

Hyundai Plasma Display

HQP421SR/421HR/501HR
User's Guide

Service Center

USA

Hyundai ImageQuest America
3101 North First Street San Jose, CA 95134
Hyundai tech support
Tel : +800-568-0061, 408-232-8654
Fax : +408- 232-8146
e-mail : syuen@hyundaiqa.com

AVC USA, INC.

777 Mark Street, Wood Dale, IL 60191
Tel : 630-595-0123 / 800-568-0060
Fax : 630-595-2345 / 800-784-9422
e-mail : avctech@avcusa.com

NEW ZEALAND

TRANSTECH DISTRIBUTORS Ltd.
PO Box 12985 Penrose,
Auckland New Zealand
Tel : 09-571-0775
Fax : 09-571-0776
e-mail : LouisG@Transtech.co.nz
WWW : www.transtech.co.nz

AUSTRALIA

Thomas Electronics Australia Pty Ltd.
3 Sheridan Close
Milperra NSW 2214, Australia
Tel : +61 2 9773 7400
Fax : 61 2 9773 7177
Attn : Ms. Shiely Poniman

GERMANY

Hyundai ImageQuest Europe GmbH
Geheimrat Hummel Platz 2
65239, Hochheim, Germany
Tel : 06146 / 904 444
Fax : 06146 / 904 410
e-mail : service@hyundaiq.de
WWW : www.hyundaiq.com

JAPAN

Hyundai ImageQuest JAPAN
Shin-Hibiya Bldg, East 5F 1-3-6
Uchisaiwai-Cho, Chiyoda-ku,
Tokyo, Japan 100-0011
Tel : 03-5157-2286
Fax : 03-5157-2284
e-mail : pjkim@iqt.co.kr
C/S P.J.Kim

www.hyundaiQ.com

FCC Information

User Instructions

The Federal Communications Commission Radio Frequency Interference Statement includes the following warning :

NOTE : This equipment has been tested and found to comply with the limits for a Class B digital device pursuant to Part 15 of the FCC Rules.

These limits are designed to provide reasonable protection against harmful interference in a residential installation. This equipment generates, uses, and can radiate radio frequency energy and, if not installed and used in accordance with the instructions, may cause harmful interference to radio communications. However, there is no guarantee that interference will not occur in a particular installation.

If this equipment does cause harmful interference to radio or television receptions, which can be determined by turning the equipment off and on, the user is encouraged to try to correct the interference by one or more of the following measures :

- Reorient or relocate the receiving antenna.
- Increase the separation between the equipment and receiver.
- Connect the equipment into an outlet on a circuit different from that to which the receiver is connected.
- Consult the dealer or an experienced radio/TV technician for assistance.

User Information

Changes or modifications not expressly approved by the party responsible for compliance could void the user's authority to operate the equipment.

Connecting of peripherals requires the use of grounded shielded signal cables.

Important Tips

Image Retention effect(Image Sticking) —

1. Cause :

- Image Retention Effect could be come from displaying a still picture in certain period of time with at a certain area continuously, as the feature of Plasma Display Panel.
- This is the same matters to other companies' PDP products, too.

2. Prevention :

- To avoid this matter, use the product after reducing brightness and contrast, especially a still image is displaying for a long time. *(Example : Contrast 50, Brightness 50 - See the page 36)*
Once Image retention occurs, change the mode into Video mode which displays more motion pictures. It will help reduce this matter, but cannot completely eliminate once it occurs.
It makes the screen's brightness worse as displaying a fixed pattern often.
- Use the fuction, Pixel Shift in still image, in our PDP products.
(For more details, see the below page 65)

3. Solution :

- The temporary image sticking would decrease with displaying Full-White pattern after 10 hours.
- The permanent image sticking couldn't take off under the latest technology even though being in its manufacturer.

4. Notice :

- It is very important to notify every buyer/customer this information and All Branches/Buyers /Customers should be fully aware of this.
- Image Sticking in PDP products couldn't get the support from a manufacturer, and does not come under the warranty.

Second Tip —

• Pixel Defect :

Plasma Display Panel(PDP) is made of a group of refined pixels (cells). The Panel, in which 99.9% of pixels have approved, is a normal product. Therefore, only a few of abnormal pixels may appear, however, this has no influence upon PDP performance.

Image Sticking Precaution

Still Image/Panorama/Wide/4:3 in motion Image —

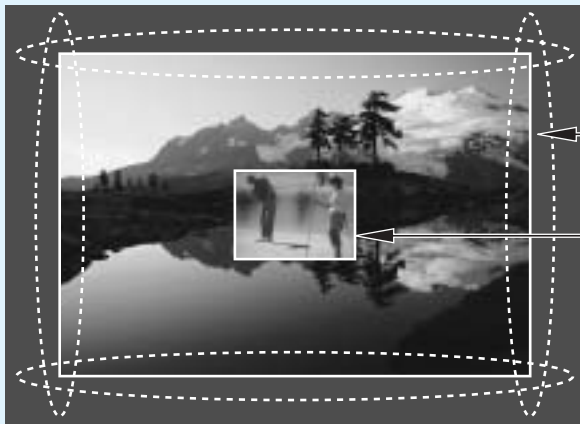

Panorama, Wide, 4:3 aspect ratio

Box or Still image

- **Precaution :**

- Image Sticking could be come from Still Image and Boundary line for a long time display and Brightness gap in Boundary.
- This Matter(Image Sticking) is same thing under the other PDP's Company.
- Still Image/Letter in watching TV also will be effect to Image sticking.
- *This matter(Image Sticking) is out of warranty.

Features

A Wide Array of Screen Settings

You can choose different screen settings depending on the type of program you are watching or the surrounding conditions (the lighting or the outside weather conditions).

You can switch among Standard, Dynamic, Movie and Mild options or you can configure the screen settings for yourself.

A Wide Array of Sound Settings

You can choose an optimal sound setting for the type of program you are watching.

You can switch among Music, Movie, News and Standard options or you can configure the settings for yourself.

SRS WOW(Surround) Audio Function

You can listen to dynamic and surround sound only with ordinary speakers.

Two Tuner Built-In

You can watch two channels at the same time and changing each channel.

PIP Viewing

You can watch TV or Text information at the same time while working on PC or watching VCR/DVD movies.

Various of the Aspect Ratio

You can adjust aspect Ratio as you want.

Auto On/Off Function

This function allows you to turn On/Off your PDP TV at the preset Time.

If there is no signal during a specific time period, power will be off.

Auto Detection Sound Format

When watching TV in Stereo/SAP mode, this function automatically detects transmission signaling to display broadcasting status on the OSD.

Table of Contents

General Information

Important Tips	3
Image Sticking Precaution	4
Safety Precaution	5
Contents of the Package	11
Separately Sold Products	11
Parts Names and Functions	13
Remote Control	15
How To Use Speakers (Standing Type)	17
How To Use Speakers (Desk Type)	18
How To Install Wall Hanger Support	19
How To Install Wall mount frame	20
How To Install Desktop Stand	21

Connections

Connecting VHF and UHF Antenna.....	23
Connecting Cable TV	23
Before connecting the video/audio connections to external devices	25
Connecting a VCR, Cable/Satellite Receiver	26
Connecting a DVD Player	27
Connecting a DTV(Digital Broadcast) Receiver	28
Playing Back a Tape Recorded On a Camcorder	29
Connecting to a PC(DVI, D-SUB)	30
Resolutions Supported in PC	31
Scart Connection to the External Input	32

Picture Setup

How to Select the Picture Mode	35
How to Set the Desired Picture	36
How to Set Blue Screen	37
How to Set Film Mode	38
How to Select a Color Temperature	39
How to Set PIP [Mode]	40
How to Set Multi-Screen [Input Source/Position/Size]	41
Supported PIP Table	43
How to Set Noise Reduction	44
How to Select the Fit(Fine Image Technology) Engine Mode	45

Sound Setup

How to Select the Audio Mode	47
How to Set the Desired Audio	48
How to Select AVL	49
How to Select SRS WOW(Surround)	50
How to Select MTS(Multi-Channel Sound)	51
How to Set the Output of Subwoofer	52

Channel Setup

Memorizing the Channels	55
Fine Tuning Channel Reception	56
Storing Channels Manually	57
Using the LNA(Low-Noise-Amplifier) Feature	58

Function Setup

How to Select the Aspect Ratio	61
Displaying Information	63
How to Set Key-Lock	64
Using the Pixel Shift / Full White / Wiper Function	65
How to Freeze Picture	66
How to Set DPMS	67
Choosing the Your Languages	68
How to Set Image Adjust in PC Mode	69
Viewing Closed Captions	71
Using the V-Chip	73

Clock Setup

How to Set Clock	77
How to Set On Time	78
How to Set Off Time	80
How to Set Sleep Time	82

Appendix

Glossary	85
Troubleshooting	87
Care and Cleaning	89
Product Specifications	90
Component Video Signal Format	91



Safety Precaution

The contents of this section are provided for the safety of users and their property. Please read the instructions carefully before using.

WARNING

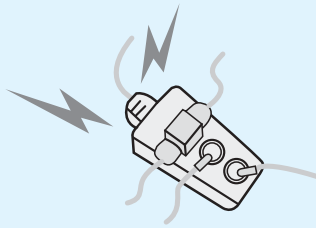

Do not connect multiple electrical appliances to a single outlet.
- It may cause a fire due to overheating from the outlet.

If there is a persistent accumulation of dusts or water on the plug, please make sure to wipe it off using a dry cloth.

- It may cause a fire or an electric shock.



WARNING

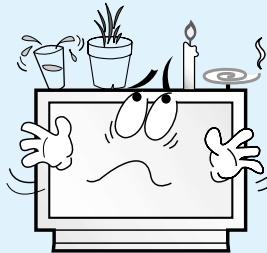



Do not put a water bowl, filled with liquids such as vases, candle, bug repellent smoke, cigarette, plants, or heavy thing on the PDP.
- It may cause electric shock or fire and also heavy things may cause injury when they fall.

Do not install in a place where there is oil, smoke, excessive humidity, or where water may be sprinkled, dripped, splashed on it.

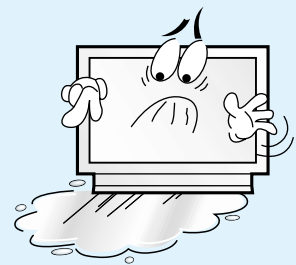
- This may cause electric shock or fire.



Safety instructions are divided into "Warning" and "Alert". Their meanings are as follows.

-  This icon is intended to alert the user to the presence of potential danger and important operating instructions.
-  **WARNING** : When there is a possibility of serious injury or death if not observed.
-  **ALERT** : When there is a possibility of slight injury or product damage if not observed.

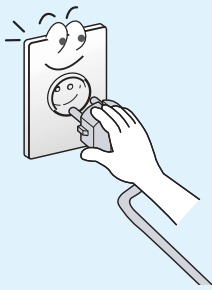

Firmly plug in the power cord so that it does not pull out.

- An unstable connection may cause fire.

Do not use a damaged power cord or plug, or loose outlet.

- They may cause electric shock or fire.

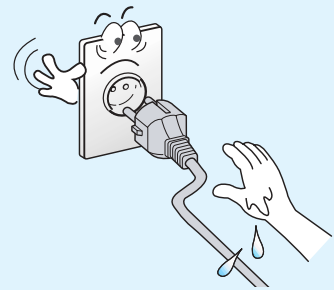
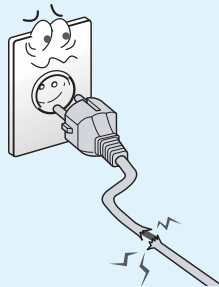

Never touch the power plug or outlet with wet hands.

- This may cause electric shock.

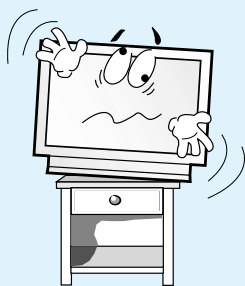

Do not install on an unstable place or small support.

- This may cause the PDP to fall, resulting in serious injury to a child or adult.

Do not use or store a flammable spray or inflammable things near the PDP.

- They may cause explosion or fire.

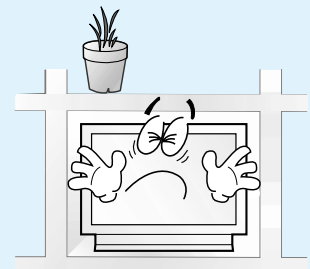
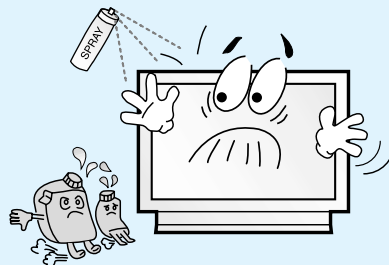

Do not install the PDP in a bookshelf, closet, or a place where there is poor air circulation.

- Fire may be caused due to the rise of internal temperature.



Safety PrecautionContinued from previous page

The contents of this section are provided for the safety of users and their property. Please read the instructions carefully before using.

WARNING

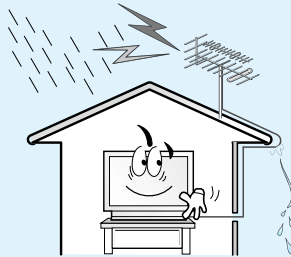

Make the antenna cable loop at the entrance of the building. Any necessary action such as making the antenna cable loop at the entrance of the building should be taken to prevent rainwater on the outdoor antenna cable from possibly running into the indoor.

- If raindrop gets into the PDP, it may cause a fire or an electric shock.

Never attempt to open, fix, or modify the PDP.

- When there is a need for fixing, call a service center. Fire or electric shock may be caused.



WARNING



Any heat sources such as radiators and heat registers, etc. on or near the PDP.

- It may cause a fire.

Do not block ventilating slits.

- Blocking the ventilation slits prevents inner heat from escaping, which may lead to a fire.

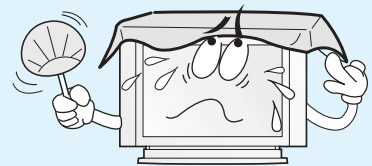

Safety instructions are divided into "Warning" and "Alert". Their meanings are as follows.

- ⚠ This icon is intended to alert the user to the presence of potential danger and important operating instructions.
- ⚠ **WARNING** : When there is a possibility of serious injury or death if not observed.
- ⚠ **ALERT** : When there is a possibility of slight injury or product damage if not observed.

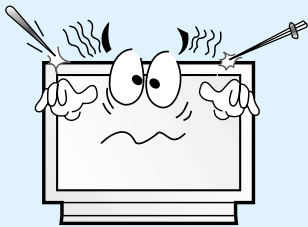

Do not put a metallic object like chopstick, wire, or puncher or inflammables like paper or a match in a vent, headphone jack, or AV jacks of the PDP.

- Electric shock or fire may be caused.

When the PDP produces abnormal noise, burning smell, or smoke, unplug the PDP immediately and call a service center.

- Electric shock or fire may be caused.

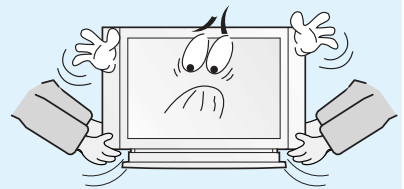
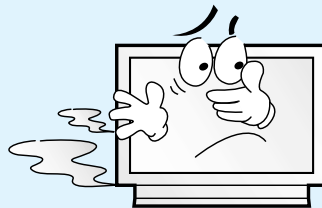

When moving the PDP assembled with speakers, make sure to detach the speakers from it.

- If you carry the product holding the speakers, it may cause the product to fall, causing serious injury or damage.

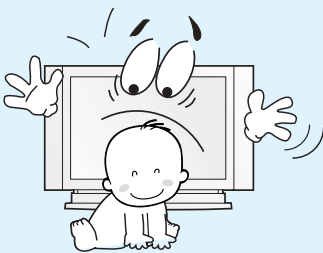

Do not install the product on the floor.

- If it falls over, your child may be injured.

Unplug the product during lightning or thunderstorms and never touch the antenna cable.

- It may cause a fire or an electric shock.

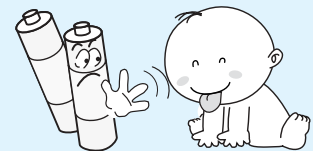
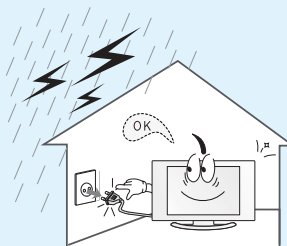

Keep the remote control batteries out of sight and out reach of children.

- If your child swallows a battery, see your doctor immediately.



Safety PrecautionContinued from previous page

The contents of this section are provided for the safety of users and their property.
Please read the instructions carefully before using.

WARNING

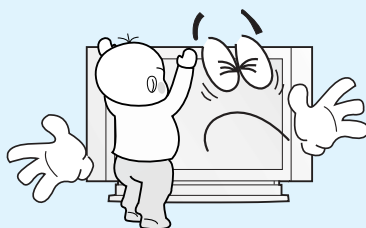

Do not allow children to climb or play on the PDP.
- If it falls over on children, it may cause serious injury.

Do not place toys and cookies, etc. on the PDP, which may attract children's attention. Children will climb on the PDP to reach whatever they have their eyes on.
- If it falls over on children, it may cause serious injury.

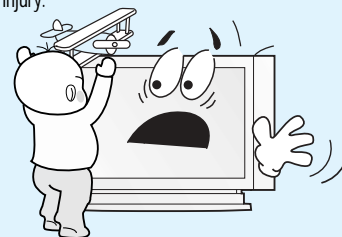

ALERT

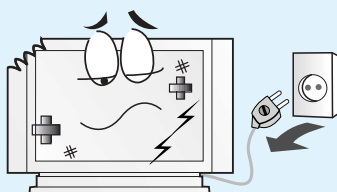

In the event of damaging or dropping the product, switch off the power and remove the plug.
- Using a damaged product may cause an electric shock or a fire.
- Contact your local service center.

Please avoid touching the panel at the rear of PDP as it is producing high temperature.
- Direct contact with the hot surface may cause physical burns.

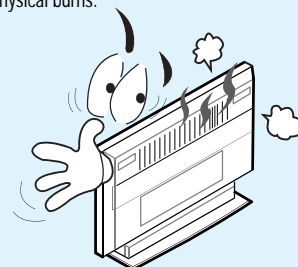

Safety instructions are divided into "Warning" and "Alert". Their meanings are as follows.

- ⚠ This icon is intended to alert the user to the presence of potential danger and important operating instructions.
- ⚠ **WARNING** : When there is a possibility of serious injury or death if not observed.
- ⚠ **ALERT** : When there is a possibility of slight injury or product damage if not observed.



When cleaning the PDP, make sure to disconnect the power plug and use a dry, soft cloth for a cleanup.

- Please avoid using chemicals such as wax, benzene, alcohol, thinner, mosquito spray, air freshener, lubricant or synthetic detergent.

When replacing batteries, make sure to match the batteries to the (+) and (-) marks in the battery compartment.

- Mismatching of polarities may result in internal damage to batteries, fire due to leakage or contamination.

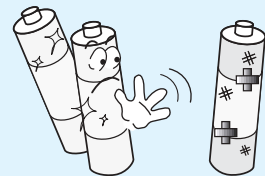
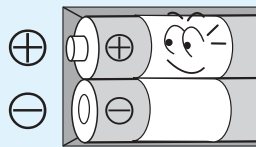

Always use the standard batteries and avoid using old batteries together with new ones.

- Otherwise it may result in internal damage to batteries, fire due to leakage or contamination.

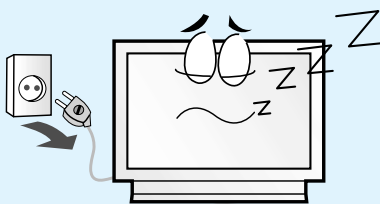

Unplug when you do not use your PDP for a long time.

- If dust is stacked on the PDP, electric shock or fire may be caused from heat, fire, or deterioration of insulation.

When moving the PDP, 2 or more people are advised to carry it.

- Injury or damage may be caused when the PDP falls.

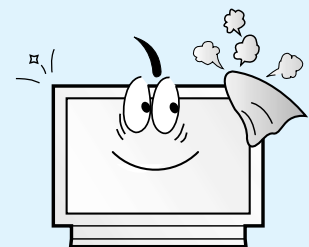
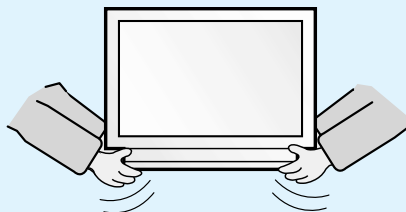

Consult a service center or customer service for inside cleaning about once a year.

- When dust is piled inside the PDP for long time, fire or malfunction may be caused.



Contents of the Package

To purchase additional parts, consult a distributor or selling agent.

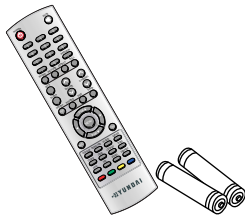

Remote Control/2 Batteries
(1.5V AAA)

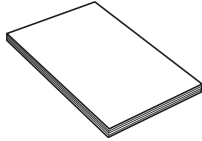

User's Guide

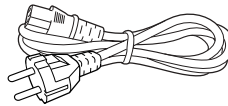

Power Cord

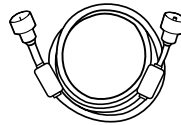

Antenna Cable



Separately Sold Products

If you want to purchase separately sold products, consult a service center, electronics shops, or parts seller.

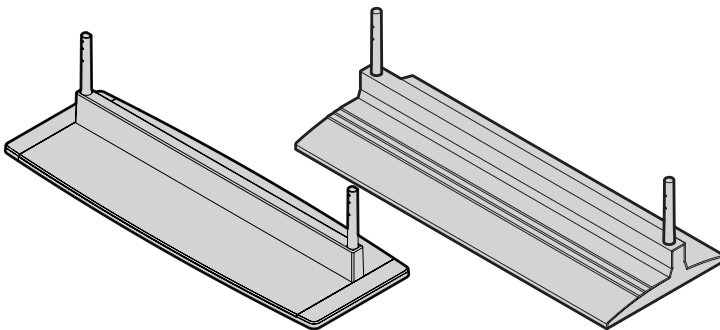

Desk type stand



Desk type speaker

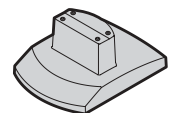

Desk type speaker
stand

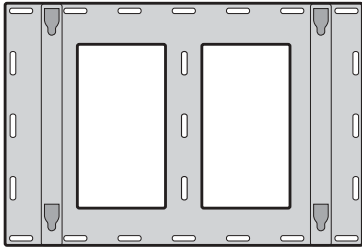

Wall mounting frame

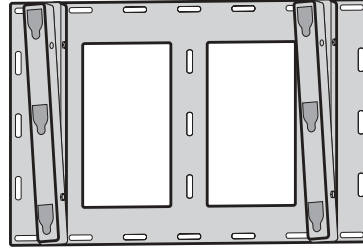

Adjustable wall mounting frame

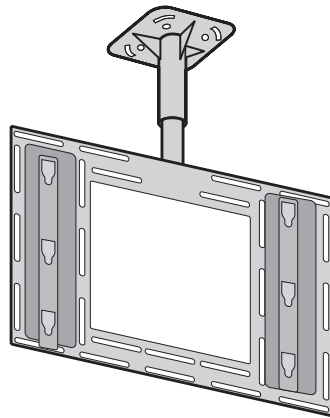

Ceiling mounting frame

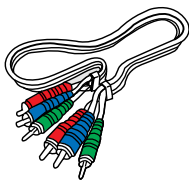

Component(Y, Pb, Pr) cable

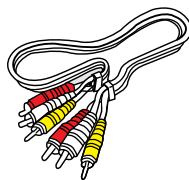

Composite(Video & Audio) cable

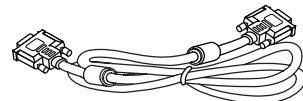

DVI PC video(digital) cable

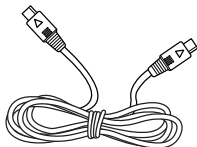

S-video cable

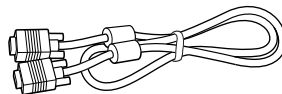

PC signal cable

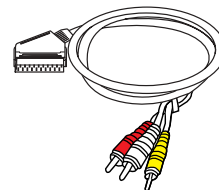

Scart cable



Parts Names and Functions

Front View

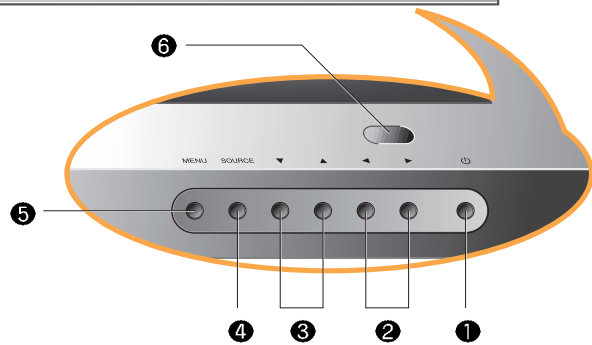
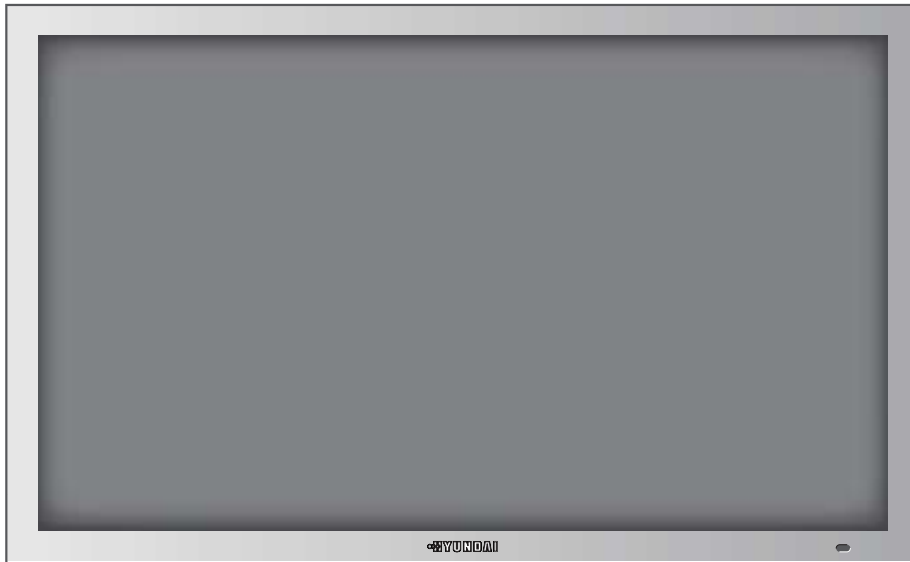

* The above image may look different from the real product.

1 Power button

Use this button to turn on or off the PDP.

2 Volume buttons

Use these buttons for your desired sound level. These buttons also serve as the cursor of Select/Adjust when in Menu mode.

3 Channel buttons

Use these buttons to change channels. These buttons also serve as the cursor of Down and Up buttons when in Menu mode.

4 Source button

Use this button to switch among inputs connected to the PDP.

5 Menu button

Use this button to display or exit from menus.

6 Remote sensor and power LED

Point the remote control toward here. It displays standby or operation status.

Rear View

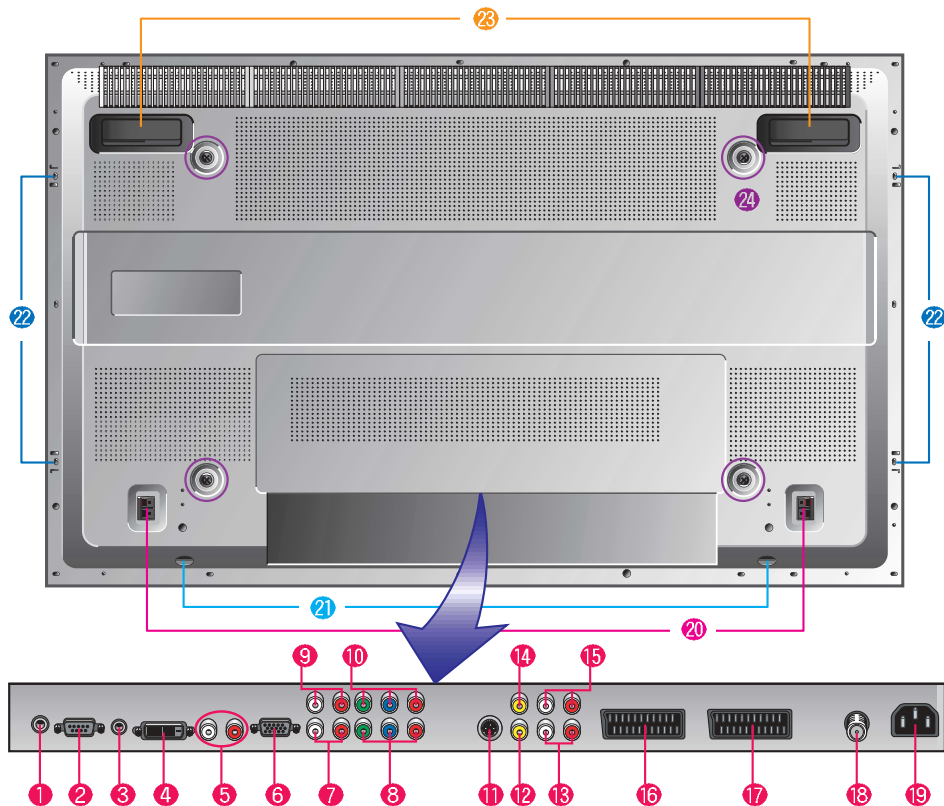

- 1 Sub woofer output**
If you wish to reproduce the lower bass frequencies, please connect the cable to your Subwoofer speaker with *AMP.
- 2 RS-232 input terminal**
Connect to the RS-232 terminal of a PC for the service check.
*For the control method using this terminal, consult an authorized PDP monitor dealer.
- 3 Phone Jack(RS-232 Output)**
Extend an RS-232 input.
- 4 DVI input terminal**
Connect to the DTV receiver with DVI terminal or to external devices such as a PC.
- 5 PC/DVI Audio input terminal**
Connect to the audio output terminal of a PC.
- 6 D-SUB input terminal**
Connect to the DTV Receiver with D-Sub terminal or to RGB output terminal of a PC.
- 7 Audio input terminal for DVD**
Connect to the audio output terminal of DVD player.
- 8 Component input terminal for DVD or DTV**
Connect to the Component output terminal of DVD player/DTV receiver.
- 9 Audio input terminal for DTV Component**
Connect to the audio output terminal of DTV receiver.
- 10 Component input terminal for DTV**
Connect to the Component output terminal of DTV receiver.
- 11 S-video input terminal**
Use this for the better video quality than video input terminal.
- 12 Video Composite input terminal for VCR**
Connect to the Composite Video output terminal of VCR or DVD player.
- 13 Audio input terminal for VCR**
Connect this when S-video or Composite Video inputs.
- 14 Video output**
This allows you to view the current program from another external source at the same time.
- 15 Audio output**
This allows you to hear the sound for the current program.
- 16/17 SCART input terminal**
Use this for composite-video input and audio-inputs using scart cable.
- 18 ANT. input**
This allows you to connect your antenna.
- 19 Power input terminal**
Power cord is connected here.
- 20 Speaker terminal**
- 21 Stand assembly**
- 22 Speaker assembly**
- 23 Carrying handles**
- 24 Screw hole for fixing on a wall**



Remote Control

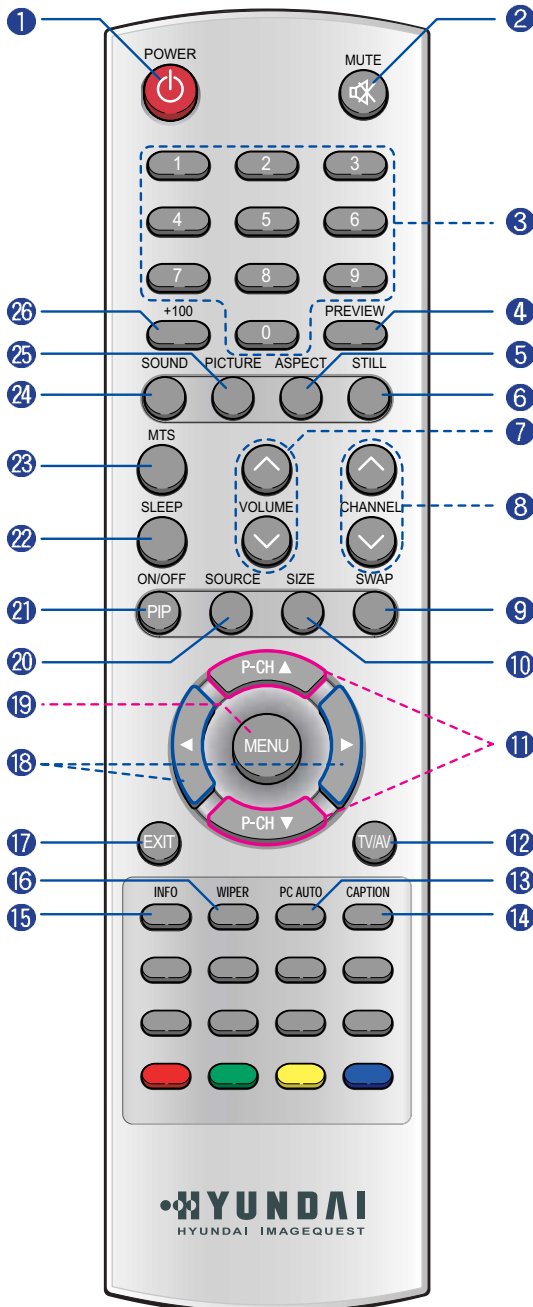

- 1 POWER/STANDBY**
Use this button to turn the TV set on or off.
- 2 MUTE**
Use this button to turn the sound off completely.
- 3 NUMERIC KEYS**
Use these buttons to select channels.
- 4 PREVIEW**
Use this button to return to the previous channel.
- 5 ASPECT RATIO**
Use this button to quickly change the picture format.
- 6 STILL**
Use this button to freeze a picture.
- 7 VOLUME**
Use this button to control the volume level
- 8 CHANNEL**
Use these buttons to select channels.
- 9 SWAP**
Use this button to switch what is being shown on the main picture to the sub-picture.
- 10 SIZE**
Use this button to change the size of a sub-picture.
- 11 SUB-PICTURE CHANNEL SELECTION**
Use these buttons to select or adjust each item of menu. Or you can select channels in sub-pictures.
- 12 TV/AV buttons**
Use this button to display the available video sources.
(TV, Video, S-Video, DTV, DVD, PC, DVI, Scart 1, Scart 2)
- 13 PC AUTO**
Use this button to automatically adjust settings according to the frequency and resolution selection in PC mode.

- 14 CAPTION**
Use this button to displays the closed captions that are broadcasted with certain TV shows.
- 15 INFORMATION**
Use this button to display picture mode, resolution or various program information.
- 16 WIPER**
Use this button to prevent any possible ghosts. White bar will pass through the TV screen to prevent ghosts.
- 17 EXIT**
Use this button to exit from a menu.
- 18 SELECT/ADJUST**
Select or adjust each item of menu.
- 19 MENU**
Use this button to adjust screen, audio, channel, function, time, etc.
- 20 SOURCE [MULTI SCREEN]**
Use this button to select input signals for sub-pictures.
- 21 PIP (PICTURE IN PICTURE) ON/OFF**
Use this button to watch more than one picture at once.
- 22 SLEEP**
Use this button to allow your TV to turn off automatically at designated time.
- 23 MTS**
Use this button to display types of audio signals currently aired on TV. Or you can use this button to switch to other Sound Mode available.
- 24 SOUND**
Use this button to select the status of sound.
- 25 PICTURE**
Use this button to select the status of picture.
- 26 +100 KEY**
Use this button to select the channel above 100

How to Insert Batteries in Remote Control

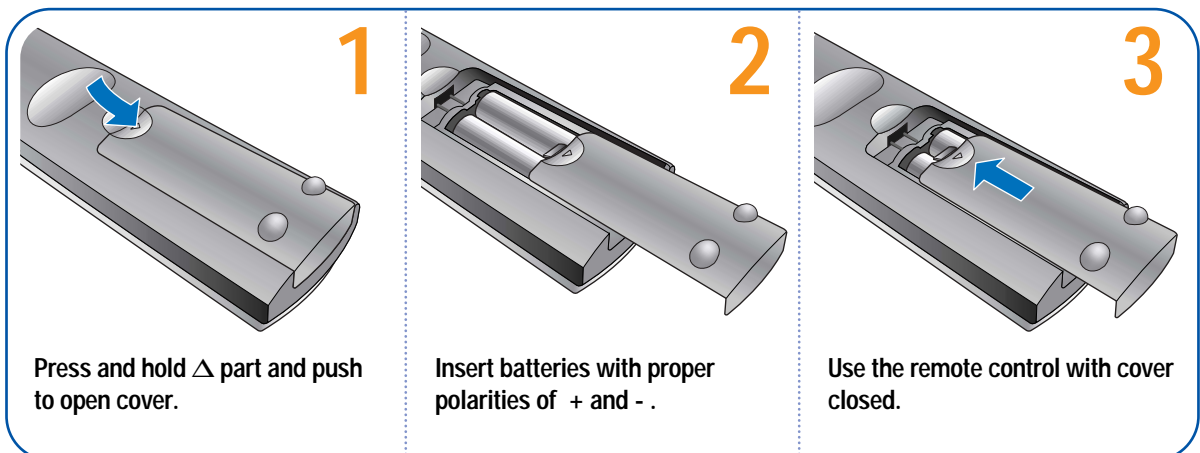

*Battery type : 1.5V/UM-3(AA/R06)



How To Use Speakers (Standing Type)

Parts configuration chart

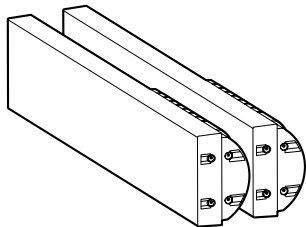

2 Speakers (left and right)

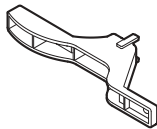

4 brackets



16 fixing screws



2 sets of speaker cables
(left and right)

Assembly and Connection Method

1

Insert brackets into the grooves on the rear of speakers and fasten them with fixing screws. (Left and right side each)

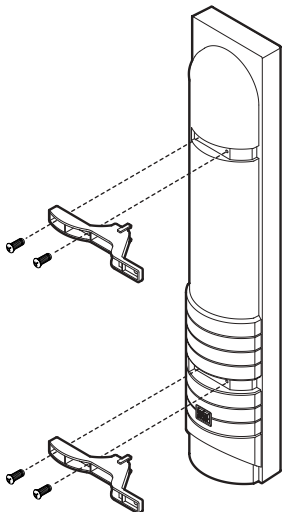

2

Fasten 1 with PDP body using fixing screws. (Left and right side each)

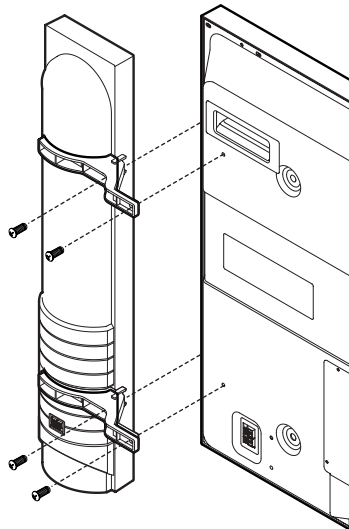

3

Connect speaker cables between terminals on the rear of speakers with speaker connection terminals on the rear of PDP. (Connect cables and terminals in the same color)

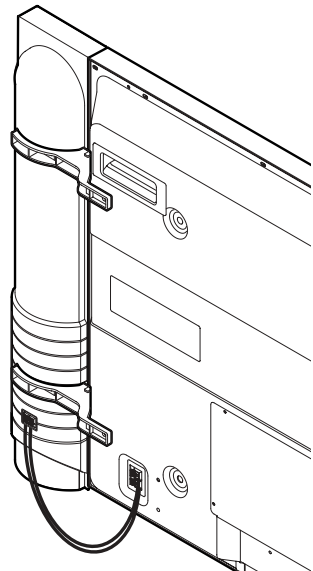

WARNING

Do not move the product holding the speakers. Always use handles on the PDP. (Brackets connecting PDP and speakers may be damaged.)

How To Use Speakers (Desk Type)

Parts configuration chart

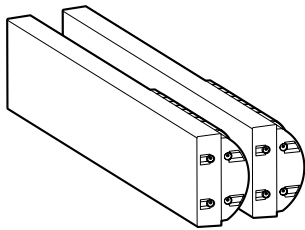

2 Speakers (left and right)

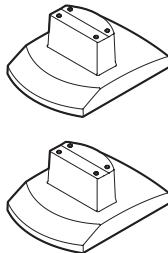

2 Speaker-stands (left and right)



8 fixing screws



2 sets of speaker cables (left and right)

Assembly and Connect method

1

Insert speaker-stands in the groove on the bottom of speakers and fasten them with fixing screws. (Left and right side each)



2

Upright **1** and place them on desired place left and right of PDP. (Left and right side each)



3

Connect speaker cables between terminals on the rear of speakers and speaker connection terminals on the rear of PDP. (Connect cables and terminals in the same color)

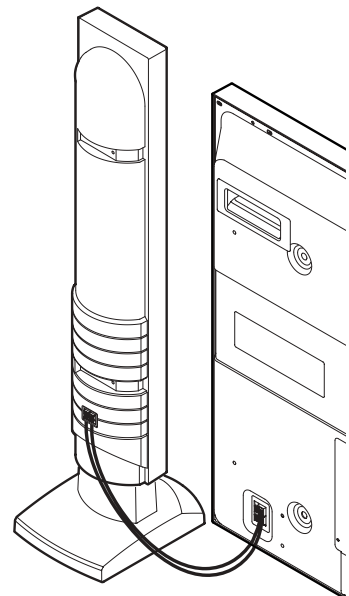
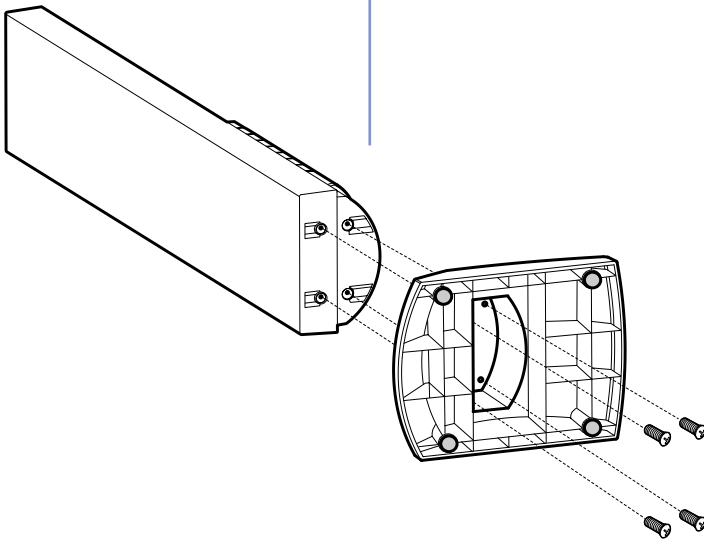



How To Install Wall Hanger Support

1. Caution

1. Install on the vertical wall surface only.
2. Do not install on the following places to protect the performance of PDP and to prevent malfunction.
 - Near sprinkler Detector
 - Near heating devices
 - Places where vibration or shock may be applied
 - Near high voltage electric power line
3. Install in a proper method with the structural materials of the wall. If the wall is not strong enough to stand weight of PDP set, reinforce the wall surface before installation.
4. Do not install within a wall.

2. Parts configuration chart

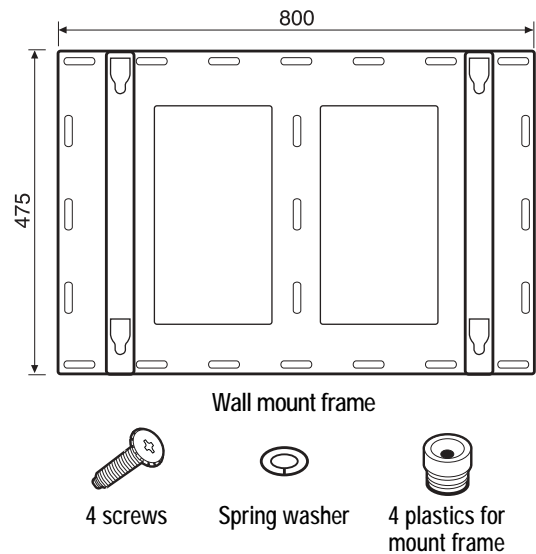

3. Angle Adjustment(Optional)

The angle of PDP may be adjusted from 0 degree to 20 degree in 5 steps with 5 degrees. Use the angle adjustable hole on the side of fixing panel when adjustment is needed. (This function is supported with angle adjustable type wall mount frame only.)

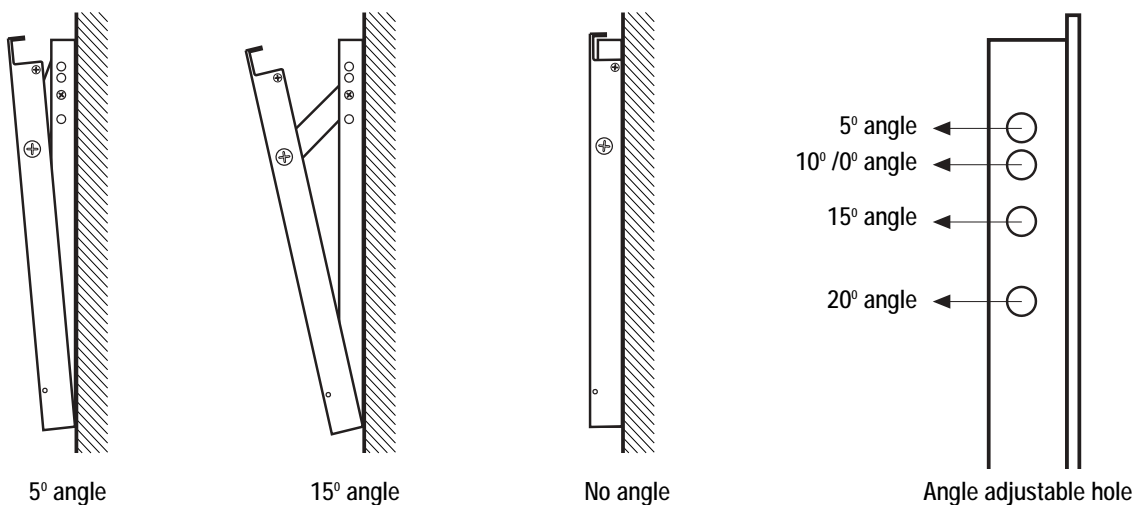

* Fixed type wall mount frame does not support angle adjustable function.

How To Install Wall mount frame

4. Installation Method

1. Unscrew screws fasted on four spots on the back of PDP.

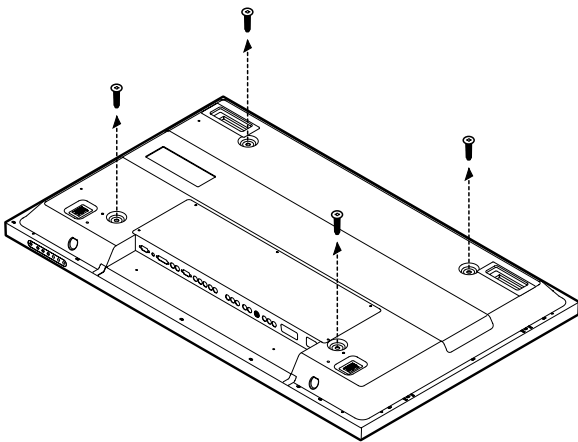

3. Fix the wall mount frame on the wall with screws or nails.

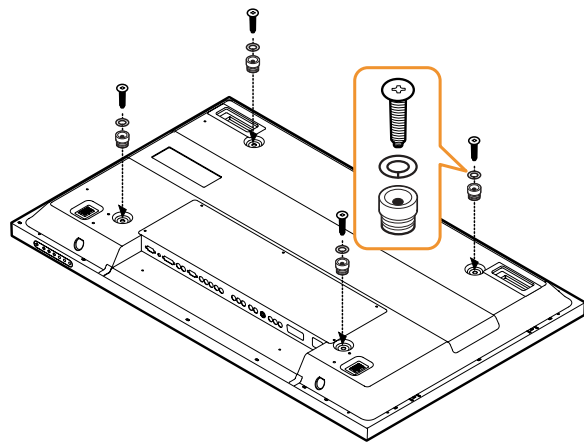
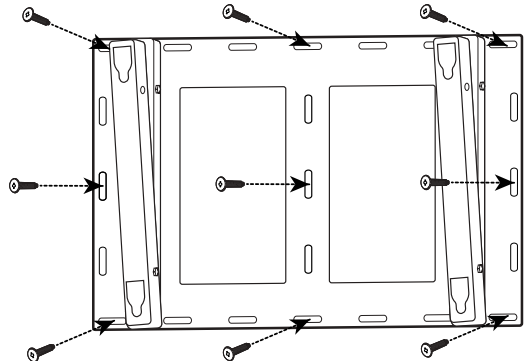

2. Fasten the screws and plastics for mount frame on the spot where screws were as shown on the picture.

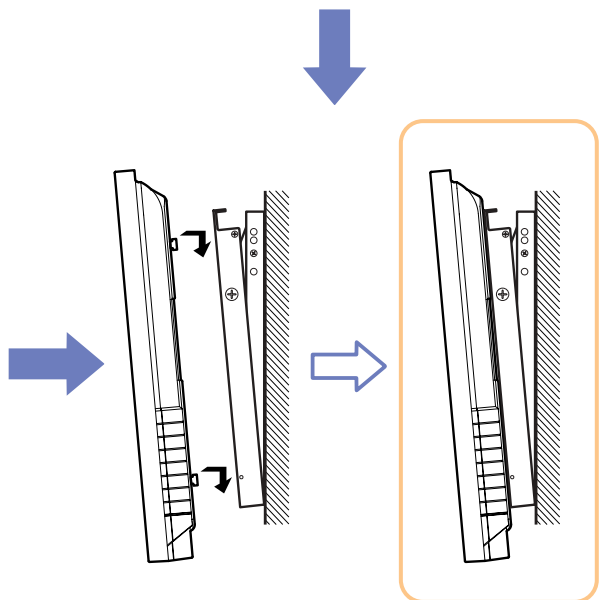

4. Hang the plastics for the mount frame on the wall mount frame. (If the PDP is lifted too much, the hanging plastic may be separated.)



How To Install Desktop Stand

1. Place the PDP body on a flat desk or shelf. Clean the surface of the desk or shelf in order to prevent scratch on the product.
2. Align the stand with PDP body below and fasten the stand bars using 4 fixing screws.
3. After the assembly is over, stand the assembled product at a desired place.

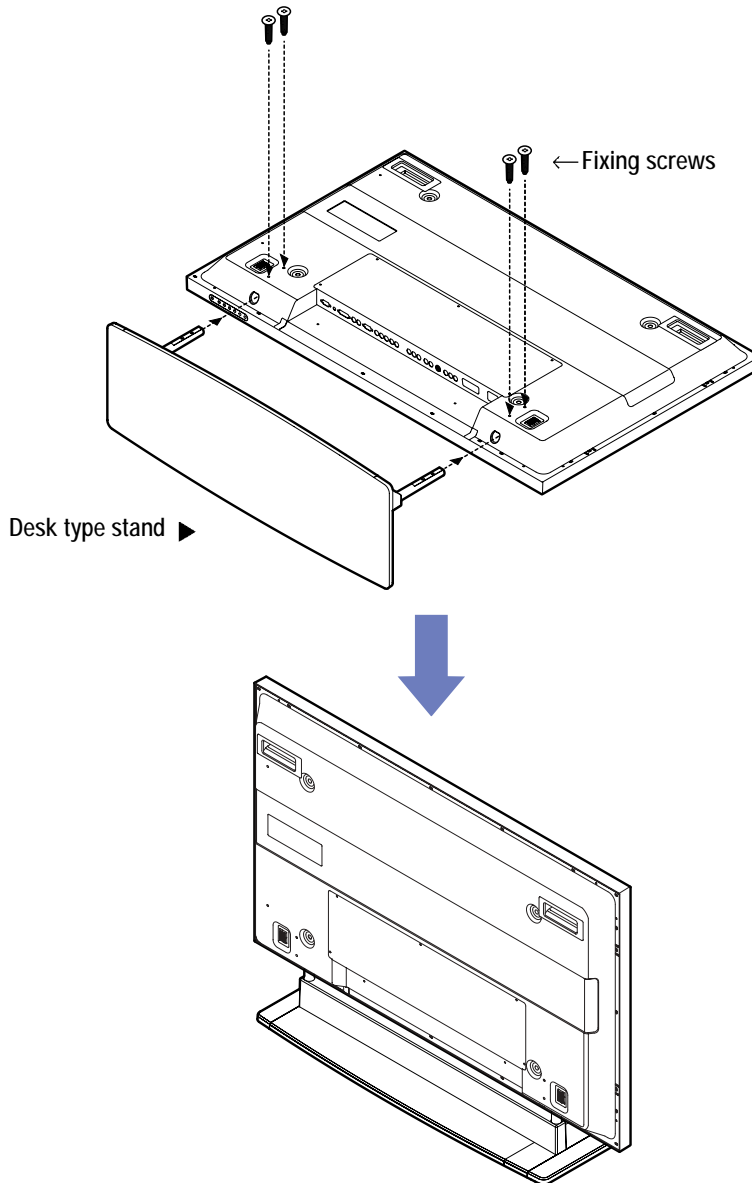

Warning : Do not install at an unstable place or on a small support.
(When a child plays around the product and touch it, PDP may fall and injure the child.)

Connections

- Connecting VHF and UHF Antenna.....23
- Connecting Cable TV23
- Before connecting the video/audio connections to external devices25
- Connecting a VCR, Cable/Satellite Receiver26
- Connecting a DVD Player27
- Connecting a DTV(Digital Broadcast) Receiver28
- Playing Back a Tape Recorded On a Camcorder29
- Connecting to a PC(DVI, D-SUB)30
- Resolutions Supported in PC31
- Scart Connection to the External Input32



Connecting VHF and UHF Antenna

Antenna with 75-ohm Round Leads

If your antenna looks like this :  it has 75-ohm round leads.

Plug the antenna lead into the VHF/UHF terminal on the PDP.
Use the Antenna Cable, an accessory included in the product package.

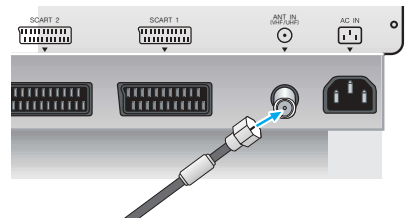

Connecting Cable TV

You can connect different cable systems to your PDP, including cable without a cable box, and cable with a cable box that descrambles some or all channels.

Cable without a Cable Box

Plug the incoming cable into the VHF/UHF terminal on the PDP.
Use the Antenna Cable, an accessory included in the product package.

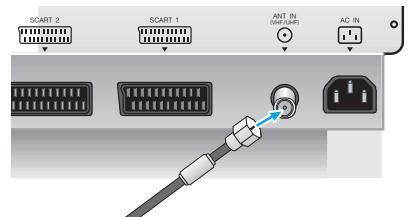

Cable with a Cable Box that Descrambles All Channels.

- 1 Find the cable connected to the ANTENNA OUT terminal on your cable box. This terminal might be labeled "ANT OUT", "VHF OUT", or simply "OUT".
- 2 Connect the cable to the VHF/UHF terminal on the PDP.
Use the Antenna Cable, an accessory included in the product package.

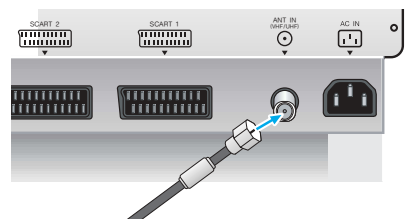

Cable with a Cable Box that Descrambles Some (But Not All) Channels

To complete this connection you will need a two-way splitter, an RF (A/B) switch, and four coaxial cables.

- 1 Find and disconnect the cable that is connected to the ANTENNA IN terminal of your cable box. This terminal might be labeled "ANT IN", "VHF IN", or simply, "IN". Connect this cable to a two-way splitter.

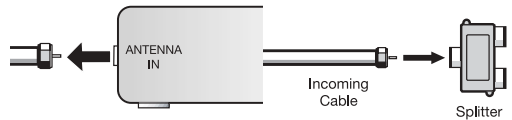

- 2 Connect a coaxial cable between an OUTPUT terminal of the splitter and the IN terminal of the cable box.

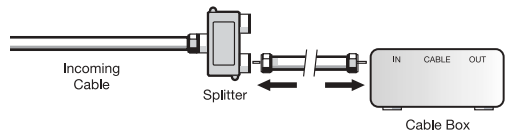

- 3 Connect a coaxial cable between the ANTENNA OUT terminal of the cable box and the B-IN terminal of the A/B switch.

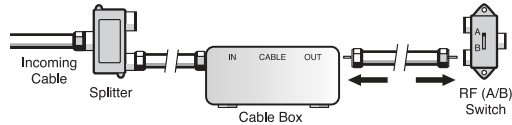

- 4 Connect a coaxial cable between the ANTENNA OUT terminal of the cable box and the B-IN terminal of the A/B switch.

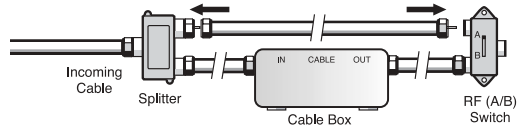

- 5 Connect the last coaxial cable between the OUT terminal of the RF (A/B) switch and the VHF/UHF terminal on the PDP.

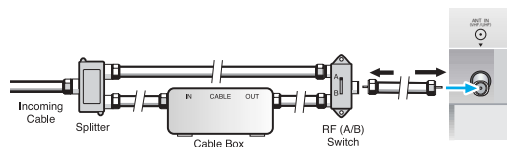

After you've made this connection, set the A/B switch to the "A" position for normal viewing. Set the A/B switch to the "B" position to view scrambled channels. (When you set the A/B switch to "B", you will need to tune your Set-Top Box to the cable box's output channel, which is usually channel 3 or 4.)



Before connecting the video/audio connections to external devices

Please make sure to read the following information on connection to enjoy best picture quality.

Video/Audio connectors

Types of video/audio cable :

- ① DVI-D ② 15-Pin D-Sub ③ COMPONENT ④ S-VIDEO ⑤ COMPOSITE ⑥ FULL SCART ⑦ HALF SCART

Best picture quality is displayed in the following order.

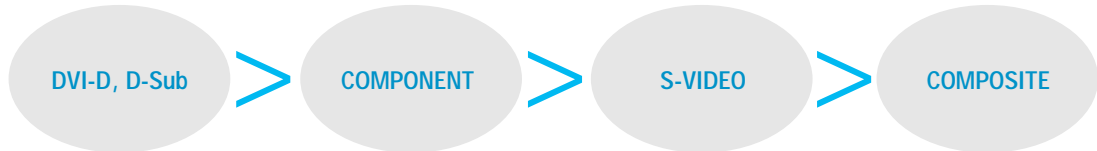
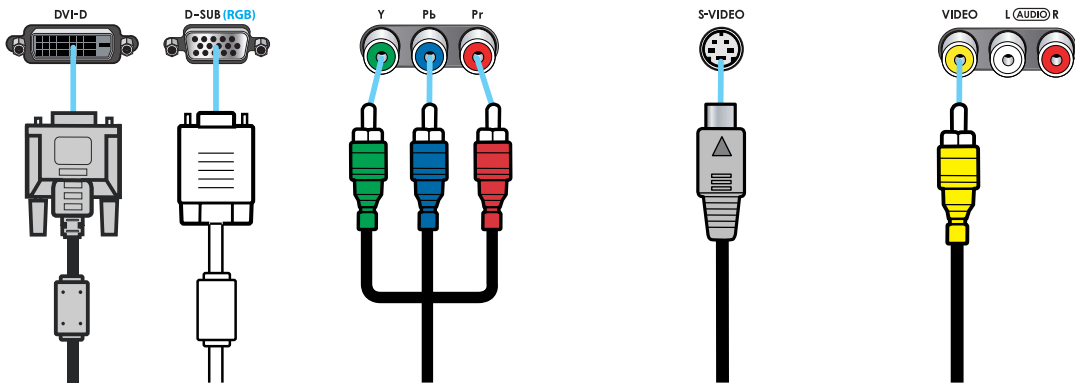

The superior picture quality starts from the far left side.

Connecting a VCR, Cable/Satellite Receiver

Connection Method

- 1 Connect Video/S-Video cable between Video/S-Video output terminal of VCR or Cable/Satellite receiver and Video/S-Video input terminal of PDP.
(Connect cables and terminal in the same colors)
- 2 Connect Audio cable (left:white color, right:red color) between Audio output terminal of VCR or cable/satellite receiver and Audio input terminal of PDP.
(Connect cables and terminal in the same colors)

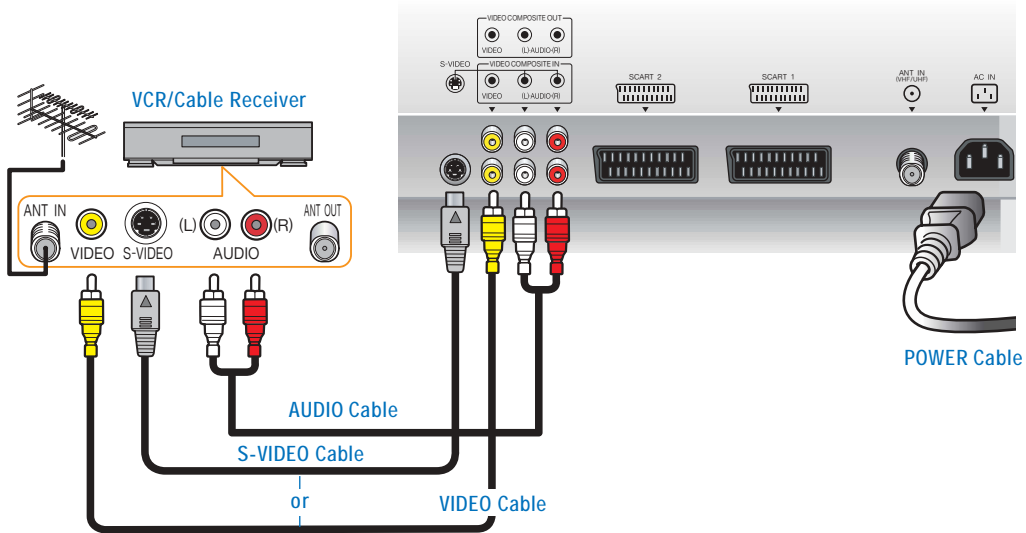

How to Watch

- 1 Turn on your PDP and press on remote control unit.
- 2 Press to move between entries. And press to select Video or S-Video.

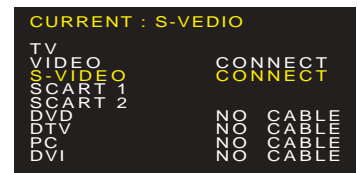

Use S-video cables for better picture quality.



Connecting a DVD Player

Connection Method

- 1 Connect video cables(Y, Pb, Pr) between output terminals(Y, Pb, Pr) of DVD player and the input terminals(Y, Pb, Pr) of DVD(480i/480p/720p/1080i) on the rear of PDP.
(Connect cables and terminal in the same colors)
- 2 Connect Audio cable between Audio output terminal of DVD player and Audio input terminal for DVD Audio on the rear of PDP.
(Connect cables and terminal in the same colors)

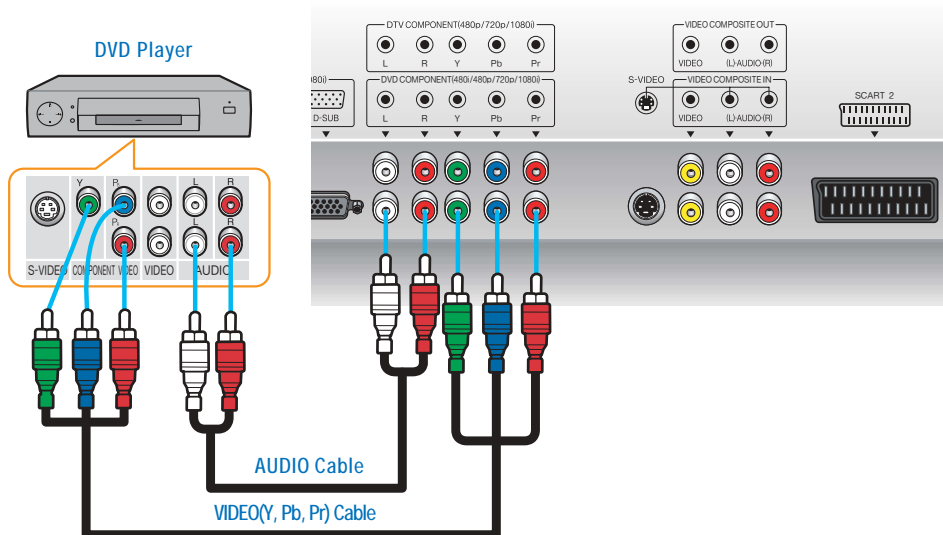

How to Watch

- 1 Turn on your PDP and press on remote control unit.
- 2 Press to move between entries. And press to select DVD.

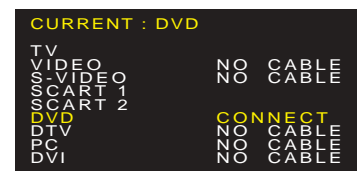

Output terminal mark(Y, Pb, and Pr) of DVD player may be written as Y, B-Y, R-Y/Y-Cb-Cr / Y-Pb-Pr.
(It depends on DVD player)

Connecting a DTV(Digital Broadcast) Receiver

Connection Method

- 1 Connect video cables(Y, Pb, Pr) between output terminals(Y, Pb, Pr) of DTV Receiver and the input terminals(Y, Pb, Pr) of DTV(480p/720p/1080i) on the rear of PDP. (Connect cables and terminal in the same colors)
- 2 Connect Audio cable between Audio output terminal of DTV Receiver and Audio input terminal for DTV Audio on the rear of PDP. (Connect cables and terminal in the same colors)

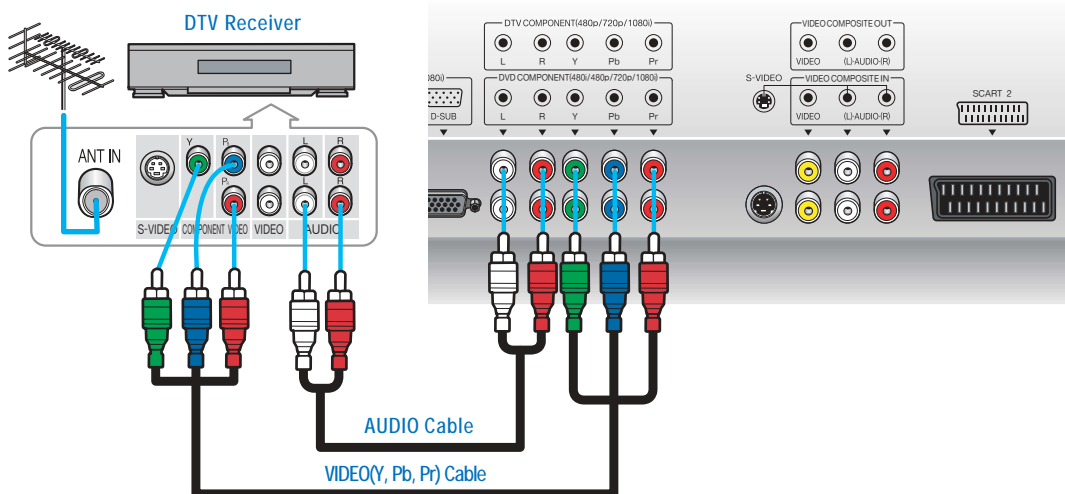

How to Watch

- 1 Turn on your PDP and press **TV/AV** on remote control unit.
- 2 Press **CH A** to move between entries. And press **Left/Right** to select DTV.

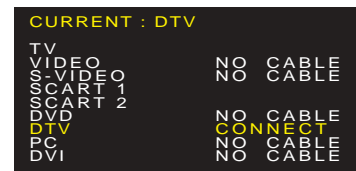

TIP

To watch digital broadcast, you have to separately purchase a digital set-top box and connect it to PDP. PDP cannot reproduce proper image, if the signal format is not supported by PDP. Please see the page 91, for the detailed signal formats that PDP supports.



Playing Back a Tape Recorded On a Camcorder

Connection Method

- 1 Connect Video cable between Video output terminal of Camcorder/Game player and Video input terminal of PDP.
(Connect cables and terminal in the same colors)
- 2 Connect Audio cable (left:white color, right:red color) between Audio output terminal of Camcorder /Game player and Audio input terminal of PDP.
(Connect cables and terminal in the same colors)

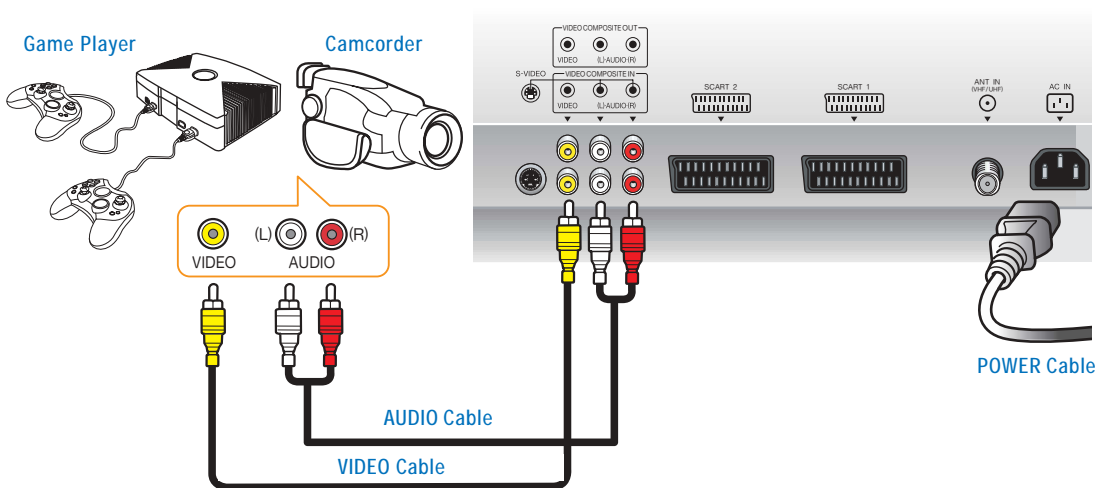

How to Watch

- 1 Turn on your PDP and press on remote control unit.
- 2 Press to move between entries. And press to select Video.

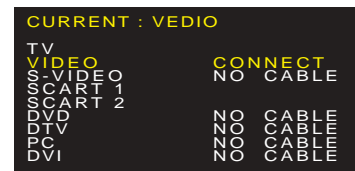

Connecting to a PC(DVI, D-SUB)

Connection Method

- 1 Connect PC signal cable(15 pins D-sub) between output terminal of PC and the D-sub input terminal of a PDP. In case of DVI(Digital) cable, connect it between output terminal for DVI(DIGITAL) of PC and input terminal for DVI of PDP.
- 2 Connect Audio cable between Audio output terminal of PC and Audio input terminal for PC of PDP. (Connect cables and terminal in the same colors)

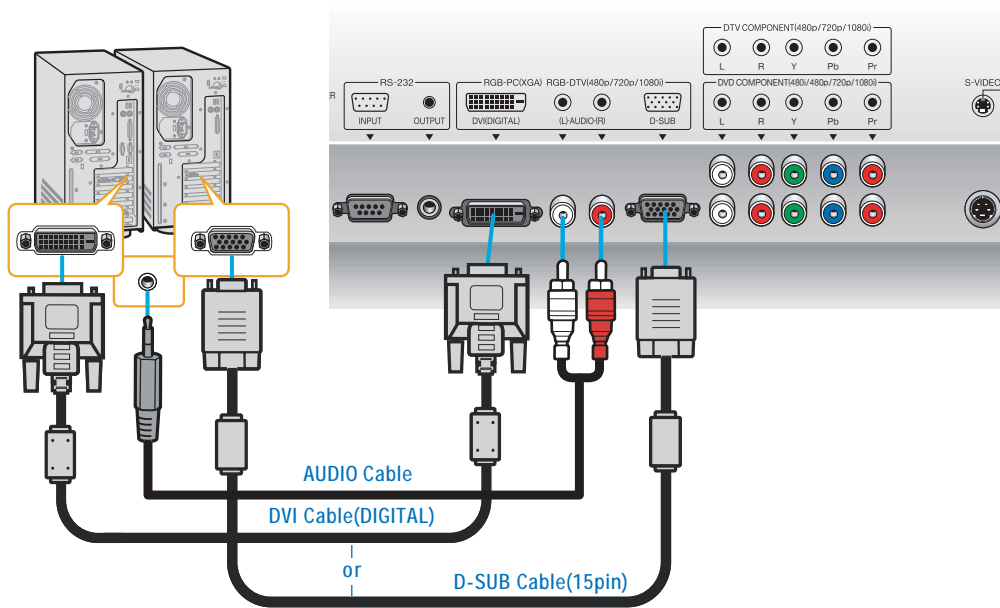

When Using As a PC Monitor

- 1 Turn on your PDP and press **TV/AV** on remote control unit.
- 2 Press **PC/DVI** to move between entries. And press **Left/Right** to select PC or DVI.

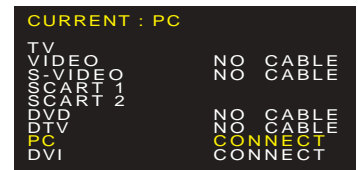

TIP

DVI cable provides better picture quality. This product supports plug-and-play function. We recommend the above method if the satellite receiver supports DTV signal with DVI(Digital) and D-sub(15 pin) cable for the better quality picture.



Resolutions Supported in PC

Resolution	Horizontal frequency	Vertical frequency
640 x 350	31.47	70.09
	37.86	85.08
640 x 480	31.47	59.94
	37.86	72.80
	37.50	75.00
	43.27	85.01
720 x 400	31.47	70.08
800 x 600	37.88	60.32
	48.08	72.18
	46.88	75.00
	53.67	85.06
832 x 624	49.72	74.55
1024 x 768	48.36	60.00
	60.02	75.03
	68.68	85.00

* Recommended Resolution is 1024x768@60Hz : HQP421HR / HQP501HR

* Recommended Resolution is 800x600@60Hz : HQP421SR

Scart Connection to the External Input

Connection Method

- 1 This end can be fitted with : A Scart connector
- 2 If you have video player that is supported CVBS, You can use Scart 1, Scart 2 port.

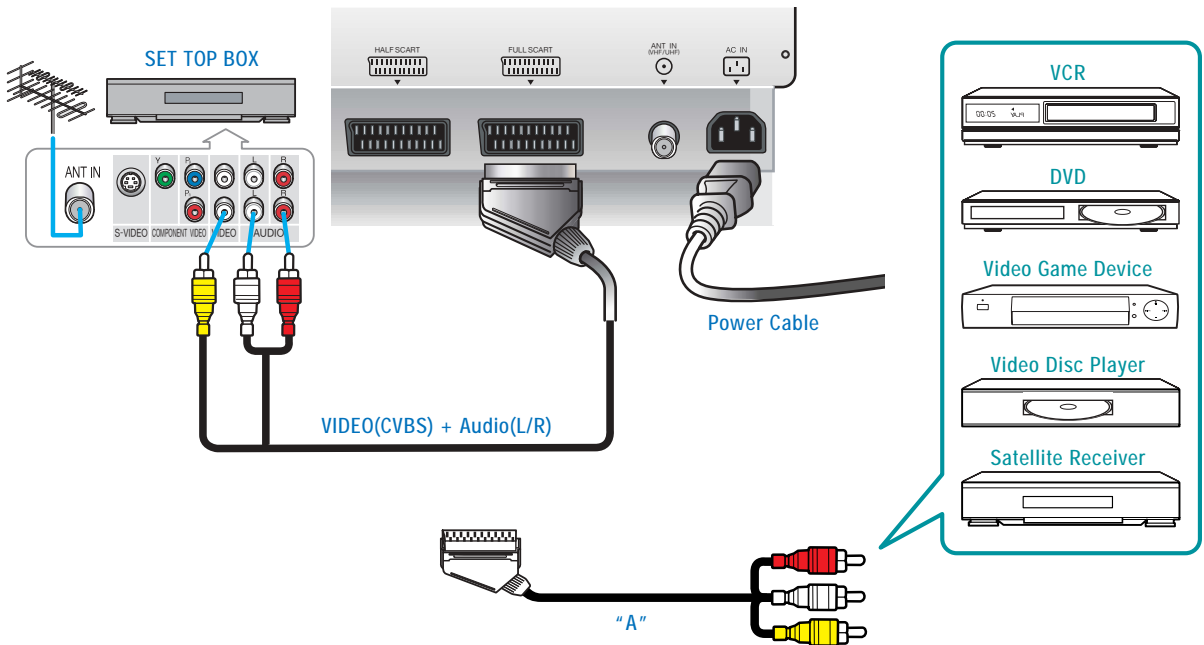

How to Watch

- 1 Turn on your PDP and press on remote control unit.
- 2 Press to move between entries. And press to select Scart 1 or Scart 2.

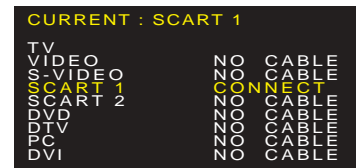

TIP

You can use composite video by scart 1/2, connector please contact your local service center about "A" cable.



CONNECTIONS

Picture Setup



How to Select the Picture Mode	35
How to Set the Desired Picture	36
How to Set Blue Screen	37
How to Set Film Mode	38
How to Select a Color Temperature	39
How to Set PIP [Mode]	40
How to Set Multi-Screen [Input Source/Position/Size]	41
Supported PIP Table	43
How to Set Noise Reduction	44
How to Select the Fit(Fine Image Technology) Engine Mode ...	45



How to Select the Picture Mode

Users can adjust picture mode automatically according to the input mode(TV, Video, S-Video, F/H Scart, DVD, DTV).



Press Menu button.
Menu items appear on the screen.

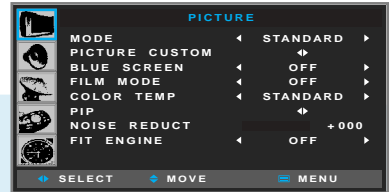

1



Press Up and Down buttons to move to "Picture" icon.

2



Press Left and Right buttons to select "MODE".

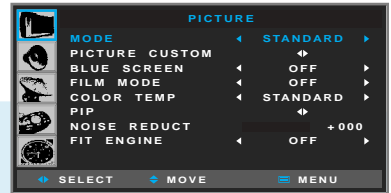

3



Press Left and Right buttons, then the menu changes in order below.
⇒ Standard ⇒ DYNAMIC ⇒ Movie
⇒ MILD ⇒ User ⇒



Press MENU button after the setting is done, and Menu goes to the previous menu.
If the EXIT button is pressed, the menu disappears.

STANDARD : For general contents. It fits most video contents.

DYNAMIC : For a clear display.

MOVIE : For movies.

MILD : For a soft display.

USER : When the user wants to set the values → [see the next page](#)

PICTURE

How To Directly Select Picture Mode : Press button.

- Users can select Standard ⇒ Dynamic ⇒ Movie ⇒ Mild ⇒ USER, when the input mode is TV, S-Video, Scart 1/2, DVD, DTV.
- Users can select Standard ⇒ Low(Text Mode) ⇒ High(Movie), when the input mode is PC or DVI.

TIP

In the user's mode, the users can adjust at thier preference contrast, brightness, sharpness, color, tint at standard, dynamic, movie, or mild mode.

*Adjustments menu may be different according to the input source.

How to Set the Desired Picture

Users can manually adjust the picture in their own ways.

- 

Press Menu button.
Menu items appear on the screen.

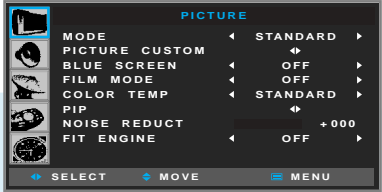

- 1



Press Up and Down buttons to move to "Picture" icon.
- 2

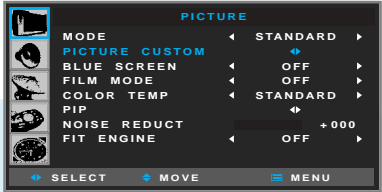

Press Left and Right buttons to select "PICTURE"



- 3





Press Up and Down buttons to move to "PICTURE CUSTOM".
- 4



Press Left and Right buttons to select "PICTURE CUSTOM".
Picture Custom menu appears.

- 5



Choose one of the items listed, then Press Left and Right buttons to adjust.
- 

Press MENU button after the setting is done, and Menu goes to the previous menu.
If the EXIT button is pressed, the menu disappears.

CONTRAST : Adjust the brightness and darkness of object and background.
BRIGHTNESS : Adjust the brightness of the entire picture.
SHARPNESS : Adjust clarity of outline of objects.
COLOR : Adjust colors into deeper or lighter colors.
TINT : Adjust colors naturally. ➔ This only applies to NTSC mode.



Setting of Color and Tint is not supported in PC, DVI and DTV input modes.



How to Set Blue Screen

If there is no broadcast or no signal from a connected external device, your PDP will show a blue screen.
If a broadcast signal comes in, the blue screen will be converted to a normal screen.



Press Menu button.
Menu items appear on the screen.

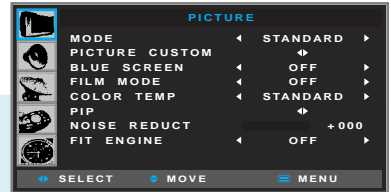

1



Press Up and Down buttons to move to "Picture" icon.

2



Press Left and Right button to select "PICTURE".

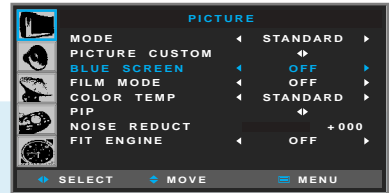

3



Press Up and Down button to move to "BLUE SCREEN".

4



Press Left and Right button to "ON/OFF".



Press MENU button after the setting is done, and Menu goes to the previous menu.
If the EXIT button is pressed, the menu disappears.

TIP

In the status of Blue Screen active, when the main picture receives no signal during watching a TV or VCR program as a main picture while viewing a VCR or TV program as a sub picture in PIP mode, the entire screen (including both main and sub pictures) will turn blue. When the main picture signal comes back, the both pictures will be restored to normal.

How to Set Film Mode

Set Film Mode to receive a crisp, clear picture without flickering.



Press Menu button.
Menu items appear on the screen.

1



Press Up and Down buttons to move to "Picture" icon.

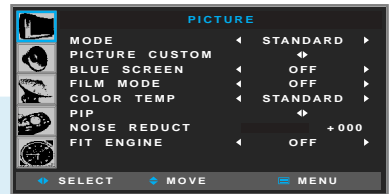

2



Press Left and Right button to select "PICTURE".

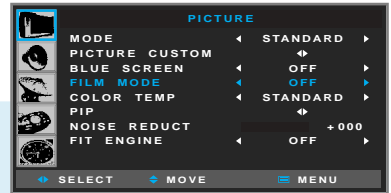

3



Press Up and Down button to move to "Film mode".

4



Press Left and Right button to "ON/OFF".



Press MENU button after the setting is done, and Menu goes to the previous menu.
If the EXIT button is pressed, the menu disappears.

TIP

You may experience the distortion of the screen edge during a DVD or VCR playback. This may be caused by bad edit of a film (a DVD title or tape). If you have come across this symptom, select OFF in the Film Mode.



How to Select a Color Temperature

Users can adjust Color as users want.



Press Menu button.
Menu items appear on the screen.

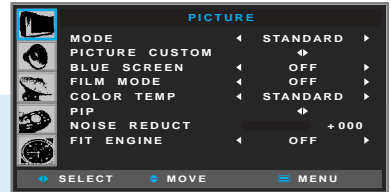

1



Press Up and Down buttons to move to
"Picture" icon.

2



Press Left and Right button to select
"PICTURE".

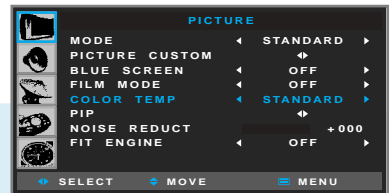

3



Press Up and Down button to move to
"COLOR TEMP".

4



Press Left and Right button, then Mode changes in order below.
⇒ Standard ⇒ Cool ⇒ Warm ⇒



Press MENU button after the setting is done, and Menu goes to the previous menu.
If the EXIT button is pressed, the menu disappears.

STANDARD : Colors for general picture.

COOL : Cool colors with bluish tone.

WARM : Warm colors with reddish tone.

How to Set PIP [Mode]

This is to set PIP(Picture In Picture) mode or Twin mode.



Press Menu button.
Menu items appear on the screen.

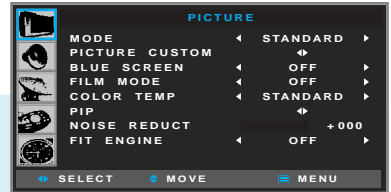

1



Press Up and Down buttons to move to "Picture" icon.

2



Press Left and Right button to select "PICTURE".

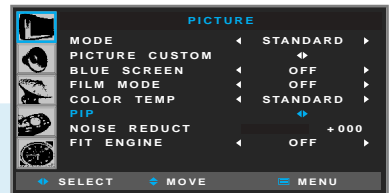

3



Press Up and Down button to move to "PIP".

4



Press Left and Right button to select "PIP".
Menu items appear on the screen.



5



Press Up and Down button to move to "MODE".

6



Press Left and Right button, then Mode changes in order below.
⇒ PIP ⇒ TWIN ⇒ OFF ⇒

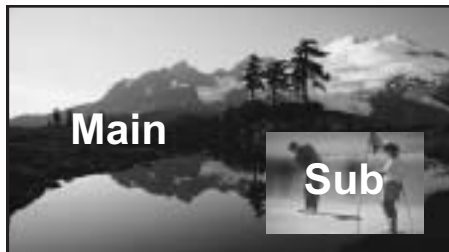

PIP : To watch the Sub screen in the main screen at once.



TWIN : To watch two screens in half and half.

After setting this, go to step 7 to set the SOURCE.



How to Set Multi-Screen [Input Source/Position/Size]

This is to set the Input Source, Position and Size of the Sub-picture. (This function is available only when PIP mode active.)



Press Up and Down buttons to move to "SOURCE".



Press Left and Right button, then source changes in order below.

- ⇒ TV ⇒ Video ⇒ S-Video ⇒ SCART 1
- ⇒ SCART 2 ⇒ DVD ⇒ DTV ⇒ PC ⇒ DVI ⇒

In case of PIP mode, go to step 9 if you need to set the "SWAP" of Main and sub pictures.



Press Up and Down buttons to move to "SWAP".



Press Left and Right buttons.

In case of PIP mode, go to step 11 if you need to set the "SIZE" of Sub picture.



Press Up and Down buttons to move to "Size".



Press Left and Right buttons to set to "LARGE/SMALL".

In case of PIP mode, go to step 13 if you need to set the "POSITION" of Sub picture.



Press Up and Down buttons to move to "POSITION".

14



Press Left and Right button, then position changes in order below.

⇒ Right Down ⇒ Left Down ⇒ Left Up ⇒ Right Up ⇒

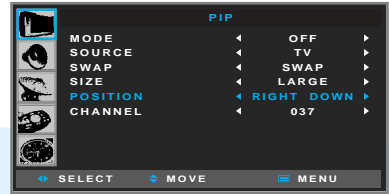

In case the Input source in Sub picture is TV, go to step 15 when you wish to change the channels of Sub picture.

15



Press Up and Down buttons to move to "Channel".



16



Press Left and Right button to select "Channel Number".



Press MENU button after the setting is done, and Menu goes to the previous menu. If the EXIT button is pressed, the menu disappears.



▲ Adjust the location in PIP

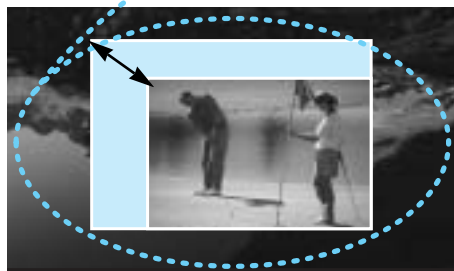

▲ Adjust the size in PIP

For details on Hot-keys on the remote control, please go to the next page.



Hot-Keys on the Remote Control

How to Directly Turn PIP FUNCTION ON/OFF : Press ^{ON/OFF}  button.

To turn ON/OFF the PIP function

How To Directly Adjust PIP MODE & SIZE : Press ^{SIZE}  button.

To watch PIP/TWIN ways or to adjust the Size of Sub picture.

⇒ Large ⇒ Small ⇒ TWIN ⇒

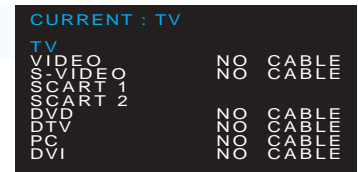

How To Directly Change Sub Source : Press ^{SOURCE}  button.

Press Up and Down buttons to move to the Sub Source.
And select using Left or Right button.



How To Directly Set The SWAP : Press ^{SWAP}  button.

To swap the Main picture and sub picture.

How To Directly Set The Sub Channel : Press   button.



Main and sub pictures cannot have the same input source.

Supported PIP Table

PIP : 0 → Supported, X → Not Supported

Main \ Sub	PC	DVI	DTV	DVD	TV	S-Video	Video	Scart 2	Scart 1
PC	X	X	X	X	0	0	0	0	0
DVI	X	X	X	X	0	0	0	0	0
DTV	X	X	X	X	0	0	0	0	0
DVD	X	X	X	X	0	0	0	0	0
TV	0	0	0	0	0	0	0	0	0
S-Video	0	0	0	0	0	X	0	0	0
Video	0	0	0	0	0	0	X	0	0
Scart 2	0	0	0	0	0	0	0	X	0
Scart 1	0	0	0	0	0	0	0	0	X

How to Set Noise Reduction

This is to eliminate some noise on the screen in Video mode.



Press Menu button.
Menu items appear on the screen.

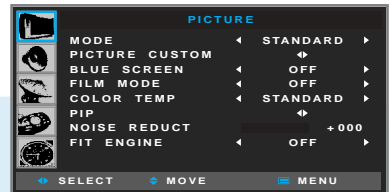

1



Press Up and Down buttons to move to "Picture" icon.

2



Press Left and Right button to select "PICTURE".

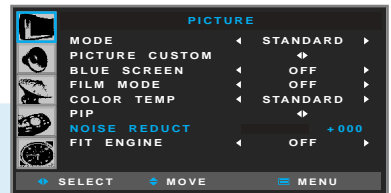

3



Press Up and Down button to move to "NOISE REDUCT".

4



Press Left and Right button to adjust Screen quality.



Press MENU button after the setting is done, and Menu goes to the previous menu.
If the EXIT button is pressed, the menu disappears.



In the Noise Reduction, the more you reduce the screen noise, the more the sharpness level of the pictures may become degraded.



How to Select the Fit(Fine Image Technology) Engine Mode

Fit Engine mode function allows users to experience more lively, clearly and brightly images. (For 50" PDP only)



Press Menu button.
Menu items appear on the screen.

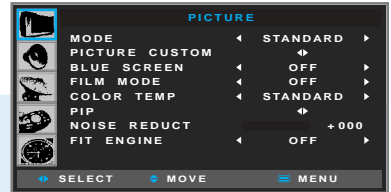

1



Press Up and Down buttons to move to "Picture" icon.

2



Press Left and Right button to select "PICTURE".

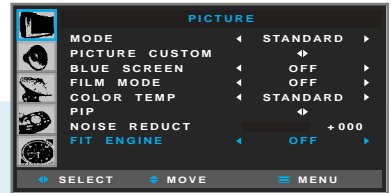

3



Press Up and Down button to move to "FIT ENGINE".

4



Press Left and Right button, then the menu changes in order below.
⇒ OFF ⇒ DEMO ON ⇒ ON ⇒

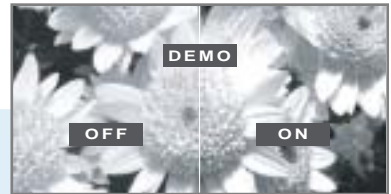

Press MENU button after the setting is done, and Menu goes to the previous menu.
If the EXIT button is pressed, the menu disappears.



Only In the FIT ENGINE demo mode, Demo OSD can appear on the screen after 1 or 2 seconds.

Sound Setup



How to Select the Audio Mode	47
How to Set the Desired Audio	48
How to Select AVL	49
How to Select SRS WOW(Surround)	50
How to Select MTS(Multi-Channel Sound)	51
How to Set the Output of Subwoofer	52



How to Select the Audio Mode

Users can adjust sound mode automatically as users want.



Press Menu button.
Menu items appear on the screen.



1



Press Up and Down buttons to move to "SOUND" icon.

2



Press Left and Right buttons to select "SOUND".



3



Press Left and Right button, then the menu changes in order below.

⇒ Standard ⇒ Music ⇒ Movie
⇒ News ⇒ User ⇒



Press MENU button after the setting is done, and Menu goes to the previous menu.
If the EXIT button is pressed, the menu disappears.

STANDARD : For the general sound. This fits most audio contents.

MUSIC : For enjoying original sound.

MOVIE : For grandiose sound.

NEWS : For the clear sound.

USER : When the user wants to set the value → [see the next page](#)

SOUND

How To Directly Select Picture Mode : Press  button.

Users can select STANDARD ⇒ MUSIC ⇒ MOVIE ⇒ NEWS ⇒ USER in order.

How to Set the Desired Audio

Users can manually adjust the sound in thier own ways.



Press Menu button.
Menu items appear on the screen.



1



Press Up and Down buttons to move to "SOUND" icon.

2



Press Left and Right buttons to select "SOUND".



3



Press Up and Down buttons to move to "SOUND custom".

4



Press Left and Right buttons to select "SOUND custom".
Sound Custom menu appears.

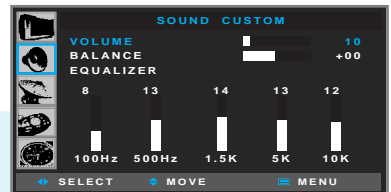

5



Choose one of the items listed,
then Press Left and Right buttons to adjust.



Press MENU button after the setting is done, and Menu goes to the previous menu.
If the EXIT button is pressed, the menu disappears.

VOLUME : Adjusts the volume.
BALANCE : Adjusts the balance of left and right speakers.
EQUALIZER : Adjusts the audio output signal in the desired band.



How to Select AVL

This function automatically gives a similar volume size to each channel.



Press Menu button.
Menu items appear on the screen.



1



Press Up and Down buttons to move to "SOUND" icon.

2



Press Left and Right buttons to select "SOUND".



3



Press Up and Down buttons to move to "AVL".

4



Press Left and Right buttons to "ON/OFF".



Press MENU button after the setting is done, and Menu goes to the previous menu.
If the EXIT button is pressed, the menu disappears.

How to Select SRS WOW(Surround)

You can enjoy the spectacular, clear and crisp sound.



Press Menu button.
Menu items appear on the screen.



1



Press Up and Down buttons to move to "SOUND" icon.

2



Press Left and Right buttons to select "SOUND".



3



Press Up and Down buttons to move to "SRS WOW".

4



Press Left and Right buttons to "ON/OFF".



Press MENU button after the setting is done, and Menu goes to the previous menu.
If the EXIT button is pressed, the menu disappears.

TIP

The SRS WOW function is activated only when the audio input signal is Stereo.



is a trademark of SRS Labs, Inc.

WOW technology is incorporated under license from SRS Labs, Inc.

Remarkable Enhancement for Mono or Stereo Playback

WOW™, is an award-winning, patented technology that significantly enhances the quality of mono and stereo audio material. It creates the perception of improved dynamics and bass performance over standard speakers or headphones.

WOW makes up for the limitations inherent in smaller speakers and headphones by providing a panoramic three-dimensional audio image that extends the sound in both the horizontal and vertical planes well beyond the speakers or headphones themselves. As a result, manufacturers of small audio devices, televisions, wireless and personal/portable products can dramatically improve their product's audio performance without enlarging the speaker size. The enriching effects of WOW are especially noticeable on digitally compressed mono or stereo audio in formats such as MP3, WMA and audio CD in which the "tinny" hollow sound is greatly reduced.



How to Select MTS(Multi-Channel Sound)

Depending on the particular program being broadcast, you can select to stereo, mono, or a Separate Audio Program. (SAP audio is usually a foreign-language translation. Sometimes SAP has unrelated information like news or weather.)



Press Menu button.
Menu items appear on the screen.



1



Press Up and Down buttons to move to "Sound" icon.

2



Press Left and Right buttons to select "Sound".



3



Press Up and Down buttons to move to "MTS".

4



Press Left and Right buttons, Repeatedly to select "MONO", "STEREO" or "SAP".



Press MENU button after the setting is done, and Menu goes to the previous menu. If the EXIT button is pressed, the menu disappears.

How To Directly Select MTS : Press  button.

Repeatedly to select "MONO", "Stereo" or "SAP".

- Choose "Stereo" for channels that are broadcasting in STEREO.
- Choose "MONO" for channels that are broadcasting in MONO, or if you are having difficulty receiving a STEREO signal.
- Choose "SAP" to listen to the separate audio program, which is usually a foreign-language translation.

TIP

If the signal reception conditions deteriorate, setting to Mono will make your listening condition better.

How to Set the Output of Subwoofer

You can set this function when you wish to install your subwoofer speaker system.



Press Menu button.
Menu items appear on the screen.



1



Press Up and Down buttons to move to "SOUND" icon.

2



Press Left and Right buttons to select "SOUND".



3



Press Up and Down buttons to move to "SUB WOOFER".

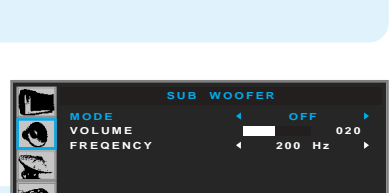

4



Press Left and Right buttons to select "SUB WOOFER".
Sub Woofer menu appears.

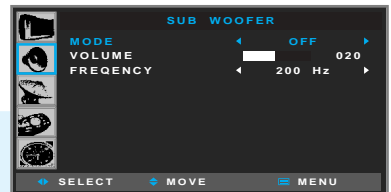

5



Choose item, then Press Left and Right buttons to adjust.



Press MENU button after the setting is done, and Menu goes to the previous menu.
If the EXIT button is pressed, the menu disappears.



- The frequencies in the entry are the subwoofer's frequency range.
- You make sure to use a subwoofer speaker system with built-in amplifier.



Channel Setup



Memorizing the Channels	55
Fine Tuning Channel Reception	56
Storing Channels Manually	57
Using the LNA(Low-Noise-Amplifier) Feature	58



Memorizing the Channels

Your PDP can memorize and store all of the available channels for both "off-air" (antenna) and cable channels. After the available channels are memorized, use the CH and CH buttons to scan through the channels. This eliminates the need to change channels by entering the channel digits. There are three steps for memorizing channels: selecting a broadcast source, memorizing the channels (automatic) and adding and deleting channels (manual).

Selecting the Video Signal-source

Before your television can begin memorizing the available channels, you must specify the type of signal source that is connected to the TV (i.e., an antenna or a cable system).



Press Menu button.
Menu items appear on the screen.

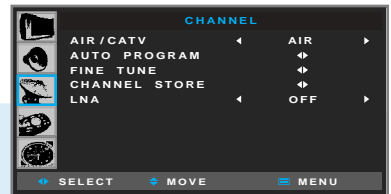

1



Press Up and Down buttons to move to "CHANNEL" icon.

2



Press Left and Right buttons to select "CHANNEL".
AIR/CATV is highlighted.

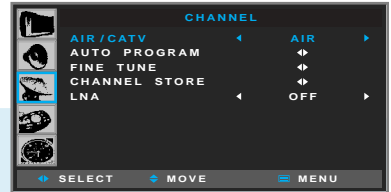

3



Repeatedly press the Left/Right buttons to cycle through these choices :
⇒ STD ⇒ HRC ⇒ IRC ⇒ AIR ⇒

4



Press Up and Down buttons to move to "AUTO PROGRAM".

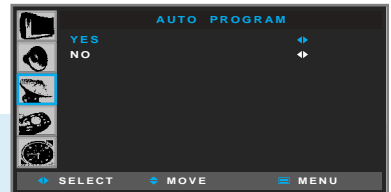

5



Press Left and Right buttons to select "AUTO PROGRAM".
AUTO PROGRAM menu appears.

6



Press Left and Right buttons to select "YES", then store the selected channels.

CHANNEL SETUP



- STD, HRC and IRC identify various types of cable TV systems. contact your local cable company to identify the of cable system that exists in your particular area.
- The PDP automatically cycles through all available channels and stores them in memory.
- If you press the MENU button in the middle of AUTO STORE, the first stored channel will be displayed, and the AUTO STORE stops.

Fine Tuning Channel Reception

If the reception is clear, you do not have to fine tune channels, as this is done automatically during the search and store operation. If the signal is weak or distorted, you may have to fine tune the channel manually.



Press Menu button.
Menu items appear on the screen.



1



Press Up and Down buttons to move to "CHANNEL" icon.

2



Press Left and Right buttons to select "CHANNEL".

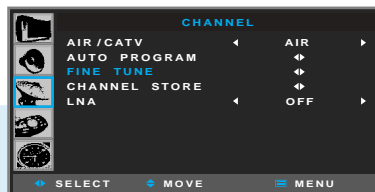

3



Press Up and Down buttons to move to "Fine Tune".

4



Press Left and Right buttons to select "Fine Tune".
New Menu items appear.

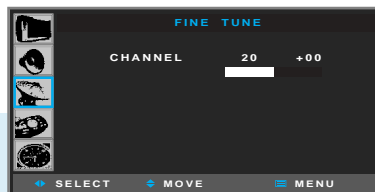

5



Press Left and Right buttons to adjust Screen.
*Channel number is current channel.



Press MENU button after the setting is done, and Menu goes to the previous menu.
If the EXIT button is pressed, the menu disappears.



OSD for the fine tuned channels is highlighted in blue.
On INFORMATION active, MFT (Manual Fine Tune) after the channel number will be displayed.



Storing Channels Manually

You can exclude the channels of your choice from the channel scan operation. When you scan through the stored channels, those that you have chosen to skip are thus not displayed.

All channels that you do not specifically choose to skip are displayed during scanning.



Press Menu button.
Menu items appear on the screen.

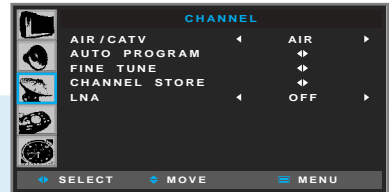

1



Press Up and Down buttons to move to "CHANNEL" icon.

2



Press Left and Right buttons to select "CHANNEL".

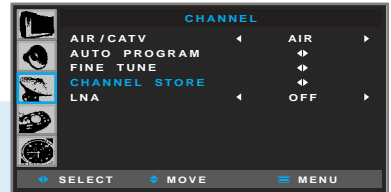

3



Press Up and Down buttons to move to "CHANNEL STORE".

4



Press Left and Right buttons to select "CHANNEL STORE".
Channel Store menu appears.



5



*The displayed channel number indicates a current channel.
Press Left and Right buttons to select Channel Number.

6



Press Up and Down buttons to move to "ADD/DELETE".

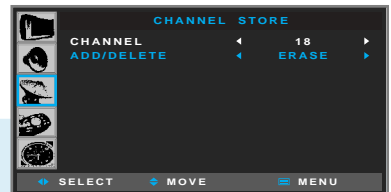

7



Press Left and Right buttons, then select ADD or ERASE.



Press MENU button after the setting is done, and Menu goes to the previous menu.
If the EXIT button is pressed, the menu disappears.

Using the LNA(Low-Noise-Amplifier) Feature

If the reception is clear, you don't have to use this feature.
 If the signal is weak or distorted, try the followings.



Press Menu button.
 Menu items appear on the screen.

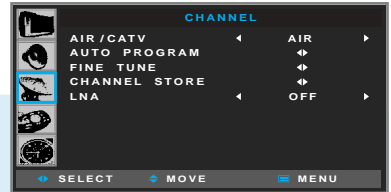

1



Press Up and Down buttons to move to "CHANNEL" icon.

2



Press Left and Right buttons to select "CHANNEL".

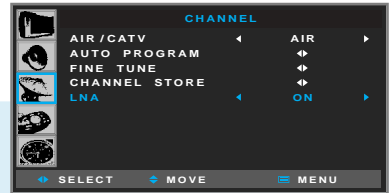

3



Press Up and Down buttons to move to "LNA".

4



Press Left and Right buttons to ON/OFF.



Press MENU button after the setting is done, and Menu goes to the previous menu.
 If the EXIT button is pressed, the menu disappears.



Function Setup



How to Select the Aspect Ratio	61
Displaying Information	63
How to Set Key-Lock	64
Using the Pixel Shift / Full White / Wiper Function	65
How to Freeze Picture	66
How to Set DPMS	67
Choosing the Your Languages	68
How to Set Image Adjust in PC Mode	69
Viewing Closed Captions	71
Using the V-Chip	73



How to Select the Aspect Ratio

Users can adjust Aspect Ratio as users want.



Press Menu button.
Menu items appear on the screen.

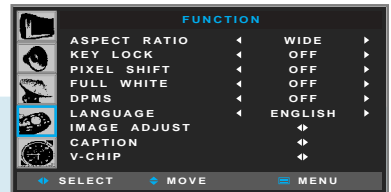

1



Press Up and Down buttons to move to "FUNCTION" icon.

2



Press Left and Right buttons to select "FUNCTION".



3



Press Up and Down buttons to move to "ASPECT RATIO".

4



Press Left and Right buttons to select "ASPECT RATIO".

5



Press Left and Right buttons, then the menu changes in order below.
⇒ Wide ⇒ Normal ⇒ Panorama ⇒ Zoom1 ⇒ Zoom2 ⇒ Zoom3 ⇒ Auto Wide ⇒



Press MENU button after the setting is done, and Menu goes to the previous menu.
If the EXIT button is pressed, the menu disappears.

ASPECT

How To Directly Select Aspect Ratio : Press button.

OSD menu displays the current aspect ratio.

If you press the ASPECT button second time, aspect ratio will be changed according to Input mode as follows :

- Under DTV, DVD inputs : Users can select Wide ⇒ Zoom1 ⇒ Zoom2 ⇒ Zoom3 ⇒ Auto Wide in order.
- Under PC, DVI inputs : Users can select Wide ⇒ Normal ⇒ Auto Wide in order.
- Under other inputs : Users can select Wide ⇒ Normal ⇒ Panorama ⇒ Zoom1 ⇒ Zoom2 ⇒ Zoom3 ⇒ Auto Wide in order.

WIDE / AUTO WIDE

General broadcast picture is adjusted to 16:9.



NORMAL

General picture size.



PANORAMA

Picture size for panorama video.

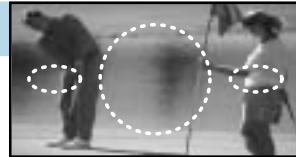

ZOOM1

Zoom in 16:9 in vertical direction.



ZOOM2

The picture enlarged to 16:9 format. This mode is recommended in letter box format.



ZOOM3

This Mode is used to display 4:3. The picture using the full surface of the screen leaving the Sub-title visible.





Displaying Information

You can view the channel information and setting status by pressing the "INFO" button on the remote control.

INFO



In case of applying TV input
Press INFO button.

AIR - 020
12 : 30 AM

PICTURE MODE : STANDARD
SOUND MODE : USER
MTS MODE : MONO
INPUT SIGNAL : MONO

INFO



In case of applying VIDEO input
Press INFO button.

VIDEO - NTSC
12 : 30 AM

INFO



In case of applying PC input
Press INFO button.

PC - 1024x768 70Hz
12 : 30 AM

EXIT



If the EXIT button is pressed, the menu disappears.

How to Set Key-Lock

This is to lock the control buttons on the front bottom of PDP.



Press Menu button.
Menu items appear on the screen.

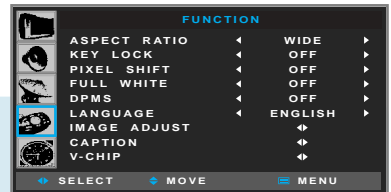

1



Press Up and Down buttons to move to "FUNCTION" icon.

2



Press Left and Right buttons to select "FUNCTION".

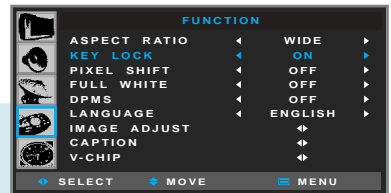

3



Press Up and Down buttons to move to "KEY LOCK".

4



Press Left and Right buttons to ON/OFF.



Press MENU button after the setting is done, and Menu goes to the previous menu. If the EXIT button is pressed, the menu disappears.

TIP

When the AC power supply is cut off, key-lock function is automatically off.



Using the Pixel Shift / Full White / Wiper Function

This feature is designed to reduce image sticking effects during displaying a static picture. (Brightness degradation is caused by the scale effects of a panel, which is characteristic of a PDP.)



Press Menu button.
Menu items appear on the screen.

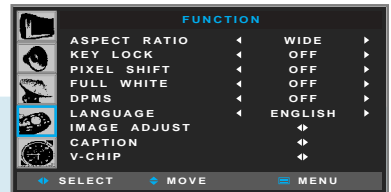

1



Press Up and Down buttons to move to "FUNCTION" icon.

2



Press Left and Right buttons to select "FUNCTION".

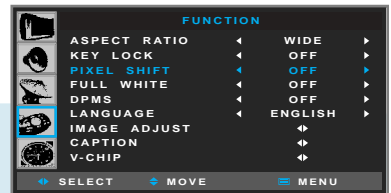

3



Press Up and Down buttons to move to "PIXEL SHIFT" or "FULL WHITE".

4



Press Left and Right buttons to "ON/OFF".

4



Press MENU button after the setting is done, and Menu goes to the previous menu. If the EXIT button is pressed, the menu disappears.

While FULL WHITE is activated, if you wish to switch the mode to Off or wish to use other function, press any of buttons on the remote control unit or any of control keys on the PDP unit. Then the menu screen will appear again. Press the left or right button to deactivate the current mode.

It may take from several minutes up to several hours to remove the image sticking. If a fixed pattern is displayed for a long time, you can prevent the latent image by switching FULL WHITE to On for 2 or 3 minutes on a hourly basis. The image sticking effect is influenced by the brightness of a fixed pattern and its display time. It is recommended that you reduce the level of the brightness by using picture controls (See page 36) when a fixed pattern is displayed for a long time.

WIPER

How To Directly Select Wiper : Press  button.

The image sticking (brightness degradation) is eliminated as white bars are moving in the right direction.

How to Freeze Picture

The user can temporarily stop the playing picture.

STILL



Press Still button.

Playing picture is stopped.

- Under multi-screen mode(PIP, TWIN), the main picture stops.

To deselect Still function.

Press Still button once more.





How to Set DPMS

When in PC mode, you can activate Power Saving mode.



Press Menu button.
Menu items appear on the screen.

1



Press Up and Down buttons to move to "FUNCTION" icon.



2



Press Left and Right buttons to select "FUNCTION".

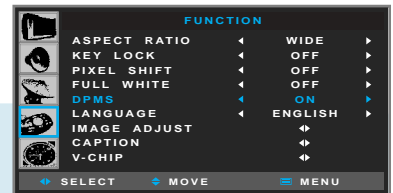

3



Press Up and Down buttons to move to "DPMS".

4



Press Left and Right buttons to "ON/OFF".



Press MENU button after the setting is done, and Menu goes to the previous menu.
If the EXIT button is pressed, the menu disappears.



DPMS feature is available for PC mode only.

Choosing the Your Languages

When you start using your TV for the first time, you must select your language preference in order to display main menus and sub menus, etc.



Press Menu button.
Menu items appear on the screen.

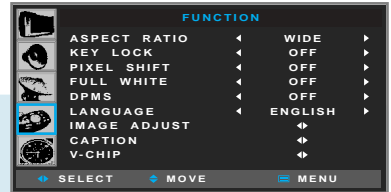

1



Press Up and Down buttons to move to "FUNCTION" icon.

2



Press Left and Right buttons to select "FUNCTION".



3



Press Up and Down buttons to move to "LANGUAGE".

4



Press Left and Right button, then the menu changes in order below.
⇒ English ⇒ French ⇒ German ⇒ Spanish ⇒ Italian ⇒



Press MENU button after the setting is done, and Menu goes to the previous menu.
If the EXIT button is pressed, the menu disappears.



How to Set Image Adjust in PC Mode



Press Menu button.
Menu items appear on the screen.



1



Press Up and Down buttons to move to "FUNCTION" icon.

2



Press Left and Right buttons to select "FUNCTION".

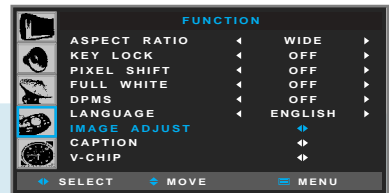

3



Press Up and Down buttons to move to "IMAGE ADJUST".

4



Press Left and Right buttons to select "IMAGE ADJUST".
Image adjust menu appears.



5



Press Up and Down buttons to choose Item.

6



Press Left and Right buttons to adjust.



Press MENU button after the setting is done, and Menu goes to the previous menu.
If the EXIT button is pressed, the menu disappears.

HORIZONTAL POSITION : To adjust the horizontal position of the picture.
 VERTICAL POSITION : To adjust the vertical position of the picture.
 FREQUENCY : To adjust to reduce the noise on the picture.
 PHASE : To adjust to eliminate the shake of the picture.
 Auto ADJUST : Horizontal/vertical positions are automatically adjusted.

How To Directly Select Auto Track : Press  button.

Automatically adjust Horizontal/Vertical position of the picture.

TIP

- This function is provided in only PC mode.
- When executing PC AUTO, optimum picture can be obtained if the setting is made under the full pattern.
- You can store up to six modes by activating PC AUTO function.
If you exceed six modes, the first stored mode information will be removed and a newly stored mode will be stored.



Viewing Closed Captions

Your TV decodes and displays the closed captions that are broadcast with certain TV shows. These captions are usually subtitles for the hearing impaired or foreign language translations. All VCRs record the closed caption signal from television programs, so home-recorded video tapes also provide closed captions. Most prerecorded commercial video tapes provide closed captions as well. Check for the closed caption symbol in your television schedule and on the tape's packaging : 

* The Caption feature does not work with DVD or DTV signals.



Press Menu button.
Menu items appear on the screen.

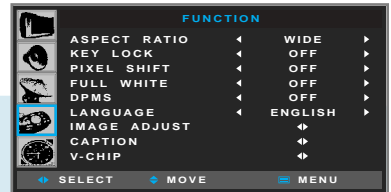

1



Press Up and Down buttons to move to "FUNCTION" icon.

2



Press Left and Right buttons to select "FUNCTION".

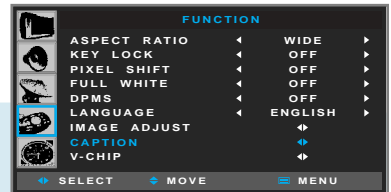

3



Press Up and Down buttons to move to "CAPTION".

4



Press Left and Right buttons to select "CAPTION".
Caption menu appears.



5



Caption is highlighted.
Press Left and Right buttons to "ON/OFF".

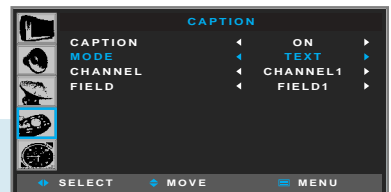

6



Press Left and Right buttons to select "TEXT or CAPTION".

Press the Down button and then go to step 6 if you need to set the Mode.

Press the Down button and then go to step 7 if you need to depending on the particular broadcast, it might be necessary to make changes to "Channels" and "Field"

Continued on next page

..... Continued from previous page.

7



Press the UP/DOWN/LEFT/RIGHT button to make the changes.



8

Follow the same procedure as in steps 6 above.



Press MENU button after the setting is done, and Menu goes to the previous menu.
If the EXIT button is pressed, the menu disappears.



TIP

Different channels and fields display information.
Field 2 carries additional information that supplements the information in Field 1.
(For example, channel 1 may have subtitles in English, while channel 2 has subtitles in spanish.)



Using the V-Chip

The V-Chip feature automatically locks out programs that are deemed inappropriate for children. The user must enter a PIN(Personal ID Number) before any of the V-chip restrictions are set up or changed.

**When the V-Chip feature is activated, the PIP features do not function.*



Press Menu button.
Menu items appear on the screen.

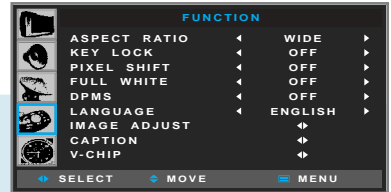

1



Press Up and Down buttons to move to "FUNCTION" icon.

2



Press Left and Right buttons to select "FUNCTION".



3



Press Up and Down buttons to move to "V-CHIP".

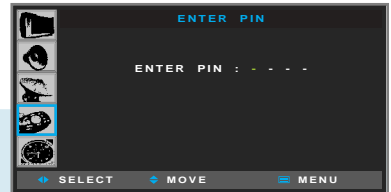

4



Press Left and Right buttons to select "V-CHIP".
The message "Enter PIN" will appear.

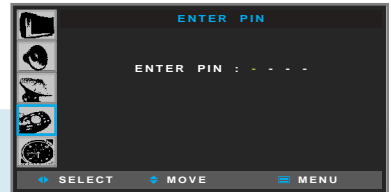

5

Enter you 4-digit PIN number.
The default PIN number of a new TV set is "0-0-0-0".
The "V-Chip" Screen will appear.

6



Press Up and Down buttons to move to "CHANGE PIN",

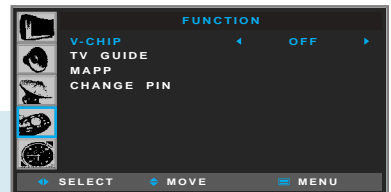

7



Press Left and Right buttons to select "CHANGE PIN".
The change PIN screen will appear.

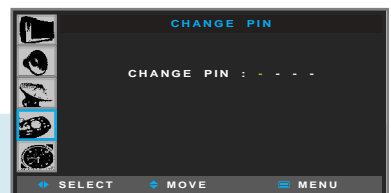

8

Choose any 4-digits for your PIN and enter them.
As soon as the 4-digits are entered, the "Confirm New PIN" screen appears.

Continued on next page

..... Continued from previous page.

9

Re-enter the same 4 digits.
When the confirm screen disappears,
your PIN has been memorized.
V-CHIP is highlighted.



Go to step 10, if you need to set restrictions using the "TV Guideline".

TIP

If you forget the PIN, Press the remote-control buttons in the following sequence,
which resets the PIN to "0-0-0-0".

MENU + MTS + SLEEP + INFO (On the Remote Control)



This message should be printed on a separate page of paper or on a page of the manual that can be removed
by a parent and put in a safe place where the children cannot find this message!!

10



Press Left and Right buttons to "ON/OFF".



11



Press Up and Down buttons to move to
"TV GUIDE".



12



Press Left and Right buttons to select "TV GUIDE".
TV Guide menu appears .

13



Press the Up and Down button to select
one of the six age-based categories.

TV-Y : Young children	TV-PG : Parental guidance
TV-Y7 : Children 7 and over	TV-14 : Viewers 14 and over
TV-G : General audience	TV-MA : Mature audience

Continued on next page



..... Continued from previous page.

14

At this point, one of the TV-Guidelines is selected.
Press the right button : Depending on your exiting setup, a letter "U" or "B" will start blinking.
(U=Unblocke, B=Blocked)

15

Whlie the "U" or "B" is blinking, **press the Up and Down button** to block or Unblock the category.
Press the Right button to save the TV-Guidelines.
A TV-Rating will selected, and no letters will blink.
To select a differnt TV-Rating, **press the Up and Down button and them repeat the process.**

Note 1 : The TV-Y7, TV-PG, TV-14 and TV-MA have additional options.
See the next step to change any of the following sub-ratings:

FV : Fantasy violence **L** : Adult Language **V** : Violence
D : Sexually Sugessive Dialog **S** : Sexual situation

Note 2 : The V-Chip will automatically block certain categories that are "more restrictive".
For example, if you block "TV-Y" category, then TV-Y7 will automatically be blocked.
Similarly, if you block the TV-G category, then all the categories in the "young adult"
group will be blocked (TV-G, TV-PG, TV-14 and TV-MA).
The sub-ratings (D, L, S, V) work together similarly. (See next section.)

Go to step 16, if you need to set FV, D, L, S and V sub-ratings.

16

First, select one of these TV-Ratings :
TV-Y7, TV-PG, TV-14 or TV-MA (See Step ~, on previous page).

17

Next, while the TV-Rating is selected, **repeatedly press the RIGHT button.**
This will cycle through the available sub-ratings (FV,L, S, D or V).
A blinking letter ("U" or "B") will be displayed for each sub-rating. While the "U" or "B" is
blinking, **press the UP or DOWN button** to change the sub-rating.

18

Press the RIGHT button to save the TV guidelines. A TV-Rating will be selected and no
letters will select. To select a different TV-Rating, **press the UP or DOWN button and then
repeat the process.**

Note : The V-chip will automatically block certain categories that are "More restrictive".
For example, if you block "L" sub-rating in TV-PG, then the "L" sub-ratings in TV-14
and TV-MA will automatically be blocked.

Clock Setup



How to Set Clock	77
How to Set On Time	78
How to Set Off Time	80
How to Set Sleep Time	82



How to Set Clock

You can set the current time so that it may be displayed by pressing the "INFO" button. You must also set a clock if you wish to use the automatic on or off timers.

Ex) To set to 6:30 PM,



Press Menu button.
Menu items appear on the screen.



1



Press Up and Down buttons to move to "TIME" icon.

2



Press Left and Right buttons to select "TIME".



3



Press Up and Down buttons to move to "CLOCK".



4



Press Left and Right buttons to select "CLOCK".
Press the button a second time to move to "HOUR".



5



Press Up and Down buttons to set to "6".

6



Press Left and Right buttons to move to "MINUTE" unit.



7



Press Up and Down buttons to set to "30".

8



Press Left and Right buttons to move to "AM/PM".



9



Press Up and Down buttons to set to "PM".

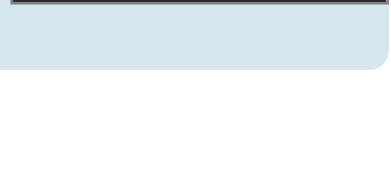



When the power supply(AC main power) is cut off, the clock is reset to the value before the Time set.

Press the Right button and then go to step 10 if you need to set on time.

How to Set On Time

This function allows you to automatically turn on your PDP at the preset time.

Ex) To set to 7:20 AM,

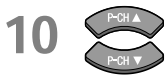

Press Up and Down buttons to move to "ON TIME".



Press Left and Right buttons to select "ON TIME".
On Time menu appears.



Press Left and Right buttons to select "TIME" to move to "HOUR".

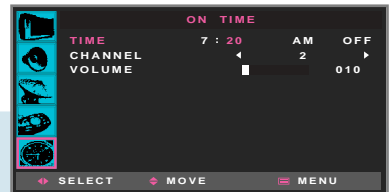

Press Up and Down buttons to set to "7".



Press Left and Right buttons to move to "MINUTE" unit.



Press Up and Down buttons to set to "20".



Press Left and Right buttons to move to "AM/PM".



Press Up and Down buttons to set to "AM".

Continued on next page



..... Continued from previous page. (Set the volume level and channel at the time when your PDP turns on.)



Press Left and Right button to move to "ON/OFF".



Press Up and Down buttons to set to "ON".

Press the Right button and then go to step 20 if you need to set the Channel/Volume.



Press Up and Down buttons to move to "CHANNEL".

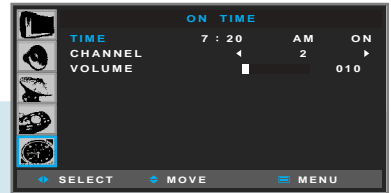

Press Left and Right buttons to set to "Channel".



Press Up and Down buttons to move to "VOLUME".



Press Left and Right buttons to adjust.



Press MENU button after the setting is done, and Menu goes to the previous menu. If the EXIT button is pressed, the menu disappears.



Regardless of which Input Mode you set On Time in, your PDP will turn on in TV Mode only.

How to Set Off Time

This function allows you to automatically turn off your PDP at the preset time.

Ex) To set to 11:30 PM,



Press Menu button.
Menu items appear on the screen.



1



Press Up and Down buttons to move to "TIME" icon.

2



Press Left and Right buttons to select "TIME".



3



Press Up and Down buttons to move to "OFF TIME".



4



Press Left and Right buttons to select "OFF TIME" to move to "HOUR" unit.

5



Press Up and Down buttons to set to "11".

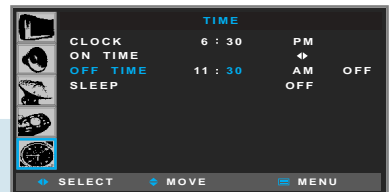

6



Press Left and Right buttons to move to "MINUTE" unit.

7



Press Up and Down buttons to set to "30".

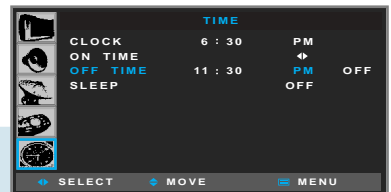

8



Press Left and Right buttons to move to "AM/PM".

9



Press Up and Down buttons to set to "PM".

Continued on next page



..... Continued from previous page.

10



Press Left and Right button to move to "ON/OFF".

11









Press Up and Down buttons to set to "ON".

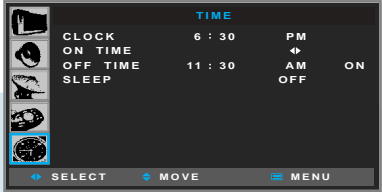

Press MENU button after the setting is done, and Menu goes to the previous menu. If the EXIT button is pressed, the menu disappears.

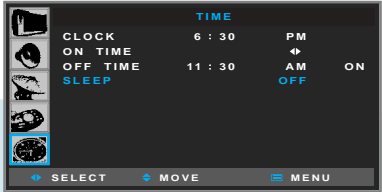
How to Set Sleep Time

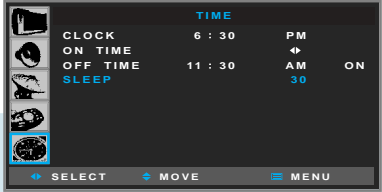
This function allows you to automatically turn off your PDP after a designated amount of time.

	<p>Press Menu button. Menu items appear on the screen.</p>	
1 	<p>Press Up and Down buttons to move to "TIME" icon.</p>	
2 	<p>Press Left and Right buttons to select "TIME".</p>	
3 	<p>Press Up and Down buttons to move to "SLEEP".</p>	
4 	<p>Press Left and Right buttons, then the menu changes in order below. (Unit : Minute) ⇒ OFF ⇒ 30 ⇒ 60 ⇒ 90 ⇒ 120 ⇒ 240 ⇒</p>	
	<p>Press MENU button after the setting is done, and Menu goes to the previous menu. If the EXIT button is pressed, the menu disappears.</p>	

How To Directly Start Sleep : Press  button.

Press sleep button, then the setting changes in order below. (Unit : Minute)
⇒ OFF ⇒ 30 ⇒ 60 ⇒ 90 ⇒ 120 ⇒ 240 ⇒



One minute before the preset Sleep Time, "Power off in a minute" message will appear.



Appendix



Glossary	85
Troubleshooting	87
Cleaning and Caring	89
Product Specifications	90



Glossary

- Component video** Component video is sent through three cables: two color shade (chrominance) signals and one brightness (luminance) signal. Component video achieves greater color accuracy than composite video or S-VIDEO by splitting chrominance into two separate portions.
- Composite video** Composite video is sent through a single cable. Composite video combines the color shade (chrominance) and brightness (luminance) information into one video signal.
- S-VIDEO** S VIDEO requires a single cable, which carries the brightness (luminance) and color (chrominance) signals of the picture separately. S-VIDEO provides better resolution than composite video, which carries the signals together.
- Full Scart** SCART connectors used with many European video equipments is designed to carry composite video and RGB video signals. If the equipment which outputs picture outputs RGB-signal, it will output RGB signal from the RGB pins and a complete composite video signal at the same time.
- Half Scart** Basically is the same as Full Scart in function but does not support RGB Video signals.
- 480i** Provides 480 lines of resolution. Displays images using interlaced scanning, which first transmits all the odd lines on the TV screen and then the even lines.
- 480p** Provides 480 lines of resolution. Displays images using progressive scanning, which transmits each line from top to bottom.
- 720p** Provides 720 lines of resolution. Displays images using progressive scanning, which transmits each line from top to bottom.
- 1080i** Provides 1080 lines of resolution. Displays images using interlaced scanning, which first transmits all the odd lines on the TV screen and then the even lines. 1080i is one of the formats used by HDTV (High Definition TV).
- Digital television (DTV)** A new technology for transmitting and receiving broadcast television signals. DTV provides higher resolution and improved sound quality over analog television.
- HDTV(High Definition TV)** HDTV is a new kind of digital TV, creating a high quality picture, high definition. The HDTV provides a theater-like screen with an aspect ratio of 16:9. Supports 480p or higher.
- SDTV(Standard Definition TV)** SDTV is a new kind of standard definition digital TV, having a range of lower resolution than the HDTV. Supports 480i.
- Satellite Broadcasting** Provides crisp picture and clear audio quality throughout the country via a satellite.
- Cable Broadcast Receiver (Converter)** A device that receives cable broadcasting. Connecting it to your TV set allows you to watch a various channels.

- VHF/UHF** VHF (Very High Frequency) is the part of the frequency spectrum from 30 to 300 megahertz. UHF (Ultra High Frequency) is the part of the frequency spectrum from 300 to 3,000 megahertz.
- DVD** DVD (digital versatile disc) is an optical disc that can store a huge volume of multimedia such as video, game, and audio application, etc.
- DVI** DVI (Digital Visual Interface) is a specification for digital signals. This interface using TMDS transmission reduces the loss of signal, allowing to enjoy a clear and crisp image. There are DVI-D connection, designed for digital signals, and DVI-I connection, designed for both analog and digital signals.
- Coaxial Cable** Coaxial cable is the kind of rounded copper cable, which is generally used for TV antenna.
- LNA (Low-Noise-Amplifier)** Satellite applied technology. It is capable of amplifying weak signals so that any area experiencing a signal interruption may enjoy a clearer picture quality.
- Aspect ratio** Refers to the ratio between the width and height of the screen. This TV has a 16:9 (widescreen) aspect ratio, as opposed to a 4:3 aspect ratio.
- PIP (Simultaneous Screen)** PIP allows you to view two images at the same time in a single screen.
- SWAP** PIP function provides a main picture (larger image) and sub-picture (smaller image). The SWAP is designed to swap the sub-picture for the main picture. For example, while you are watching a main picture on TV and watching a sub-picture on VCR, you can instantly switch the two pictures by using the SWAP function.
- Picture Mode** Picture Mode features the optimal picture quality. There are Standard-Dynamic-Movie-Mild-User features in order. "User Control" allows you to adjust Contrast, Brightness, Sharpness, Color and Tint.
- Sound Mode** Sound Mode features the optimal sound quality. There are Standard-Music-Movie-News-User features in order. "User Control" allows you to adjust high frequency sound, middle frequency sound and low frequency sound.
- Channel Tuning** The feature allows you to enjoy optimal broadcasting. This product provides automatic tuning feature for the best broadcasting status. You can tune the channels manually.
- SRS WOW** A well-recognized 3D sound technology developed by US SRS Labs, Inc. This technology delivers the ultimate audio experience only with two speakers as if through multi-channel speakers.
- Subwoofer Output** Designed to improve ultra low frequency with about 150Hz. Installation of a sub woofer with a built-in amplifier is necessary.



Troubleshooting

Installation Problems

Symptom	Possible solution
How can I install an antenna?	Refer to pages 23~24.
TV screen is not clear after installing an indoors antenna.	Indoors antenna may experience poor reception due to surrounding buildings. Please install an outdoors antenna or wireless antenna.
How can I view cable broadcasting?	Please install a cable broadcasting receiver (Converter).

Picture Problems

Symptom	Possible solution
Neither picture nor sound comes up.	Check whether power is on. Check whether the power is cut or whether power cord is properly connected. Try to plug another product's power cord to the outlet the PDP is plugged into.
Picture turns on slowly after power is on.	This symptom is not a malfunction. This delay is designed to prevent the distorted and noisy picture when power is on. However, if the picture does not appear more than 5 minutes after power is on, call a service center.
Vertical and horizontal lines and web patterns briefly appear on the picture and shake.	This symptom may be caused by interference from other electric appliances. Please avoid using a cordless phone, hairdryer, and electric drill, etc.
Input Source information only appears on black screen.	Check whether your TV is properly connected to external devices.
Poor reception on some channels.	Check whether you selected proper channels. Try re-orienting your antenna. Ensure LNA is activated.
Black and white on some channels.	Check other channels for black and white screen. Adjust colour.
TV won't turn on.	Ensure the power cord is plugged.
Screen is too bright or too dark.	Adjust brightness.

Auto On does not work.

Ensure to use the remote control or power button on the product to turn off your TV. If you unplug the power cord, the stand-by consumption power becomes 0 (zero), which causes the programmed time to be erased.

After setting the time, I turned TV off and turn it on. The programmed information has been erased.

Ensure to use the remote control or power button on the product to turn off your TV. If you unplug the power cord, the stand-by consumption power becomes 0 (zero), which causes the programmed time to be erased.

Sound Problems

Symptom	Possible solution
Too much noise occurs.	Check whether the audio setting is in the Stereo mode. In the Stereo mode, the sound may be distorted in the area where experiences poor reception or is located far away from a TV broadcasting station.
No sound while viewing a cable channel	Make sure an audio or audio/video component is securely inserted into the appropriate jacks. Check other channels for sound. Check the volume settings on the cable broadcasting receiver.
Picture is OK but sound does not come out.	Try to press volume up/volume down buttons of your remote control.
One of the speakers does not produce sound.	Select sound balance and make proper adjustment. (Page 48) Check the speaker connection cables.

General



Care and Cleaning

Cabinet Cleaning

Wipe a soft dry cloth.

Do not use inflammables like Benzene or Thinner, or wet clothes.
Do not scratch the panel of PDP with a fingernail or pointed object.

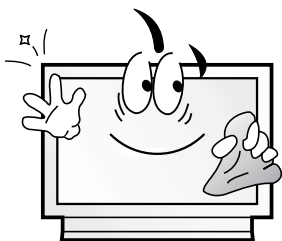

Screen Cleaning

Clean the screen with a soft cloth moistened in mild glass detergent and dry with a soft cloth.

Never use any solvent on the screen such as Acetone, Benzene, or Thinner, etc.

Cleaning Inside

When the inside needs to be cleaned, contact a service center or distribution agent where the item is purchased.

It is recommended cleaning is complete before the rainy season.

Product Specifications

Display (PDP TV)

MODEL	HQP421SR	HQP421HR	HQP501HR
Pixel	852(H) x 480(V)	1024(H) x 768(V)	1366(H) x 768(V)
Width	1030 mm		1208 mm
Height (Excluding stand)	631 mm		724 mm
Height (Including stand)	717 mm		809.5 mm
Depth	79 mm		79 mm
Weight (With Package)	32 kg		54 kg
Weight (Net Product)	26 kg		43 kg
Power	100 - 240V AC 50/60Hz		
Colors	16,770,000 colors(256 colors for each R, G, B)		
Use Temperature	0°-40°C		
Use Humidity	Below 80%		
TV	2-Tuner Built In		

Speaker (Optional)

MODEL	PD421S	P501S
Dimensions(WxDxH)	120 x 79 x 631 mm	120 x 79 x 724 mm
Weight	2 kg x 2	1.5 kg x 2
Type	2 way 6 speaker system	
Cabinet	Base Reflex Type	
Impedance	8 Ω	
Allowable Input	Rated 8W (RMS)	
	Max. 10W(Music Peak Power)	
Frequency Response	120Hz ~ 20,000Hz (-10dB)	
Output Sound Pressure	87dB/W/m	



Component Video Signal Format

If PDP cannot reproduce proper video image, it's necessary to select a specific component video signal format among the below.

- DVD : 480i / 480p / 720p / 1080i
- DTV (Digital Broadcast) : 480p / 720p / 1080i
- All signals are available for 60Hz.

PDP couldn't display proper video image in case of different output signal from the specification that PDP supports. (The below specification table) Then, please adjust the output signal setting from the appliances.

Or when you would like to purchase PDP & the appliances like SETTOP BOX or DVD, please check the compatibility between the input signal of PDP and the output signal of the appliances.

• Component Input Specification

Signal Name		Horizontal Frequency (KHz)	Vertical Frequency (KHz)	Remarks
480 60i	720 x 483	15.75	60	DVD input
		15.734	59.94	
480 60i	720 x 486	15.75	60	
		15.734	59.94	
480 60i	640 x 480	15.75	60	
		15.734	59.94	
480 60p	720 x 483	31.5	60	DVD input DTV Input
		31.469	59.94	
480 60p	720 x 486	31.5	60	
		31.469	59.94	
480 60p	640 x 480	31.5	60	
		31.469	59.94	
720 60p	1280 x 720	45	60	
		44.955	59.94	
1080 60i	1920 x 1080	33.75	60	
		33.716	59.94	

MEMO



MEMO

MEMO



MEMO

Free Manuals Download Website

<http://myh66.com>

<http://usermanuals.us>

<http://www.somanuals.com>

<http://www.4manuals.cc>

<http://www.manual-lib.com>

<http://www.404manual.com>

<http://www.luxmanual.com>

<http://aubethermostatmanual.com>

Golf course search by state

<http://golfingnear.com>

Email search by domain

<http://emailbydomain.com>

Auto manuals search

<http://auto.somanuals.com>

TV manuals search

<http://tv.somanuals.com>