

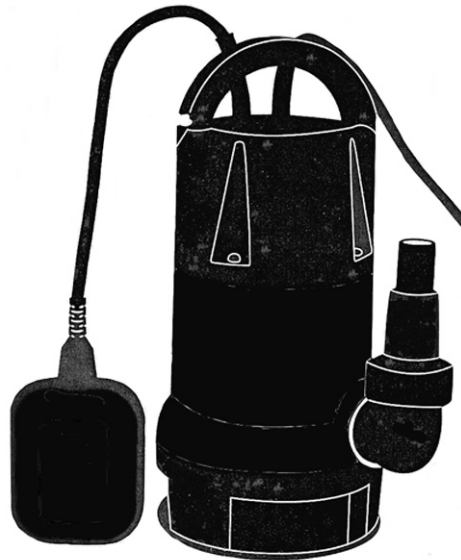

## SUBMERSIBLE DIRTY WATER PUMP

**Model 93819 - 1 HP**  
**Model 93820 - 1.2 HP**

### ASSEMBLY AND OPERATING INSTRUCTIONS



Due to continuing improvements, actual product may differ slightly from the product described herein.

Distributed exclusively by  
Harbor Freight Tools®.

3491 Mission Oaks Blvd., Camarillo, CA 93011  
Visit our Web site at: <http://www.harborfreight.com>

**TO PREVENT SERIOUS INJURY,  
READ AND UNDERSTAND ALL WARNINGS  
AND INSTRUCTIONS BEFORE USE.**

Copyright © 2006 by Harbor Freight Tools®. All rights reserved. No portion of this manual or any artwork contained herein may be reproduced in any shape or form without the express written consent of Harbor Freight Tools.

**For technical questions, please call 1-800-444-3353.**

Revised 08i

## PRODUCT SPECIFICATIONS

Model	93819	93820
Electrical Requirements	120 V~ / 60 Hz / 750 W / 6 A / 1 HP Motor	120 V~ / 60 Hz / 900 W / 7 A / 1.2 HP Motor
Power Cord Plug	3-Prong, Grounded	
Power Cord	18 Ft. Long / 18AWG x 3C	
Thermal Overload Protection	Yes	
Switch	Automatic ON/OFF Float	
Self-Priming	Yes	
Maximum Size Particle Uptake	0.196"	
Maximum Pressure	14.5 PSI/1.0 bar	16 PSI/1.1 bar
Maximum Capacity	3400 Gal. Per Hour/56 Gal. Per Min.	3700 Gal. Per Hour/61 Gal. Per Min.
Maximum Delivery Height	26 Feet	28 Feet
Maximum Submersion Depth	16 Feet	
Discharge Diameter	1-1/2"	
Minimum Uptake Depth	4"	
Maximum Operating Temperature	95° F	

## SAVE THIS MANUAL

You will need this manual for the safety warnings and precautions, assembly, operating, inspection, maintenance and cleaning procedures, parts list and assembly diagram. Keep your invoice with this manual. Write the invoice number on the inside of the front cover. Keep this manual and invoice in a safe and dry place for future reference.

## GENERAL SAFETY RULES



**READ AND UNDERSTAND ALL INSTRUCTIONS**  
**Failure to follow all instructions listed below may result in electric shock, fire, and/or serious injury.**

**SAVE THESE INSTRUCTIONS**

### WORK AREA

- Keep your work area clean and well lit.** Cluttered benches and dark areas invite accidents.

2. **Do not operate power tools in explosive atmospheres, such as in the presence of flammable liquids, gases, or dust.** Power tools create sparks which may ignite the dust or fumes.
3. **Keep bystanders, children, and visitors away while operating a power tool.** Distractions can cause you to lose control.

### ELECTRICAL SAFETY

4. **Grounded tools must be plugged into a GFCI (Ground Fault Circuit Interrupter) outlet, properly installed, and grounded in accordance with all codes and ordinances. Never remove the grounding prong or modify the plug in any way. Do not use any adapter plugs. Check with a qualified electrician if you are in doubt as to whether the outlet is properly grounded.** If the tools should electrically malfunction or break down, grounding provides a low resistance path to carry electricity away from the user.
5. **Double insulated tools are equipped with a polarized plug (one blade is wider than the other). This plug will fit in a polarized outlet only one way. If the plug does not fit fully in the outlet, reverse the plug. If it still does not fit, contact a qualified electrician to install a polarized outlet. Do not change the plug in any way.** Double insulation  eliminates the need for the three wire grounded power cord and grounded power supply system.
6. **Avoid body contact with grounded surfaces such as pipes, radiators, ranges, and refrigerators.** There is an increased risk of electric shock if your body is grounded.
7. **Do not abuse the Power Cord. Never use the Power Cord to carry the tool or pull the Plug from an outlet. Keep the Power Cord away from heat, oil, sharp edges, or moving parts. Replace damaged Power Cords immediately.** Damaged Power Cords increase the risk of electric shock.

### PERSONAL SAFETY

8. **Stay alert. Watch what you are doing, and use common sense when operating this product. Do not use the Fountain while tired or under the influence of drugs, alcohol, or medication.** A moment of inattention while operating this product may result in serious personal injury.

9. **Dress properly. Do not wear loose clothing or jewelry. Contain long hair. Keep your hair, clothing, and gloves away from moving parts.** Loose clothes, jewelry, or long hair can be caught in moving parts.
10. **Use safety equipment. Wear ANSI approved safety impact goggles when assembling this product.** Non-skid safety shoes must be used for appropriate conditions.

### TOOL USE AND CARE



11. **Disconnect the Power Cord Plug from the power source before making any adjustments, changing accessories, or storing the Pump.** Such preventive safety measures reduce the risk of starting the unit accidentally.
12. **Store idle equipment out of reach of children and other untrained persons.** Electrically powered products are dangerous in the hands of untrained users.
13. **Check for misalignment or binding of moving parts, breakage of parts, and any other condition that may affect this product's operation. If damaged, have the Fountain serviced before using.** Many accidents are caused by poorly maintained equipment.

### SERVICE



14. **Service must be performed only by qualified repair personnel.** Service or maintenance performed by unqualified personnel could result in a risk of injury.
15. **When servicing this product, use only identical replacement parts. Follow instructions in the "Inspection, Maintenance, And Cleaning" section of this manual.** Use of unauthorized parts or failure to follow maintenance instructions may create a risk of electric shock or injury.

### SPECIFIC SAFETY RULES

1. **Maintain labels and nameplates on the Pump.** These carry important information. If unreadable or missing, contact Harbor Freight Tools for a replacement.
2.  **Wear ANSI approved safety impact eye goggles when assembling the Pump.** Using personal safety devices reduce the risk for injury. Safety impact eye goggles are available from Harbor Freight Tools.

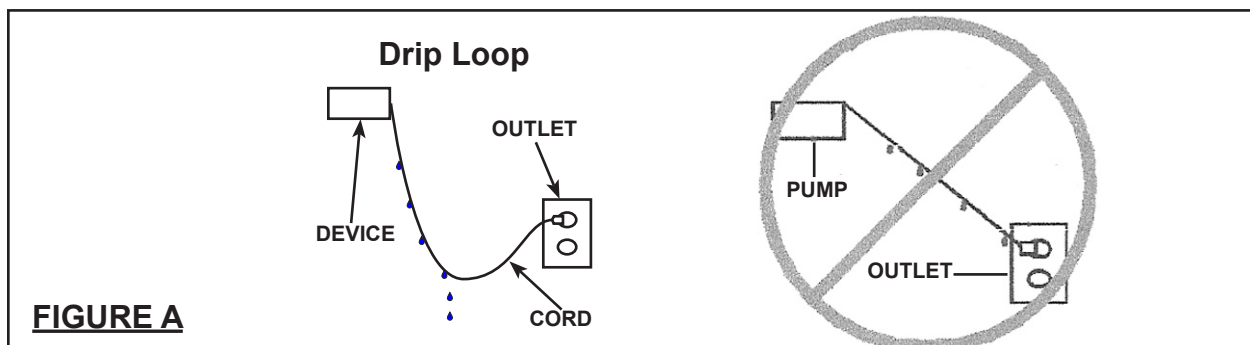
3. **Use the right product for the job.** There are certain applications for which this product was designed. Do not use small tools, attachments, or equipment to do the work of larger industrial tools, attachments, or equipment.
4. **Maintain a safe environment.** Keep the area well lit. Make sure there is adequate surrounding space. Always keep the area free of obstructions, grease, oil, trash, and other debris. Do not use an electrically powered product in areas near flammable chemicals, dusts, and vapors.
5.  **WARNING! Risk of electrical shock.** Always disconnect the Pump from its power source before handling or making any adjustments to the tool. Always wear non-skid rubber boots when water is on the floor and you must unplug the Pump. Never allow the internal Motor to get wet. Make sure the electrical power source is a separately fused, grounded, 3-wire type **GFCI** (Ground Fault Circuit Interrupter) outlet. **Do not remove the ground prong on the Power Cord Plug. Do not use an extension cord.**
6. **Do not pump hazardous materials.** Do not pump explosive or flammable materials such as fuel, oil, kerosene, gasoline, etc. Do not pump in close proximity to flammable or explosive materials. Do not pump fats, oils, salt or waste water. **This Pump is designed to move clean or dirty water only.** Do not pump water over **95** degrees Fahrenheit.
7. **Make sure the discharge pipe** (not included) **is secured to a solid surface to ensure the stability of the Pump.**
8. **Make sure to position the Pump on a flat, level, solid surface.**
9.  **WARNING! Always arrange a “drip loop” in the Power Cord connecting the Pump to a 120 volt, GFCI electrical outlet.** A drip loop is that part of the Power Cord below the level of the outlet to prevent water from traveling along the Power Cord and coming in contact with the outlet. If the Power Plug or electrical outlet *does* get wet, do not unplug the Power Cord. Disconnect the fuse or circuit breaker that supplies power to the Pump. Then, unplug the Power Cord and examine for presence of water in the outlet. **(See Figure A.)**



10. ***If necessary***, have a certified electrician install (within 14 feet of where the Pump will be located) a 120 volt, GFCI electrical outlet that is dedicated only to the Pump. Any outlet should be above the water line.
11. **NEVER** raise or lower the Pump by its electrical Power Cord.
12. In cold weather, when the Pump is not in use, protect the interior of the Pump from freezing by draining the water and pumping a permanent type automobile anti-freeze containing a rust inhibitor through the system. A 50% mixture with water is recommended. Be sure to flush the system with a neutralizing liquid prior to re-use of the Pump.
13. **Prior to use, and periodically thereafter, check to make sure all connections are tight and secure.**
14. **Industrial applications must follow OSHA requirements.**
15. **Performance of this product may vary depending on variations in local line voltage.**
16.  **WARNING!** People with pacemakers should consult their physician(s) before using this product. Operation of electrical equipment in close proximity to a heart pacemaker could cause interference or failure of the pacemaker.
17.  **WARNING!** The warnings and cautions discussed in this manual cannot cover all possible conditions and situations that may occur. It must be understood by the operator that common sense and caution are factors which cannot be built into this product, but must be supplied by the operator.

## SAVE THESE INSTRUCTIONS

### GROUNDING

#### **WARNING!**

**Improperly connecting the grounding wire can result in the risk of electric shock. Check with a qualified electrician if you are in doubt as to whether the outlet is properly grounded. Do not modify the power cord plug provided with the tool. Never remove the grounding prong from the plug. Do not use the tool if the power cord or plug is damaged. If damaged, have it repaired by a service facility before use. If the plug will not fit the outlet, have a proper outlet installed by a qualified electrician.**

## GROUNDING TOOLS: TOOLS WITH THREE PRONG PLUGS

1. Tools marked with "Grounding Required" have a three wire cord and three prong grounding plug. The plug must be connected to a properly grounded outlet. If the tool should electrically malfunction or break down, grounding provides a low resistance path to carry electricity away from the user, reducing the risk of electric shock. **(See Figure B.)**
2. The grounding prong in the plug is connected through the green wire inside the cord to the grounding system in the tool. The green wire in the cord must be the only wire connected to the tool's grounding system and must never be attached to an electrically "live" terminal. **(See Figure B.)**
3. Your tool must be plugged into an appropriate outlet, properly installed and grounded in accordance with all codes and ordinances. The plug and outlet should look like those in the following illustration. **(See Figure B.)**

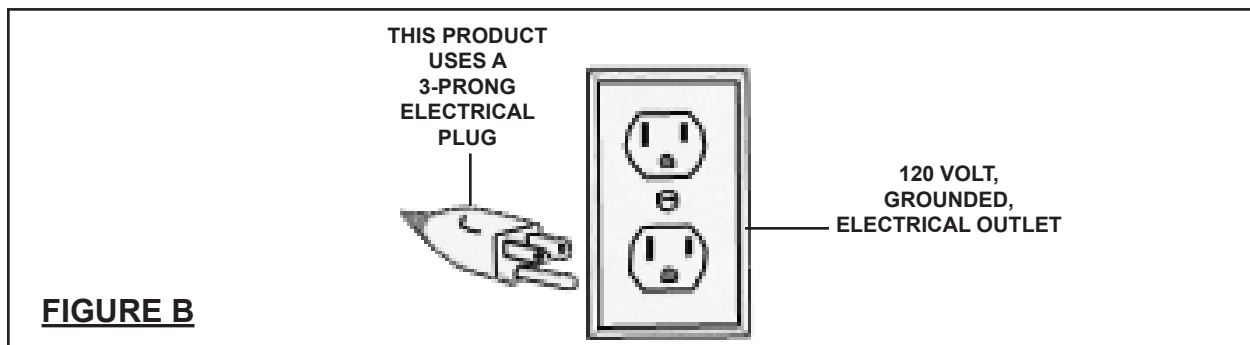



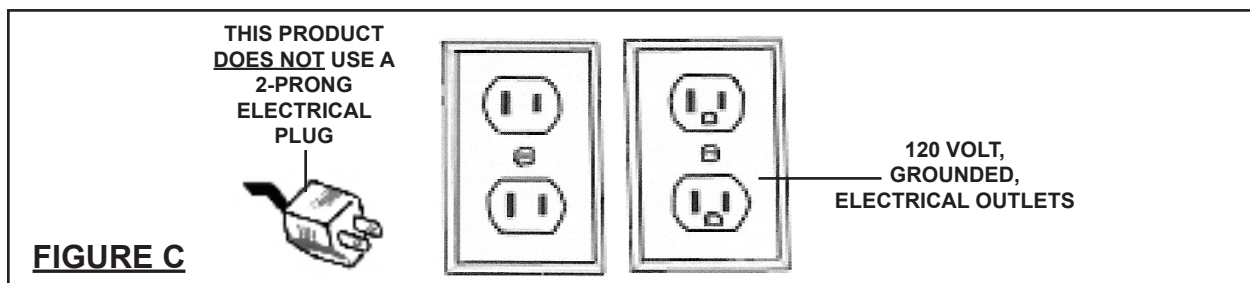

## DOUBLE INSULATED TOOLS: TOOLS WITH TWO PRONG PLUGS

4. Tools marked "Double Insulated" do not require grounding. They have a special double insulation system which satisfies OSHA requirements and complies with the applicable standards of Underwriters Laboratories, Inc., the Canadian Standard Association, and the National Electrical Code. **(See Figure C.)**
5. Double insulated tools may be used in either of the 120 volt outlets shown in the following illustration. **(See Figure C.)**

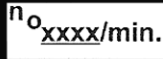

## SYMBOLOLOGY

	Double Insulated
	Canadian Standards Association
	Underwriters Laboratories, Inc.
	Volts Alternating Current
	Amperes
	No Load Revolutions per Minute (RPM)

**FIGURE D**

## UNPACKING

When unpacking, check to make sure all the parts shown on the **Parts List on page 12** are included. If any parts are missing or broken, please call Harbor Freight Tools at the number shown on the cover of this manual as soon as possible.

## ASSEMBLY AND OPERATING INSTRUCTIONS

### NOTE:

For additional information regarding the parts listed in the following pages, refer to the **Assembly Diagram on page 13**.

1.  **WARNING!** Always make sure to turn off the electricity powering the Pump's electrical outlet and that the Pump is unplugged from its outlet prior to assembling the unit, unclogging the unit, or making any adjustments to the unit.
2. *If necessary*, have a certified electrician install (within 14 feet of where the Pump will be located) a 120 volt, GFCI electrical outlet that is dedicated only to the Pump. **Any outlet should be well above the water line.**
3. The size of the discharge outlet on the Union (37) is 1-1/2" diameter. Only a 1-1/2" diameter Discharge Pipe (not included) must be used. Do not attempt to reduce the discharge size below 1-1/2" as this will affect Pump flow and performance. **(See Figure E, next page.)**



4. Connect the Union (37) to the Coupler (34). Make sure to hand tighten only. Over-tightening may cause the Union to crack. Then, connect a 1-1/2" diameter Discharge Pipe to the Union. **NOTE:** Make sure the Discharge Pipe is secured to a solid surface, with appropriate hardware (not included), to ensure the stability of the Pump. (See Figure E.)
5. Install an additional union (not included) or other means of separating the Discharge Pipe just above the floor to facilitate removal of the Pump if necessary. (See Figure E.)
6. A check valve (not included) is recommended just above, or in place of, the Union to prevent the backflow of water after each pump cycle. If a Check Valve is used, a 1/8" diameter air bleed hole should be drilled through the Discharge Pipe just above the lower Union (37) to prevent Pump "airlock". A small spray of water out of this hole is normal while the Pump is running. (See Figure E.)

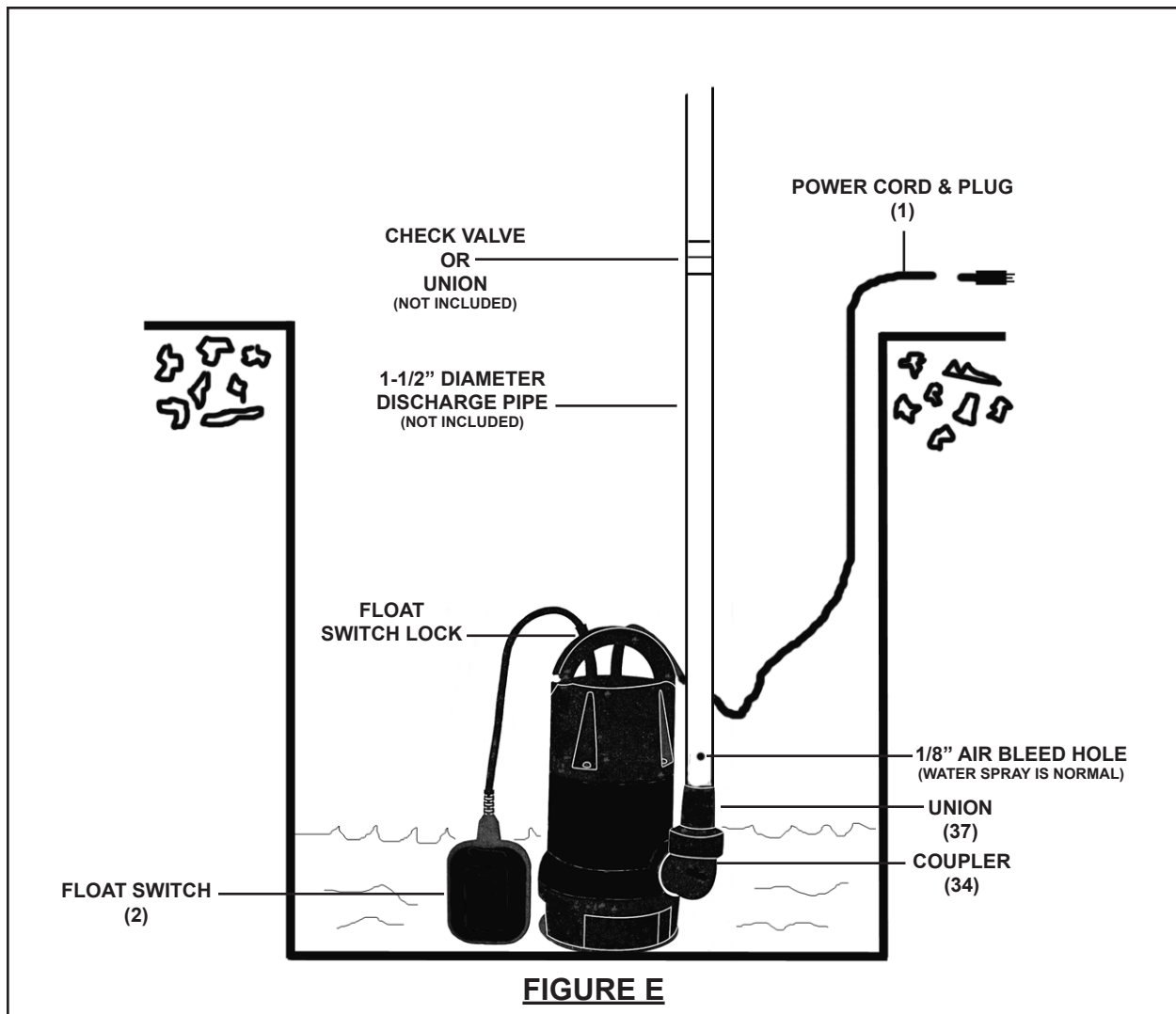

7. Carefully set the Pump in place. **Do not lower or raise the Pump by its Power Cord (1) or Discharge Pipe. (See Figure E.)**
8. The Float Switch (2) automatically switches on and off at a water depth of approximately 4 inches. The ON/OFF height can be manually adjusted by adjusting the Float Switch Lock. **CAUTION:** Do not run the Pump dry. Doing so will increase wear to the unit and possibly cause seal damage. **(See Figure E.)**
9. **NOTE:** This Pump has a built-in thermal protector for the Motor which automatically shuts it off to avoid overheating. After the Motor cools, it will cycle back on. Wait for the cycle to continue. Do not try to turn on the Pump manually after it has automatically shut off.
10. Connect additional Discharge Pipe as needed to direct the water discharge to the desired location. The discharge should be kept as short as possible with a minimum number of turns. **IMPORTANT:** Do not exceed the maximum lift of the Pump:  
**1 HP Model 93819 = 26 Feet.**  
**1.2 HP Model 93820 = 28 Feet.**
11. Connect the Power Cord & Plug (1) to its 120 volt, GFCI electrical outlet, while making sure to form a “drip loop” in the Power Cord. **(See Figure A.)**
12. When the water level exceeds approximately 4 inches the Pump will automatically turn on and run continuously until the water level falls below 4 inches at which time the Pump will automatically turn off.
13.  **WARNING!** When shutting off power to the Pump, always shut off the electrical power to the GFCI outlet first. Then, disconnect the Pump’s Power Cord & Plug (1) from the GFCI outlet.

## INSPECTION, MAINTENANCE, AND CLEANING

1.  **WARNING!** Always shut off the electrical power to the GFCI outlet first. Then, disconnect the Pump’s Power Cord & Plug (1) from the GFCI outlet prior to performing any inspection, maintenance, or cleaning procedures.
2. **Before each use,** inspect the general condition of the Pump. Check for cracked or broken parts, damaged electrical wiring, clogged Impeller Cover, Impeller, Discharge Pipes, and any other condition that may affect safe operation. If abnormal noise or vibration occurs, have the problem corrected before further use. **Do not use damaged equipment.**
3. **To clean the Impeller Cover and Impeller:** A clogged or dirty Impeller Cover

or Impeller (25) will greatly reduce performance of the Pump. To clean the Impeller Cover (32), spray the Cover with clean water. To clean the Impeller, remove the *three* Tapping Screws (39) at the bottom of the Base (38). Then, remove the Base to expose the Impeller Cover and Impeller. Use a stream of clean water to clean the Impeller and Impeller area inside the Pump. Then, replace the Base. (See Figure F and Assy. Diagram.)

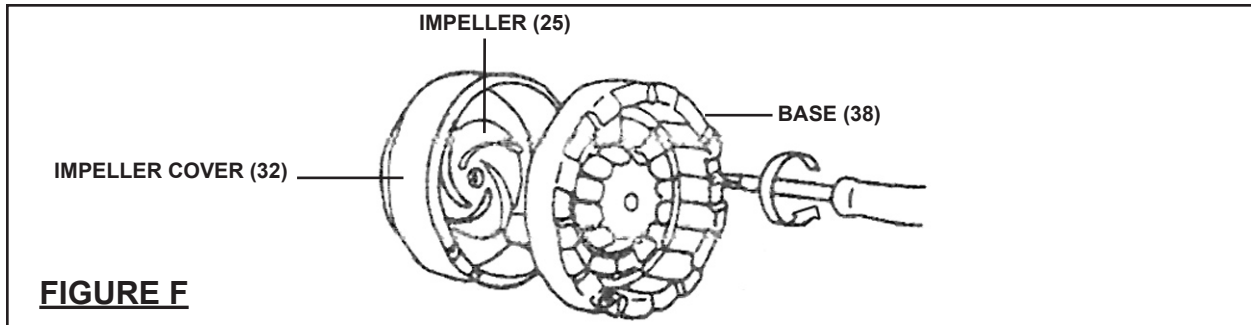

**FIGURE F**

4. When storing, make sure to store the Pump in a clean, dry, safe location out of reach of children. In cold weather, when the Pump is not in use, protect the interior of the Pump from freezing by draining the water and pumping a permanent type automobile anti-freeze containing a rust inhibitor through the system. A 50% mixture with water is recommended. Be sure to flush the system with a neutralizing liquid prior to re-use of the Pump.
5. **⚠ CAUTION! All maintenance, service, or repairs not mentioned in this manual must only be performed by a qualified service technician.**

## TROUBLESHOOTING

Problem	Possible Solution
Pump does not start.	<ol style="list-style-type: none"> <li>1. Make sure the Pump is plugged into a working 120 volt, GFCI, electrical outlet. (See page 5.)</li> <li>2. Adjust the Float Switch to a lower position. (See page 10.)</li> </ol>
No flow from Pump.	<ol style="list-style-type: none"> <li>1. Clean Impeller and Impeller Cover.</li> <li>2. Check Discharge Pipe for freezing or blockage. If necessary, thaw Pipe and/or remove excessive debris.</li> <li>3. Discharge Pipe excessively bent. Reset Pipe.</li> </ol>
Pump does not switch off.	Float Switch cannot sink down. Lower Float Switch. (See page 10.)
Insufficient flow.	<ol style="list-style-type: none"> <li>1. Clean Impeller and Impeller Cover. (See page 11.)</li> <li>2. Check Discharge Pipe for freezing or blockage. If necessary, thaw Pipe and/or remove excessive debris.</li> <li>3. Have a qualified service technician clean interior of Pump and, if necessary, replace worn parts.</li> </ol>
Pump switches off too soon.	<ol style="list-style-type: none"> <li>1. Clean Impeller and Impeller Cover. (See page 11.)</li> <li>2. Make sure the water temperature does not exceed 95° Fahrenheit.</li> </ol>

**PLEASE READ THE FOLLOWING CAREFULLY**

THE MANUFACTURER AND/OR DISTRIBUTOR HAS PROVIDED THE PARTS LIST AND ASSEMBLY DIAGRAM IN THIS MANUAL AS A REFERENCE TOOL ONLY. NEITHER THE MANUFACTURER OR DISTRIBUTOR MAKES ANY REPRESENTATION OR WARRANTY OF ANY KIND TO THE BUYER THAT HE OR SHE IS QUALIFIED TO REPLACE ANY PARTS OF THE PRODUCT. IN FACT, THE MANUFACTURER AND/OR DISTRIBUTOR EXPRESSLY STATES THAT ALL REPAIRS AND PARTS REPLACEMENTS SHOULD BE UNDERTAKEN BY CERTIFIED AND LICENSED TECHNICIANS, AND NOT BY THE BUYER. THE BUYER ASSUMES ALL RISKS AND LIABILITY ARISING OUT OF HIS OR HER REPAIRS TO THE ORIGINAL PRODUCT OR REPLACEMENT PARTS THERETO, OR ARISING OUT OF HIS OR HER INSTALLATION OF REPLACEMENT PARTS THERETO.

**PARTS LIST**

Part #	Description	Qty.	Part #	Description	Qty.
1	Power Cord & Plug	1	22	Cable Sleeve	1
2	Float Switch	1	23	O-Ring	1
3	Screw	4	24	Washer	1
4	Pump Rear Cover	1	25	Impeller	1
5	Cable Sleeve	1	26	Lock Nut	1
6	Cable Clamp	2	27	Housing	1
7	Capacitor	1	28	Steel Ball	1
9	Cable Clamp Block	1	29	Washer	1
10	Tapping Screw	3	30	Tapping Screw	1
11	Motor Rear Cover	1	31	O-Ring	1
12	Washer	1	32	Impeller Cover	1
13	Bearing	2	33	Tapping Screw	3
14	Rotor	1	34	Coupler	1
16	Stator	1	35	O-Ring	2
17	Seal Ring	3	36	Adaptor	1
19	O-Ring	1	38	Base	1
20	Motor Front Cover	1	39	Tapping Screw	3
21	Washer	4			

**NOTE:**

Some parts are listed and shown for illustration purposes only, and are not available individually as replacement parts.

# ASSEMBLY DIAGRAM

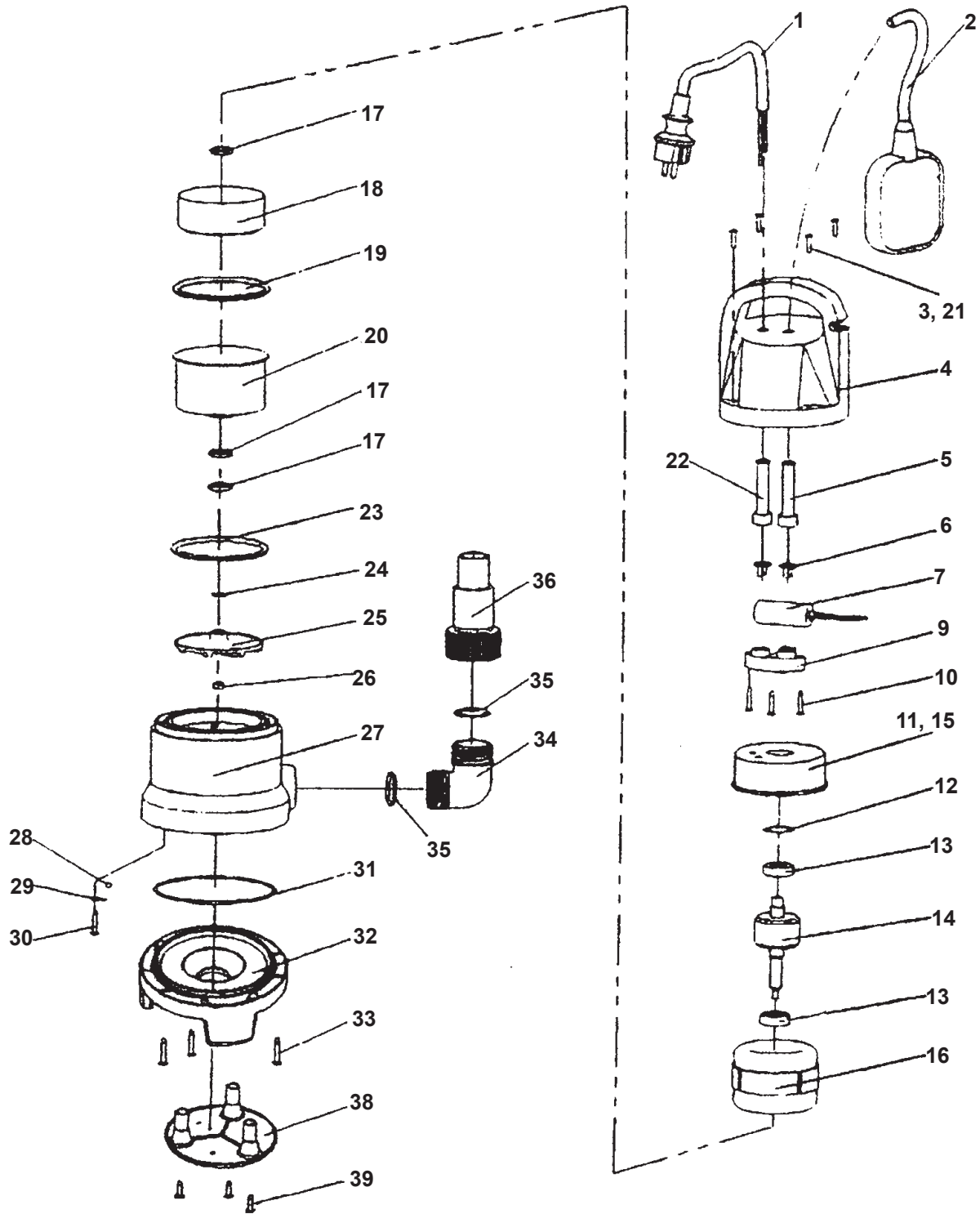

**NOTE:**

Some parts are listed and shown for illustration purposes only, and are not available individually as replacement parts.

Rev 08i

SKU 93819  
93820

**For technical questions, please call 1-800-444-3353**

**PAGE 13**

---

## LIMITED 1 YEAR / 90 DAY WARRANTY

---

Harbor Freight Tools Co. makes every effort to assure that its products meet high quality and durability standards, and warrants to the original purchaser that for a period of ninety days from date of purchase that the engine/motor, the belts (if so equipped), and the blades (if so equipped) are free of defects in materials and workmanship. Harbor Freight Tools also warrants to the original purchaser, for a period of one year from date of purchase, that all other parts and components of the product are free from defects in materials and workmanship (90 days if used by a professional contractor or if used as rental equipment). This warranty does not apply to damage due directly or indirectly, to misuse, abuse, negligence or accidents, repairs or alterations outside our facilities, normal wear and tear, or to lack of maintenance. We shall in no event be liable for death, injuries to persons or property, or for incidental, contingent, special or consequential damages arising from the use of our product. Some states do not allow the exclusion or limitation of incidental or consequential damages, so the above limitation of exclusion may not apply to you. THIS WARRANTY IS EXPRESSLY IN LIEU OF ALL OTHER WARRANTIES, EXPRESS OR IMPLIED, INCLUDING THE WARRANTIES OF MERCHANTABILITY AND FITNESS.

To take advantage of this warranty, the product or part must be returned to us with transportation charges prepaid. Proof of purchase date and an explanation of the complaint must accompany the merchandise. If our inspection verifies the defect, we will either repair or replace the product at our election or we may elect to refund the purchase price if we cannot readily and quickly provide you with a replacement. We will return repaired products at our expense, but if we determine there is no defect, or that the defect resulted from causes not within the scope of our warranty, then you must bear the cost of returning the product.

This warranty gives you specific legal rights and you may also have other rights which vary from state to state.

**3491 Mission Oaks Blvd. • PO Box 6009 • Camarillo, CA 93011 • (800) 444-3353**

## Free Manuals Download Website

<http://myh66.com>

<http://usermanuals.us>

<http://www.somanuals.com>

<http://www.4manuals.cc>

<http://www.manual-lib.com>

<http://www.404manual.com>

<http://www.luxmanual.com>

<http://aubethermostatmanual.com>

Golf course search by state

<http://golfingnear.com>

Email search by domain

<http://emailbydomain.com>

Auto manuals search

<http://auto.somanuals.com>

TV manuals search

<http://tv.somanuals.com>