

# TWO BURNER PROPANE STOVE

## Model 91614

### ASSEMBLY & OPERATING INSTRUCTIONS

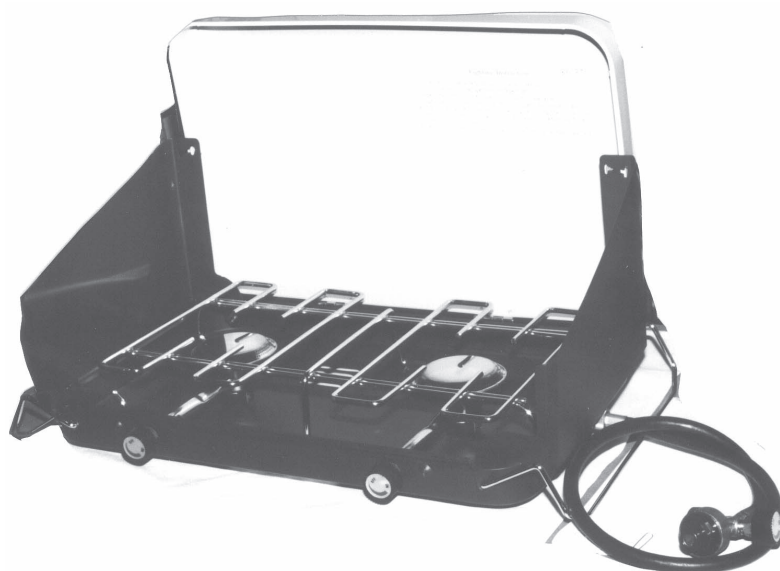

#### FOR YOUR SAFETY

If you smell gas:

1. Check that the bottle is tightly screwed to the regulator.
2. Shut off gas to the appliance.
3. Extinguish any open flame.
4. If odor continues, properly dispose of the propane bottle and use another.

**WARNING:** For Outdoor Use Only.

#### FOR YOUR SAFETY

Do not store or use gasoline or other flammable vapors and liquids in the vicinity of this or any other appliance.

**WARNING:** Improper installation, adjustment, alteration, service, or maintenance can cause injury or property damage. Read the installation, operating, and maintenance instructions thoroughly before installing or servicing this equipment.



3491 Mission Oaks Blvd., Camarillo, CA 93011  
Visit our Web site at <http://www.harborfreight.com>

Copyright© 2004 by Harbor Freight Tools®. All rights reserved. No portion of this manual or any artwork contained herein may be reproduced in any shape or form without the express written consent of Harbor Freight Tools.

**For technical questions and replacement parts, please call 1-800-444-3353**

THANK YOU for choosing a **HARBOR FREIGHT TOOLS** product. For future reference, please complete the owner's record below:

**Model** \_\_\_\_\_ **Serial No.** \_\_\_\_\_ **Purchase Date** \_\_\_\_\_

SAVE THE RECEIPT, WARRANTY AND THESE INSTRUCTIONS. It is important that you read the entire manual to become familiar with the unit BEFORE you begin assembly.

#### **Technical Specifications**

Construction: 20 Gauge Sheet Steel, Welded 1/4" diameter Grid w/  
nickel plated burners, brass pressure valve and feed  
tube, and valve adapter assembly.  
BTU per Burner: 8,000  
Also Included: (1) propane hose and valve adapter assembly  
Brass Socket Injector: Fits 16.4 oz. tank



**READ ALL INSTRUCTIONS BEFORE USING THIS PRODUCT!**

#### **Safety Warnings and Precautions**

**WARNING:** When using product, basic safety precautions should always be followed to reduce the risk of personal injury and damage to equipment.

1. **Keep children away.** Do not let children handle, move, or adjust the Propane Stove.
2. **Store idle equipment.** When not in use, the Stove must be stored disconnected from the cylinder in a dry, cool location to inhibit rust. Always lock up the Propane Stove and Propane canister and keep out of reach of children.
3. **Check for damaged parts.** Before using any product, any part that appears damaged should be carefully checked to determine that it will operate properly and perform its intended function. Check for any broken parts or mounting fixtures; and any other condition that may affect proper operation. Any part that is damaged should be properly repaired or replaced by a qualified technician. Do not use the product if any knob does not turn On and Off properly.
4. **Replacement parts and accessories.** When servicing, use only identical replacement parts. Use of any other parts will void the warranty. Only use accessories intended for use with this product. Approved accessories are available from Harbor Freight Tools.
5. **Do not operate if under the influence of alcohol or drugs.** Read warning labels if taking prescription medicine to determine if your judgment or reflexes are impaired while taking drugs. If there is any doubt, do not operate the product.
6. **Maintenance.** For your safety, service and maintenance should be performed regularly by a qualified technician.

#### **Propane Stove Specific Safety Warnings**



1. **If the information provided in this manual is not followed exactly, a fire or explosion may result, causing property damage, PERSONAL INJURY, or DEATH.**
2. **Improper assembly, installation, adjustment, alteration, service, use, or maintenance can cause property damage, PERSONAL INJURY, or DEATH. Installation and repair should be done by a qualified service person. The Propane Stove should be inspected before use and at least annually by a qualified service person.**

Frequent cleaning may be necessary. It is imperative that the Fuel Inlet, the burners, and valves of the Stove be kept clean.

### **Carbon Monoxide Inhalation Hazard**

3.  **The Propane Stove must never be used indoors, in a house, or any other sealed structure. Carbon monoxide is produced during operation and is DEADLY in a closed environment.** Early signs of carbon Monoxide poisoning resemble the flu, with headaches, dizziness, or nausea. If you have these signs, the heater may not be working properly or is improperly vented, get fresh air immediately.

### **Risk of Fire and/or Explosion**

4. **Do not store extra propane tanks in the vicinity of the Propane Stove or any other appliance.**
5.  **If gas is smelled during operation, immediately turn the Burner Control Knob (8) to OFF, and close the valve on the propane tank.** Propane gas is odorless. An odor-making agent is added to propane/LP gas to enable you to smell the gas if it may be leaking.
6.  **If the Propane Stove shuts off during operation, turn the Control Knob to OFF, check the amount of fuel in the tank and wait 5 minutes for the gas to clear before restarting.** If it continues to shut off during operation, have it serviced by a qualified technician.
7. **Never place the Propane Stove within 10 feet of flammable objects such as wood, trees, overhangs, and umbrellas.**

### **Risk of Burns-Propane Stove Gets Very Hot During Use.**

8.  **Do not attempt to move the Propane Stove while it is in operation.** Turn it off and wait one-half hour until it cools down before moving.
9. **Do not touch the Burner and Fuel Jet Assembly while the Propane Stove is lit.** Before servicing, wait one-half hour for the Propane Stove to cool down.
10. **Children and adults should be alerted to the hazards of high surface temperatures and should stay away to avoid burns or clothing ignition.**
11. **Young children should be carefully supervised when they are in the area of the Stove.**
12. **Clothing or other flammable materials should not be hung from the Stove, or placed on or near the Stove.**
13. **Turn OFF the stove immediately and have a qualified technician check the stove if any of the following exists:**
- a) The smell of propane gas in conjunction with extreme yellow tipping of the burner flames.
  - b) The stove does not reach temperature.
  - c) The burner makes a popping noise during use. (A slight popping noise is normal when the burner is extinguished).
14. **If the burner is not operating normally, shut off the propane gas before checking to see if anything is obstructing the gas flow.** The lit burner should operate with a blue flame, with a small yellow tip.
15. **WARNING:** This product contains or, when used, produces a chemical known to the State of California to cause cancer and birth defects or other reproductive harm. (California Health & Safety Code 25249.5, *et seq.*)
16. **This Stove must be used with an appropriate LP gas regulator (included).**

**Warning:** The warnings, cautions, and instructions discussed in this instruction manual cannot cover all possible conditions and situations that may occur. It must be understood by the operator that common sense and caution are factors which cannot be built into this product, but must be supplied by the operator.

### Assembly and Operation

Your Two Burner Propane Stove will require some simple assembly as described in the following steps. To assist you with assembly and operation please refer to the Operational Figures as well as the Assembly Diagram and Parts List located on the last pages of this manual.

1. Pull the Latches (6) up from the top and around to the bottom of the Stove-see Figure 1.
2. Make certain that the stove is on a flat, level surface capable of supporting the weight of the Stove and the items to be heated. Raise the Cover (1), then raise the Side Shields (2) on both sides of the Stove. Insert the tabs on the Cover (1) through the hole in the side of the Side Shields (2). Raise each Side Shield (2) completely into place so that the tab locks into place at the end of the groove.

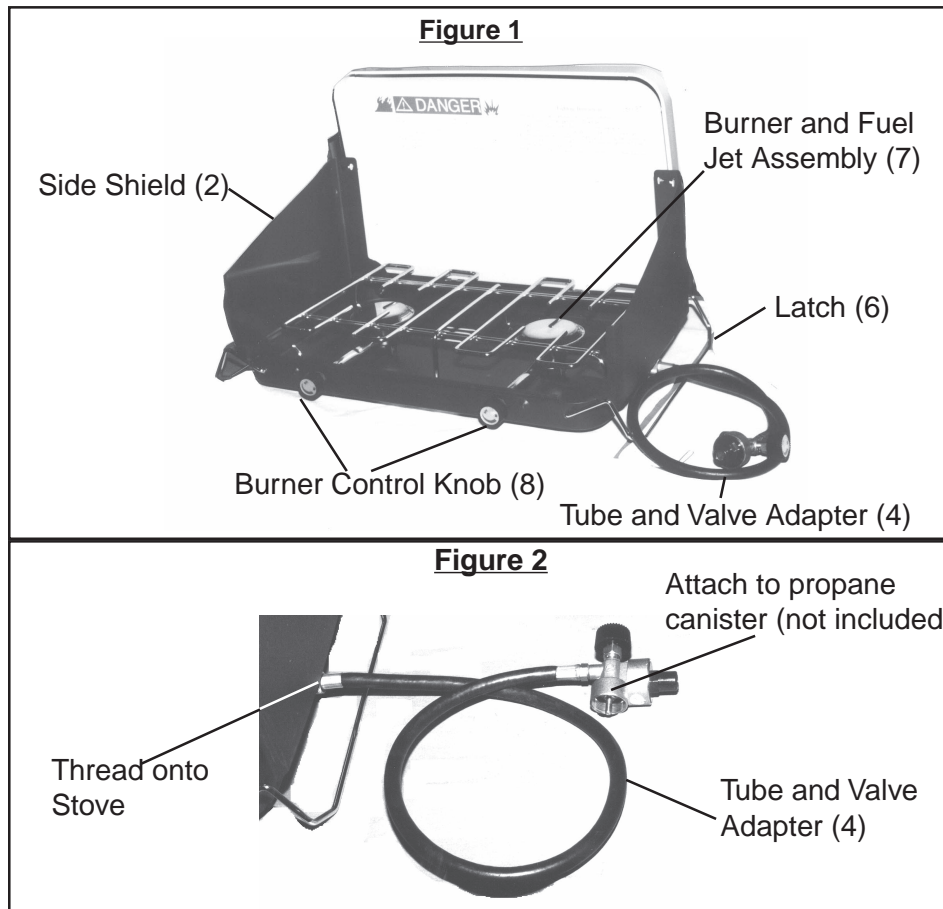

3. Thread the Tube and Valve Adapter Assembly (4) onto the Stove-see Figure 2. Tighten securely by hand or using a wrench.
4. Make certain that both the Burner Control Knobs (8) are in the OFF position before attaching the propane canister (not included).
5. Attach the other end of the Tube and Valve Adapter (4) to the propane canister (not included).

6. To light the Burner and Fuel Jet Assembly (7), place a lit match next to the Burner and Fuel Jet Assembly (7). Slightly turn the Burner Control Knob (8).
7. Slightly turn the Burner Control Knob (8) counterclockwise for the Burner and Fuel Jet Assembly that (7) you wish to light. Remove the match from the Burner and Fuel Jet Assembly (7) once the flame is ignited.

### **Increasing and Decreasing Heat/Flame to Burner Assembly**

1. Turning the Burner Control Knob (8) counterclockwise will increase the flow of gas to the Burner Assembly and Fuel Jet (7). This will increase the size of the flame.
2. Turning the Burner Control Knob (8) clockwise will decrease the flow of gas to the Burner Assembly and Fuel Jet (7). This will decrease the size of the flame.
3. To completely turn off the propane gas flow, turn the Burner Control Knob (8) completely clockwise.
4. If the Fuel Jet (8) gets blocked, it will need to be serviced by a qualified technician before further use. Only a qualified service technician should perform the following steps: (a) Remove the Tube and Valve Adapter (4). (b) Disconnect the Burner and Fuel Jet Assembly (7) from the Stove. (c) Clean it with a mild detergent. (d) Reconnect the Burner and Fuel Jet Assembly (7). (e) Replace the Tube and Valve Adapter (4).

### **Storing the Two Burner Propane Stove for Travel**

Before folding up your Propane Stove for travel, make certain that it has completely cooled off after use.

- a) Make certain that all knobs are in the OFF position and all nearby flames and sources of ignition are extinguished. Remove the Tube and Valve Adapter (4) from the propane gas canister.
- b) Unscrew the Tube and Valve Adapter (4) from the Stove.
- c) Slide the tabs on the Cover (1) out from each Side Shield (2).
- d) Fold down each Side Shield (2), and fold down the Cover (1).
- e) Flip the Latches (6) around to the top so that they hold the Cover closed.

### **Unpacking**

When unpacking your Two Burner Propane Stove, check to make sure the following parts are included. If any parts are missing or broken, please call **HARBOR FREIGHT TOOLS** at **1-800-444-3353**.

Part #	Description	Quantity	Part #	Description	Quantity
1	Cover	1	5	Fuel Inlet and Air Control	2
2	Side Shield	2	6	Latch	2
3	Grid	1	7	Burner and Fuel Jet Assembly	2
4	Tube and Valve Adapter	1	8	Burner Control Knob	2

Note: Some parts are listed and shown for illustration purposes only and are not available individually as replacement parts.

## Assembly Diagram

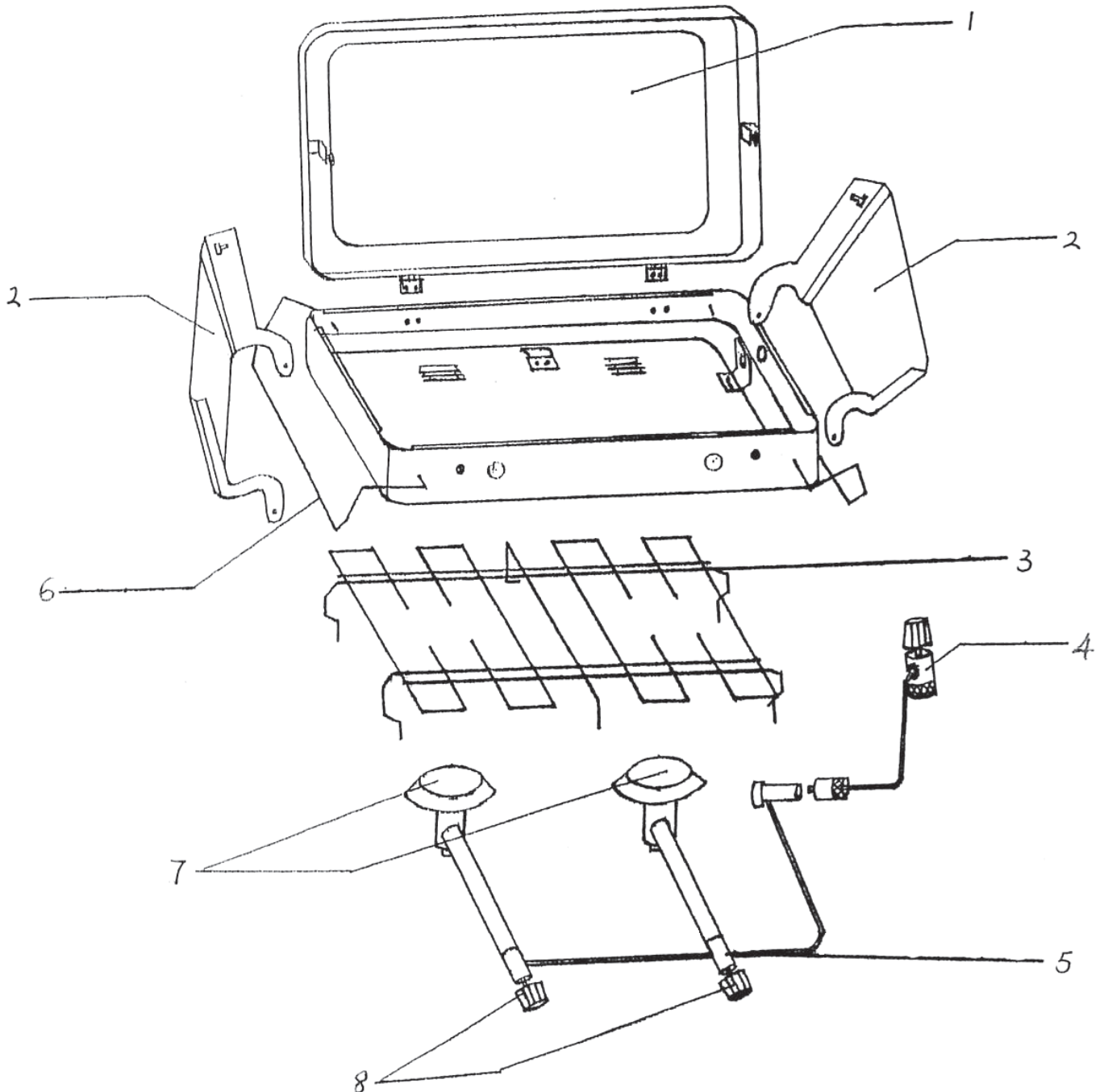

### PLEASE READ THE FOLLOWING CAREFULLY

THE MANUFACTURER AND/OR DISTRIBUTOR HAS PROVIDED THE PARTS DIAGRAM IN THIS MANUAL AS A REFERENCE TOOL ONLY. NEITHER THE MANUFACTURER NOR DISTRIBUTOR MAKES ANY REPRESENTATION OR WARRANTY OF ANY KIND TO THE BUYER THAT HE OR SHE IS QUALIFIED TO MAKE ANY REPAIRS TO THE PRODUCT OR THAT HE OR SHE IS QUALIFIED TO REPLACE ANY PARTS OF THE PRODUCT. IN FACT, THE MANUFACTURER AND/OR DISTRIBUTOR EXPRESSLY STATES THAT ALL REPAIRS AND PARTS REPLACEMENTS SHOULD BE UNDERTAKEN BY CERTIFIED AND LICENSED TECHNICIANS AND NOT BY THE BUYER. THE BUYER ASSUMES ALL RISK AND LIABILITY ARISING OUT OF HIS OR HER REPAIRS TO THE ORIGINAL PRODUCT OR REPLACEMENT PARTS THERETO, OR ARISING OUT OF HIS OR HER INSTALLATION OF REPLACEMENT PARTS THERETO.

## Free Manuals Download Website

<http://myh66.com>

<http://usermanuals.us>

<http://www.somanuals.com>

<http://www.4manuals.cc>

<http://www.manual-lib.com>

<http://www.404manual.com>

<http://www.luxmanual.com>

<http://aubethermostatmanual.com>

Golf course search by state

<http://golfingnear.com>

Email search by domain

<http://emailbydomain.com>

Auto manuals search

<http://auto.somanuals.com>

TV manuals search

<http://tv.somanuals.com>