

CENTRAL PNEUMATIC®

CONTRACTOR SERIES

AIR STAPLER 1/4" CROWN, 18 GAUGE

Models 40072 / 40073
/ 97521

SET UP AND OPERATING INSTRUCTIONS



Visit our website at: <http://www.harborfreight.com>



**Read this material before using this product.
Failure to do so can result in serious injury.
SAVE THIS MANUAL.**

Copyright© 2007 by Harbor Freight Tools®. All rights reserved. No portion of this manual or any artwork contained herein may be reproduced in any shape or form without the express written consent of Harbor Freight Tools. Diagrams within this manual may not be drawn proportionally. Due to continuing improvements, actual product may differ slightly from the product described herein. Tools required for assembly and service may not be included.

For technical questions or replacement parts, please call 1-800-444-3353.

Manual Revised 10a

SAVE THIS MANUAL

Keep this manual for the safety warnings and precautions, assembly, operating, inspection, maintenance and cleaning procedures. Write the product's serial number in the back of the manual near the assembly diagram (or month and year of purchase if product has no number). Keep this manual and the receipt in a safe and dry place for future reference.

Safety Alert Symbol and Signal Words

In this manual, on the labeling, and all other information provided with this product:



This is the safety alert symbol. It is used to alert you to potential personal injury hazards. Obey all safety messages that follow this symbol to avoid possible injury or death.

DANGER

DANGER indicates a hazardous situation which, if not avoided, will result in death or serious injury.

WARNING

WARNING indicates a hazardous situation which, if not avoided, could result in death or serious injury.

CAUTION

CAUTION, used with the safety alert symbol, indicates a hazardous situation which, if not avoided, could result in minor or moderate injury.







NOTICE

NOTICE is used to address practices not related to personal injury.

CAUTION

CAUTION, without the safety alert symbol, is used to address practices not related to personal injury.

Symbol Definitions

Symbol	Property or statement
PSI	Pounds per square inch of pressure
CFM	Cubic Feet per Minute flow
SCFM	Cubic Feet per Minute flow at standard conditions
NPT	National pipe thread, tapered
NPS	National pipe thread, straight
	WARNING marking concerning Risk of Eye Injury. Wear ANSI-approved safety goggles with side shields.
	Warning marking concerning Risk of Puncture Injury. Wear heavy-duty work gloves.
	Read the manual before set-up and/or use.
	WARNING marking concerning Risk of Hearing Loss. Wear hearing protection.
	WARNING marking concerning Risk of Respiratory Injury. Wear NIOSH-approved dust mask/respirator.
	WARNING marking concerning Risk of Explosion.

IMPORTANT SAFETY INSTRUCTIONS

INSTRUCTIONS PERTAINING TO A RISK OF FIRE, ELECTRIC SHOCK, OR INJURY TO PERSONS

WARNING – When using tools, basic precautions should always be followed, including the following:

General

- a. **To reduce the risks of electric shock, fire, and injury to persons, read all the instructions before using the tool.**



Work area

- a. **Keep the work area clean and well lighted.** Cluttered benches and dark areas increase the risks of electric shock, fire, and injury to persons.
- b. **Do not operate the tool in explosive atmospheres, such as in the presence of flammable liquids, gases, or dust.** The tool is able to create sparks resulting in the ignition of the dust or fumes.
- c. **Keep bystanders, children, and visitors away while operating the tool.** Distractions are able to result in the loss of control of the tool.

Personal safety

- a. **Stay alert. Watch what you are doing and use common sense when operating the tool. Do not use the tool while tired or under the influence of drugs, alcohol, or medication.** A moment of inattention while operating the tool increases the risk of injury to persons.
- b. **Dress properly. Do not wear loose clothing or jewelry. Contain long hair. Keep hair, clothing, and gloves away from moving parts.** Loose clothes, jewelry, or long hair increases the risk of injury to persons as a result of being caught in moving parts.
- c. **Avoid unintentional starting. Be sure the trigger is released before**

connecting to the air supply. Do not carry the tool with your finger on the trigger or connect the tool to the air supply with the trigger pressed.

- d. **Do not overreach. Keep proper footing and balance at all times.** Proper footing and balance enables better control of the tool in unexpected situations.
- e.  **Use safety equipment.** A dust mask, non-skid safety shoes and a hard hat must be used for the applicable conditions. Wear heavy-duty work gloves during use.
- f.  **Always wear eye protection.** Wear ANSI-approved safety goggles with side shields.
- g.  **Always wear hearing protection when using the tool.** Prolonged exposure to high intensity noise is able to cause hearing loss.
- h. **Do not attach the hose or tool to your body.** Attach the hose to the structure to reduce the risk of loss of balance if the hose shifts.
- i. **Always assume that the tool contains fasteners.** Do not point the tool toward yourself or anyone whether it contains fasteners or not.
- j. **WARNING – Do not fire fastener on top of another fastener.** This is able to cause the fastener to be deflected and hit someone, or cause the tool to react and result in a risk of injury to persons.
- k. **WARNING – Remove finger from the trigger when not driving fasteners.** Never carry the tool with finger on trigger, the tool is able to fire a fastener.

Tool use and care

- a. **Use clamps or another practical way to secure and support the workpiece to a stable platform.** Holding the work by hand or against the body is unstable and can lead to loss of control.
- b. **Do not force the tool.** Use the correct tool for the application. The correct tool will do the job better and safer at the rate for which the tool is designed.
- c. **Do not use the tool if the trigger does not turn the tool on or off.** Any tool that cannot be controlled with the trigger is dangerous and must not be used until repaired.
- d. **Disconnect the tool from the air source before making adjustments, doing tool maintenance, clearing jams, touching the safety nosepiece, leaving work area, loading, or unloading the tool.** Such precautionary measures reduce the risk of injury to persons.
- e. **Store the tool when it is idle out of reach of children and other untrained persons.** A tool is dangerous in the hands of untrained users.
- f. **Maintain the tool with care.** A properly maintained tool reduces the risk of binding and is easier to control.
- g. **Check for misalignment or binding of moving parts, breakage of parts, and any other condition that affects the tool's operation.** If damaged, have the tool serviced before using. Many accidents are caused by poorly maintained tools. There is a risk of bursting if the tool is damaged.
- h. **Use only accessories that are identified by the manufacturer for the specific tool model.** Use of an accessory not intended for use with the

specific tool model, increases the risk of injury to persons.

- i. **Use only those fasteners listed in the Specifications chart of this manual.** Fasteners not identified for use with this tool by the tool manufacturer are able to result in a risk of injury to persons or tool damage when used in this tool.

Service

- a. **Tool service must be performed only by qualified repair personnel.**
- b. **When servicing a tool, use only identical replacement parts. Use only authorized parts.**
- c. **Use only the lubricants supplied with the tool or specified by the manufacturer.**

Air source

- a.  **Never connect to an air source that is capable of exceeding 200 PSI.** Over pressurizing the tool may cause bursting, abnormal operation, breakage of the tool or serious injury to persons. Use only clean, dry, regulated compressed air at the rated pressure or within the rated pressure range as marked on the tool. Always verify prior to using the tool that the air source has been adjusted to the rated air pressure or within the rated air-pressure range.
- b. **Never use oxygen, carbon dioxide, combustible gases or any bottled gas as an air source for the tool.** Such gases are capable of explosion and serious injury to persons.



SAVE THESE INSTRUCTIONS.

SPECIFIC SAFETY INSTRUCTIONS

1. **Operators and others in work area MUST wear ANSI-approved safety goggles with side shields during use.**
The employer is responsible to enforce the use of eye protection by the operator and others in the work area.
2. **Keep fingers away from trigger when not driving fasteners to avoid accidental firing.**
3. **Choice of triggering method is important. Check manual for triggering options.**
4. Always assume the tool contains fasteners.
5. Do not point the tool toward yourself or anyone whether it contains fasteners or not.
6. Do not actuate the tool unless the tool is placed firmly against the workpiece.
7. Respect the tool as a working implement.
8. No horseplay. This tool is not a toy and can be deadly if misused.
9. Do not load the tool with fasteners when any one of the operating controls, such as the Trigger or Safety Nosepiece, is activated.
10. Do not remove, tamper with, or otherwise cause the tool operating controls to become inoperable.
11. Do not operate the tool if any portion of the tool operating controls is inoperable, disconnected, altered, or not working properly.
12. Disconnect the tool from the air supply when:
 - a. Unattended.
 - b. Performing any maintenance or repair.
 - c. Clearing a jam.
 - d. Moving the tool to a new location.
13. Do not make any modifications to this tool.
14. Refer to the tool maintenance instructions for detailed information on the proper maintenance of the tool.
15. Fire fasteners into an appropriate work surface only. Do not attempt to fire fasteners into surfaces too hard to penetrate. Do not drive fasteners on top of other fasteners, or at too steep of an angle. Fasteners can ricochet causing personal injury.
16. Do not fire fasteners too close to the edge of a workpiece. They may split the workpiece and fly free, causing personal injury.
17. Keep clear of the workpiece near the area being fastened. Fasteners may bend sideways during firing, causing them to exit the workpiece at an unexpected point, causing personal injury.
18. Transport Tool safely. Always disconnect air supply when moving the tool. Carry the tool by the handle and avoid contact with the trigger.
19. Hold tool away from head and body. During operation the Tool may kick back causing injury.
20. Do not fire fasteners into a workpiece that has people, utility lines, or other objects behind or inside it.
21. Keep balance while using this tool. Keep area below clear if working in an elevated location, and secure air hose to prevent falls from bystanders accidentally pulling on it.

22. Obey the manual for the air compressor used to power this tool.
23. Install an in-line shutoff valve to allow immediate control over the air supply in an emergency, even if a hose is ruptured.
24. Do not engrave or stamp anything into the housing to prevent weakening of the housing.
25. **WARNING:** Some dust created by power sanding, sawing, grinding, drilling, and other construction activities, contains chemicals known [to the State of California] to cause cancer, birth defects or other reproductive harm. Some examples of these chemicals are:
 - Lead from lead-based paints
 - Crystalline silica from bricks and cement or other masonry products
 - Arsenic and chromium from chemically treated lumber
 Your risk from these exposures varies, depending on how often you do this type of work. To reduce your exposure to these chemicals: work in a well ventilated area, and work with approved safety equipment, such as those dust masks that are specially designed to filter out microscopic particles. (California Health & Safety Code § 25249.5, *et seq.*)
26. **WARNING:** The brass components of this product contain lead, a chemical known to the State of California to cause birth defects (or other reproductive harm). (California Health & Safety code § 25249.5, *et seq.*)
27. The warnings and precautions discussed in this manual cannot cover all possible conditions and situations that may occur. It must be understood by the operator that common sense and caution are factors which cannot be built into this product, but must be supplied by the operator.

Vibration Precautions

This tool vibrates during use. Repeated or long-term exposure to vibration may cause temporary or permanent physical injury, particularly to the hands, arms and shoulders. To reduce the risk of vibration-related injury:

1. Anyone using vibrating tools regularly or for an extended period should first be examined by a doctor and then have regular medical check-ups to ensure medical problems are not being caused or worsened from use. Pregnant women or people who have impaired blood circulation to the hand, past hand injuries, nervous system disorders, diabetes, or Raynaud's Disease should not use this tool. If you feel any symptoms related to vibration (such as tingling, numbness, and white or blue fingers), seek medical advice as soon as possible.
2. Do not smoke during use. Nicotine reduces the blood supply to the hands and fingers, increasing the risk of vibration-related injury.
3. Wear suitable gloves to reduce the vibration effects on the user.
4. Use tools with the lowest vibration when there is a choice between different processes.
5. Include vibration-free periods each day of work.
6. Grip tool as lightly as possible (while still keeping safe control of it). Let the tool do the work.
7. To reduce vibration, maintain tool as explained in this manual. If abnormal vibration occurs, stop immediately.



**SAVE THESE
INSTRUCTIONS.**

SPECIFICATIONS

Operating Pressure	60-100 PSI
Staple Capacity	80
Staple Length / Type	$\frac{3}{4}$ " to $1\frac{1}{2}$ ", $\frac{1}{4}$ " Crown, .039-.042" Shank (18 Gauge)
Air Inlet	$\frac{1}{4}$ " NPT (18 TPI - male/female adapter included)

Note: SKU's 40072 and 97521 contain the Stapler by itself.
SKU 40073 contains the Stapler, pneumatic tool oil, 2 hex wrenches, and a blowmold carrying case.

UNPACKING

When unpacking, make sure the item is intact and undamaged. If any parts are missing or broken, call Harbor Freight Tools at 1-800-444-3353 as soon as possible.

OPERATION

For best service, incorporate an oiler, regulator, and inline filter, as shown in the diagram below. Hoses, couplers, oilers, regulators, and filters are all available at Harbor Freight Tools.

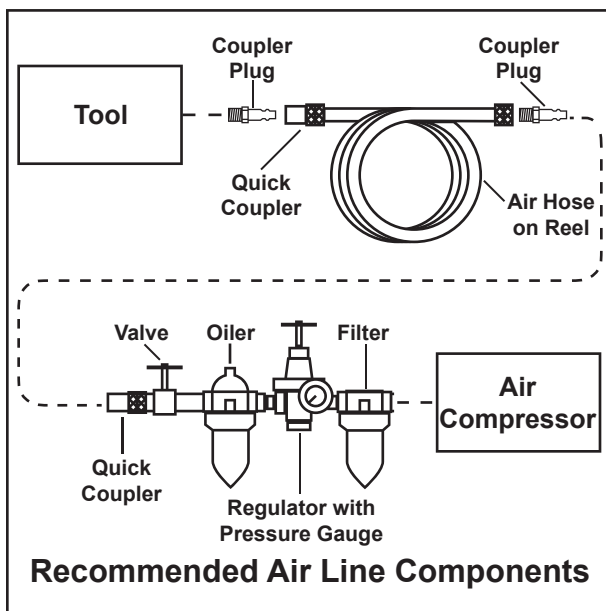

Note: To connect this tool, we recommend a quick coupler/adapter (not included). Coupler/adapters are available at Harbor Freight Tools. For smoother operation, put 3-5 drops of pneumatic tool oil in the Air Plug (82) before each use.

Testing the Single Sequential Safety Trip Mechanism

Warning: Even though the Stapler should be empty during this procedure, **ALWAYS** point the Stapler at a piece of scrap wood when testing.

1. Make sure the tool is disconnected from the power supply.
2. Completely empty the magazine of staples.
3. The Stapler should not fire if the nose is not depressed against the workpiece.
4. Check that the Trigger (39) and the Safety (52) move freely, without sticking.
5. Connect the air supply to the tool at the Air Plug (82) set at the recommended 60-100 PSI, and not to go over the maximum 100 PSI.
6. Test the tool by depressing the Safety (52) against the workpiece without pulling the Trigger (39). **The tool must not cycle (fire)**. If it cycles (fires), stop immediately and take the tool to a qualified service technician.
7. Hold the tool away or off of the workpiece. The Safety (52) of the tool should return to its original position. Squeeze the Trigger (39). **The tool should not cycle (fire)**. If it cycles (fires), stop immediately and take the tool to a qualified service technician.
8. Depress the Safety (52) against the workpiece and squeeze the Trigger (39). **The tool must cycle (fire) once only**. Release the trigger and squeeze it again. **The tool must cycle (fire) once only**.

REV 10a

SKU's 40072,
40073, & 97521

For technical questions, please call 1-800-444-3353.

Page 7

With the Trigger held, carefully lift the nailer and press it against the workpiece again. **The tool must not cycle (fire).** If it fails to act in the manner explained in bold, have it repaired by a qualified service technician.

Loading Staples



ALWAYS WEAR ANSI APPROVED IMPACT SAFETY GOGGLES WHEN RELOADING OR DOING ANY OTHER MAINTENANCE ON THIS TOOL. Other people in the work area must also wear ANSI approved impact safety goggles.

Warning! Make sure the Stapler is not attached to the air hose whenever loading the tool.

1. Release the Latch (69) and pull back on Magazine B (61).
2. Insert a row of clean, undamaged staples with the crowns up.
3. Push Magazine B (61) forward until the Latch (69) snaps into place.

Operating the Stapler

1. Attach the Stapler to the air supply at the Air Plug (82). Start your compressor and check the pressure, making sure it is set at the recommended 60-100 PSI and not to go over the maximum 100 PSI.
2. To fire, place the nose of the Stapler on the workpiece. The Stapler should not fire if the nose is not depressed. Once depressed, gently and briefly squeeze the Trigger (39) once. **Do not fire repeatedly. Staples could bounce off of one another, damaging the work piece or causing PERSONAL INJURY.**
3. After disconnecting the Stapler, the Nut (39), near the trigger, can be turned to adjust the depth. After adjusting, be sure to practice on scrap wood before working on a project.

Clearing Jams



TO PREVENT SERIOUS INJURY

FROM ACCIDENTAL OPERATION, BEFORE ANY MAINTENANCE OR REPAIRS ARE DONE (including clearing jams):



- **Wear ANSI-approved safety goggles with side shields.** Other people in the work area must also wear ANSI-approved impact safety goggles with side shields.
 - **Release the trigger.**
 - **Detach the air supply.**
 - **Attempt to fire the Tool into a piece of scrap wood to ensure that it is disconnected and is incapable of firing any fasteners.**
 - **Empty the magazine and leave it open during service.**
1. Disconnect tool from air hose, empty Magazine A (66) of staples, release any built-up air pressure, and leave the magazine open, as explained above.

FIGURE 1 Safety Cover Bolt (53)



2. While doing this step and the next, hold the Stapler pointed away from you and any other people or fragile objects - see *Figure 1*. Remove all three Safety Cover Bolts (53) on the Safety Cover (54).

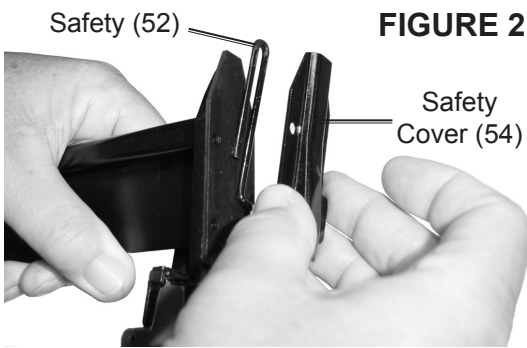

FIGURE 2

3. Lift the Safety Cover (54) off the top of the stapler - see *Figure 2*.

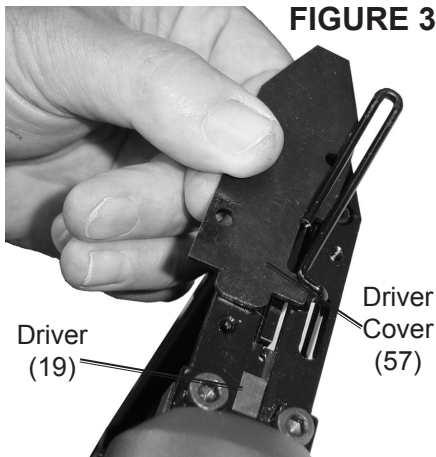

FIGURE 3

4. Carefully slide the Driver Cover (57) off around the Safety (52) and remove the jammed staple - see *Figure 3*. Use pliers to remove a stuck staple.
5. Inspect the Driver (19) for bends or breakage - see *Figure 3*. If it is damaged, do not use the tool until it is repaired by a qualified technician.
6. Lightly oil the Driver (19) and replace the Driver Cover (57). Replace the Safety Cover (54), being careful to line up the bolt holes and fit the Safety (52) into the slot. Replace and securely tighten all of the Safety Cover Bolts (53). The Safety (52) must move without sticking.
7. Reload the Stapler.
8. Reconnect the Stapler to the air hose.
9. Press the Safety (52) of the Stapler against an appropriate piece of scrap wood and test fire the Stapler several times, checking for proper operation.

REV 10a

SKU's 40072,
40073, & 97521

For technical questions, please call 1-800-444-3353.

Page 9

10. Disconnect the Stapler, remove the staples, and store the Stapler in a location out of children's reach.

MAINTENANCE

⚠️ WARNING TO PREVENT SERIOUS INJURY

FROM ACCIDENTAL OPERATION, BEFORE ANY MAINTENANCE OR REPAIRS ARE DONE (including clearing jams):



- **Wear ANSI-approved safety goggles with side shields.** Other people in the work area must also wear ANSI-approved impact safety goggles with side shields.
- **Release the trigger.**
- **Detach the air supply.**
- **Attempt to fire the Tool into a piece of scrap wood to ensure that it is disconnected and is incapable of firing any fasteners.**
- **Empty the magazine and leave it open during service.**

Note: If the Stapler leaks air, continually skips staples, does not drive the staple properly, or the Trigger (39) or Safety (52) do not move freely have it serviced by a qualified service technician.

1. After each use, check the tightness on all visible screws.
2. Wipe the Stapler clean daily with a damp cloth and non-flammable cleaning solution. Never soak the Stapler.
3. Make sure that no dirt or debris blocks the fastener discharge area.
4. **Any maintenance, service, or repairs, apart from those procedures explained in this manual, are to be attempted only by a qualified technician.**

PARTS LIST

Part	Description
1	Exhaust Deflector
2	O-Ring
3	Hex. Bolt
4	Head Cap
5	Seal
6	Internal Lining
7	O-Ring
8	Compression Spring
9	Gasket
10	O-Ring
11	Head Valve Piston
12	O-Ring
13	O-Ring
14	O-Ring
15	Collar
16	O-Ring
17	Piston
18	Pin
19	Driver
20	O-Ring
21	Lining Ring
22	O-Ring
23	Cylinder
24	O-Ring
25	Bumper
26	Body
27	Nozzle
28	Seal

Part	Description
29	Trigger Valve Upper
30	Spring
31	O-Ring
32	Trigger Plunger
33	O-Ring
34	Trigger Valve Lower
35	Compression Spring
36	Trigger Plate
37	Spring Pin
38	E-Ring
39	Trigger
40	Retainer Pin
41	Safety Guide
42	Spring Washer
43	Hex Bolt
44	Spring Pin
45	Spring
46	Screw Nut
47	Thumb Wheel
48	Spring
49	Steel Ball
50	Stopper
51	E-Ring
52	Safety
53	Safety Cover Bolt
54	Safety Cover
55	Hex. Bolt
56	Spacer

Part	Description
57	Driver Cover
58	Driver Guide
59	Hex. Bolt
60	Pin
61	Magazine B
62	Pusher Unit
63	Spring Holder
64	O-Ring
65	Spring
66	Magazine A
67	Hex. Bolt
68	Retainer Pin
69	Latch
70	Spring
71	O-Ring
72	Hex Bolt
73	Cylinder Pin
74	Tail Cover
75	Hex. Bolt
76	Hex. Bolt
77	Tail Hanger
78	Lock Nut
79	Hand Grip
80	O-Ring
81	End Cap
82	Air Plug

PLEASE READ THE FOLLOWING CAREFULLY

THE MANUFACTURER AND/OR DISTRIBUTOR HAS PROVIDED THE PARTS DIAGRAM IN THIS MANUAL AS A REFERENCE TOOL ONLY. NEITHER THE MANUFACTURER NOR DISTRIBUTOR MAKES ANY REPRESENTATION OR WARRANTY OF ANY KIND TO THE BUYER THAT HE OR SHE IS QUALIFIED TO MAKE ANY REPAIRS TO THE PRODUCT OR THAT HE OR SHE IS QUALIFIED TO REPLACE ANY PARTS OF THE PRODUCT. IN FACT, THE MANUFACTURER AND/OR DISTRIBUTOR EXPRESSLY STATES THAT ALL REPAIRS AND PARTS REPLACEMENTS SHOULD BE UNDERTAKEN BY CERTIFIED AND LICENSED TECHNICIANS AND NOT BY THE BUYER. THE BUYER ASSUMES ALL RISK AND LIABILITY ARISING OUT OF HIS OR HER REPAIRS TO THE ORIGINAL PRODUCT OR REPLACEMENT PARTS THERETO, OR ARISING OUT OF HIS OR HER INSTALLATION OF REPLACEMENT PARTS THERETO.

Note: Some parts are listed and shown for illustration purposes only and are not available individually as replacement parts.

ASSEMBLY DIAGRAM

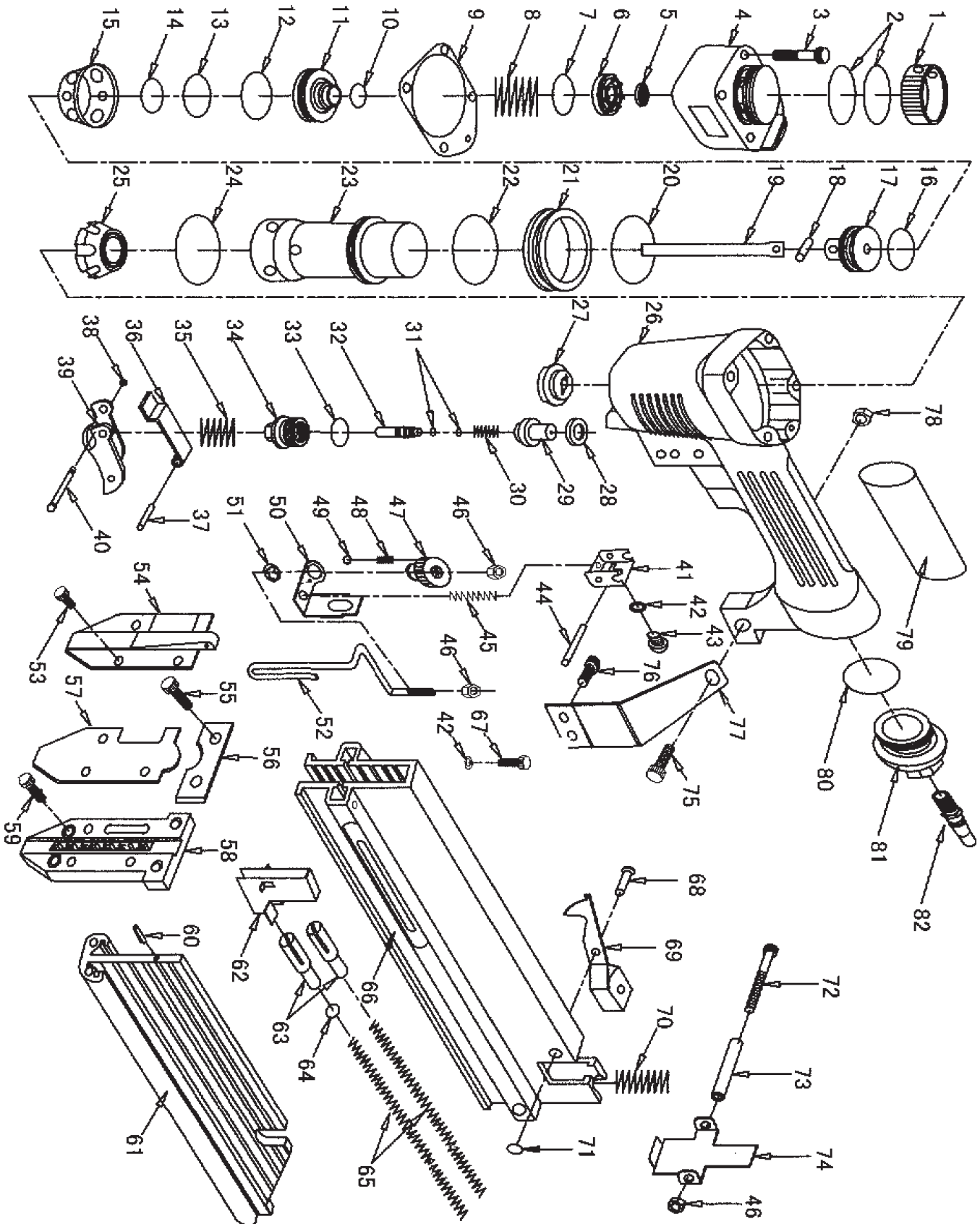

SKU's 40072,
40073, & 97521

For technical questions, please call 1-800-444-3353.

Page 11

LIMITED 1 YEAR WARRANTY

Harbor Freight Tools Co. makes every effort to assure that its products meet high quality and durability standards, and warrants to the original purchaser that this product is free from defects in materials and workmanship for the period of one year from the date of purchase (90 days if used by a professional contractor or if used as rental equipment). This warranty does not apply to damage due directly or indirectly, to misuse, abuse, negligence or accidents, repairs or alterations outside our facilities, normal wear and tear, or to lack of maintenance. We shall in no event be liable for death, injuries to persons or property, or for incidental, contingent, special or consequential damages arising from the use of our product. Some states do not allow the exclusion or limitation of incidental or consequential damages, so the above limitation of exclusion may not apply to you. THIS WARRANTY IS EXPRESSLY IN LIEU OF ALL OTHER WARRANTIES, EXPRESS OR IMPLIED, INCLUDING THE WARRANTIES OF MERCHANTABILITY AND FITNESS.

To take advantage of this warranty, the product or part must be returned to us with transportation charges prepaid. Proof of purchase date and an explanation of the complaint must accompany the merchandise. If our inspection verifies the defect, we will either repair or replace the product at our election or we may elect to refund the purchase price if we cannot readily and quickly provide you with a replacement. We will return repaired products at our expense, but if we determine there is no defect, or that the defect resulted from causes not within the scope of our warranty, then you must bear the cost of returning the product.

This warranty gives you specific legal rights and you may also have other rights which vary from state to state.

3491 Mission Oaks Blvd. • PO Box 6009 • Camarillo, CA 93011 • (800) 444-3353

Free Manuals Download Website

<http://myh66.com>

<http://usermanuals.us>

<http://www.somanuals.com>

<http://www.4manuals.cc>

<http://www.manual-lib.com>

<http://www.404manual.com>

<http://www.luxmanual.com>

<http://aubethermostatmanual.com>

Golf course search by state

<http://golfingnear.com>

Email search by domain

<http://emailbydomain.com>

Auto manuals search

<http://auto.somanuals.com>

TV manuals search

<http://tv.somanuals.com>