

CHICAGO

Electric Power Tools

SOLDERING GUN KIT

180 WATT WITH LIGHT

Model 04328

ASSEMBLY AND OPERATING INSTRUCTIONS



3491 Mission Oaks Blvd., Camarillo, CA 93011
Visit our Web site at: <http://www.harborfreight.com>

Copyright ©2003 by Harbor Freight Tools®. All rights reserved. No portion of this manual or any artwork contained herein may be reproduced in any shape or form without the express written consent of Harbor Freight Tools.

For technical questions, please call 1-800-444-3353.

PRODUCT SPECIFICATIONS



| Item | Description |
|-------------------|---|
| Soldering Power | 180 watts; heats to 1135° F. |
| Power Consumption | 120 VAC, 60 Hz, 1.5 amps |
| Line Cord | 18 AWG x 2C, UL Listed; 2-prong polarized plug |
| Weight | 2.35 Lbs. |
| Features | Frontal light to illuminate workpiece |
| Lightbulb | 6 volt, 3 watt |
| Accessories | 3 – Soldering Tips 1 – Roll rosin core solder 1 – Solder flux |

SAVE THIS MANUAL

You will need this manual for the safety warnings and precautions, assembly, operating, inspection, maintenance and cleaning procedures, parts list and assembly diagram. Keep your invoice with this manual. Write the invoice number on the inside of the front cover. Keep this manual and invoice in a safe and dry place for future reference.

GENERAL SAFETY RULES



WARNING!

READ AND UNDERSTAND ALL INSTRUCTIONS
Failure to follow all instructions listed below may result in
electric shock, fire, and/or serious injury.
SAVE THESE INSTRUCTIONS

WORK AREA

1. **Keep your work area clean and well lit.** Cluttered areas invite accidents.
2. **Do not operate power tools in explosive atmospheres, such as in the presence of flammable liquids, gases, or dust.** Power tools create sparks which may ignite the dust or fumes.
3. **Keep bystanders, children, and visitors away while operating a power tool.** Distractions can cause you to lose control. Protect others in the work area from debris such as chips and sparks. Provide barriers or shields as needed.

ELECTRICAL SAFETY

4. **Grounded tools must be plugged into an outlet properly installed and grounded in accordance with all codes and ordinances. Never remove the grounding prong or modify the plug in any way. Do not use any adapter plugs. Check with a qualified electrician if you are in doubt as to whether the outlet is properly grounded.** If the tools should electrically malfunction or break down, grounding provides a low resistance path to carry electricity away from the user.
5. **Double insulated tools are equipped with a polarized plug (one blade is wider than the other). This plug will fit in a polarized outlet only one way. If the plug does not fit fully in the outlet, reverse the plug. If it still does not fit, contact a qualified electrician to install a polarized outlet. Do not change the plug in any way.** Double insulation eliminates the need for the three wire grounded power cord and grounded power supply system.
6. **Avoid body contact with grounded surfaces such as pipes, radiators, ranges, and refrigerators.** There is an increased risk of electric shock if your body is grounded.
7. **Do not expose power tools to rain or wet conditions.** Water entering a power tool will increase the risk of electric shock.
8. **Do not abuse the Power Cord. Never use the Power Cord to carry the tools or pull the Plug from an outlet. Keep the Power Cord away from heat, oil, sharp edges, or moving parts. Replace damaged Power Cords immediately.** Damaged Power Cords increase the risk of electric shock.
9. **When operating a power tool outside, use an outdoor extension cord marked "W-A" or "W".** These extension cords are rated for outdoor use, and reduce the risk of electric shock.

PERSONAL SAFETY

10. **Stay alert. Watch what you are doing, and use common sense when operating a power tool. Do not use a power tool while tired or under the influence of drugs, alcohol, or medication.** A moment of inattention while operating power tools may result in serious personal injury.
11. **Dress properly. Do not wear loose clothing or jewelry. Contain long hair. Keep your hair, clothing, and gloves away from moving parts.** Loose clothes, jewelry, or long hair can be caught in moving parts.

12. **Avoid accidental starting. Be sure the Power Switch is off before plugging in.** Carrying power tools with your finger on the Power Switch, or plugging in power tools with the Power Switch on, invites accidents.
13. **Remove adjusting keys or wrenches before turning the power tool on.** A wrench or a key that is left attached to a rotating part of the power tool may result in personal injury.
14. **Do not overreach. Keep proper footing and balance at all times.** Proper footing and balance enables better control of the power tool in unexpected situations.
15. **Use safety equipment. Always wear eye protection.** Dust mask, non-skid safety shoes, hard hat, or hearing protection must be used for appropriate conditions.

TOOL USE AND CARE

16. **Use clamps (not included) or other practical ways to secure and support the workpiece to a stable platform.** Holding the work by hand or against your body is unstable and may lead to loss of control.
17. **Do not force the tool. Use the correct tool for your application.** The correct tool will do the job better and safer at the rate for which it is designed.
18. **Do not use the power tool if the Power Switch does not turn it on or off.** Any tool that cannot be controlled with the Power Switch is dangerous and must be replaced.
19. **Disconnect the Power Cord Plug from the power source before making any adjustments, changing accessories, or storing the tool.** Such preventive safety measures reduce the risk of starting the tool accidentally.
20. **Store idle tools out of reach of children and other untrained persons.** Tools are dangerous in the hands of untrained users.
21. **Maintain tools with care. Keep cutting tools sharp and clean.** Properly maintained tools with a sharp cutting edge are less likely to bind and are easier to control. Do not use a damaged tool. Tag damaged tools "Do not use" until repaired.
22. **Check for misalignment or binding of moving parts, breakage of parts, and any other condition that may affect the tool's operation. If damaged, have the tool serviced before using.** Many accidents are caused by poorly maintained tools.

23. **Use only accessories that are recommended by the manufacturer for your model.** Accessories that may be suitable for one tool may become hazardous when used on another tool.

SERVICE

24. **Tool service must be performed only by qualified repair personnel.** Service or maintenance performed by unqualified personnel could result in a risk of injury.
25. **When servicing a tool, use only identical replacement parts. Follow instructions in the “*Inspection, Maintenance, And Cleaning*” section of this manual.** Use of unauthorized parts or failure to follow maintenance instructions may create a risk of electric shock or injury.

SPECIFIC SAFETY RULES

1. **Maintain labels and nameplates on the Soldering Gun.** These carry important information. If unreadable or missing, contact Harbor Freight Tools for a replacement.
2. **Always wear safety impact eye goggles and heavy work gloves when using the Soldering Gun.** Using personal safety devices reduce the risk for injury. Safety impact eye goggles and heavy work gloves are available from Harbor Freight Tools.
3. **Maintain a safe working environment.** Keep the work area well lit. Make sure there is adequate surrounding workspace. Always keep the work area free of obstructions, grease, oil, trash, and other debris. Do not use a power tool in areas near flammable chemicals, dusts, and vapors. Do not use this product in a damp or wet location.
4. **Make sure to read and understand all instructions and safety precautions as outlined in the instruction manual.**
5. **Always keep the extension cord away from heated parts on the tool.**
6. **Avoid unintentional starting.** Make sure you are prepared to begin work before turning on the Soldering Gun.
7. **When using the Soldering Gun, always maintain a firm grip on the tool.**

8. **Connect tool to properly grounded outlets.** **Caution:** To provide continued protection against risk of electric shock, connect to properly grounded outlets only. Do not immerse the Soldering Gun in water.
9. **Use of any accessory or attachment other than those mentioned in the manual may result in personal injury and/or property damage.**
10. **Avoid Serious Burns.** The Soldering Gun reaches 1135° F. Do not point the Soldering Gun, or turn yourself toward another person while soldering.
11. **Do not open Soldering Gun.** Do not attempt to open and repair this unit. It must be serviced by a qualified technician.
12. **Indoor use only.** This product was designed primarily for indoor use only.
13. **Avoid damaging equipment and tools.** Always de-energize any circuits or wires to be soldered before making connections and soldering.
14. **Do not breath soldering fumes.** Never breath soldering fumes as they may make you ill.
15. **Never lay the Soldering Gun down where the heated parts can contact flammable materials or electrical wires.**
16. **Never leave the Soldering Gun unattended when it is plugged into an electrical outlet.** Turn off the tool, and unplug it from its electrical outlet before leaving.
17. **Always unplug the Soldering Gun from its electrical outlet before performing and inspection, maintenance, or cleaning procedures.**
18.  **WARNING** People with pacemakers should consult their physician(s) before using this product. Operation of electrical equipment in close proximity to a heart pacemaker could cause interference or failure of the pacemaker.

Note: Performance of this tool may vary depending on variations in local line voltage. Extension cord usage may also affect tool performance.

Warning: The warnings, cautions, and instructions discussed in this instruction manual cannot cover all possible conditions and situations that may occur. It must be understood by the operator that common sense and cautions are factors which cannot be built into this product, but must be supplied by the operator.

GROUNDING

WARNING!

Improperly connecting the grounding wire can result in the risk of electric shock. Check with a qualified electrician if you are in doubt as to whether the outlet is properly grounded. Do not modify the power cord plug provided with the tool. Never remove the grounding prong from the plug. Do not use the tool if the power cord or plug is damaged. If damaged, have it repaired by a service facility before use. If the plug will not fit the outlet, have a proper outlet installed by a qualified electrician.

GROUNDED TOOLS: TOOLS WITH THREE PRONG PLUGS

1. Tools marked with “Grounding Required” have a three wire cord and three prong grounding plug. The plug must be connected to a properly grounded outlet. If the tool should electrically malfunction or break down, grounding provides a low resistance path to carry electricity away from the user, reducing the risk of electric shock. **(See Figure A.)**
2. The grounding prong in the plug is connected through the green wire inside the cord to the grounding system in the tool. The green wire in the cord must be the only wire connected to the tool’s grounding system and must never be attached to an electrically “live” terminal. **(See Figure A.)**
3. Your tool must be plugged into an appropriate outlet, properly installed and grounded in accordance with all codes and ordinances. The plug and outlet should look like those in the following illustration. **(See Figure A.)**

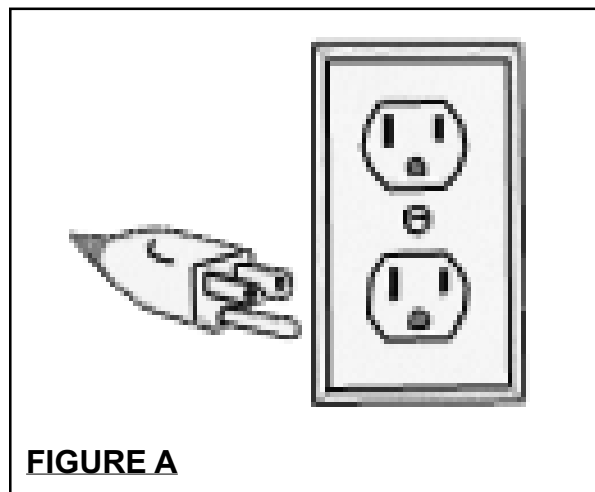

DOUBLE INSULATED TOOLS: TOOLS WITH TWO PRONG PLUGS

4. Tools marked "Double Insulated" do not require grounding. They have a special double insulation system which satisfies OSHA requirements and complies with the applicable standards of Underwriters Laboratories, Inc., the Canadian Standard Association, and the National Electrical Code. **(See Figure B.)**
5. Double insulated tools may be used in either of the 120 volt outlets shown in the following illustration. **(See Figure B.)**

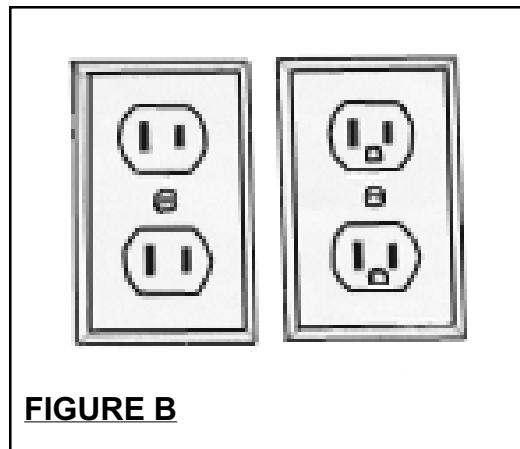

EXTENSION CORDS



1. **Grounded** tools require a three wire extension cord. **Double Insulated** tools can use either a two or three wire extension cord.
2. As the distance from the supply outlet increases, you must use a heavier gauge extension cord. Using extension cords with inadequately sized wire causes a serious drop in voltage, resulting in loss of power and possible tool damage. **(See Figure C, next page.)**
3. The smaller the gauge number of the wire, the greater the capacity of the cord. For example, a 14 gauge cord can carry a higher current than a 16 gauge cord. **(See Figure C.)**
4. When using more than one extension cord to make up the total length, make sure each cord contains at least the minimum wire size required. **(See Figure C.)**
5. If you are using one extension cord for more than one tool, add the nameplate amperes and use the sum to determine the required minimum cord size. **(See Figure C.)**

6. If you are using an extension cord outdoors, make sure it is marked with the suffix "W-A" ("W" in Canada) to indicate it is acceptable for outdoor use.
7. Make sure your extension cord is properly wired and in good electrical condition. Always replace a damaged extension cord or have it repaired by a qualified electrician before using it.
8. Protect your extension cords from sharp objects, excessive heat, and damp or wet areas.

| RECOMMENDED MINIMUM WIRE GAUGE FOR EXTENSION CORDS* (120 VOLT) | | | | | |
|---|------------------------------|--------------------|--------------------|---------------------|---------------------|
| NAMEPLATE AMPERES (At Full Load) | EXTENSION CORD LENGTH | | | | |
| | 25 Feet | 50 Feet | 75 Feet | 100 Feet | 150 Feet |
| 0 – 2.0 | 18 | 18 | 18 | 18 | 16 |
| 2.1 – 3.4 | 18 | 18 | 18 | 16 | 14 |
| 3.5 – 5.0 | 18 | 18 | 16 | 14 | 12 |
| 5.1 – 7.0 | 18 | 16 | 14 | 12 | 12 |
| 7.1 – 12.0 | 18 | 14 | 12 | 10 | - |
| 12.1 – 16.0 | 14 | 12 | 10 | - | - |
| 16.1 – 20.0 | 12 | 10 | - | - | - |

FIGURE C * Based on limiting the line voltage drop to five volts at 150% of the rated amperes.

SYMBOLOLOGY

| | |
|---|---|
|  | Double Insulated |
|  | Canadian Standards Association |
|  | Underwriters Laboratories, Inc. |
| V ~ | Volts Alternating Current |
| A | Amperes |
| n_oxxxx/min. | No Load Revolutions per Minute (RPM) |

UNPACKING

When unpacking, check to make sure all the parts shown on the **Parts List on page 13** are included. If any parts are missing or broken, please call Harbor Freight Tools at the number shown on the cover of this manual as soon as possible.

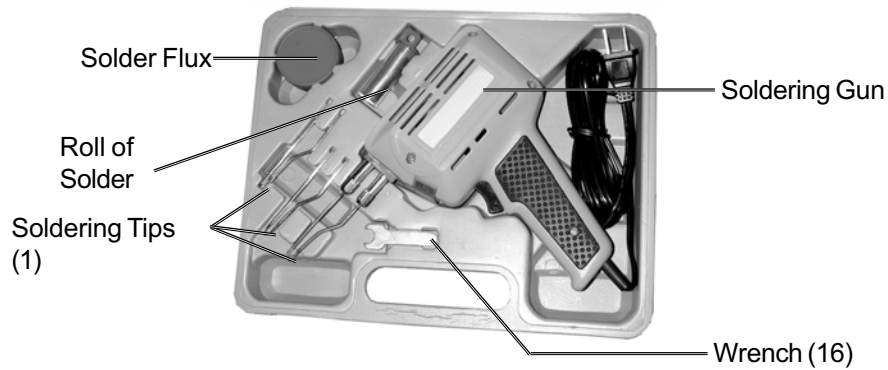

ASSEMBLY AND OPERATING INSTRUCTIONS

NOTE: For additional information regarding the parts listed in the following pages, refer to the **Assembly Diagram on page 14**.

CAUTION: Always make sure the Power Cord of the Soldering Gun is unplugged from its electrical outlet prior to making any adjustments to the tool.

WARNING: This product contains lead, which is a chemical known to the State of California to cause cancer and birth defects or other reproductive harm. (California Health & Safety Code 25249.5, et seq.)

This product, when used for soldering and similar applications, produces chemicals known to the State of California to cause cancer and birth defects (or other reproductive harm). (California Health & Safety Code 25249.5 et seq.)

Preparing the Soldering Tip

1. Using Wrench (16), check that the Soldering Tip Nuts (2) are not loose.
Do not overtighten as you may strip the threads.
2. Set the Soldering Gun on the workbench, and plug the Line Cord into an electrical outlet.
3. Press on the Trigger Switch (12) until the Soldering Tip (1) heats up.
4. Apply a sufficient amount of rosin-core solder to melt over the entire tip of the Soldering Gun. Wipe the tip with a rag until the tip is clean and shiny.

Preparing the Metal to be Soldered

1. If wires are to be soldered, thoroughly clean or scrape the wires so that only the clean copper is showing. Make the wire splice.
2. If other metals are to be soldered, thoroughly clean or scrape the metal surfaces. It may be necessary to apply acid flux (not supplied) to the metal surfaces before soldering.

Caution: If soldering on printed circuit boards, too much heat can soften the plastic form and loosen the metal eyelet connections. Use minimal heat, or solder with a low wattage soldering pencil. Never use acid core solder on wiring circuits.

Soldering

1. Press on the Trigger Switch (12) until the Soldering Tip (1) heats up.
2. Brush on solder flux, as needed, to the workpiece. Place the Soldering Tip to the joint, wiring splice, or metal to be soldered.
3. Apply solder to the wire splice or metal to be soldered, not the Soldering Tip.

When the splice or metal is hot enough, it will melt the solder causing it to flow within the splice or between the metal surfaces.

4. When the solder has flowed over the entire wire splice or metal surface, remove the Soldering Tip and release the Trigger Switch.

If you are new to soldering, you may find it helpful to practice soldering first on scrap wires and splices.

Maintenance

Note: Maintenance requiring disassembly of this tool should only be performed while the product is disconnected from the electrical supply circuit.

1. When you are finished soldering, heat up the Soldering Tip (1) again and apply a small amount of rosin-core solder to coat the tip. Wipe off with a rag.
This will leave the tip clean and ready for use again.
2. If the Soldering Tip cracks or becomes eroded, the Soldering Tip needs to be replaced. In this condition, it will not heat up properly.

Accessories

Replacing the Soldering Tip

1. To replace the Soldering Tip, place the Wrench (16) over each Nut (2) and remove by turning counterclockwise.
2. Push the Nuts toward the Soldering Tip end, exposing the opposite ends of the Soldering Tip.
3. Guide the old Soldering Tip out of the Transformer Assembly (4) mounting posts (A). Refer to the Assembly Drawing on the next page.
4. Straighten out the ends of the old Soldering Tip using pliers, and remove the Nuts (2).
5. Place the Nuts over the mounting ends of the new Soldering Tip.
6. Using pliers, bend the mounting ends of the new Soldering Tip so that about 3/16 inch is at 90 degrees.

If the bend is too long, the Nuts will not fit over mounting posts.

7. Guide the bent ends into the mounting posts of the Transformer Assembly.
8. Carefully tighten the Nuts over the mounting posts.

Make sure that the Nuts fit squarely over threads or damage will occur to the mounting post threads. Do not overtighten.

Replacing the Light Bulb

1. Remove the Light Bulb Lens (15) from the front of the Soldering Gun.
2. Pull out the burnt Light Bulb and replace with a new one of the same voltage and type (see Specifications).
3. Replace the Light Bulb Lens

INSPECTION, MAINTENANCE, AND CLEANING

1.  **WARNING!** Make sure the Power Switch (part #) of the Soldering Gun is in its "OFF" position and that the tool is unplugged from its electrical outlet before performing any inspection, maintenance, or cleaning procedures.
2. **BEFORE EACH USE**, inspect the general condition of the Soldering Gun. Check for loose screws, misalignment or binding of moving parts, cracked or broken parts, damaged electrical wiring, and any other condition that may affect its safe operation. If abnormal noise or vibration occurs, have the problem corrected before further use. **Do not use damaged equipment.**

Parts List

| Item # | Description | Qty |
|--------|--------------------------|-----|
| 1 | Soldering Tip | 3 |
| 2 | Nut | 2 |
| 3 | Heat Insulation Plate | 1 |
| 4 | Transformer Assembly | 1 |
| 5 | Cover (right) | 1 |
| 6 | Cover (left) | 1 |
| 7 | Screw | 4 |
| 8 | Plate | 2 |
| 9 | Line Cord | 1 |
| 10 | Strain Relief, Line Cord | 1 |
| 11 | Terminals | 2 |
| 12 | Trigger Switch | 1 |
| 13 | Button | 1 |
| 14 | Light Bulb | 1 |
| 15 | Lens, Light Bulb | 1 |
| 16 | Wrench | 1 |
| 17 | Blow Mold Case | 1 |

NOTE: Some parts are listed and shown for illustration purposes only and are not available individually as replacement parts.

PLEASE READ THE FOLLOWING CAREFULLY

THE MANUFACTURER AND/OR DISTRIBUTOR HAS PROVIDED THE PARTS LIST AND ASSEMBLY DIAGRAM IN THIS MANUAL AS A REFERENCE TOOL ONLY. NEITHER THE MANUFACTURER OR DISTRIBUTOR MAKES ANY REPRESENTATION OR WARRANTY OF ANY KIND TO THE BUYER THAT HE OR SHE IS QUALIFIED TO MAKE ANY REPAIRS TO THE PRODUCT, OR THAT HE OR SHE IS QUALIFIED TO REPLACE ANY PARTS OF THE PRODUCT. IN FACT, THE MANUFACTURER AND/OR DISTRIBUTOR EXPRESSLY STATES THAT ALL REPAIRS AND PARTS REPLACEMENTS SHOULD BE UNDERTAKEN BY CERTIFIED AND LICENSED TECHNICIANS, AND NOT BY THE BUYER. THE BUYER ASSUMES ALL RISK AND LIABILITY ARISING OUT OF HIS OR HER REPAIRS TO THE ORIGINAL PRODUCT OR REPLACEMENT PARTS THERETO, OR ARISING OUT OF HIS OR HER INSTALLATION OF REPLACEMENT PARTS THERETO.

ASSEMBLY DIAGRAM

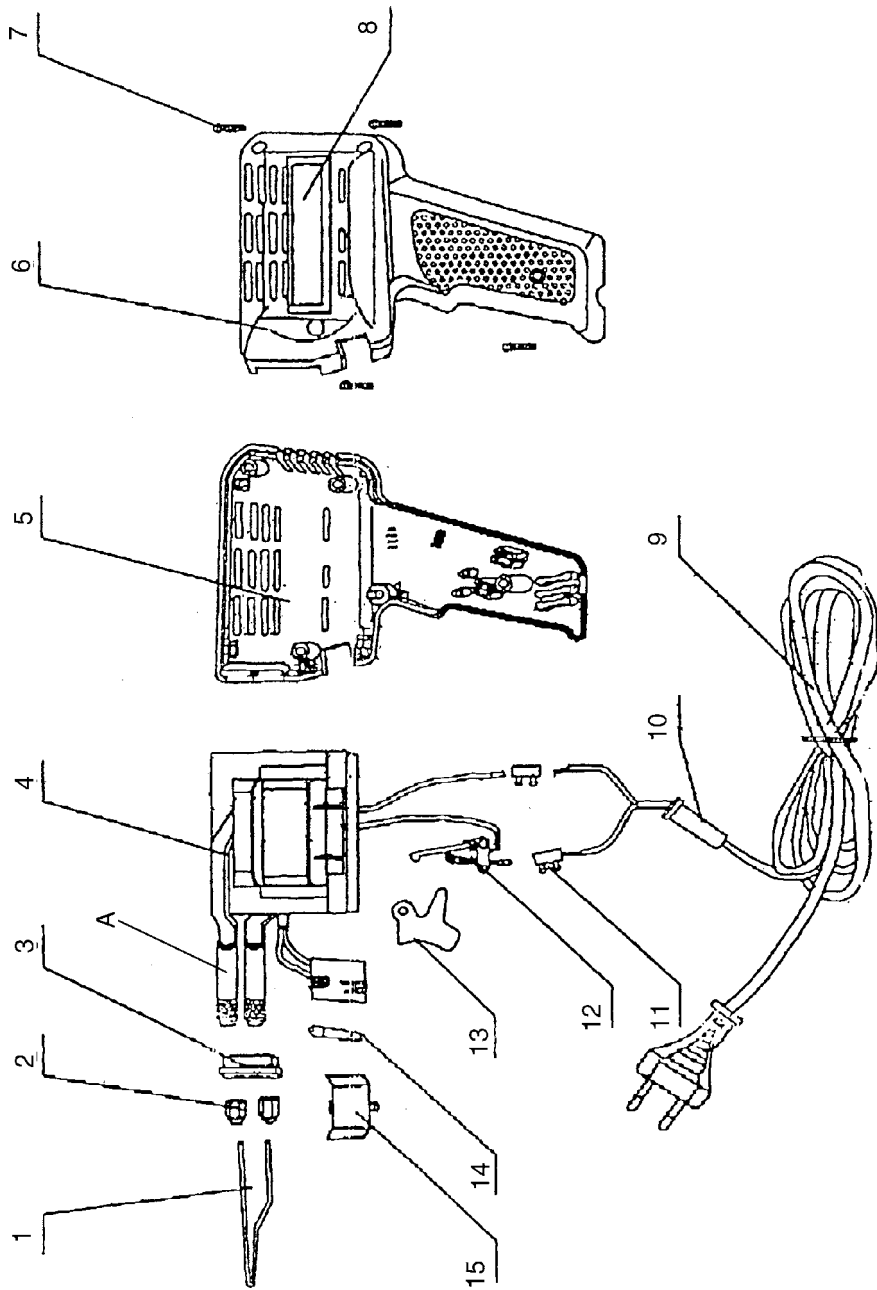

NOTE: Some parts are listed and shown for illustration purposes only, and are not available individually as replacement parts.

Free Manuals Download Website

<http://myh66.com>

<http://usermanuals.us>

<http://www.somanuals.com>

<http://www.4manuals.cc>

<http://www.manual-lib.com>

<http://www.404manual.com>

<http://www.luxmanual.com>

<http://aubethermostatmanual.com>

Golf course search by state

<http://golfingnear.com>

Email search by domain

<http://emailbydomain.com>

Auto manuals search

<http://auto.somanuals.com>

TV manuals search

<http://tv.somanuals.com>