

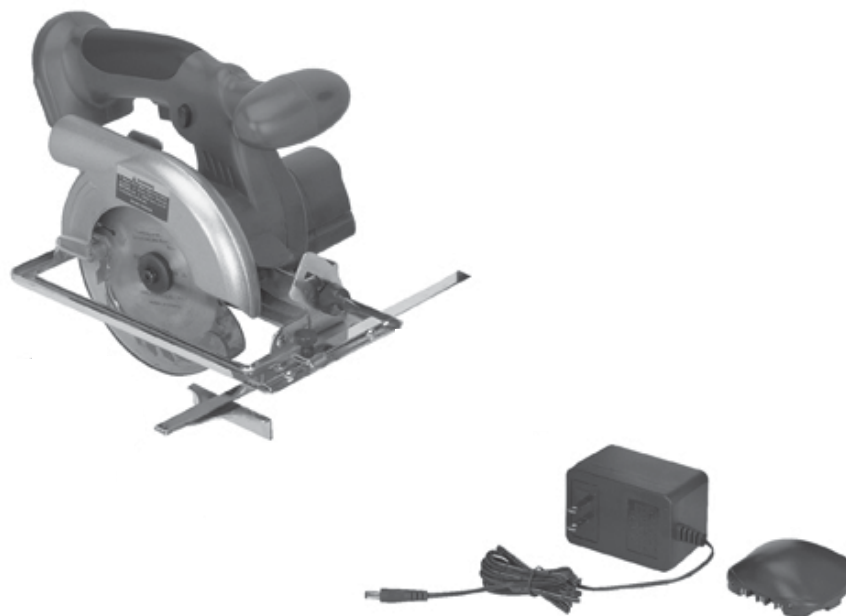

18V CIRCULAR SAW

Model 93827

ASSEMBLY AND OPERATING INSTRUCTIONS



Due to continuing improvements, actual product may differ slightly from the product described herein.



3491 Mission Oaks Blvd., Camarillo, CA 93011
Visit our Web site at <http://www.harborfreight.com>

**TO PREVENT SERIOUS INJURY,
READ AND UNDERSTAND ALL WARNINGS
AND INSTRUCTIONS BEFORE USE.**

Copyright© 2005 by Harbor Freight Tools®. All rights reserved. No portion of this manual or any artwork contained herein may be reproduced in any shape or form without the express written consent of Harbor Freight Tools.

For technical questions and replacement parts, please call 1-800-444-3353.

Contents

UNPACKING.....	2
PRODUCT SPECIFICATIONS.....	3
GENERAL SAFETY RULES	3
CHARGING THE BATTERY	10
OPERATION	11
Circular Saw	11
INSPECTION, MAINTENANCE, AND CLEANING	14
PARTS LISTS AND DIAGRAMS	15
Parts List/Diagram C - Circular Saw	15

UNPACKING

When unpacking, check to make sure all the parts shown on the **Parts Lists at the end of the manual** are included. If any parts are missing or broken, please call Harbor Freight Tools at the number shown on the cover of this manual as soon as possible.

Note: Before first use, the Battery (64) will require charging. The first charge requires **8 hours** charge time. See charging instructions on page 10.

PRODUCT SPECIFICATIONS

Item	Description
AC Charger Adapter	Input: 120 VAC / 60 Hz Output: 24 VDC, 400 mA Charge Time: 3 to 5 Hours; 8 Hour Initial Charge
Circular Saw	5 ³ / ₈ " Dia., 3/8" Arbor Blade; 0-2,500 No Load RPM; Safety Trigger; Adjustable Table with Fence
Accessories	1 Rechargeable 18 VDC Battery; Battery Charger/ Adapter

Save This Manual

You will need this manual for the safety warnings and precautions, assembly, operating, inspection, maintenance and cleaning procedures, parts list and assembly diagram. Keep your invoice with this manual. Write the invoice number on the inside of the front cover. Keep this manual and invoice in a safe and dry place for future reference.

GENERAL SAFETY RULES



READ AND UNDERSTAND ALL INSTRUCTIONS
Failure to follow all instructions listed below may result in
electric shock, fire, and/or serious injury.
SAVE THESE INSTRUCTIONS

Work Area

1. **Keep your work area clean and well lit.** Cluttered benches and dark areas invite accidents.
2. **Do not operate power tools in explosive atmospheres, such as in the presence of flammable liquids, gases, or dust.** Power tools create sparks which may ignite the dust or fumes.

3. **Keep bystanders, children, and visitors away while operating a power tool.** Distractions can cause you to lose control. Protect others in the work area from debris such as chips and sparks. Provide barriers or shields as needed. **Do not allow children to handle or play with these products.**

Electrical Safety

4. **Grounded tools must be plugged into an outlet properly installed and grounded in accordance with all codes and ordinances. Never remove the grounding prong or modify the plug in any way. Do not use any adapter plugs. Check with a qualified electrician if you are in doubt as to whether the outlet is properly grounded.** If the tools should electrically malfunction or break down, grounding provides a low resistance path to carry electricity away from the user.
5. **Double insulated tools are equipped with a polarized plug (one blade is wider than the other). This plug will fit in a polarized outlet only one way. If the plug does not fit fully in the outlet, reverse the plug. If it still does not fit, contact a qualified electrician to install a polarized outlet. Do not change the plug in any way.** Double insulation eliminates the need for the three wire grounded power cord and grounded power supply system.
6. **Avoid body contact with grounded surfaces such as pipes, radiators, ranges, and refrigerators.** There is an increased risk of electric shock if your body is grounded.
7. **Do not expose power tools to rain or wet conditions.** Water entering a power tool will increase the risk of electric shock.
8. **Do not abuse the Power Cord. Never use the Power Cord to carry the tools or pull the Plug from an outlet. Keep the Power Cord away from heat, oil, sharp edges, or moving parts. Replace damaged Power Cords immediately.** Damaged Power Cords increase the risk of electric shock.
9. **When operating a power tool outside, use an outdoor extension cord marked “W-A” or “W”.** These extension cords are rated for outdoor use, and reduce the risk of electric shock.

Personal Safety

10. **Stay alert. Watch what you are doing, and use common sense when operating a power tool. Do not use a power tool while tired or under the influence of drugs, alcohol, or medication.** A moment of inattention while operating power tools may result in serious personal injury.
11. **Dress properly. Do not wear loose clothing or jewelry. Contain long hair. Keep your hair, clothing, and gloves away from moving parts.** Loose clothes, jewelry, or long hair can be caught in moving parts.

12. **Avoid accidental starting. Be sure the Power Switch is off before plugging in.** Carrying power tools with your finger on the Power Switch, or plugging in power tools with the Power Switch on, invites accidents.
13. **Remove adjusting keys or wrenches before turning the power tool on.** A wrench or a key that is left attached to a rotating part of the power tool may result in personal injury.
14. **Do not overreach. Keep proper footing and balance at all times.** Proper footing and balance enables better control of the power tool in unexpected situations.
15. **Use safety equipment. Always wear eye protection.** Dust mask, nonskid safety shoes, hard hat, or hearing protection must be used for appropriate conditions. Always wear ANSI approved safety goggles and a dust mask/respirator when using or performing maintenance on this tool.

Tool Use and Care

16. **Use clamps (not included) or other practical ways to secure and support the workpiece to a stable platform.** Holding the work by hand or against your body is unstable and may lead to loss of control.
17. **Do not force the tool. Use the correct tool for your application.** The correct tool will do the job better and safer at the rate for which it is designed. Do not force the tool and do not use the tool for a purpose for which it is not intended. Do not modify this product.
18. **Do not use the power tool if the Power Switch does not turn it on or off.** Any tool that cannot be controlled with the Power Switch is dangerous and must be replaced.
19. **Disconnect the Power Cord Plug from the power source before making any adjustments, changing accessories, or storing the tool.** Such preventive safety measures reduce the risk of starting the tool accidentally. **Always unplug the tool from its electrical outlet before performing any inspection, maintenance, or cleaning procedures.**
20. **Store idle tools out of reach of children and other untrained persons.** Tools are dangerous in the hands of untrained users.
21. **Maintain tools with care. Keep cutting tools sharp and clean.** Properly maintained tools with a sharp cutting edge are less likely to bind and are easier to control. Do not use a damaged tool. Tag damaged tools "Do not use" until repaired.
22. **Check for misalignment or binding of moving parts, breakage of parts, and any other condition that may affect the tool's operation. If damaged, have the tool serviced before using.** Many accidents are caused by poorly maintained tools.

23. **Use only accessories that are recommended by the manufacturer for your model.** Accessories that may be suitable for one tool may become hazardous when used on another tool.

Service

24. **Tool service must be performed only by qualified repair personnel.** Service or maintenance performed by unqualified personnel could result in a risk of injury.
25. **When servicing a tool, use only identical replacement parts. Follow instructions in the “*Inspection, Maintenance, And Cleaning*” section of this manual.** Use of unauthorized parts or failure to follow maintenance instructions may create a risk of electric shock or injury.

Grounding

 **WARNING!**

Improperly connecting the grounding wire can result in the risk of electric shock. Check with a qualified electrician if you are in doubt as to whether the outlet is properly grounded. Do not modify the power cord plug provided with the tool. Never remove the grounding prong from the plug. Do not use the tool if the power cord or plug is damaged. If damaged, have it repaired by a service facility before use. If the plug will not fit the outlet, have a proper outlet installed by a qualified electrician.

Grounded Tools: Tools With Three Prong Plugs

1. Tools marked with “Grounding Required” have a three wire cord and three prong grounding plug. The plug must be connected to a properly grounded outlet. If the tool should electrically malfunction or break down, grounding provides a low resistance path to carry electricity away from the user, reducing the risk of electric shock. **(See Figure A.)**
2. The grounding prong in the plug is connected through the green wire inside the cord to the grounding system in the tool. The green wire in the cord must be the only wire connected to the tool’s grounding system and must never be attached to an electrically “live” terminal. **(See Figure A.)**

3. Your tool must be plugged into an appropriate outlet, properly installed and grounded in accordance with all codes and ordinances. The plug and outlet should look like those in the following illustration. **(See Figure A.)**

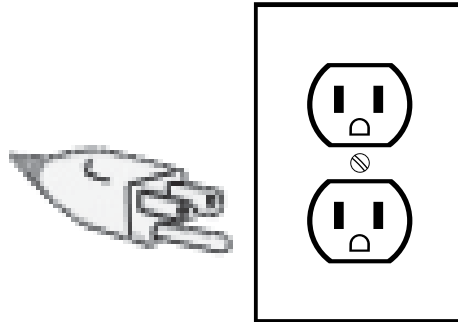

FIGURE A

Double Insulated Tools: Tools With Two Prong Plugs

4. Tools marked “Double Insulated” do not require grounding. They have a special double insulation system which satisfies OSHA requirements and complies with the applicable standards of Underwriters Laboratories, Inc., the Canadian Standard Association, and the National Electrical Code. **(See Figure B.)**
5. Double insulated tools may be used in either of the 120 volt outlets shown in the following illustration. **(See Figure B.)**

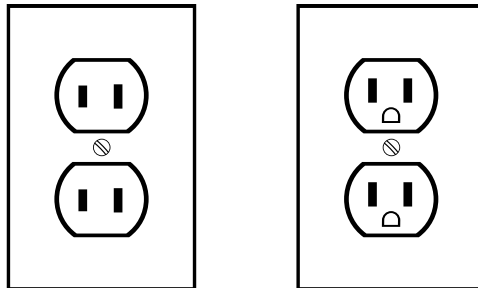

FIGURE B

Extension Cords







1. **Grounded** tools require a three wire extension cord. **Double Insulated** tools can use either a two or three wire extension cord.
2. As the distance from the supply outlet increases, you must use a heavier gauge extension cord. Using extension cords with inadequately sized wire causes a serious drop in voltage, resulting in loss of power and possible tool damage. **(See Figure C, next page.)**
3. The smaller the gauge number of the wire, the greater the capacity of the cord. For example, a 14 gauge cord can carry a higher current than a 16 gauge cord. **(See Figure C.)**

4. When using more than one extension cord to make up the total length, make sure each cord contains at least the minimum wire size required. **(See Figure C.)**
5. If you are using one extension cord for more than one tool, add the nameplate amperes and use the sum to determine the required minimum cord size. **(See Figure C.)**
6. If you are using an extension cord outdoors, make sure it is marked with the suffix "W-A" ("W" in Canada) to indicate it is acceptable for outdoor use.
7. Make sure your extension cord is properly wired and in good electrical condition. Always replace a damaged extension cord or have it repaired by a qualified electrician before using it.
8. Protect your extension cords from sharp objects, excessive heat, and damp or wet areas.



RECOMMENDED MINIMUM WIRE GAUGE FOR EXTENSION CORDS*					
NAMEPLATE AMPERES (At Full Load)	EXTENSION CORD LENGTH				
	25 Feet	50 Feet	75 Feet	100 Feet	150 Feet
0 - 2.0	18	18	18	18	16
2.1 - 3.4	18	18	18	16	14
3.5 - 5.0	18	18	16	14	12
5.1 - 7.0	18	16	14	12	12
7.1 - 12.0	18	14	12	10	-
12.1 - 16.0	14	12	10	-	-
16.1 - 20.0	12	10	-	-	-

FIGURE C * Based on limiting the line voltage drop to five volts at 150% of the rated amperes.

Symbology

	Double Insulated
	Canadian Standards Association
	Underwriters Laboratories, Inc.
	Volts Alternating Current
	Amperes
	No Load Revolutions per Minute (RPM)

Specific Safety Rules

1. **Maintain a safe working environment.** Make sure there is adequate surrounding workspace. Always keep the work area free of obstructions, grease, oil, trash, and other debris.
2. **Maintain labels and nameplates on this item.** These carry important information. If unreadable or missing, contact Harbor Freight Tools for a replacement.
3. **When using a handheld power tool, always maintain a firm grip on the tool with both hands.**
4. **To avoid electrical shock, do not pull or carry the AC Charger Adapter (63) by its Power Cord or pull the Power Cord around sharp corners or edges.** Do not unplug the AC Charger Adapter by pulling on the Power Cord. Keep the Power Cord away from heated surfaces.
5. **Never leave the AC Charger Adapter (63) unattended when it is plugged in.** Make sure to unplug the AC Charger Adapter from its outlet before leaving.
6. **Proper Battery Care:** Battery (64) leakage may occur under extreme usage or temperature conditions. If Battery fluid comes in contact with skin, wash with soap and water and rinse with lemon juice and vinegar. If the fluid comes in contact with eyes, flush with water for several minutes and contact a doctor immediately. Never burn the Battery, as it can explode in a fire. Do not attempt to charge a leaking Battery. Contact local solid waste authorities for instructions on correct disposal or recycling of the Battery.
7. **Store idle equipment.** When not in use, tools and equipment should be stored in a dry location to inhibit rust. Always lock up tools and equipment, and keep out of reach of children.
8. **Industrial applications must follow OSHA requirements.**
9.  **WARNING!** Some dust created by power sanding, sawing, grinding, drilling, and other construction activities, contain chemicals known (to the State of California) to cause cancer, birth defects or other reproductive harm. Some examples of these chemicals are: lead from lead-based paints, crystalline silica from bricks and cement or other masonry products, arsenic and chromium from chemically treated lumber. Your risk from these exposures varies, depending on how often you do this type of work. To reduce your exposure to these chemicals: work in a well ventilated area, and work with approved safety equipment, such as those dust masks that are specially designed to filter out microscopic particles. (California Health & Safety Code § 25249.5, *et seq.*)
10.  **WARNING!** People with pacemakers should consult their physician(s) before using this product. Electromagnetic fields in close proximity to a heart pacemaker could cause interference to or failure of the pacemaker.
11.  **WARNING!** The warnings, precautions, and instructions discussed in this manual cannot cover all possible conditions and situations that may occur. The operator must understand that common sense and caution are factors which cannot be built into this product, but must be supplied by the operator.

CHARGING THE BATTERY

Note: Always switch to a fresh battery when tool performance begins to diminish. Severe heat is most destructive to a battery; the more heat generated, the faster the battery loses power. A battery that gets too hot can be permanently damaged. Never over-discharge a battery by using the tool even after tool performance is decreasing. Never attempt to discharge a tool's battery by continuing to pull the tool trigger. **When tool performance begins to diminish, stop the tool, recharge the battery and use the fresh battery for optimal performance.**

1. When a Battery (64) requires recharging, a **3 to 5 hour*** charge allows the tool to operate at full power. Do not recharge the Battery longer than 5 hours*, as damage to the Battery and/or tool will occur.
2. To charge the Battery (64), plug the AC Charger Adapter's (63) plug into the Charger (62). Insert the Charger (62) onto the top of the Battery (64) until it locks into place. Charging room temperature: 50° F - 104° F. Then, plug the AC Charger Adapter into the nearest 120 Volt, grounded, electrical outlet. **(See illustration below.)**

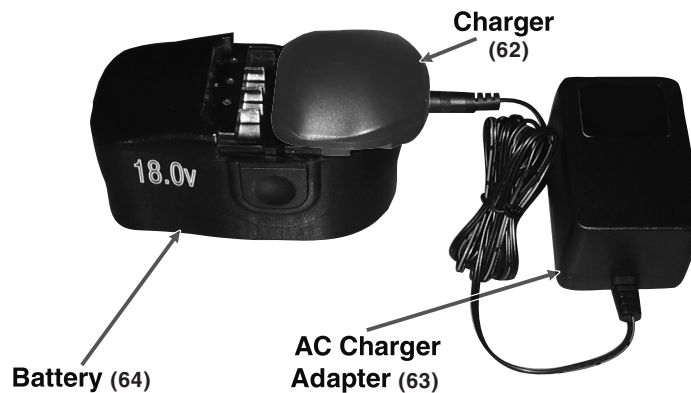

3. Two *Charging Indicator LEDs* on the Charger (62) will illuminate to show that charging is taking place. **NOTE:** The AC Charger Adapter (63) will **not** automatically turn off when the Battery is fully charged, and the Charging Indicator LEDs will remain on until the AC Charger Adapter is disconnected from the electrical outlet. Recharging the Battery more than **5 hours*** can cause damage to the battery cells.
4. While charging, the Battery (64), AC Charger Adapter (63), and/or Charger (62) may become warm to the touch. This is normal, and does not indicate a problem.
5. Once the Battery (64) is fully charged, disconnect the AC Charger Adapter (63) from the electrical outlet. Then, disconnect the Charger from the Battery.

* The Battery (64) require an initial charge time of 8 hours. Do not recharge the Battery more than 5 hours after this initial charging.

OPERATION

Note: For additional information regarding the parts listed in the following pages, refer to the **Assembly Diagrams at the end of the manual.**

Circular Saw

WARNING: Always make sure the Battery (64) of the Circular Saw is removed *prior* to making any adjustments to the tool, except for adjusting the depth of cut (required to install the battery).

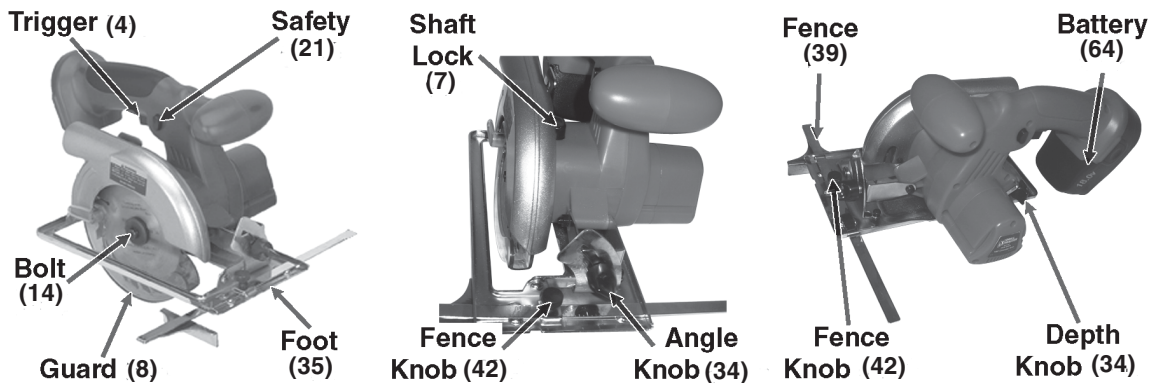

1. **Blade Installation:**

A. **Make certain that the Battery (64) is removed before proceeding.**

B. Remove the Hex Wrench (55) from its holder near the Depth Knob (34).

C. Press in and hold the Shaft Lock (7) while you loosen the Bolt (14). Remove the Bolt (14) and the Outer Flange (13).

D. Hold the Guard (8) open and slide the Blade (10) over and onto the shaft from the bottom. **Make certain that the arrow marked on the Blade (10) is facing the same direction as the arrow molded into the Fixed Guard (12).**

E. Replace the Outer Flange (13) lining up the flats in the Flange with the flats on the shaft.

F. Press in and hold the Shaft Lock (7) while you reinstall the Bolt (14) and securely tighten it. Return the Hex Wrench (55) to its holder.

2. The Fence (39) helps you cut multiple times at roughly the same distance.

To Adjust the Fence (39):

A. Loosen the Fence Knob (42).

B. Move the Fence as desired.

C. Retighten the Fence Knob securely.

3. **To Adjust the Angle of Cut:**
 - A. Loosen the Angle Knob (34).
 - B. Pivot the Saw body in relation to the Foot (35) to adjust the angle. Read the angle from the arrow and scale near the Angle Knob.
 - C. Retighten the Angle Knob (34) securely.
4. **To Adjust the Depth of Cut:**
 - A. **Be sure to keep your fingers well away from the Trigger (4), Safety (21), and Blade (10) while performing any adjustment, but especially when adjusting the Depth, because the battery may be installed.**
 - B. Loosen the Depth Knob (34).
 - C. Raise/lower the Saw body in relation to the Foot (35) to adjust the depth.
Note: Add $\frac{1}{8}$ " to the depth so the Saw Blade (10) can cut through the material cleanly.
 - D. Retighten the Depth Knob (34) securely.
5. Make certain that both halves of the workpiece are properly supported and secured in place. Also, make sure that the path you will be cutting along is free from all obstructions under/on the board and that there are no obstructions in the board itself (such as knots or hardware).

Keep your fingers AWAY from the Trigger (4) and Safety (21) until you are lined up with the board and ready to cut.
6. Adjust the depth of cut to the shallowest setting. Insert the fully charged Battery (64) in the Circular Saw's handle, and make sure it snaps into place on the handle. The depth of cut can now be adjusted to the desired setting for use.

7. **Causes and operator prevention of “kickback”:** Kickback is a sudden reaction to a pinched, bound, or misaligned Saw Blade (10), causing an uncontrolled Saw to lift up and out of the workpiece toward the operator. When the Saw Blade is pinched or bound tightly by the kerf (i.e. the slot that was cut) closing down, the Saw Blade stalls and the Motor reaction drives the tool rapidly toward the operator. If the Saw Blade becomes twisted or misaligned in the cut, the teeth at the back edge of the Saw Blade can dig into the top surface of the workpiece, causing the Saw Blade to climb out of the kerf and jump back toward the operator. **Kickback is a result of tool misuse and/or incorrect operating procedures or conditions and can be minimized by taking proper precautions as given below:**
- A. **Maintain a firm grip with both hands on the Saw, and position your body and arm to allow you to resist kickback forces.**
 - B. **When the Saw Blade (10) is binding, or when interrupting a cut for any reason, release the Trigger (4) and hold the Saw motionless in the workpiece until the Saw Blade comes to a complete stop.** Never attempt to remove the Saw from the workpiece or pull the Saw backward while the Saw Blade is in motion or kickback can occur.
 - C. **When restarting the Saw in the workpiece, center the Saw Blade (10) in the kerf and check that the saw teeth are not engaged into the workpiece.** If the Saw Blade is binding, it may walk up or kickback from the workpiece as the Saw is restarted.
 - D. **Support large panels to minimize the risk of Saw Blade pinching and kickback.** Large panels tend to sag under their own weight. Supports must be placed under the panel on both sides, near the line of cut and near the edge of the panel.
 - E. **Do not use a dull or damaged Saw Blade (10).** Unsharpened or improperly set Saw Blades produce a narrow kerf causing excessive friction, Saw Blade binding and kickback.
 - F. **Make sure all Saw adjustments are tight and secure before making a cut.** If Saw adjustments shift while cutting, it may cause binding and kickback.
 - G. **Use caution when making a pocket cut into existing walls.** The Saw Blade (10) may cut objects that can cause kickback. Always check to make sure there are no electrical wires or cables in the cutting path.
8. **Get in Position for and Perform the Cut:**
- A. Rest the front section of the Foot (35) on the edge of the workpiece. Line up the Saw Blade (10) with the line you will cut along.
 - B. Press the Safety (21) in and squeeze the Trigger (4). Allow the Saw Blade to rotate up to full speed before evenly moving the Saw along the cut. Do not force the saw, allow it to cut at its own pace.
9. Release the Trigger (4) and Safety (21) once the cut is completed. As a safety measure, remove the Battery (64) when work is completed.



INSPECTION, MAINTENANCE, AND CLEANING

1.  **WARNING!** Always remove the Battery Pack (64) from a tool and unplug the AC Charger Adapter (63) from its electrical outlet before performing any inspection, maintenance, or cleaning on the tool.
2. **BEFORE EACH USE**, inspect the general condition of the tool. Check for misalignment or binding of moving parts, cracked or broken parts, damaged wiring, and any other condition that may affect its safe operation. If abnormal noise or vibration occurs with a tool, have the problem corrected before further use. **Do not use damaged equipment.**
3. **TO CLEAN**, use a clean, slightly damp cloth to clean the outer surfaces of the tool. A mild detergent may be used. Do not use solvents. Do not immerse the tool, Battery, or AC Charger Adapter in water.
4. **WHEN STORING**, always keep the tool a clean, dry location out of reach of children. Keep charger unplugged from the wall outlet when not in use.

PLEASE READ THE FOLLOWING CAREFULLY

THE MANUFACTURER AND/OR DISTRIBUTOR HAS PROVIDED THE PARTS DIAGRAM IN THIS MANUAL AS A REFERENCE TOOL ONLY. NEITHER THE MANUFACTURER NOR DISTRIBUTOR MAKES ANY REPRESENTATION OR WARRANTY OF ANY KIND TO THE BUYER THAT HE OR SHE IS QUALIFIED TO MAKE ANY REPAIRS TO THE PRODUCT OR THAT HE OR SHE IS QUALIFIED TO REPLACE ANY PARTS OF THE PRODUCT. IN FACT, THE MANUFACTURER AND/OR DISTRIBUTOR EXPRESSLY STATES THAT ALL REPAIRS AND PARTS REPLACEMENTS SHOULD BE UNDERTAKEN BY CERTIFIED AND LICENSED TECHNICIANS AND NOT BY THE BUYER. THE BUYER ASSUMES ALL RISK AND LIABILITY ARISING OUT OF HIS OR HER REPAIRS TO THE ORIGINAL PRODUCT OR REPLACEMENT PARTS THERETO, OR ARISING OUT OF HIS OR HER INSTALLATION OF REPLACEMENT PARTS THERETO.

Parts List and Diagram - Circular Saw

Part	Description	Part	Description	Part	Description
1	Left Housing	22	Spring	42	Fence Knob
3	Heat Cover	23	Screw M5x10	43	Washer
4	Trigger	24	Inner Flange	44	Spring
5	Right Housing	25	Shaft Cover	45	Screw M3.5x16
6	Screw	26	Washer	46	Screw M4x72
7	Shaft Lock	27	Bearing	47	Terminal
8	Guard	28	Bushing	48	Screw M3x5
9	Guard Spring	29	Base	49	Red Wire
10	Saw Blade	30	Motor Gear	50	Black Wire
11	Spring Washer	31	Motor	51	Ferrite Bead
12	Fixed Guard	32	Motor Mount	52	Label
13	Outer Flange	33	Motor Housing	53	Rubber Post
14	Bolt	34	Knob	54	Screw
15	Rubber Stop	35	Foot	55	Hex Wrench
16	Screw M3x10	36	Receiver	56	Nut M4
17	Lock Pin	37	Foot Support	57	Spring Washer
18	Spring	38	Foot Pivot	58	Nut
19	Nut M5	39	Fence/Ruler	59	Nut M5
20	Screw	40	Bracket	60	Black Wire
21	Safety	41	Screw	61	Red Wire

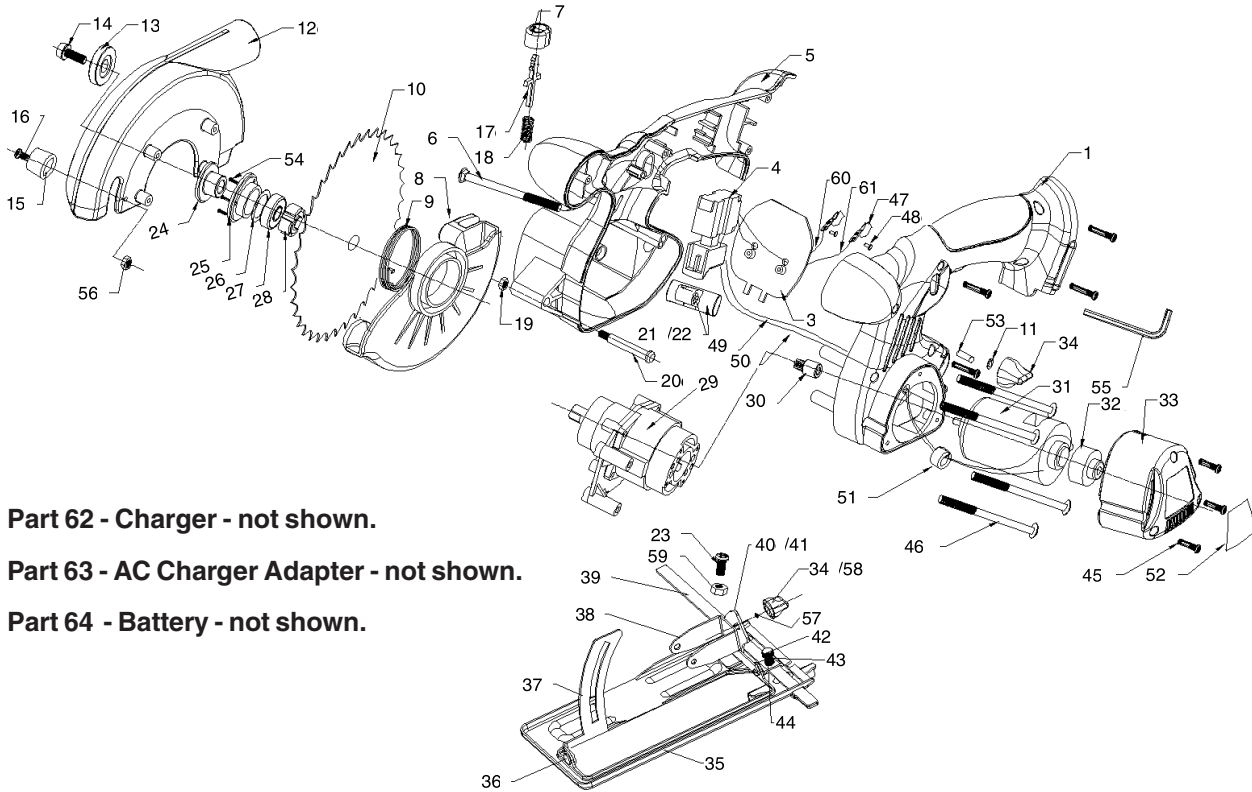

Part 62 - Charger - not shown.

Part 63 - AC Charger Adapter - not shown.

Part 64 - Battery - not shown.

NOTE: Some parts are listed and shown for illustration purposes only, and are not available individually as original or replacement parts.

Free Manuals Download Website

<http://myh66.com>

<http://usermanuals.us>

<http://www.somanuals.com>

<http://www.4manuals.cc>

<http://www.manual-lib.com>

<http://www.404manual.com>

<http://www.luxmanual.com>

<http://aubethermostatmanual.com>

Golf course search by state

<http://golfingnear.com>

Email search by domain

<http://emailbydomain.com>

Auto manuals search

<http://auto.somanuals.com>

TV manuals search

<http://tv.somanuals.com>