

**CENTRAL MACHINERY**

®

# **FOUR INCH BELT AND 6 INCH DISC SANDER**

**Model 93981**

## **ASSEMBLY AND OPERATING INSTRUCTIONS**

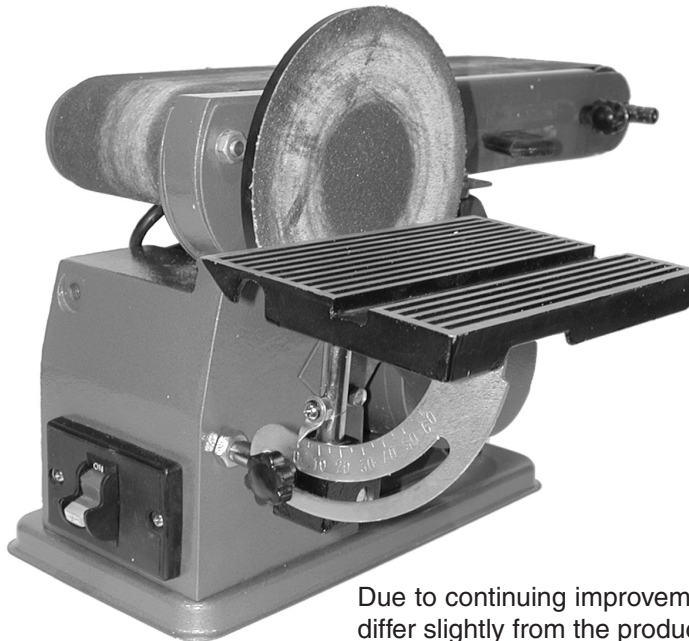

Due to continuing improvements, actual product may differ slightly from the product described herein.

**Distributed Exclusively by**



**HARBOR FREIGHT  
TOOLS**



®

3491 MISSION OAKS BLVD., CAMARILLO, CA 93011  
VISIT OUR WEB SITE AT [HTTP://WWW.HARBORFREIGHT.COM](http://www.harborfreight.com)

Copyright © 2006 by Harbor Freight Tools®. All rights reserved. No portion of this manual or any artwork contained herein may be reproduced in any shape or form without the express written consent of Harbor Freight Tools.

**For technical questions and replacement parts, please call 1-800-444-3353**

---

## SPECIFICATIONS

---

Power Requirement	120 VAC, 60 Hz
Motor	3/4 HP Input, 1/3 HP Output
Disc Speed	1780 RPM
Belt Speed	1150 FPM
Switch	Toggle with Safety Lock
Sanding Belt Size	4 (W) x 36 (L) inches, 80 grit
Sand Disc Size	6 inch diameter, 80 grit
Table Size	7-1/2 (W) x 5 (L) x 3/4 (D) inches
Table Tilt	0 ~ 60 degrees downward
Miter Gauge	5 x 3-1/4 x 1-5/8 (H) inches; 0 ~ 60 degree L/R
Overall Dimensions	24-3/4 (H) x 15 (W) x 14 (D) inches
Weight	37.5 lb.

---

## SAVE THIS MANUAL

---

You will need the manual for the safety warnings and precautions, assembly instructions, operating and maintenance procedures, parts list and diagram. Keep your invoice with this manual. Write the invoice number on the inside of the front cover. Keep the manual and invoice in a safe and dry place for future reference.

---

## GENERAL SAFETY RULES

---

 **WARNING!**

**READ AND UNDERSTAND ALL INSTRUCTIONS**  
**Failure to follow all instructions listed below may result in**  
**electric shock, fire, and/or serious injury.**  
**SAVE THESE INSTRUCTIONS**

### Work Area

1. **Keep your work area clean and well lit.** Cluttered benches and dark areas invite accidents.
2. **Do not operate power tools in explosive atmospheres, such as in the presence of flammable liquids, gases, or dust.** Power tools create sparks which may ignite the dust or fumes.
3. **Keep bystanders, children, and visitors away while operating a power tool.** Distractions can cause you to lose control. Protect others in the work area from debris such as chips and sparks. Provide barriers or shields as needed.

### Electrical Safety

1. **Avoid body contact with grounded surfaces such as pipes, radiators, ranges, and refrigerators.** There is an increased risk of electric shock if your body is grounded.
2. **Do not expose power tools to rain or wet conditions.** Water entering a power tool will increase the risk of electric shock.

REV 09/06

3. **Grounded tools must be plugged into an outlet properly installed and grounded in accordance with all codes and ordinances. Never remove the grounding prong or modify the plug in any way. Do not use any adapter plugs. Check with a qualified electrician if you are in doubt as to whether the outlet is properly grounded.** If the tools should electrically malfunction or break down, grounding provides a low resistance path to carry electricity away from the user.
4. **Double insulated tools are equipped with a polarized plug (one blade is wider than the other). This plug will fit in a polarized outlet only one way. If the plug does not fit fully in the outlet, reverse the plug. If it still does not fit, contact a qualified electrician to install a polarized outlet. Do not change the plug in any way.** Double insulation  eliminates the need for the three wire grounded power cord and grounded power supply system.
5. **Do not abuse the Power Cord. Never use the Power Cord to carry the tools or pull the Plug from an outlet. Keep the Power Cord away from heat, oil, sharp edges, or moving parts. Replace damaged Power Cords immediately.** Damaged Power Cords increase the risk of electric shock.
6. **When operating a power tool outside, use an outdoor extension cord marked “W-A” or “W”.** These extension cords are rated for outdoor use, and reduce the risk of electric shock.

### Personal Safety

1. **Stay alert. Watch what you are doing, and use common sense when operating a power tool. Do not use a power tool while tired or under the influence of drugs, alcohol, or medication.** A moment of inattention while operating power tools may result in serious personal injury.
2. **Dress properly. Do not wear loose clothing or jewelry. Contain long hair. Keep your hair, clothing, and gloves away from moving parts.** Loose clothes, jewelry, or long hair can be caught in moving parts.
3. **Avoid accidental starting. Be sure the Power Switch is off before plugging in.** Carrying power tools with your finger on the Power Switch, or plugging in power tools with the Power Switch on, invites accidents.
4. **Remove adjusting keys or wrenches before turning the power tool on.** A wrench or a key that is left attached to a rotating part of the power tool may result in personal injury.
5. **Do not overreach. Keep proper footing and balance at all times.** Proper footing and balance enables better control of the power tool in unexpected situations.
6. **Use safety equipment. Always wear eye protection.** Dust mask, non-skid safety shoes, hard hat, or hearing protection must be used for appropriate conditions.

## Tool Use and Care

1. **Use clamps (not included) or other practical ways to secure and support the workpiece to a stable platform.** Holding the work by hand or against your body is unstable and may lead to loss of control.
2. **Do not force the tool. Use the correct tool for your application.** The correct tool will do the job better and safer at the rate for which it is designed.
3. **Do not use the power tool if the Power Switch does not turn it on or off.** Any tool that cannot be controlled with the Power Switch is dangerous and must be replaced.
4. **Disconnect the Power Cord Plug from the power source before making any adjustments, changing accessories, or storing the tool.** Such preventive safety measures reduce the risk of starting the tool accidentally.
5. **Store idle tools out of reach of children and other untrained persons.** Tools are dangerous in the hands of untrained users.
6. **Maintain tools with care. Keep cutting tools sharp and clean.** Properly maintained tools with a sharp cutting edge are less likely to bind and are easier to control. Do not use a damaged tool. Tag damaged tools “Do not use” until repaired.
7. **Check for misalignment or binding of moving parts, breakage of parts, and any other condition that may affect the tool’s operation. If damaged, have the tool serviced before using.** Many accidents are caused by poorly maintained tools.
8. **Use only accessories that are recommended by the manufacturer for your model.** Accessories that may be suitable for one tool may become hazardous when used on another tool.

## Service



1. **Tool service must be performed only by qualified repair personnel.** Service or maintenance performed by unqualified personnel could result in a risk of injury.
2. **When servicing a tool, use only identical replacement parts. Follow instructions in the “*Inspection, Maintenance, And Cleaning*” section of this manual.** Use of unauthorized parts or failure to follow maintenance instructions may create a risk of electric shock or injury.

---

## **SPECIFIC SAFETY RULES FOR THIS PRODUCT**

---

1. **Maintain labels and nameplates on the Belt Sander.** These carry important information. If unreadable or missing, contact Harbor Freight Tools for a replacement.
2. **Always wear ANSI approved safety impact eye goggles and heavy work gloves when using the Belt Sander.** Using personal safety devices reduce the risk for injury. Safety impact eye goggles and work gloves are available from Harbor Freight Tools.

3. **Maintain a safe working environment.** Keep the work area well lit. Make sure there is adequate surrounding workspace. Always keep the work area free of obstructions, grease, oil, trash, and other debris. Do not use a power tool in areas near flammable chemicals, dusts, and vapors. Do not use this product in a damp or wet location.
4. **Avoid unintentional starting.** Make sure you are prepared to begin work before turning on the Belt Sander.
5. **Do not force the Belt Sander.** This tool will do the work better and safer at the speed and capacity for which it was designed.
6. **Always unplug the Belt Sander from its electrical outlet before performing any inspection, maintenance, or cleaning procedures.**
7. **Never leave the Belt Sander unattended while running.** Turn power off if you have to leave the Belt Sander.
8. **Before each use, check all nuts, bolts, and screws for tightness.** Vibration during mixing may cause these to loosen.
9. **Keep extension cord off the ground and away from water.**
10. **Always connect the Line Cord to a Ground Fault Circuit Interrupter (GFCI) protected electrical outlet.**
11. **Install this product on a proper surface.** Locate on a flat, level, and solid surface that is capable of supporting the weight of the Belt Sander.
12. **Always maintain a maximum of 1/16 inch clearance between the table and the sanding Disc.**
13. **Do not use the right side of the disc for sanding.** The material could kick back.
14. **Hold material securely while sanding to avoid kickback.**
15.  **WARNING!** Some dust created by power sanding, sawing, grinding, drilling, and other construction activities, contain chemicals known (to the State of California) to cause cancer, birth defects or other reproductive harm. Some examples of these chemicals are: lead from lead-based paints, crystalline silica from bricks and cement or other masonry products, arsenic and chromium from chemically treated lumber. Your risk from these exposures varies, depending on how often you do this type of work. To reduce your exposure to these chemicals: work in a well ventilated area, and work with approved safety equipment, such as those dust masks that are specially designed to filter out microscopic particles. (California Health & Safety Code § 25249.5, *et seq.*)
16.  **WARNING!** People with pacemakers should consult their physician(s) before using this product. Electromagnetic fields in close proximity to a heart pacemaker could cause interference to or failure of the pacemaker.

## GROUNDING

### WARNING!

Improperly connecting the grounding wire can result in the risk of electric shock. Check with a qualified electrician if you are in doubt as to whether the outlet is properly grounded. Do not modify the power cord plug provided with the tool. Never remove the grounding prong from the plug. Do not use the tool if the power cord or plug is damaged. If damaged, have it repaired by a service facility before use. If the plug will not fit the outlet, have a proper outlet installed by a qualified electrician.

### GROUNDING TOOLS: TOOLS WITH THREE PRONG PLUGS

1. Tools marked with “Grounding Required” have a three wire cord and three prong grounding plug. The plug must be connected to a properly grounded outlet. If the tool should electrically malfunction or break down, grounding provides a low resistance path to carry electricity away from the user, reducing the risk of electric shock. **(See Figure A.)**
2. The grounding prong in the plug is connected through the green wire inside the cord to the grounding system in the tool. The green wire in the cord must be the only wire connected to the tool’s grounding system and must never be attached to an electrically “live” terminal. **(See Figure A.)**
3. Your tool must be plugged into an appropriate outlet, properly installed and grounded in accordance with all codes and ordinances. The plug and outlet should look like those in the following illustration. **(See Figure A.)**

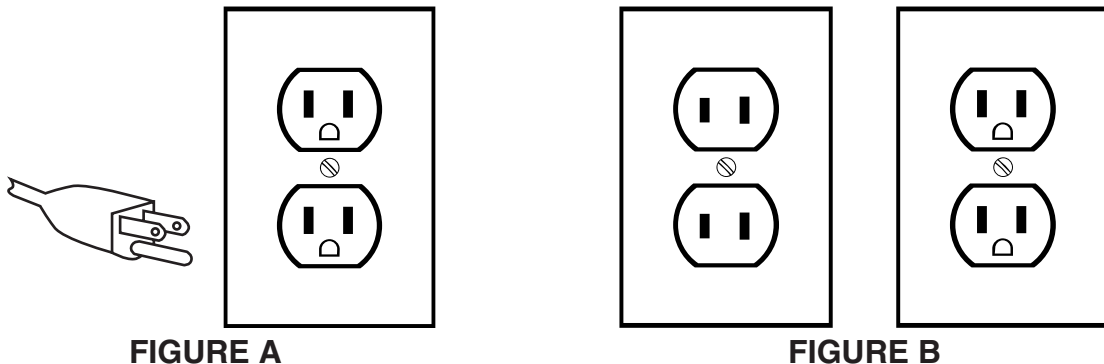

FIGURE A

FIGURE B

### DOUBLE INSULATED TOOLS: TOOLS WITH TWO PRONG PLUGS

1. Tools marked “Double Insulated” do not require grounding. They have a special double insulation system which satisfies OSHA requirements and complies with the applicable standards of Underwriters Laboratories, Inc., the Canadian Standard Association, and the National Electrical Code. **(See Figure B.)**

2. Double insulated tools may be used in either of the 120 volt outlets shown in the preceding illustration. **(See Figure B.)**

### EXTENSION CORDS



1. **Grounded** tools require a three wire extension cord. **Double Insulated** tools can use either a two or three wire extension cord.
2. As the distance from the supply outlet increases, you must use a heavier gauge extension cord. Using extension cords with inadequately sized wire causes a serious drop in voltage, resulting in loss of power and possible tool damage. **(See Table A, next page.)**
3. The smaller the gauge number of the wire, the greater the capacity of the cord. For example, a 14 gauge cord can carry a higher current than a 16 gauge cord. **(See Table A.)**
4. When using more than one extension cord to make up the total length, make sure each cord contains at least the minimum wire size required. **(See Table A.)**
5. If you are using one extension cord for more than one tool, add the nameplate amperes and use the sum to determine the required minimum cord size. **(See Table A.)**
6. If you are using an extension cord outdoors, make sure it is marked with the suffix "W-A" ("W" in Canada) to indicate it is acceptable for outdoor use.
7. Make sure your extension cord is properly wired and in good electrical condition. Always replace a damaged extension cord or have it repaired by a qualified electrician before using it.
8. Protect your extension cords from sharp objects, excessive heat, and damp or wet areas.

<b>RECOMMENDED MINIMUM WIRE GAUGE FOR EXTENSION CORDS*</b> <b>(120 OR 240 VOLT)</b>					
<b>NAMEPLATE AMPERES (at full load)</b>	<b>EXTENSION CORD LENGTH</b>				
	<b>25 Feet</b>	<b>50 Feet</b>	<b>75 Feet</b>	<b>100 Feet</b>	<b>150 Feet</b>
0 – 2.0	18	18	18	18	16
2.1 – 3.4	18	18	18	16	14
3.5 – 5.0	18	18	16	14	12
5.1 – 7.0	18	16	14	12	12
7.1 – 12.0	18	14	12	10	-
12.1 – 16.0	14	12	10	-	-
16.1 – 20.0	12	10	-	-	-

**Table A**      \* Based on limiting the line voltage drop to five volts at 150% of the rated amperes.



## SYMBOLOLOGY

	Double Insulated
	Canadian Standards Association
	Underwriters Laboratories, Inc.
$V \sim$	Volts Alternating Current
<b>A</b>	Amperes
$n_0$ xxxx/min.	No Load Revolutions per Minute (RPM)

---

## UNPACKING

---

When unpacking, check to make sure that all the parts are included. Refer to the Assembly section, and the Assembly Drawing and Parts List at the end of this manual. If any parts are missing or broken, please call Harbor Freight Tools at the number on the cover of this manual as soon as possible.

---

## ASSEMBLY INSTRUCTIONS

---

### Feet Placement

1. Carefully set the Belt Sander on its side.
2. Find four rubber Feet (45) in the parts bag.

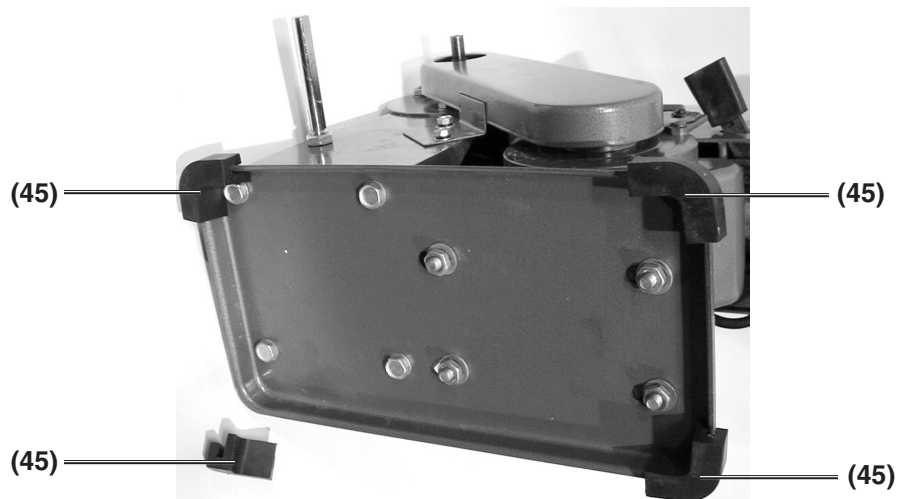

3. Press-fit each rubber Foot (45) over the lip of the Base (44) corner.
4. Using Wrench (70), check the tightness of all the Nuts and Bolts under the Base (44).



## Mounting Sanding Disc

1. Place the Belt Sander so that it is sitting on its feet.
2. On Disc (22), loosen the Set Screw (17) with a Hex Wrench (not supplied).
3. Slide the Disc all the way onto the Drive Shaft (6) so that the Set Screw (17) faces the flat surface on the Drive Shaft (6).

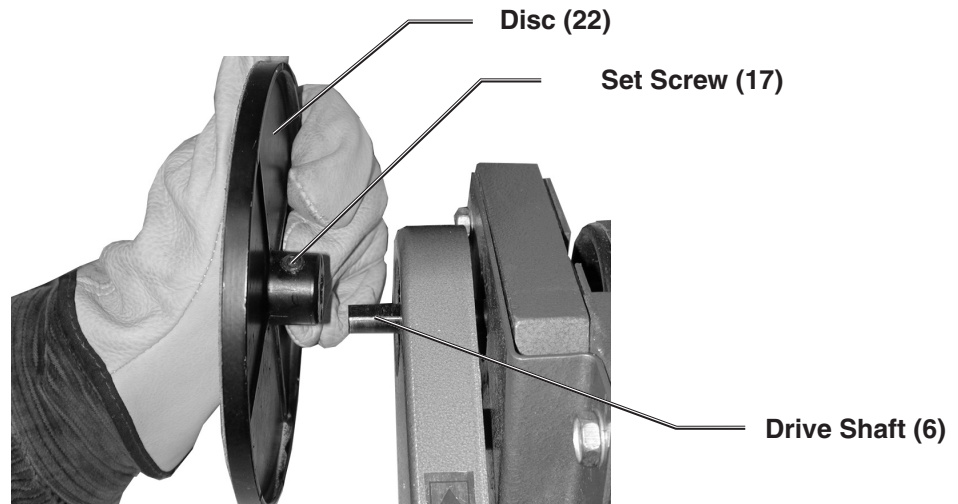

4. Securely tighten the Set Screw (17).

## Table Installation

1. Find the Table Bar (49) and insert one end into the mounting holes under the Table (59) as shown below, left.

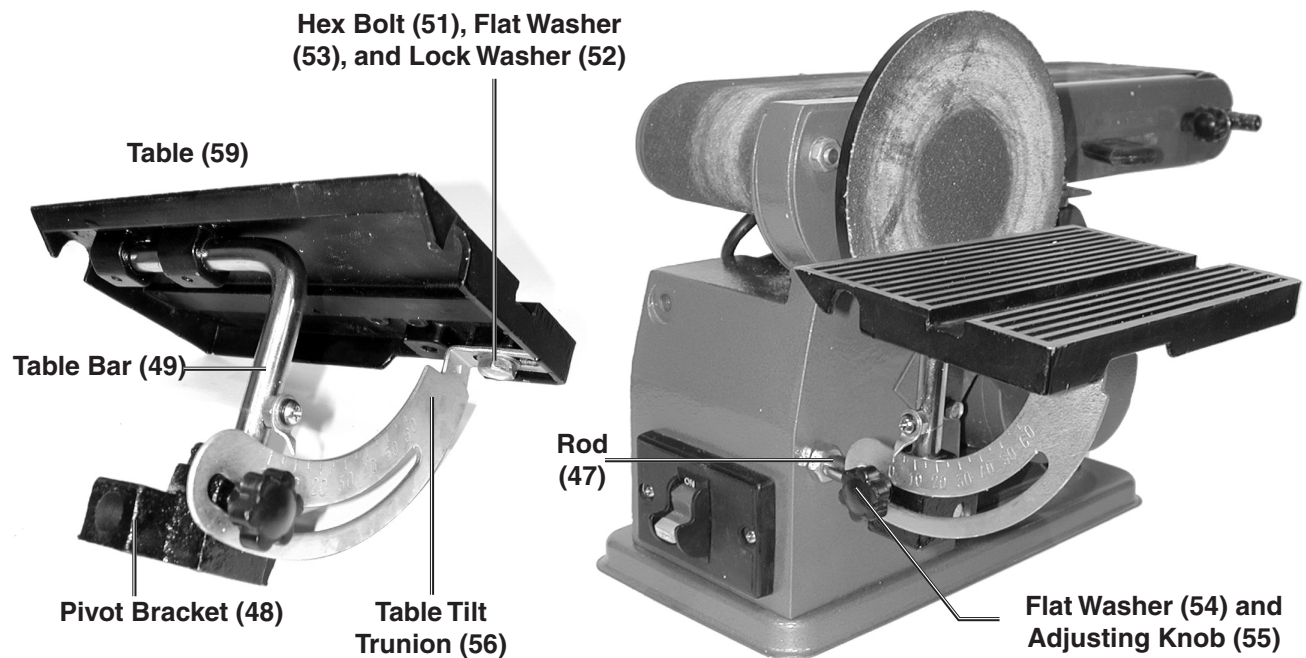

2. Insert the other end of the Table Bar (end with the angle Pointer #58) into the Pivot Bracket (48).

3. Mount the Table Tilt Trunion (56) to the Table (59) using Hex Bolt (51), Flat Washer (53), and Lock Washer (52). Securely tighten. See photos at the bottom of page 9.
4. Mount the other end of the Table Tilt Trunion (56) to the Pivot Bracket (48) using Flat Washer (54) and Adjusting Knob (55). Securely tighten.
5. Slide the Pivot Bracket (48) all the way onto the Rod (47) and tighten Set Screw (50).

### Mounting the Block Stop

1. Remove Disc (22) by loosening Set Screw (17) and pulling the Disc off.

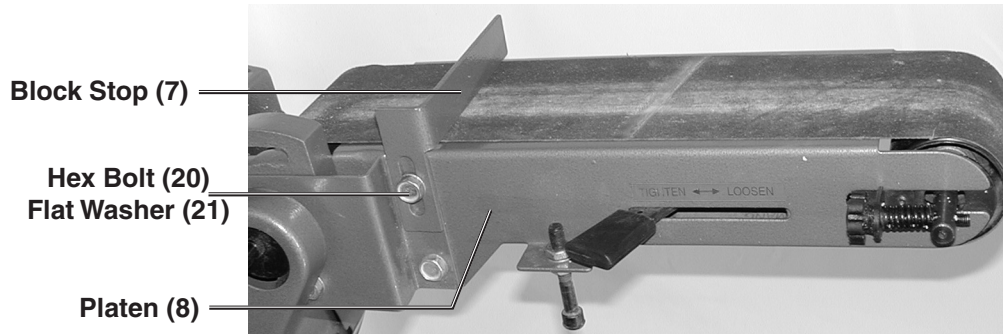

2. For sanding using the Belt (4), mount the Block Stop (7) to the Platen (8) using Hex Bolt (20) with Flat Washer (21). Securely tighten.

---

## OPERATING INSTRUCTIONS

---

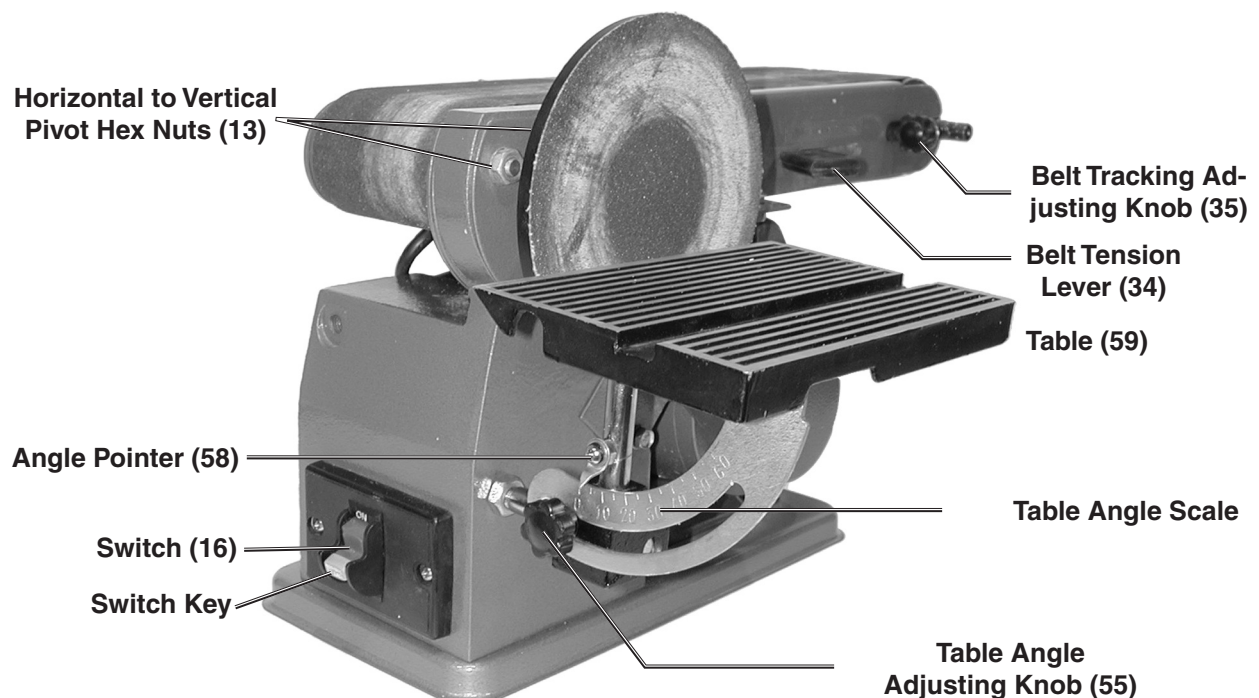

### Controls and Adjustments

## On / Off Switch

The locking On/Off Switch (16) needs to have the Switch Key inserted before the switch can be used. This feature prevents unauthorized use of the Belt Sander. The locking Switch operates as follows.

1. Insert plastic Switch Key into locking Switch (16).
2. Press the Switch to the On position to start.
3. Press the Switch to the Off position to stop.
4. To lock switch in Off position, pull out the key and store in a secure place.

**Caution: Never walk away from the Belt Sander when the machine is running. Always lock the switch in the Off position when not in use.**

## Sanding Safety Tips

1. Always maintain a maximum of 1/16 inch clearance between the table and the sanding Disc.
2. **CAUTION: Do not use the right side of the disc for sanding. The material could kickback.**
3. **Hold material securely while sanding to avoid kick back.**

## Leveling Table Assembly

During this and other procedures, refer to the photos on the previous page and the Assembly Drawing on the last page.

1. Place a combination square on the Table (59) so that it also touches the Sanding Disc (23). If the Table is 90 degrees to the Sanding Paper, the square is flush on the Pad.
2. If the Table is not 90 degrees with the Pad, loosen the Table Angle Adjusting Knob (55) and tilt the Table until the square is flush with the Pad.
3. Retighten the Knob to secure the table.
4. Loosen the angle Pointer (58) screw and adjust it so that it points to 90 degrees. Retighten screw.

## Adjusting the Sanding Belt Tracking

1. Turn the Belt Sander On.  
If the belt looks like it is going to slide off either roller, the belt tracking needs to be adjusted (described in the next step).
2. Turn the Belt Tracking Adjusting Knob (35) until the belt rides on the center of the Idle Roller (41) and Drive Drum (5).

## Adjusting the Sanding Belt for Vertical Operation

**Caution: Never make adjustments to the Belt Sander without first unplugging the line cord from the electrical outlet.**

1. Using a Wrench (70), loosen Hex Nuts (13) until the belt frame Platen (8) can be moved.
2. Push the Platen to the desired angle (0 to 90 degrees).

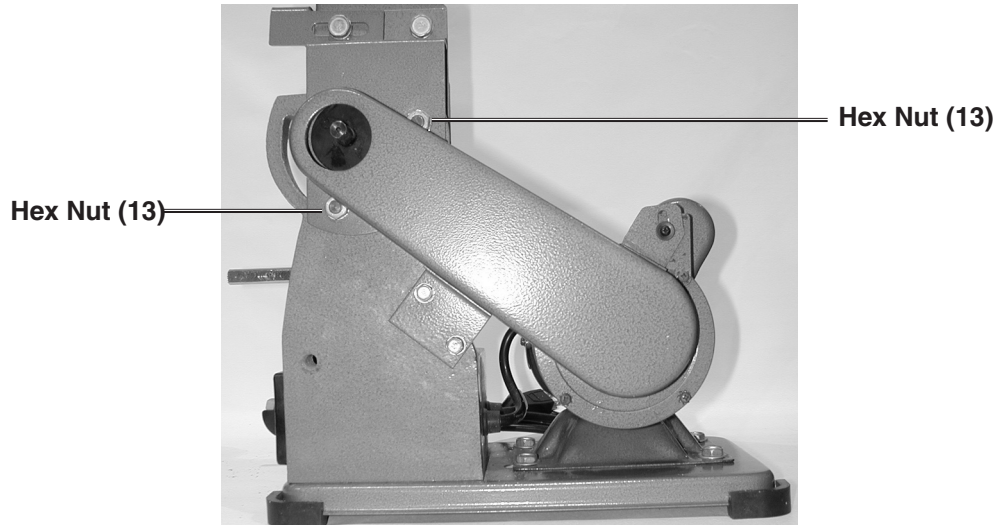

3. Retighten Hex Nuts (13).

---

## **INSPECTION, MAINTENANCE, AND CLEANING**

---

**⚠ WARNING! Make sure the Power Switch of the Belt Sander is in its “OFF” position and that the tool is unplugged from its electrical outlet before performing any inspection, maintenance, or cleaning procedures.**

1. Before each use, inspect the general condition of the Belt Sander. Check for loose screws, misalignment or binding of moving parts, cracked or broken parts, damaged electrical wiring, and any other condition that may affect its safe operation. If abnormal noise or vibration occurs, have the problem corrected before further use. Do not use damaged equipment.
2. Periodically recheck all nuts, bolts, and screws for tightness.
3. Cover and store in a clean and dry location.
4. Apply a light coat of paste wax to the worktable to make feeding stock easier.
5. Use compressed air to blow out dust and debris from sander and motor.
6. The bearings within are sealed and do not require lubrication.

## Mounting Sanding Disc

1. Remove Table (59) surrounding Sanding Disc (23).
2. Peel off old Sanding Disc.
3. Align perimeter of new Sanding Disc (23) over Aluminum Disc (22). When aligned, press disc firmly onto Disc.  
Most Sanding Discs have self-adhering properties. Others may require application of an appropriate glue (not supplied).
4. Replace Table (59).

## Sanding Belt Replacement

1. Push the Belt Tension Lever (34) to the right to loosen the Belt (4).
2. Slide the old Sanding Belt (4) off the Idler Roller (41) and Drive Drum (5).
3. Slide the new Sanding Belt (4) onto the Idler Roller (41) and Drive Drum (5).  
Refer to the Parts List for correct Belt (4) replacement size.
4. Push the Belt Tension Lever (34) to the left to tighten the Belt (4).
5. Turn on the Belt Sander to test the new Belt. If the Belt tracks to one side, go to page 11 and follow the procedure for Belt Tracking Adjustment.

---

## **TROUBLESHOOTING**

---

SYMPTOM	PROBABLE CAUSE	REMEDY
Belt Sander does not turn on	Not plugged in to electrical outlet	Connect to outlet
	Switch key not inserted into Switch	Insert Switch Key, then push Switch to On position
	GFCI or facility circuit breaker open	Reset circuit breakers
	Power Switch defective	Replace Switch
	Motor or wiring problem	Repair with a qualified technician
Motor slows when sanding	V-Belt too tight	A qualified technician needs to loosen tension
	Sanding with too much pressure on stock	Apply less pressure when sanding
Sanding Belt runs off Idler Roller	Not tracking properly	Adjust Sanding Belt Tracking
Wood burns while sanding	Sanding Disc or Belt is loaded with debris	Clean or replace Disc or Belt.
Sander makes excessive noise	V-Belt too tight	A qualified technician needs to loosen



## PARTS LIST

Part	Description	Qty.	Part	Description	Qty.
1	Bolt, Pan Head, 4x8mm	6	35	Adjusting Knob	1
1A	Washer, Lock, 4mm	6	36	Adjusting Spring	1
1B	Washer, Flat, 4mm	6	37	Block Plate	1
2	Bearing Plate II	1	38	Push Back Spring	1
3	Ball Bearing, 6201	2	39	Idler Roller Shaft	1
4	Belt, Sanding, 4"x36"	1	40	Ball Bearing, 6201	2
5	Drive, Drum	1	41	Idler Roller	1
6	Drive Shaft	1	41A	Screw, Round Head	1
7	Block Stop	1	42	Bolt, Hex, 8x16mm	8
8	Platen	1	43	Washer, Flat, 8mm	12
9	Screw with Set Square	2	44	Base	1
10	Bearing Plate I	1	45	Feet	4
11	Plate, Reinforcing	1	45A	Motor Pulley	1
12	Table Bracket	1	46	Nut, Hex, 10mm	1
13	Nut, Hex, 8mm	8	47	Rod	1
14	Horizontal Stop	1	48	Pivot Bracket	1
15	Strain Relief	2	49	Table Bar	1
16	Switch	1	50	Set Screw, 8x8mm	2
16A	Bolt, Pan Head, 5x12mm	3	51	Bolt, Hex, 8x10mm	2
16B	Washer, Lock, 5mm	1	52	Washer, Lock, 8mm	2
16C	Washer, Serrated, 5mm	1	53	Washer, Flat, 8mm	2
17	Set Screw, 6x6mm	3	54	Washer, Flat, 8mm	1
18	V-Belt	1	55	Adjusting Knob	1
19	Pulley, Drive	1	56	Table Tilt Trunion	1
20	Bolt, Hex, 8x12mm	2	57	Bolt, Pan Head, 5x10mm	1
21	Washer, Flat, 8mm	4	58	Pointer	1
22	Disc, Aluminum	1	59	Table	1
23	Disc, Sanding	1	60	Finger I	1
24	Bolt, Hex, 6x12mm	2	61	Washer, Lock, 4mm	1
25	Washer, Flat, 6mm	2	61A	Washer, Flat, 4mm	1
26	Bolt, Pan Head, 5x15mm	1	62	Bolt, Pan Head, 4x5mm	1
27	Washer, Flat, 5mm	1	63	Screw, Lock	1
28	Pulley Cover	1	64	Miter Gage	1
29	Pulley Cover Plate	1	65	Miter Bar	1
30	Washer, Flat, 5mm	1	66	Line Cord	1
31	Washer, Lock, 5mm	1	67	Washer, Lock, 4mm	4
32	Nut, Hex, 5mm	1	68	Washer, Flat, 4mm	4
33	Motor	1	69	Nut, Hex, 4mm	4
34	Tension Lever	1	70	Wrench	1

**NOTE:** Some parts are listed and shown for illustration purposes only and are not available individually as replacement parts.

### PLEASE READ THE FOLLOWING CAREFULLY

THE MANUFACTURER AND/OR DISTRIBUTOR HAS PROVIDED THE PARTS LIST AND ASSEMBLY DIAGRAM IN THIS MANUAL AS A REFERENCE TOOL ONLY. NEITHER THE MANUFACTURER OR DISTRIBUTOR MAKES ANY REPRESENTATION OR WARRANTY OF ANY KIND TO THE BUYER THAT HE OR SHE IS QUALIFIED TO MAKE ANY REPAIRS TO THE PRODUCT, OR THAT HE OR SHE IS QUALIFIED TO REPLACE ANY PARTS OF THE PRODUCT. IN FACT, THE MANUFACTURER AND/OR DISTRIBUTOR EXPRESSLY STATES THAT ALL REPAIRS AND PARTS REPLACEMENTS SHOULD BE UNDERTAKEN BY CERTIFIED AND LICENSED TECHNICIANS, AND NOT BY THE BUYER. THE BUYER ASSUMES ALL RISK AND LIABILITY ARISING OUT OF HIS OR HER REPAIRS TO THE ORIGINAL PRODUCT OR REPLACEMENT PARTS THERETO, OR ARISING OUT OF HIS OR HER INSTALLATION OF REPLACEMENT PARTS THERETO.

# ASSEMBLY DRAWING

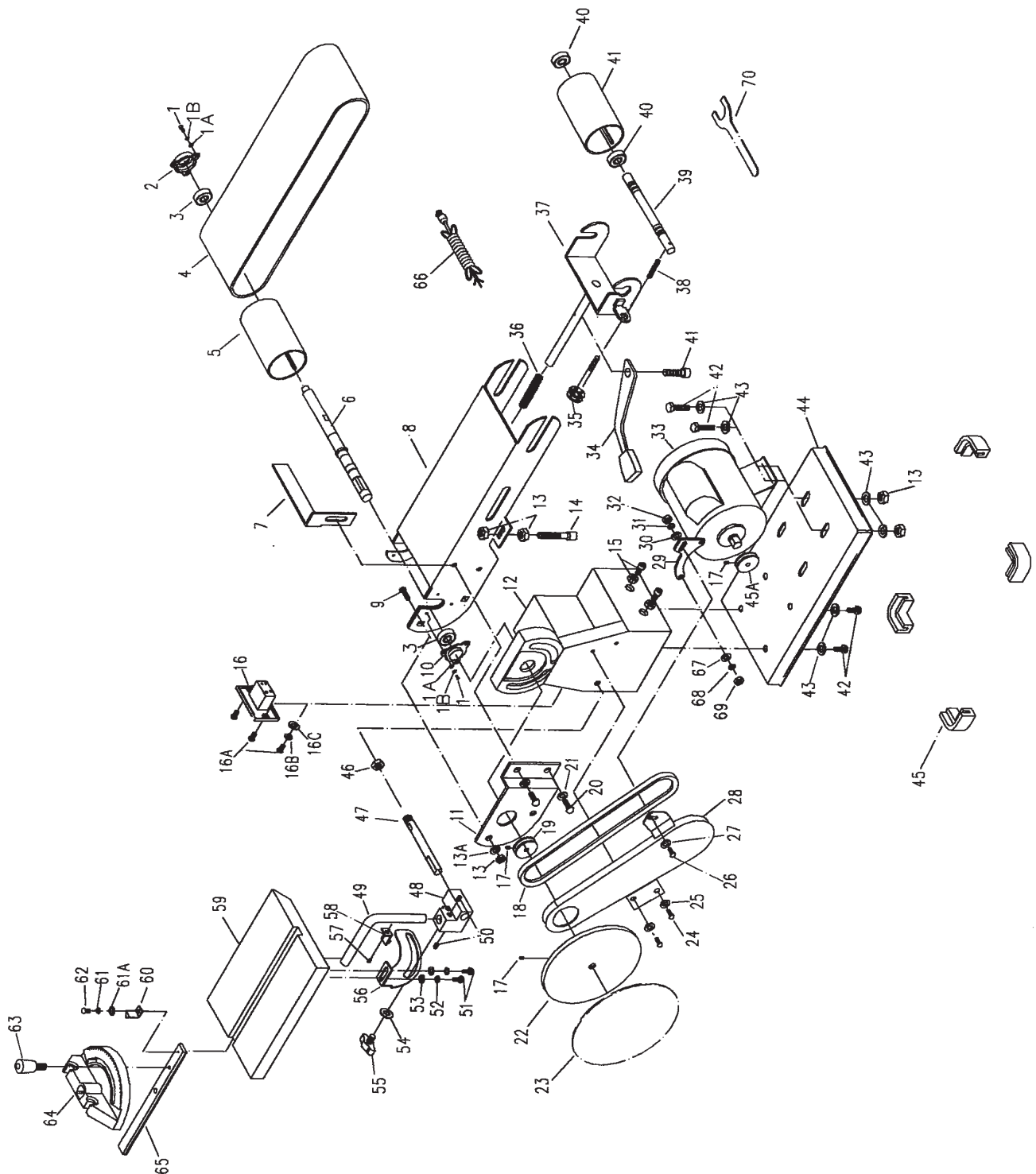

**Record Product's Serial Number Here:** \_\_\_\_\_

**Note:** If product has no serial number, record month and year of purchase instead.

**Note:** Some parts are listed and shown for illustration purposes only, and are not available individually as replacement parts.



## WARRANTY CARD

**CENTRAL MACHINERY**®

### **LIMITED 90 DAY/1 YEAR WARRANTY**

Harbor Freight Tools Co. makes every effort to assure that its products meet high quality and durability standards, and warrants to the original purchaser for a period of ninety days from date of purchase that the motor, the belts (if so equipped), and the blades (if so equipped) are free of defects in materials and workmanship. Harbor Freight Tools also warrants to the original purchaser, for a period of one year from date of purchase, that all other parts and components of the product are free from defects in materials and workmanship. This warranty does not apply to damage due directly or indirectly to misuse, abuse, negligence or accidents; repairs or alterations outside our facilities; or to lack of maintenance. We shall in no event be liable for death, injuries to persons or property, or for incidental, contingent, special or consequential damages arising from the use of our product. Some states do not allow the exclusion or limitation of incidental or consequential damages, so the above limitation of exclusion may not apply to you. THIS WARRANTY IS EXPRESSLY IN LIEU OF ALL OTHER WARRANTIES, EXPRESS OR IMPLIED, INCLUDING THE WARRANTIES OF MERCHANTABILITY AND FITNESS.

To take advantage of this warranty, the product or part must be returned to us with transportation charges prepaid. Proof of purchase date and an explanation of the complaint must accompany the merchandise. If our inspection verifies the defect, we will either repair or replace the product at our election or we may elect to refund the purchase price if we cannot readily and quickly provide you with a replacement. We will return repaired products at our expense, but if we determine there is no defect, or that the defect resulted from causes not within the scope of our warranty, then you must bear the cost of returning the product.

This warranty gives you specific legal rights and you may also have other rights which vary from state to state.

**3491 Mission Oaks Blvd. • PO Box 6009 • Camarillo, CA 93011 • (800) 444-3353**

## Free Manuals Download Website

<http://myh66.com>

<http://usermanuals.us>

<http://www.somanuals.com>

<http://www.4manuals.cc>

<http://www.manual-lib.com>

<http://www.404manual.com>

<http://www.luxmanual.com>

<http://aubethermostatmanual.com>

Golf course search by state

<http://golfingnear.com>

Email search by domain

<http://emailbydomain.com>

Auto manuals search

<http://auto.somanuals.com>

TV manuals search

<http://tv.somanuals.com>