



1600 PSI PRESSURE WASHER

Model 99741

SET UP AND OPERATING INSTRUCTIONS



Holster (10) not shown.

Distributed exclusively by Harbor Freight Tools®.

3491 Mission Oaks Blvd., Camarillo, CA 93011

Visit our website at: <http://www.harborfreight.com>



**Read this material before using this product.
Failure to do so can result in serious injury.
SAVE THIS MANUAL.**

Copyright© 2008 by Harbor Freight Tools®. All rights reserved. No portion of this manual or any artwork contained herein may be reproduced in any shape or form without the express written consent of Harbor Freight Tools. Diagrams within this manual may not be drawn proportionally. Due to continuing improvements, actual product may differ slightly from the product described herein. Tools required for assembly and service may not be included.

For technical questions or replacement parts, please call 1-800-444-3353.

CONTENTS	
IMPORTANT SAFETY INFORMATION	3
GENERAL PRESSURE WASHER SAFETY WARNINGS.....	3
SPECIFIC PRESSURE WASHER SAFETY WARNINGS.....	5
VIBRATION SAFETY	7
GROUNDING	8
SYMBOLGY.....	8
SPECIFICATIONS.....	9
UNPACKING	9
ASSEMBLY.....	9
CONTROLS AND SETUP.....	10
CONTROLS AND FEATURES	10
SETUP	11
OPERATION	12
OPERATING TIPS	14
BECOME FAMILIAR WITH YOUR MACHINE:	14
USE PROPER PRESSURE WASHER OPERATION TECHNIQUES:.....	14
CLEANING RECOMMENDATIONS .	14
INSPECTION, MAINTENANCE, AND CLEANING.....	16
LIMITED 1 YEAR / 90 DAY WARRANTY	17
PARTS LIST.....	18
ASSEMBLY DIAGRAM.....	19
TROUBLESHOOTING	20

SAVE THIS MANUAL

Keep this manual for the safety warnings and precautions, assembly, operating, inspection, maintenance and cleaning procedures. Write the product's serial number in the back of the manual near the assembly diagram (or month and year of purchase if product has no number). Keep this manual and the receipt in a safe and dry place for future reference.

IMPORTANT SAFETY INFORMATION

In this manual, on the labeling, and all other information provided with this product:



This is the safety alert symbol. It is used to alert you to potential personal injury hazards. Obey all safety messages that follow this symbol to avoid possible injury or death.

DANGER

DANGER indicates a hazardous situation which, if not avoided, will result in death or serious injury.

WARNING

WARNING indicates a hazardous situation which, if not avoided, could result in death or serious injury.

CAUTION

CAUTION, used with the safety alert symbol, indicates a hazardous situation which, if not avoided, could result in minor or moderate injury.

NOTICE

NOTICE is used to address practices not related to personal injury.

CAUTION

CAUTION, without the safety alert symbol, is used to address practices not related to personal injury.

General Pressure Washer Safety Warnings



WARNING Read all safety warnings and instructions. Failure to follow the warnings and instructions may result in electric shock, fire and/or serious injury. Save all warnings and instructions for future reference.

Work area safety

1. Keep work area clean and well lit. Cluttered or dark areas invite accidents.
2. Do not operate pressure washers in explosive atmospheres, such as in the presence of flammable liquids, gases or dust. Pressure washers create sparks which may ignite the dust or fumes.
3. Keep children and bystanders away while operating a pressure washer. Distractions can cause you to lose control.

Electrical safety

1. Pressure washer plugs must match the outlet. Never modify the plug in any way. Do not use any adapter plugs with grounded pressure washers. Unmodified plugs and match-

ing outlets will reduce risk of electric shock.

2. Avoid body contact with grounded surfaces such as pipes, radiators, ranges and refrigerators. There is an increased risk of electric shock if your body is grounded.
3. Do not expose pressure washers to rain or wet conditions. Water entering a pressure washer will increase the risk of electric shock.
4. Do not abuse the cord. Never use the cord for carrying, pulling or unplugging the pressure washer. Keep cord away from heat, oil, sharp edges or moving parts. Damaged or entangled cords increase the risk of electric shock.

5. **GFCI PRECAUTIONS**

Test GFCI (Ground Fault Circuit Interrupter) before each use as follows:

- a. Plug GFCI into power outlet and press reset button. Indicator should turn on.
- b. Press test button. Indicator should turn off.
- c. Press reset button again for use. Do not use if above test fails.

The GFCI device does not protect against electrical shock due to contact with both circuit conductors or a fault in any wiring supplying the GFCI device.

To allow GFCI unit to function properly, EXTENSION CORDS MUST NOT BE USED with this pressure washer.

Personal safety

1. Stay alert, watch what you are doing and use common sense when operating a pressure washer. Do not

use a pressure washer while you are tired or under the influence of drugs, alcohol or medication. A moment of inattention while operating pressure washers may result in serious personal injury.

2. Use personal protective equipment. Always wear eye protection and thick rubber boots. Safety equipment such as dust mask, non-skid safety shoes, hard hat, or hearing protection used for appropriate conditions will reduce personal injuries.
3. Prevent unintentional starting. Ensure the switch is in the off-position before connecting to power source and/or battery pack, picking up or carrying the equipment. Carrying pressure washers with your finger on the switch or energizing pressure washers that have the switch on invites accidents.
4. Do not overreach. Keep proper footing and balance at all times. This enables better control of the pressure washer in unexpected situations.
5. Dress properly. Do not wear loose clothing or jewelry. Keep your hair, clothing and gloves away from moving parts. Loose clothes, jewelry or long hair can be caught in moving parts.
6. Only use safety equipment that has been approved by an appropriate standards agency. Unapproved safety equipment may not provide adequate protection. Eye protection must be ANSI-approved for the specific hazards in the work area.

Pressure washer use and care

1. Do not use the pressure washer if the switch does not turn it on and off. Any pressure washer that cannot be controlled with the switch is dangerous and must be repaired.
2. Disconnect the plug from the power source before making any adjustments, changing accessories, or storing pressure washers. Such preventive safety measures reduce the risk of starting the pressure washer accidentally.
3. Store idle pressure washers out of the reach of children and do not allow persons unfamiliar with the pressure washer or these instructions to operate the pressure washer. Pressure washers are dangerous in the hands of untrained users.
4. Maintain pressure washers. Check for breakage of parts and any other condition that may affect the pressure washer's operation. If damaged, have the pressure washer repaired before use. Many accidents are caused by poorly maintained pressure washers.
5. Use the pressure washer, accessories etc. in accordance with these instructions, taking into account the working conditions and the work to be performed. Use of the pressure washer for operations different from those intended could result in a hazardous situation.

Service

Have your pressure washer serviced by a qualified repair person using only identical replacement parts. This

will ensure that the safety of the pressure washer is maintained.

Specific Pressure Washer Safety Warnings

1. Maintain labels and nameplates on the equipment. These carry important safety information. If unreadable or missing, contact Harbor Freight Tools for a replacement.
2. Risk of injection or severe injury. Keep clear of Nozzle. Do not direct discharge stream at people or animals. Keep the work area clear of all people and animals.
3. Use the right product for the right job. There are certain applications for which this product was designed. Do not use small equipment, tools, or attachments to do the work of larger industrial equipment, tools, or attachments. Do not use this product for a purpose for which it was not intended.
4. This product must continuously run with cold water only. Never use hot water. Dry running will cause serious damage to the seals. Make sure the water supply used for the Pressure Washer is not dirty, sandy, and does not contain any corrosive chemical products.
5. To avoid electrical shock, never start and run the Pressure Washer in the rain. Never allow water to leak inside the Body of the Pressure Washer. Do not direct discharge stream at the Pressure Washer itself or at other live electrical equipment.
6. Do not allow the GFCI Plug to become wet. Always place the GFCI

Plug in a dry location and as far away as possible from the object being sprayed. Keep all electrical connections dry and off the ground.

7. When using the Pressure Washer, always maintain a firm grip on the Water Gun with both hands. Squeezing the Trigger of the Water Gun causes a kickback force.
8. Do not pull or carry the Power Washer by its Power Cord, or pull the Cord around sharp corners or edges. Do not unplug the Power Washer by pulling on the Cord. Keep the Cord away from heated surfaces.
9. Do not handle the GFCI Plug with wet hands.
10. Avoid unintentional starting. Make sure you are prepared to begin work before turning on the Pressure Washer.
11. The work area should have adequate drainage to reduce the possibility of a fall due to slippery surfaces.
12. This Pressure Washer is intended for outdoor residential use only.
13. Some chemicals or detergents may be harmful if inhaled or ingested. Use an ANSI approved respirator or mask whenever there is a chance that vapors may be inhaled.
14. Keep the High Pressure Hose connected to the Pressure Washer and Spray Gun while the system is pressurized. Disconnecting the Pressure Hose while the unit is pressurized is dangerous, and may cause injury.
15. Prior to starting the Pressure Washer in cold weather, check all of the parts of the unit to make sure ice has not formed. Do not store the unit anywhere that the temperature will fall below 32° F (0° C). (See “Inspection, Maintenance, and Cleaning” section for proper storage procedures.)
16. Do not feed already-pressurized water (Such as that from another pressure washer) into this washer.
17. When dispensing detergent, apply the detergent to the cleaning area at low pressure only. Then, spray the detergent off the cleaning area by using the adjustable Nozzle. NOTICE: Detergent dispensing only works when the spray wand is in the low-pressure position.
18. The high pressure water flow can damage the work surface if not used properly. Always test the spray in an open area first.
19. Never move the Pressure Washer by pulling on the High Pressure Hose. Use the Handle provided on the top of the unit.
20. Never leave the Pressure Washer unattended when it is plugged into an electrical outlet. Turn off the Pressure Washer, and unplug it from its electrical outlet before leaving.
21. If water is leaking out of the Pressure Washer immediately shut off the unit. Unplug the Pressure Washer, and discharge all pressure before tightening fittings or having repair work done by a qualified technician.
22. People with pacemakers should consult their physician(s) before use. Electromagnetic fields in close proximity to heart pacemaker could cause

pacemaker interference or pacemaker failure.

23. **WARNING:** The brass components of this product contain lead, a chemical known to the State of California to cause birth defects (or other reproductive harm). (California Health & Safety code § 25249.5, et seq.)
24. **WARNING:** Handling the cord on this product will expose you to lead, a chemical known to the State of California to cause cancer, and birth defects or other reproductive harm. Wash hands after handling. (California Health & Safety Code § 25249.5, et seq.)
25. The warnings, precautions, and instructions discussed in this instruction manual cannot cover all possible conditions and situations that may occur. It must be understood by the operator that common sense and caution are factors which cannot be built into this product, but must be supplied by the operator.

Vibration Safety

This equipment vibrates during use. Repeated or long-term exposure to vibration may cause temporary or permanent physical injury, particularly to the hands, arms and shoulders. To reduce the risk of vibration-related injury:

1. Anyone using vibrating equipment regularly or for an extended period should first be examined by a doctor and then have regular medical check-ups to ensure medical problems are not being caused or worsened from use. Pregnant women or people who have impaired blood circulation to

the hand, past hand injuries, nervous system disorders, diabetes, or Raynaud's Disease should not use this piece of equipment. If you feel any medical or physical symptoms related to vibration (such as tingling, numbness, and white or blue fingers), seek medical advice as soon as possible.

2. Do not smoke during use. Nicotine reduces the blood supply to the hands and fingers, increasing the risk of vibration-related injury.
3. Wear suitable gloves to reduce the vibration effects on the user.
4. Use equipment with the lowest vibration when there is a choice between different processes.
5. Include vibration-free periods each day of work.
6. Grip gun as lightly as possible (while still keeping safe control of it). Let the equipment do the work.
7. To reduce vibration, maintain the equipment as explained in this manual. If any abnormal vibration occurs, stop use immediately.



SAVE THESE INSTRUCTIONS.

GROUNDING





⚠️ WARNING TO PREVENT ELECTRIC SHOCK



AND DEATH FROM INCORRECT GROUNDING WIRE CONNECTION:
 Check with a qualified electrician if you are in doubt as to whether the outlet is properly grounded. Do not modify the power cord plug provided with the equipment. Do not use the equipment if the power cord or plug is damaged. If damaged, have it repaired by a service facility before use. If the plug will not fit the outlet, have a proper outlet installed by a qualified electrician.

To allow GFCI unit to function properly, EXTENSION CORDS MUST NOT BE USED with this pressure washer.

Symbology

	Double Insulated
	Canadian Standards Association
	Underwriters Laboratories, Inc.
	Volts Alternating Current
	Amperes
n_0 xxxx/min.	No Load Revolutions per Minute (RPM)

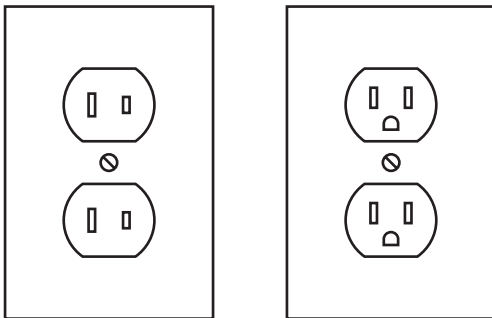

Outlets for 2-Prong Plug

1. Equipment marked “Double Insulated” does not require grounding. They have a special double insulation system which satisfies OSHA requirements and complies with the applicable standards of Underwriters Laboratories, Inc., the Canadian Standard Association, and the National Electrical Code.
2. Double insulated equipment may be used in either of the 120 volt outlets shown in the preceding illustration. **(See Outlets for 2-Prong Plug.)**

SPECIFICATIONS

Electrical Requirements	120 V / 60 Hz / 13 A 35 Ft. Long Power Cord
Water Pressure	1,600 PSI
Flow Rate	1.6 GPM
Water Supply Required	3-4 GPM minimum
Hose Length	19 Ft.



UNPACKING

When unpacking, check to make sure that the item is intact and undamaged. If any parts are missing or broken, please call Harbor Freight Tools at the number shown on the cover of this manual as soon as possible.

ASSEMBLY



Read the **ENTIRE IMPORTANT SAFETY INFORMATION** section at the beginning of this manual including all text under subheadings therein before set up or use of this product.

WARNING TO PREVENT SERIOUS INJURY

FROM ACCIDENTAL OPERATION:

Before performing any inspection, maintenance, or cleaning procedures:

- a. Turn the Power Switch of the equipment to its "OFF" position.
- b. Unplug the equipment from its electrical outlet.
- c. Shut off water supply.
- d. Safely discharge all residual water pressure.

e. Disconnect water supply hose.

Note: For additional information regarding the parts listed in the following pages, refer to the Assembly Diagram near the end of this manual.

1. Check the Inlet Strainer for any blockage, including packaging debris. The Pressure Washer may be shipped with a plastic plug in the Inlet.
2. Position the rear of the Handle above the rear of the Pressure Washer body. Connect the Suction Tube from the top of the Pressure Washer body to the connector on the bottom of the Detergent Bottle in the Handle. Make sure that the Suction tube does not bend or get pinched during assembly. Lower the Handle onto the Pressure Washer Body. Then secure the Handle to the Pressure Washer body, using the Screws provided.
3. Insert the Spray Wand into the Water Gun, and twist the Wand into the Extension until the Wand locks in place. Pull the Wand to make certain it is secure.
4. Attach the High Pressure Hose to the Outlet Port on the front of the Pressure Washer.
5. Attach the female part of the Quick Connector Set to the Supply Port on the back of the Pressure Washer. Attach the male part of the Quick Connector Set to a heavy-duty garden hose (not included). Then, pull back on the collar on the Female quick connector and insert the male Quick Connector.

CONTROLS AND SETUP

Note: Familiarize yourself with the location and function of all of the machine's controls before proceeding to setup of the machine.

Controls and features

1. This item is equipped with a GFCI (Ground Fault Circuit Interruption) plug. Read and follow these GFCI precautions:

WARNING! TO PREVENT ELECTRIC SHOCK AND DEATH: Test GFCI (Ground Fault Circuit Interrupter) before each use as follows:

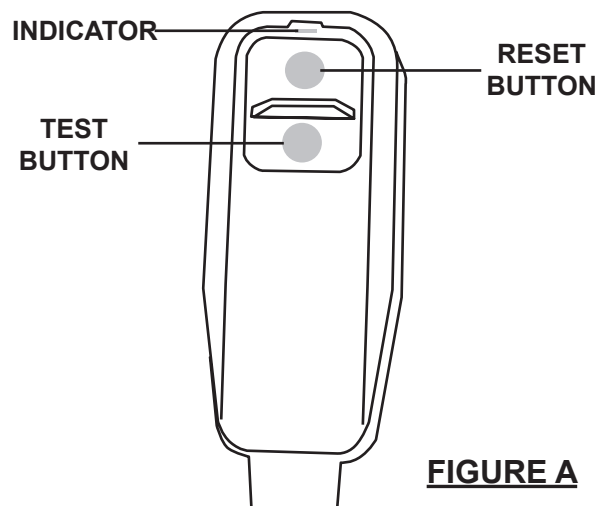

FIGURE A

- a. Make sure the trigger is released and plug GFCI into power outlet. Press reset button. Indicator should turn on.
- b. Press test button. Indicator should turn off.
- c. Press reset button again for use. Do not use if above test fails.

The GFCI device does not protect against electrical shock due to contact with both circuit conduc-

tors or a fault in any wiring supplying this device.

Should replacement of the GFCI Power Plug become necessary, only a qualified technician should perform the service.

Do not alter or disable the GFCI Power Plug.

To allow GFCI unit to function properly, extension cords must not be used with this pressure washer.

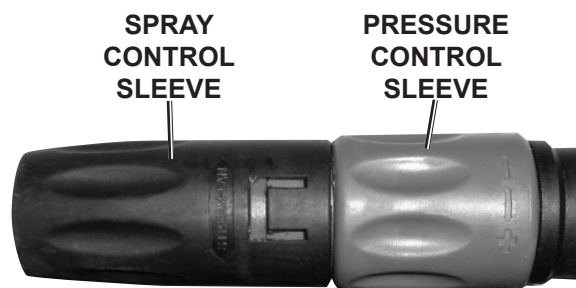

FIGURE B

2. The Spray Control Sleeve on the Spray Wand can be rotated for a range of spray patterns, from a full fan spray to a direct stream spray. Also, the Pressure Control Sleeve can be rotated clockwise for low-pressure spray and detergent application, or rotated counterclockwise for normal high-pressure spray.
3. The built-in Detergent Bottle located in the Handle allows the application (USING THE LOW PRESSURE SETTING ONLY) of pressure washing detergent (not included) onto the work surface. The Pressure Washer will automatically mix the detergent and water. Note: Do not add water to the Detergent Dispenser.

CAUTION! NEVER use any products not designed for pressure washer use, nor any products with chlorine or any caustic materials, including liquids containing solvents, trisodium phosphate products, ammonia, or acid-based cleaners.

Fill the Detergent Dispenser *only* when the unit is *not* running or plugged in.

Setup

1. CHECK THE WATER SUPPLY. Prior to using the Pressure Washer for the first time, it is ESSENTIAL to verify that the water supply is adequate. The Pressure Washer needs TWICE the water supply (or volume) than the stated water output (1.6 GPM). This Pressure Washer will need about 3-4 GPM to operate correctly and efficiently. If the water is being supplied by a well/pump, make certain that the well/pump produces enough water to keep up with the Pressure Washer's water demands. Water supply hoses should be heavy duty to withstand the forces involved. Water hoses up to 25' long must be $\frac{5}{8}$ " ID. Water hoses up to 50' long must be $\frac{3}{4}$ " ID. Do not use hoses longer than 50'. The more minerals in the water (the harder the water) you use, the more often mineral buildup will need to be cleaned out from the nozzles.
Flow rate of the water supply must never be allowed to fall below 3 GPM.
To determine the water supply's flow rate: Run the water at full for one minute into a 5 gallon container, and measure the amount of water in the container.

CAUTION! If the Pressure Washer is run with an inadequate water supply, the

pump will cavitate. Cavitation causes the pump to operate loudly and will damage it.

2. ARRANGE FOR A PROPER ELECTRICAL SUPPLY. This unit uses a large amount of current, especially during start-up. Turn off power switch, then connect this unit only to a dedicated household circuit capable of providing ample current to it. A dedicated circuit has no additional loads (running devices) connected to it; shut off any appliances that slow down or lights that dim while the washer is running. For best results, connect the plug to that circuit's outlet that is nearest to the circuit breaker panel.
3. MAKE SURE THE WASHER IS CLEAN AND READY FOR USE. Ensure the inlet water strainer, nozzle, and the rest of the Washer are completely free of buildup or debris.
4. PLAN OUT THE JOB: Plan out what areas will be cleaned, how many sessions will be necessary, and how long the individual sessions of work will need to be. Plan to clean the higher portions first, because the higher portions will typically remain cleaner while the other areas are cleaned. Plan a safe direction for runoff to flow while the job is being performed, and plan on working your way in that direction. You will have a clearer idea of the time involved to clean the area after doing a test run, as explained on page 14.

5. **PREPARE THE CLEANING AREA.**
Clear the cleaning area of all objects that are not being cleaned. If any water prone or delicate items cannot be moved, protect them. If detergent is to be used, cover or remove any plants or animals that may be damaged by the detergent.
6. **PLACE THE PRESSURE WASHER IN AN APPROPRIATE LOCATION.**
The location should be protected

from any water from the cleaning area; select a location higher than the cleaning area. The pressure washer's location should be close enough so that the hose will reach every portion of the job to be done with some slack for movement. Also, select an area with proper access to a dedicated circuit.

OPERATION



Read the **ENTIRE IMPORTANT SAFETY INFORMATION** section at the beginning of this manual including all text under subheadings therein before set up or use of this product.



TO PREVENT SERIOUS INJURY

FROM ACCIDENTAL OPERATION:

Turn the Power Switch of the equipment to its "OFF" position before performing any inspection, maintenance, or cleaning procedures.

1. Attach the High Pressure Hose to the Port on the front of the Pressure Washer.
2. Attach the Water Gun into the Water Gun, and press and twist the Wand into the Extension until the Wand locks in place.
NOTE: The Pressure Washer will not pressurize if the Nozzle is not completely assembled. It will not work

properly with only part of the Wand installed.

3. Connect the High Pressure Hose to the Pressure Washer. Make sure all connections are tight. Then, open the water supply valve **fully**. If leaks occur, shut off water and retighten connections.
4. **IMPORTANT! Prior to turning on the Pressure Washer, connect the unit to the water supply. Turn on the water, disengage the safety, and squeeze the Trigger until water flows out of the Water Gun.** This removes air from the system and allows the unit to properly perform. **Failure to follow this step can damage the Pump.**
5. Connect the GFCI plug and test it, as explained on page 10. Turn the Power Switch to the "ON" position. **The motor will briefly run when the switch is first turned on to build up pressure** and then go to standby until the trigger is squeezed.
NOTE: The Motor does not run continuously, but only when the Trigger is

squeezed. **If a humming noise persists while the motor is on standby, briefly discharge the nozzle in a safe direction.**

6. Point the Nozzle in a safe direction and squeeze the Trigger. Switch the unit's switch to the OFF position whenever the gun is not in use. Clean the area, following the tips contained in the Operating Tips section.
7. When finished spraying turn the Power Switch to its "OFF" position, and turn off the water supply.
WARNING: Do not disconnect the high-pressure hose or water inlet hose until all pressure is discharged safely.
8. **IMPORTANT!** When turning off the unit after use, high pressure will

remain inside the unit, its High Pressure Hose, and the water inlet hose. Point the Water Gun in a safe direction and discharge all remaining pressure. The high-pressure hose and water inlet hose can be disconnected after the pressure is released.

9. Store the pressure washer and all accessories according to the directions under *Storage* on page 16.

IF ANY UNEXPECTED PROBLEMS ARISE, PLEASE REFER TO THE TROUBLESHOOTING SECTION AT THE END OF THIS MANUAL.

OPERATING TIPS

Become Familiar With your Machine:

1. Before beginning work, set aside enough time to familiarize yourself with this machine's cleaning rate and capacity along with all instructions and precautions contained in this section, along with the Operating Instruction and Operating Controls sections.
2. This unit is intended for various light to moderate cleaning applications. If deeper cleaning is desired, it can be attained at times, however this is done at the expense of speed. This unit is not intended for paint stripping or deep concrete cleaning applications.
3. Clean a test area to satisfaction before proceeding with the entire area, as stated in Cleaning Recommendations.
4. This unit has several settings and adjustments that effect the speed of cleaning and the water force applied to cleaning. Good guidelines to keep in mind are:

**WIDE STREAM =
QUICKER COVERAGE BUT
LIGHTER CLEANING.**

**NARROW STREAM =
DEEPER CLEANING BUT
SLOWER COVERAGE.**

Use Proper Pressure Washer Operation Techniques:

The machine may suddenly stop and require a rest period from time to time; **this is normal and does not indicate a problem** (See Troubleshooting, page 20). However, certain operating techniques may help reduce or even prevent the need for such rest periods, increasing efficiency:

- a. Do not release the trigger between sweeps. Release the trigger as few times as possible during use. Interrupted or sporadic spraying will cause the unit to heat up quickly and will increase the need for rest periods.
- b. Make sure that all obstacles have been moved and the entire area is ready before starting.
- c. For small jobs, try to finish an entire portion of the job before taking a break.

Cleaning Recommendations

1. Clean an inconspicuous test area to help avoid damaging the surface: Always begin with the fan spray at a distance of about 3-5 feet from the surface being cleaned to avoid damaging the surface of the object. Clear the test area of people and water-sensitive objects. If a pressure washing detergent is to be used, apply the detergent to this area as well. After cleaning this area, switch off the pressure washer and inspect the area carefully for any damage or discoloration. If any damage is noted from the pressure setting, use a lighter setting when cleaning the rest of the area. If damage or discoloration is

- noted from the detergent, do not use it when cleaning.
2. First, pass over the area with a light cleaning, and then more thoroughly clean it.
 - 3a. **For a vertical or sloped surface:**
 - a. Wash from the top down.
 - b. If possible, direct the stream in the same direction as the slope towards a draining area. This will enable better drainage and therefore better cleaning.
 - 3b. **For a flat surface:**
 - a. If a thin layer of water accumulates on the surface, periodically use the stream to direct this water towards the drainage.
 - b. After the major cleaning is done, sweep the surface with the stream to help direct loose debris toward the drainage.
 4. If detergent is to be applied: Only use pressure washing detergent; other detergents will clog or damage the pressure washer. Apply the detergent at low pressure, by using the low pressure setting of the Spray Wand. Allow the detergent several minutes to sit and soak into the work surface; this will improve cleaning efficiency. Briefly shut off the unit and turn the Pressure Control Sleeve counter-clockwise to switch to high pressure mode and automatically shut off the soap dispenser for rinsing. Rinse off all detergent completely.
 5. Hold the Water Gun at about a 45° angle and steadily sweep the stream back and forth; if a severe, head-on angle is used, dirt may imbed in the surface being cleaned. Follow a steady, consistent pace during cleaning; this will help prevent stripes or discoloration afterwards. If streaking or uneven cleaning is noted at the end of a project, go over the edges of the streaks with a wide fan pattern to help blend these lighter areas in.
 6. If several different surfaces are to be cleaned, be careful not to damage any of the less solid surfaces while trying to clean the harder ones. This is especially a concern when cleaning tile and grout, bricks and mortar, or stones and mortar.
 7. If wood is being cleaned, be careful not to damage it. Wood will usually require resurfacing (Sanding) and re-coat with a surface protectant (wood, stain, varnish) after it has dried. Try to avoid leaving water on a wooden surface; doing so can harm the surface.

INSPECTION, MAINTENANCE, AND CLEANING



Procedures not specifically explained in this manual must be performed only by a qualified technician.

⚠️ WARNING

TO PREVENT SERIOUS INJURY

FROM ACCIDENTAL OPERATION:

Before performing any inspection, maintenance, or cleaning procedures:

- a. Turn the Power Switch of the equipment to its “OFF” position.
- b. Unplug the equipment from its electrical outlet.
- c. Shut off water supply.
- d. Safely discharge all residual water pressure.
- e. Disconnect water supply hose.

TO PREVENT SERIOUS INJURY FROM PRESSURE WASHER FAILURE:

Do not use damaged equipment. If abnormal noise or vibration occurs, have the problem corrected before further use.

1. **Before each use**, inspect the general condition of the Pressure Washer. Check for loose screws, misalignment or binding of moving parts, damaged electrical wiring, damaged High Pressure Hose, damaged accessories, and any other condition that may affect its safe operation. If abnormal noise or vibration occurs, have the problem corrected before

further use. **Do not use damaged equipment.**

2. **To clean**, remove excess water from the Pump by tipping the unit to drain any remaining water from the inlet and outlet fittings. Drain the Detergent Dispenser and flush with running water. Use only a clean cloth and mild detergent to clean the body of the Pressure Washer. Do not use solvents. Do not immerse any part of the tool in liquid. Dry off any remaining water on all parts and fittings. Remove mineral deposits from the nozzle using a thin, stiff wire. The more minerals that are dissolved in the water (the harder the water) you use, the more often mineral buildup will need to be cleaned out from inside nozzle.
3. **STORAGE:** When storing, empty the Pressure Washer of water. Frost will damage the Pressure Washer if the unit contains water. Store the Pressure Washer in a dry, frost-free room. Flush the unit with automotive antifreeze prior to long-term storage. Dispose of antifreeze according to local ordinances.
4. **⚠️ WARNING!** If the supply cord or plug of this pressure washer is damaged, it must be replaced only by a qualified service technician.

LIMITED 1 YEAR / 90 DAY WARRANTY

Harbor Freight Tools Co. makes every effort to assure that its products meet high quality and durability standards, and warrants to the original purchaser that for a period of ninety days from date of purchase that the engine/motor, the belts (if so equipped), and the blades (if so equipped) are free of defects in materials and workmanship. Harbor Freight Tools also warrants to the original purchaser, for a period of one year from date of purchase, that all other parts and components of the product are free from defects in materials and workmanship (90 days if used by a professional contractor or if used as rental equipment). This warranty does not apply to damage due directly or indirectly, to misuse, abuse, negligence or accidents, repairs or alterations outside our facilities, normal wear and tear, or to lack of maintenance. We shall in no event be liable for death, injuries to persons or property, or for incidental, contingent, special or consequential damages arising from the use of our product. Some states do not allow the exclusion or limitation of incidental or consequential damages, so the above limitation of exclusion may not apply to you. THIS WARRANTY IS EXPRESSLY IN LIEU OF ALL OTHER WARRANTIES, EXPRESS OR IMPLIED, INCLUDING THE WARRANTIES OF MERCHANTABILITY AND FITNESS.

To take advantage of this warranty, the product or part must be returned to us with transportation charges prepaid. Proof of purchase date and an explanation of the complaint must accompany the merchandise. If our inspection verifies the defect, we will either repair or replace the product at our election or we may elect to refund the purchase price if we cannot readily and quickly provide you with a replacement. We will return repaired products at our expense, but if we determine there is no defect, or that the defect resulted from causes not within the scope of our warranty, then you must bear the cost of returning the product.

This warranty gives you specific legal rights and you may also have other rights which vary from state to state.

3491 Mission Oaks Blvd. • PO Box 6009 • Camarillo, CA 93011 • (800) 444-3353

PARTS LIST

Part	Description	Qty.
1	Cap	1
2	Screw	2
3	Rear Handle	1
4	Gasket	1
5	Detergent Bottle	1
6	Front Handle	1
7	Screw	12
8	Tube	1
9	Motor Housing	1
10	Holster	1
11	Screw	9
12	Screw	2
13	Power Switch	1
14	Front Housing	1
15	Screw	4
16	Switch	1
17	Capacitor	1
18	Rear Switch Housing	1
19	Front Switch Housing	1

PARTS LIST

Part	Description	Qty.
20	O-ring	1
21	Shaft	1
22	Rear Housing	1
23	GFCI Plug	1
23a	Power Cord	1
24	Shock Absorber	4
25	Motor/pump Assembly	1
26	Clip Cover	1
27	Jacket	1
28	Wheel	2
29	Hubcap	2
30	Water gun	1
30a	Nozzle	1
31	High Pressure Hose	1
32	Male Low Pressure Hose Connector	1
33	Female Low Pressure Hose Connector	1

Record Product's Serial Number Here: _____

Note: If product has no serial number, record month and year of purchase instead.

Note: Some parts are listed and shown for illustration purposes only, and are not available individually as replacement parts.

PLEASE READ THE FOLLOWING CAREFULLY

THE MANUFACTURER AND/OR DISTRIBUTOR HAS PROVIDED THE PARTS LIST AND ASSEMBLY DIAGRAM IN THIS MANUAL AS A REFERENCE TOOL ONLY. NEITHER THE MANUFACTURER OR DISTRIBUTOR MAKES ANY REPRESENTATION OR WARRANTY OF ANY KIND TO THE BUYER THAT HE OR SHE IS QUALIFIED TO MAKE ANY REPAIRS TO THE PRODUCT, OR THAT HE OR SHE IS QUALIFIED TO REPLACE ANY PARTS OF THE PRODUCT. IN FACT, THE MANUFACTURER AND/OR DISTRIBUTOR EXPRESSLY STATES THAT ALL REPAIRS AND PARTS REPLACEMENTS SHOULD BE UNDERTAKEN BY CERTIFIED AND LICENSED TECHNICIANS, AND NOT BY THE BUYER. THE BUYER ASSUMES ALL RISK AND LIABILITY ARISING OUT OF HIS OR HER REPAIRS TO THE ORIGINAL PRODUCT OR REPLACEMENT PARTS THERETO, OR ARISING OUT OF HIS OR HER INSTALLATION OF REPLACEMENT PARTS THERETO.

SKU 99741

**For technical questions, please call 1-800-444-3353;
Troubleshooting section at end of manual.**

PAGE 18

ASSEMBLY DIAGRAM

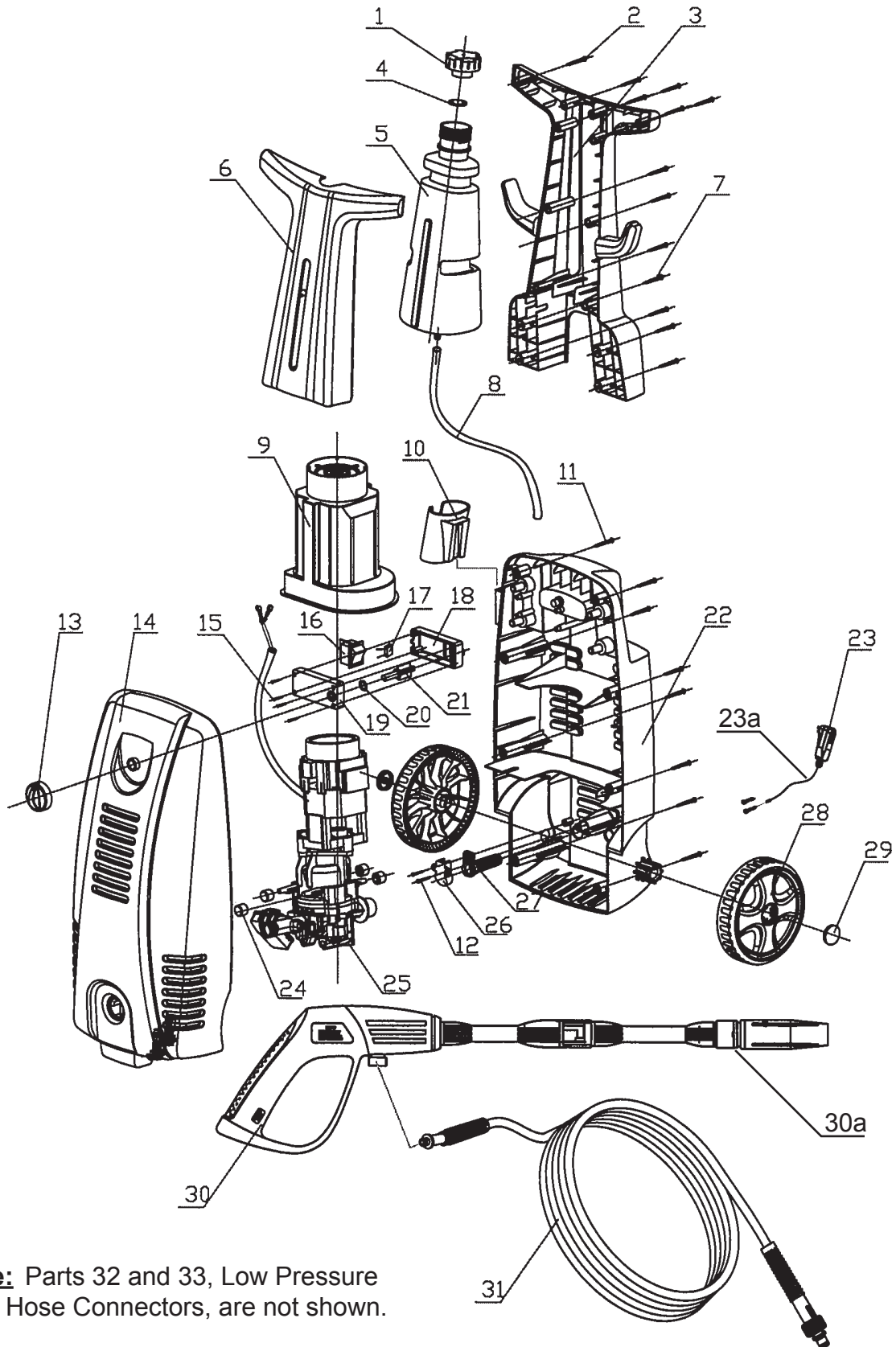

Note: Parts 32 and 33, Low Pressure Hose Connectors, are not shown.

TROUBLESHOOTING



Shut off the Pressure Washer, release all pressure in a safe manner, and disconnect it from power and water before adjusting, cleaning, or repairing the unit.

Pressure Washer Stops Suddenly

The thermal safety Switch may be tripped. Switch the unit off. Allow the unit to rest for 20-30 minutes and retry.

**UNIT OPERATES
NORMALLY AFTER
RESTING**

The following points should be applied to help reduce the frequency of rest periods:

1. Eliminate any extension cord used.
2. Use proper operating techniques. Review the Operating Tips section, starting on page 14.
3. Verify that this unit is being supplied with the correct voltage, see page 11, #2. Connect the plug to the outlet nearest the circuit breaker panel and remove any other loads that may be on the circuit.

**UNIT DOES NOT
RESTART**

Check the indicator on the GFCI power plug (explained under *Controls and Features*, #1 on page 10).

**INDICATOR
APPEARS**

Dry self thoroughly and check the circuit breaker on your household panel.

**BREAKER
NOT TRIPPED**

Contact qualified technician.

**INDICATOR DOES
NOT APPEAR**

Make sure unit is totally dry, then press reset button. If GFCI continues to trip, contact a certified electrician.

BREAKER TRIPPED

Check for electrical shorts. If none are found, reset breaker. If breaker continues to trip, try another circuit or contact a certified electrician.

Water leaking from within the housing

Seals may be worn or damaged.



Leaking water creates a shock hazard.

IMMEDIATELY discontinue use. Have the unit repaired by a qualified technician before further use.

If the steps above do not solve the problem or if the repairs involved are too complex, contact a qualified technician.

Troubleshooting (Continued)



Shut off the Pressure Washer, release all pressure in a safe manner, and disconnect it from power and water before adjusting, cleaning, or repairing the unit.

Pressure Washer will not start

Dry self thoroughly and check the voltage at the outlet, and press the reset button on the GFCI power plug (explained under *Controls and Features*, #1 on page 10).

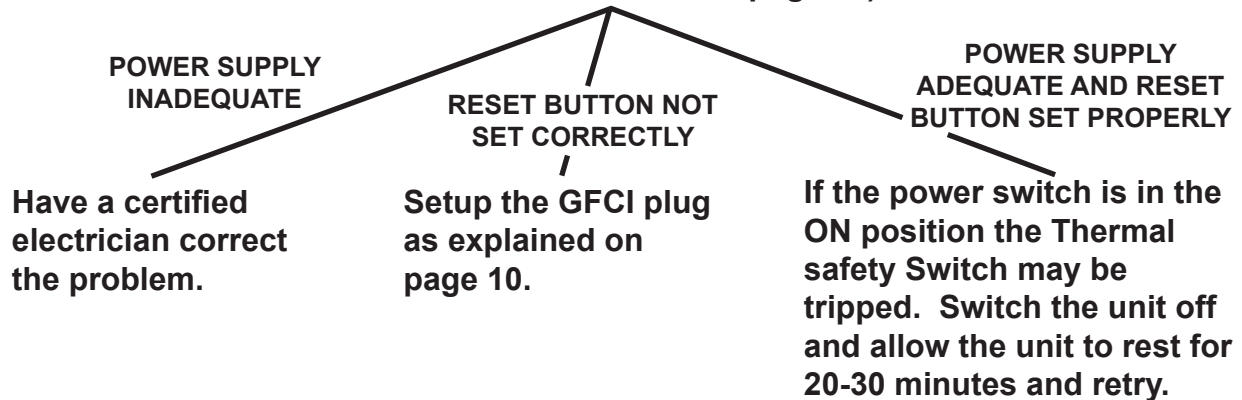

Pressure washer does not build pressure

Check that hose is unbent and Inlet Screen is free from debris and deposits.

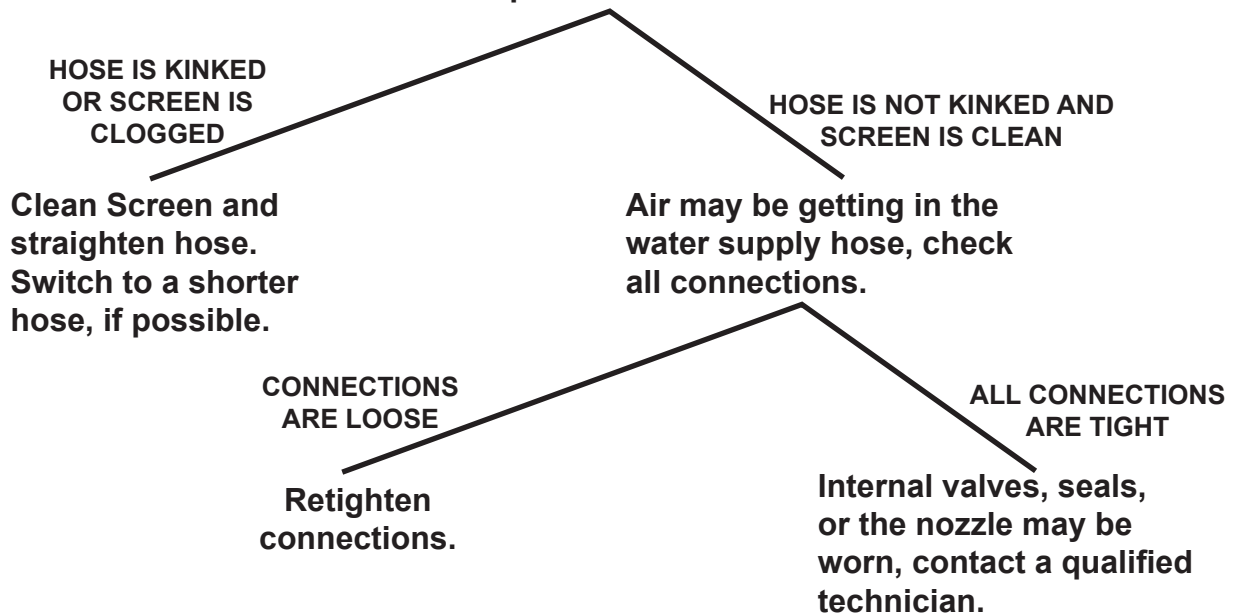

If the steps above do not solve the problem or if the repairs involved are too complex, contact a qualified technician.

Troubleshooting (Continued)



Shut off the Pressure Washer, release all pressure in a safe manner, and disconnect it from power and water before adjusting, cleaning, or repairing the unit.

Pressure changes during use

Air may be getting in the water supply hose, check all connections.

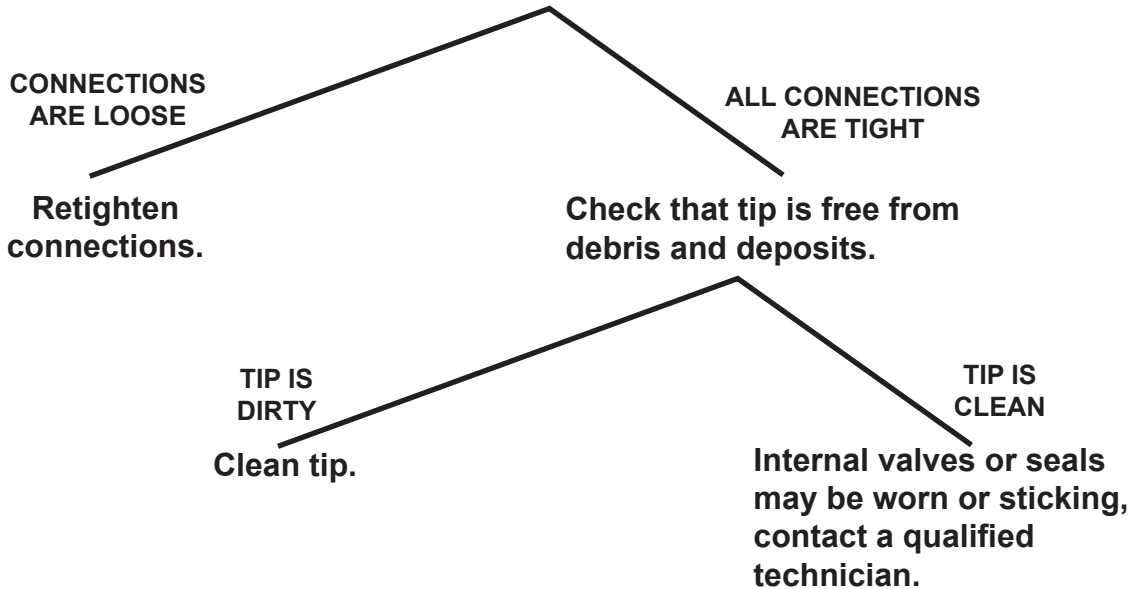

Detergent will not dispense

Verify that proper type of pressure washer detergent is being used and that the low pressure setting is being used, see pages 10-11, #3.

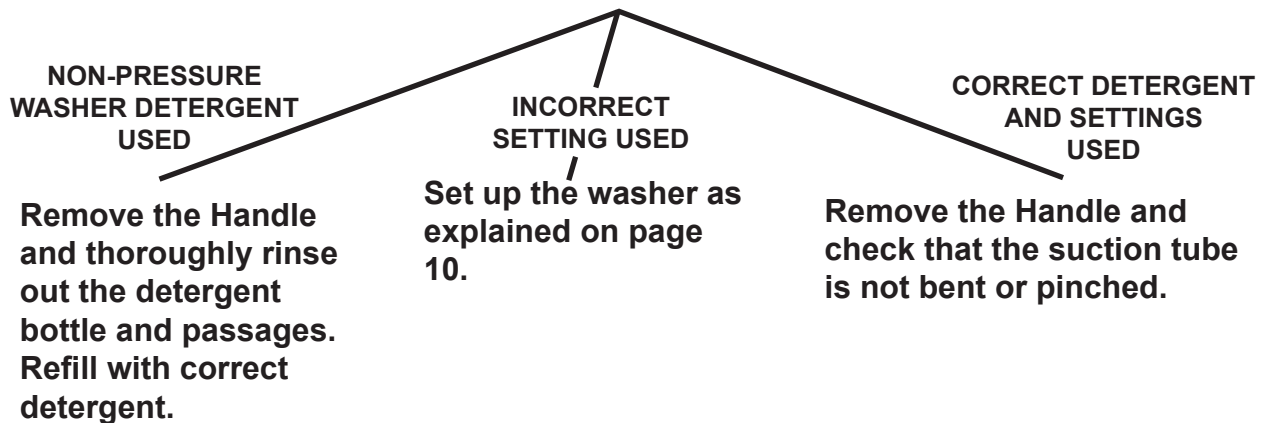

If the steps above do not solve the problem or if the repairs involved are too complex, contact a qualified technician.

Troubleshooting (Continued)



Shut off the Pressure Washer, release all pressure in a safe manner, and disconnect it from power and water before adjusting, cleaning, or repairing the unit.

Problem: There is no water coming out of the spray gun when the pump is running and trigger is depressed.

Cause: Hard water deposits (calcium) has built up inside the small orifices blocking the water from entering the pump.

Solution: Unplug the unit, lay the unit face down, fill pump at the water inlet fitting with calcium remover (such as CLR) and allow at least 5 hrs for calcium deposit to break down.

REV 08h

If the steps above do not solve the problem or if the repairs involved are too complex, contact a qualified technician.

SKU 99741

For technical questions, please call 1-800-444-3353.

PAGE 23

Free Manuals Download Website

<http://myh66.com>

<http://usermanuals.us>

<http://www.somanuals.com>

<http://www.4manuals.cc>

<http://www.manual-lib.com>

<http://www.404manual.com>

<http://www.luxmanual.com>

<http://aubethermostatmanual.com>

Golf course search by state

<http://golfingnear.com>

Email search by domain

<http://emailbydomain.com>

Auto manuals search

<http://auto.somanuals.com>

TV manuals search

<http://tv.somanuals.com>