

CENTRAL PNEUMATIC®

PAINT SPRAY GUN

Model 43760

ASSEMBLY AND OPERATING INSTRUCTIONS



Due to continuing improvements, actual product may differ slightly from the product described herein.



3491 Mission Oaks Blvd., Camarillo, CA 93011
Visit our Web site at <http://www.harborfreight.com>

**TO PREVENT SERIOUS INJURY,
READ AND UNDERSTAND ALL WARNINGS
AND INSTRUCTIONS BEFORE USE.**

Copyright© 2000 by Harbor Freight Tools®. All rights reserved. No portion of this manual or any artwork contained herein may be reproduced in any shape or form without the express written consent of Harbor Freight Tools.

For technical questions and replacement parts, please call 1-800-444-3353.

Manual revised 08/05

IMPORTANT: The Spray Gun must be cleaned immediately after use. Improper cleaning is a common reason for the Spray Gun not to work.

Contents

Unpacking	2
Specifications	3
Safety Warnings and Precautions	3
Air Connection	6
Control Layout	6
A Comparison: Conventional versus HVLP Spray Guns	7
Preparation	7
Fan Direction and Pattern Adjustment	8
Techniques	10
Maintenance	11
Parts List	12
Assembly Diagram	13
Troubleshooting	14

Unpacking

When unpacking, check to make sure the product is intact and undamaged. If any parts are missing or broken, please call Harbor Freight Tools at the number on the cover of this manual as soon as possible.

Specifications

Inlet PSI Range	20-55 PSI, 55 PSI Max.
Air Consumption	6 CFM
Paint Capacity	1 Quart
Air Inlet	1/4" - 18 NPS
Nozzle Size	.082"
Feed Type	Siphon

Save This Manual

You will need the manual for the safety warnings and precautions, assembly instructions, operating and maintenance procedures, parts list and diagram. Keep your invoice with this manual. Write the invoice number on the inside of the front cover. Keep the manual and invoice in a safe and dry place for future reference.

Safety Warnings and Precautions

WARNING: When using tool, basic safety precautions should always be followed to reduce the risk of personal injury and damage to equipment.

Read all instructions before using this tool!

1. **Keep work area clean.** Cluttered areas invite injuries.
2. **Observe work area conditions.** Do not use machines or power tools in damp or wet locations. Don't expose to rain. Keep work area well lit. Do not use air tools in the presence of flammable gases or liquids.
3. **Keep children away.** Children must never be allowed in the work area. Do not let them handle machines, tools, extension cords, or air hoses.
4. **Store idle equipment.** When not in use, tools must be stored in a dry location to inhibit rust. Always lock up tools and keep out of reach of children.
5. **Use the right tool for the job.** Do not attempt to force a small tool or attachment to do the work of a larger industrial tool. There are certain applications for which this tool was designed. It will do the job better and more safely at the rate for which it was intended. Do not modify this tool and do not use this tool for a purpose for which it was not intended.
6. **Dress properly.** Do not wear loose clothing or jewelry as they can be caught in moving parts. Protective, electrically nonconductive clothes and nonskid footwear are recommended when working. Wear restrictive hair covering to contain long hair.
7.  **Use eye and ear protection.** Always wear ANSI approved impact safety goggles and a dust mask/respirator when using this Spray Gun.
8. **Do not overreach.** Keep proper footing and balance at all times. Do not reach over or across running machines or air hoses.

9. **Maintain tools with care.** Keep tools clean for better and safer performance. Follow instructions for lubricating and changing accessories. Inspect tool cords and air hoses periodically and, if damaged, have them repaired by an authorized technician. The handle must be kept clean, dry, and free from oil and grease at all times.
10. **Disconnect air supply.** Disconnect air hose when not in use, when changing accessories, and during maintenance.
11. **Remove adjusting wrenches.** Check that adjusting wrenches are removed from the tool before attaching to the air source.
12. **Avoid unintentional starting.** Be sure the trigger is in the Off position when not in use and before attaching to the air source. Do not carry any tool with your finger on the trigger, whether it is attached to the air compressor or not.
13. **Stay alert.** Watch what you are doing, use common sense. Do not operate any tool when you are tired.
14. **Check for damaged parts.** Before using any tool, any part that appears damaged should be carefully checked to determine that it will operate properly and perform its intended function. Check for alignment and binding of moving parts; any broken parts or mounting fixtures; and any other condition that may affect proper operation. Any part that is damaged should be properly repaired or replaced by a qualified technician. Do not use the tool if the trigger does not operate properly.
15. **Replacement parts and accessories.** When servicing, use only identical replacement parts. Use of any other parts will void the warranty. Only use accessories intended for use with this tool. Approved accessories are available from Harbor Freight Tools.
16. **Do not operate tool if under the influence of alcohol or drugs.** Read warning labels if taking prescription medicine to determine if your judgement or reflexes are impaired while taking drugs. If there is any doubt, do not operate the tool.
17. **Use proper size and type extension cord.** If an extension cord is required for the compressor, it must be of the proper size and type to supply the correct current to the compressor without heating up. Otherwise, the extension cord could melt and catch fire, or cause electrical damage to the compressor. Check your compressor's manual for the appropriate size cord.
18. **Maintenance.** For your safety, maintenance should be performed regularly by a qualified technician and the unit must be thoroughly cleaned out after every use. **Improper cleaning of the Spray Gun is a common reason for the Spray Gun to jam or not perform properly.**
19. **Compressed air only.** Never use combustible gas as a power source. Never exceed the recommended operating pressure of the any of the parts (i.e. hoses, fittings, gun) of the Sprayer system.
20. **Do not spray near open flames, pilot lights, stoves, heaters, the air compressor, or any other heat source.** Most solvents and coatings are highly flammable, particularly when sprayed. Maintain a distance of at least 25 feet from the air compressor. If possible, locate the air compressor in a separate room. **Do not smoke while spraying.**

21. **Read all of the information concerning coating products and cleaning solvents.** Chlorinated solvents (e.g. 1-1-1 Trichlorethylene and Methylene Chloride, also known as methyl chloride) can chemically react with aluminum and may explode. Many paint sprayers contain aluminum. If you have any doubt about potential chemical reactions, contact the solvent or coating manufacturer.
22. **Materials used when painting or cleaning may be harmful or fatal if inhaled or swallowed.** Only use in an area with adequate ventilation. Use a respirator or mask when painting or using cleaning solvents.
23. **Never release the sprayer lid while the cup is pressurized.**
24. **Industrial applications must follow OSHA requirements.**
25. **Never point a spray gun at a person or animal.** Serious injury could occur.
26. **Spraying hazardous materials may result in serious injury or death.** Do not spray pesticides, acids, corrosive materials, fertilizers, and toxic chemicals.
27. **WARNING:** The brass components of this product contain lead, a chemical known to the State of California to cause birth defects (or other reproductive harm).
(California Health & Safety Code § 25249.5, *et seq.*)

Note: Performance of the compressor (if powered by line voltage) may vary depending on variations in local line voltage. Extension cord usage may also affect tool performance.

WARNING: The warnings, cautions, and instructions discussed in this instruction manual cannot cover all possible conditions and situations that may occur. It must be understood by the operator that common sense and caution are factors which cannot be built into this product, but must be supplied by the operator.

Air Connection

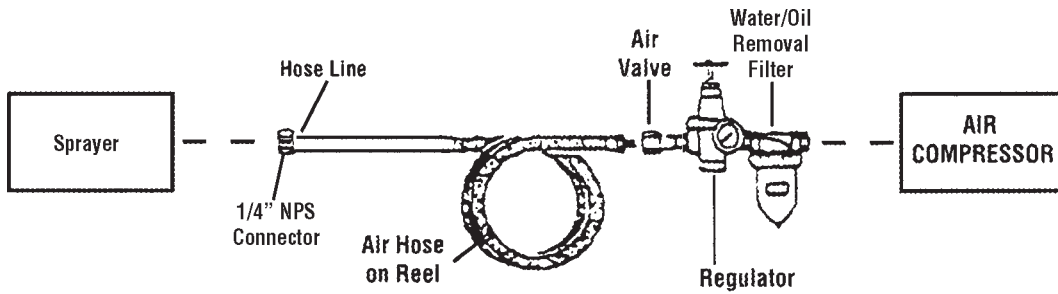

Recommended Air Line Components

For best service you should incorporate a regulator and inline filter, as shown in the diagram above. Hoses, couplers, regulators, and filters are all available at Harbor Freight Tools.

Note: Compressor pumps discharge condensed water, oil, or other contaminants along with the compressed air. Condensation causes “fish eyes” to appear in paint patterns. To avoid this problem, install water/oil removal filters and controls (not included) as close to the Spray Gun as possible. If run through the Gun, water and oil will cause damage.

1. You will need to prepare a 1/4" air connector (sold separately) to connect to the air inlet on the Spray Gun. First, wrap the 1/4" air connector (not included) with pipe thread seal tape before threading it into the Air Inlet (34). Connect the 3/8" ID Air Source Hose to the Spray Gun.
2. Set the air pressure on your compressor to 20-55 PSI. Do not exceed the maximum air pressure of 55 PSI.
3. Check the air connection for leaks and then disconnect the tool from the air source.

Control Layout

FIGURE 1

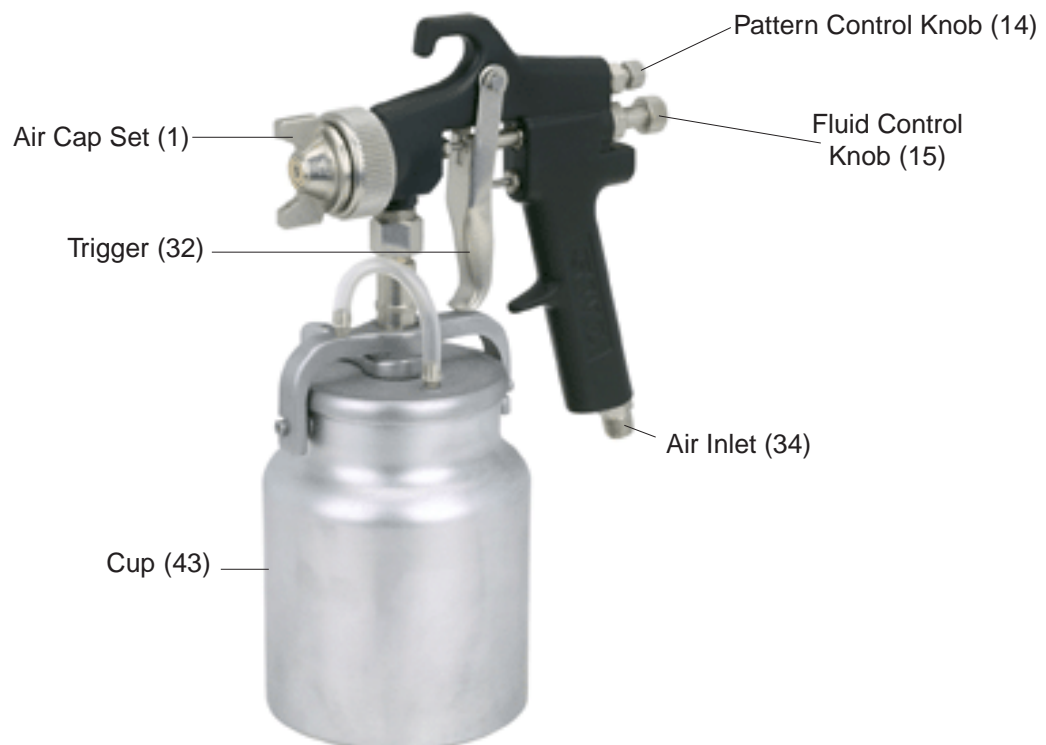

IMPORTANT: The Spray Gun must be cleaned immediately after use. Improper cleaning is a common reason for the Spray Gun not to work.

A Comparison: Conventional versus HVLP Spray Guns

Because conventional spray guns require a much higher air cap pressure to atomize the paint than HVLP Spray Guns, conventional guns have lower transfer efficiencies and more overspray.

This translates to a significant paint/material savings for HVLP guns, in addition to making them more environmentally friendly.

To qualify as HVLP, the dynamic air pressure going in the Air Cap must be a maximum of 10 PSI. The lower the air pressure, the less bounce back and overspray.

See **FIGURE 2** below.

FIGURE 2

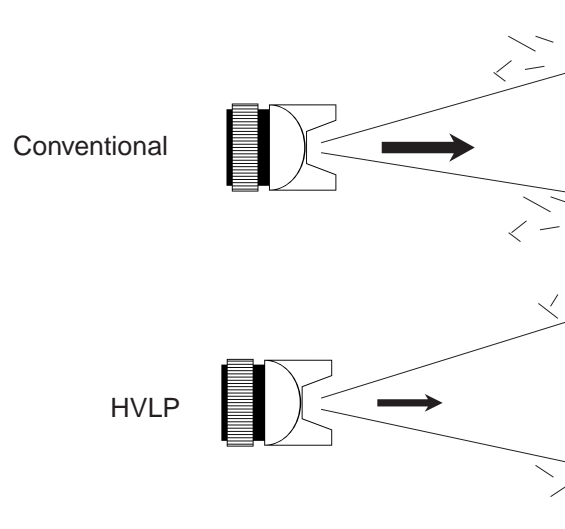

Preparation

Note: Proper paint material mixture helps to ensure less problems. Be sure to follow the manufacturer's directions. Most materials will spray readily if they are thinned properly.

General tips for Preparation:

1. Mix and thin the paint/materials thoroughly according to the manufacturer's directions. **Do not use latex paints with this Spray Gun.**
2. Carefully strain the paint/material through a paint strainer or piece of cheese cloth.
3. Swing the Cup Locking Lever (39) out of the locked position to remove the Cup (43) from the Unit. Fill the Cup (43) to approximately 3/4 full. Place the Cup (43) back on the unit and swing the Cup Locking Lever (39) to the locked position.
4. Start the air compressor.
5. To adjust the spray pattern, set up a piece of scrap material to practice on. While practicing on the scrap material, check to see that the material you are spraying has the appropriate consistency. If it appears to thin, add a very small amount of thinner (not included). **BE CAREFUL** when thinning. Proceed slowly, adding very minimal amounts. **NEVER** exceed the manufacturer's thinning recommendations.

IMPORTANT: The Spray Gun must be cleaned immediately after use. Improper cleaning is a common reason for the Spray Gun not to work.

Fan Direction and Pattern Adjustment

Note: Always make sure the Vent (45) is clear and unclogged.

Fan Direction

To change the direction of the fan from horizontal to vertical, loosen the Lock Ring and turn the Air Cap (1) 90 degrees. After the adjustment, tighten the Lock Ring by hand. See **FIGURE 3** below.

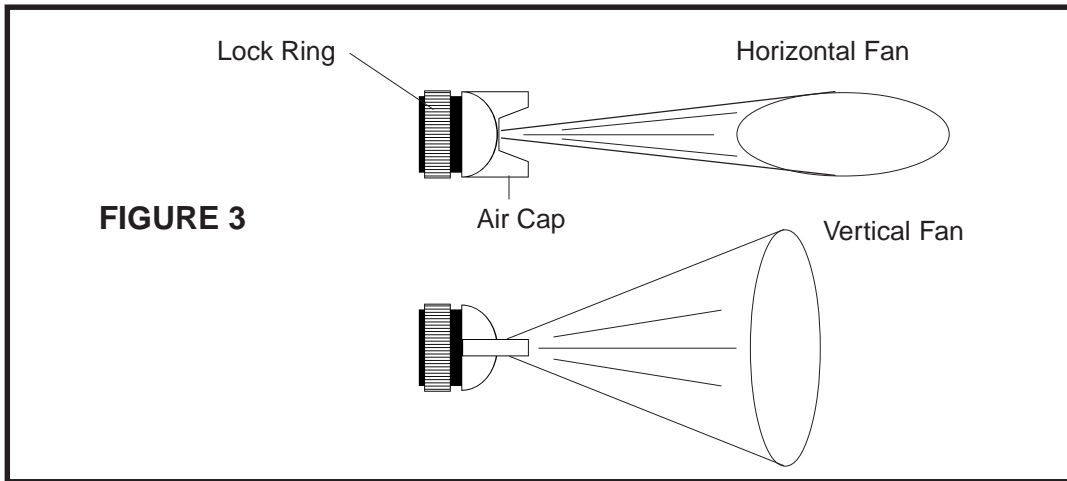

Pattern Adjustment

Warning!! Never exceed the Maximum Inlet PSI of 55 PSI.

1. If you need to reduce the air pressure for specific areas, adjust the air compressor.
2. To set the pattern size specific to the job, use the Pattern Control Knob (14) (see **FIGURE 1** on page 6). By turning it counterclockwise (all the way open), the pattern will flatten. Turn the Pattern Control Knob (14) clockwise for a round pattern. See **FIGURE 4** below.

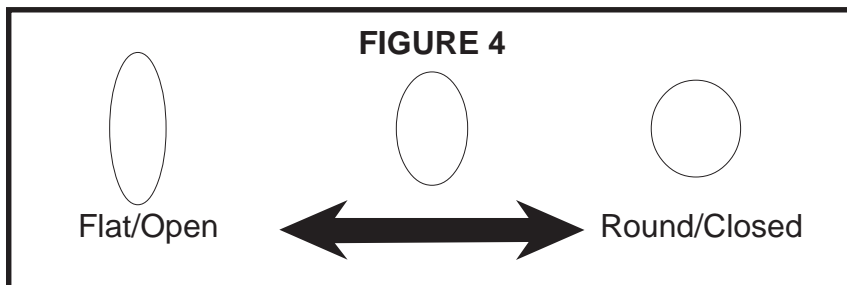

IMPORTANT: The Spray Gun must be cleaned immediately after use. Improper cleaning is a common reason for the Spray Gun not to work.

Fan Direction and Pattern Adjustment (continued)

3. Turn the Fluid Control Knob (15) clockwise until it is fully closed. See **FIGURE 1** on page 6.
4. After setting up a piece of scrap material, squeeze the Trigger (32) in short bursts while turning the Fluid Control Knob (15) counterclockwise and observe the spray patterns until you see the pattern you want. Also, look at the pattern for consistency. Too much air may cause the spray to come out too fine. Reduce the air pressure or allow more material to come out by opening the Fluid Control Knob (15). If the spray appears too thick (you see globs of paint), close down the Fluid Control Knob (15) slowly, checking the mixture after each adjustment. See **FIGURE 5** below.

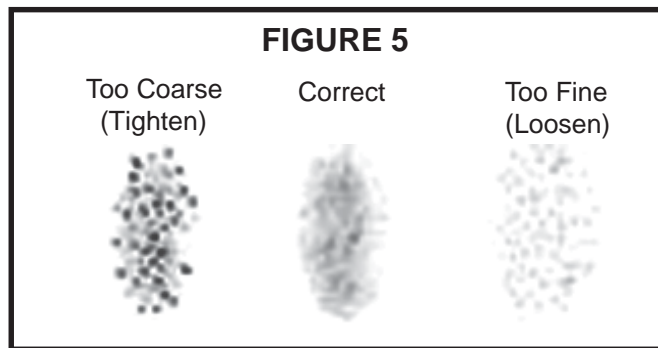

IMPORTANT: The Spray Gun must be cleaned immediately after use. Improper cleaning is a common reason for the Spray Gun not to work.

Techniques

Note: Before spraying, mask all objects you do not want sprayed and lay cloths (not included) on the floors.

1. Always keep the gun at right angles to the workpiece (See **FIGURE 6**). Pull the Trigger (32) slowly and move the Spray Gun in parallel strokes to the object being painted. Keep the distance from the object being painted at 6" to 9". This may slightly differ depending on the flow adjustment and the material being sprayed. Do not stop the gun movement while spraying. If you stop the gun for even just a slight pause while spraying, the paint will build up and run down the workpiece.

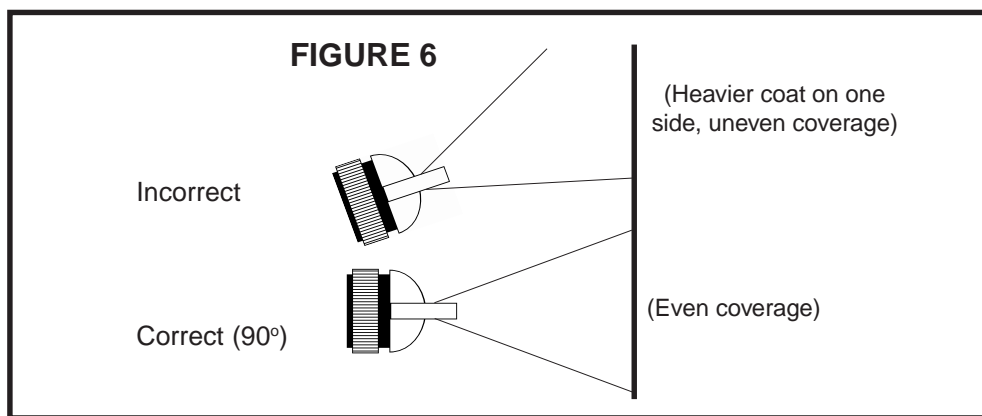

2. To ensure you don't allow paint to build up, start moving the Spray Gun before you Squeeze the Trigger (32). When you are finished spraying, release the Trigger (32) before you stop moving the Spray Gun. Doing so will eliminate distinct overlaps, producing a blended (feathered) affect. See **FIGURE 7** below.

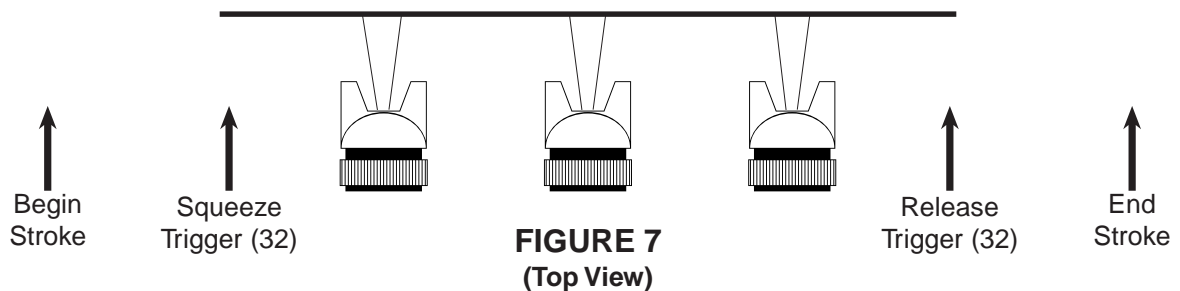

Note: The speed of the stroke, the adjustment of the Fluid Control Knob (15), and the distance from the workpiece, will determine how much paint is being applied. To get the best results, try to apply two thin coats of paint versus one thick coat.

3. **Clean out the gun thoroughly after EVERY use, according to the instructions found on the next page.**

IMPORTANT: The Spray Gun must be cleaned IMMEDIATELY after use. Improper cleaning is a common reason for the Spray Gun not to work properly. Materials dry quickly which will render the gun useless. It is extremely difficult to remove dry paint from small passages within the Gun.

Maintenance

SOLVENT SELECTION

Always follow the paint manufacturer's recommendations for cleaning, solvent type, and disposing of used solvent.

Latex Paints: DO NOT USE LATEX PAINTS WITH THIS PRODUCT.

Oil Based Paints: Use mineral spirits.

IF A FLAMMABLE SOLVENT NEEDS TO BE USED, ADHERE TO THE FOLLOWING:



1. **Follow all of the solvent manufacturer's clean up instructions and safety precautions at all times.**
2. Always flush the Spray Gun a full hose length from the air compressor.
3. If collecting flushed solvents into a metal container, transfer into a larger nonmetal container, and flush the metal container.
4. Work far away from any ignition sources in a vapor free area.

After each use:

1. Empty the Paint Cup (43) and clean it with the solvent.
2. Fill the Paint Cup (43) with solvent and spray it through the Gun into a container, while shaking the gun. Once the Paint Cup (43) is empty, repeat the process until the solvent comes out clean.

Disconnect from the air source. After disconnecting, be aware that air pressure may still remain in the Spray Gun. Point the Gun into the spent solvent container and squeeze the Trigger again to make sure no air remains.

3. Remove the Air Cap and soak it in solvent until it is clean. Use an old toothbrush and toothpicks to remove any material. **Do not use metal objects to clean the Air Cap or you may damage the drilled passages.** Inspect the fluid needle and make sure it is not bent. If it is bent, have it replaced by a certified service technician.

Warning!! Do not immerse the Spray Gun Body in solvent!

4. Use the appropriate solvent (depending on the material sprayed) to wipe down the Gun body.
5. Always lubricate the Spray Gun after cleaning. You may use a non-silicon oil or a light lubricant on all threaded connections prior to storing the unit.
6. **Disposal:** After cleaning your Spray Gun, properly dispose of your cleaning solutions according to the solution manufacturer's direction and local hazardous waste standards.

Parts List

Part	Description	Part	Description
1	Air Cap Set	35	Nipple
2	Fluid Nozzle	36	Fluid Joint
3	Gun Body	37	Screw Cap
4	Trigger Stud	38	Fastener
5	Stop Ring	39	Cup Locking Lever
14	Pattern Control Knob	40	Cup Cover
15	Fluid Control Knob	41	Liquid Tube
16	Needle Spring	42	Cup Cover Gasket
22	Needle Packing Screw	43	Cup
23	Needle Packing Ring	44	Trigger Valve Assembly
24	Air Valve Packing Ring	45	Fluid Control Assembly
32	Trigger	46	Pattern Control Assembly
33	Air Inlet Screw	47	Vinyl Vent Tube
34	Air Inlet	48	Vent Port

PLEASE READ THE FOLLOWING CAREFULLY

THE MANUFACTURER AND/OR DISTRIBUTOR HAS PROVIDED THE PARTS DIAGRAM IN THIS MANUAL AS A REFERENCE TOOL ONLY. NEITHER THE MANUFACTURER NOR DISTRIBUTOR MAKES ANY REPRESENTATION OR WARRANTY OF ANY KIND TO THE BUYER THAT HE OR SHE IS QUALIFIED TO MAKE ANY REPAIRS TO THE PRODUCT OR THAT HE OR SHE IS QUALIFIED TO REPLACE ANY PARTS OF THE PRODUCT. IN FACT, THE MANUFACTURER AND/OR DISTRIBUTOR EXPRESSLY STATES THAT ALL REPAIRS AND PARTS REPLACEMENTS SHOULD BE UNDERTAKEN BY CERTIFIED AND LICENSED TECHNICIANS AND NOT BY THE BUYER. THE BUYER ASSUMES ALL RISK AND LIABILITY ARISING OUT OF HIS OR HER REPAIRS TO THE ORIGINAL PRODUCT OR REPLACEMENT PARTS THERETO, OR ARISING OUT OF HIS OR HER INSTALLATION OF REPLACEMENT PARTS THERETO.

NOTE: Some parts are listed and shown for illustration purposes only and are not available individually as replacement parts.

Assembly Diagram

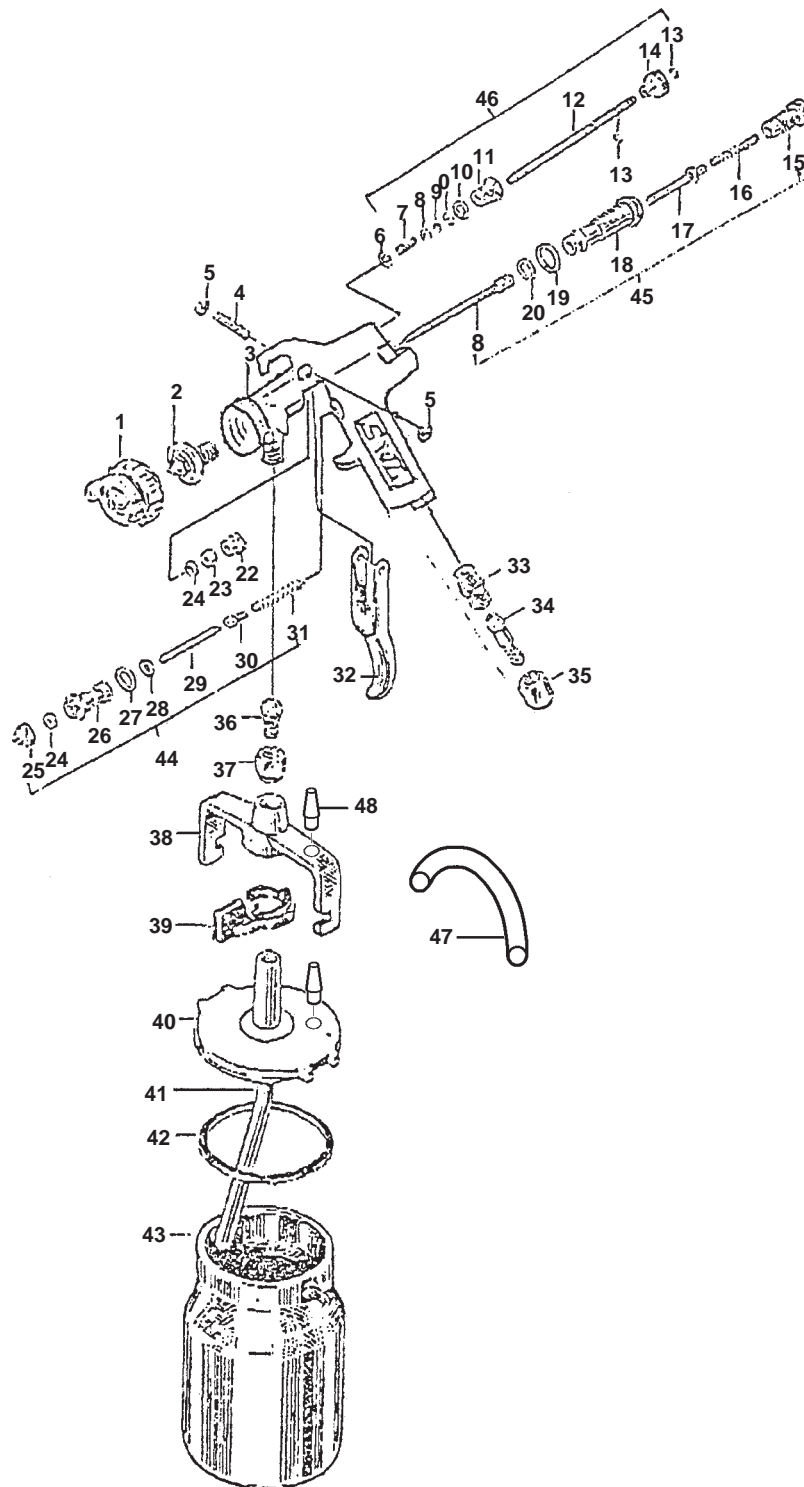

IMPORTANT: Improper cleaning is a common reason for the unit not to work properly. Most problems can be avoided or remedied with prompt, thorough cleaning.

Troubleshooting Spray Pattern Diagnosis

The Patterns below resemble symptoms of spray pattern problems. Please refer to the accompanying possible problems if you are experiencing similar difficulties. The solution to each problem follows the problem in parentheses.



Problem 1:

1. The Pattern Control Knob (14) is partially closed. (Open Pattern Control Knob (14).)
2. The material is too thick. (Thin material according to the manufacturer's instructions.)
3. The air pressure is too low. (Increase air pressure within the Maximum PSI (55).)



Problem 2:

1. High air pressure. (Reduce air pressure.)
2. Not enough fluid. (Increase fluid.)
3. Pattern Control Knob (14) open too much. (Partially close Pattern Control Knob (14).)



Problem 3:

1. Air Cap plugged. (Clean the Air Cap.)
2. Air cap loose or dirty seat. (Clean and tighten.)
3. Dried material on fluid tip. (Use a nonmetallic point to clean the Air Cap.)



Problem 4:

1. Dirt on one side of the fluid tip. (Clean the fluid tip.)
2. Holes on one side of the Air cap are plugged. (Clean the Air cap with a nonmetallic point.)

If the steps above do not solve the problem or if the repairs involved are too complex, contact a qualified technician.

IMPORTANT: Improper cleaning is a common reason for the unit not to work properly. Most problems can be avoided or remedied with prompt, thorough cleaning.

Troubleshooting (continued)

Problem	Cause	Solution
Sputtering Spray	<ol style="list-style-type: none"> 1. Low material level 2. Cup tipped too far 3. Clogged Air Vent 4. Loose fluid inlet connections 5. Dry or loose fluid needle Packing Nut 6. Loose/damaged fluid tip/seat 	<ol style="list-style-type: none"> 1. Refill 2. Hold upright 3. Clean vent hole 4. Tighten 5. Lubricate and/or tighten 6. Adjust or replace
Will Not Spray	<ol style="list-style-type: none"> 1. No pressure at gun 2. Fluid control not open enough 3. Fluid too thick 	<ol style="list-style-type: none"> 1. Check air hoses 2. Open fluid control 3. Thin fluid or increase pressure (within Maximum range)
Overspray	<ol style="list-style-type: none"> 1. Improper application speed 2. Improper distance from workpiece 3. Too much pressure 	<ol style="list-style-type: none"> 1. Move moderately and parallel 2. Adjust distance 3. Reduce air pressure
Fluid Tip Leakage	<ol style="list-style-type: none"> 1. Dirty tip 2. Tight Packing Nut (22) 3. Broken fluid needle spring 4. Worn or damaged tip 	<ol style="list-style-type: none"> 1. Clean 2. Loosen Packing Nut 3. Replace 4. Replace tip and/or needle
Air Leaking from Air Cap	<ol style="list-style-type: none"> 1. Dirty air valve/seat 2. Sticking air valve 3. Damaged air valve spring 4. Worn/damaged air valve/seat 5. Bent valve stem 	<ol style="list-style-type: none"> 1. Clean 2. Lubricate 3. Replace 4. Replace 5. Replace
Fluid Leaking from Packing Nut (22)	<ol style="list-style-type: none"> 1. Packing Nut loose 2. Packing worn or dry 	<ol style="list-style-type: none"> 1. Tighten without restricting 2. Replace or lubricate (non-silicone)

If the steps above do not solve the problem or if the repairs involved are too complex, contact a qualified technician.

Free Manuals Download Website

<http://myh66.com>

<http://usermanuals.us>

<http://www.somanuals.com>

<http://www.4manuals.cc>

<http://www.manual-lib.com>

<http://www.404manual.com>

<http://www.luxmanual.com>

<http://aubethermostatmanual.com>

Golf course search by state

<http://golfingnear.com>

Email search by domain

<http://emailbydomain.com>

Auto manuals search

<http://auto.somanuals.com>

TV manuals search

<http://tv.somanuals.com>