



16-GAUGE FINISH NAILER

Model 66872

SET UP AND OPERATING INSTRUCTIONS



Distributed exclusively by Harbor Freight Tools®.

3491 Mission Oaks Blvd., Camarillo, CA 93011

Visit our website at: <http://www.harborfreight.com>



Read and understand tool labels and manual. Failure to follow warnings could result in DEATH or SERIOUS INJURY. SAVE THIS MANUAL.

Copyright© 2009 by Harbor Freight Tools®. All rights reserved. No portion of this manual or any artwork contained herein may be reproduced in any shape or form without the express written consent of Harbor Freight Tools. Diagrams within this manual may not be drawn proportionally. Due to continuing improvements, actual product may differ slightly from the product described herein. Tools required for assembly and service may not be included.

For technical questions or replacement parts, please call 1-800-444-3353.

SAVE THIS MANUAL

Keep this manual for the safety warnings and precautions, assembly, operating, inspection, maintenance and cleaning procedures. Write the product's serial number in the back of the manual near the assembly diagram (or month and year of purchase if product has no number). Keep this manual and the receipt in a safe and dry place for future reference.

Safety Alert Symbol and Signal Words

In this manual, on the labeling, and all other information provided with this product:



This is the safety alert symbol. It is used to alert you to potential personal injury hazards. Obey all safety messages that follow this symbol to avoid possible injury or death.

⚠ DANGER

DANGER indicates a hazardous situation which, if not avoided, will result in death or serious injury.

⚠ WARNING

WARNING indicates a hazardous situation which, if not avoided, could result in death or serious injury.

⚠ CAUTION

CAUTION, used with the safety alert symbol, indicates a hazardous situation which, if not avoided, could result in minor or moderate injury.

NOTICE

NOTICE is used to address practices not related to personal injury.

CAUTION

CAUTION, without the safety alert symbol, is used to address practices not related to personal injury.

IMPORTANT SAFETY INSTRUCTIONS

INSTRUCTIONS PERTAINING TO A RISK OF FIRE, ELECTRIC SHOCK, OR INJURY TO PERSONS

WARNING – When using tools, basic precautions should always be followed, including the following:

General

- a. To reduce the risks of electric shock, fire, and injury to persons, read all the instructions before using the tool.

Work area

- a. Keep the work area clean and well lighted. Cluttered benches and dark areas increase the risks of electric shock, fire, and injury to persons.
- b. Do not operate the tool in explosive atmospheres, such as in the presence of flammable liquids, gases, or dust. The tool is able to create sparks resulting in the ignition of the dust or fumes.
- c. *Keep bystanders, children, and visitors away while operating the*

tool. Distractions are able to result in the loss of control of the tool.

Personal safety

- a. **Stay alert. Watch what you are doing and use common sense when operating the tool. Do not use the tool while tired or under the influence of drugs, alcohol, or medication.** A moment of inattention while operating the tool increases the risk of injury to persons.
- b. **Dress properly. Do not wear loose clothing or jewelry. Contain long hair. Keep hair, clothing, and gloves away from moving parts.** Loose clothes, jewelry, or long hair increases the risk of injury to persons as a result of being caught in moving parts.
- c. **Avoid unintentional starting. Be sure the Trigger (40) is off before connecting to the air supply.** Do not carry the tool with your finger on the trigger or connect the tool to the air supply with the trigger on.
- d. **Do not overreach. Keep proper footing and balance at all times.** Proper footing and balance enables better control of the tool in unexpected situations.



- e. **Use safety equipment.** A dust mask, non-skid safety shoes and a hard hat must be used for the applicable conditions. Wear heavy-duty work gloves during use.



- f. **Always wear eye protection.** Wear ANSI-approved safety goggles.

- g.  **Always wear hearing protection when using the tool.** Prolonged exposure to high intensity noise is able to cause hearing loss.
- h. **Do not attach the hose or tool to your body.** Attach the hose to the structure to reduce the risk of loss of balance if the hose shifts.
- i. **Always assume that the tool contains fasteners.** Do not point the tool toward yourself or anyone whether it contains fasteners or not.
- j. **WARNING – Do not fire fastener on top of another fastener.** This is able to cause the fastener to be deflected and hit someone, or cause the tool to react and result in a risk of injury to persons.
- k. **WARNING – Remove finger from the Trigger when not driving fasteners.** Never carry the tool with finger on trigger, the tool is able to fire a fastener.

Tool use and care

- a. **Use clamps or another practical way to secure and support the workpiece to a stable platform.** Holding the work by hand or against the body is unstable and is able to lead to loss of control.
- b. **Do not force the tool.** Use the correct tool for the application. The correct tool will do the job better and safer at the rate for which the tool is designed.
- c. **Do not use the tool if the Trigger does not turn the tool on or off.** Any tool that cannot be controlled

with the trigger is dangerous and must be repaired.

- d. **Disconnect the tool from the air source before making adjustments, doing tool maintenance, clearing jams, touching the safety, leaving work area, loading, or unloading the tool.** Such precautionary measures reduce the risk of injury to persons.
- e. **Store the tool when it is idle out of reach of children and other untrained persons.** A tool is dangerous in the hands of untrained users.
- f. **Maintain the tool with care.** A properly maintained tool is more efficient and reduces the risk of binding and is easier to control.
- g. **Check for misalignment or binding of moving parts, breakage of parts, and any other condition that affects the tool's operation.** If damaged, have the tool serviced before using. Many accidents are caused by poorly maintained tools. There is a risk of bursting if the tool is damaged.
- h. **Use only accessories that are identified by the manufacturer for the specific tool model.** Use of an accessory not intended for use with the specific tool model, increases the risk of injury to persons.
- i. **Use only those fasteners listed in the Accessories section of this manual.** Fasteners not identified for use with this tool by the tool manufacturer are able to result in a risk of injury to persons or tool damage when used in this tool.

Service

- a. **Tool service must be performed only by qualified repair personnel.**
- b. **When servicing a tool, use only identical replacement parts. Use only authorized parts.**
- c. **Use only the lubricants supplied with the tool or specified by the manufacturer.**

Air source







- a.  **Never connect to an air source that is capable of exceeding 90 PSI.** Over pressurizing the tool may cause bursting, abnormal operation, breakage of the tool or serious injury to persons. Use only clean, dry, regulated compressed air at the rated pressure or within the rated pressure range as marked on the tool. Always verify prior to using the tool that the air source has been adjusted to the rated air pressure or within the rated air-pressure range.
- b. **Never use oxygen, carbon dioxide, combustible gases or any bottled gas as an air source for the tool.** Such gases are capable of explosion and serious injury to persons.



SAVE THESE INSTRUCTIONS.

SYMBOLS AND SPECIFIC SAFETY INSTRUCTIONS

Symbol Definitions

Symbol	Property or statement
PSI	Pounds per square inch of pressure
CFM	Cubic Feet per Minute flow
SCFM	Cubic Feet per Minute flow at standard conditions
NPT	National pipe thread, tapered
NPS	National pipe thread, straight
	WARNING marking concerning Risk of Eye Injury. Wear ANSI-approved eye protection.
	Warning marking concerning Risk of Puncture Injury. Wear heavy-duty work gloves.
	Read the manual before set-up and/or use.
	WARNING marking concerning Risk of Hearing Loss. Wear hearing protection.
	WARNING marking concerning Risk of Respiratory Injury. Wear NIOSH-approved dust mask/respirator.
	WARNING marking concerning Risk of Explosion.

Specific Safety Instructions

1. **Operators and others in work area MUST wear ANSI-approved safety goggles with side shields during use.** The employer is responsible to enforce use of eye protection by the operator and others in the work area.
2. **Keep fingers away from Trigger when not driving fasteners to avoid accidental firing.**
3. Always assume the tool contains fasteners.
4. Do not point the tool toward yourself or anyone whether it contains fasteners or not.
5. Do not actuate the tool unless the tool is placed firmly against the work-piece.
6. Respect tool as a working implement.
7. No horseplay. This tool is not a toy and can be deadly if misused.
8. Do not load the tool with fasteners when any one of the operating controls is activated.
9. Do not remove, tamper with, or otherwise cause the tool operating controls to become inoperable.
10. Do not operate the tool if any portion of the tool operating controls is inoperable, disconnected, altered, or not working properly.
11. Disconnect the tool from the power source when:
 - a. Unattended.
 - b. Performing any maintenance or repair.
 - c. Clearing a jam.
 - d. Moving the tool to a new location.
12. The written approval of the tool manufacturer must be obtained prior to making any modifications to the tool.
13. Refer to the tool maintenance instructions for detailed information on the proper maintenance of the tool.

14. Fire fasteners into an appropriate work surface only. Do not attempt to fire fasteners into surfaces too hard to penetrate. Do not drive fasteners on top of other fasteners, or at too steep of an angle. Fasteners can ricochet causing personal injury.
15. Do not fire fasteners too close to the edge of a workpiece. They may split the workpiece and fly free, causing personal injury.
16. Transport Tool safely. Always disconnect air supply when moving the tool. Carry the tool by the handle and avoid contact with the trigger.
17. Hold tool away from head and body. During operation the Tool may kick back causing injury.
18. Do not fire fasteners into a workpiece that has people, utility lines, or other objects behind or inside it.
19. Keep balance while using this tool. Keep area below clear if working in a high location, and secure air hose to prevent falls from bystanders accidentally pulling on it.
20. Obey the manual for the air compressor used to power this tool.
21. Install in-line shutoff valve to allow immediate control over air supply in an emergency, even if hose is ruptured.
22. Do not engrave or stamp anything into the housing to prevent weakening of the housing.
23. **WARNING:** Some dust created by power sanding, sawing, grinding, drilling, and other construction activities, contains chemicals known [to the State of California] to cause cancer,

birth defects or other reproductive harm. Some examples of these chemicals are:

- Lead from lead-based paints
- Crystalline silica from bricks and cement or other masonry products
- Arsenic and chromium from chemically treated lumber

Your risk from these exposures varies, depending on how often you do this type of work. To reduce your exposure to these chemicals: work in a well ventilated area, and work with approved safety equipment, such as those dust masks that are specially designed to filter out microscopic particles. (California Health & Safety Code § 25249.5, *et seq.*)

24. **WARNING:** The brass components of this product contain lead, a chemical known to the State of California to cause birth defects (or other reproductive harm). (California Health & Safety code § 25249.5, *et seq.*)
25. The warnings and precautions discussed in this manual cannot cover all possible conditions and situations that may occur. It must be understood by the operator that common sense and caution are factors which cannot be built into this product, but must be supplied by the operator.

Vibration Precautions

This tool vibrates during use. Repeated or long-term exposure to vibration may cause temporary or permanent physical injury, particularly to the hands, arms and shoulders. To reduce the risk of vibration-related injury:

1. Anyone using vibrating tools regularly or for an extended period should

first be examined by a doctor and then have regular medical check-ups to ensure medical problems are not being caused or worsened from use. Pregnant women or people who have impaired blood circulation to the hand, past hand injuries, nervous system disorders, diabetes, or Raynaud's Disease should not use this tool. If you feel any symptoms related to vibration (such as tingling, numbness, and white or blue fingers), seek medical advice as soon as possible.

2. Do not smoke during use. Nicotine reduces the blood supply to the hands and fingers, increasing the risk of vibration-related injury.
3. Wear suitable gloves to reduce the vibration effects on the user.
4. Use tools with the lowest vibration when there is a choice between different processes.
5. Include vibration-free periods each day of work.
6. Grip tool as lightly as possible (while still keeping safe control of it). Let the tool do the work.
7. To reduce vibration, maintain tool as explained in this manual. If abnormal vibration occurs, stop immediately.

! SAVE THESE INSTRUCTIONS.

FUNCTIONAL DESCRIPTION

Specifications

Air Pressure Range	60-90 PSI
Maximum Air Pressure	90 PSI
Average Air Consumption	4-6 SCFM
Air Inlet	1/4" -18 NPT
Magazine Capacity	100 Nails
Trigger Type	Contact Trip Trigger
Fastener Capacity	3/4" to 2" Long, 16-Gauge Collated, (Finish Nails)

Components and Controls



Safety - Also called the workpiece contact, the safety helps prevent the tool from firing unless it is pressed against an object.

INITIAL TOOL SET UP/ ASSEMBLY

! Read the ENTIRE IMPORTANT SAFETY INFORMATION section at the beginning of this manual including all text under subheadings therein before set up or use of this product.

Note: For additional information regarding the parts listed in the following pages, refer to the Assembly Diagram near the end of this manual.

Unpacking

When unpacking, make sure the item is intact and undamaged. If any parts are missing or broken, call Harbor Freight Tools at 1-800-444-3353.

- This air tool may be shipped with a protective plug covering the air inlet. Remove this plug before set up.

Air Supply

⚠ WARNING TO PREVENT EXPLOSION:



Use only clean, dry, regulated, compressed air to power this tool. Do not use oxygen, carbon dioxide, combustible gases, or any other bottled gas as a power source for this tool.

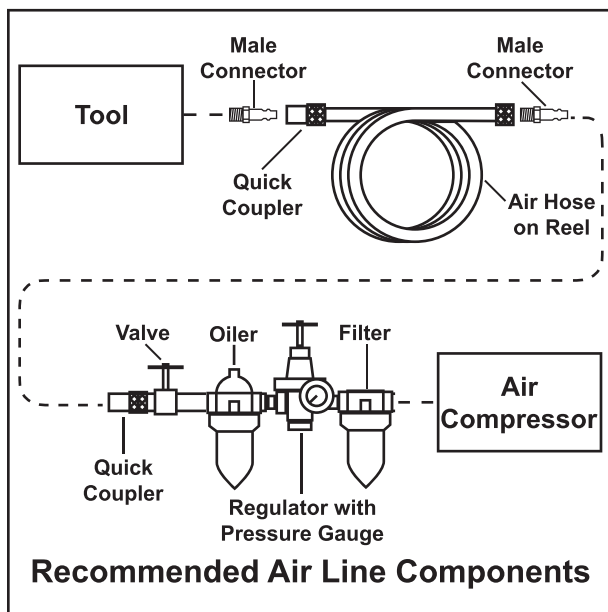

1. Incorporate an in-line oiler, shut-off valve, regulator with pressure gauge,

and filter for best service, as shown in the diagram above. **An in-line shut-off valve is an important safety device because it controls the air supply even if the air hose is ruptured.**

Note: If an automatic oiler system is not used, add a few drops of Pneumatic Tool Oil to the airline connection before operation. Add a few more drops after each hour of continual use.

2. Attach an air hose to the compressor's air outlet. Connect the air hose to the air inlet of the tool. Other components, such as a connector and quick coupler, will make operation more efficient, but are not required.

⚠ WARNING! TO PREVENT SERIOUS INJURY FROM ACCIDENTAL OPERATION:

Do not install a female quick coupler on the tool. Such a coupler contains an air valve that will allow the air tool to retain pressure and operate accidentally after the air supply is disconnected.

Note: Air flow, and therefore tool performance, can be hindered by under-sized air supply components.

3. The air hose must be long enough to reach the work area with enough extra length to allow free movement while working.
4. Release the tool's trigger.
5. Close the in-line safety valve between the compressor and the tool.
6. Turn on the air compressor according to the manufacturer's directions and allow it to build up pressure until it cycles off.

7. Adjust the air compressor's output regulator so that the air output is enough to properly power the tool, but the output will not exceed the tool's maximum air pressure at any time. Adjust the pressure gradually, while checking the air output gauge to set the right pressure range.
8. The air pressure setting must not exceed job site regulations/restrictions. The air pressure setting must not exceed 90 PSI when being used with work pieces that have a thickness of less than 1-3/4".
9. Inspect the air connections for leaks. Repair any leaks found.
10. If the tool will not be used at this time, turn off and detach the air supply, safely discharge any residual air pressure, and release the trigger to prevent accidental operation.

Note: Residual air pressure should not be present after the tool is disconnected from the air supply. However, it is a good safety measure to attempt to discharge the tool in a safe fashion after disconnecting to ensure that the tool is disconnected and unpowered.

OPERATING INSTRUCTIONS



Read the **ENTIRE IMPORTANT SAFETY INFORMATION** section at the beginning of this manual including all text under subheadings therein before set up or use of this product.

Inspect tool before use, looking for damaged, loose, and missing parts. If any problems

are found, do not use tool until repaired.

Work Piece and Work Area Set Up

1. Designate a work area that is clean and well-lit. The work area must not allow access by children or pets to prevent injury and distraction.
2. Route the air hose along a safe route to reach the work area without creating a tripping hazard or exposing the air hose to possible damage. The air hose must be long enough to reach the work area with enough extra length to allow free movement while working.
3. Secure loose workpieces using a vise or clamps (not included) to prevent movement while working.
4. There must not be hazardous objects (such as utility lines or foreign objects) nearby that will present a hazard while working.

Testing the Full Sequential Safety Trip Mechanism

⚠ WARNING TO PREVENT SERIOUS INJURY

FROM ACCIDENTAL OPERATION:

Empty the tool before this procedure. Point the tool at a piece of scrap wood when testing.

The Tool should not fire if the nose is not depressed against the workpiece. This tool has a full sequential safety trip mechanism, which is designed to prevent inadvertent firing. The tool will only fire if the Safety is resting on the workpiece prior to pulling the Trigger.

1. Disconnect the tool from the air supply.
2. Empty the Magazine of fasteners.
3. Check that the Trigger and the Safety on the nose of the tool, move freely, without sticking.
4. Connect the air supply to the tool at the Male Air Coupler (53) and set at the recommended 60-90 PSI, and not over the maximum 90 PSI.
5. Test the tool by depressing the Safety against the workpiece without pulling the Trigger. **The Tool must not cycle (fire).** If it cycles (fires), stop immediately and have it repaired by a qualified service technician.
6. Hold the tool away or off of the workpiece. The Safety of the tool should return to its original position. Squeeze the Trigger. **The tool must not cycle (fire).** If the tool fires, stop immediately and have it repaired by a qualified service technician.
7. Depress the Safety against the workpiece and squeeze the Trigger. **The tool must cycle (fire) only once.** Release the Trigger and squeeze it again. **The tool must not cycle (fire).** With the Trigger held, carefully lift the tool and press it against the workpiece again. **The tool must not cycle (fire).** If it fails to perform in the manner explained in bold, have it repaired by a qualified service technician.
8. **Please note:** The Trigger and Safety will not work when the Nailer Magazine is empty.

Loading the Tool

⚠ WARNING TO PREVENT SERIOUS INJURY FROM ACCIDENTAL OPERATION, BEFORE LOADING:



- **Wear ANSI-approved safety goggles with side shields.** Other people in the work area must also wear ANSI-approved impact safety goggles.
- **Release the trigger.**
- **Detach the air supply.**
- **Attempt to fire the Tool into a piece of scrap wood to ensure that it is disconnected and is incapable of firing any fasteners.**

⚠ WARNING TO PREVENT SERIOUS INJURY FROM ACCIDENTAL OPERATION: Release the trigger, detach the air supply, and safely discharge any residual air pressure in the tool before loading. **Keep the Tool pointed away from yourself and others at all times. Do not load fasteners with the Trigger or Safety depressed.**

1. In order to prevent marring the surface, attach the Nozzle Cover (56). The tang on the Cover goes to the back of the Nozzle (59). If the Cover is attached incorrectly, the Nozzle cannot be depressed and the Nailer will not function. When not used, attach the Nozzle Cover onto the tang at the back of the Tail Cover (65).
2. Depress the Pusher (63) to release the Magazine (82).

3. Slide the Magazine out all the way.
4. Insert the required size Fasteners (3/4", 1", 1-1/4", 1-1/2" or 1-3/4" 16-gauge) into the Magazine with the point towards the Nozzle. **WARNING!** Insert ONLY one size of fastener at a time. Do NOT load fasteners of different sizes together.
5. Slide the Magazine back into place until the Pusher (71) locks in.
6. Air exhaust may be directed in any direction. Rotate the Exhaust Valve Cover (1) to keep exhaust from blowing back at the operator's face.
6. If the tool requires more force to accomplish the task, verify that the tool receives sufficient, unobstructed airflow (CFM) and increase the pressure (PSI) output of the regulator up to the maximum air pressure rating of this tool.
CAUTION! TO PREVENT TOOL AND ACCESSORY FAILURE, RESULTING IN INJURY:
Do not exceed the tool's maximum air pressure rating.
If the tool still does not have sufficient force at maximum pressure and sufficient airflow, then a larger tool may be required.

General Operating Instructions

1. Test the Tool, as directed in the prior section, before each use.
2. If an automatic oiler is not used, add a few drops of Pneumatic Tool Oil to the airline connection before use. Add a few drops more after each hour of continual use.
3. Place the Nozzle on a scrap material, preferably the same thickness and type of material as the workpiece. Press the Trigger (40) to activate the Nailer. Performing this test-firing will help you to set the correct air pressure (not exceeding 90 PSI) to properly drive the fastener.
4. Grip the Body (29) of the Nailer with both hands and press the Nozzle (59) against the surface you wish to fasten. Be sure to keep hands, fingers and other body parts away from Nozzle.
5. Press the Trigger (40) to activate the Nailer.
7. To prevent accidents, turn off the tool, detach the air supply, safely discharge any residual air pressure in the tool, and release the trigger after use. Clean external surfaces of the tool with clean, dry cloth. Then store the tool indoors out of children's reach.

USER-MAINTENANCE INSTRUCTIONS



Procedures not specifically explained in this manual must be performed only by a qualified technician.

⚠️ WARNING

TO PREVENT SERIOUS INJURY FROM ACCIDENTAL OPERATION, BEFORE ANY MAINTENANCE OR REPAIRS ARE DONE (including clearing jams):



- **Wear ANSI-approved safety goggles with side shields.** Other people in the work area must also wear ANSI-approved impact safety goggles.
- **Release the trigger.**
- **Detach the air supply.**
- **Attempt to fire the Tool into a piece of scrap wood to ensure that it is disconnected and is incapable of firing any fasteners.**
- **The Magazine is spring-loaded and may cause parts or a fastener to fly out of the Tool. Empty the magazine and leave it open during service.**

TO PREVENT SERIOUS INJURY FROM TOOL FAILURE:

Do not use damaged equipment. If abnormal noise, vibration, or leaking air leaks occur, have the problem corrected before further use.



TO PREVENT EXPLOSION: Lubricate only with specified lubricants. Lubricate the air inlet using only pneumatic tool oil. Lubricate the internal mechanism using only white lithium grease. Other lubricants may damage the mechanism and may be highly flammable, causing an explosion.

Cleaning, Maintenance, and Lubrication

Note: These procedures are in addition to the regular checks and maintenance

explained as part of the regular operation of the air-operated tool.

1. **Daily - Air Supply Maintenance:** Every day, perform maintenance on the air supply according to the component manufacturers' instructions. The lubricator's oil level needs to be maintained and the moisture filter must be regularly drained. Performing routine maintenance on the air supply will allow the tool to operate more safely and will also reduce wear on the tool.

Clearing Jams

⚠ WARNING TO PREVENT SERIOUS INJURY FROM ACCIDENTAL OPERATION, BEFORE ANY MAINTENANCE OR REPAIRS ARE DONE (including clearing jams):



- **Wear ANSI-approved safety goggles with side shields.** Other people in the work area must also wear ANSI-approved impact safety goggles.
- **Release the trigger.**
- **Detach the air supply.**
- **Attempt to fire Tool into piece of scrap wood to ensure that it is disconnected and incapable of firing fasteners.**
- **Empty the magazine and leave it open during service. The Magazine is spring-loaded and may cause parts or a fastener to fly out of the Tool.**

1. If a fastener is jammed in the discharge area, remove it with pliers.
2. If a fastener is jammed in the magazine, pull the Pusher all the way

out. Use a screwdriver to release the jammed fastener by probing the openings in the magazine.

3. Pull out the jammed fastener and the remainder of the fastener strip that is still in the magazine. Dispose of the

remaining fastener strip; it may be bent or damaged in some other way.

4. If unable to clear jam using the method prescribed above, the tool should be taken to a qualified service technician for proper servicing.

Troubleshooting

Problem	Possible Causes	Likely Solutions
Insufficient fastener depth.	<ol style="list-style-type: none"> 1. Incorrect tool depth setting. 2. Not enough air pressure. 3. Incorrect lubrication or not enough lubrication. 4. Blocked air inlet screen (if equipped). 5. Mechanism contaminated. 	<ol style="list-style-type: none"> 1. Adjust depth setting, if available. 2. Check for loose connections and make sure that air supply is providing enough air pressure (PSI) to the tool's air inlet. Do not exceed maximum air pressure. 3. Lubricate using air tool oil and grease according to directions. 4. Clean air inlet screen of buildup. 5. Have qualified technician clean and lubricate mechanism. Install in-line filter in air supply as stated in Initial Set Up: Air Supply.
Fasteners drive too deeply.	<ol style="list-style-type: none"> 1. Incorrect tool depth setting. 2. Too much air pressure. 	<ol style="list-style-type: none"> 1. Adjust depth setting, if available. 2. Reduce air supply pressure (PSI).
Tool cycles without firing fastener.	<ol style="list-style-type: none"> 1. Tool empty. 2. Incorrect fasteners used. 3. Magazine dirty or not lubricated properly. 4. Insufficient air flow. 5. Nails jammed. 	<ol style="list-style-type: none"> 1. Fill with correct fasteners. 2. Empty, then fill with correct fasteners. 3. Clean and lubricate magazine and pusher. 4. Check for loose connections and make sure that air supply is providing enough air flow (CFM) and pressure (PSI) to the tool's air inlet. Do not exceed maximum air pressure. 5. Check the Magazine, remove Nozzle, and clear bent or broken nails.
Frequent jamming.	Incorrect fastener type.	Confirm fastener diameter, type, length, angle, and collation type. Correct as needed.
Severe air leakage. (Slight air leakage is normal, especially on older tools.)	<ol style="list-style-type: none"> 1. Cross-threaded housing components. 2. Loose housing. 3. Damaged valve or housing. 4. Dirty, worn or damaged valve. 	<ol style="list-style-type: none"> 1. Check for incorrect alignment and uneven gaps. If cross-threaded, disassemble and replace damaged parts before use. 2. Tighten housing assembly. If housing cannot tighten properly, internal parts may be misaligned. 3. Replace damaged components. 4. Clean or replace valve assembly.



Follow all safety precautions whenever diagnosing or servicing the tool. Disconnect air supply before service.

PARTS LIST

Part	Description	Q'ty
1	Exhaust Valve Collar	1
2	O-Ring (33 x 1.75)	2
3	Cover Grip	1
4	Screw (5 x 35)	4
5	Cylinder Cap	1
6	Air Seal	6
7	O-Ring (22 x 1.5)	1
8	Exhaust Valve	1
9	Spring	1
10	O-Ring (9.8 x 2.4)	1
11	O-Ring (32 x 2.5)	1
12	Firing Valve Piston	1
13	O-Ring (13 x 3)	1
14	O-Ring (24.5 x 3)	1
15	O-Ring (22.9 x 2.7)	1
16	Piston Head	1
17	Piston Driver Coupling	1
18	Spring Pin (4 x 10)	1
19	Spring Pin (2.5 x 10)	3
20	Driver Blade	1
21	Collar	1
22	O-Ring (44.8 x 2.6)	1
23	Spacer	1
24	O-Ring (26.6 x 2.6)	1
25	Cylinder	1
26	Bumper	1
27	Gasket	1
28	E-Ring (Ø2.5)	1
29	Body	1
30	Nozzle	1
31	O-Ring (11 x 1.05)	1
32	Upper Housing	1
33	O-Ring (8 x 1)	1
34	Conical Spring	1
35	O-Ring (1.9 x 1.2)	2
36	Remote Core	1
37	Remote Housing	1
38	O-Ring (9.8 x 1.9)	1
39	Spring	1
40	Trigger	1
41	Trigger Frame	1

Part	Description	Q'ty
42	Guide	1
43	Trigger Release Catch	1
44	Compression Spring	1
45	Catch Guide Plate	1
46	Screw (5 x 22)	3
47	Washer (5 x 1.1)	2
48	Spacer	1
49	Spring Pin (3 x 24)	1
50	Trigger Pin	1
51	O-Ring (37.5 x 3.5)	1
52	Tail Cover	1
53	Male Air Coupler	1
54	Screw (4 x 8)	3
55	Driver Guide Cover	1
56	Nozzle Cover	1
57	Safety	1
58	Screw (4 x 18)	2
59	Nozzle	1
60	Nylon Nut (M5)	1
61	Magazine Support	1
62	Belt Hook	1
63	Pusher	1
64	Compression Spring	1
65	Tail Cover	1
66	Step Pin	2
67	Spacer	2
68	Screw (4 x 25)	2
69	Scaleboard	1
70	Screw (3 x 12)	1
71	Pusher	1
72	Spring Holder	1
73	Feeder Spring	1
74	Steel Bar	1
75	Handle Grip	1
76	Exhaust Valve Assembly	1
77	Head Valve Piston	1
78	Piston Set	1
79	Cylinder	1
80	Trigger Valve	1
81	Rack	1
82	Magazine	1

Record Product's Serial Number Here: _____

Note: If product has no serial number, record month and year of purchase instead.

Note: Some parts are listed and shown for illustration purposes only, and are not available individually as replacement parts.

ASSEMBLY DIAGRAM

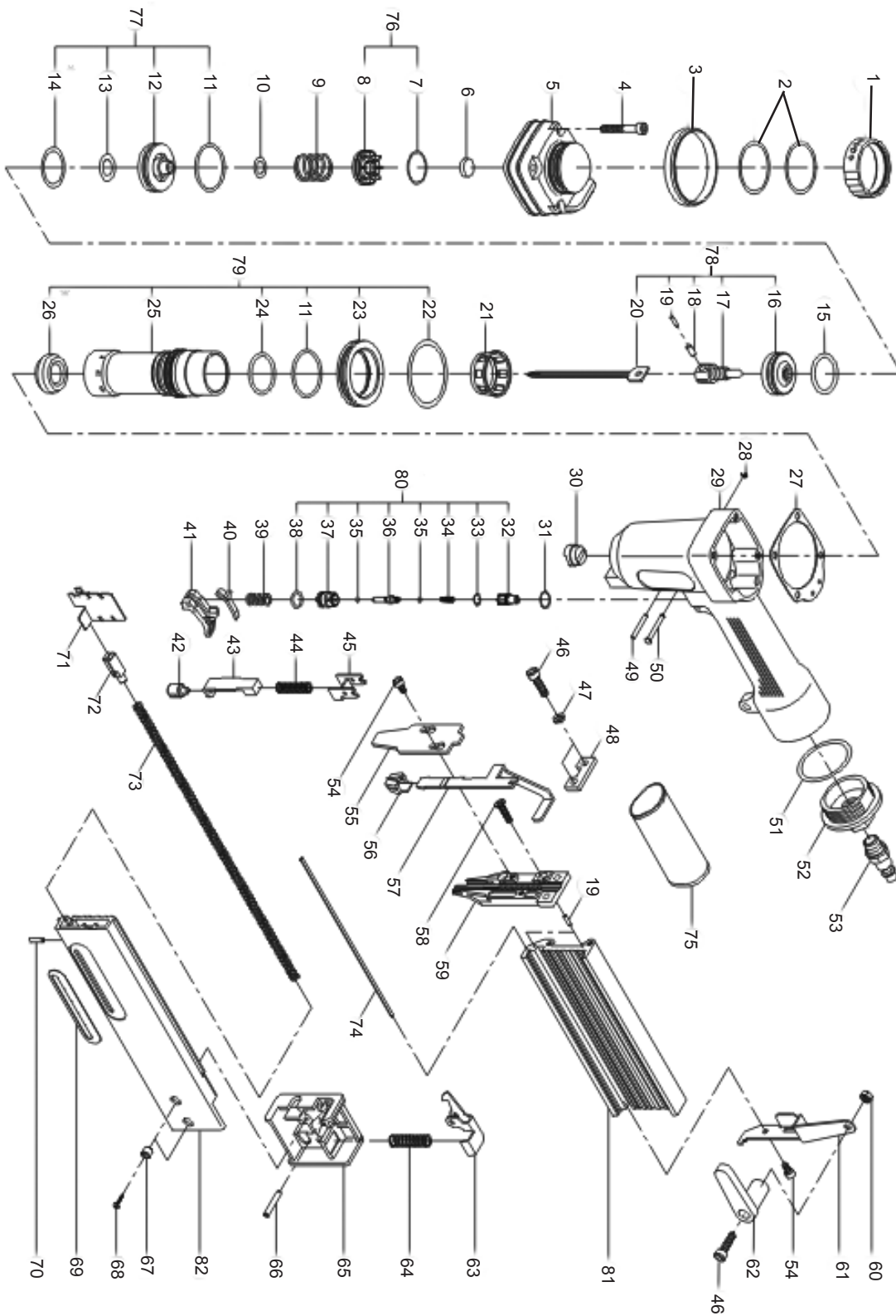

90 Day Warranty

Harbor Freight Tools Co. makes every effort to assure that its products meet high quality and durability standards, and warrants to the original purchaser that this product is free from defects in materials and workmanship for the period of 90 days from the date of purchase. This warranty does not apply to damage due directly or indirectly, to misuse, abuse, negligence or accidents, repairs or alterations outside our facilities, criminal activity, improper installation, normal wear and tear, or to lack of maintenance. We shall in no event be liable for death, injuries to persons or property, or for incidental, contingent, special or consequential damages arising from the use of our product. Some states do not allow the exclusion or limitation of incidental or consequential damages, so the above limitation of exclusion may not apply to you. THIS WARRANTY IS EXPRESSLY IN LIEU OF ALL OTHER WARRANTIES, EXPRESS OR IMPLIED, INCLUDING THE WARRANTIES OF MERCHANTABILITY AND FITNESS.

To take advantage of this warranty, the product or part must be returned to us with transportation charges prepaid. Proof of purchase date and an explanation of the complaint must accompany the merchandise. If our inspection verifies the defect, we will either repair or replace the product at our election or we may elect to refund the purchase price if we cannot readily and quickly provide you with a replacement. We will return repaired products at our expense, but if we determine there is no defect, or that the defect resulted from causes not within the scope of our warranty, then you must bear the cost of returning the product.

This warranty gives you specific legal rights and you may also have other rights which vary from state to state.

3491 Mission Oaks Blvd. • PO Box 6009 • Camarillo, CA 93011 • (800) 444-3353

PLEASE READ THE FOLLOWING CAREFULLY

THE MANUFACTURER AND/OR DISTRIBUTOR HAS PROVIDED THE PARTS LIST AND ASSEMBLY DIAGRAM IN THIS MANUAL AS A REFERENCE TOOL ONLY. NEITHER THE MANUFACTURER OR DISTRIBUTOR MAKES ANY REPRESENTATION OR WARRANTY OF ANY KIND TO THE BUYER THAT HE OR SHE IS QUALIFIED TO MAKE ANY REPAIRS TO THE PRODUCT, OR THAT HE OR SHE IS QUALIFIED TO REPLACE ANY PARTS OF THE PRODUCT. IN FACT, THE MANUFACTURER AND/OR DISTRIBUTOR EXPRESSLY STATES THAT ALL REPAIRS AND PARTS REPLACEMENTS SHOULD BE UNDERTAKEN BY CERTIFIED AND LICENSED TECHNICIANS, AND NOT BY THE BUYER. THE BUYER ASSUMES ALL RISK AND LIABILITY ARISING OUT OF HIS OR HER REPAIRS TO THE ORIGINAL PRODUCT OR REPLACEMENT PARTS THERETO, OR ARISING OUT OF HIS OR HER INSTALLATION OF REPLACEMENT PARTS THERETO.

Free Manuals Download Website

<http://myh66.com>

<http://usermanuals.us>

<http://www.somanuals.com>

<http://www.4manuals.cc>

<http://www.manual-lib.com>

<http://www.404manual.com>

<http://www.luxmanual.com>

<http://aubethermostatmanual.com>

Golf course search by state

<http://golfingnear.com>

Email search by domain

<http://emailbydomain.com>

Auto manuals search

<http://auto.somanuals.com>

TV manuals search

<http://tv.somanuals.com>