

# Metal Detector

## Model 43150

### Assembly and Operating Instructions



**Visit Our Web Site**  
**<http://www.harborfreight.com>**

3491 Mission Oaks Blvd., Camarillo, CA 93011

Copyright © 2000 by Harbor Freight Tools®. All rights reserved.  
No portion of this manual or any artwork contained herein may be reproduced in any shape or form without the express written consent of Harbor Freight Tools.

**For technical questions and replacement parts, please call 1-800-444-3353.**

Revised Cover 09/04

## Specifications

Stem Length:	15-1/2" X 28-1/2"
Coil:	6-1/2" Diameter
Power Supply:	Qty 6, AA Batteries
Battery Tester:	Yes, built-in
Audio:	3 distinctive sounds for different metals
Weight:	1.8 Lbs.

### Save This Manual

You will need the manual for the safety warnings and precautions, assembly instructions, operating and maintenance procedures, parts list and diagram. Keep your invoice with this manual. Write the invoice number on the inside of the front cover. Keep the manual and invoice in a safe and dry place for future reference.

### Safety Warnings and Precautions

**WARNING:** When using tool, basic safety precautions should always be followed to reduce the risk of personal injury and damage to equipment.

#### Read all instructions before using this product!

1. **Handle the Metal Detector carefully at all times.** Dropping the Metal Detector can cause damage to circuit boards and the case, which can cause the product to work improperly.
2. **Only use and store the Metal Detector in normal temperature environments.** Extremes in temperature can shorten the effectiveness of electronic devices and melt or damage plastic parts.
3. **Avoid electrical shock.** Any metal detector may discover underground power lines, explosives or other items which when struck could cause personal injury. Do not use this product in areas where there might be underground electric lines or pipes buried at shallow depths. Never search in military zones where bombs or other explosives may be buried. Avoid striking any line known or suspected to be carrying electric power. Do not search any pipeline, particularly if it could contain a flammable gas or liquid. In areas of uncertain conditions, use reasonable caution before using the Metal Detector. If there is any question about a condition being safe or unsafe, do not operate the Metal Detector.
4. **Keep the Metal Detector clean.** Wipe the housing after each use. The search coil is washable and can be fully submerged. Never submerge the control housing. Protect the control housing from rain, blowing surf and heavy mist. Disassemble the stem and wipe it clean after use in sandy areas.
5. **Dress properly.** Do not wear loose clothing or jewelry as they can be caught in moving parts. Protective, electrically nonconductive clothes and nonskid footwear are recommended when working. Wear restrictive hair covering to contain long hair.
6. **Use the right tool for the job.** Do not attempt to force a small tool or attachment to do the work of a larger industrial tool. There are certain applications for which this tool was designed. Do not modify this tool and do not use this tool for a purpose for which it was not intended.
7. **Stay alert.** Watch what you are doing, use common sense. Do not operate any tool when you are tired.

## Safety Warnings and Precautions (continued)

- Check for damaged parts.** Before using any tool, any part that appears damaged should be carefully checked to determine that it will operate properly and perform its intended function. Check for alignment and binding of moving parts; any broken parts or mounting fixtures; and any other condition that may affect proper operation. Any part that is damaged should be properly repaired or replaced by a qualified technician. Do not use the tool if any switch does not turn On and Off properly.
- Replacement parts and accessories.** When servicing, use only identical replacement parts. Use of any other parts will void the warranty. Only use accessories intended for use with this tool. Approved accessories are available from Harbor Freight Tools.
- Do not operate tool if under the influence of alcohol or drugs.** Read warning labels on prescriptions to determine if your judgment or reflexes are impaired while taking drugs. If there is any doubt, do not operate the tool.
- Maintenance.** For your safety, maintenance should be performed regularly by a qualified technician.
- People with pacemakers should consult their physician(s) before using this product.** Electromagnetic fields in close proximity to a heart pacemaker could cause interference to or failure of the pacemaker.

**Warning:** The warnings, cautions, and instructions discussed in this instruction manual cannot cover all possible conditions and situations that may occur. It must be understood by the operator that common sense and caution are factors which cannot be built into this product, but must be supplied by the operator.

## Unpacking

When unpacking, check to make sure all parts shown on the Parts Diagram and Parts List are present. If any parts are missing or broken, please call Harbor Freight Tools at the number on the cover of this manual.

## Preparing to Operate

### Adjusting the Stem

- Turn locknut clockwise until it becomes loose (see Figure 1). Adjust the stem so when you are standing upright with the detector in your hand, the search coil is level with and about 1/2 to 2 inches above the ground when your arm is relaxed at your side (see Figure 2).



Figure 1



Figure 2

Turn the stem's lock nut counterclockwise to lock it in place.

### Adjusting the Search Coil

Loosen the Knobs at the end of the Search Coil (the Search Coil should be parallel with the ground). Tighten the Knobs enough to keep the Search Coil from wobbling or rotating (see Figure 3).

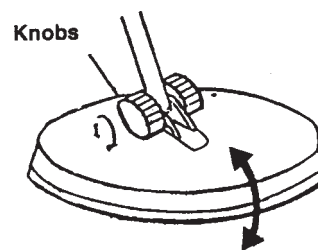

Figure 3

## Battery Installation

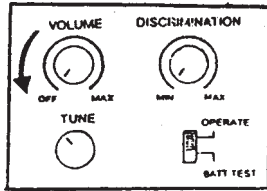

Figure 4

The Metal Detector requires the use of six AA batteries. Do not mix old and new batteries and do not mix different types of batteries.

1. If the Metal Detector is on, turn the volume on the control housing to **OFF** (see Figure 4).
2. Press on the battery compartment cover and slide the cover off in the direction of the arrow (see Figure 5).

3. Insert the batteries into the compartment as indicated by the polarity symbols (+ and -) which are marked inside the compartment (see Figure 6) Replace the cover.

Remember to remove batteries if you do not plan on using the Metal Detector for a week or more.

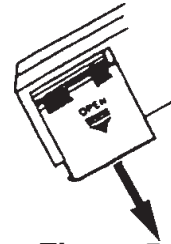

Figure 5

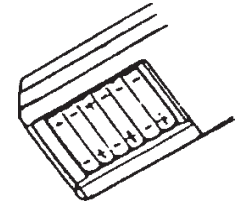

Figure 6

## Testing Batteries:

Always test the battery power when the Metal Detector does not turn on, has weak volume, will not tune properly, or has erratic operation.

Rotate **VOLUME** away from **OFF** and set **OPERATE / BATT** to **BATT TEST** (see Figure 7).

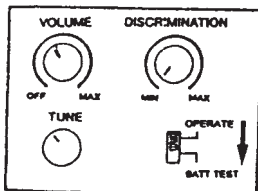

Figure 7

If the pointer on the viewmeter is between 3 and 6 (green area), the batteries have enough power to operate the detector. If the pointer is not in the green area, replace the batteries.

## Using Earphones:

Stereo earphones (not included) can be connected to the Metal Detector. Using earphones saves battery power and makes it easier to identify changes in the sound patterns. Earphones are connected to the ear jack on the side of the Control Housing (see Figure 8). When using earphones, protect your hearing by:

- a. Set the volume to the lowest setting before you begin listening. Adjust the volume to a comfortable level.
- b. Never listen at extremely high volume levels; permanent hearing loss can result.
- c. Once the volume is set, do not increase it. Over time, your ears adapt to the volume level, so a volume level that does not cause discomfort might still damage your hearing.

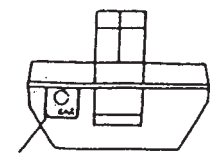

EAR Figure 8

## Operation:

This metal detector distinguishes between ferrous and non-ferrous metals. Ferrous metals contain iron. Non-ferrous metals do not (examples: gold, silver, copper, platinum, aluminum, lead, and zinc).

When the Metal Detector senses a metallic object, the meter reading changes and the detector might sound a tone. The reaction depends on what metal is detected.

### Turning on and Tuning the Metal Detector:

While holding the detector in a comfortable position, rotate the **VOLUME** away from **OFF** to the desired sound level. Set **OPERATE/BATT TEST** to **OPERATE** to detect (see Figure 9).

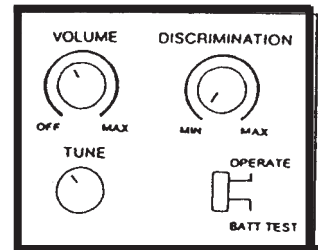

Figure 9

**TUNE** fine tunes the balance between the detector's receiver and transmitter. This provides consistent pointer and tone indications. To set **TUNE**: Rotate **VOLUME** to the 11 o'clock position. Set **DISCRIMINATION** to its midpoint (see Figure 10).

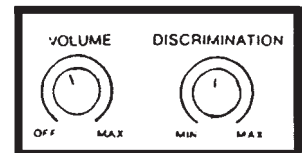
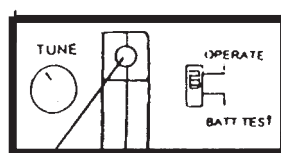

Figure 10

Hold the search coil about 1 foot from the ground. Hold down the red button on the handle, and slowly rotate **TUNE** left to right until the pointer on the viewmeter rests at or near 0; then release the red button.



Red Button

Figure 11

As the search continues, you can fine-tune the detector using **DISCRIMINATION**.

Note: To return the pointer to 0 at any time, simply press down on the red button.

### To Test and Use the Metal Detector:

Before using the detector for the first time, you should test the unit to see how it reacts to different metals. You can conduct this test outdoors or indoors.

#### For indoor test:

1. After removing watches, rings or any other metal jewelry, place the detector on a wooden or plastic table (search coil's angle so that the flat part faces upward) - see Figure 12. Note: never test on a floor inside a building, as it may have a type of metal present.

2. Rotate **VOLUME** to the 11 o'clock position.

3. Set **DISCRIMINATION** to its midpoint.

4. Take the sample of material to be tested (example: coin or gold ring) and place it about 2 inches above the search coil. Note: the Metal Detector will not detect without motion. You must move the object since you are not sweeping the Metal Detector.

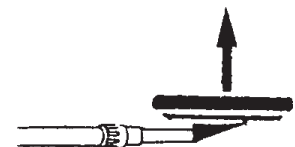

Figure 12

## For Indoor Test (continued)

5. If the detector detects the material, it sounds a tone and the pointer moves to the left (ferrous) or to the right (non-ferrous) while the detector determines the type of metal it is detecting (see Figure 13).

6. If the detector does not detect the material, the battery power may be low. Also verify that the search coil is properly connected. The detector may also need to be fine tuned (see directions below and on the next page).

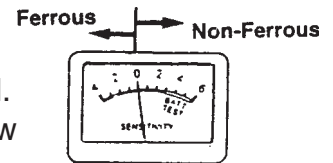

Figure 13

### Outdoor Testing and Use:

1. Locate an area outdoors where there is no metal present. Place a sample of the material to be tested (coin or gold ring) on the ground.

2. Rotate **VOLUME** about two-thirds clockwise.

3. Press and release the red button on the handle. Slowly rotate **TUNE** until the pointer is at or near **0**. A tone should be barely heard.

4. With the search coil being held approximately 1 to 2 inches above the ground, slowly move the search coil over the area where you placed the sample. Sweep in a side to side motion as follows:

Sweep slowly to avoid missing targets. Never raise the sweep coil while sweeping; sweep back and forth as if it was a pendulum (see Figure 14).

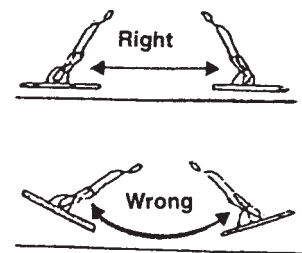

Figure 14

If the detector successfully detects the material, it will sound a tone and the pointer will move to the type of metal it found. If nothing was detected, try again (make sure the search coil is being moved properly).

The detector will respond strongly when it detects most valuable metal objects. If the signal does not repeat after being swept over the target a few times, the target is probably junk metal.

False signals can occur from electrical interference, large, irregular pieces of junk metal, or finding trash on the ground. False signals usually occur broken or are non-repeatable.

After finding a metal item, wait a few seconds after the tone stops before continuing; this allows the detector time to reset. You can also press the red button on the handle to return the pointer to the center of the viewmeter.

### Fine Tuning the Metal Detector:

Once you practice with the unit, you can fine tune it to make it more selective in what is found. The ability to distinguish between different types of metal is termed discrimination.

The **DISCRIMINATION** setting determines whether the detector will distinguish between different types of ferrous and non-ferrous metals.

You can set **DISCRIMINATION** to the minimum level (fully counterclockwise) or to the maximum level (fully clockwise) or anywhere in between. As you set it to higher levels, the detector first does not detect small pieces of silver paper, then thick foil, and finally metal objects like pull tabs from soda cans (see Figure 15).

Note: As you move to a new area, you must adjust **DISCRIMINATION**.

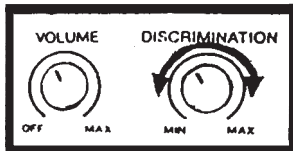

**Figure 15**

As you sweep the search coil back and forth over the ground surface you will recognize the difference between signals that occur at random and signals that are stable and repeatable. The key is to dig only for those targets that produce a strong, repeatable signal. This will prevent you from wasting time focusing on trash induced signals.

No metal detector is totally accurate. Many conditions influence the success of metal detection. Among the factors that influence results are the angle at which the object rests in the ground, the depth of object, the amount of iron the object contains and the size of the object.

To accurately pinpoint a target: 1. Once the detector detects a target that is buried, continue to sweep the search coil over the target in a narrowing side-to-side motion. 2. Stop the search coil directly over the spot on the ground. Then move the search coil straight forward away from you and straight back towards you. Make a mental note of the exact spot on the surface where the detector beeps. Repeat these steps in an X pattern. The target should be directly below the X at the area where the loudest response is heard.

### **Troubleshooting:**

#### **Problem**

False signals are being displayed

#### **Suggestion for Cure**

Sweeping too fast or at the wrong angle.  
Heavily oxidized metals are detected.  
Pinpoint the target from several different angles. If the detector does not display and sound the same signal each time, the target is probably heavily oxidized metal.

Once a target is found, the display does not show the correct metal type

May be more than one target in the area.  
If target is heavily oxidized, an incorrect reading may occur. This does not signify a problem with the detector. It may be a type of metal which is not recognizable to the detector.

## ELECTRICAL PARTS LIST

Ref. No.	Description	Mfr's Part No.
<b>Capacitors</b>		
C1	Ceramic 0.01 $\mu$ F $\pm$ 10% 63 V	CT1
C2	Ceramic 0.01 $\mu$ F $\pm$ 10% 63 V	CT1
C3	Ceramic 560 pF $\pm$ 10% 100 V	CC4
C4	*Mylar 0.1 $\mu$ F $\pm$ 10% 100 V	CL21
C5	Ceramic 560 pF $\pm$ 10% 100 V	CC4
C6	Electric 100 $\mu$ F +50%-10% 10 V	CD11
C7	Ceramic 0.01 $\mu$ F $\pm$ 10% 63 V	CT1
C8	Mylar 0.1 $\mu$ F $\pm$ 10% 100 V	CL21
C9	Electric 47 $\mu$ F +50%-10% 10 V	CD11
C10	Ceramic 0.01 $\mu$ F $\pm$ 10% 63 V	CT1
C11	Mylar 0.01 $\mu$ F $\pm$ 10% 63 V	CL11
C12	Ceramic 0.01 $\mu$ F $\pm$ 10% 63 V	CT1
C13	Ceramic 0.047 $\mu$ F $\pm$ 10% 63 V	CT1
C14	Electric 47 $\mu$ F +50%-10% 10 V	CD11
C15	Ceramic 0.1 $\mu$ F $\pm$ 10% 63 V	CT1
C16	Mylar 0.15 $\mu$ F $\pm$ 10% 100 V	CL21
C17	Mylar 0.15 $\mu$ F $\pm$ 10% 100 V	CL21
C18	Mylar 0.01 $\mu$ F $\pm$ 10% 63 V	CL11
C19	Mylar 0.47 $\mu$ F $\pm$ 10% 100 V	CL21X
C20	Ceramic 0.01 $\mu$ F $\pm$ 10% 63 V	CT1
C21	Ceramic 0.01 $\mu$ F $\pm$ 10% 63 V	CT1
<b>Diodes</b>		
D1	Zaner Diode BS-62 5.6 V	BS-62 5.6 V
D2	Redtify Diode IN4001	IN4001
D3	Zaner Diode DS-62 9.1 V	BS-62 9.1 V
<b>Intergrated Circuits</b>		
IC1	CD4069	CD4069
IC2	CD4070	CD4070
IC3	LM358	LM358
IC4	CA3140	CA3140
<b>Inductors</b>		
L1	Transmitter Coil	SQC5.775.019
L2	Receiver Coil	SQC5.775.020
L3	Inductor 15 $\mu$ H	LGA0307-R15K
L4	Inductor 15 $\mu$ H	LGA0307-R15K
<b>Transistors</b>		
Q1	Transistor 9015C	9015C
Q2	Transistor 9014C	9014C
Q3	Transistor 9013G	9013G
Q4	Transistor 9014C	9014C
Q5	Transistor 9014C	9014C
Q6	Transistor 9013G	9013G

\*Mylar is a registered trademark of E.I. DuPont de Nemours and Company.



## ELECTRICAL PARTS LIST – CONTINUED

Ref. No.	Description	Q.	Mfr's Part No.
<b>Resistors</b>			
R1	Resistor 100 kohm		RT14-0.25
R2	Resistor 6.8 kohm		RJ14-0.25
R3	Resistor 430 kohm		RT14-0.25
R4	Resistor 220 ohm		RT14-0.25
R5	Resistor 47 ohm		RT14-0.25
R6	Resistor 100 kohm		RT14-0.25
R7	Resistor 100 kohm		RT14-0.25
R8	Resistor 430 kohm		RT14-0.25
R9	Resistor 150 kohm		RT14-0.25
R10	Resistor 1.5 kohm		RT14-0.25
R11	Resistor 330 kohm		RT14-0.25
R12	Resistor 100 kohm		RT14-0.25
R13	Resistor 1 Mohm		RT14-0.25
R14	Resistor 330 kohm		RT14-0.25
R15	Resistor 47 kohm		RT14-0.25
R16	Resistor 100 kohm		RT14-0.25
R17	Resistor 22 kohm		RT14-0.25
R18	Resistor 10 ohm		RT14-0.25
R19	Resistor 1 Mohm		RT14-0.25
R20	Resistor 75 kohm		RT14-0.25
R21	Resistor 100 kohm		RT14-0.25
R22	Resistor 10 kohm		RT14-0.25
R23	Resistor 10 kohm		RT14-0.25
R24	Resistor 820 ohm		RT14-0.25
R25	Resistor 820 ohm		RT14-0.25
R26	Resistor 51 kohm		RJ14-0.25
R27	Resistor 820 ohm		RT14-0.25
R28	Resistor 27 kohm		RT14-0.25
R29	Resistor 15 ohm		RT14-0.25
R30	Resistor 100 kohm		RT14-0.25
R31	Resistor 470 kohm		RT14-0.25
R32	Resistor 51 ohm		RT14-0.25
<b>Protentionmeter</b>			
RV1	50K-B-30ZS-13 (Disc Control)		RV-17
RV2	5K-2		WI02
RV3	5K-B-30ZS-13 (Volume Control)		RV-17
RV4	10K-B-30ZS-13 (Tune Control)		RV-17
<b>Switches</b>			
S2	Button Switch		PBS-2201-NL
S3	2P2T Side Switch (NOR/B1)		SS22F18G10
<b>Miscellaneous and Connection Wire</b>			
	Insulated Wire (Red) 230 mm Long (Ear Socket)		DUY-3-1(10x7/0.15)
	Insulated Wire (Yellow) 230 mm Long (Ear Socket)		DUY-3-1(10x7/0.15)
	Insulated Wire (Green) 230 mm Long (Ear Socket)		DUY-3-1(10x7/0.15)
	Insulated Wire (Blue) 230 mm Long (Ear Socket)		DUY-3-1(10x7/0.15)
	Insulated Wire (Purple) 200 mm Long (Speaker)		DUY-3-1(10x7/0.15)
	Insulated Wire (Grey) 200 mm Long (Speaker)		DUY-3-1(10x7/0.15)
	Insulated Wire (White) 180 mm Long (Battery Box)		DUY-3-1(10x7/0.15)
	Insulated Wire (Black) 180 mm Long (Battery Box)		DUY-3-1(10x7/0.15)
	Insulated Wire (Brown) 160 mm Long (Meter)		DUY-3-1(10x7/0.15)

# WIRING DIAGRAM

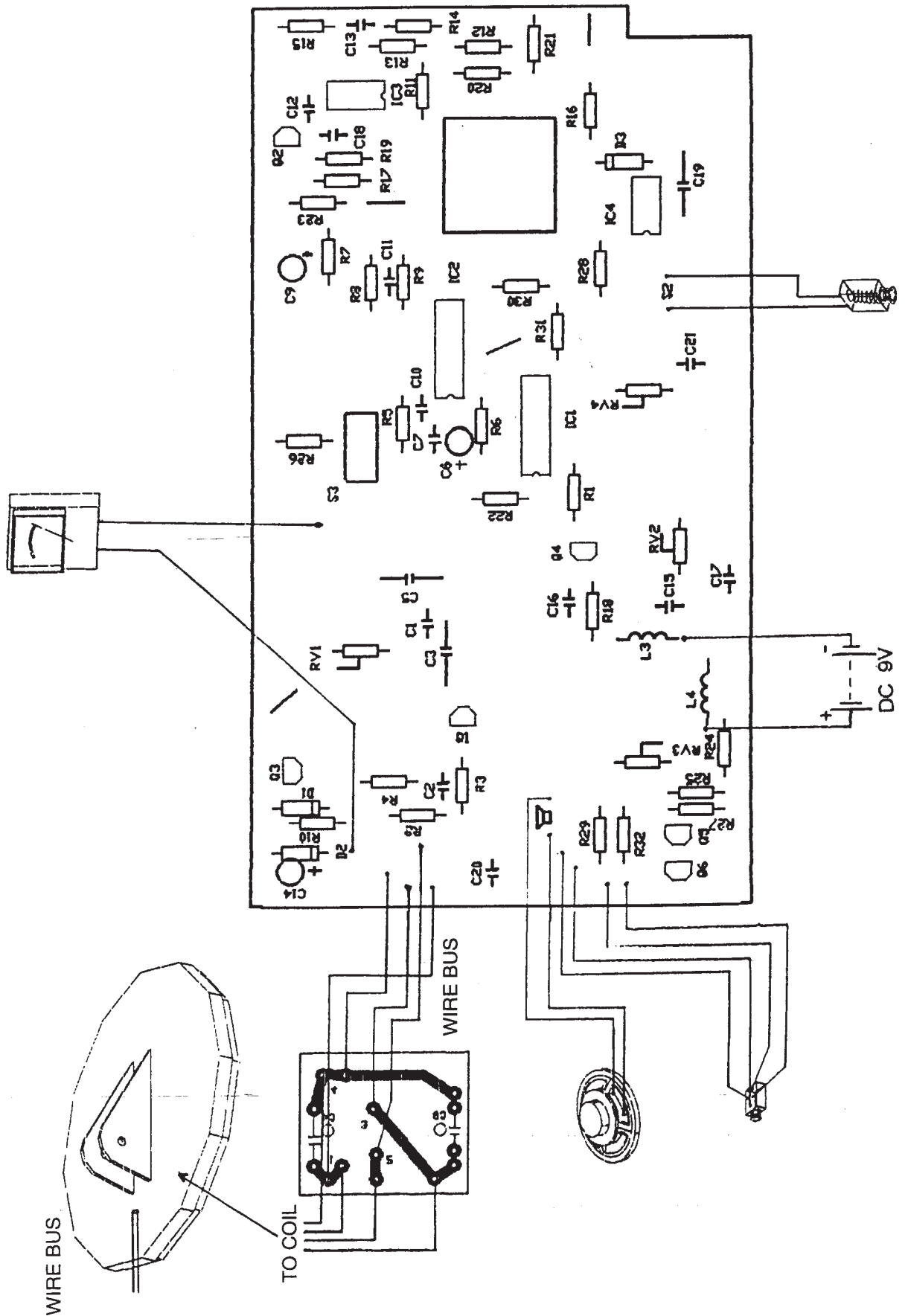

## MECHANICAL PARTS LIST

Ref. No.	Description	Mfr's Part No.
1	Push Button (Red)	SQC8.337.012
2	Push Button Switch	PBS-2201-NL
3	Handle (Left)	SQC8.333.012
4	Handle (Right)	SQC8.333.011
5	Screw ST2.9 x 12	GB845-85
6	Nut M3 (Handle Mounting)	GB39-88
7	Control Box Top	SQC6.116.046
8	Meter	M3005
9	Speaker Paper	SQC7.844.016
10	Speaker	YD-50 8 ohm 0.25 W
11	Control Knob	SQC8.337.333
12	Main PCB Board	SQC2.908.527
13	Lining Board	SQC7.840.251
14	Sponge 20 x 20 mm	SQC7.840.253
15	Screw ST2.9 x 12	GB845-85
16	Sponge	SQC7.840.252
17	Earphone Socket	
18	Control Box Bottom	SQC6.116.047
19	Screw M3 x 20	GB818-85
20	Battery Cover	SQC7.852.074
21	Screw ST2.9 x 12	GB845-85
22	Screw M3 x 40 (Controller Box Mounting)	GB820-85
23	Screw M3 x 25	GB820-85
24	Nut M3	GB61 72-86
25	Aluminum Stem Large ø19 mm	SQC7.756.009
26	Aluminum Stem Small ø16 mm	SQC7.756.008
27	Search Head	SQC6.680.011
28	Head Fixing Knob (Screw Side)	SQC6.354.022
29	Stem Lock Ring (Threaded)	SQC8.225.012
30	Stem Lock Ring	SQC8.220.081
31	Stem Lock Ring	SQC8.220.011
32	Head Fixing Knob (Nut Side)	SQC6.354.021
33	Bushing	SQC7.860.081
<b>PACKING</b>		
	Plastic Packet	SQC8.840.052
	Gift Box	SQC6.876.213
	Packing Box	SQC6.876.212
	Spacer	SQC8.865.017
	Spacer	SQC8.865.016
	Spacer	SQC8.865.018
	Lining	SQC8.866.194
	Manual	

PLEASE READ THE FOLLOWING CAREFULLY

THE MANUFACTURER AND/OR DISTRIBUTOR HAS PROVIDED THE PARTS DIAGRAM IN THIS MANUAL AS A REFERENCE TOOL ONLY. NEITHER THE MANUFACTURER NOR DISTRIBUTOR MAKES ANY REPRESENTATION OR WARRANTY OF ANY KIND TO THE BUYER THAT HE OR SHE IS QUALIFIED TO MAKE ANY REPAIRS TO THE PRODUCT OR THAT HE OR SHE IS QUALIFIED TO REPLACE ANY PARTS OF THE PRODUCT. IN FACT, THE MANUFACTURER AND/OR DISTRIBUTOR EXPRESSLY STATES THAT ALL REPAIRS AND PARTS REPLACEMENTS SHOULD BE UNDERTAKEN BY CERTIFIED AND LICENSED TECHNICIANS AND NOT BY THE BUYER. THE BUYER ASSUMES ALL RISK AND LIABILITY ARISING OUT OF HIS OR HER REPAIRS TO THE ORIGINAL PRODUCT OR REPLACEMENT PARTS THERETO, OR ARISING OUT OF HIS OR HER INSTALLATION OF REPLACEMENT PARTS THERETO.

Note: Some parts are listed and shown for illustration purposes only and are not available individually as replacement parts.

## TROUBLESHOOTING

Symptom	Cause	Remedy
1. No (output) sound and meter reading	<ul style="list-style-type: none"><li>Defective battery clip.</li><li>Broken battery wire to PCB</li><li>Defective VOLUME Control (RV3) Switch "S1"</li></ul>	<ul style="list-style-type: none"><li>Replace</li><li>Replace</li><li>Replace</li></ul>
2. No sound or noisy	<ul style="list-style-type: none"><li>Open speaker.</li><li>Broken speaker or earphone jack connections.</li><li>Defective headphone jack.</li><li>Q5, Q6 Defective.</li></ul>	<ul style="list-style-type: none"><li>Replace</li><li>Repair connections</li><li>Replace</li></ul>
3. No meter indication	<ul style="list-style-type: none"><li>Defective meter connection</li><li>Defective meter.</li></ul>	<ul style="list-style-type: none"><li>Repair</li><li>Replace</li></ul>
4. Auto-Tune does not function	<ul style="list-style-type: none"><li>Broken auto-tune switch connection</li><li>IC1, IC2, IC3, IC4 defective</li></ul>	<ul style="list-style-type: none"><li>Repair connection</li><li>Check and replace IC.</li></ul>
5. No response to any metal	<ul style="list-style-type: none"><li>Defective transistor Q1</li><li>Defective coil connections</li><li>Defective coil L1 or L2.</li></ul>	<ul style="list-style-type: none"><li>Check and replace</li><li>Check and replace</li><li>Check and repair.</li></ul>
6. Sensitivity too low	<ul style="list-style-type: none"><li>Search coil out of alignment</li><li>Batteries voltage is too low</li><li>Exposure to too high humidity -internal corrosion</li></ul>	<ul style="list-style-type: none"><li>Replace search head</li><li>Replace indicated components.</li></ul>

# Parts Diagram

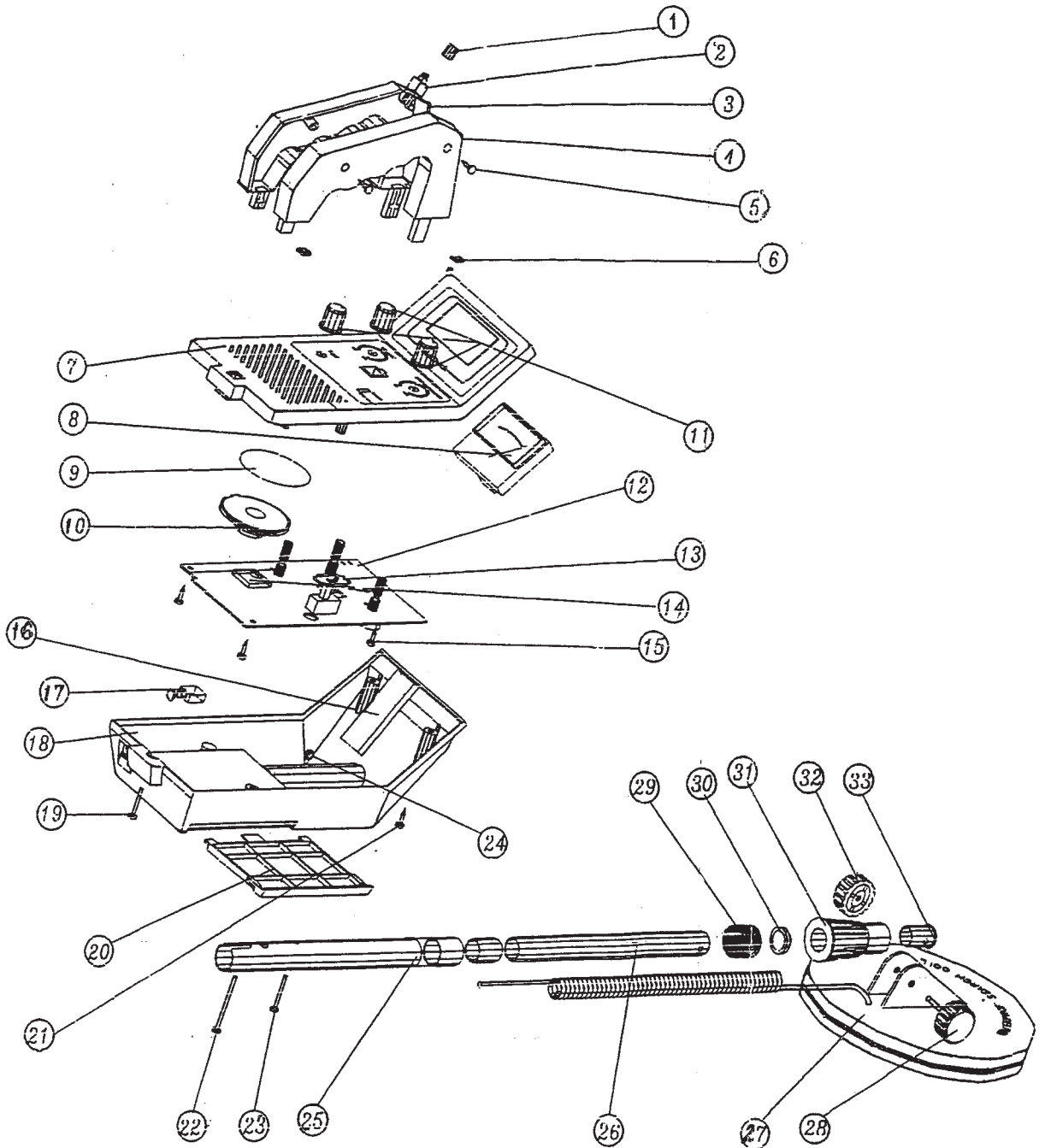

## Free Manuals Download Website

<http://myh66.com>

<http://usermanuals.us>

<http://www.somanuals.com>

<http://www.4manuals.cc>

<http://www.manual-lib.com>

<http://www.404manual.com>

<http://www.luxmanual.com>

<http://aubethermostatmanual.com>

Golf course search by state

<http://golfingnear.com>

Email search by domain

<http://emailbydomain.com>

Auto manuals search

<http://auto.somanuals.com>

TV manuals search

<http://tv.somanuals.com>