

# CHICAGO

**Electric Power Tools**

## CORDLESS IMPACT WRENCH

### 1/2" DRIVE - 19.2 VOLT

**Model 92798**

### OPERATING INSTRUCTIONS



Distributed Exclusively by



**HARBOR FREIGHT  
TOOLS**



3491 Mission Oaks Blvd., Camarillo, CA 93011  
Visit our Web site at: <http://www.harborfreight.com>

**TO PREVENT SERIOUS INJURY,  
READ AND UNDERSTAND ALL WARNINGS  
AND INSTRUCTIONS BEFORE USE.**

Copyright©2005 by Harbor Freight Tools®. All rights reserved. No portion of this manual or any artwork contained herein may be reproduced in any shape or form without the express written consent of Harbor Freight Tools.

**For technical questions, please call 1-800-444-3353.**

## PRODUCT SPECIFICATIONS

Item	Description
Electrical Requirements	Power Output: 19.2 VDC Power Input: 120 VAC/60 Hz Charger Battery Type: 1.7Ah Panasonic® Charge Time: 1 Hour Fast Charge Charger Power Plug: 2 Prong, Polarized
Drive Size	1/2"
Trigger Type	Variable Speed 0-2300 RPM / 0-2300 BPM Reversible
Maximum Torque	260 Ft./Lbs.
Sockets Included	4 Qty – Sizes: 11/16", 3/4", 13/16", 7/8"
Overall Dimensions	11" L x 3-3/8" W x 10-7/8" H
Weight	7.3 Pounds

## UNPACKING

When unpacking, check to make sure all the parts shown on the **Parts List on page 13** are included. If any parts are missing or broken, please call Harbor Freight Tools at the number shown on the cover of this manual as soon as possible.

## SAVE THIS MANUAL

You will need this manual for the safety warnings and precautions, assembly, operating, inspection, maintenance and cleaning procedures, parts list and assembly diagram. Keep your invoice with this manual. Write the invoice number on the inside of the front cover. Keep this manual and invoice in a safe and dry place for future reference.

## GENERAL SAFETY RULES

 **WARNING!**

**READ AND UNDERSTAND ALL INSTRUCTIONS**  
Failure to follow all instructions listed below may result in electric shock, fire, and/or serious injury.

**SAVE THESE INSTRUCTIONS**

## WORK AREA

1. **Keep your work area clean and well lit.** Cluttered benches and dark areas invite accidents.
2. **Do not operate power tools in explosive atmospheres, such as in the presence of flammable liquids, gases, or dust.** Power tools create sparks

REV 03/05

which may ignite the dust or fumes.

3. **Keep bystanders, children, and visitors away while operating a power tool.** Distractions can cause you to lose control. Protect others in the work area from debris such as chips and sparks. Provide barriers or shields as needed.

### **ELECTRICAL SAFETY**

1. **Grounded tools must be plugged into an outlet properly installed and grounded in accordance with all codes and ordinances. Never remove the grounding prong or modify the plug in any way. Do not use any adapter plugs. Check with a qualified electrician if you are in doubt as to whether the outlet is properly grounded.** If the tools should electrically malfunction or break down, grounding provides a low resistance path to carry electricity away from the user.
2. **Double insulated tools are equipped with a polarized plug (one blade is wider than the other). This plug will fit in a polarized outlet only one way. If the plug does not fit fully in the outlet, reverse the plug. If it still does not fit, contact a qualified electrician to install a polarized outlet. Do not change the plug in any way.** Double insulation  eliminates the need for the three wire grounded power cord and grounded power supply system.
3. **Avoid body contact with grounded surfaces such as pipes, radiators, ranges, and refrigerators.** There is an increased risk of electric shock if your body is grounded.
4. **Do not expose power tools to rain or wet conditions.** Water entering a power tool will increase the risk of electric shock.
5. **Do not abuse the Power Cord. Never use the Power Cord to carry the tools or pull the Plug from an outlet. Keep the Power Cord away from heat, oil, sharp edges, or moving parts. Replace damaged Power Cords immediately.** Damaged Power Cords increase the risk of electric shock.
6. **When operating a power tool outside, use an outdoor extension cord marked “W-A” or “W”.** These extension cords are rated for outdoor use, and reduce the risk of electric shock.

### **PERSONAL SAFETY**

1. **Stay alert. Watch what you are doing, and use common sense when operating a power tool. Do not use a power tool while tired or under the influence of drugs, alcohol, or medication.** A moment of inattention while operating power tools may result in serious personal injury.

2. **Dress properly. Do not wear loose clothing or jewelry. Contain long hair. Keep your hair, clothing, and gloves away from moving parts.** Loose clothes, jewelry, or long hair can be caught in moving parts.
3. **Avoid accidental starting. Be sure the Power Switch is off before plugging in.** Carrying power tools with your finger on the Power Switch, or plugging in power tools with the Power Switch on, invites accidents.
4. **Remove adjusting keys or wrenches before turning the power tool on.** A wrench or a key that is left attached to a rotating part of the power tool may result in personal injury.
5. **Do not overreach. Keep proper footing and balance at all times.** Proper footing and balance enables better control of the power tool in unexpected situations.
6. **Use safety equipment. Always wear eye ANSI-approved safety impact eye goggles.** Dust mask, non-skid safety shoes, hard hat, or hearing protection must be used for appropriate conditions.

#### TOOL USE AND CARE

1. **Use clamps (not included) or other practical ways to secure and support the workpiece to a stable platform.** Holding the work by hand or against your body is unstable and may lead to loss of control.
2. **Do not force the tool. Use the correct tool for your application.** The correct tool will do the job better and safer at the rate for which it is designed.
3. **Do not use the power tool if the Power Switch does not turn it on or off.** Any tool that cannot be controlled with the Power Switch is dangerous and must be replaced.
4. **Disconnect the Power Cord Plug from the power source before making any adjustments, changing accessories, or storing the tool.** Such preventive safety measures reduce the risk of starting the tool accidentally.
5. **Store idle tools out of reach of children and other untrained persons.** Tools are dangerous in the hands of untrained users.
6. **Maintain tools with care. Keep tools clean and dry.** Properly maintained tools with a sharp cutting edge are less likely to bind and are easier to control. Do not use a damaged tool. Tag damaged tools “Do not use” until repaired.

7. **Check for misalignment or binding of moving parts, breakage of parts, and any other condition that may affect the tool's operation. If damaged, have the tool serviced before using.** Many accidents are caused by poorly maintained tools.
8. **Use only accessories that are recommended by the manufacturer for your model.** Accessories that may be suitable for one tool may become hazardous when used on another tool.



### SERVICE

1. **Tool service must be performed only by qualified repair personnel.** Service or maintenance performed by unqualified personnel could result in a risk of injury.
2. **When servicing a tool, use only identical replacement parts. Follow instructions in the “*Inspection, Maintenance, And Cleaning*” section of this manual.** Use of unauthorized parts or failure to follow maintenance instructions may create a risk of electric shock or injury.

### SPECIFIC SAFETY RULES

1. **Maintain a safe working environment.** Keep the work area well lit. Make sure there is adequate surrounding workspace. Always keep the work area free of obstructions, grease, oil, trash, and other debris. Do not use the Impact Wrench in areas near flammable chemicals, dusts, and vapors. Do not use this product in a damp or wet location.
2. **Maintain labels and nameplates on the Impact Wrench.** These carry important information. If unreadable or missing, contact Harbor Freight Tools for a replacement.
3. **When using the Impact Wrench, always maintain a firm grip on the tool with both hands.**
4. **Do not use the Impact Wrench or Charger (39) if it has been dropped, damaged, left outdoors, or immersed in liquid.**
5. **Do not charge the Battery (37) when the temperature is below 50 degrees Fahrenheit or above 104 degrees Fahrenheit.**
6. **Do not shake, drop, or strike the Battery (37).**
7. **To avoid electrical shock, do not pull or carry the Charger (39) by its Power Cord or pull the Power Cord around sharp corners or edges.** Do not

unplug the Charger by pulling on the Power Cord. Keep the Power Cord away from heated surfaces.

8. **To avoid electrical shock, do not handle the Charger (39), its Power Cord Plug, or the Impact Wrench with wet hands.**
9. **Keep the Handle of the Impact Wrench dry, clean, free from oil and grease.**
10. **Avoid unintentional starting.** Make sure you are prepared to begin work before turning on the Impact Wrench.
11. **Never leave the Charger (39) unattended when it is plugged into an electrical outlet.** Make sure to unplug it from its electrical outlet before leaving.
12. **Always turn off the Impact Wrench and unplug the Charger (39) from its electrical outlet before changing accessories or performing any inspection, maintenance, or cleaning procedures.**
13. **Always switch to a fresh Battery (37) when tool performance begins to diminish.** Severe heat is most destructive to a Battery. The more heat generated, the faster the Battery loses power. A Battery that gets too hot can be permanently damaged. Never over-discharge a Battery by using the tool even after tool performance is decreasing. Never attempt to discharge a tool's Battery by continuing to pull the tool's trigger. When tool performance begins to diminish, stop the tool, recharge the Battery, and use the fresh Battery for optimal performance.
14. **Battery (37) leakage may occur under extreme usage or temperature conditions.** If Battery fluid comes in contact with skin, wash with soap and water and rinse with lemon juice and vinegar. If the fluid comes into contact with the eyes, flush with water for several minutes and contact a doctor immediately.
15. **Never burn the Battery, as it can explode in a fire.** Do not charge the Impact Wrench with a leaking Battery. Contact local solid waste authorities for instructions on correct disposal or recycling of the Battery.
16.  **WARNING!** People with pacemakers should consult their physician(s) before using this product. Operation of electrical equipment in close proximity to a heart pacemaker could cause interference or failure of the pacemaker.
17.  **WARNING!** The warnings, precautions, and instructions discussed in this manual cannot cover all possible conditions and situations that may occur. The operator must understand that common sense and caution are factors, which cannot be built into this product, but must be supplied by the operator.

## GROUNDING

### WARNING!

Improperly connecting the grounding wire can result in the risk of electric shock. Check with a qualified electrician if you are in doubt as to whether the outlet is properly grounded. Do not modify the power cord plug provided with the tool. Never remove the grounding prong from the plug. Do not use the tool if the power cord or plug is damaged. If damaged, have it repaired by a service facility before use. If the plug will not fit the outlet, have a proper outlet installed by a qualified electrician.

## DOUBLE INSULATED TOOLS: TOOLS WITH TWO PRONG PLUGS

1. Tools marked "Double Insulated" do not require grounding. They have a special double insulation system which satisfies OSHA requirements and complies with the applicable standards of Underwriters Laboratories, Inc., the Canadian Standard Association, and the National Electrical Code.
2. Double insulated tools may be used in either of the 120 volt outlets shown in the following illustration. **(See Figure A.)**

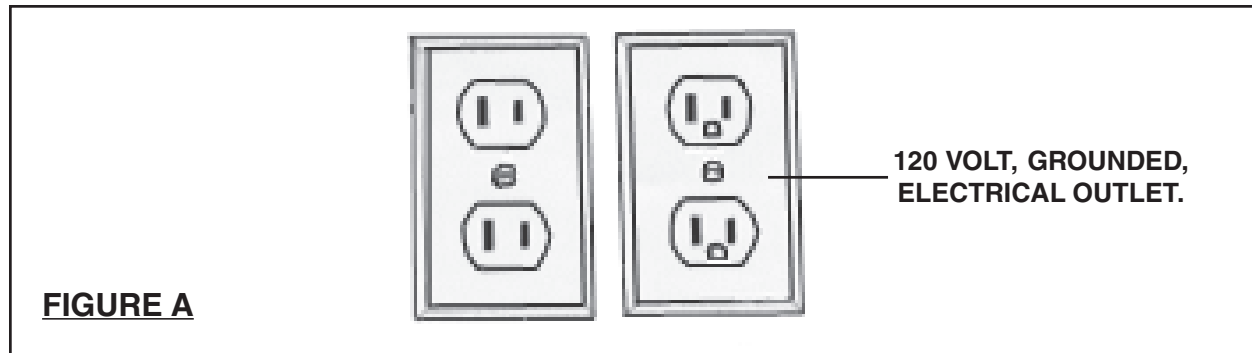

## EXTENSION CORDS

1. **Grounded** tools require a three wire extension cord. **Double Insulated** tools can use either a two or three wire extension cord.
2. As the distance from the supply outlet increases, you must use a heavier gauge extension cord. Using extension cords with inadequately sized wire causes a

serious drop in voltage, resulting in loss of power and possible tool damage.  
**(See Figure B.)**

3. The smaller the gauge number of the wire, the greater the capacity of the cord. For example, a 14 gauge cord can carry a higher current than a 16 gauge cord.  
**(See Figure B.)**
4. When using more than one extension cord to make up the total length, make sure each cord contains at least the minimum wire size required.  
**(See Figure B.)**
5. If you are using one extension cord for more than one tool, add the nameplate amperes and use the sum to determine the required minimum cord size.  
**(See Figure B.)**
6. If you are using an extension cord outdoors, make sure it is marked with the suffix "W-A" ("W" in Canada) to indicate it is acceptable for outdoor use.
7. Make sure your extension cord is properly wired and in good electrical condition. Always replace a damaged extension cord or have it repaired by a qualified electrician before using it.
8. Protect your extension cords from sharp objects, excessive heat, and damp or wet areas.



<b>RECOMMENDED MINIMUM WIRE GAUGE FOR EXTENSION CORDS*</b> <b>(120 VOLT)</b>					
<b>NAMEPLATE AMPERES (At Full Load)</b>	<b>EXTENSION CORD LENGTH</b>				
	<b>25 FEET</b>	<b>50 FEET</b>	<b>75 FEET</b>	<b>100 FEET</b>	<b>150 FEET</b>
<b>0-2.0</b>	<b>18</b>	<b>18</b>	<b>18</b>	<b>18</b>	<b>16</b>
<b>2.1-3.4</b>	<b>18</b>	<b>18</b>	<b>18</b>	<b>16</b>	<b>14</b>
<b>3.5-5.0</b>	<b>18</b>	<b>18</b>	<b>16</b>	<b>14</b>	<b>12</b>
<b>5.1-7.0</b>	<b>18</b>	<b>16</b>	<b>14</b>	<b>12</b>	<b>12</b>
<b>7.1-12.0</b>	<b>16</b>	<b>14</b>	<b>12</b>	<b>10</b>	<b>-</b>
<b>12.1-16.0</b>	<b>14</b>	<b>12</b>	<b>10</b>	<b>-</b>	<b>-</b>
<b>16.1-20.0</b>	<b>12</b>	<b>10</b>	<b>-</b>	<b>-</b>	<b>-</b>

**\*Based on limiting the line voltage drop  
to five volts at 150% of the rated amperes.**

**FIGURE B**



## SYMBOLOLOGY

	Double Insulated
	Canadian Standards Association
	Underwriters Laboratories, Inc.
V ~	Volts Alternating Current
A	Amperes
no xxx/min.	No Load Revolutions per Minute (RPM)

**FIGURE C**

## PRODUCT FEATURES

**NOTE:** For additional information regarding the parts listed in the following pages, refer to the **Assembly Diagram on page 13**.

-  **WARNING!** Always make sure the Trigger (36) of the Impact Wrench is in its “**OFF**” position, the Battery (37) is removed from the Impact Wrench, and the Charger (39) is unplugged from its electrical outlet prior to making any adjustments to the tool. **(See Figure D, next page.)**
- Trigger (36):** The Trigger is operated *manually* simply by squeezing the Trigger to turn on the Impact Wrench and releasing pressure on the Trigger to turn off the Impact Wrench. **(See Figure D.)**
- Forward/Reverse Switch (32):** The Forward/Reverse Switch allows you to change the rotational direction of the Impact Wrench. For a clockwise rotation, move the Forward/Reverse Button to the *right*. For a counterclockwise rotation, move the Forward/Reverse Button to the *left*. To avoid damage to the Impact Wrench, always wait until the tool completely stops before changing rotational directions. **(See Figure D.)**
- 1/2” Drive Impact Head (7):** The 1/2” Impact Head features a spring and ball to securely hold a socket. The Impact Head accepts all sizes of standard and metric sockets having a 1/2” drive. **(See Figure D.)**

REV 03/05

5. **Battery (37):** The power source for the Impact Wrench is a rechargeable, 19.2 VDC Battery. Make sure to follow all safety precautions when working with the Battery. **(See Figure D.)**
6. **Charger (39):** The Charger is powered by plugging its Power Plug into a 120 volt, grounded, electrical outlet. **NEVER** attempt to power the Charger with any other electrical source other than a 120 volt, grounded electrical outlet. **(See Figure D.)**

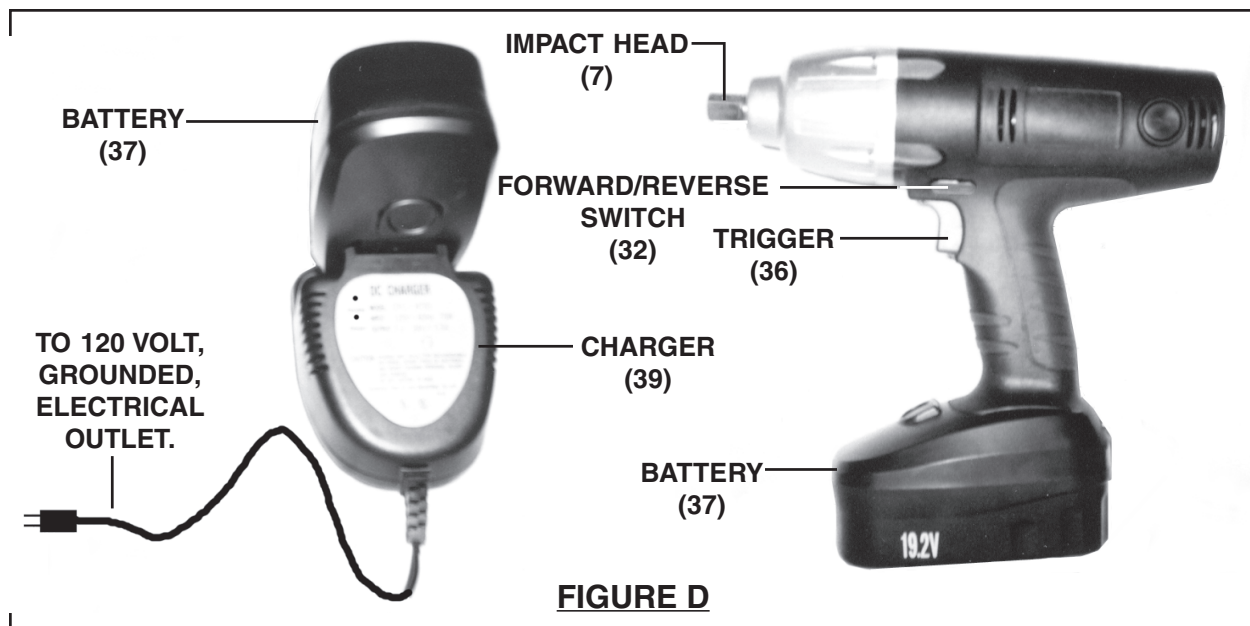

## TO CHARGE THE IMPACT WRENCH



1. **NOTE:** The Battery (37) requires charging. The first charge requires **1 hour** charge time prior to using the Impact Wrench. **(See Figure D.)**
2. The Battery (37) should only be recharged when the Impact Wrench begins to run slowly. **(See Figure D.)**
3. When the Battery (37) requires recharging, a **1 hour** charge allows the tool to operate at full power. Do not recharge the Battery longer than 1 hour, as damage to the Battery and/or Impact Wrench will occur. **(See Figure D.)**
4. Make sure the Trigger (36) on the Impact Wrench is in its “OFF” position. Slide the Battery (37) off the handle of the Impact Wrench. Insert the Battery into the charging socket of the Charger (39). Then plug the Charger into the nearest 120 volt, grounded, electrical outlet. **(See Figure D.)**

5. Verify that the **RED** Charging Indicator Light comes on. If it does not illuminate, check the power connection or try a different electrical outlet. Charge the Battery (37) for 1 hour. **NOTE:** When the Battery is fully charged the **RED** Charging Indicator Light will turn off, and the **GREEN** Charged Light will illuminate. Subsequent charging can also be done in 1 hour. **(See Figure D.)**
6. While charging, the Battery (37) and Charger (39) may become warm to the touch. This is normal, and does not indicate a problem. **(See Figure D.)**
7. Once the Battery (37) is fully charged, disconnect the Charger (39) from the electrical outlet. Remove the Battery from the Charger, and insert the Battery into the handle of the Impact Wrench. **(See Figure D.)**
8. **NOTE:** If charging more than one Battery (37), allow the Charger (39) to cool down before reusing. **(See Figure D.)**

## OPERATING INSTRUCTIONS

1. Before installing a socket, make sure the Battery (37) is removed from the Impact Wrench to avoid accidental starting. Then, firmly insert the Socket onto the 1/2" Impact Head (7) of the tool. **(See Figure D.)**
2. Whenever possible, secure the workpiece in place, using a vise or clamps (not included).
3. Insert the fully charged Battery (37) into the handle of the Impact Wrench. **(See Figure D.)**
4. Use the Forward/Reverse Switch (32) to select the turning rotation of the Impact Wrench. **(See Figure D.)**
5. Insert the socket onto the nut that is to be loosened/tightened.
6. Make sure to hold the Impact Wrench firmly with **both hands**, as torque from the Motor will cause the tool to twist. Then, squeeze the Trigger (36) to turn on the Impact Wrench. **(See Figure D.)**
7. When finished, release the Trigger (36) to stop the Impact Wrench. Then, remove the Battery (37) and socket from the tool. **(See Figure D.)**
8. Make sure to store the Impact Wrench in a dry, clean location out of reach of children and other unauthorized people.

## INSPECTION, MAINTENANCE, AND CLEANING

1.  **WARNING!** Always let the Trigger (36) rest in its “OFF” position, remove the Battery (37) from the tool, and unplug the Charger (39) from its electrical outlet before performing any inspection, maintenance, or cleaning.
2. **Before each use:** Inspect the general condition of the Impact Wrench. Check for misalignment or binding of moving parts, cracked or broken parts, leaking Battery, damaged Charger wiring, chipped or broken sockets, and any other condition that may affect its safe operation. If abnormal noise or vibration occurs, have the problem corrected before further use.  
**Do not use damaged equipment.**
3. **Daily:** With a clean cloth, remove all dirt, grease, and oil from the Impact Wrench. Do not immerse the Impact Wrench in any liquids.
4. It may become necessary at sometime to replace or clean the two Carbon Brushes (29) when the Motor performance decreases, or stops working completely.  
**To replace the Carbon Brushes:** Remove the two Brush Holder Caps (28). Then, remove the two Carbon Brushes (29), keeping track of the orientation and location of each. If either Carbon Brush is worn more than halfway, replace *both* Carbon Brushes. If the Carbon Brushes are just dirty, however, they may be cleaned by rubbing them with a pencil eraser. If cleaning and replacing used brushes, try to install them in the same holders and in the same direction they were removed. When installing the Carbon Brushes, make sure the carbon portion of the Carbon Brushes contact the Motor’s Rotor and that the springs face away from the Motor. Also, make sure the springs operate freely. After replacement or cleaning, replace the two Brush Holder Caps.  
**NOTE:** New Carbon Brushes tend to arc or spark when first used until they wear and conform to the Motor’s Rotor.
5.  **CAUTION!** All maintenance, service, or repairs not listed in this manual are only to be attempted by a qualified service technician.

## PLEASE READ THE FOLLOWING CAREFULLY

THE MANUFACTURER AND/OR DISTRIBUTOR HAS PROVIDED THE PARTS LIST AND ASSEMBLY DIAGRAM IN THIS MANUAL AS A REFERENCE TOOL ONLY. NEITHER THE MANUFACTURER OR DISTRIBUTOR MAKES ANY REPRESENTATION OR WARRANTY OF ANY KIND TO THE BUYER THAT HE OR SHE IS QUALIFIED TO MAKE ANY REPAIRS TO THE PRODUCT, OR THAT HE OR SHE IS QUALIFIED TO REPLACE ANY PARTS OF THE PRODUCT. IN FACT, THE MANUFACTURER AND/OR DISTRIBUTOR EXPRESSLY STATES THAT ALL REPAIRS AND PARTS REPLACEMENTS SHOULD BE UNDERTAKEN BY CERTIFIED AND LICENSED TECHNICIANS, AND NOT BY THE BUYER. THE BUYER ASSUMES ALL RISK AND LIABILITY ARISING OUT OF HIS OR HER REPAIRS TO THE ORIGINAL PRODUCT OR REPLACEMENT PARTS THERETO, OR ARISING OUT OF HIS OR HER INSTALLATION OF REPLACEMENT PARTS THERETO.

REV 04/06

SKU 92798

For technical questions, please call 1-800-444-3353.

Page 12

## PARTS LIST & ASSEMBLY DIAGRAM

Part #	Description	Part #	Description
1	Stun Screw (1)	21	Bearing (3)
2	Washer (1)	22	Armature
3	Front Cover	23	Plate
4	Oillite Bearing	24	Washer (2)
5	Rubber Washer	25	Stator
6	Plate Washer	26	Oillite Bearing (2)
7	Impact Head	27	Carbon Brush Shaft
8	Impact Shaft	28	Brush Holder Cap
9	Bearing (1)	29	Carbon Brush
10	Torque Spring	30	Brush Holder
11	Buffer Pad	31	Connector
12	Spring Pad	32	Forward/Reverse Switch
13	Master Impact Driver	33	Right Body
14	Steel Ball	34	Left Body
15	Planetary Gear	35	Carrying Strap
16	Straight Pin	36	Trigger
17	Bearing Pad	37	Battery
18	Bearing (2)	38	Stun Screw (2)
19	Inner Rim	39	Charger
20	Rim Shaft		

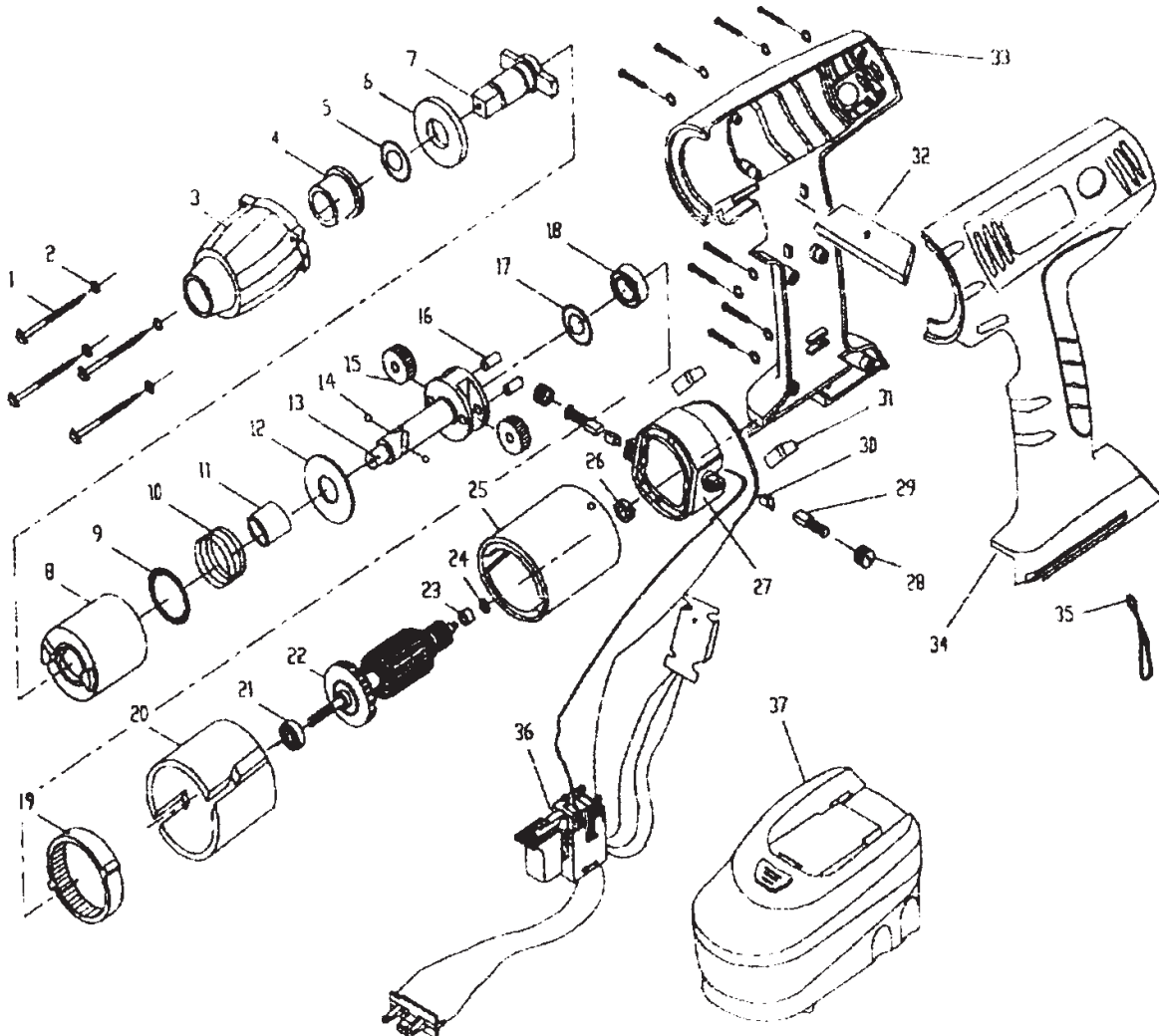

**NOTE:**

Some parts are listed and shown for illustration purposes only, and are not available individually as replacement parts.

## Free Manuals Download Website

<http://myh66.com>

<http://usermanuals.us>

<http://www.somanuals.com>

<http://www.4manuals.cc>

<http://www.manual-lib.com>

<http://www.404manual.com>

<http://www.luxmanual.com>

<http://aubethermostatmanual.com>

Golf course search by state

<http://golfingnear.com>

Email search by domain

<http://emailbydomain.com>

Auto manuals search

<http://auto.somanuals.com>

TV manuals search

<http://tv.somanuals.com>