

Wet Stone Grinder

Model 92683

ASSEMBLY AND OPERATING INSTRUCTIONS

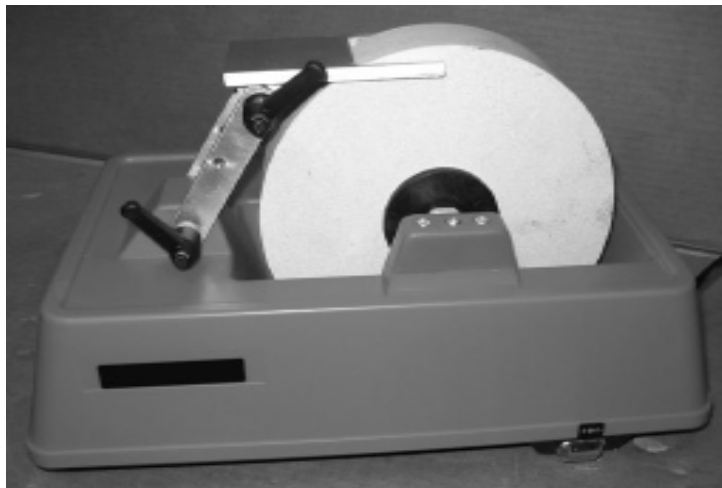

3491 Mission Oaks Blvd., Camarillo, CA 93011

Visit our Web site at <http://www.harborfreight.com>

Copyright © 2005 by Harbor Freight Tools®. All rights reserved.

No portion of this manual or any artwork contained herein may be reproduced in any shape or form without the express written consent of Harbor Freight Tools.

For technical questions and replacement parts, please call 1-800-444-3353

Specifications

Construction	Plastic Case, Belt Drive with Aluminum Guide	Wet Stone Size Spindle Dimension	6" Dia. x 1.65"W 5-1/4" x 15/32" – 18 TPI
Power Required	110 VAC, 85 Watts, 6.1 Amps (no load)	Motor Speed	150 - 200 RPM
Dimensions	15-1/4" L x 9" W x 9-1/4" H	Net Weight	14.5 lb.

This Wet Stone Grinder is ideal for sharpening knives, chisels, scissors, and similar cutting tools. The slow speed of the grinding wheel which is kept continually wet, prevents the blade from overheating and losing its temper. The continuous wet bath also helps keep the grinding wheel from clogging, thus extending its usable life. The grinder direction is reversible for various applications. An adjustable blade guide and safety shield are included. This grinder is rated for maximum continuous use time of 20 minutes. The included cardboard angle guide is helpful in setting the proper grinding angle for various items.

Save This Manual

You will need the manual for the safety warnings and precautions, assembly instructions, operating and maintenance procedures, parts list and diagram. Keep your invoice with this manual. Write the invoice number on the inside of the front cover. Keep the manual and invoice in a safe and dry place for future reference.

Safety Warnings and Precautions

WARNING: When using tool, basic safety precautions should always be followed to reduce the risk of personal injury and damage to equipment.

Read all instructions before using this tool!

1. **Keep your work area clean and well lit.** Cluttered benches and dark areas invite accidents.
2. **Do not operate power tools in explosive atmospheres, such as in the presence of flammable liquids, gases, or dust.** Power tools create sparks which may ignite the dust or fumes.
3. **Keep bystanders, children, and visitors away while operating a power tool.** Distractions can cause you to lose control. Protect others in the work area from debris such as chips and sparks. Provide barriers or shields as needed.
4. **Grounded tools must be plugged into an outlet properly installed and grounded in accordance with all codes and ordinances. Never remove the grounding prong or modify the plug in any way. Do not use any adapter plugs. Check with a qualified electrician if you are in doubt whether the outlet is properly grounded.** If the tool should electrically malfunction or break down, grounding provides a low resistance path to carry electricity away from the user.
5. **Double insulated tools are equipped with a polarized plug (one blade is wider than the other). This plug will fit in a polarized outlet only one way. If the plug does not fit fully in the outlet, reverse the plug. If it still does not fit, contact a qualified electrician to install a polarized outlet. Do not change the plug in any way.** Double insulation eliminates the need for the three wire grounded power cord and grounded power supply system.
6. **Avoid body contact with grounded surfaces such as pipes, radiators, ranges, and refrigerators.** There is an increased risk of electric shock if your body is grounded.
7. **Do not expose power tools to rain or wet conditions.** Water entering a power tool will increase the risk of electric shock.

8. **Do not abuse the Power Cord. Never use the Power Cord to carry the tool or pull the Plug from an outlet. Keep the Power Cord away from heat, oil, sharp edges, or moving parts. Replace damaged Power Cords immediately.** Damaged Power Cords increase the risk of electric shock.
9. **When operating a power tool outside, use an outdoor extension cord marked “W-A” or “W”.** These extension cords are rated for outdoor use, and reduce the risk of electric shock.

Personal Safety

10. **Stay alert. Watch what you are doing, and use common sense when operating a power tool. Do not use a power tool while tired or under the influence of drugs, alcohol, or medication.** A moment of inattention while operating power tools may result in serious personal injury.
11. **Dress properly. Do not wear loose clothing or jewelry. Contain long hair. Keep your hair, clothing, and gloves away from moving parts.** Loose clothes, jewelry, or long hair can be caught in moving parts.
12. **Avoid accidental starting. Be sure the Power Switch is off before plugging in.** Plugging in power tools with the Power Switch on, invites accidents.
13. **Remove adjusting keys or wrenches before turning the power tool on.** A wrench or a key that is left attached to a rotating part of the power tool may result in personal injury.
14. **Do not overreach. Keep proper footing and balance at all times.** Proper footing and balance enables better control of the power tool in unexpected situations.
15. **Use safety equipment. Always wear ANSI-approved eye protection, full face shield, and work gloves when using this grinder.** Dust mask, non-skid safety shoes, hard hat, or hearing protection must be used for appropriate conditions.

Tool Use and Care

16. **Be sure the sharpener is used only on a stable platform.** Be sure to use the blade guide, and wear safety glasses at all times when using this tool.
17. **Do not force the tool. Use the correct tool for your application.** The correct tool will do the job better and safer at the rate for which it is designed.
18. **Do not use the power tool if the Power Switch does not turn it on or off.** Any tool that cannot be controlled with the Power Switch is dangerous and must be replaced.
19. **Disconnect the Power Cord Plug from the power source before making any adjustments, changing accessories, or storing the tool.** Such preventive safety measures reduce the risk of starting the tool accidentally.
20. **Store idle tools out of reach of children and other untrained persons.** Tools are dangerous in the hands of untrained users.
21. **Maintain tools with care, keeping them adjusted and clean.** Properly maintained tools are less likely to bind and are easier to control. Do not use a damaged tool. Tag damaged tools “Do not use” until repaired.
22. **Check for misalignment or binding of moving parts, breakage of parts, and any other condition that may affect the tool’s operation. If damaged, have the tool serviced before using.** Many accidents are caused by poorly maintained tools.

23. **Use only accessories that are recommended by the manufacturer for your model.** Accessories that may be suitable for one tool may become hazardous when used on another tool.

Service

24. **Tool service must be performed only by qualified repair personnel.** Service or maintenance performed by unqualified personnel could result in a risk of injury.
25. **When servicing a tool, use only identical replacement parts.** Use of unauthorized parts or failure to follow maintenance instructions may create a risk of electric shock or injury.

Specific Safety Rules

1. **Maintain labels and nameplates on the tool.** These carry important information. If unreadable or missing, contact Harbor Freight Tools for a replacement.
2. **Always wear ANSI approved safety impact eye goggles when using the tool.** Using personal safety devices reduce the risk for injury. Safety impact eye goggles and other safety equipment are available from Harbor Freight Tools.
3. **Maintain a safe working environment.** Keep the work area well lit. Make sure there is adequate surrounding workspace. Always keep the work area free of obstructions, grease, oil, trash, and other debris. Do not use a power tool in areas near flammable chemicals, dusts, and vapors. Do not use this product in a damp or wet location.
4. **Make sure to read and understand all instructions and safety precautions as outlined in the manufacturer's manual.**
5. **When starting this power tool, always ensure that it remains in place on a stable work platform.**
6. **Always keep the extension cord away from moving parts on the tool.**
7. **Avoid unintentional starting.** Make sure you are prepared to begin work before turning on the tool.
8. **Do not force the tool.** This tool will do the work better and safer at the speed and capacity for which it was designed.
9. **Never walk away from the tool until the motor has come to a complete stop.** The tool may create unforeseen risk while the motor cycles down.
10. **Never leave the tool unattended when it is plugged into an electrical outlet.** Turn off the tool, and unplug it from its electrical outlet before leaving.
11. **Always unplug the tool from its electrical outlet before performing any inspection, maintenance, or cleaning procedures.**
12. **WARNING!** Some dust created by power sanding, sawing, grinding, drilling, and other construction activities, contain chemicals known (to the State of California) to cause cancer, birth defects or other reproductive harm. Some examples of these chemicals are: lead from lead-based paints, crystalline silica from bricks and cement or other masonry products, arsenic and chromium from chemically treated lumber. Your risk from these exposures varies, depending on how often you do this type of work. To reduce your exposure to these chemicals: work in a well ventilated area, and work with approved safety equipment, such as those dust masks that are specially designed to filter out microscopic particles. *(California Health & Safety Code 25249.5, et seq.)*
13. **WARNING!** People with pacemakers should consult their physician(s) before using this product. Electromagnetic fields in close proximity to a heart pacemaker could cause interference to or failure of the pacemaker.

GROUNDING

⚠ WARNING! Improperly connecting the grounding wire can result in the risk of electric shock. Check with a qualified electrician if you are in doubt as to whether the outlet is properly grounded. Do not modify the power cord plug provided with the tool. Never remove the grounding prong from the plug. Do not use the tool if the power cord or plug is damaged. If damaged, have it repaired by a service facility before use. If the plug will not fit the outlet, have a proper outlet installed by a qualified electrician.

GROUNDED TOOLS: TOOLS WITH THREE PRONG PLUGS

1. Tools marked with "Grounding Required" have a three wire cord and three prong grounding plug. The plug must be connected to a properly grounded outlet. If the tool should electrically malfunction or break down, grounding provides a low resistance path to carry electricity away from the user, reducing the risk of electric shock. **(See Figure A.)**
2. The grounding prong in the plug is connected through the green wire inside the cord to the grounding system in the tool. The green wire in the cord must be the only wire connected to the tool's grounding system and must never be attached to an electrically "live" terminal. **(See Figure A.)**
3. Your tool must be plugged into an appropriate outlet, properly installed and grounded in accordance with all codes and ordinances. The plug and outlet should look like those in the following illustration. **(See Figure A.)**

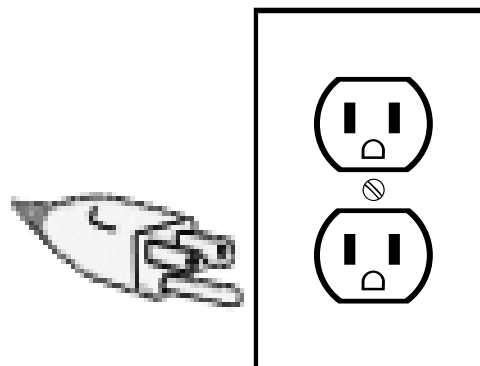

Figure A

DOUBLE INSULATED TOOLS: TOOLS WITH TWO PRONG PLUGS

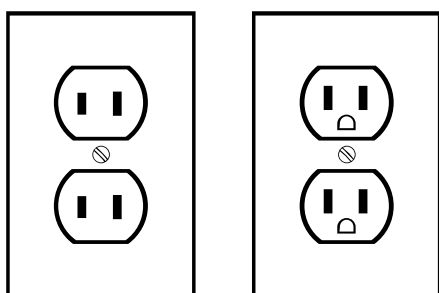

Figure B

4. Tools marked "Double Insulated" do not require grounding. They have a special double insulation system which satisfies OSHA requirements and complies with the applicable standards of Underwriters Laboratories, Inc., the Canadian Standard Association, and the National Electrical Code. **(See Figure B.)**
5. Double insulated tools may be used in either of the 120 volt outlets shown in the following illustration. **(See Figure B.)**

NOTE: The 92683 Wet Stone Grinder uses a non-polarized two-prong plug.



EXTENSION CORDS

1. **Grounded** tools require a three wire extension cord. **Double Insulated** tools can use either a two or three wire extension cord.
2. As the distance from the supply outlet increases, you must use a heavier gauge extension cord. Using extension cords with inadequately sized wire causes a serious drop in voltage, resulting in loss of power and possible tool damage. **(See Figure C.)**
3. The smaller the gauge number of the wire, the greater the capacity of the cord. For example, a 14 gauge cord can carry a higher current than a 16 gauge cord. **(See Figure C.)**
4. When using more than one extension cord to make up the total length, make sure each cord contains at least the minimum wire size required. **(See Figure C.)**
5. If you are using one extension cord for more than one tool, add the nameplate amperes and use the sum to determine the required minimum cord size. **(See Figure C.)**
6. If you are using an extension cord outdoors, make sure it is marked with the suffix "W-A" ("W" in Canada) to indicate it is acceptable for outdoor use.
7. Make sure your extension cord is properly wired and in good electrical condition. Always replace a damaged extension cord or have it repaired by a qualified electrician before using it.
8. Protect your extension cords from sharp objects, excessive heat, and damp or wet areas.

RECOMMENDED MINIMUM WIRE GAUGE FOR EXTENSION CORDS* (120 OR 240 VOLT)					
NAMEPLATE AMPERES (At Full Load)	EXTENSION CORD LENGTH				
	25 Feet	50 Feet	75 Feet	100 Feet	150 Feet
0 – 2.0	18	18	18	18	16
2.1 – 3.4	18	18	18	16	14
3.5 – 5.0	18	18	16	14	12
5.1 – 7.0	18	16	14	12	12
7.1 – 12.0	18	14	12	10	-
12.1 – 16.0	14	12	10	-	-
16.1 – 20.0	12	10	-	-	-

FIGURE C * Based on limiting the line voltage drop to five volts at 150% of the rated amperes.

SYMBOLOLOGY

	Double Insulated	$V \sim$	Volts Alternating Current
	Canadian Standards Association	A	Amperes
	Underwriters Laboratories, Inc.	n_0 xxxx/min.	No Load Revolutions per Minute (RPM)

Unpacking

When unpacking, check to make sure the following parts are included.

Grinder Unit with Grinding Wheel, and Angle Guide

If any parts are missing or broken, please call Harbor Freight Tools at the number on the cover of this manual.

WARNING: The brass components of this product contain lead, a chemical known to the State of California to cause birth defects (or other reproductive harm). (California Health & Safety code 25249.5, et seq.)

Operation

Preliminary Safety Check:

Before starting the grinder, with the power cord unplugged, and the Power Switch turned to the OFF ("O") position, check to ensure:

- a) The safety shield is in place and properly adjusted.
- b) The grinding stone can be revolved freely by hand.
- c) The Tool Rest is in place, adjusted to within 3mm of the face of the grinding stone, and firmly tightened in place.

Basic Operation:

- 1) With the power cord unplugged, and the Power Switch (6) turned OFF, fill the water container 1/2 full.
- 2) Adjust the Tool Rest (31) to the desired angle. (See Tool Rest Adjustment section on next page.)
- 3) Plug into an appropriate, circuit breaker protected 110/120 volt DC power outlet.
- 4) Press the Power Switch (6) to either "1→" (forward) or "1←" (reverse) positions, as required.
- 5) Allow the machine to run up to speed, and stay there for at least 30 seconds before beginning work. If the grinder does not run smoothly, refer to the section on page 8 on Grinding Wheel care. Be sure the Grinding Wheel is properly dressed and balanced before beginning work. Be sure the Grinding Wheel is running at full speed before beginning work.
- 6) Feed the workpiece smoothly into the Grinding Wheel (22). Do not apply heavy pressure or bump the workpiece against the Grinding Wheel. Apply light pressure on the work piece. Try to allow the Grinding Wheel to continue to turn at full speed as you work.



WARNING: Do not use this grinder over 30 minutes each hour, or longer than 20 minutes continuously. This will help prevent overheating of the grinder, and extend grinder life.

- 7) When done sharpening, move the Power Switch (6) to the OFF position. Allow the Grinding Wheel to come to a stop on its own. Do not manually stop the Grinding Wheel by grabbing it or holding an object against it. Stopping the Grinding Wheel causes stress and possible damage to the gears and belts.

Using the Angle Guide to adjust the Tool Rest angle

You can use the angle guide to adjust the Tool Rest (31) to best sharpen your tools.

- 1) Determine the best sharpening angle for your tool. The included angle guide has several useful angles for sharpening knives, chisels and other hand tools.
- 2) To adjust the tool rest's position, the unit has two Tool Rest Adjusters (34). The bottom one adjusts the arm's angle, and the top adjusts the rest's angle. The adjusters have two positions: In the normal position, they adjust the tightness of the joint. If they are pulled out, they can turn freely to go to the beginning of the turn. They are spring loaded, so they automatically return to the first position.
- 3) Place the Grinding Guide on the Grinding Wheel as shown in the photo, using the selected grinding angle.
- 4) Adjust the Tool Rest (31) vertically, then push it forward against the Grinding Guide. The edge of the Tool Rest (31) should be within 1/16" of the grinding wheel.
- 5) Tighten the Tool Rest Adjusters (34) To fix the Tool Rest in place. The adjusters should not be over tightened, as they will break.

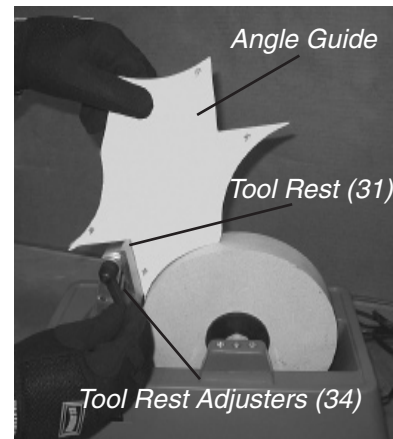

Effective Sharpening

- 1) For best results, the Grinding Wheel should be turning toward the blade.
- 2) Hold the blade flat against the Tool Rest (31), and move it lightly against the Grinding Wheel (22) as you move it from one side to the other. Reverse the blade, and move it again lightly against the Grinding Wheel from side to side. Do not aggressively feed the blade into the Grinding Wheel. Repetitive light passes on each side of the blade will produce best results.
- 3) After grinding the blade, use a burnisher, fine whetstone or knife steel (not included) to remove microscopic burrs from the blade edge.

Maintenance

Dressing the Grinding Wheel

For best sharpening results, it is important to maintain the Grinding Stone in good condition. With use the Grinding Stone will wear, and may become out of round or uneven. Dressing the Grinding Wheel will restore its proper shape and roundness.

The stone must be dry to dress it. Pour the water out of the Grinder, and allow time for the Grinding Wheel to thoroughly dry before dressing.

To dress the Grinding Wheel, hold a dressing tool (available separately from Harbor Freight Tools) or a flat piece of hardened steel (not included) against the Grinding Wheel as it turns. It is important to hold this tool firmly, and supported by the Tool Rest as you are shaping the Grinding Wheel. Slowly feed the dressing tool or piece of steel into the Grinding Wheel, until the Grinding Wheel fully contacts the dressing tool. The Grinding Wheel should now be even and round. Observe the Grinding Wheel spinning freely for a few seconds to determine its condition. If necessary, continue to dress the wheel until it spins smoothly.

Changing the Grinding Wheel

Eventually, the Grinding Wheel may require replacement. The Grinding Wheel should be replaced when it has lost approx. 25% of its diameter. Suitable Grinding Wheels are available from Harbor Freight Tools.

- 1) Ensure that the replacement Grinding Wheel is no greater than 8" in Diameter nor 1.65" in Width. The bore must be designed to fit a 15/32" Spindle.
- 2) Be sure the Grinder is unplugged and turned OFF.
- 3) Pour the water out by tilting the grinder to the rear.
- 4) Remove the two outermost screws on each Bearing Block, and set the Bearing Blocks aside (as shown in the photo at right).



5) Remove the Grinding Wheel assembly by lifting it straight up, as shown in the photo at left.

6) Remove the Brass Bearing, V-ring (19), two Nuts (20), and Flange (21). You may now slide the old Grinding Wheel off the Axle (23). See photo on right.

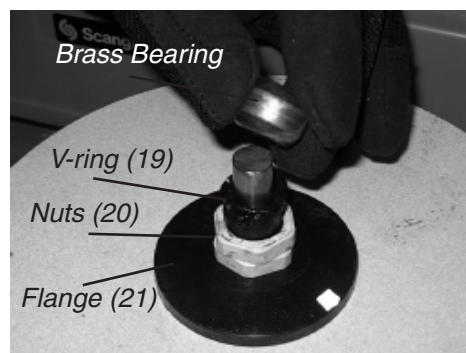
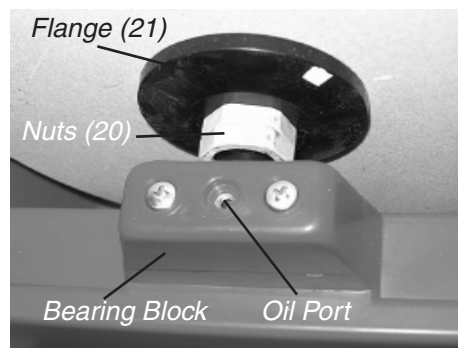

- 7) Install the new Grinding Wheel, and replace the Flange (21) and Nuts (20) as they were before. Do not over tighten the Nuts. The Grinding Wheel assembly should then be reassembled, the bearings and gear greased, and carefully put back in place so that the gear meshes properly and so that both v-rings sit nicely into the groove, creating a good seal. Replace the Bearing Blocks. When replacing the Bearing Blocks, attention should also be given to the v-rings to make sure that they are in place. Both Bearing Blocks should be tightened down enough to provide a good seal.
- 8) Test the Grinder to ensure that the new Grinding Wheel runs smoothly. If it does not, try loosening the Nuts (20) and reposition the new Grinding Wheel on the Axle. If, after several tries, this does not solve the problem, tighten the Nuts and dress the wheel as discussed above.

Periodic Maintenance

- 1) Unplug the Grinder before cleaning or adjusting. Pour the water out by tilting the grinder to the rear.
- 2) Once a year, place a small amount of lubricating oil in the oil ports on top of the bearing blocks on each side of the Grinding Wheel. The center screw above each bearing covers the oiling port. The screw is simply removed and several drops of oil are added periodically.
- 3) When storing the Grinder, empty it of water, and cover to prevent dirt accumulation.

Parts List

Part	Description
1	Power Cord
2	Power Cord Support
3	Screw m2, 9X9, 5
4	Sleeve
5	Cable
6	Power Switch
7	Power Switch Cover
8	Flat Plug
9	Motor 110 VAC
10	Nut m8
11	Screw m6 x 55
12	Cog-Belt wheel 44t
13	Nut m6
14	Toothed Belt 130XL
15	Geared Motor Wheel
16	Screw m4 x 14
17	Retaining Plate for Motor
18	Screw m4 x 6
19	V-ring
20	Nut PG11
21	Flange
22	Grinding Wheel

Part	Description
23	Axle with Flange
24	Base
25	Screw m4 x 45
26	Spring Washer m4
27	Housing
28	Toothed Belt Drive 35t
29	C-clip 12mm
30	Toothed Belt 110XL
31	Tool Rest
32	Hand Grip m6
33	Spring
34	Disk m6
35	Aluminum Bar
36	Cover m6 x 60
37	Relief Clamp
38	Condenser
39	Small Cover
40	Large Cover
41	Axle Housing for Gear Wheel
42	Screw m2, 9 x 19
43	Screw m4 x 12

NOTE: Some parts are listed and shown for illustration purposes only and are not available individually as replacement parts.

Assembly Drawing

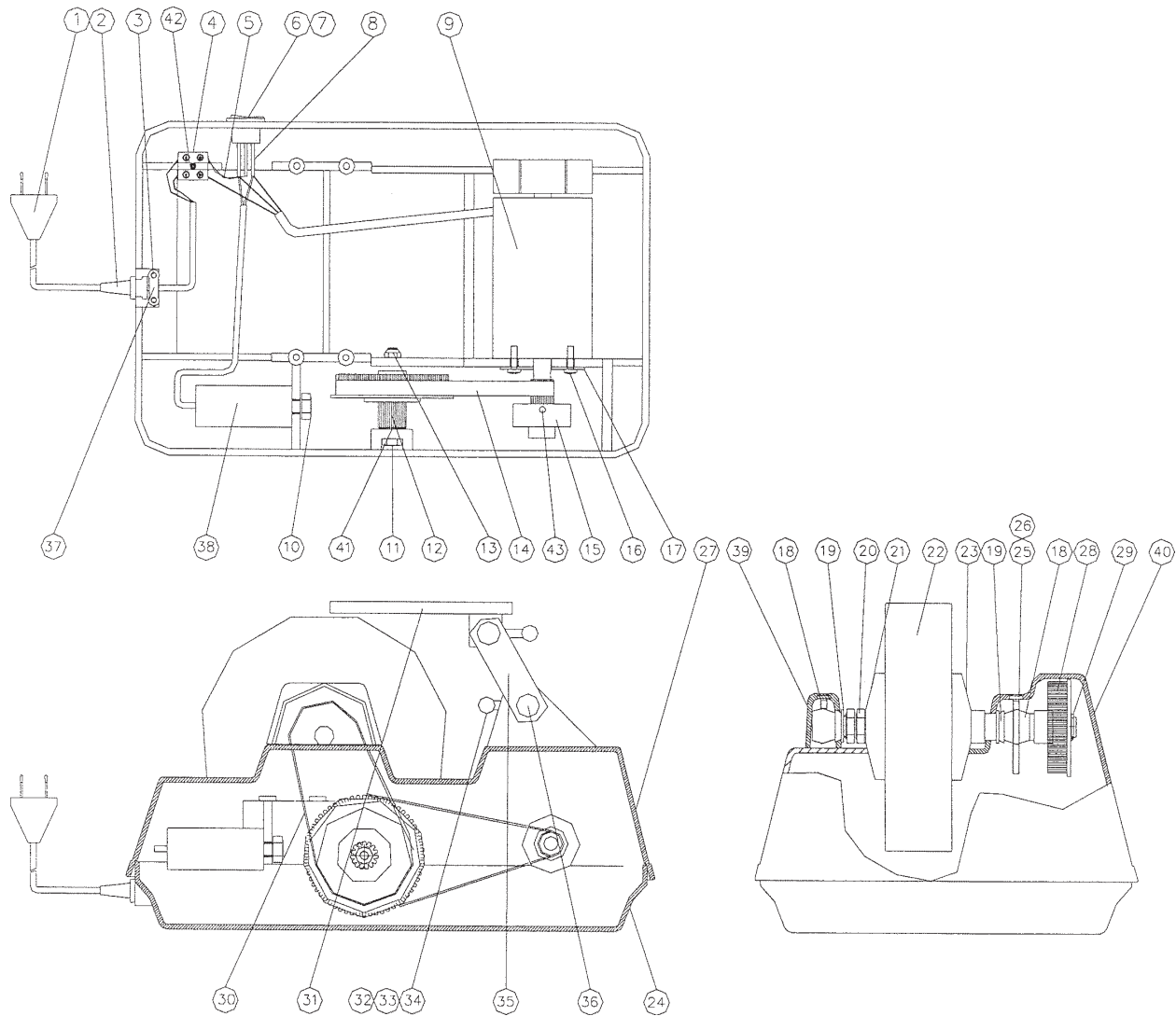

PLEASE READ THE FOLLOWING CAREFULLY

THE MANUFACTURER AND/OR DISTRIBUTOR HAS PROVIDED THE PARTS DIAGRAM IN THIS MANUAL AS A REFERENCE TOOL ONLY. NEITHER THE MANUFACTURER NOR DISTRIBUTOR MAKES ANY REPRESENTATION OR WARRANTY OF ANY KIND TO THE BUYER THAT HE OR SHE IS QUALIFIED TO MAKE ANY REPAIRS TO THE PRODUCT OR THAT HE OR SHE IS QUALIFIED TO REPLACE ANY PARTS OF THE PRODUCT. IN FACT, THE MANUFACTURER AND/OR DISTRIBUTOR EXPRESSLY STATES THAT ALL REPAIRS AND PARTS REPLACEMENTS SHOULD BE UNDERTAKEN BY CERTIFIED AND LICENSED TECHNICIANS AND NOT BY THE BUYER. THE BUYER ASSUMES ALL RISK AND LIABILITY ARISING OUT OF HIS OR HER REPAIRS TO THE ORIGINAL PRODUCT OR REPLACEMENT PARTS THERETO, OR ARISING OUT OF HIS OR HER INSTALLATION OF REPLACEMENT PARTS THERETO.

Free Manuals Download Website

<http://myh66.com>

<http://usermanuals.us>

<http://www.somanuals.com>

<http://www.4manuals.cc>

<http://www.manual-lib.com>

<http://www.404manual.com>

<http://www.luxmanual.com>

<http://aubethermostatmanual.com>

Golf course search by state

<http://golfingnear.com>

Email search by domain

<http://emailbydomain.com>

Auto manuals search

<http://auto.somanuals.com>

TV manuals search

<http://tv.somanuals.com>