

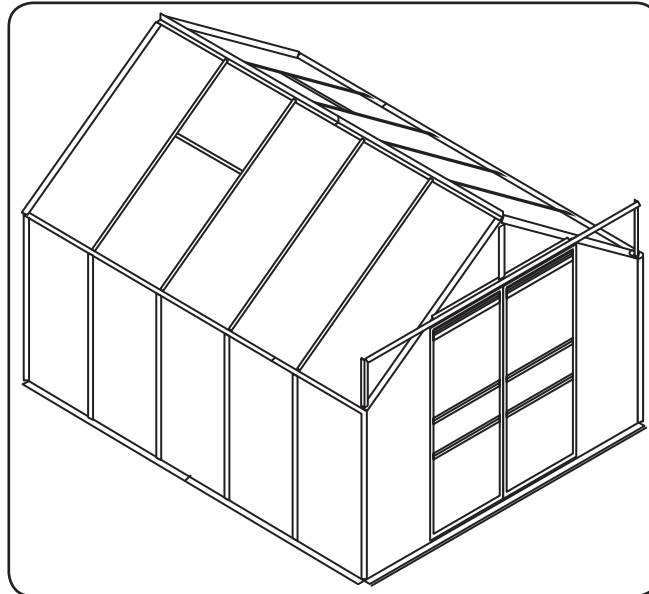

8' x 10' GREENHOUSE WITH TWO VENTS

Model 93920

ASSEMBLY INSTRUCTIONS



Due to continuing improvements, actual product may differ slightly from the product described herein.



3491 Mission Oaks Blvd., Camarillo, CA 93011

Visit our website at: <http://www.harborfreight.com>

**TO PREVENT SERIOUS INJURY, READ AND UNDERSTAND
ALL WARNINGS AND INSTRUCTIONS BEFORE USE.**

Copyright© 2006 by Harbor Freight Tools®. All rights reserved. No portion of this manual or any artwork contained herein may be reproduced in any shape or form without the express written consent of Harbor Freight Tools.

For technical questions or replacement parts, please call 1-800-444-3353.

Contents

UNPACKING	2
SPECIFICATIONS.....	3
Save This Manual	3
GENERAL SAFETY WARNINGS AND PRECAUTIONS	3
BASE ASSEMBLY	5
FRAME ASSEMBLY	6
Assembling the Outer Frame.....	6
Assembling the Roof Frame	8
Assembling the Studs and Braces.....	9
Assembling the Roof Studs and Braces.....	12
Assembling the Window.....	13
Assembling the Doors.....	13
Installing the Transparent Panels	15
Panel Installation Diagram	16
INSPECTION, MAINTENANCE, AND CLEANING.....	17
PARTS LIST	18

UNPACKING

When unpacking, check to make sure all the parts shown on the **Parts Lists at the end of this manual** are included. If any parts are missing or broken, please call Harbor Freight Tools at the number shown on the cover of this manual as soon as possible.

SPECIFICATIONS

Overall Dimensions	120" L x 96 ¹ / ₂ " W x 86 ⁵ / ₈ " H
Window Dimensions	22 ⁷ / ₈ " L x 20" W
Door Dimensions	64" H x 24" W x 1 ¹ / ₄ " Thick
Materials	Aluminum Frame Transparent Polycarbonate Sheets
Aluminum Thickness	0.038"
Polycarbonate Sheet Thickness	0.165"
Weight	154 lb.

Save This Manual

You will need this manual for the safety warnings and precautions, assembly, inspection, maintenance and cleaning procedures, parts list and assembly diagram. Keep your invoice with this manual. Write the invoice number on the inside of the front cover. Keep this manual and invoice in a safe and dry place for future reference.

GENERAL SAFETY WARNINGS AND PRECAUTIONS

1. **KEEP WORK AREA CLEAN AND DRY.** Cluttered, damp, or wet work areas invite injuries.
2. **KEEP CHILDREN AWAY FROM GREENHOUSE.** Do not allow children to play in or climb on this product. Although this greenhouse does include some protective covers, there are still some exposed sharp edges. In addition, protective covers may fall off in time. Children must be supervised if allowed near the greenhouse.
3. **DO NOT ASSEMBLE THIS PRODUCT IF UNDER THE INFLUENCE OF ALCOHOL OR DRUGS.** Read warning labels on prescriptions to determine if your judgement or reflexes are impaired while taking drugs. If there is any doubt, do not attempt to assemble this product.
4. **USE EYE PROTECTION.** Wear ANSI-approved safety impact eye goggles when assembling this product. ANSI-approved safety impact eye goggles are available from Harbor Freight Tools.
5. **DO NOT OVERREACH.** Keep proper footing and balance at all times to prevent tripping, falling, back injury, etcetera.
6. **STAY ALERT.** Watch what you are doing at all times. Use common sense. Do not attempt to assemble this product when you are tired or distracted from the job at hand.

7. **CHECK FOR DAMAGED PARTS.** Before using this product, carefully check that it will operate properly and perform its intended function. Check for damaged parts and any other conditions that may affect the operation of this product. Replace or repair damaged or worn parts immediately.
8. **REPLACEMENT PARTS AND ACCESSORIES:** When servicing, use only identical replacement parts. Only use accessories intended for use with this product. Approved accessories are available from Harbor Freight Tools.
9. **MAINTAIN THIS PRODUCT WITH CARE.** Keep this product clean and dry for better performance.
10. **MAINTENANCE:** For your safety, service and maintenance should be performed regularly by a qualified technician.
11. **USE THE RIGHT PRODUCT FOR THE JOB.** Do not attempt to force a small product to do the work of a larger industrial product. There are certain applications for which this product was designed. It will do the job better and more safely in the manner for which it was intended. Do not modify this product, and do not use this product for a purpose for which it was not intended.
12. **MAINTAIN A SAFE WORKING ENVIRONMENT.** Keep the work area well lit. Make sure there is adequate surrounding workspace. Avoid high traffic areas. Always keep the work area free of obstructions, grease, oil, trash, and other debris.
13. **PROPER GREENHOUSE LOCATION:** Make sure the Greenhouse is located on a flat, level, surface.
14. **WARNING:** This product contains or produces a chemical known to the State of California to cause cancer and birth defects (or other reproductive harm). (California Health & Safety Code § 25249.5, *et seq.*)
15. **THIS UNIT CONTAINS PIECES WITH SHARP EDGES.** The machined edges of the aluminum parts and the ends of the panel clips may be sharp. Handle all parts carefully.
16. **SNOW/DEBRIS ACCUMULATION HAZARD.** The heavy weight of accumulated snow or other debris can cause parts of this greenhouse to buckle suddenly. Do not allow debris to accumulate on top of the greenhouse. If snowfall is expected, place additional supports (not provided) underneath the Crown (15a, 15b). **NEVER enter a greenhouse with accumulated debris on top.**
17. **WARNING:** The warnings, precautions, and instructions discussed in this manual cannot cover all possible conditions and situations that may occur. The operator must understand that common sense and caution are factors, which cannot be built into this product, but must be supplied by the operator.

BASE ASSEMBLY

IMPORTANT—READ THE FOLLOWING CAREFULLY BEFORE PROCEEDING

- The first step in assembly is to assemble a proper base. The greenhouse must be properly supported to help prevent property damage and injury in the event of strong winds or inclement weather. Wind and ground conditions may vary from site to site, and may affect the practicality and effectiveness of anchoring methods substantially.
 - Be certain to check with local authorities to obtain all required building permits and to familiarize yourself with any building codes that may apply.
 - Decide on a location for the greenhouse. The location should be a level, well-lit area that is sheltered from the wind. The door of the greenhouse should not open towards the prevailing wind, if possible.
1. Excavate an area for the base of the greenhouse. The area must be 8' 2" wide by 10' 2" long by 2¹/₂" – 2³/₄" deep. The floor of the hole must be level and square. The diagonal dimensions, from corner to corner, should each be 13'.
 2. Assemble the Base outside the hole as shown below. Note that the angled edges of the Base Plates (40, 41a, 41b) need to face the corners of the base. Use Base Bolts (45), Base Nuts (46), and Connectors (42, 43) to secure the pieces together.

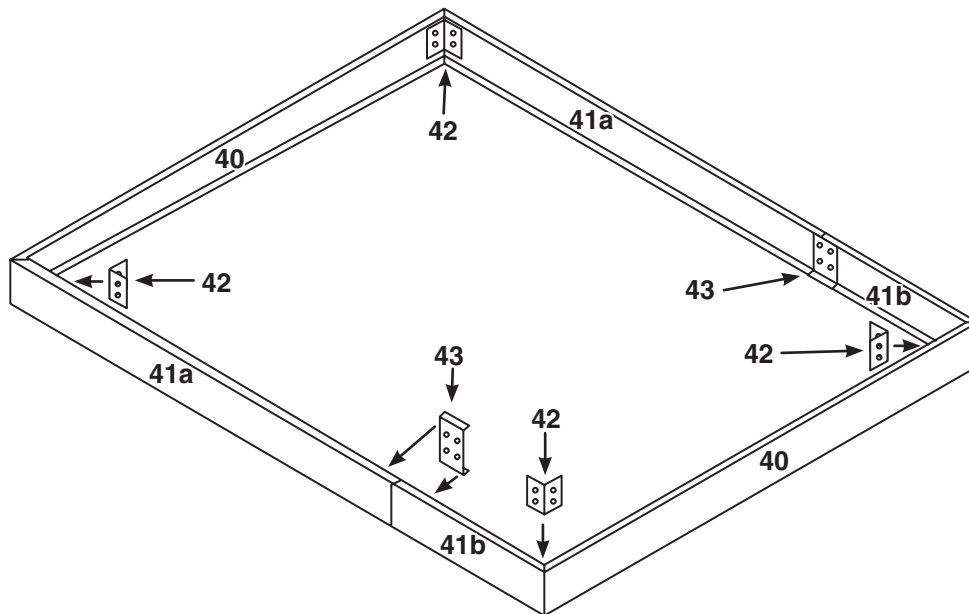

Base Assembly

3. With assistance, lower the Base into the hole. The diagonal dimensions, from outside corner to outside corner, must be equal for the base to be square.
4. Fill the hole around the outside of the base with soil.
5. This base will need to be filled with about 17-18 cubic feet of gravel or another appropriate fill material (not provided). The gravel should reach up to about 1¹/₂" – 3³/₄" below the lip of the base.

FRAME ASSEMBLY

- Unless noted otherwise, all frame parts will be attached using the Short Bolts (59) and Nuts (61) provided. Bolts should all be assembled with their heads facing the outside of the greenhouse. Tighten Nuts only about $\frac{1}{4}$ turn past finger-tight; be careful not to overtighten.
- Lay out all parts by number prior to assembly.
- An assistant or an appropriate support (not included) will be useful to keep the partially assembled parts upright during assembly. Two assistants should be used to assemble the Crown pieces to the rest of the frame.
- Assemble on a clear, calm day. Wind may damage the Greenhouse and will make assembly difficult.

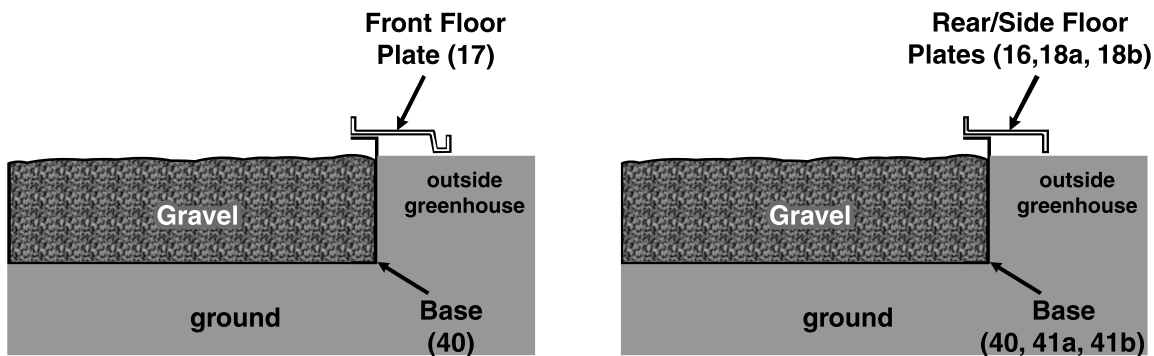

Cross Section

Assembling the Outer Frame

1. Use the bracket built into Side Floor Plate A (18a) to attach Side Floor Plate B (18b). Repeat for the second pair of Side Floor Plates. Lay all Floor Plates (16-18b) out on top of the base with the flanges facing the outside of the greenhouse as shown above. Make sure that the Front Floor Plate (17) is on the side that you want your door to be located.

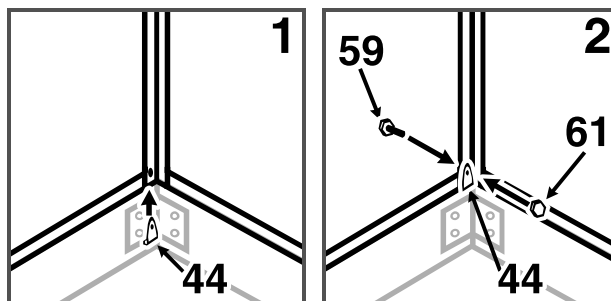

2. There are four Corner Studs (1) to be attached to the Floor Plates (16-18b), the end with two holes should be at the bottom. Attach one Corner Stud (1) on the outside of each corner using two Bolts. As shown above: 1) slide a Hold Down Connector

(44) up under the rail and over the end of the Bolt (59), then **2)** secure it using a Nut (61). Use two Hold Down Connectors for each Corner Stud.

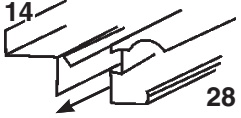
3. Remove the Nuts (61) you used in step 1 to assemble the Side Floor Plates (18a, 18b), install a Hold Down Connector (44) over the end of each Bolt (59), and re-install all Nuts (61).
4. Place three Short Bolts (59) and Nuts (61) into the holes on the Top Doorway Beam (14). Do not tighten them yet. While making sure that the profiles of the parts are oriented as shown to the right, slide the slot on the Door Rail (28) over the heads of the three bolts on the Top Doorway Beam. Center the Door Rail on the Doorway Beam then tighten the Nuts. 
5. Attach a Corner End Cap (68) to the top outer corner of each Corner Stud (1).

The 14 spots requiring a Hold-down Connector (44) are marked with a plus (+).

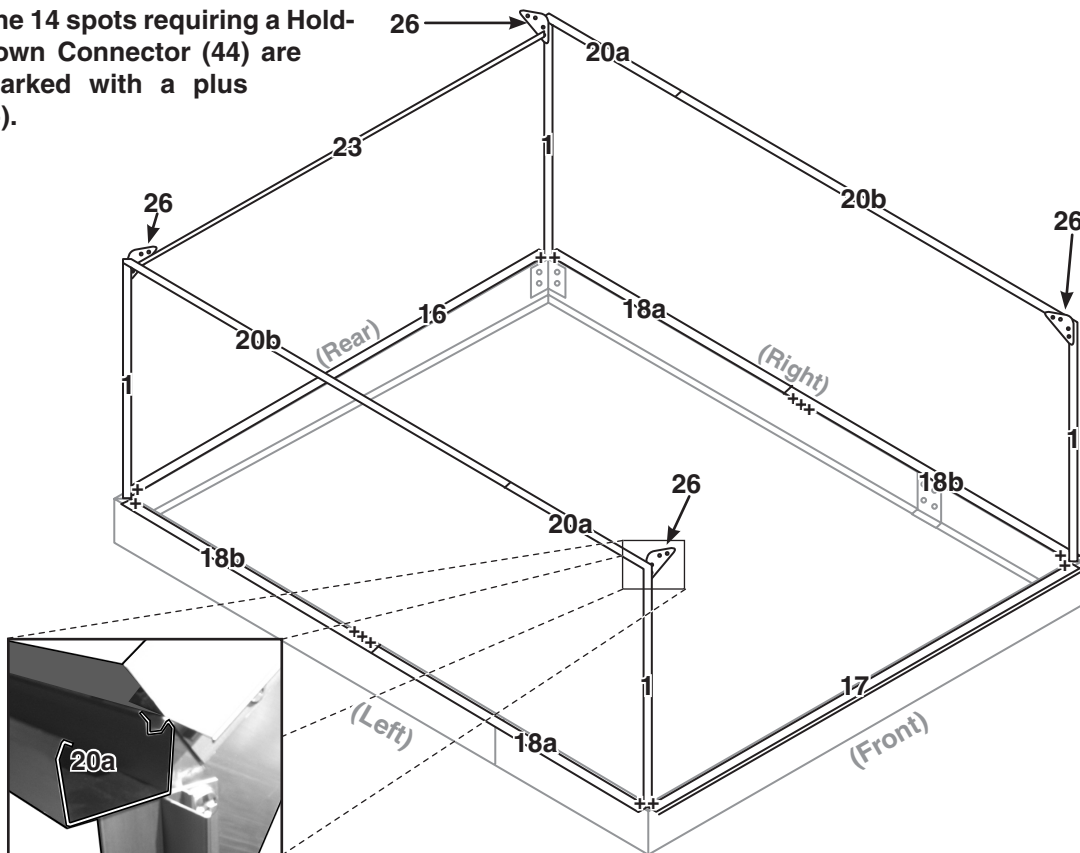
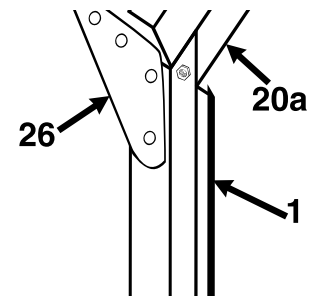

Figure A

6. Assemble both Side Ceiling Plates (20a, 20b) to one another.
7. Attach a Side Ceiling Plate Ass'y (20) flat against the inside of two Corner Studs (1). Make sure that the gutter on the Side Ceiling Plate is oriented correctly, see **Figure A inset**.



At this point, the completed section of the frame will likely need support. Attach the second Ceiling Plate the same way.

8. Attach a Corner Bracket (26) at the top of each Corner Stud (1) so that the bracket faces upwards, see diagram to the right. Leave the bottom holes of the two rear Corner Brackets (26) empty to allow the rear brace to be attached to those holes in the next step.
9. Attach the Rear Brace (23) to the inside of the two Corner Brackets (1) that are over the Rear Floor Plate (16). Attach each end to the lower hole on the Corner Bracket (26) using a Long Bolt (60) and Nut (61). (See Figure A.)

Assembling the Roof Frame

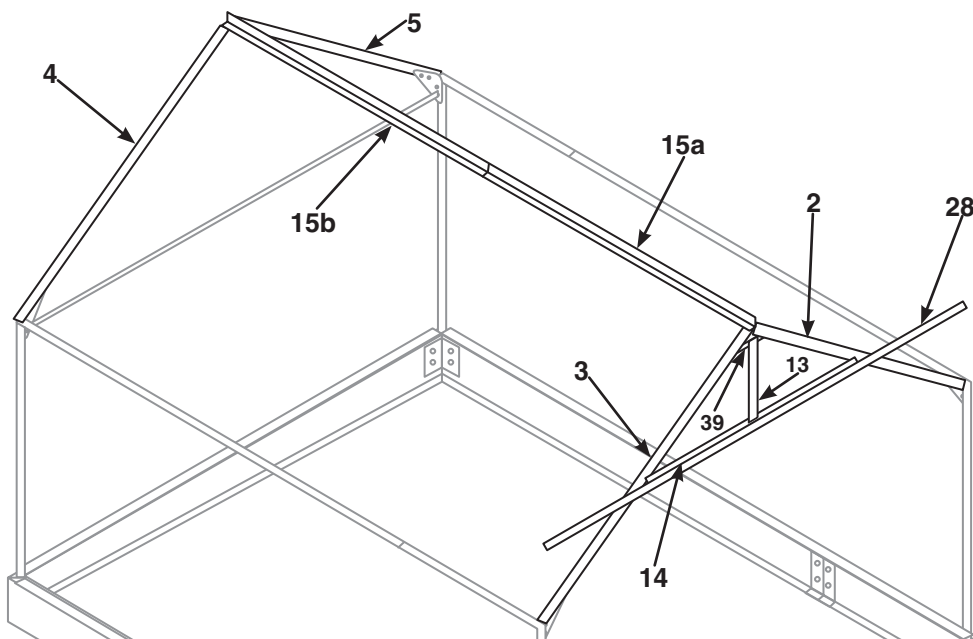
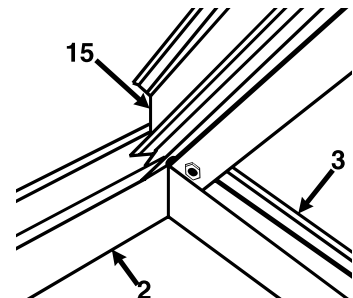
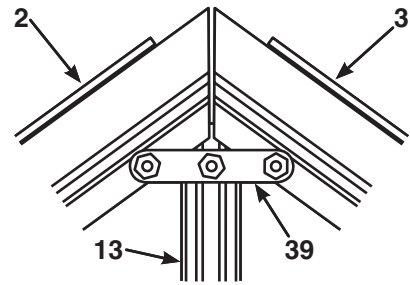

Figure B

1. At the side of the Greenhouse: Assemble the Front Crown (15a) to the Rear Crown (15b) using the attached bracket.
2. Attach the Front-Right and Front-Left Crown Beams (2, 3) to the outside of the Crown Ass'y (15) with the angled edges towards the top. See diagram to the right, viewed from under the Crown, facing forward.
3. Attach the Top Doorway Beam (14) and Door Rail (28) assembly to the outside (opposite the Crown) of the Front-Right and Front-Left Crown Beams (2, 3).
4. Attach the Front-Center Top Stud (13) to the center of the Top Doorway Beam (14).



5. Attach the Front-Center Top Stud (13) to the Front Crown Beams (2,3) using the Top-center Connector (39) as shown below right.
6. Attach the Rear Crown Beams (4,5) to the Crown (15b) in the same fashion as the Front Crown Beams in step 2.
7. Attach a Corner End Cap (68) onto the outer end of each Crown Beam (2-5). Cover the gaps between the Crown Beams (between 2-3 & 4-5) with a Peak Cap (72) in each. You may desire to use some silicone (not included) to secure the Peak Caps (72) in place.
8. With two assistants, lift the Crown Assembly and place the Crown Beams (2-5) on top of the Corner Brackets (26). **(See Figure B.)** Secure each corner in place with the Crown Beams on the outside of the Corner Brackets.



Assembling the Studs and Braces

The 13 spots requiring a Hold-down Connector (44) are marked with a plus (+).

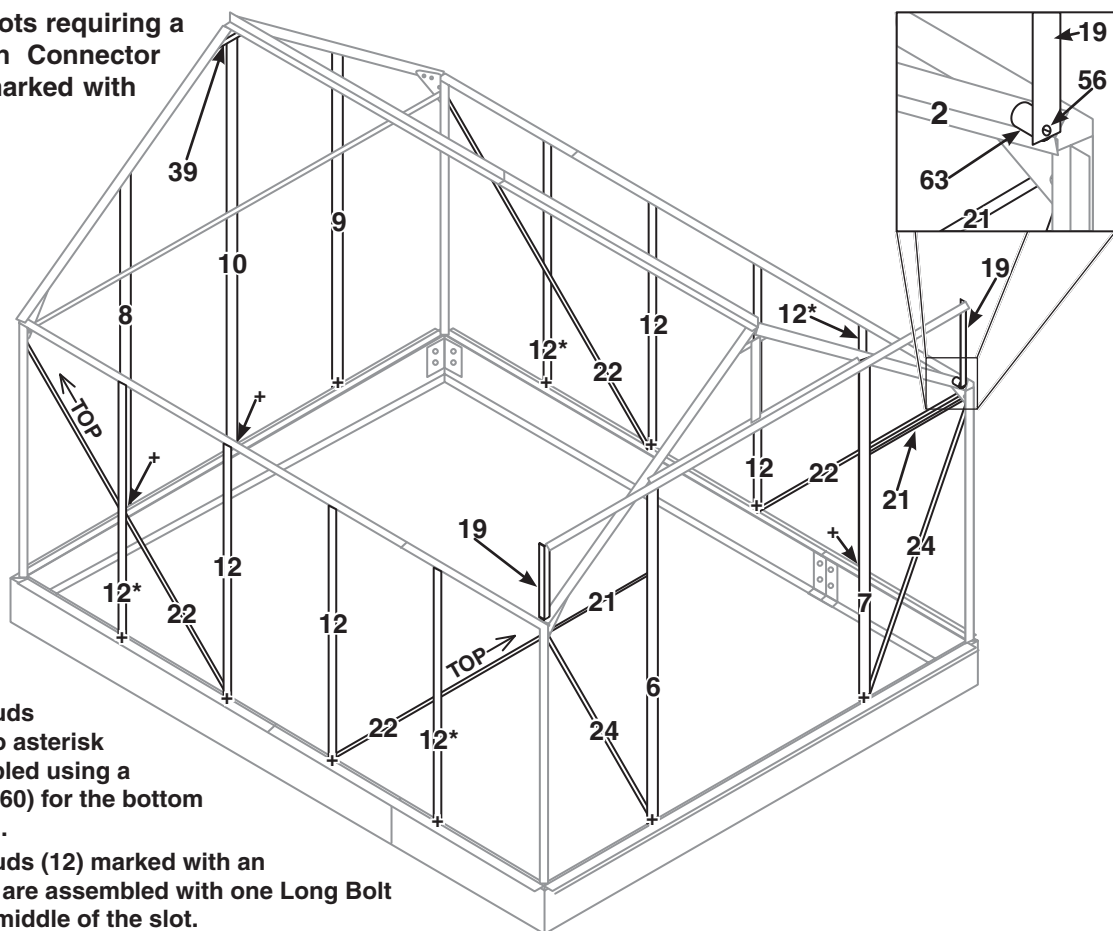

Note:
 All Side Studs (12) with no asterisk are assembled using a Long Bolt (60) for the bottom connection.
 All Side Studs (12) marked with an asterisk (*) are assembled with one Long Bolt (60) in the middle of the slot.

Figure C

1. Attach the Rear-Left, Rear-Right, and Rear-Center Studs (8, 9, & 10) to the outside of the Rear Floor Plate (16) and Rear Brace (23). Slide a Hold-Down Connector

(44) under the base and over the Bolt at each Floor Plate (16) connection. Use Long Bolts (60) for the Rear Brace (23) connections.

- Attach the tops of the Rear Studs (8, 9, & 10) to the Rear-Right and Rear-Left Crown Beams (4, 5). For the Rear-Center Stud (10), use a Top Center Connector (39) to connect to the Crown Beams, as shown to the right.

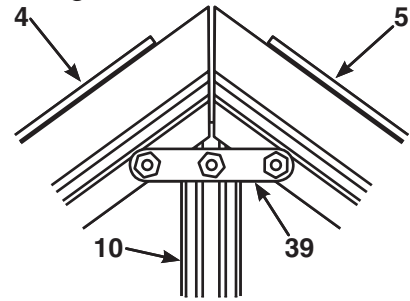

- Refer to the **Note** in **Figure C**. Attach the two Side Studs (12) in the center of each side (without asterisks in **Figure C**) to the outside of the frame. Make the bottom connections using a Long Bolt (60) for later assembly of the Side Diagonal Brace (22). Slide a Hold-Down Connector (44) under the base and over the Long Bolt at each bottom connection, but do not install a Nut (61) over the Long Bolt yet.
- Refer to the **Note** in **Figure C**. Attach the two Side Studs (12) near the corner of each side (with asterisks (*) in **Figure C**) to the outside of the frame. Slide a Long Bolt (60) into each slot for later Side Diagonal Brace (22) assembly. Slide a Hold-Down Connector (44) under the base and over the Bolt before installing the Nut (61) at each bottom connection.
- Attach a Side Diagonal Brace (22) to the lower hole of a Corner Stud (1) on the inside with the TOP arrow pointing towards the Corner Stud as shown in **Figure C**. Use a Long Bolt (60) to attach the Brace. Attach the other three Side Diagonal Braces (22) to the other Corner Studs (1) in the same manner.
- Attach the center hole of each Brace to the Long Bolt (60) in the center of the Side Studs (12) designated with an asterisk (*) in **Figure C**. This Bolt (60) was included in step 4, above.
- Attach the bottoms of all four Side Diagonal Braces (22) to the Long Bolts (60) installed at the bottoms of the remaining Side Studs.

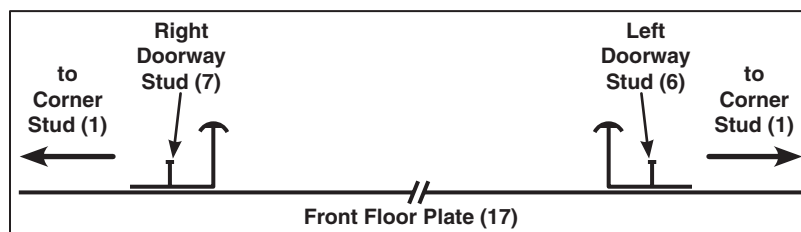

View from above

- Install the Left and Right Doorway Studs (6 & 7) to the outside of the frame so that they rest flat against the frame. Their orientation should be the same as shown above. Slide a Long Bolt (60) into each slot for later Front Brace (21) assembly. Make the bottom connections using a Long Bolt (60) for later assembly of the Front Diagonal Braces (24). Slide a Hold-Down Connector (44) under the base and over

the Long Bolt at each bottom connection, but do not install a Nut (61) over the Long Bolt yet.

9. Remove the bottom Bolt from the Corner Brackets (26) at the front of the greenhouse. Install the Front Diagonal Braces (24) to the bottom hole of the Brackets on the inside using Long Bolts (60). Attach the bottom of the Front Diagonal Braces (24) to the Long Bolt left exposed on the Floor Plate (17) from the last step. **(See Figure C.)**
10. Remove the second Bolt from the bottom of the front Corner Brackets (26). Connect the Front Braces (21) to the exposed hole using Long Bolts (60). Connect the loose ends of the Front Braces (21) to the Doorway Studs (6, 7) using Long Bolts (60). **(See Figure C.)**
11. Attach the Door Slide Support (19) to the Front-Right Crown Beam (2) using the Long Door Support Bolt (56) and Nut (61), with the Door Support Spacer (63) between the Support and the Stud. **(See Figure C, inset, and diagram to the right.)** Repeat for the other Door Slide Support (19) on the opposite side.
12. The frame should now rest square. Measure diagonally from corner to corner at the top. If the measurements are not equal, adjust the frame as needed until square. Some Nuts (61) may need to be temporarily loosened to adjust the frame properly.
13. Place the Gutter End Caps (69) onto the ends of the Side Ceiling Plates (20a, 20b) oriented with a gap in the bottom to allow water to drain out of the gutters.

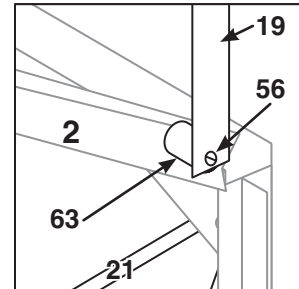

Assembling the Roof Studs and Braces

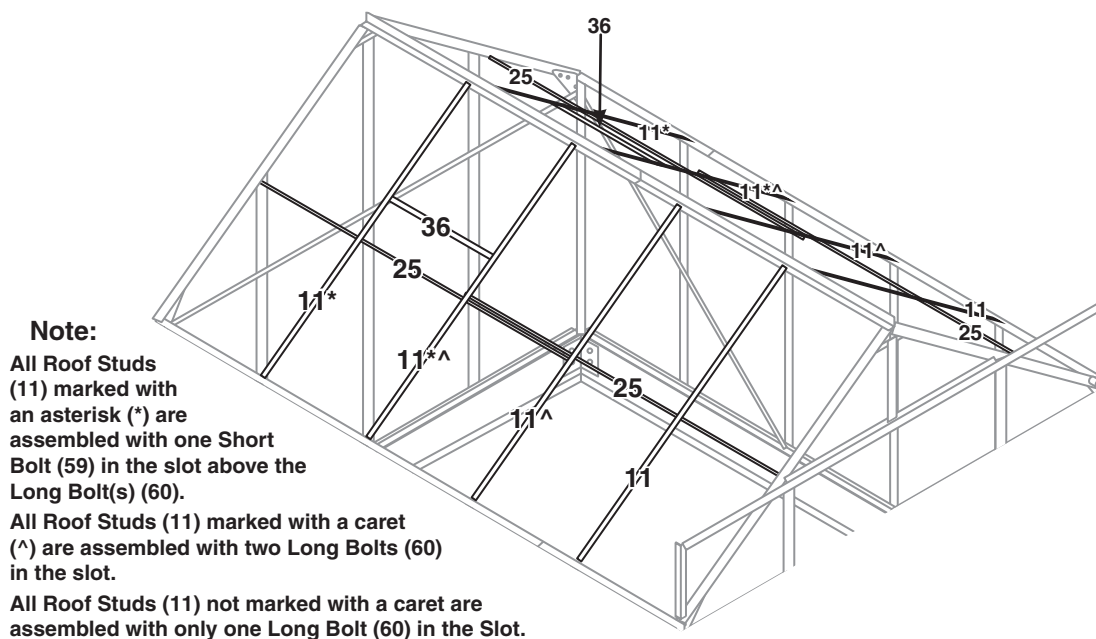
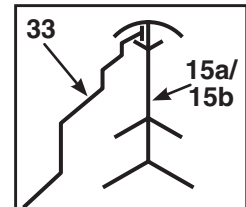
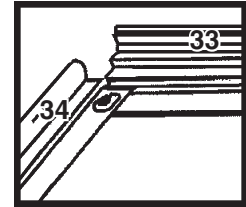

Figure D

1. Attach all Roof Studs (11) to the outside of the Front/Rear Crown (15a, 15b). Leave the bottom ends of the Roof Studs unattached for now.
2. Slide one Short Bolt (59) into all the Roof Studs (11) marked with an asterisk (*) above. Slide two Long Bolts (60) into the Roof Studs indicated with a caret (^) above. Slide one Long Bolt (60) into all the Roof Studs not marked with a caret above. Secure the ends of all Roof Studs (11) to the outer top edge of the Side Ceiling Plates (20a, 20b) using Short Bolts (59).
3. Attach Roof Braces (25) to the underside of the Roof Studs (11) side-by-side, using the Long Bolts (60) included in the last step. Secure the ends of the Braces first, then secure the centers.
4. Slide a Window Support Beam (36) onto two Roof Studs (11) marked with an asterisk (*), with the predrilled holes on the underside and the flat side facing the Crown (15a, 15b). Use the extra Bolts (59) to secure the Beam loosely in place. Repeat for the other Window Support Beam (36).
5. At this time, verify that the Door Rail (28) is oriented correctly, with the rounded edge facing up – see number 4 on page 7.

Assembling the Window

1. Attach the Side Window Frames (34) to the Top Window Frame (33), as shown below to the right.
2. Insert Short Bolts (59) into the holes at the bottom of the Side Window Frames (34), so that the threads stick out the bottom of the window.
3. Remove the protective film from both sides of the Window Pane (51). Slide the Window Pane (51) into the three-sided frame.
4. Slide the Bottom Window Frame (35) onto the two Short Bolts (59) and the Window Pane (51). Secure it in place with Nuts (61). You may need to apply some pressure to the heads of the Bolts through the Window Pane to allow the Nuts to thread on properly.
5. Attach the Window Brace (38) to the Bottom Window Frame (35) using two Window Screws (58). The holes on the Window Brace (38) should face away from the window.
6. Slide the top edge of the Top Window Frame (33) into the slot at the top of the Crown (15b), see illustration to the right. The window should be aligned with the Window Brace (38) underneath it. Slide the window into place over the Window Support Beam (36). Gradually lower it into place.
7. Using two Window Screws (58), attach the Window Stop (37) to the Window Support Beam (36) with its tab pointing towards the Crown (*10, 11). It should be on the underside of the Window Support Beam, inside the greenhouse.
8. Loosen the Nuts (61) holding the Window Support Beam (36) in place and slide the Window Support Beam (36) up to touch the window. Secure it in place.
9. Repeat steps 1-8 for the other window.



Assembling the Doors

The doors are assembled using the Door Screws (57). The Screws thread directly into the rounded portions of the parts in the center of the doors.

1. Place an Outer Door Frame (27a) with the slotted side down. Attach two Center Door Frames (31) to the Outer Door Frame (27a). Assemble them with the rounded portion facing the front, as shown to the right.
2. Attach an Inner Door Frame (27b) to the other side of the Center Door Frames (31) in the same way.

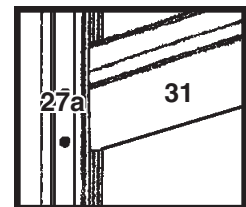

Front view

3. Orient the assembled door frames for so that the Outer Door Frame (27a) is on the left, and the Inner Door Frame (27b) is on the right. This is the assembly used for the left door, the right door will be assembled later with the Outer and Inner Door Frames on the opposite sides (outer on right, inner on left). All illustrations show the left door assembly.

4. Attach the Top Door Frame (30) to the top of the Outer/Inner Door Frames (27a, 27b). Make sure that the rounded portion faces the front and that the flange where the pane will sit faces down towards the center of the door, see the diagram to the right.

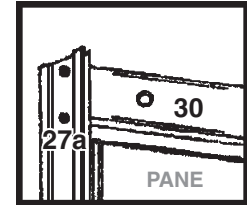

Front view

5. Using two Short Bolts (59) and two Nuts (61), attach the Door Slider (29) to the Top Door Frame (30) with the rollers on the top of the door.

6. Insert a Door Bottom Slider (64) into each end of the Bottom Door Frame (32). Make sure that the Sliders are assembled the correct way, with the gap facing the back of the door – see diagram to the right. Attach the Bottom Door Frame (32) to the Outer/Inner Door Frames (27a, 27b) using two Screws (57) on each side – the one on the top into the Bottom Door Frame (32) and the bottom one into the Door Bottom Slider (64).

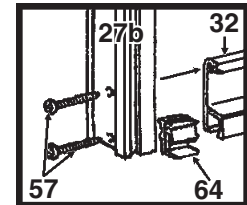

View from behind

7. Raise the assembled Door up and insert the first roller of its Door Slider (29) onto the Door Rail (28). Carefully align the first Bottom Door Slider (64) over the edge of the Front Floor Plate (17) – see illustration to the right. Carefully slide the door over and align the other top Roller and bottom Slider as you did the first ones.

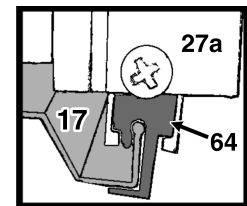

Side view

8. Assemble and install the right door by following the preceding steps, except place the Outer and Inner Door Frames (27a, 27b) on the opposite sides as explained in step 3.

9. Once both doors are installed, install a Short Bolt (59) and Nut (61) into the hole on the ends the Door Rail (28) to prevent the doors from sliding off the rails. Attach the Right and Left Rail End Caps (70,71) onto the ends of the Door Rails.

Installing the Transparent Panels

1. Panel Clips (67) are used to secure the Transparent Panels in place on the Greenhouse.
2. Remove the protective film from both sides of all panels.

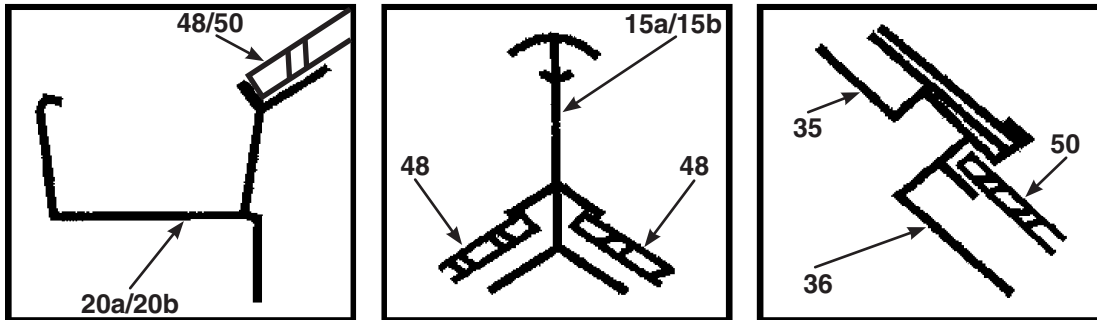

3. The Roof Panels (48) and the Roof Window Panel (50) will need to be placed as shown in the illustrations above. The top edges of these panels need to be placed up under the edge of the Crown (15a, 15b) or the Window Support Beam (36).
4. One at a time, place each Transparent Panel (47 – 49, 51 – 55) in its proper location on the Ceiling and Frame of the Greenhouse. Then, secure the Transparent Panel in place, using the quantity and location of Panel Clips (67) as shown in the Panel Installation Diagram, next page. Also, refer to the panel clip installation instructions in the following step.

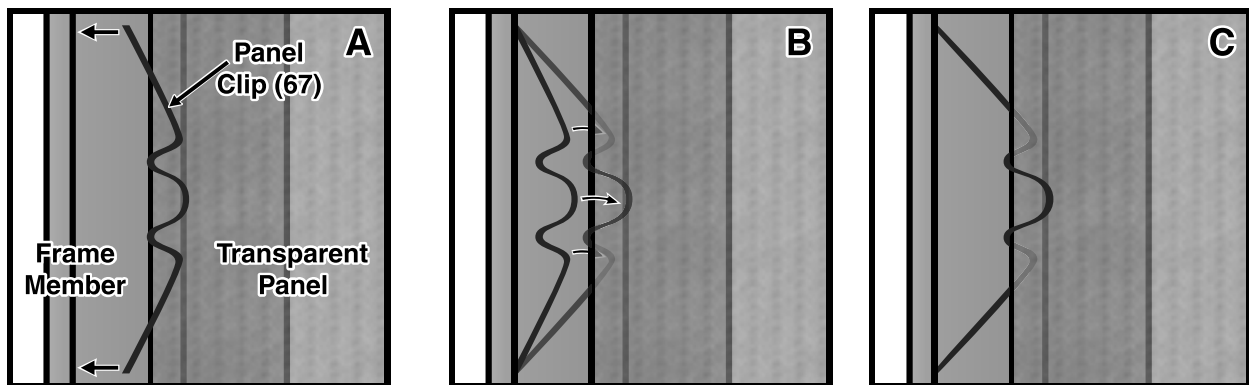

5. **Be careful, Panel Clip (67) ends may be sharp and may spring back!**
To attach Panel Clips:
 - a. Place the two loose ends of the Clip into the groove in the frame.
 - b. Swing the center portion of the Clip up against the panel.
 - c. Two edges of the Clip swing under the edge of the panel and the center edge holds the panel in place.

Panel Installation Diagram

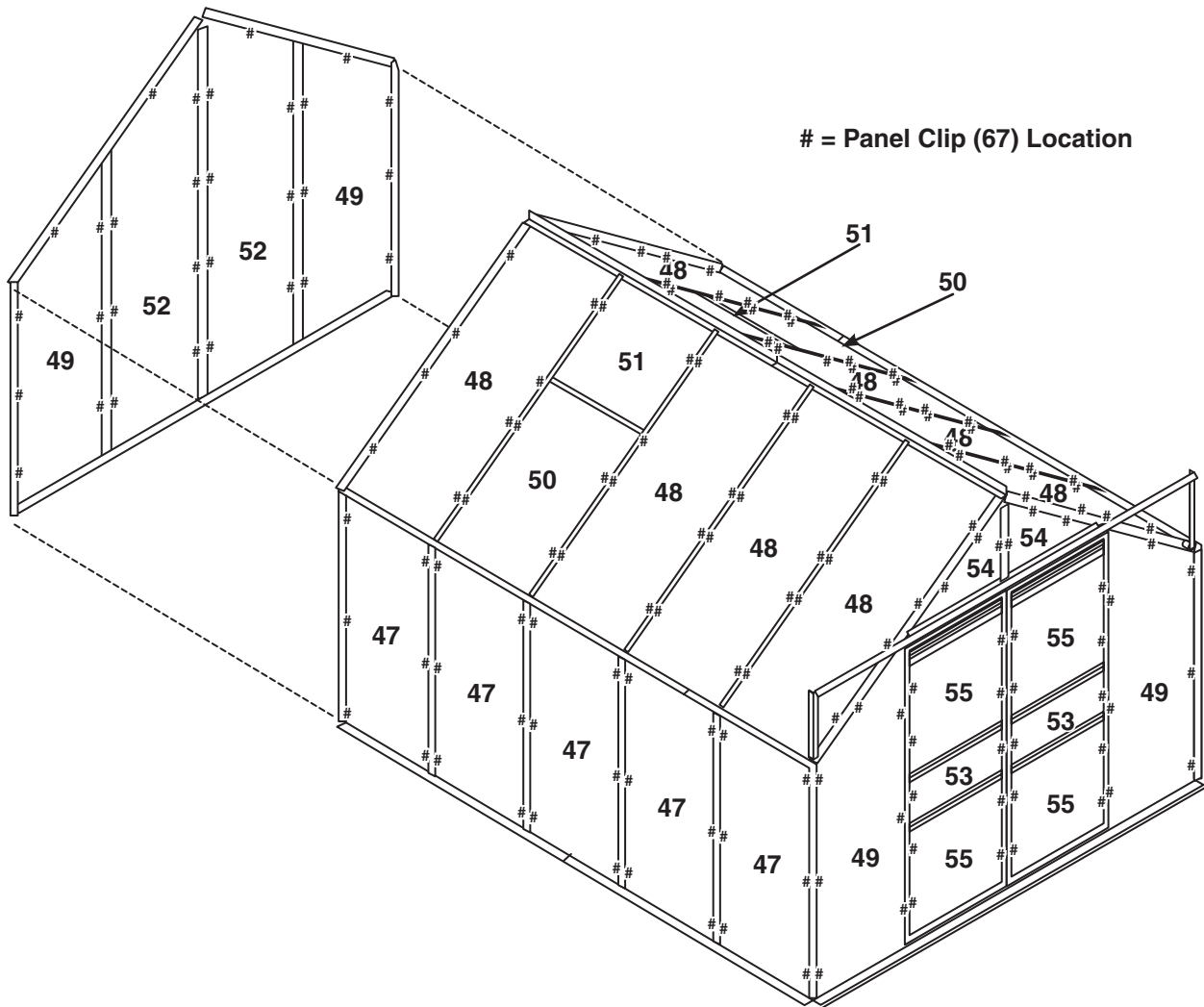

INSPECTION, MAINTENANCE, AND CLEANING

1. **BEFORE EACH USE**, inspect the general condition of the Greenhouse. Check for loose screws, misalignment or binding of moving parts, cracked or broken parts, and any other condition that may affect the safe operation of the Greenhouse. If a problem occurs with the Greenhouse, have it corrected before further use.
Do not use damaged equipment.
2. **TO CLEAN**: Wipe with a damp cloth, using a mild detergent.
Do not use cleaners that are combustible, corrosive, or not compatible with aluminum.
3. **WHEN STORING**: Keep the Greenhouse in a box and in a clean, dry location.

PLEASE READ THE FOLLOWING CAREFULLY

THE MANUFACTURER AND/OR DISTRIBUTOR HAS PROVIDED THE PARTS DIAGRAM IN THIS MANUAL AS A REFERENCE TOOL ONLY. NEITHER THE MANUFACTURER NOR DISTRIBUTOR MAKES ANY REPRESENTATION OR WARRANTY OF ANY KIND TO THE BUYER THAT HE OR SHE IS QUALIFIED TO MAKE ANY REPAIRS TO THE PRODUCT OR THAT HE OR SHE IS QUALIFIED TO REPLACE ANY PARTS OF THE PRODUCT. IN FACT, THE MANUFACTURER AND/OR DISTRIBUTOR EXPRESSLY STATES THAT ALL REPAIRS AND PARTS REPLACEMENTS SHOULD BE UNDERTAKEN BY CERTIFIED AND LICENSED TECHNICIANS AND NOT BY THE BUYER. THE BUYER ASSUMES ALL RISK AND LIABILITY ARISING OUT OF HIS OR HER REPAIRS TO THE ORIGINAL PRODUCT OR REPLACEMENT PARTS THERETO, OR ARISING OUT OF HIS OR HER INSTALLATION OF REPLACEMENT PARTS THERETO.

































PARTS LIST

Lengths given are approximate and rounded to the nearest inch.

PART	DESCRIPTION			Q'TY	PART	DESCRIPTION			Q'TY
1	Corner Stud	4'		4	20a	Side Ceiling Plate A	2' 10"		2
2	Front-Right Crown Beam	4' 9"		1	20b	Side Ceiling Plate B	7' 1"		2
3	Front-Left Crown Beam	4' 9"		1	21	Front Brace	1' 11"		2
4	Rear-Right Crown Beam	4' 9"		1	22	Side Diagonal Brace	5' 7"		4
5	Rear-Left Crown Beam	4' 9"		1	23	Rear Brace	7' 9"		1
6	Left Doorway Stud	5' 3"		1	24	Front Diagonal Brace	4' 3"		2
7	Right Doorway Stud	5' 3"		1	25	Roof Brace	5' 10"		4
8	Rear-Left Stud	5' 4"		1	26	Corner Bracket			4
9	Rear-Right Stud	5' 4"		1	27a	Outer Door Frame	5' 2"		2
10	Rear-Center Stud	6' 8"		1	27b	Inner Door Frame	5' 2"		2
11	Roof Stud	4' 8"		8	28	Door Rail	7' 8"		1
12	Side Stud	4'		8	29	Door Slider	2'		2
13	Front-Center Top Stud	1' 4"		1	30	Top Door Frame	2'		2
14	Top Doorway Beam	3' 11"		1	31	Center Door Frame	2'		4
15a	Front Crown	5' 2"		1	32	Bottom Door Frame	2'		2
15b	Rear Crown	4' 10"		1	33	Top Window Frame	1' 11"		2
16	Rear Floor Plate	7' 9"		1	34	Side Window Frame	1' 9"		4
17	Front Floor Plate	7' 9"		1	35	Bottom Window Frame	1' 11"		2
18a	Side Floor Plate A	4' 10"		2	36	Window Support Beam	2'		2
18b	Side Floor Plate B	5' 2"		2	37	Window Stop			2
19	Door Slide Support	1' 2"		2	38	Window Brace			2

PARTS LIST (continued)

Part lengths are approximate and rounded to the nearest inch.

PART	DESCRIPTION		Q'TY	PART	DESCRIPTION		Q'TY		
39	Top Center Connector		2	55	Door Top/Bottom Panel	2' x 1' 11"	4		
40	Front/Rear Base Plate	8'		2	56	Long Door Support Bolt	M6 x 33 mm		2
41a	Side Base Plate A	8'		2	57	Door Screw	ST4.3 x 19 mm		32
41b	Side Base Plate B	2'		2	58	Window Screw	ST4 x 7.5 mm		8
42	Base Plate Corner Connector		4	59	Short Bolt	M6 x 10 mm		122	
43	Base Plate Side Connector		2	60	Long Bolt	M6 x 18 mm		40	
44	Hold-down Connector		25	61	Nut	M6		184	
45	Base Bolt	1/4" x 10mm		24	63	Door Support Spacer		2	
46	Base Nut	1/4"		24	64	Door Bottom Slider		4	
47	Wall Panel	1' 11" x 4'		10	65	Spanner Wrench		2	
48	Roof Panel	1' 11" x 4' 9"		8	66	Hex Wrench		1	
49	Front/Rear Side Panel	1' 11" x 5' 4"		4	67	Panel Clip		206	
50	Roof Window Panel	1' 11" x 3'		2	68	Corner End Cap		8	
51	Window Pane	1' 11" x 1' 9"		2	69	Gutter End Cap		4	
52	Rear Center Panel	1' 11" x 6' 8"		2	70	Right Rail End Cap		1	
53	Door Center Panel	2' x 9"		2	71	Left Rail End Cap		1	
54	Front Top Panel	1' 11" x 1' 4"		2	72	Peak Cap		2	

Note: Some parts are listed and shown for illustration purposes only and are not available individually as replacement parts.

Free Manuals Download Website

<http://myh66.com>

<http://usermanuals.us>

<http://www.somanuals.com>

<http://www.4manuals.cc>

<http://www.manual-lib.com>

<http://www.404manual.com>

<http://www.luxmanual.com>

<http://aubethermostatmanual.com>

Golf course search by state

<http://golfingnear.com>

Email search by domain

<http://emailbydomain.com>

Auto manuals search

<http://auto.somanuals.com>

TV manuals search

<http://tv.somanuals.com>