

CENTRAL PNEUMATIC®

# 1/2" REVERSIBLE AIR DRILL

**Model 98896**

## SET UP AND OPERATING INSTRUCTIONS



Distributed exclusively by Harbor Freight Tools®.

3491 Mission Oaks Blvd., Camarillo, CA 93011

Visit our website at: <http://www.harborfreight.com>



**Read this material before using this product.  
Failure to do so can result in serious injury.  
SAVE THIS MANUAL.**

Copyright© 2008 by Harbor Freight Tools®. All rights reserved. No portion of this manual or any artwork contained herein may be reproduced in any shape or form without the express written consent of Harbor Freight Tools. Diagrams within this manual may not be drawn proportionally. Due to continuing improvements, actual product may differ slightly from the product described herein. Tools required for assembly and service may not be included.

**For technical questions or replacement parts, please call 1-800-444-3353.**

<b>CONTENTS</b>		<b>TROUBLESHOOTING..... 13</b>	
<b>SAFETY ALERT SYMBOL AND SIGNAL WORDS .....</b>	<b>3</b>	<b>PARTS LIST .....</b>	<b>14</b>
<b>IMPORTANT SAFETY INSTRUCTIONS .....</b>	<b>3</b>	<b>ASSEMBLY DIAGRAM.....</b>	<b>15</b>
<b>GENERAL.....</b>	<b>3</b>	<b>LIMITED 1 YEAR WARRANTY ...</b>	<b>16</b>
<b>WORK AREA.....</b>	<b>3</b>		
<b>PERSONAL SAFETY .....</b>	<b>4</b>		
<b>TOOL USE AND CARE .....</b>	<b>4</b>		
<b>SERVICE .....</b>	<b>5</b>		
<b>AIR SOURCE.....</b>	<b>5</b>		
<b>SYMBOLS AND SPECIFIC SAFETY INSTRUCTIONS .....</b>	<b>6</b>		
<b>SYMBOL DEFINITIONS.....</b>	<b>6</b>		
<b>SPECIFIC SAFETY INSTRUCTIONS</b>	<b>6</b>		
<b>VIBRATION PRECAUTIONS .....</b>	<b>7</b>		
<b>FUNCTIONAL DESCRIPTION.....</b>	<b>8</b>		
<b>SPECIFICATIONS .....</b>	<b>8</b>		
<b>COMPONENTS AND CONTROLS ....</b>	<b>8</b>		
<b>INITIAL TOOL SET UP/ ASSEMBLY.....</b>	<b>8</b>		
<b>UNPACKING.....</b>	<b>8</b>		
<b>AIR SUPPLY.....</b>	<b>8</b>		
<b>OPERATING INSTRUCTIONS ....</b>	<b>10</b>		
<b>TOOL SET UP .....</b>	<b>10</b>		
<b>WORK PIECE AND WORK AREA SET UP .....</b>	<b>11</b>		
<b>GENERAL OPERATING INSTRUCTIONS .....</b>	<b>11</b>		
<b>USER-MAINTENANCE INSTRUCTIONS .....</b>	<b>12</b>		
<b>CLEANING, MAINTENANCE, AND LUBRICATION .....</b>	<b>12</b>		

---

## SAVE THIS MANUAL

---

Keep this manual for the safety warnings and precautions, assembly, operating, inspection, maintenance and cleaning procedures. Write the product's serial number in the back of the manual near the assembly diagram (or month and year of purchase if product has no number). Keep this manual and the receipt in a safe and dry place for future reference.

---

### Safety Alert Symbol and Signal Words

---

In this manual, on the labeling, and all other information provided with this product:



This is the safety alert symbol. It is used to alert you to potential personal injury hazards. Obey all safety messages that follow this symbol to avoid possible injury or death.

### **DANGER**

**DANGER** indicates a hazardous

situation which, if not avoided, will result in death or serious injury.

### **WARNING**

**WARNING** indicates a

hazardous situation which, if not avoided, could result in death or serious injury.

### **CAUTION**

**CAUTION**, used with the safety

alert symbol, indicates a hazardous situation which, if not avoided, could result in minor or moderate injury.

### **NOTICE**

**NOTICE** is used to address practices not related to personal injury.

### **CAUTION**

**CAUTION**, without the safety alert symbol, is used to address practices not related to personal injury.

---

## IMPORTANT SAFETY INSTRUCTIONS

---

### INSTRUCTIONS PERTAINING TO A RISK OF FIRE, ELECTRIC SHOCK, OR INJURY TO PERSONS

---

**WARNING** – When using tools, basic precautions should always be followed, including the following:

#### General

- a. To reduce the risks of electric shock, fire, and injury to persons, read all the instructions before using the tool.

#### Work area



- a. Keep the work area clean and well lighted. Cluttered benches and dark areas increase the risks of electric shock, fire, and injury to persons.
- b. Do not operate the tool in explosive atmospheres, such as in the presence of flammable liquids, gases, or dust. The tool is able to create sparks resulting in the ignition of the dust or fumes.
- c. *Keep bystanders, children, and visitors away while operating the*

**tool.** Distractions are able to result in the loss of control of the tool.

### Personal safety

- a. **Stay alert. Watch what you are doing and use common sense when operating the tool. Do not use the tool while tired or under the influence of drugs, alcohol, or medication.** A moment of inattention while operating the tool increases the risk of injury to persons.
- b. **Dress properly. Do not wear loose clothing or jewelry. Contain long hair. Keep hair, clothing, and gloves away from moving parts.** Loose clothes, jewelry, or long hair increases the risk of injury to persons as a result of being caught in moving parts.
- c. **Avoid unintentional starting. Be sure the switch is off before connecting to the air supply.** Do not carry the tool with your finger on the switch or connect the tool to the air supply with the switch on.
- d. **Remove adjusting keys and wrenches before turning the tool on.** A wrench or a key that is left attached to a rotating part of the tool increases the risk of personal injury.
- e. **Do not overreach. Keep proper footing and balance at all times.** Proper footing and balance enables better control of the tool in unexpected situations.
- f.  **Use safety equipment.** A dust mask, non-skid safety shoes and a hard hat must be used for the applicable

conditions. Wear heavy-duty work gloves during use.

- g.  **Always wear eye protection.** Wear ANSI-approved safety goggles.
- h.  **Always wear hearing protection when using the tool.** Prolonged exposure to high intensity noise is able to cause hearing loss.
- i. **Risk of Electric Shock. This tool is not provided with an insulated gripping surface.** Contact with a "live" wire will also make exposed metal parts of the tool "live" and shock the operator.
- j. **Avoid body contact with grounded surfaces such as pipes, radiators, ranges and refrigerators.** There is an increased risk of electric shock if your body is grounded.
- k. **Explore the workpiece to avoid contact with hidden wiring.** Thoroughly investigate the workpiece for possible hidden wiring before performing work. Contact with live wiring will shock the operator.

### Tool use and care

- a. **Use clamps or another practical way to secure and support the workpiece to a stable platform.** Holding the work by hand or against the body is unstable and is able to lead to loss of control.
- b. **Do not force the tool.** Use the correct tool for the application. The correct tool will do the job better and safer at the rate for which the tool is designed.

- c. **Do not use the tool if the switch does not turn the tool on or off.** Any tool that cannot be controlled with the switch is dangerous and must be repaired.
- d. **Disconnect the tool from the air source before making any adjustments, changing accessories, or storing the tool.** Such preventive safety measures reduce the risk of starting the tool unintentionally. Turn off and detach the air supply, safely discharge any residual air pressure, and release the throttle and/or turn the switch to its off position before leaving the work area.
- e. **Store the tool when it is idle out of reach of children and other untrained persons.** A tool is dangerous in the hands of untrained users.
- f. **Maintain the tool with care.** Keep a cutting tool sharp and clean. A properly maintained tool, with sharp cutting edges reduces the risk of binding and is easier to control.
- g. **Check for misalignment or binding of moving parts, breakage of parts, and any other condition that affects the tool's operation.** If damaged, have the tool serviced before using. Many accidents are caused by poorly maintained tools. There is a risk of bursting if the tool is damaged.
- h. **Use only accessories that are identified by the manufacturer for the specific tool model.** Use of an accessory not intended for use with the specific tool model, increases the risk of injury to persons.

### Service

- a. ***Tool service must be performed only by qualified repair personnel.***
- b. **When servicing a tool, use only identical replacement parts. Use only authorized parts.**
- c. **Use only the lubricants supplied with the tool or specified by the manufacturer.**

### Air source





- a.  **Never connect to an air source that is capable of exceeding 90 psi.** Over pressurizing the tool may cause bursting, abnormal operation, breakage of the tool or serious injury to persons. Use only clean, dry, regulated compressed air at the rated pressure or within the rated pressure range as marked on the tool. Always verify prior to using the tool that the air source has been adjusted to the rated air pressure or within the rated air-pressure range.
- b. ***Never use oxygen, carbon dioxide, combustible gases or any bottled gas as an air source for the tool.*** Such gases are capable of explosion and serious injury to persons.



**SAVE THESE INSTRUCTIONS.**

# SYMBOLS AND SPECIFIC SAFETY INSTRUCTIONS

## Symbol Definitions

Symbol	Property or statement
<b>n<sub>o</sub></b>	No-load speed
<b>.../min</b>	Revolutions or reciprocation per minute
<b>PSI</b>	Pounds per square inch of pressure
<b>ft-lb</b>	Foot-pounds of torque
<b>BPM</b>	Blows per minute
<b>CFM</b>	Cubic Feet per Minute flow
<b>SCFM</b>	Cubic Feet per Minute flow at standard conditions
<b>NPT</b>	National pipe thread, tapered
<b>NPS</b>	National pipe thread, straight
	WARNING marking concerning Risk of Eye Injury. Wear ANSI-approved eye protection.
	WARNING marking concerning Risk of Hearing Loss. Wear hearing protection.
	WARNING marking concerning Risk of Respiratory Injury. Wear NIOSH-approved dust mask/respirator.
	WARNING marking concerning Risk of Explosion.

## Specific Safety Instructions

1. The warnings and precautions discussed in this manual cannot cover all possible conditions and situations that may occur. It must be understood by the operator that common sense and caution are factors which cannot be built into this product, but must be supplied by the operator.
2. **WARNING:** Some dust created by power sanding, sawing, grinding, drilling, and other construction activities, contains chemicals known [to the State of California] to cause cancer, birth defects or other reproductive harm. Some examples of these chemicals are:
  - Lead from lead-based paints
  - Crystalline silica from bricks and cement or other masonry products
  - Arsenic and chromium from chemically treated lumber
 Your risk from these exposures varies, depending on how often you do this type of work. To reduce your exposure to these chemicals: work in a well ventilated area, and work with approved safety equipment, such as those dust masks that are specially designed to filter out microscopic particles. (California Health & Safety Code § 25249.5, *et seq.*)  
**WARNING:** The brass components of this product contain lead, a chemical known to the State of California to cause birth defects (or other reproductive harm). (California Health & Safety code § 25249.5, *et seq.*)
3. Only use with accessories rated to handle the forces exerted by this tool during operation. Other accessories not designed for the forces generated may break and forcefully launch pieces.
4. Attach all accessories properly to the tool before connecting the air supply. A loose accessory may detach or break during operation.

5. Obey the manual for the air compressor used to power this tool.
6. Install an in-line shutoff valve to allow immediate control over the air supply in an emergency, even if a hose is ruptured.
7. Use this tool with both hands only. Using tools with only one hand can result in loss of control.
8. Do not lay the tool down until it has come to a complete stop. Moving parts can grab the surface and pull the tool out of your control.
3. Wear suitable gloves to reduce the vibration effects on the user.
4. Use tools with the lowest vibration when there is a choice between different processes.
5. Include vibration-free periods each day of work.
6. Grip tool as lightly as possible (while still keeping safe control of it). Let the tool do the work.
7. To reduce vibration, maintain tool as explained in this manual. If abnormal vibration occurs, stop immediately.

### **Vibration Precautions**

This tool vibrates during use. Repeated or long-term exposure to vibration may cause temporary or permanent physical injury, particularly to the hands, arms and shoulders. To reduce the risk of vibration-related injury:

1. Anyone using vibrating tools regularly or for an extended period should first be examined by a doctor and then have regular medical check-ups to ensure medical problems are not being caused or worsened from use. Pregnant women or people who have impaired blood circulation to the hand, past hand injuries, nervous system disorders, diabetes, or Raynaud's Disease should not use this tool. If you feel any medical or physical symptoms related to vibration (such as tingling, numbness, and white or blue fingers), seek medical advice as soon as possible.
2. Do not smoke during use. Nicotine reduces the blood supply to the hands and fingers, increasing the risk of vibration-related injury.



**SAVE THESE  
INSTRUCTIONS.**

# FUNCTIONAL DESCRIPTION

## Specifications

Air Pressure Range	90 PSI
Maximum Air Pressure	90 PSI
Air Inlet	1/4" -18 NPT
Maximum Speed*	700 RPM
Air Consumption	5 CFM @ 90 PSI
Arbor/Chuck Capacity	1/16 - 1/2"

\* Maximum speed at stated maximum air pressure. Excess air pressure is hazardous and may cause the tool to exceed stated maximum speed.

## Components and Controls

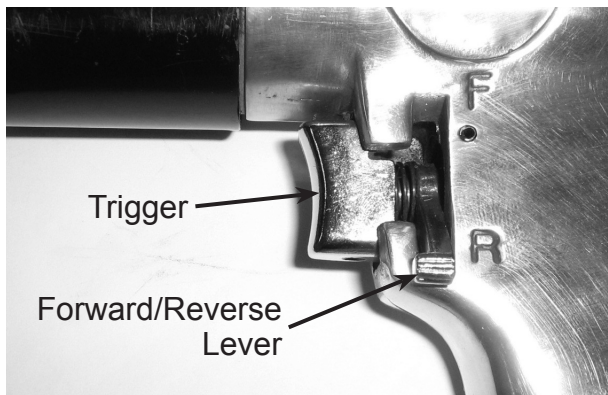

Fig. 1

1. Reversible feature controlled by the Forward/Reverse lever next to the power trigger. (See Fig. 1.) Move switch up toward "F" for forward and down toward "R" for reverse

## INITIAL TOOL SET UP/ ASSEMBLY



Read the **ENTIRE IMPORTANT SAFETY INFORMATION** section at the beginning of this manual including all text under subheadings therein before set up or use of this product.

**Note:** For additional information regarding the parts listed in the following pages,

refer to the Assembly Diagram near the end of this manual.

## Unpacking

When unpacking, check to make sure that the item is intact and undamaged. If any parts are missing or broken, please call Harbor Freight Tools at the number shown throughout the manual as soon as possible.

- This air tool may be shipped with a protective plug covering the air inlet. Remove this plug before set up.

## Air Supply

### ⚠ WARNING TO PREVENT EXPLOSION:



Use only clean, dry, regulated, compressed air to power this tool. Do not use oxygen, carbon dioxide, combustible gases, or any other bottled gas as a power source for this tool.

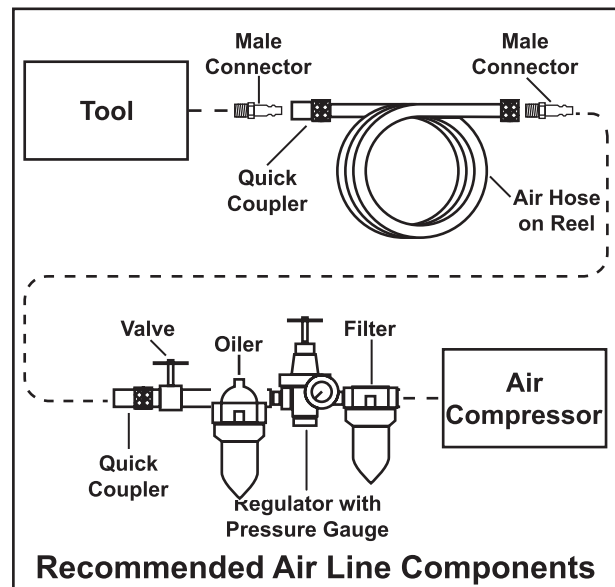

Fig. 2

1. Incorporate an in-line oiler, shut-off valve, regulator with pressure gauge,



and filter for best service, as shown in the diagram above. **An in-line shutoff valve is an important safety device because it controls the air supply even if the air hose is ruptured.** (See Fig. 2.)

**Note:** If an automatic oiler system is not used, add a few drops of Pneumatic Tool Oil to the airline connection before operation. Add a few more drops after each hour of continual use. Oiling location is engraved into the bottom of the handle next to the drill's air inlet.

2. Attach an air hose to the compressor's air outlet. Connect the air hose to the air inlet of the tool. Other components, such as a connector and quick coupler, will make operation more efficient, but are not required.

**⚠WARNING! TO PREVENT SERIOUS INJURY FROM ACCIDENTAL OPERATION:**

**Do not install a female quick coupler on the tool.** Such a coupler contains an air valve that will allow the air tool to retain pressure and operate accidentally after the air supply is disconnected.

**Note:** Air flow, and therefore tool performance, can be hindered by undersized air supply components.

3. The air hose must be long enough to reach the work area with enough extra length to allow free movement while working.
4. Make sure the tool's throttle or switch is in the off position; refer to Operation section for description of controls.

5. Close the in-line safety valve between the compressor and the tool.
6. Turn on the air compressor according to the manufacturer's directions and allow it to build up pressure until it cycles off.
7. Adjust the air compressor's output regulator so that the air output is enough to properly power the tool, but the output will not exceed the tool's maximum air pressure at any time. Adjust the pressure gradually, while checking the air output gauge to set the right pressure range.
8. Inspect the air connections for leaks. Repair any leaks found.
9. If the tool will not be used at this time, turn off and detach the air supply, safely discharge any residual air pressure, and release the throttle and/or turn the switch to its off position to prevent accidental operation.

**Note:** Residual air pressure should not be present after the tool is disconnected from the air supply. However, it is a good safety measure to attempt to discharge the tool in a safe fashion after disconnecting to ensure that the tool is disconnected and unpowered.

## OPERATING INSTRUCTIONS



Read the **ENTIRE IMPORTANT SAFETY INFORMATION** section at the beginning of this manual including all text under subheadings therein before set up or use of this product.

Inspect tool before use, looking for damaged, loose, and missing parts. If any problems are found, do not use tool until repaired.

### Tool Set Up

#### **⚠️ WARNING** TO PREVENT SERIOUS INJURY FROM ACCIDENTAL OPERATION:

Turn off the tool, detach the air supply, safely discharge any residual air pressure in the tool, and release the throttle and/or turn the switch to its off position before performing any inspection, maintenance, or cleaning procedures.

#### TO PREVENT SERIOUS INJURY:

Do not adjust or tamper with any control or component in a way not specifically explained within this manual. Improper adjustment can result in tool failure or other serious hazards.

1. You will need to prepare a 1/4" air connector to connect to the Air Inlet (13) on the Drill. First, wrap the 1/4" air connector with pipe thread seal tape before connecting to a 1/4"

ID Air Source Hose (not included). Connect the Air Source Hose to the Drill.

**Note:** If you are not using an automatic oiler system, before operation, add a few drops of Pneumatic Tool Oil to the airline connection. Add a few drops more after each hour of continual use.

2. Set the air pressure on your compressor to 90 PSI. Do not exceed the maximum air pressure of 90 PSI.
3. Check the air connection for leaks.

**Warning!** Always disconnect the unit from the air compressor when changing bits.

**Warning!** After drilling, the bit will be extremely hot. Do not touch it until it has had ample time to cool down.

**Note:** To reverse the drill's direction, flip the **Reverse Lever** on the handle down. (See Fig.1).

4. **To install the handle:** Slide the **Handle Ring (35)** over the **Clamp Nut (30)** in the desired position. Install the **Handle (34)** over the threaded portion of the **Handle Ring (35)** and tighten securely.

5. Insert the **Chuck Key (36)** into one of the holes in the **Chuck (32)** and turn it counterclockwise to open the jaws.

6. Insert the bit and hand tighten it, then tighten it with the **Chuck Key (36)** by turning it clockwise.

7. With heavy leather gloves on, tug on the bit and make sure it is securely attached. Check that it is straight.

**Note:** Always use sharp bits. Dull or damaged bits may cause undue stress on the drill and possibly break causing injury. Bits are available at Harbor Freight Tools.

8. Securely clamp your workpiece.

### **Work Piece and Work Area Set Up**

1. Designate a work area that is clean and well-lit. The work area must not allow access by children or pets to prevent injury and distraction.
2. Route the air hose along a safe route to reach the work area without creating a tripping hazard or exposing the air hose to possible damage. The air hose must be long enough to reach the work area with enough extra length to allow free movement while working.
3. Secure loose workpieces using a vise or clamps (not included) to prevent movement while working.
4. There must not be hazardous objects (such as utility lines or foreign objects) nearby that will present a hazard while working.

### **General Operating Instructions**

1. If an automatic oiler is not used, add a few drops of Pneumatic Tool Oil to the airline connection before use. Add a few drops more after each hour of continual use.
2. If the tool requires more force to accomplish the task, verify that the tool receives sufficient, unobstructed airflow (CFM) and increase the pressure (PSI) output of the regulator up to the maximum air pressure rating of this tool. **CAUTION! TO PREVENT TOOL AND ACCESSORY FAILURE, RESULTING IN INJURY: Do not exceed the tool's maximum air pressure rating.** If the tool still does not have sufficient force at maximum pressure and sufficient airflow, then a larger tool may be required.

3. When drilling wood, place the bit at the point to be drilled. If you are drilling a hard, smooth surface, use a punch to mark the drill location. Grasp the drill firmly with both hands while slowly squeezing the Trigger (8). Never force the tool. Only apply light pressure when horizontal drilling.

**Note:** When drilling plastics or plastic coated chip board, follow the same directions as stated in number 9 for wood.

**Note:** If a bit becomes wedged into the workpiece, remove it from the drill and use the appropriate hand tools to remove it.

4. When drilling metal, always use a punch to mark the drilling position. Use a cutting oil with most metals, to prolong the life of the bit and increase the drilling action. With steel, tin, and sheet metal use a light machine oil, with aluminum, use paraffin. Do not use lubricants with brass, copper, and cast iron. Grasp the drill firmly with both hands and follow the directions given in #9 above.
5. When done drilling, release pressure on the **Trigger (8)**. The drill will slow to a stop. Disconnect the Air Drill from the air compressor hose.
6. To prevent accidents, turn off the tool, detach the air supply, safely discharge any residual air pressure in the tool, and release the throttle and/or turn the switch to its off position after use. Clean external surfaces of the tool with clean, dry cloth, and apply a thin coat of tool oil. Then store the tool indoors out of children's reach.

---

## USER-MAINTENANCE INSTRUCTIONS

---



Procedures not specifically explained in this manual must be performed only by a qualified technician.

### **!WARNING**

#### **TO PREVENT SERIOUS INJURY**

##### **FROM ACCIDENTAL OPERATION:**

Turn off the tool, detach the air supply, safely discharge any residual air pressure in the tool, and release the throttle and/or turn the switch to its off position before performing any inspection, maintenance, or cleaning procedures.

##### **TO PREVENT SERIOUS INJURY FROM TOOL FAILURE:**

Do not use damaged equipment. If abnormal noise, vibration, or leaking air occurs, have the problem corrected before further use.



##### **TO PREVENT EXPLOSION:**

Lubricate the tool only with specified lubricants. Lubricate the air inlet using only pneumatic tool oil. Lubricate the internal mechanism using only white lithium grease. Other lubricants may damage the mechanism and may be highly flammable, causing an explosion.

---

## Cleaning, Maintenance, and Lubrication

---

**Note:** These procedures are in addition to the regular checks and maintenance explained as part of the regular operation of the air-operated tool.

1. **Daily - Air Supply Maintenance:**  
Every day, perform maintenance on the air supply according to the component manufacturers' instructions. The lubricator's oil level needs to be maintained and the moisture filter must be regularly drained. Performing routine maintenance on the air supply will allow the tool to operate more safely and will also reduce wear on the tool.
2. **Weekly - Grease Lubrication:**  
Lubricate the internal mechanism of the tool, using white lithium grease through the grease fittings. See Lubrication Diagram below.
3. **Quarterly (every 3 months) - Tool Disassembly, Cleaning, and Inspection:**  
Have the internal mechanism cleaned, inspected, and lubricated by a qualified technician. If the vanes need replacement, all vanes should be replaced as a set.

## Troubleshooting

Problem	Possible Causes	Likely Solutions
Decreased output.	<ol style="list-style-type: none"> <li>1. Not enough air pressure and/or air flow.</li> <li>2. Obstructed trigger.</li> <li>3. Incorrect lubrication or not enough lubrication.</li> <li>4. Blocked air inlet screen (if equipped).</li> <li>5. Air leaking from loose housing.</li> <li>6. Mechanism contaminated.</li> <li>7. Vane wear or damage.</li> </ol>	<ol style="list-style-type: none"> <li>1. Check for loose connections and make sure that air supply is providing enough air flow (CFM) at required pressure (PSI) to the tool's air inlet. <b>Do not exceed maximum air pressure.</b></li> <li>2. <b>Clean around trigger to ensure free movement.</b></li> <li>3. Lubricate using air tool oil and grease according to directions.</li> <li>4. Clean air inlet screen of buildup.</li> <li>5. Make sure housing is properly assembled and tight.</li> <li>6. Have qualified technician clean and lubricate mechanism. Install in-line filter in air supply as stated in Initial Set Up: Air Supply.</li> <li>7. Replace all vanes.</li> </ol>
Housing heats during use.	<ol style="list-style-type: none"> <li>1. Incorrect lubrication or not enough lubrication.</li> <li>2. Worn parts.</li> </ol>	<ol style="list-style-type: none"> <li>1. Lubricate using air tool oil and grease according to directions.</li> <li>2. Have qualified technician inspect internal mechanism and replace parts as needed.</li> </ol>
Severe air leakage. (Slight air leakage is normal, especially on older tools.)	<ol style="list-style-type: none"> <li>1. Cross-threaded housing components.</li> <li>2. Loose housing.</li> <li>3. Damaged valve or housing.</li> <li>4. Dirty, worn or damaged valve.</li> </ol>	<ol style="list-style-type: none"> <li>1. Check for incorrect alignment and uneven gaps. If cross-threaded, disassemble and replace damaged parts before use.</li> <li>2. Tighten housing assembly. If housing cannot tighten properly, internal parts may be misaligned.</li> <li>3. Replace damaged components.</li> <li>4. Clean or replace valve assembly.</li> </ol>
<div style="display: flex; align-items: center;">  <p><b>Follow all safety precautions whenever diagnosing or servicing the tool. Disconnect air supply before service.</b></p> </div>		

**PLEASE READ THE FOLLOWING  
CAREFULLY**

THE MANUFACTURER AND/OR DISTRIBUTOR HAS PROVIDED THE PARTS LIST AND ASSEMBLY DIAGRAM IN THIS MANUAL AS A REFERENCE TOOL ONLY. NEITHER THE MANUFACTURER OR DISTRIBUTOR MAKES ANY REPRESENTATION OR WARRANTY OF ANY KIND TO THE BUYER THAT HE OR SHE IS QUALIFIED TO MAKE ANY REPAIRS TO THE PRODUCT, OR THAT HE OR SHE IS QUALIFIED TO REPLACE ANY PARTS OF THE PRODUCT. IN FACT, THE MANUFACTURER AND/OR DISTRIBUTOR EXPRESSLY STATES THAT ALL REPAIRS AND PARTS REPLACEMENTS SHOULD BE UNDERTAKEN BY CERTIFIED AND LICENSED TECHNICIANS, AND NOT BY THE BUYER. THE BUYER ASSUMES ALL RISK AND LIABILITY ARISING OUT OF HIS OR HER REPAIRS TO THE ORIGINAL PRODUCT OR REPLACEMENT PARTS THERETO, OR ARISING OUT OF HIS OR HER INSTALLATION OF REPLACEMENT PARTS THERETO.

**PARTS LIST**

<b>Part</b>	<b>Description</b>	<b>Q'ty</b>
1	Housing	1
2	O-Ring	1
3	O-Ring	1
4	Valve Stem	1
5	O-Ring	3
6	Bushing	1
7	Trigger Spring	1
8	Trigger	1
9	Trigger Screw	1
10	Pin	1
11	Muffler Cover	1
12	Screw	2
13	Air Inlet	1
14	Bearing	2
15	End Plate	1
16	Rotor	1
17	Rotor Blade	5
18	Cylinder	1
19	Pin	1
20	Front Plate	1
21	Washer	1
22	Gear	1
23	Gear	6
24	Pin	6
25	Gear Plate	1
26	Gear	1
27	Work Spindle	1
28	Thread Ring Gear	2
29	Bearing	2
30	Clamp Nut	1
31	Washer	1
32	Chuck	1
33	Chuck Screw	1
34	Handle	1
35	Handle Ring	1
36	Chuck Key (See Cover Photo)	1
37	Air Coupler/Fitting (Not Shown)	1

---

# ASSEMBLY DIAGRAM

---

## Assembly Drawing

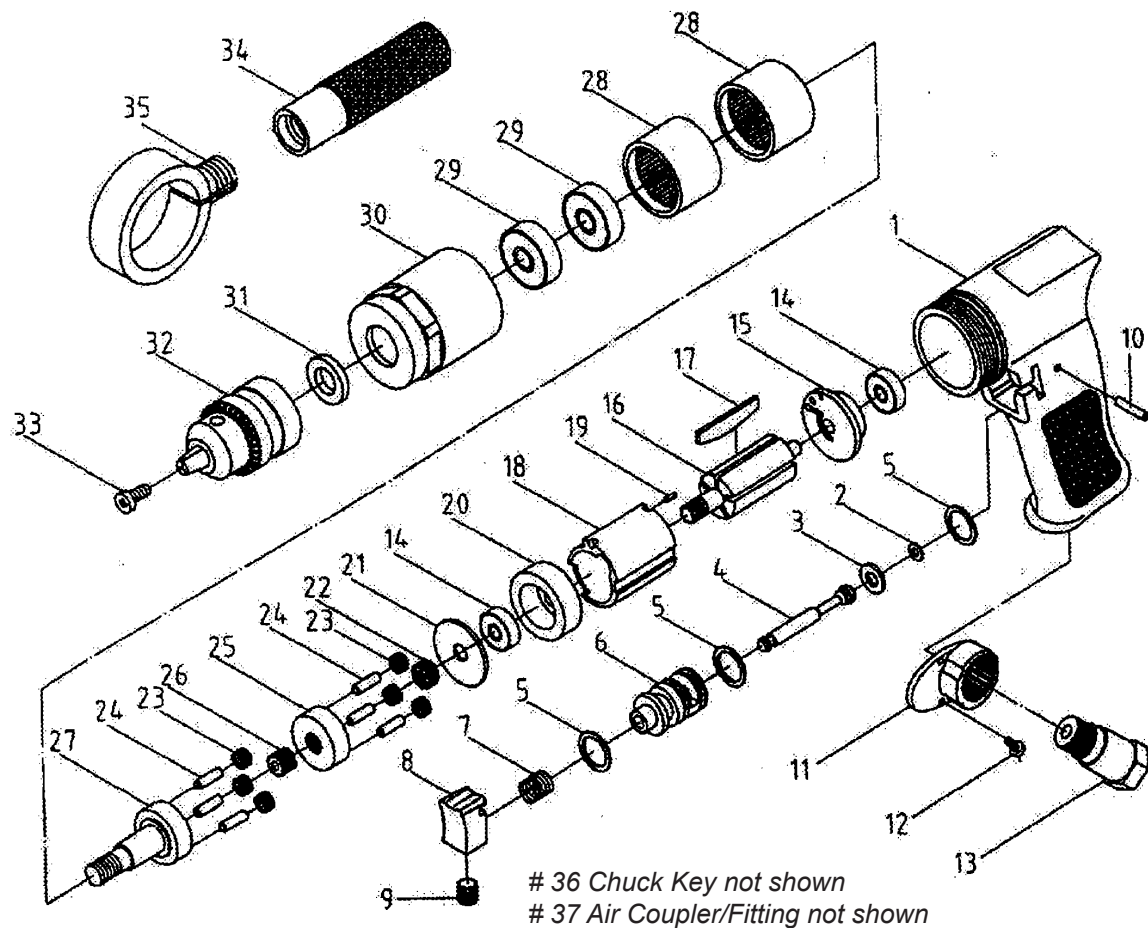

Record Product's Serial Number Here: \_\_\_\_\_

**Note:** If product has no serial number, record month and year of purchase instead.

**Note:** Some parts are listed and shown for illustration purposes only, and are not available individually as replacement parts.

---

## LIMITED 1 YEAR WARRANTY

---

Harbor Freight Tools Co. makes every effort to assure that its products meet high quality and durability standards, and warrants to the original purchaser that this product is free from defects in materials and workmanship for the period of one year from the date of purchase (90 days if used by a professional contractor or if used as rental equipment). This warranty does not apply to damage due directly or indirectly, to misuse, abuse, negligence or accidents, repairs or alterations outside our facilities, normal wear and tear, or to lack of maintenance. We shall in no event be liable for death, injuries to persons or property, or for incidental, contingent, special or consequential damages arising from the use of our product. Some states do not allow the exclusion or limitation of incidental or consequential damages, so the above limitation of exclusion may not apply to you. THIS WARRANTY IS EXPRESSLY IN LIEU OF ALL OTHER WARRANTIES, EXPRESS OR IMPLIED, INCLUDING THE WARRANTIES OF MERCHANTABILITY AND FITNESS.

To take advantage of this warranty, the product or part must be returned to us with transportation charges prepaid. Proof of purchase date and an explanation of the complaint must accompany the merchandise. If our inspection verifies the defect, we will either repair or replace the product at our election or we may elect to refund the purchase price if we cannot readily and quickly provide you with a replacement. We will return repaired products at our expense, but if we determine there is no defect, or that the defect resulted from causes not within the scope of our warranty, then you must bear the cost of returning the product.

This warranty gives you specific legal rights and you may also have other rights which vary from state to state.

**3491 Mission Oaks Blvd. • PO Box 6009 • Camarillo, CA 93011 • (800) 444-3353**



## Free Manuals Download Website

<http://myh66.com>

<http://usermanuals.us>

<http://www.somanuals.com>

<http://www.4manuals.cc>

<http://www.manual-lib.com>

<http://www.404manual.com>

<http://www.luxmanual.com>

<http://aubethermostatmanual.com>

Golf course search by state

<http://golfingnear.com>

Email search by domain

<http://emailbydomain.com>

Auto manuals search

<http://auto.somanuals.com>

TV manuals search

<http://tv.somanuals.com>