

CHICAGO

Electric Power Tools

3 N 1

Leaf Blower Vac

Model 91010

ASSEMBLY AND OPERATING INSTRUCTIONS



3491 Mission Oaks Blvd., Camarillo, CA 93011
Visit our Web site at: <http://www.harborfreight.com>

Copyright © 2003 by Harbor Freight Tools®. All rights reserved. No portion of this manual or any artwork contained herein may be reproduced in any shape or form without the express written consent of Harbor Freight Tools.

For technical questions, please call 1-800-444-3353.

PRODUCT SPECIFICATIONS

Construction	Injection molded polypropylene plastic housing and tube blower	Fan blower type	Totally enclosed fan cooled white polypropylene fan
Motor Unit	110-120 Volts AC, 60 Hz	Motor Power	2100 Watts, 20.8 Amps Peak Power
Speed Control	Dial Control, settings 1 - 6	Motor Speed	variable 8000 - 15,000 rpm
Weight	12.5 lbs.	Capacity	12 gallons
Motor Housing Dimensions	17-3/4"L x 8-1/2"W x 14-1/2"H	Inlet Dimensions	7-1/4"L x 5-5/16"W x 2-1/2" Diam.
Sound Pressure Level	84.3 decibels (dB)		
Air Speed	87-156 mph		

SAVE THIS MANUAL

You will need this manual for the safety warnings and precautions, assembly, operating, inspection, maintenance and cleaning procedures, parts list and assembly diagram. Keep your invoice with this manual. Write the invoice number on the inside of the front cover. Keep this manual and invoice in a safe and dry place for future reference.

GENERAL SAFETY RULES

 **WARNING!**

READ AND UNDERSTAND ALL INSTRUCTIONS
Failure to follow all instructions listed below may result in electric shock, fire, and/or serious injury.
SAVE THESE INSTRUCTIONS

WORK AREA

1. **Keep your work area clean and well lit.** Cluttered and dark areas invite accidents.
2. **Do not operate power tools in explosive atmospheres, such as in the presence of flammable liquids, gases, or dust.** Power tools create sparks which may ignite the dust or fumes.
3. **Keep bystanders, children, and visitors away while operating a power tool.** Distractions can cause you to lose control. Protect others in the work area from debris such as chips and sparks. Provide barriers or shields as needed.

ELECTRICAL SAFETY

4. **Grounded tools must be plugged into an outlet properly installed and grounded in accordance with all codes and ordinances. Never remove the grounding prong or modify the plug in any way. Do not use any adapter plugs. Check with a qualified electrician if you are in doubt as to whether the outlet is properly grounded.** If the tool should electrically malfunction or break down, grounding provides a low resistance path to carry electricity away from the user.
5. **Double insulated tools are equipped with a polarized plug (one blade is wider than the other). This plug will fit in a polarized outlet only one way. If the plug does not fit fully in the outlet, reverse the plug. If it still does not fit, contact a qualified electrician to install a polarized outlet. Do not change the plug in any way.** Double insulation eliminates the need for the three wire grounded power cord and grounded power supply system.
6. **Avoid body contact with grounded surfaces such as pipes, radiators, ranges, and refrigerators.** There is an increased risk of electric shock if your body is grounded.
7. **Do not expose power tools to rain or wet conditions.** Water entering a power tool will increase the risk of electric shock.
8. **Do not abuse the Power Cord. Never use the Power Cord to carry the tool or pull the Plug from an outlet. Keep the Power Cord away from heat, oil, sharp edges, or moving parts. Replace damaged Power Cords immediately.** Damaged Power Cords increase the risk of electric shock.
9. **When operating a power tool outside, use an outdoor extension cord marked “W-A” or “W”.** These extension cords are rated for outdoor use, and reduce the risk of electric shock.

PERSONAL SAFETY

10. **Stay alert. Watch what you are doing, and use common sense when operating a power tool. Do not use a power tool while tired or under the influence of drugs, alcohol, or medication.** A moment of inattention while operating power tools may result in serious personal injury.
11. **Dress properly. Do not wear loose clothing or jewelry. Contain long hair. Keep your hair, clothing, and gloves away from moving parts and blower tubes.** Loose clothes, jewelry, or long hair can be caught in moving parts or blower tubes.

12. **Avoid accidental starting. Be sure the Power Switch is off before plugging in.** Carrying power tools with your finger on the Power Switch, or plugging in power tools with the Power Switch on, invites accidents.
13. **Remove adjusting keys or wrenches before turning the power tool on.** A wrench or a key that is left attached to a rotating part of the power tool may result in personal injury.
14. **Do not overreach. Keep proper footing and balance at all times.** Proper footing and balance enables better control of the power tool in unexpected situations.
15. **Use safety equipment. Always wear eye protection.** Dust mask, non-skid safety shoes, hard hat, or hearing protection must be used for appropriate conditions.

TOOL USE AND CARE



16. **Do not force the tool. Use the correct tool for your application.** The correct tool will do the job better and safer at the rate for which it is designed.
17. **Do not use the power tool if the Power Switch does not turn it on and off.** Any tool that cannot be controlled with the Power Switch is dangerous and must be replaced.
18. **Disconnect the Power Cord Plug from the power source before making any adjustments, changing accessories, or storing the tool.** Such preventive safety measures reduce the risk of starting the tool accidentally.
19. **Store idle tools out of reach of children and other untrained persons.** Tools are dangerous in the hands of untrained users.
20. **Check for misalignment or binding of moving parts, breakage of parts, and any other condition that may affect the tool's operation. If damaged, have the tool serviced before using.** Many accidents are caused by poorly maintained tools.
21. **Use only accessories that are recommended by the manufacturer for your model.** Accessories that may be suitable for one tool may become hazardous when used on another tool.

SERVICE

22. **Tool service must be performed only by qualified repair personnel.** Service or maintenance performed by unqualified personnel could result in a risk of injury.
23. **When servicing a tool, use only identical replacement parts. Follow instructions in the “*Inspection, Maintenance, And Cleaning*” section of this manual.** Use of unauthorized parts or failure to follow maintenance instructions may create a risk of electric shock or injury.

SPECIFIC SAFETY RULES

1. **Maintain labels and nameplates on the Vacuum Leaf Blower.** These carry important information. If unreadable or missing, contact Harbor Freight Tools for a replacement.
2. **Always wear safety impact eye goggles and heavy work gloves when using the Vacuum Leaf Blower.** Using personal safety devices reduce the risk for injury. Safety impact eye goggles and heavy work gloves are available from Harbor Freight Tools.
3. **Maintain a safe working environment.** Keep the work area well lit. Make sure there is adequate surrounding workspace. Always keep the work area free of obstructions, grease, oil and other debris. Do not use a power tool in areas near flammable chemicals, dusts, and vapors. Do not use this product in a damp or wet location.
4. **When using a hand-held power tool, always maintain a firm grip on the tool with both hands to resist starting torque.**
5. **Always keep the extension cord away from moving parts on the tool.**
6. **Avoid unintentional starting.** Make sure you are prepared to begin work before turning on the Vacuum Leaf Blower.
7. **Do not force the Vacuum Leaf Blower.** This tool will do the work better and safer at the speed and capacity for which it was designed.
8.  **WARNING!** Never reach into this tool while the motor is running; serious injury may result. Never operate this tool with the Blower Tube Assembly removed; serious injury may result.
9. Never point the Leaf Blower Vacuum at people or animals.

10.  **WARNING!** Never operate this tool in the rain or wet conditions. Danger of electrical shock or electrocution exists in these conditions.
11. **Never lay the Vacuum Leaf Blower down until the motor has come to a complete stop.** Allow the motor to come to a complete stop before releasing it, as an uncontrolled running tool may create risk of serious injury.
12. **Never leave the Vacuum Leaf Blower unattended when it is plugged into an electrical outlet.** Turn off the tool, and unplug it from its electrical outlet before leaving.
13. **Always unplug the Vacuum Leaf Blower from its electrical outlet before performing and inspection, maintenance, or cleaning procedures.**
14.  **WARNING!** People with pacemakers should consult their physician(s) before using this product. Operation of electrical equipment in close proximity to a heart pacemaker could cause interference or failure of the pacemaker.

UNPACKING

When unpacking, check to make sure that your item is in good condition, and all the following are included. If any parts are missing or broken, please call Harbor Freight Tools at the number shown on the cover of this manual as soon as possible.

Your product should include:

Main blower body

Blower extension

Mulch bag

Carrying strap

Wheel assembly

PRODUCT FEATURES AND BENEFITS

This tool offers three separate functions in one. You can use it as a vacuum leaf blower, mulcher, and vacuum. It offers 6 variable speeds from 8,000 to 15,000 rpm, to suit your particular need. It is ideal for maintaining your property, as well as blowing out a garage, workshop, truck bed or other similar use.

GROUNDING

WARNING!

Improperly connecting the grounding wire can result in the risk of electric shock. Check with a qualified electrician if you are in doubt as to whether the outlet is properly grounded. Do not modify the power cord plug provided with the tool. Never remove the grounding prong from the plug. Do not use the tool if the power cord or plug is damaged. If damaged, have it repaired by a service facility before use. If the plug will not fit the outlet, have a proper outlet installed by a qualified electrician.

GROUNDING TOOLS: TOOLS WITH THREE PRONG PLUGS

1. Tools marked with “Grounding Required” have a three wire cord and three prong grounding plug. The plug must be connected to a properly grounded outlet. If the tool should electrically malfunction or break down, grounding provides a low resistance path to carry electricity away from the user, reducing the risk of electric shock. **(See Figure A.)**
2. The grounding prong in the plug is connected through the green wire inside the cord to the grounding system in the tool. The green wire in the cord must be the only wire connected to the tool’s grounding system and must never be attached to an electrically “live” terminal. **(See Figure A.)**
3. Your tool must be plugged into an appropriate outlet, properly installed and grounded in accordance with all codes and ordinances. The plug and outlet should look like those in the following illustration. **(See Figure A.)**

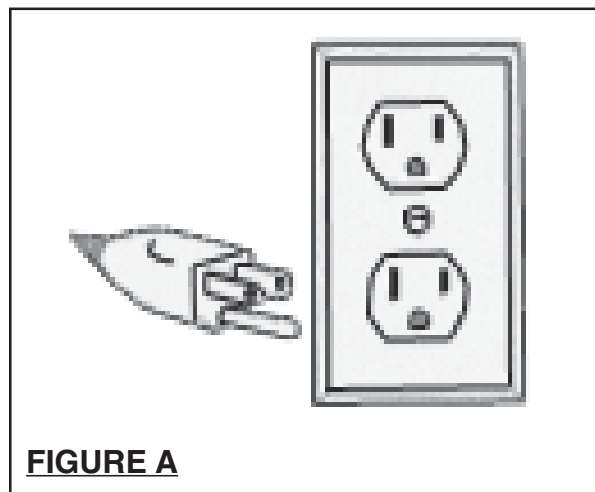

DOUBLE INSULATED TOOLS: TOOLS WITH TWO PRONG PLUGS

4. Tools marked "Double Insulated" do not require grounding. They have a special double insulation system which satisfies OSHA requirements and complies with the applicable standards of Underwriters Laboratories, Inc., the Canadian Standard Association, and the National Electrical Code. **(See Figure B.)**
5. Double insulated tools may be used in either of the 120 volt outlets shown in the following illustration. **(See Figure B.)**

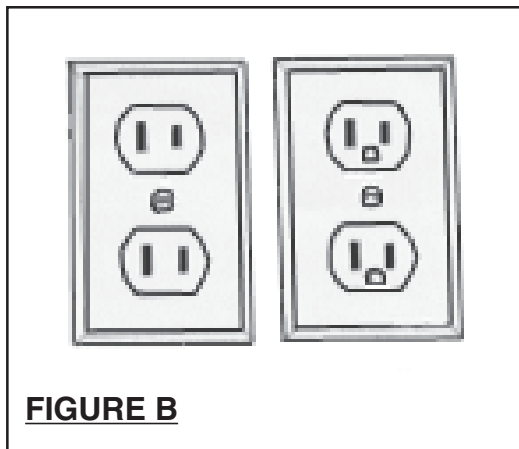

This tool has a 2-prong, polarized plug.

EXTENSION CORDS



1. **Grounded** tools require a three wire extension cord. **Double Insulated** tools can use either a two or three wire extension cord.
2. As the distance from the supply outlet increases, you must use a heavier gauge extension cord. Using extension cords with inadequately sized wire causes a serious drop in voltage, resulting in loss of power and possible tool damage. **(See Figure C, next page.)**
3. The smaller the gauge number of the wire, the greater the capacity of the cord. For example, a 14 gauge cord can carry a higher current than a 16 gauge cord. **(See Figure C.)**
4. When using more than one extension cord to make up the total length, make sure each cord contains at least the minimum wire size required. **(See Figure C.)**
5. If you are using one extension cord for more than one tool, add the nameplate amperes and use the sum to determine the required minimum cord size.

6. If you are using an extension cord outdoors, make sure it is marked with the suffix "W-A" ("W" in Canada) to indicate it is acceptable for outdoor use.
7. Make sure your extension cord is properly wired and in good electrical condition. Always replace a damaged extension cord or have it repaired by a qualified electrician before using it.
8. Protect your extension cords from sharp objects, excessive heat, and damp or wet areas.

RECOMMENDED MINIMUM WIRE GAUGE FOR EXTENSION CORDS* (120 VOLT)					
NAMEPLATE AMPERES (At Full Load)	EXTENSION CORD LENGTH				
	25 Feet	50 Feet	75 Feet	100 Feet	150 Feet
0 – 2.0	18	18	18	18	16
2.1 – 3.4	18	18	18	16	14
3.5 – 5.0	18	18	16	14	12
5.1 – 7.0	18	16	14	12	12
7.1 – 12.0	18	14	12	10	-
12.1 – 16.0	14	12	10	-	-
16.1 – 20.0	12	10	-	-	-

FIGURE C * Based on limiting the line voltage drop to five volts at 150% of the rated amperes.

SYMBOLOLOGY

	Double Insulated
	Canadian Standards Association
	Underwriters Laboratories, Inc.
V ~	Volts Alternating Current
A	Amperes
n_oxxxx/min.	No Load Revolutions per Minute (RPM)

ASSEMBLY AND OPERATING INSTRUCTIONS

CAUTION: Always make sure the Power Cord is unplugged from its electrical outlet *prior* to assembling or making any adjustments to the tool.

Attaching and removing the Blower Tube Assembly:

(Please see assembly diagram on next page)

1. Insert the guiding end of the Blower Extension into the Upper Tube. Push the two sections together firmly until the clip engages. These two pieces together form the Blower Tube Assembly.
2. Insert the Blower Tube Assembly firmly into the Motor Housing.
3. On the upper part of the Motor Housing, where the Blower Tube Assembly has been inserted, rotate the Fastener forward, locking the Blower Tube Assembly into the Motor Housing. Invert the entire assembly and repeat with the Fastener located on the underside of the Motor Housing.
4. To remove the Blower Tube Assembly, rotate both Fasteners toward the Motor Housing, then pull the Blower Tube Assembly straight out of the Motor Housing.

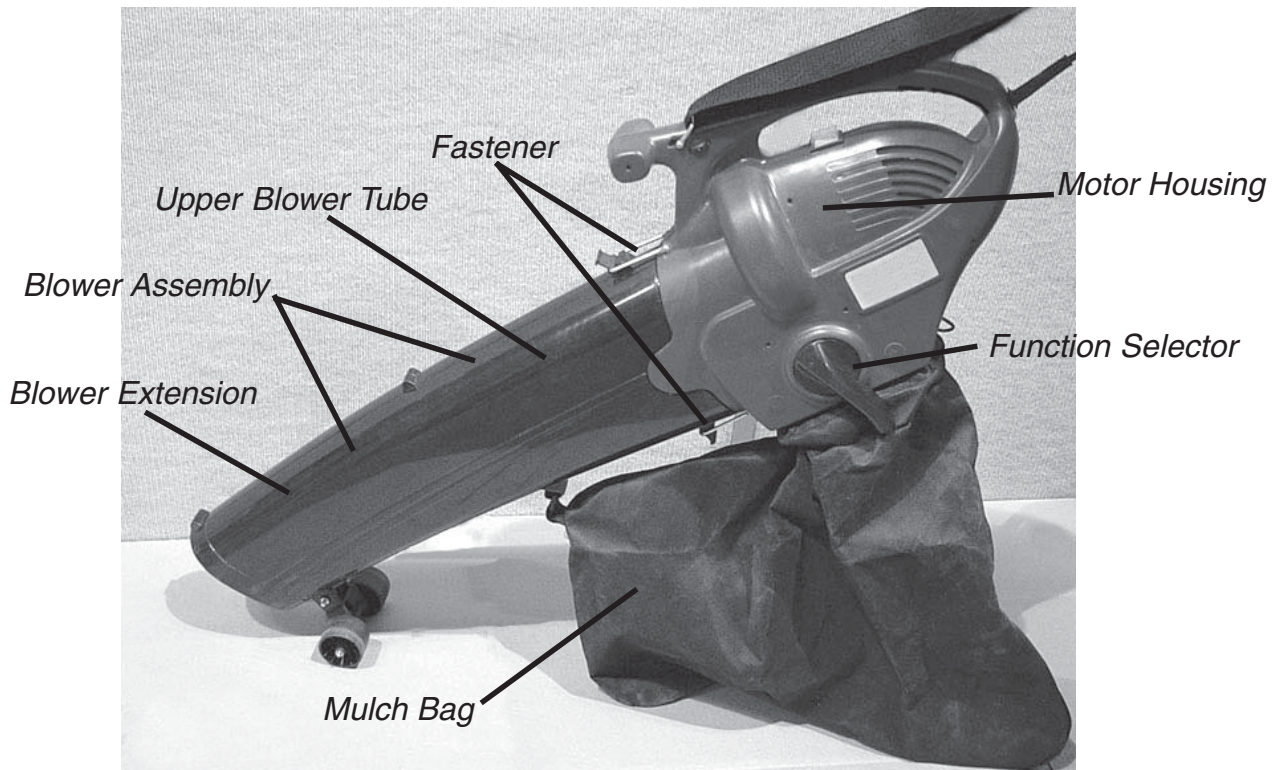

Attaching and removing the Mulch Bag:

1. Position the Mulch Bag at the underside of the unit, with the pointed end of the bag toward the open end of the blower tube. Loop the opening in the Mulch Bag over the opening at the bottom of the Motor Housing. Tighten the cord on the bag around the edge of the opening on the Motor Housing.
2. Attach the hook on the Mulch Bag to the Upper Blower Tube.

Blow / Vacuum Function Selector

1. To use this tool as a **vacuum**, rotate the Function Selector **away from the nozzle**.
2. To use this tool as **blower**, rotate the Function Selector **toward the nozzle**.

NOTE: When using this tool as a blower, it is better to remove the Mulch Bag. Since the blower function draws air into the Outlet Tube (29), having the Mulch Bag in place may restrict this inward air flow.

Turning the unit ON and OFF, and Adjusting Blower Speed

WARNING! Do not turn this unit on unless you are wearing safety glasses, and have taken precautions to be sure it is safe to do so.

1. To turn on unit, be sure it is plugged in. Then move ON/OFF Switch to the “I” position. To turn unit OFF, rotate switch to “O” position.
2. To adjust blower speed, rotate the Speed Control to any of its 6 positions.

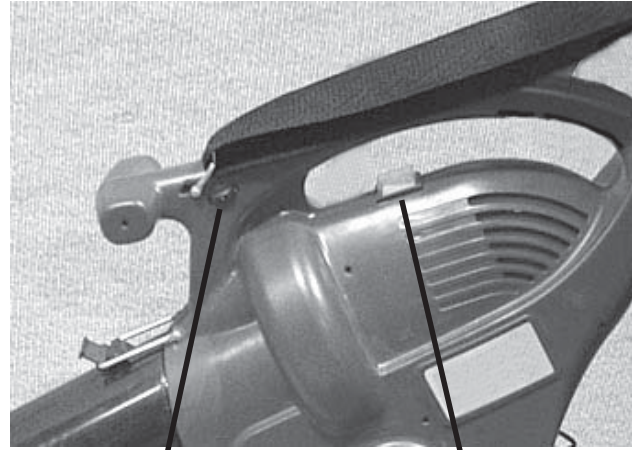

Speed Control

ON / OFF Switch

WARNING! Never direct blown air toward any person or animal.

INSPECTION, MAINTENANCE, AND CLEANING

1.  **WARNING!** Make sure the ON /OFF Switch (18) is in its “OFF” position and that the tool is unplugged from its electrical outlet before performing any inspection, maintenance, or cleaning procedures.
2. **BEFORE EACH USE**, inspect the general condition of this tool. Check for loose screws, misalignment or binding of moving parts, cracked or broken parts, damaged electrical wiring, and any other condition that may affect its safe operation. If abnormal noise or vibration occurs, have the problem corrected before further use. **Do not use damaged equipment.**
3. When using this tool as a blower, it is better to have the Mulch Bag removed.
4. When using this tool as a vacuum, the Mulch Bag will periodically fill up. When you notice it is nearly full, stop work, turn OFF the ON /OFF Switch, and unplug the unit from its power source. Remove the Mulch Bag and empty the contents into a suitable container. Then replace the Mulch Bag, reconnect the power supply, and when it is safe to do so, turn the ON /OFF Switch to the ON position and continue working.
5. When using this tool as a vacuum, avoid picking up sticks, twigs, stones, glass or other hard items. Hard items may damage the Fan (19). Sticks and twigs may clog the Blower Tube Assembly.

PARTS LIST

Part Number	Description	Part Number	Description
1	Left Motor Housing / Handle	16	Press-on Fastener
2	Left Upper and Lower Blower Tubes	17	Power Connector
3	Right Motor Housing / Handle	18	ON / OFF Switch
4	Right Upper and Lower Blower Tubes	19	Assistance Switch
5	Function Selector	20	Motor Rear Assembly
6	Screw	21	Motor
7	Pin	22	Motor Front Assembly
8	Tube Connector	23	Fan
9	Capacitor	24	Guide Wheel
10	Screw	25	Wheel Axle
11	Safety Switch	26	Lead Wind Pipe
12	Press Board	27	Fixture Screw
13	Drawstring Attachment Hook	28	Transformer
14	Power Cord	29	Outlet Tube
15	Power Cord Cuff	30 31	Mulch Bag Carrying Strap

Please refer to the Assembly Diagram on page 14.

PLEASE READ THE FOLLOWING CAREFULLY
--

THE MANUFACTURER AND/OR DISTRIBUTOR HAS PROVIDED THE PARTS LIST AND ASSEMBLY DIAGRAM IN THIS MANUAL AS A REFERENCE TOOL ONLY. NEITHER THE MANUFACTURER NOR DISTRIBUTOR MAKES ANY REPRESENTATION OR WARRANTY OF ANY KIND TO THE BUYER THAT HE OR SHE IS QUALIFIED TO MAKE ANY REPAIRS TO THE PRODUCT, OR THAT HE OR SHE IS QUALIFIED TO REPLACE ANY PARTS OF THE PRODUCT. IN FACT, THE MANUFACTURER AND/OR DISTRIBUTOR EXPRESSLY STATES THAT ALL REPAIRS AND PARTS REPLACEMENTS SHOULD BE UNDERTAKEN BY CERTIFIED AND LICENSED TECHNICIANS, AND NOT BY THE BUYER. THE BUYER ASSUMES ALL RISK AND LIABILITY ARISING OUT OF HIS OR HER REPAIRS TO THE ORIGINAL PRODUCT OR REPLACEMENT PARTS THERETO, OR ARISING OUT OF HIS OR HER INSTALLATION OF REPLACEMENT PARTS THERETO.

ASSEMBLY DIAGRAM

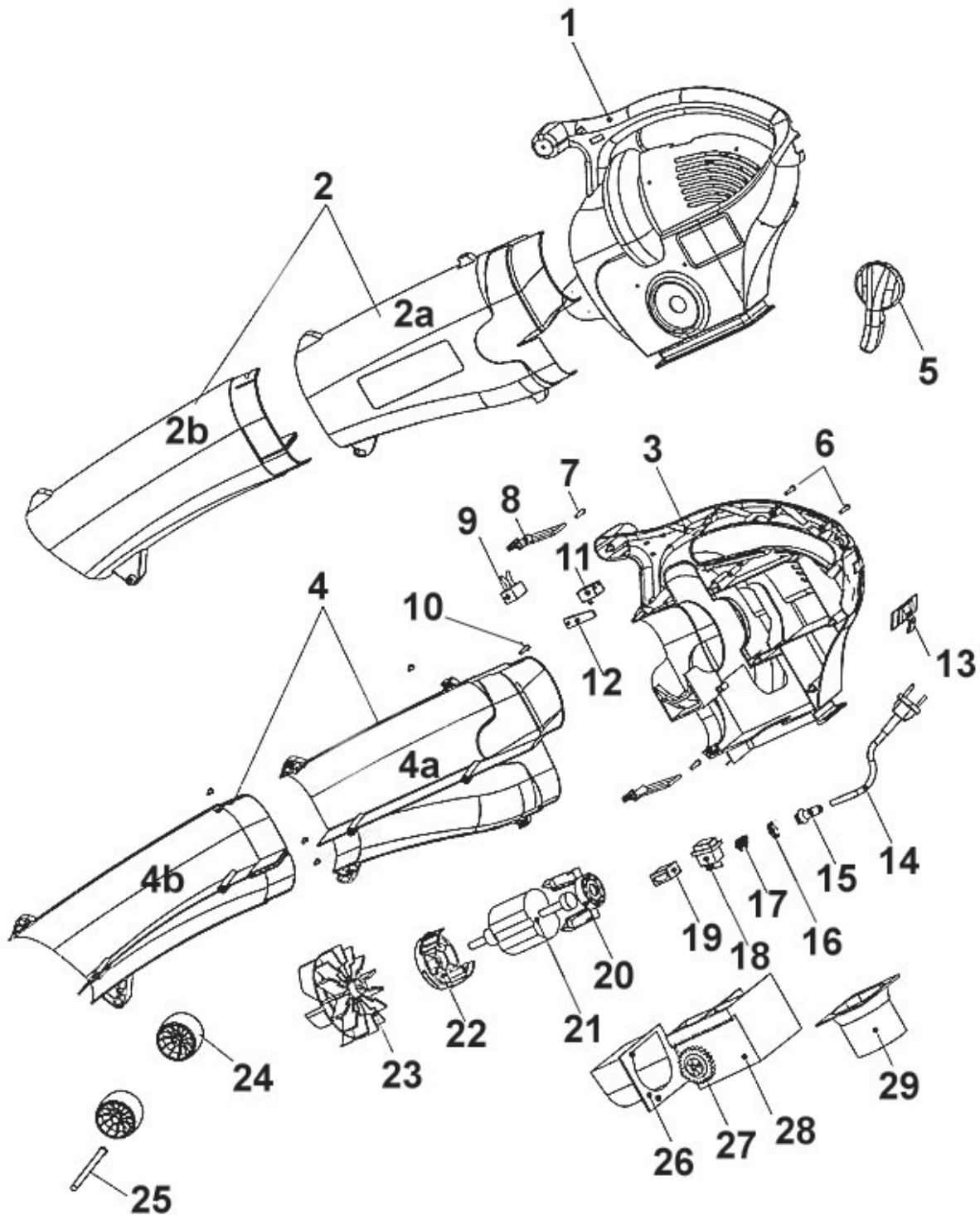

#30 and #31 listed on Parts List, not shown on Assembly Diagram.

NOTE: Some parts are listed and shown for illustration purposes only, and are not available individually as replacement parts.

Free Manuals Download Website

<http://myh66.com>

<http://usermanuals.us>

<http://www.somanuals.com>

<http://www.4manuals.cc>

<http://www.manual-lib.com>

<http://www.404manual.com>

<http://www.luxmanual.com>

<http://aubethermostatmanual.com>

Golf course search by state

<http://golfingnear.com>

Email search by domain

<http://emailbydomain.com>

Auto manuals search

<http://auto.somanuals.com>

TV manuals search

<http://tv.somanuals.com>