

SOLAR CHARGER

Model 65063

SET UP AND OPERATING INSTRUCTIONS



Distributed exclusively by Harbor Freight Tools®.

3491 Mission Oaks Blvd., Camarillo, CA 93011

Visit our website at: <http://www.harborfreight.com>



**Read this material before using this product.
Failure to do so can result in serious injury.
SAVE THIS MANUAL.**

Copyright© 2008 by Harbor Freight Tools®. All rights reserved. No portion of this manual or any artwork contained herein may be reproduced in any shape or form without the express written consent of Harbor Freight Tools. Diagrams within this manual may not be drawn proportionally. Due to continuing improvements, actual product may differ slightly from the product described herein. Tools required for assembly and service may not be included.

For technical questions or replacement parts, please call 1-800-444-3353.

SAVE THIS MANUAL

Keep this manual for the safety warnings and precautions, assembly, operating, inspection, maintenance and cleaning procedures. Write the product's serial number in the back of the manual (or month and year of purchase if product has no number). Keep this manual and the receipt in a safe and dry place for future reference.

IMPORTANT SAFETY INFORMATION

In this manual, on the labeling, and all other information provided with this product:



This is the safety alert symbol. It is used to alert you to potential personal injury hazards. Obey all safety messages that follow this symbol to avoid possible injury or death.

DANGER

DANGER indicates a hazardous situation which, if not avoided, will result in death or serious injury.

WARNING

WARNING indicates a hazardous situation which, if not avoided, could result in death or serious injury.

CAUTION

CAUTION, used with the safety alert symbol, indicates a hazardous situation which, if not avoided, could result in minor or moderate injury.

NOTICE

NOTICE is used to address practices not related to personal injury.

CAUTION

CAUTION, without the safety alert symbol, is used to address practices not related to personal injury.

General Safety Warnings



WARNING Read all safety warnings and instructions. *Failure to follow the warnings and instructions may result in electric shock, fire and/or serious injury. Save all warnings and instructions for future reference.*

1. **Work area safety**
 - a. **Keep work area clean and well lit.** *Cluttered or dark areas invite accidents.*
 - b. **Do not operate this product in explosive atmospheres, such as in the presence of flammable liquids, gases or dust.** *This product can create sparks which may ignite the dust or fumes.*
2. **Electrical safety**
 - a. **The AC/DC Adapter Plug must match the outlet. Never modify the Plug in any way.** *Unmodified plugs and matching outlets will reduce risk of electric shock.*
 - b. **Avoid body contact with grounded surfaces such as pipes, radiators, ranges and refrigerators.** *There is an increased risk of electric shock if your body is grounded.*
 - c. **Do not expose this product to rain or wet conditions.** *Water entering*

this product will increase the risk of electric shock.

- d. Do not abuse the AC/DC Adapter Cord. Never use the Cord for carrying, pulling or unplugging this product. Keep Cord away from heat, oil, sharp edges or moving parts. Damaged or entangled cords increase the risk of electric shock.**
- e. When operating the AC/DC Adapter outdoors, use an extension cord suitable for outdoor use. Use of a cord suitable for outdoor use reduces the risk of electric shock.**
- f. If operating the AC/DC Adapter in a damp location is unavoidable, use a Ground Fault Circuit Interrupter (GFCI) protected supply. Use of a GFCI reduces the risk of electric shock.**

3. Personal safety

- a. Stay alert, watch what you are doing and use common sense when using this product. Do not use this product while you are tired or under the influence of drugs, alcohol or medication. A moment of inattention while operating this product may result in serious personal injury.**
- b. Do not overreach. Keep proper footing and balance at all times. This enables better control of the power tool in unexpected situations.**
- c. Dress properly. Do not wear loose clothing or jewelry. Keep your hair, clothing and gloves away from moving parts. Loose clothes, jewelry or long hair can be caught in moving parts.**

4. Product use and care

- a. Do not force this product. Use the correct product for your application. The correct product will do the job better and safer at the rate for which it was designed.**
- b. Disconnect the AC/DC Adapter Plug from the power source and the Battery from the Solar Charger before making any adjustments, changing accessories, or storing the product.**
- c. Store this product out of the reach of children and do not allow persons unfamiliar with this product or these instructions to operate the unit. Electrically powered products are dangerous in the hands of untrained users.**
- d. Maintain this product. Check for misalignment or binding of moving parts, breakage of parts and any other condition that may affect this product's operation. If damaged, have the unit repaired before use. Many accidents are caused by poorly maintained products.**
- e. Use this product and its accessories in accordance with these instructions, taking into account the working conditions and the work to be performed. Use of this product for operations different from those intended could result in a hazardous situation.**

5. Battery use and care

- a. Recharge only with the AD/DC Adapter specified by the manufacturer. An Adapter that is suitable for one type of Battery may create a risk of fire when used with another Battery.**

- b. **Use this product only with specifically designated batteries.** *Use of any other Battery may create a risk of injury and fire.*
 - c. **Under abusive conditions, liquid may be ejected from the Battery. Avoid contact. If contact accidentally occurs, flush with water. If liquid contacts eyes, additionally seek medical help.** *Liquid ejected from the Battery may cause irritation or burns.*
- 6. Service**
- a. **Have your Solar Charger serviced by a qualified repair person using only identical replacement parts.** *This will ensure that the safety of the product is maintained.*

Specific Safety Warnings

1. Maintain labels and nameplates on the Solar Charger. These carry important safety information. If unreadable or missing, contact Harbor Freight Tools for a replacement.
2. Avoid unintentional starting. Prepare to begin work before turning on the unit.
3. CAUTION: When solar charging, this Charger becomes hot to the touch when fully charged and for a period after it is charged. Use care when handling.
4. Do not leave the AC/DC Adapter unattended when it is plugged into an electrical outlet. Unplug the Adapter from its electrical outlet before leaving.
5. Do not reverse the polarity of the load, the Solar Charger, or the Battery.
6. Clean the surface of the Solar Charger periodically with a clean, soft cloth for best performance. Do not use solvents, acid, or alkali products.
7. For increased pickup of solar energy, it is recommended that the Solar Panel be positioned so that it points directly at the sun.
8. Performance of the Solar Charger may vary depending on site location, angle of the Solar Panel in relation to the arc of the sun, and available sunlight.
9. This product is not a toy. Keep it out of reach of children.
10. People with pacemakers should consult their physician(s) before use. Electromagnetic fields in close proximity to heart pacemaker could cause pacemaker interference or pacemaker failure. In addition, people with pacemakers should:
 - Avoid operating alone.
 - Do not use with power switch locked on.
 - Properly maintain and inspect to avoid electrical shock.
 - Any power cord must be properly grounded. Ground Fault Circuit Interrupter (GFCI) should also be implemented – it prevents sustained electrical shock.
11. WARNING: Handling the AC/DC Adapter Cord on this product will expose you to lead, a chemical known to the State of California to cause cancer, and birth defects or other reproductive harm. Wash hands after

handling. (California Health & Safety Code § 25249.5, et seq.)

12. The warnings, precautions, and instructions discussed in this instruction manual cannot cover all possible conditions and situations that may occur. It must be understood by the operator that common sense and caution are factors which cannot be built into this product, but must be supplied by the operator.



SAVE THESE INSTRUCTIONS.

GROUNDING

WARNING TO PREVENT ELECTRIC SHOCK



AND DEATH FROM INCORRECT GROUNDING WIRE CONNECTION: Check with a qualified electrician if you are in doubt as to whether the outlet is properly grounded. Do not modify the AC/DC Adapter Cord Plug provided with the Solar Charger. Do not use the Solar Charger if the AC/DC Adapter Power Cord or Plug is damaged. If damaged, have it repaired by a service facility before use. If the Plug will not fit the outlet, have a proper outlet installed by a qualified electrician.

Double Insulated Tools: Tools with Two Prong Plugs

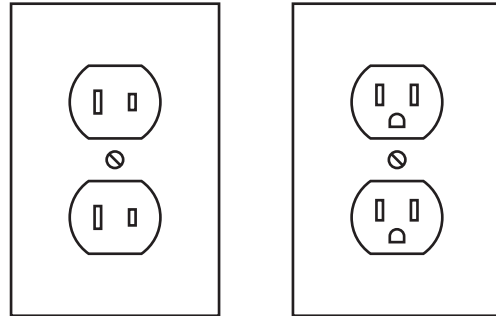

Outlets for 2-Prong Plug

1. Tools marked “Double Insulated” do not require grounding. They have a special double insulation system which satisfies OSHA requirements and complies with the applicable standards of Underwriters Laboratories, Inc., the Canadian Standard Association, and the National Electrical Code. (See **Outlets for 2-Prong Plug.**)
2. Double insulated tools may be used in either of the 120 volt outlets shown in the preceding illustration. (See **Outlets for 2-Prong Plug.**)





Extension Cords

1. **Grounded** tools require a three wire extension cord. **Double Insulated** tools can use either a two or three wire extension cord.
2. As the distance from the supply outlet increases, you must use a heavier gauge extension cord. Using extension cords with inadequately sized wire causes a serious drop in voltage, resulting in loss of power and possible tool damage. (See **Table A.**)

3. The smaller the gauge number of the wire, the greater the capacity of the cord. For example, a 14 gauge cord can carry a higher current than a 16 gauge cord. **(See Table A.)**
4. When using more than one extension cord to make up the total length, make sure each cord contains at least the minimum wire size required. **(See Table A.)**
5. If you are using one extension cord for more than one tool, add the nameplate amperes and use the sum to determine the required minimum cord size. **(See Table A.)**
6. If you are using an extension cord outdoors, make sure it is marked with the suffix "W-A" ("W" in Canada) to indicate it is acceptable for outdoor use.
7. Make sure the extension cord is properly wired and in good electrical condition. Always replace a damaged extension cord or have it repaired by a qualified electrician before using it.

RECOMMENDED MINIMUM WIRE GAUGE FOR EXTENSION CORDS* (110/240 VOLT)					
NAMEPLATE AMPERES (at full load)	EXTENSION CORD LENGTH				
	25'	50'	75'	100'	150'
0 – 2.0	18	18	18	18	16
2.1 – 3.4	18	18	18	16	14
3.5 – 5.0	18	18	16	14	12
5.1 – 7.0	18	16	14	12	12
7.1 – 12.0	18	14	12	10	-
12.1 – 16.0	14	12	10	-	-

SYMBOLOLOGY

	Double Insulated
	Canadian Standards Association
	Underwriters Laboratories, Inc.
	Volts Alternating Current
	Amperes
n ₀ xxxx/min.	No Load Revolutions per Minute (RPM)

PRODUCT SPECIFICATIONS

Product Applications	Designed to charge most cell phones. Also adapts to MP3, M4, PDA's, digital camera, etc.
AC/DC Adapter Input	110 V~ / 60 Hz
AC/DC Adapter Output	5 VDC, 500mA
AC/DC Cord Type	22 AWG
AC/DC Plug Type	2-Prong, Grounded
Lithium Battery Capacity	1000 mAh
Unit Charging Capacity	Approximately 4~6 Hours
Solar Power Output	80 mA/120 mA
Solar Charger Charge Time	4~6 Hours
AC/DC Charge Time	1~2 Hours
Charge Time from Charger to Mobile cell phone	60~90 Minutes
L.E.D. Functions	Red Charging: (Turns to Green on Full Charge). Multi-Flashing: (Indicates DC Power to Charger). Flashlight: (Push Button on Side)
Accessories	Plug Adapters (Qty. 5)

UNPACKING

When unpacking, check to make sure that the item is intact and undamaged. If any parts are missing or broken, please call Harbor Freight Tools at the number shown on the cover of this manual as soon as possible.

OPERATING INSTRUCTIONS



Read the **ENTIRE IMPORTANT SAFETY INFORMATION** section at the beginning of this manual including all text under subheadings therein before set up or use of this product.

Product Features

1. Electric current input Lamp.
2. Electric current output Lamp.
3. Flashlight Lamp.
4. Circuit Reset.
5. Flashlight Switch Button.
6. Electric current input receptacle.
7. Electric current output receptacle.
8. Solar Panel.
9. Plug Adapters
10. Connection Cord
11. AC/DC Adapter
12. Lithium Battery (not shown)

(See Figure A.)

FIGURE A

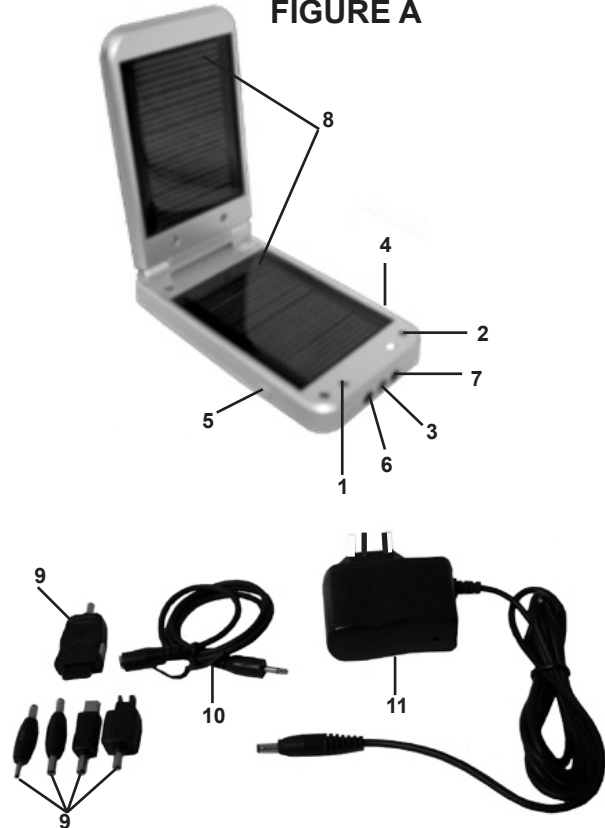

General Operating Procedures



WARNING TO PREVENT SERIOUS INJURY FROM ACCIDENTAL OPERATION:
Unplug the Solar Charger from its AC/DC Adapter before performing any inspection, maintenance, or cleaning procedures.

To Charge The Solar Charger Battery Using The AC/DC Adapter:

1. The approximate charge time, using the AC/DC Adapter (11) is **1 to 2 hours**.

2. To charge the Battery (12) of the Solar Charger, insert the Plug of the AC/DC Adapter (11) into the Electric Current Input Receptacle (6). **(See Figure A.)**
 3. Plug the Power Cord of the AC/DC Adapter (11) into the nearest 110 volt, grounded, electrical outlet. **(See Figure A.)**
 4. The Electric Current Input Lamp (1) will illuminate **RED**. In approximately 60 to 90 minutes, the Lamp will illuminate **GREEN** indicating the Solar Charger is fully charged. **Do not overcharge. (See Figure A.)**
 5. When fully charged, unplug the AC/DC Adapter (11) from its electrical outlet. Then unplug the Plug of the AC/DC Adapter from the Solar Charger's Electric Current Input Receptacle (6). **(See Figure A.)**
- angle of the Solar Panel in relation to the arc of the sun, and available sunlight.
 5. The Electric Current Input Lamp (1) will illuminate **RED**. In approximately 4 to 6 hours, the Lamp will illuminate **GREEN** indicating the Solar Charger is fully charged. **Do not overcharge. (See Figure A.)**
 6. When fully charged, close the Solar Charger to keep the Solar Panel (8) free of dirt and debris. **(See Figure A.)**

To Test The Circuit:

1. To make sure the Solar Charger is operating properly, press the Flashlight Switch Button (5) to see if the LED illuminates. If it illuminates, the circuit of the Solar Charger is operating properly. If the LED *does not* illuminate, press the Circuit Reset (4). This will reset the Solar Charger to begin charging. **(See Figure A.)**

To Charge The Solar Charger Battery Using Solar Power:

1. The approximate charge time, using solar power is **4 to 6 hours**.
2. To charge the Battery (12) of the Solar Charger, open the Solar Charger to expose the Solar Panel (8). Then set the Solar Charger on a clean, dry location in full sunlight. **(See Figure A.)**
3. For increased pickup of solar energy, and to minimize the collection of debris on the Solar Panel (8), it is recommended that the Solar Panel be positioned so that it points directly at the sun. **(See Figure A.)**
4. Performance of the Solar Charger may vary depending on site location,

To Charge A Mobile Unit:

1. Select the proper Plug Adapter (9) for the mobile unit you wish to charge. **(See Figure A.)**
2. Attach the Plug Adapter (9) to the Connection Cord (10). **(See Figure A.)**
3. Insert the Plug Adapter (9) into the charging *input* receptacle of the mobile unit. **(See Figure A.)**
4. Insert the other end of the Connection Cord (10) into the Solar Charger's Electric Current Output Receptacle (7). **(See Figure A.)**

5. The Solar Charger will immediately begin charging the mobil unit, as indicated by the Electric Current Output Lamp (2) illuminating.
(See Figure A.)
6. **IMPORTANT:** Refer to the mobile unit manufacturer's recommended charge time for the unit. **Do not overcharge. Overcharging may damage the mobile unit.**
7. When finished charging the mobil unit, unplug the Solar Charger's Plug Adapter (9) from the mobil unit.
(See Figure A.)
8. Disconnect the Plug Adapter (9) from its Connection Cord (10). Then disconnect the Connection Cord from the Solar Charger's Electric Current Output Receptacle (7).
(See Figure A.)

TO PREVENT SERIOUS INJURY FROM PRODUCT FAILURE:

Do not use damaged equipment. If abnormal noise or vibration occurs, have the problem corrected before further use.

Inspection, Maintenance, and Cleaning

1. **BEFORE EACH USE**, inspect the general condition of the Solar Charger and its accessories. Check for loose screws, misalignment or binding of moving parts, cracked or broken parts, damaged electrical wiring, and any other condition that may affect its safe operation.
2. **TO CHANGE THE LITHIUM BATTERY:** Poor product performance may be a sign the Lithium Battery (12) is worn out. It is recommended that a qualified technician replace the battery.
(See Figure B, next page.)
3. **AFTER USE**, clean the surface of the Solar Charger periodically with a clean, damp, soft cloth for best performance. Do not use solvents, acid, or alkali products.
4. **WARNING!** If the Power Cord of the AC/DC Adapter is damaged, it must be replaced only by a qualified service technician.

MAINTENANCE AND SERVICING



Procedures not specifically explained in this manual must be performed only by a qualified technician.

⚠️ WARNING

TO PREVENT SERIOUS INJURY

**FROM ACCIDENTAL OPERATION:
Unplug the AC/DC Adapter from its electrical outlet before performing any inspection, maintenance, or cleaning procedures.**

PLEASE READ THE FOLLOWING CAREFULLY

THE MANUFACTURER AND/OR DISTRIBUTOR HAS PROVIDED THE PARTS LIST AND ASSEMBLY DIAGRAM IN THIS MANUAL AS A REFERENCE TOOL ONLY. NEITHER THE MANUFACTURER OR DISTRIBUTOR MAKES ANY REPRESENTATION OR WARRANTY OF ANY KIND TO THE BUYER THAT HE OR SHE IS QUALIFIED TO MAKE ANY REPAIRS TO THE PRODUCT, OR THAT HE OR SHE IS QUALIFIED TO REPLACE ANY PARTS OF THE PRODUCT. IN FACT, THE MANUFACTURER AND/OR DISTRIBUTOR EXPRESSLY STATES THAT ALL REPAIRS AND PARTS REPLACEMENTS SHOULD BE UNDERTAKEN BY CERTIFIED AND LICENSED TECHNICIANS, AND NOT BY THE BUYER. THE BUYER ASSUMES ALL RISK AND LIABILITY ARISING OUT OF HIS OR HER REPAIRS TO THE ORIGINAL PRODUCT OR REPLACEMENT PARTS THERETO, OR ARISING OUT OF HIS OR HER INSTALLATION OF REPLACEMENT PARTS THERETO.

TROUBLESHOOTING		
Problem	Possible Causes	Possible Solutions
Battery will not charge.	<ol style="list-style-type: none"> 1. No AC power at outlet. 2. AC/DC cord and/or plug not connected. 3. Insufficient sunlight. 4. Solar panel dirty. 	<ol style="list-style-type: none"> 1. Check AC power at outlet. 2. Check that AC/DC cord and/or plug is plugged in. 3. Check that Solar Panel is in full sunlight. 4. Check that Solar Panel is clean and dry.
Solar Charger not charging mobil unit.	<ol style="list-style-type: none"> 1. Connection cord not properly plugged in to Solar Charger and/or mobil unit. 2. Circuit interruption. 3. Using wrong Plug adapter. 4. Solar Charger not designed to charge a specific mobil unit. 5. Solar Charger battery low. 	<ol style="list-style-type: none"> 1. Check that connection cord is properly connected to Solar Charger and mobil unit. 2. Press Circuit Reset. Then resume charging. 3. Check that proper plug adapter is being used. 4. Requires correct plug adapter. 5. Charge Solar Charger battery.
<div style="display: flex; align-items: center;"> <p>Follow all safety precautions whenever diagnosing or servicing the tool. Disconnect power supply before service.</p> </div>		

PARTS LIST & ASSEMBLY DIAGRAM

Part #	Description	Qty.
1	Input Indicator LED	1
2	Output Indicator LED	1
3	Flashlight Lamp	1
4	Circuit Reset	1
5	Flashlight Switch Button	1
6	AC/DC Adapter Input	1
7	DC Current Output	1
8	Solar Panel	2
9	Plug Adapter	5
10	Connection Cord	1
11	AC/DC Adapter	1
12	Lithium Battery (not shown)	1

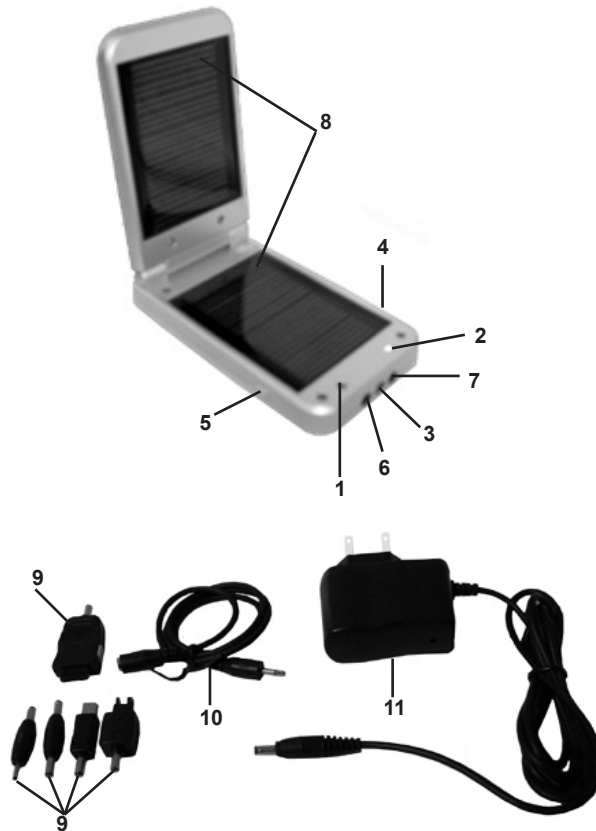

Record Product's Serial Number Here: _____

Note: If product has no serial number, record month and year of purchase instead.

Note: Some parts are listed and shown for illustration purposes only, and are not available individually as replacement parts.

Free Manuals Download Website

<http://myh66.com>

<http://usermanuals.us>

<http://www.somanuals.com>

<http://www.4manuals.cc>

<http://www.manual-lib.com>

<http://www.404manual.com>

<http://www.luxmanual.com>

<http://aubethermostatmanual.com>

Golf course search by state

<http://golfingnear.com>

Email search by domain

<http://emailbydomain.com>

Auto manuals search

<http://auto.somanuals.com>

TV manuals search

<http://tv.somanuals.com>