

# CENTRAL PNEUMATIC®

## COMPRESSOR AND AIR BRUSH KIT

**Model 95630**

### SET UP AND OPERATING INSTRUCTIONS



Visit our website at: <http://www.harborfreight.com>



**Read and understand tool labels and manual. Failure to follow warnings could result in DEATH or SERIOUS INJURY. SAVE THIS MANUAL.**

Copyright© 2010 by Harbor Freight Tools®. All rights reserved. No portion of this manual or any artwork contained herein may be reproduced in any shape or form without the express written consent of Harbor Freight Tools. Diagrams within this manual may not be drawn proportionally. Due to continuing improvements, actual product may differ slightly from the product described herein. Tools required for assembly and service may not be included.

**For technical questions or replacement parts, please call 1-800-444-3353.**

## SAVE THIS MANUAL

Keep this manual for the safety warnings and precautions, assembly, operating, inspection, maintenance and cleaning procedures. Write the product's serial number in the back of the manual near the assembly diagram (or month and year of purchase if product has no number). Keep this manual and the receipt in a safe and dry place for future reference.

### Safety Alert Symbol and Signal Words

In this manual, on the labeling, and all other information provided with this product:



This is the safety alert symbol. It is used to alert you to potential personal injury hazards. Obey all safety messages that follow this symbol to avoid possible injury or death.

#### **DANGER**

**DANGER** indicates a hazardous situation which, if not avoided, will result in death or serious injury.

#### **WARNING**

**WARNING** indicates a hazardous situation which, if not avoided, could result in death or serious injury.

#### **CAUTION**

**CAUTION**, used with the safety alert symbol, indicates a hazardous situation which, if not avoided, could result in minor or moderate injury.





#### **NOTICE**

**NOTICE** is used to address practices not related to personal injury.

## CAUTION

**CAUTION**, without the safety alert symbol, is used to address practices not related to personal injury.

### Symbol Definitions

Symbol	Property or statement
<b>PSI</b>	Pounds per square inch of pressure
<b>CFM</b>	Cubic Feet per Minute flow
<b>SCFM</b>	Cubic Feet per Minute flow at standard conditions
<b>NPT</b>	National pipe thread, tapered
<b>NPS</b>	National pipe thread, straight
	WARNING marking concerning Risk of Eye Injury. Wear ANSI-approved safety goggles with side shields.
	Read the manual before set-up and/or use.
	WARNING marking concerning Risk of Hearing Loss. Wear hearing protection.
	WARNING marking concerning Risk of Respiratory Injury. Wear NIOSH-approved dust mask/respirator.
	WARNING marking concerning Risk of Explosion.

### Important Safety Instructions

## INSTRUCTIONS PERTAINING TO A RISK OF FIRE, ELECTRIC SHOCK, OR INJURY TO PERSONS

**WARNING** – When using tools, basic precautions should always be followed, including the following:

## General

- a. **To reduce the risks of electric shock, fire, and injury to persons, read all the instructions before using the tool.**

## Work area

- a. **Keep the work area clean and well lighted.** Cluttered benches and dark areas increase the risks of electric shock, fire, and injury to persons.
- b. **Do not operate the tool in explosive atmospheres, such as in the presence of flammable liquids, gases, or dust.** The tool is able to create sparks resulting in the ignition of the dust or fumes.
- c. **Keep bystanders, children, and visitors away while operating the tool.** Distractions are able to result in the loss of control of the tool.

## Electrical Safety

- a. **Power tool plugs must match the outlet. Never modify the plug in any way. Do not use any adapter plugs with grounded power tools.** Unmodified plugs and matching outlets will reduce risk of electric shock.
- b. **Avoid body contact with grounded surfaces such as pipes, radiators, ranges and refrigerators.** There is an increased risk of electric shock if your body is grounded.
- c. **Do not expose power tools to rain or wet conditions.** Water entering a power tool will increase the risk of electric shock.
- d. **Do not abuse the cord. Never use the cord for carrying, pulling or unplugging the power tool. Keep cord away from heat, oil, sharp edges or**

**moving parts.** Damaged or entangled cords increase the risk of electric shock.

- e. **When operating a power tool outdoors, use an extension cord suitable for outdoor use.** Use of a cord suitable for outdoor use reduces the risk of electric shock.
- f. **If operating a power tool in a damp location is unavoidable, use a Ground Fault Circuit Interrupter (GFCI) protected supply.** Use of a GFCI reduces the risk of electric shock.

## Personal safety

- a. **Stay alert. Watch what you are doing and use common sense when operating the tool. Do not use the tool while tired or under the influence of drugs, alcohol, or medication.** A moment of inattention while operating the tool increases the risk of injury to persons.
- b. **Dress properly. Do not wear loose clothing or jewelry. Contain long hair. Keep hair, clothing, and gloves away from moving parts.** Loose clothes, jewelry, or long hair increases the risk of injury to persons as a result of being caught in moving parts.
- c. **Avoid unintentional starting. Be sure the Power Switch is off before connecting to the air supply.** Do not carry the tool with your finger on the Power Switch or connect the tool to the air supply with the trigger pressed.
- d. **Do not overreach. Keep proper footing and balance at all times.** Proper footing and balance enables better control of the tool in unexpected situations.

- e.  **Use safety equipment.** A dust mask, non-skid safety shoes and a hard hat must be used for the applicable conditions. Wear heavy-duty work gloves during use.

- f.  **Always wear eye protection.** Wear ANSI-approved safety goggles with side shields.

- g.  **Always wear hearing protection when using the tool.** Prolonged exposure to high intensity noise is able to cause hearing loss.

### Tool use and care

- a. **Use clamps or another practical way to secure and support the workpiece to a stable platform.** Holding the work by hand or against the body is unstable and can lead to loss of control.
- b. **Do not force the tool.** Use the correct tool for the application. The correct tool will do the job better and safer at the rate for which the tool is designed.
- c. **Do not use the tool if the Power Switch does not turn the tool on or off.** Any tool that cannot be controlled with the Power Switch is dangerous and must not be used until repaired.
- d. **Disconnect the tool from the air source before making adjustments, doing tool maintenance, clearing jams, touching the safety nosepiece, leaving work area, loading, or unloading the tool.** Such precautionary measures reduce the risk of injury to persons.
- e. **Store the tool when it is idle out of reach of children and other untrained**

**persons.** A tool is dangerous in the hands of untrained users.

- f. **Maintain the tool with care.** A properly maintained tool reduces the risk of binding and is easier to control.
- g. **Check for misalignment or binding of moving parts, breakage of parts, and any other condition that affects the tool's operation.** If damaged, have the tool serviced before using. Many accidents are caused by poorly maintained tools. There is a risk of bursting if the tool is damaged.
- h. **Use only accessories that are identified by the manufacturer for the specific tool model.** Use of an accessory not intended for use with the specific tool model, increases the risk of injury to persons.

### Service

- a. **Tool service must be performed only by qualified repair personnel.**
- b. **When servicing a tool, use only identical replacement parts. Use only authorized parts.**



**SAVE THESE INSTRUCTIONS.**

## Specific Safety Instructions

- Maintain labels and nameplates on the tool.** These carry important information. If unreadable or missing, contact Harbor Freight Tools for a replacement.
- DANGER!** This Air Compressor is NOT equipped and should not be used “as is” to supply breathing quality air. For any application of air for human consumption, you must fit the Air Compressor with suitable in-line safety and alarm equipment (not included). This additional equipment is necessary to properly filter and purify the air to meet minimal specifications for Grade D breathing as described in Compressed Gas Association Commodity Specification G 7.1-1966, OSHA 29 CFR 1910. 134, and/or Canadian Standards Associations (CSA).
- Make sure all tools and equipment used with the Air Compressor are rated to the appropriate capacity.** Do not use any tool or equipment that operates above 58 PSI.
- Drain the Air Compressor everyday.** Do not allow excessive moisture to build up inside the Air Compressor. Do not open the Water Drain Valve (23) with more than 10 PSI of air pressure in the Compressor.
- Avoid injury.** Do not direct compressed air at people or animals. Do not direct airflow at eyes or ears.
- Make sure the Air Compressor is located on a flat, level, sturdy surface capable of supporting the weight of the Compressor and any additional tools and equipment.**
- Industrial applications must follow OSHA guidelines.**
- Do not stand or sit on the Air Compressor.** Serious injury could result if the Compressor is tipped.
- Do not leave the Air Compressor unattended when it is plugged in.** Turn off the Compressor and unplug before leaving.
- Do not move or transport the Air Compressor if the unit is under pressure.**
- Do not force the Air Compressor.** This tool will do the work better and safer at the speed and capacity for which it was designed.
- This Air Compressor will automatically shut off on overload or under excessive heat.** Should this occur, turn the Power Switch (34) to its “OFF” position. Wait until the Air Compressor cools. Then turn the Power Switch (34) to its “ON” position to resume work.
- Spray painting only.** Do not use this Air Compressor with gasoline, kerosene, or any other flammable solvent.
- Maintain a safe working environment. Make sure there is adequate surrounding workspace.** Do not use this product in a damp or wet location.
- People with pacemakers should consult their physician(s) before using this product.** Electromagnetic fields in close proximity to a heart pacemaker could cause interference to or failure of the pacemaker. In addition, people with pacemakers should adhere to the following:
  - Avoid operating power tools alone.
  - Don't use a power tool with the power switch locked on.
  - If powered via a power cord be certain that the tool is properly grounded. A

ground fault interrupt (GFCI) system is also a good precaution. This inexpensive device is a good safety measure because it prevents a sustained electrical shock.

- Properly maintain and inspect all tools before use to avoid electrical shock

16. **Never leave the tool unattended when it is plugged into an electrical outlet.** Turn off the tool, and unplug it from its electrical outlet before leaving.

17. **WARNING: The brass components of this product contain lead, a chemical known to the State of California to cause birth defects (or other reproductive harm).** (California Health & Safety code § 25249.5, et seq.)

18. **WARNING: Some dust created by power sanding, sawing, grinding, drilling, and other construction activities, contains chemicals known [to the State of California] to cause cancer, birth defects or other reproductive harm.** Some examples of these chemicals are:  
Lead from lead-based paints  
Crystalline silica from bricks and cement or other masonry products  
Arsenic and chromium from chemically treated lumber  
Your risk from these exposures varies, depending on how often you do this type of work. To reduce your exposure to these chemicals: work in a well ventilated area, and work with approved safety equipment, such as those dust masks that are specially designed to filter out microscopic particles. (California Health & Safety Code § 25249.5, et seq.)

19. **Always maintain adequate ventilation, especially when using solvent based paints and during clean up.**



## SAVE THESE INSTRUCTIONS.

### Grounding

#### ! WARNING



**TO PREVENT ELECTRIC SHOCK AND DEATH FROM**

#### INCORRECT GROUNDING WIRE CONNECTION:

Check with a qualified electrician if you are in doubt as to whether the outlet is properly grounded. Do not modify the power cord plug provided with the tool. Never remove the grounding prong from the plug. Do not use the tool if the power cord or plug is damaged. If damaged, have it repaired by a service facility before use. If the plug will not fit the outlet, have a proper outlet installed by a qualified electrician.

### Grounded Tools: Tools with Three Prong Plugs

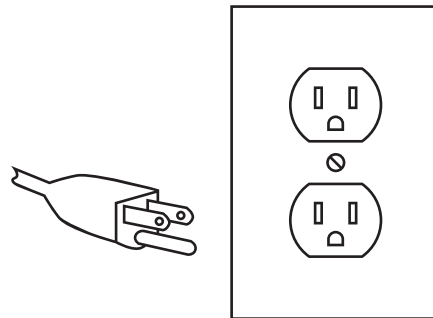

**3-Prong Plug and Outlet**

1. Tools marked with "Grounding Required" have a three wire cord and three prong grounding plug. The plug must be connected to a properly grounded outlet.

If the tool should electrically malfunction or break down, grounding provides a low resistance path to carry electricity away from the user, reducing the risk of electric shock. **(See 3-Prong Plug and Outlet.)**

2. The grounding prong in the plug is connected through the green wire inside the cord to the grounding system in the tool. The green wire in the cord must be the only wire connected to the tool's grounding system and must never be attached to an electrically "live" terminal. **(See 3-Prong Plug and Outlet.)**
3. The tool must be plugged into an appropriate outlet, properly installed and grounded in accordance with all codes and ordinances. The plug and outlet should look like those in the preceding illustration. **(See 3-Prong Plug and Outlet.)**

## Double Insulated Tools: Tools with Two Prong Plugs

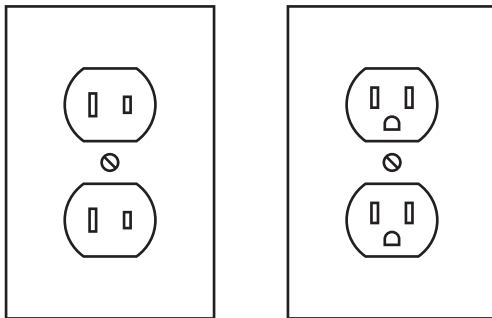

**Outlets for 2-Prong Plug**

1. Tools marked "Double Insulated" do not require grounding. They have a special double insulation system which satisfies OSHA requirements and complies with the applicable standards of Underwriters Laboratories, Inc., the Canadian Standard Association, and the National Electrical Code.

2. Double insulated tools may be used in either of the 120 volt outlets shown in the preceding illustration. **(See Outlets for 2-Prong Plug.)**











## Extension Cords

1. **Grounded** tools require a three wire extension cord. **Double Insulated** tools can use either a two or three wire extension cord.
2. As the distance from the supply outlet increases, you must use a heavier gauge extension cord. Using extension cords with inadequately sized wire causes a serious drop in voltage, resulting in loss of power and possible tool damage. **(See Table A on page <?>.)**
3. If you are using an extension cord outdoors, make sure it is marked with the suffix "W-A" ("W" in Canada) to indicate it is acceptable for outdoor use.
4. Protect the extension cords from sharp objects, excessive heat, and damp or wet areas

TABLE A: RECOMMENDED MINIMUM WIRE GAUGE FOR EXTENSION CORDS* (120/240 VOLT)					
NAMEPLATE AMPERES (at full load)	EXTENSION CORD LENGTH				
	25'	50'	75'	100'	150'
0 – 2.0	18	18	18	18	16
2.1 – 3.4	18	18	18	16	14
3.5 – 5.0	18	18	16	14	12
5.1 – 7.0	18	16	14	12	12
7.1 – 12.0	18	14	12	10	-
12.1 – 16.0	14	12	10	-	-
16.1 – 20.0	12	10	-	-	-

\* Based on limiting the line voltage drop to five volts at 150% of the rated amperes.

## Symbology

	Double Insulated
	Canadian Standards Association
	Underwriters Laboratories, Inc.
	Volts Alternating Current
	Amperes
n <sub>0</sub> xxxx/min.	No Load Revolutions per Minute (RPM)
	WARNING marking concerning Risk of Eye Injury. Wear ANSI-approved safety goggles with side shields.
	Read the manual before set-up and/or use.
	WARNING marking concerning Risk of Hearing Loss. Wear hearing protection.
	WARNING marking concerning Risk of Fire. Do not cover ventilation ducts. Keep flammable objects away.
	WARNING marking concerning Risk of Electric Shock. Properly connect power cord to appropriate outlet.

## Functional Description

### Compressor Specifications

Type	Single cylinder, oilless piston
Power	1/5 HP
Voltage	120, 60HZ, 1.18 AMP
Thermo-Overload shutoff protection	Auto shutoff
Air output	0 - 58 PSI
Air outlet size	1/8 - 27 NPT male threads
Motor RPM	1750
Pressure Gauge	0-100 PSI
Cord length	6'-2 1/2"L

### Air Brush Specifications

Working Air Pressure	0.5 CFM @ 20 PSI
Air Hose length	Approx. 5FT
Housing	Anodized Aluminum
Accessories	22cc Glass jar assembly
	5cc Metal cup
	Metal Hanger

## INITIAL ASSEMBLY



Read the **ENTIRE IMPORTANT SAFETY INFORMATION** section at the beginning of this manual including all text under subheadings therein before set up or use of this product.

**Note:** For additional information regarding parts listed in following pages, refer to Assembly Diagrams near end of manual.

### Unpacking

When unpacking, make sure that the item is intact and undamaged. If any parts are missing or broken, please call Harbor Freight Tools at 1-800-444-3353 as soon as possible.



## Initial Tool Setup/Assembly

### **WARNING** Read the **ENTIRE IMPORTANT SAFETY**

**INFORMATION** section at the beginning of this manual including all text under subheadings therein before set up or use of this product.

**Inspect tool before use, looking for damaged, loose, and missing parts. If any problems are found, do not use tool until repaired.**

1. Connect one end of the air hose to the Air Outlet (38).
2. Connect other end of air hose to the Air Brush (27).
3. Inspect the air connections for leaks. Repair any leaks found.

## Operating Instructions



Read the **ENTIRE IMPORTANT SAFETY INFORMATION** section at the beginning of this manual including all text under subheadings therein before set up or use of this product.

**Inspect tool before use, looking for damaged, loose, and missing parts. If any problems are found, do not use tool until repaired.**

### Work Piece and Work Area Set Up

1. Designate a work area that is clean and well-lit. The work area must not allow access by children or pets to prevent distraction and injury.
2. Route the air hose along a safe route to reach the work area without creating a

tripping hazard or exposing the air hose to possible damage. The air hose must be long enough to reach the work area with enough extra length to allow free movement while working.

3. Secure loose workpieces using a vise or clamps (not included) to prevent movement while working.
4. There must not be hazardous objects (utility lines or foreign objects) nearby that present a hazard while working.

### General Operating Instructions

1. Choose a 120V power supply and plug in Air Compressor.
2. Set the Pressure Gauge to desired air pressure (maximum 58 PSI).
3. Fill the 22cc Glass Jar (31A) after thinning your paint properly.

#### **NOTE: Use the proper solvent for thinning.**

Use lacquer thinner for all lacquers, paint thinner for oil based paints, and water for all latex based paints.

4. **Hold** the Air Brush Housing (8A) lightly in your hand and push the tapered fitting on the lid of the 22cc Glass Jar Assembly (31A) into the base of the Air Brush Housing (8A). It is held in place with friction and not threading.
5. **Turn** on the Power Switch (34) and the Air Compressor will start and work continuously until it reaches its maximum preset pressure which will be approximately 55 PSI at which time it will automatically shut down. It will re-start when the pressure drops to approximately 42 PSI.
6. By pressing the Finger Lever (10A) air will emerge from the Nozzle (3A). Draw back slowly/gently on the Finger

Lever (10A)) and the fluid will atomize. Continue to move the Finger Lever (10A) to achieve the air volume you need for your spray technique.

7. Continue to adjust the spray volume by using the Finger Lever (10A), moving it front to back. When you have the correct spray volume, you may fix the position using the Adjustment Screw (9A).
8. The size of the spray pattern will be in accordance with the distance between the work surface and the Nozzle (3A) of the Air Brush. For extra-fine spray, remove the Protective Cap (1A) and hold the Air Brush nearer the work surface.
9. When you are finished painting, gently release pressure on Finger Lever (10A).

**NOTE:** If while using this Air Brush and fluid blocks the Nozzle (3A) from working, move Needle Chucking Guide (13A) back and forth. If this does not clear the Nozzle (3A), try loosening the Needle Adjustment Screw (9A). This will allow a longer movement for the Needle (18A) and allow the blocked fluid to escape clearing the Nozzle (3A).

10. After flushing the Air Brush unit completely with the proper solvent: Lacquer thinner if you used a lacquer paint, water if you used a latex based paint and paint thinner for all oil based enamels, spray remaining solvent through the Nozzle (3A) until clear solvent sprays from end of Airbrush tip.

**NOTE:** ALL paints used with this Air Brush are fast drying by design and can seriously damage your tool if they are NOT flushed immediately.

11. Bleed excess air from hose and drain water out of the Water Drain Valve (23) on the Air Compressor only after turning

OFF Power Switch (34) and unplugging the Compressor from the 120 V power supply, or from your extension cord.

**NOTE:** The 5cc Metal Cup (28A) has two uses. It is used for excess thinned paint, and also for solvent when it is time to clean the Air Brush.

**NOTE:** The Metal Hook (30A) can be attached to a solid surface and used to hang Air Brush when it is not being used.

## User-Maintenance Instructions



**Procedures not specifically explained in this manual must be performed only by a qualified technician.**



**WARNING TO PREVENT SERIOUS INJURY FROM ACCIDENTAL OPERATION, make sure Power Switch of tool is in its "Off" position and that the tool is unplugged from its electrical outlet before any maintenance or repairs are done.**

**Note:** These procedures are in addition to the regular checks and maintenance explained as part of the regular operation of the air-operated tool.

1. **BEFORE EACH USE**, inspect the general condition of the tool. Check for loose screws, misalignment or binding of moving parts, cracked or broken parts, damaged electrical wiring, and any other condition that may affect its safe operation. If abnormal noise or vibration occurs, have the problem corrected before further use. **Do not use damaged equipment.**
2. **AFTER EACH USE**, wipe off with a clean, moist cloth. Also completely flush,

clean and wipe down Airbrush and all that were used during operation.

Ring and Inlet and Outlet Valves. **Please note:** This work should only be done by a qualified service technician.

3. **AFTER EVERY 500 HOURS OF REGULAR USE**, replace Compression

### Troubleshooting

Problem	Possible Causes	Likely Solutions
Air Compressor will not start.	<ol style="list-style-type: none"> <li>1. No power at outlet.</li> <li>2. Cord not connected.</li> </ol>	<ol style="list-style-type: none"> <li>1. Check power at outlet.</li> <li>2. Check that cord is plugged in.</li> </ol>
Pressure is low causing a weak spray at Nozzle of Air Brush.	<ol style="list-style-type: none"> <li>1. Air connection is leaking.</li> <li>2. Air Hose is broken.</li> <li>3. Screws on cylinder cover is loose.</li> </ol>	<ol style="list-style-type: none"> <li>1. Seal air connection with plumbers tape, (only for non-flammable type connections).</li> <li>2. Replace air connection if necessary.</li> <li>3. Tighten Cylinder Cover screws.</li> </ol>
Poor atomization when using Air Brush.	<ol style="list-style-type: none"> <li>1. The air connection is leaking.</li> <li>2. Paint viscosity is too thick.</li> <li>3. The Air Brush nozzle is plugged or dirty.</li> </ol>	<ol style="list-style-type: none"> <li>1. Make sure all air connections are "air-tight".</li> <li>2. Add correct solvent for type of paint you are using and mix thoroughly.</li> <li>3. Wash the Air Brush nozzle or change it if necessary.</li> </ol>
Air Compressor is running well but no air pressure is being delivered to Air Brush.	<ol style="list-style-type: none"> <li>1. Valve plate is unscrewed or out of place.</li> <li>2. Retainer ring is destroyed by continued use.</li> </ol>	<ol style="list-style-type: none"> <li>1. Open the front cover and tighten all screws while making sure the valve plate is in the correct position.</li> <li>2. Replace the retainer ring if necessary.</li> </ol>
The Compressor motor does not work.	<ol style="list-style-type: none"> <li>1. Electric cord is broken.</li> <li>2. Connections inside the compressor are defective.</li> <li>3. The on - off switch is defective.</li> </ol>	<ol style="list-style-type: none"> <li>1. Check the electric cord and replace it if necessary.</li> <li>2. Open the rear plate and check the connections. Repair them if necessary.</li> <li>3. Check the operation of the on - off switch and replace if necessary.</li> </ol>
Compressor motor makes a sound, but does not run.	<ol style="list-style-type: none"> <li>1. Exhaust outlet is totally blocked.</li> <li>2. Cylinder valve is incorrectly fitted. Possibly it is mounted in the wrong direction.</li> </ol>	<ol style="list-style-type: none"> <li>1. Open the outlet cap and unblock the exhaust.</li> <li>2. Re-assemble making sure the cylinder valve is correctly fitted.</li> </ol>
The Compressor motor runs but is making irregular or knocking noise.	Bearing is loose or damaged.	Replace the bearing if necessary.



**Follow all safety precautions whenever diagnosing or servicing the tool. Disconnect air supply before service.**

### PLEASE READ THE FOLLOWING CAREFULLY

THE MANUFACTURER AND/OR DISTRIBUTOR HAS PROVIDED THE PARTS LIST AND ASSEMBLY DIAGRAM IN THIS MANUAL AS A REFERENCE TOOL ONLY. NEITHER THE MANUFACTURER OR DISTRIBUTOR MAKES ANY REPRESENTATION OR WARRANTY OF ANY KIND TO THE BUYER THAT HE OR SHE IS QUALIFIED TO MAKE ANY REPAIRS TO THE PRODUCT, OR THAT HE OR SHE IS QUALIFIED TO REPLACE ANY PARTS OF THE PRODUCT. IN FACT, THE MANUFACTURER AND/OR DISTRIBUTOR EXPRESSLY STATES THAT ALL REPAIRS AND PARTS REPLACEMENTS SHOULD BE UNDERTAKEN BY CERTIFIED AND LICENSED TECHNICIANS, AND NOT BY THE BUYER. THE BUYER ASSUMES ALL RISK AND LIABILITY ARISING OUT OF HIS OR HER REPAIRS TO THE ORIGINAL PRODUCT OR REPLACEMENT PARTS THERETO, OR ARISING OUT OF HIS OR HER INSTALLATION OF REPLACEMENT PARTS THERETO.

## Compressor Parts List and Assembly Diagram

Part	Description	Qty	Part	Description	Qty
1	Screw	8	22	Front Cover	1
2	Rear cover	1	23	Water Drain Valve	1
4	Rear Body	1	24	O-Ring	1
5	Screw	4	25	Cylinder Block	1
6	Stationary Motor	1	26	O-Ring	1
7	Bearing	2	27	Cylinder Head	1
8	Rotary Motor	1	28	Cap Screw	4
9	Front Body	1	29	Filter	1
10	Counterweight	1	30	Handle	1
11	Manometer	1	31	Pressure Switch	1
12	Bearing	1	32	Pressure Regulator	1
13	Retainer Ring	1	33	Condenser	1
14	Compression Ring	1	34	Power Switch	1
17	Cylinder	1	35	Wire	1
18	Valve Plate	1	36	Rubber Pad	4
19	Valve	2	37	Locknut	1
20	Screw	1	38	Air Outlet	2
21	Front Gasket	1	39	Link	1

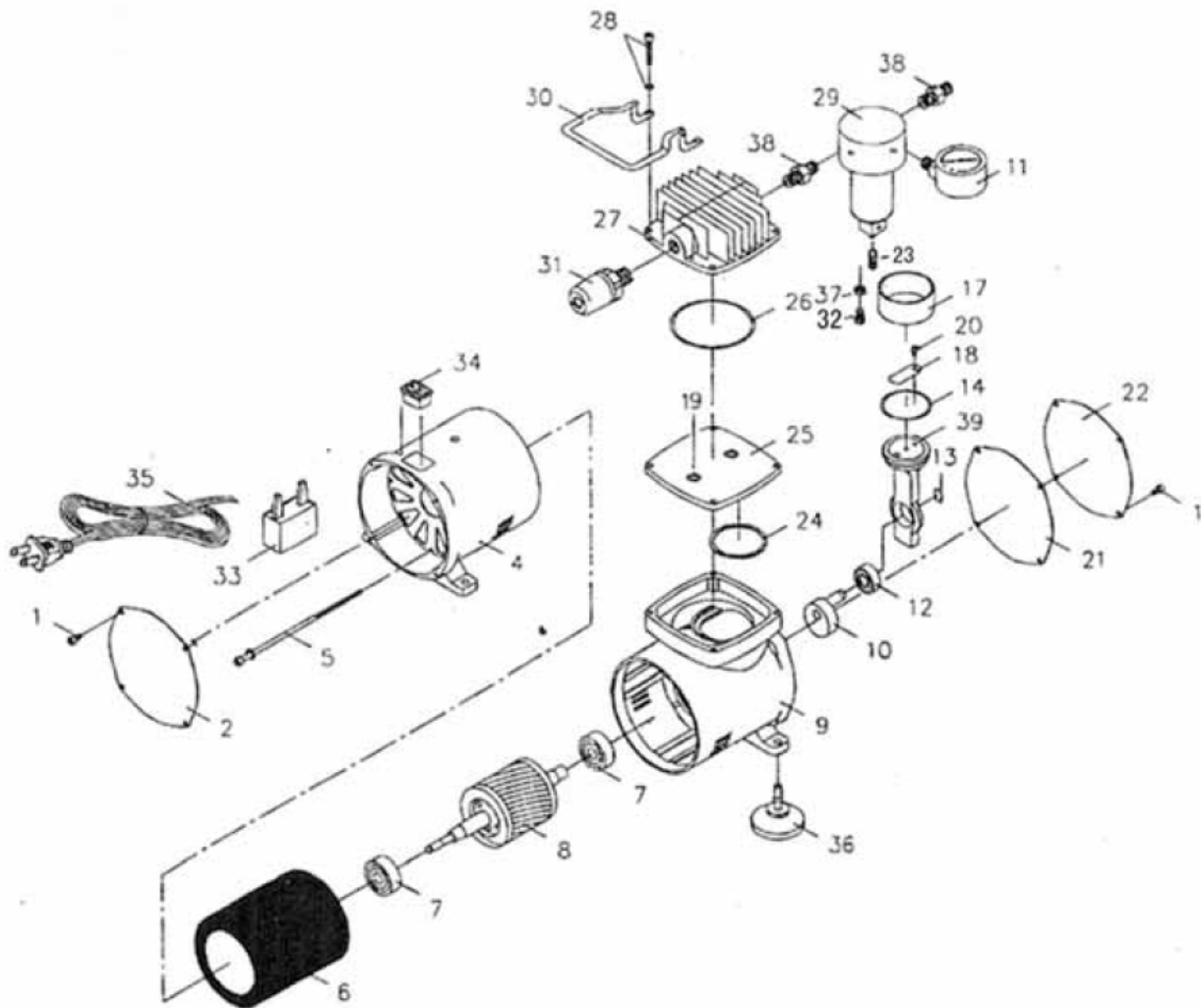

# Air Brush Parts List and Assembly Diagram

Part	Description	Qty
1A	Protective Cap	1
2A	Air Cap	1
3A	Nozzle	1
4A	Air Cap Body	1
5A	O-Ring	1
6A	Packing	1
7A	Packing Nut	1
8A	Air Brush Housing	1
9A	Needle Adjustment Screw	1
10A	Finger Lever	1
11A	Rocker	1
12A	Needle Adjusting Sleeve	1
13A	Needle Chucking Guide	1
14A	Valve Screw	1
15A	Needle Chucking Nut	1
16A	Needle Cover (Handle)	1

Part	Description	Qty
17A	Spring	1
18A	Needle	1
19A	O-Ring	1
20A	Valve Rod	1
21A	O-Ring	1
22A	Spring	1
23A	Valve Screw	1
24A	Valve Body	1
25A	Hose Connector Nut	1
26A	O-Ring for Hose Connector	1
27A	Hose Connector	1
28A	5cc Metal Cup	1
29A	7MM Wrench	1
30A	Metal Hanger	1
31A	22cc Glass Jar Assembly	1

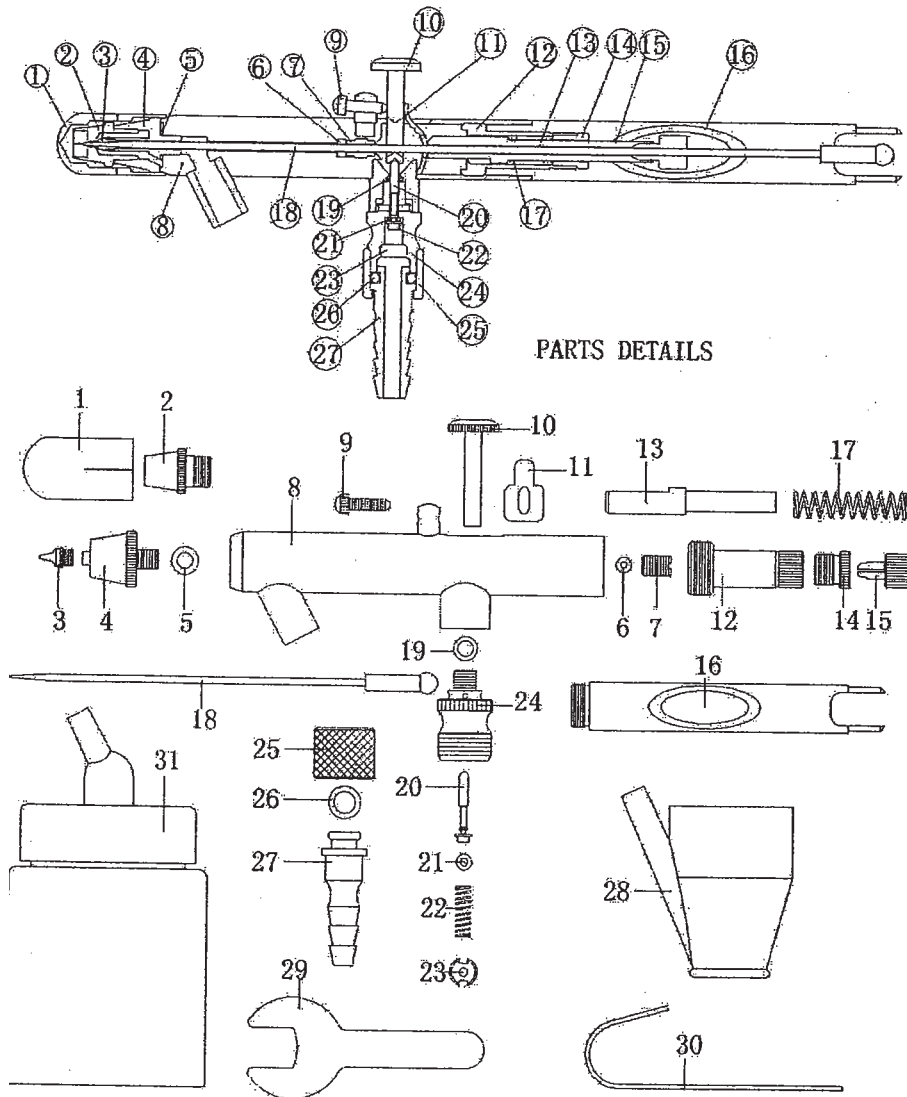

## Limited 1 Year Warranty

Harbor Freight Tools Co. makes every effort to assure that its products meet high quality and durability standards, and warrants to the original purchaser that this product is free from defects in materials and workmanship for the period of one year from the date of purchase (90 days if used by a professional contractor or if used as rental equipment). This warranty does not apply to damage due directly or indirectly, to misuse, abuse, negligence or accidents, repairs or alterations outside our facilities, normal wear and tear, or to lack of maintenance. We shall in no event be liable for death, injuries to persons or property, or for incidental, contingent, special or consequential damages arising from the use of our product. Some states do not allow the exclusion or limitation of incidental or consequential damages, so the above limitation of exclusion may not apply to you. THIS WARRANTY IS EXPRESSLY IN LIEU OF ALL OTHER WARRANTIES, EXPRESS OR IMPLIED, INCLUDING THE WARRANTIES OF MERCHANTABILITY AND FITNESS.

To take advantage of this warranty, the product or part must be returned to us with transportation charges prepaid. Proof of purchase date and an explanation of the complaint must accompany the merchandise. If our inspection verifies the defect, we will either repair or replace the product at our election or we may elect to refund the purchase price if we cannot readily and quickly provide you with a replacement. We will return repaired products at our expense, but if we determine there is no defect, or that the defect resulted from causes not within the scope of our warranty, then you must bear the cost of returning the product.

This warranty gives you specific legal rights and you may also have other rights which vary from state to state.

**Record Product's Serial Number Here:** \_\_\_\_\_

**Note:** If product has no serial number, record month and year of purchase instead.

**Note:** Some parts are listed and shown for illustration purposes only, and are not available individually as replacement parts.

# CENTRALPNEUMATIC®

3491 Mission Oaks Blvd. • PO Box 6009 • Camarillo, CA 93011 • (800) 444-3353

## Free Manuals Download Website

<http://myh66.com>

<http://usermanuals.us>

<http://www.somanuals.com>

<http://www.4manuals.cc>

<http://www.manual-lib.com>

<http://www.404manual.com>

<http://www.luxmanual.com>

<http://aubethermostatmanual.com>

Golf course search by state

<http://golfingnear.com>

Email search by domain

<http://emailbydomain.com>

Auto manuals search

<http://auto.somanuals.com>

TV manuals search

<http://tv.somanuals.com>