

# CENTRAL PNEUMATIC®

## 1/8 HP OIL-LESS AIRBRUSH COMPRESSOR WITH REGULATOR

Model 93657

### ASSEMBLY AND OPERATING INSTRUCTIONS



Due to continuing improvements, actual product may differ slightly from the product described herein.



3491 Mission Oaks Blvd., Camarillo, CA 93011  
Visit our Web site at: <http://www.harborfreight.com>

**TO PREVENT SERIOUS INJURY,  
READ AND UNDERSTAND ALL WARNINGS  
AND INSTRUCTIONS BEFORE USE.**

Copyright® 2005 by Harbor Freight Tools®. All rights reserved. No portion of this manual or any artwork contained herein may be reproduced in any shape or form without the express written consent of Harbor Freight Tools.

For technical questions, please call 1-800-444-3353.

## PRODUCT SPECIFICATIONS

Electrical Requirements	120 V / 60 Hz / 1/8 HP Motor / 1,750 RPM ON/OFF Rocker Power Switch 3-Prong, Grounded Power Plug 6' Long Power Cord (18AWG x 3C)
Compressor Type	Single Cylinder, Oil-less Pump
Thermal Protection	Internal Automatic Shut-Off On Overload And/Or Excessive Temperature Rise. Automatic Reset When Unit Cools.
Maximum Air Pressure	56 PSI
Working Air Pressure	0-40 PSI (continuous)
Air Output	.5 CFM @ 20 PSI
Automatic Shut-Off	Automatic Shut-Off At 56 PSI / Automatic Start At 43 PSI
Pressure Gauge	0-100 PSI (2 PSI Increments)
Air Outlet Size	1/8"-28 NPS Air Outlet with 1/4" NPT Male Adapter
Hose Dimensions	.236" OD x .157" ID x 10' Long (1/8"-28 NPS Female Adapter - both sides)
Overall Dimensions	9-1/4" L x 5-3/8" W x 9-1/4" H
Base Dimensions	7-3/8" L x 5-3/8" W x 1" H
Pipe Thread Seal Tape	1 Roll included
Weight	8 Pounds

## SAVE THIS MANUAL

You will need this manual for the safety warnings and precautions, assembly, operating, inspection, maintenance and cleaning procedures, parts list and assembly diagram. Keep your invoice with this manual. Write the invoice number on the inside of the front cover. Keep this manual and invoice in a safe and dry place for future reference.

## GENERAL SAFETY RULES AND PRECAUTIONS

 **WARNING!**  
**READ AND UNDERSTAND ALL INSTRUCTIONS**  
**Failure to follow all instructions listed below may result in**  
**electric shock, fire, and/or serious injury.**  
**SAVE THESE INSTRUCTIONS**

### WORK AREA

1. **Keep your work area clean and well lit.** Cluttered benches and dark areas invite accidents.
2.  **Do not operate power tools in explosive atmospheres, such as in the presence of flammable liquids, gases, or dust.** Power tools create sparks which may ignite the dust or fumes.

3. **Keep bystanders, children, and visitors away while operating a power tool.** Distractions can cause you to lose control. Protect others in the work area from debris such as chips and sparks. Provide barriers or shields as needed.

### PERSONAL SAFETY

1. **Stay alert. Watch what you are doing, and use common sense when operating a power tool. Do not use a power tool while tired or under the influence of drugs, alcohol, or medication.** A moment of inattention while operating power tools may result in serious personal injury.
2. **Dress properly. Do not wear loose clothing or jewelry. Contain long hair. Keep your hair, clothing, and gloves away from moving parts.** Loose clothes, jewelry, or long hair can be caught in moving parts.
3. **Avoid accidental starting. Be sure the Power Switch (34) is in its “OFF” position before moving the Compressor *and* before performing any service, maintenance, or cleaning procedures on the unit.**
4. **Remove adjusting keys or wrenches before turning the Compressor on.** A wrench or a key that is left attached to a rotating part of the machine may result in personal injury.
5. **Do not overreach. Keep proper footing and balance at all times.** Proper footing and balance enables better control of the power tool in unexpected situations.
6.  **Use safety equipment. Always wear eye protection.** Always wear ANSI-approved safety impact goggles when using this product.

### TOOL USE AND CARE

1. **Do not force the tool. Use the correct tool for your application.** The correct tool will do the job better and safer at the rate for which it is designed.
2. **Do not use the Compressor if the Power Switch (34) does not turn it on or off.** Any tool that cannot be controlled with its power switch is dangerous and must be replaced.
3. **Store idle tools out of reach of children and other untrained persons.** Tools are dangerous in the hands of untrained users.
4. **Maintain tools with care.** Properly maintained tools with a sharp cutting edge are less likely to bind and are easier to control. Do not use a damaged tool. Tag damaged tools “Do not use” until repaired.
5. **Check for misalignment or binding of moving parts, breakage of parts, and any other condition that may affect the tool’s operation. If damaged, have the**

**tool serviced before using.** Many accidents are caused by poorly maintained tools.



6. **Use only accessories that are recommended by the manufacturer for your model.** Accessories that may be suitable for one tool may become hazardous when used on another tool.

### SERVICE

1. **Tool service must be performed only by qualified repair personnel.** Service or maintenance performed by unqualified personnel could result in a risk of injury.
2. **When servicing a tool, use only identical replacement parts. Follow instructions in the “*Inspection, Maintenance, And Cleaning*” section of this manual.** Use of unauthorized parts or failure to follow maintenance instructions may create a risk of electric shock or injury.

## SPECIFIC SAFETY RULES AND PRECAUTIONS

1. **Maintain labels and nameplates on the Air Compressor.** These carry important information. If unreadable or missing, contact Harbor Freight Tools for a replacement.
2.  **DANGER!** This Air Compressor is NOT equipped and should not be used “as is” to supply breathing quality air. For any application of air for human consumption, you must fit the Air Compressor with suitable inline safety and alarm equipment (not included). This additional equipment is necessary to properly filter and purify the air to meet minimal specifications for Grade D breathing as described in Compressed Gas Association Commodity Specification G 7.1-1966, OSHA 29 CFR 1910. 134, and/or Canadian Standards Associations (CSA). In the event the Air Compressor is used for the purpose of breathing air application and proper inline safety and alarm equipment is not simultaneously used, existing warranties are void, and Harbor Freight Tools disclaims any liability whatsoever for any loss, personal injury, or damage.
3. **Make sure all tools and equipment used with the Air Compressor are rated to the appropriate capacity.** Do not use any tool or equipment that does not operate from 3 PSI to 40 PSI.
4. **Drain the Air Compressor every day.** Do not allow excessive moisture to build up inside the Air Compressor. Do not open the Water Drain Valve (40) with more than 10 PSI of air pressure in the Compressor.
5. **Avoid injury.** Never direct compressed air at people or animals. Never direct air-flow at eyes and ears.

6. **Make sure the Air Compressor is located on a flat, level, sturdy surface capable of supporting the weight of the Compressor and any additional tools and equipment.**
7. **Industrial applications must follow OSHA guidelines.**
8. **Never stand on the Air Compressor.** Serious injury could result if the Compressor is tipped.
9. **Never leave the Air Compressor unattended when it is plugged in and running.** Turn off the Compressor, and unplug the unit before leaving.
10. **Do not allow children and other unauthorized people to handle or play with the Air Compressor.**
11. **Do not move or transport the Compressor if the unit is under pressure.**
12. **Do not force the Compressor.** This tool will do the work better and safer at the speed and capacity for which it was designed.
13. **This Compressor will automatically shut off on overload or under excessive heat.** Should this occur, turn the Power Switch (34) to its “OFF” position. Wait until the Compressor cools. Then, turn the Power Switch to its “ON” position to resume work.
14. **Spray painting only.** Never use this unit with gasoline, kerosene, or any other flammable solvent.
15.  **WARNING!** The brass components of this product contain lead, a chemical known to the State of California to cause birth defects (or other reproductive harm). (California Health & Safety code § 25249.5, *et seq.*)
16.  **WARNING!** People with pacemakers should consult their physician(s) before using this product. Operation of electrical equipment in close proximity to a heart pacemaker could cause interference to or failure of the pacemaker.
17.  **WARNING!** The warnings and precautions discussed in this manual cannot cover all possible conditions and situations that may occur. It must be understood by the operator that common sense and caution are factors which cannot be built into this product, but must be supplied by the operator.

### **SAVE THESE INSTRUCTIONS**

## GROUNDING

### WARNING!

Improperly connecting the grounding wire can result in the risk of electric shock. Check with a qualified electrician if you are in doubt as to whether the outlet is properly grounded. Do not modify the power cord plug provided with the tool. Never remove the grounding prong from the plug. Do not use the tool if the power cord or plug is damaged. If damaged, have it repaired by a service facility before use. If the plug will not fit the outlet, have a proper outlet installed by a qualified electrician.

### GROUNDING TOOLS: TOOLS WITH THREE PRONG PLUGS

1. Tools marked with “Grounding Required” have a three wire cord and three prong grounding plug. The plug must be connected to a properly grounded outlet. If the tool should electrically malfunction or break down, grounding provides a low resistance path to carry electricity away from the user, reducing the risk of electric shock. **(See Figure A.)**
2. The grounding prong in the plug is connected through the green wire inside the cord to the grounding system in the tool. The green wire in the cord must be the only wire connected to the tool’s grounding system and must never be attached to an electrically “live” terminal. **(See Figure A.)**
3. Your tool must be plugged into an appropriate outlet, properly installed and grounded in accordance with all codes and ordinances. The plug and outlet should look like those in the following illustration. **(See Figure A.)**

THIS PRODUCT  
USES A  
3-PRONG PLUG

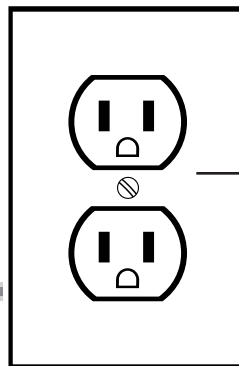

120 VOLT, GROUNDED,  
ELECTRICAL OUTLET

**FIGURE A**

**DOUBLE INSULATED TOOLS: TOOLS WITH TWO PRONG PLUGS**

4. Tools marked “Double Insulated” do not require grounding. They have a special double insulation system which satisfies OSHA requirements and complies with the applicable standards of Underwriters Laboratories, Inc., the Canadian Standard Association, and the National Electrical Code. **(See Figure B.)**
5. Double insulated tools may be used in either of the 120 volt outlets shown in the following illustration. **(See Figure B.)**

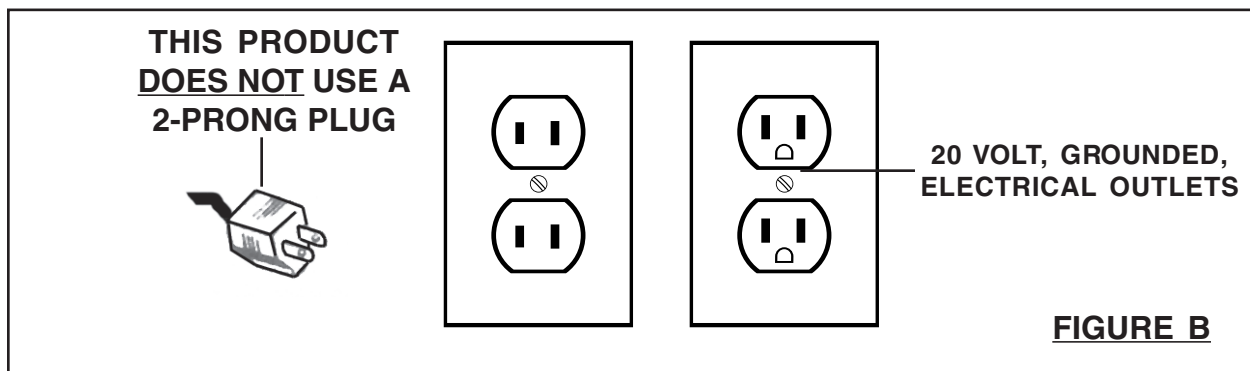

**SYMBOLOLOGY**

	Double Insulated
	Canadian Standards Association
	Underwriters Laboratories, Inc.
<b>V ~</b>	Volts Alternating Current
<b>A</b>	Amperes
noxxxx/min.	No Load Revolutions per Minute (RPM)

**FIGURE C**

## UNPACKING

When unpacking, check to make sure all the parts shown on the **Parts List on page 11** are included. If any parts are missing or broken, please call Harbor Freight Tools at the number shown on the cover of this manual as soon as possible.

## SETUP INSTRUCTIONS

1. **⚠ CAUTION!** Always make sure the Power Switch (34) of the Air Compressor is in its “OFF” position and the unit is unplugged from its electrical outlet prior to performing any service, maintenance, or cleaning of the Compressor.
2. Before operating, make sure the Air Compressor is set up in a well-ventilated area, on a flat, level, solid surface well away from any flammable objects, such as drapes. Never paint in an area without proper ventilation, or near possible ignition sources.

## OPERATING INSTRUCTIONS

### ***To Start The Compressor:***

1. Insert the Power Cord Plug (35) into the nearest 120 volt, grounded, electrical outlet. **(See Figure A.)**
2. Connect an Air Brush (not included) to the Air Hose (42) of the Compressor. Use Hose Adapter (44) if needed.
3. Turn the Power Switch (34) to its “ON” position. **(See Figure A.)**

**FIGURE A**

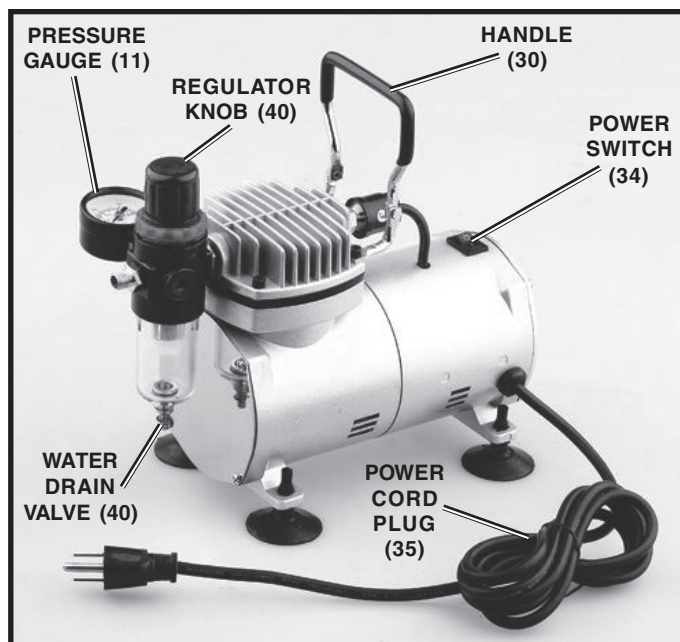

**Note:** This Compressor is designed for use with air brushes; never attempt to operate this compressor with any other type of painting equipment.





4. **NOTE:** The Compressor will automatically begin to run when the air pressure falls below **43 PSI**. When the maximum air pressure (**56 PSI**) is reached, the Compressor will automatically switch to idle and the Compressor will stop operating. The Compressor will automatically restart when the air pressure falls below **43 PSI**. **(See Figure A.)**
5. Adjust the regulated air pressure output as shown on the Pressure Gauge (11) by lifting the Regulator Knob (40), turning it to the desired pressure and pressing it back down.
6. When finished using the Air Compressor, turn its Power Switch (34) to its “**OFF**” position. Bleed out any remaining air and disconnect the Air Brush. Briefly depress the Water Drain Valve (41) to empty the unit of water after each use. **(See Figure A.)**
7. Always make sure to store the Air Compressor in a clean, dry, safe location out of reach of children and other unauthorized people.

## INSPECTION, MAINTENANCE, AND CLEANING

1.  **CAUTION!** Always make sure the Power Switch (34) of the Air Compressor is in its “**OFF**” position and the unit is unplugged from its electrical outlet prior to performing any service, maintenance, or cleaning of the Compressor.
2. **Before each use**, inspect the general condition of the Air Compressor. Check for loose screws, misalignment or binding of moving parts, cracked or broken parts, damaged electrical wiring, loose air fittings, and any other condition that may affect the safe operation of the Compressor. If abnormal noise or vibration occurs, have the problem corrected before further use.  
**Do not use damaged equipment.**
3. **After each use:** The Filter (29) will fill up with moisture from air that flows through the Filter. After each use, push the Water Drain Valve (41) under the Filter Cup to drain out the moisture. **(See Figure A.)**
4. **To clean**, wipe with a damp cloth, using a mild detergent. Never use solvents such as thinner, alcohol, trichloroethylene, etc. to clean the Air Compressor.
5. Always store the Air Compressor in a clean, dry, safe location out of reach of children and other unauthorized people.
6.  **CAUTION! All maintenance, service, or repairs not mentioned in this manual must only be performed by a qualified service technician.**

## TROUBLESHOOTING

Problem	Possible Causes	Possible Solutions
The motor does not work.	<ol style="list-style-type: none"> <li>1. No electrical power.</li> <li>2. Damaged power cord.</li> <li>3. Electrical wiring within the unit is defective.</li> <li>4. Power switch is defective.</li> </ol>	<ol style="list-style-type: none"> <li>1. Make sure the power cord is plugged into a <i>working</i>, 120 volt, grounded, electrical outlet.</li> <li>2. Have a qualified service technician replace the power cord.</li> <li>3. Have a qualified service technician replace electrical wiring.</li> <li>4. Have a qualified service technician replace power switch.</li> </ol>
The motor runs, but it makes irregular noises or a knocking noise.	<ol style="list-style-type: none"> <li>1. Bearing is loose or damaged.</li> <li>2. Screws in the connection rod are loose.</li> </ol>	<ol style="list-style-type: none"> <li>1. Have a qualified service technician replace the bearing.</li> <li>2. Tighten the screws, or replace them if necessary.</li> </ol>
Not enough pressure when painting or spraying.	<ol style="list-style-type: none"> <li>1. Loose air connection(s).</li> <li>2. Air hose is damaged.</li> <li>3. Screws on cylinder cover are loose.</li> </ol>	<ol style="list-style-type: none"> <li>1. Check all air connections, and tighten them if necessary.</li> <li>2. Replace air hose.</li> <li>3. Tighten screws.</li> </ol>
Poor spray pattern.	<ol style="list-style-type: none"> <li>1. Loose air connection(s)</li> <li>2. The oil paint concentration is too high.</li> <li>3. The air brush nozzle is plugged or dirty.</li> </ol>	<ol style="list-style-type: none"> <li>1. Check all air connections, and tighten them if necessary.</li> <li>2. Add paint thinner and mix thoroughly.</li> <li>3. Clean or change the nozzle.</li> </ol>
Motor runs good, but no air pressure or lack of air delivery.	<ol style="list-style-type: none"> <li>1. Valve plate is unscrewed or out of place.</li> <li>2. Retainer ring is damaged after excessive use at high pressure.</li> </ol>	<ol style="list-style-type: none"> <li>1. Open the front cover and make sure the valve plate is in the proper position. Tighten the screws if necessary.</li> <li>2. Have a qualified service technician replace the retainer ring.</li> </ol>

### WARNING!

**All servicing must be done with the power switch off and the power cord unplugged from its electrical outlet.**

**PLEASE READ THE FOLLOWING CAREFULLY**

THE MANUFACTURER AND/OR DISTRIBUTOR HAS PROVIDED THE PARTS LIST AND ASSEMBLY DIAGRAM IN THIS MANUAL AS A REFERENCE TOOL ONLY. NEITHER THE MANUFACTURER OR DISTRIBUTOR MAKES ANY REPRESENTATION OR WARRANTY OF ANY KIND TO THE BUYER THAT HE OR SHE IS QUALIFIED TO REPLACE ANY PARTS OF THE PRODUCT. IN FACT, THE MANUFACTURER AND/OR DISTRIBUTOR EXPRESSLY STATES THAT ALL REPAIRS AND PARTS REPLACEMENTS SHOULD BE UNDERTAKEN BY CERTIFIED AND LICENSED TECHNICIANS, AND NOT BY THE BUYER. THE BUYER ASSUMES ALL RISKS AND LIABILITY ARISING OUT OF HIS OR HER REPAIRS TO THE ORIGINAL PRODUCT OR REPLACEMENT PARTS THERETO, OR ARISING OUT OF HIS OR HER INSTALLATION OF REPLACEMENT PARTS THERETO.

**PARTS LIST**

Part	Description	Qty.	Part	Description	Qty.
1	Screw	8	25	Cylinder Block	1
2	Rear Cover	1	26	O-Ring	1
4	Rear Body	1	27	Cylinder Head	1
5	Screw	4	28	Cap Screw	4
6	Stationary Motor	1	29	Filter	1
7	Bearing	2	30	Handle	1
8	Rotary Motor	1	31	Pressure Switch	1
9	Front Body	1	33	Condenser	1
10	Counterweight	1	34	Power Switch	1
11	Pressure Gauge	1	35	Power Cord/Plug	1
12	Bearing	1	36	Rubber Pad	4
13	Retainer Ring	1	37	Connector	1
14	Compression Ring	1	38	Air Outlet	1
17	Cylinder	1	39	Link	1
18	Valve Plate	2	40	Pressure Regulator	1
19	Valve	1	41	Water Drain Valve	1
20	Screw	1	43	Air Hose	1
21	Front Gasket	1	44	Hose Adapter for Air Brush	1
22	Front Cover	1	45	Male Adapter 1/4" 18 NPT	1
23	Rear Gasket	1	46	Thread Seal Tape	1
24	O-Ring	1			

**NOTE:**

Some parts are listed and shown for illustration purposes only, and are not available individually as replacement parts.

# ASSEMBLY DIAGRAM

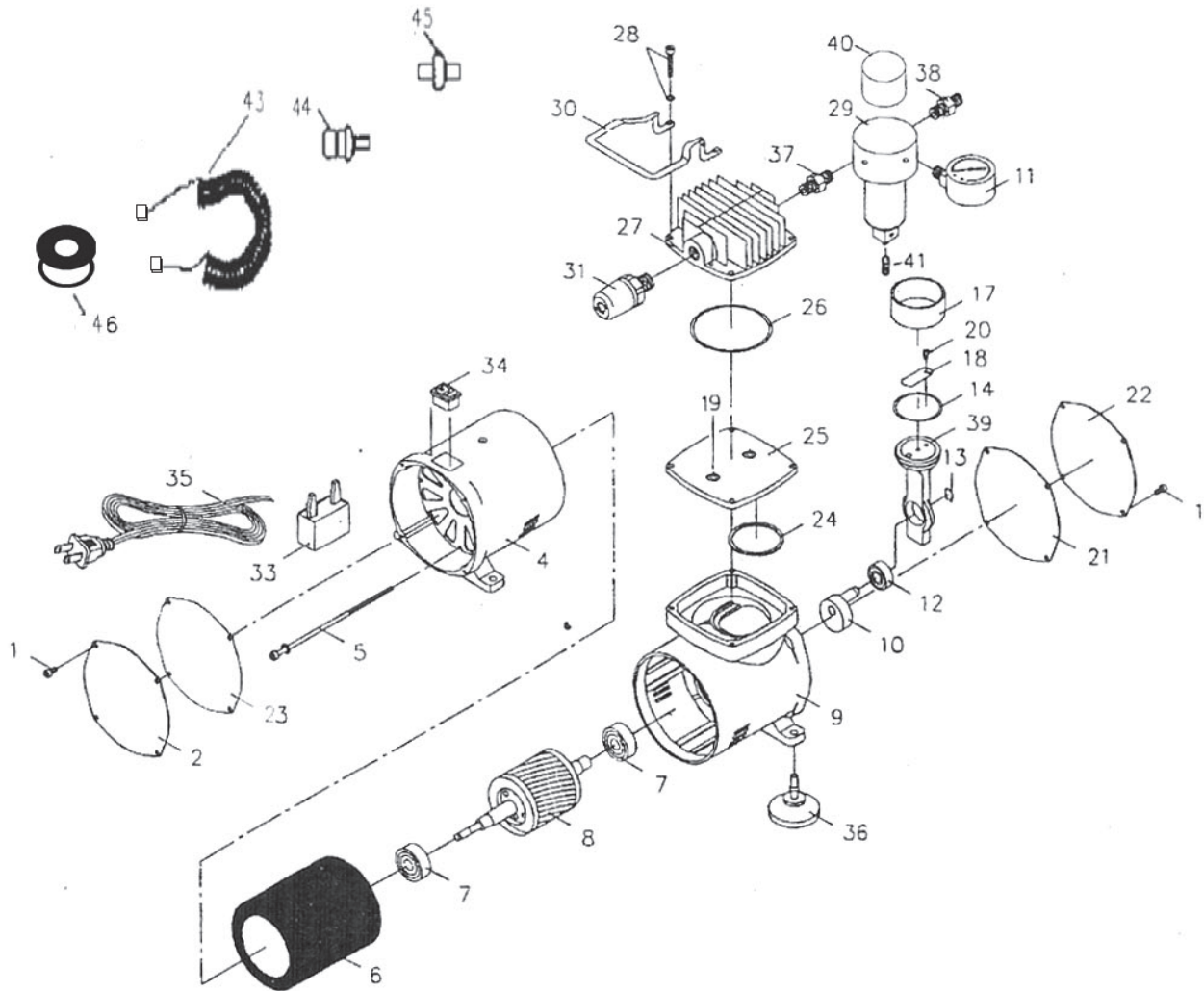

## NOTE:

Some parts are listed and shown for illustration purposes only, and are not available individually as replacement parts.

## Free Manuals Download Website

<http://myh66.com>

<http://usermanuals.us>

<http://www.somanuals.com>

<http://www.4manuals.cc>

<http://www.manual-lib.com>

<http://www.404manual.com>

<http://www.luxmanual.com>

<http://aubethermostatmanual.com>

Golf course search by state

<http://golfingnear.com>

Email search by domain

<http://emailbydomain.com>

Auto manuals search

<http://auto.somanuals.com>

TV manuals search

<http://tv.somanuals.com>