

# DUCT TYPE AIR CONDITIONER

## Operation & Instruction Manual

AD242AHBEA  
AD28NAHBEA  
AD36NAHBEA  
AD42NAHBEA  
AD52NAHBEA

No. 0010573192  
E

- Please read this operation manual before using the air conditioner.
- Please keep this manual carefully and safely.

# Table of Contents

---

Cautions .....	2
Safety Precautions .....	3-5
Parts and Functions .....	6
Malfunction .....	7- 8
Care and Maintenance .....	9
For Preparation of Heating( "Hot Keep") .....	10
Is The Unit Installed Correctly .....	11
Installation Manual For Indoor Unit .....	12-20
Installation Manual For Electric Wiring .....	21

---

# ■ Cautions

## *Disposal of the old air conditioner*

Before disposing an old air conditioner that goes out of use, please make sure it's inoperative and safe. Unplug the air conditioner in order to avoid the risk of child entrapment.

It must be noticed that air conditioner system contains refrigerants, which require specialized waste disposal. The valuable materials contained in a air conditioner can be recycled. Contact your local waste disposal center for proper disposal of an old air conditioner and contact your local authority or your dealer if you have any question. Please ensure that the pipework of your air conditioner does not get damaged prior to being picked up by the relevant waste disposal center, and contribute to environmental awareness by insisting on an appropriate, anti-pollution method of disposal.

## *Disposal of the packaging of your new air conditioner*

All the packaging materials employed in the package of your new air conditioner may be disposed without any danger to the environment.

The cardboard box may be broken or cut into smaller pieces and given to a waste paper disposal service. The wrapping bag made of polyethylene and the polyethylene foam pads contain no fluorochloric hydrocarbon.

All these valuable materials may be taken to a waste collecting center and used again after adequate recycling.

Consult your local authorities for the name and address of the waste materials collecting centers and waste paper disposal services nearest to your house.

## *Safety Instructions and Warnings*

Before starting the air conditioner, read the information given in the User's Guide carefully. The User's Guide contains very



important observations relating to the assembly, operation and maintenance of the air conditioner.

The manufacturer does not accept responsibility for any damages that may arise due to non-observation of the following instruction.

- Damaged air conditioners are not to be put into operation. In case of doubt, consult your supplier.
- Use of the air conditioner is to be carried out in strict compliance with the relative instructions set forth in the User's Guide.
- Installation shall be done by professional people, don't install unit by yourself.
- For the purpose of safety, the air conditioner must be properly grounded in accordance with specifications.
- Always remember to unplug the air conditioner before opening inlet grill. Never unplug your air conditioner by pulling on the power cord. Always grip plug firmly and pull straight out from the outlet.
- All electrical repairs must be carried out by qualified electricians. Inadequate repairs may result in a major source of danger for the user of the air conditioner.
- Do not damage any parts of the air conditioner that carry refrigerant by piercing or perforating the air conditioner's tubes with sharp or pointed items, crushing or twisting any tubes, or scraping the coatings off the surfaces. If the refrigerant spurts out and gets into eyes, it may result in serious eye injuries.
- Do not obstruct or cover the ventilation grille of the air conditioner. Do not put fingers or any other things into the inlet/outlet and swing louver.
- Do not allow children to play with the air conditioner. In no case should children be allowed to sit on the outdoor unit.

# Safety Precautions

- Before starting to use the system, read carefully this "SAFETY PRECAUTIONS" to ensure a proper operation of the system.
- Safety precautions described here are classified to "⚠ WARNING" and "⚡ CAUTION". Precautions which are shown in the column of "⚠ WARNING" means that an improper handling could lead to a grave result like a death, serious injury, etc. However, even if precautions are shown in the column of "⚡ CAUTION", a very serious problem could occur depending on situation. Make sure to observe these safety precautions faithfully because they are very important information to ensure the safety.
- Symbols which appear frequently in the text have following meanings.

	Strictly prohibited.		Observe instructions faithfully.		Provide a positive grounding.
---	----------------------	---	----------------------------------	---	-------------------------------

- When you have read through the manual, keep it always at hand for read consultation. If the operator is replaced, make sure to hand over this manual to the new operator.

## CAUTIONS FOR INSTALLATION

### ⚠ WARNING

The system should be applied to places as office, restaurant, residence and the like.



Application to inferior environment such as an engineering shop, could cause equipment malfunction and serious injury or death.

The system should be installed by your dealer or a professional installer.



Installation by yourself is not encouraged because it could cause such problems as water leakage, electrical shock or fire accident by some improper handling.

When you need some optional devices such as a humidifier, electric heater, etc., be sure to use the products which are recommended by us. These devices should be attached by a professional installer.



Installation by yourself is not encouraged because it could cause such problems as water leakage, electrical shock or fire accident by some improper handling.

### ⚡ CAUTION

Do not install nearby the place where may have leakage of flammable gas.



If the gas leaks and gathers around, it may cause the fire.

Depending on the place of installation, a circuit breaker may be necessary.



Unless the circuit breaker is installed, it could cause electrical shocks.

Drain pipe should be arranged to provide a positive draining.



If the pipe is arranged improperly, furniture or the likes may be damaged by leaked water.

Where strong winds may prevail, the system should be fixed securely to prevent a collapse.



Bodily injury could result by a collapse.

Install on the place where can endure the weight of air conditioner.



Bodily injury could result by a careless installation.

Make sure the system is grounded.

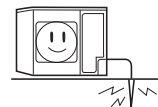

Grounding cable should never be connected to a gas pipe, city water pipe, lightning conductor rod or grounding cable of telephone. If the grounding cable is not set properly, it could cause electric shocks.

## CAUTIONS FOR OPERATION

### ⚠ WARNING

You should refrain from exposing your body directly to cool wind for a long time.



It could affect your physical condition or cause some health problems.

Do not poke the air inlet or outlet with a bar, etc.



Since the internal fan is operating with a high speed, it could cause an injury.

When any abnormal condition (scorching smell or others) is found, stop the operation immediately and turn off the power switch. Then consult your dealer.



If you continue the operation without removing the cause, it could result in a trouble, electric shock or fire.

### ⚡ CAUTION

The system should never be used for any other purposes than intended such as for preservation of food, flora and fauna, precision devices or work of art.

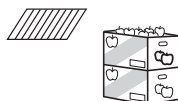

It could cause deterioration of food or other problems.

Do not handle switches with a wet hand.



It could cause electric shocks.

Combustion apparatus should not be placed allowing a direct exposure to wind of air conditioner.

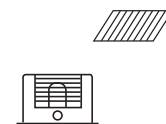

Incomplete combustion could occur on the apparatus.

# Safety Precautions

## ⚠ CAUTION

Do not wash the air conditioner with water.



It could cause electric shocks.

Do not install the system where the air outlet reaches directly the flora and fauna.



It will not be good for their health.

Make sure to use a fuse of proper electric rating.



Use of steel or copper wire in place of a fuse is strictly prohibited because it could result in a trouble or fire accident.

Neither stand on the air conditioner nor place something on it.

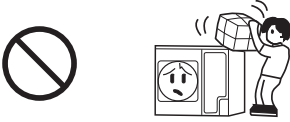

There are risks of falling or injury by collapsed object.

It is strictly prohibited to place a container of combustible gas or liquid near the air conditioner or to spray it directly with the gas or liquid.



It could cause a fire accident.

Do not operate the system while the air outlet grill is removed.

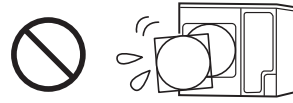

There is a risk of injury.

Do not use the power switch to turn on or off the system.

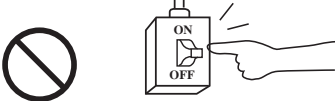

It could cause a fire or water leakage.

Do not touch the air outlet section while the swing louver is operating.



There is a risk of injury.

Do not use such equipment as a water heater, etc. around the indoor unit or the wire controller.



If the system is operated at the vicinity of such equipment which generates steam, condensed water may drip during cooling operation or it could cause a fault current or short-circuit.

When operating the system simultaneously with a combustion apparatus, indoor air must be ventilated frequently.



Insufficient ventilation could cause an oxygen deficiency accident.

Check occasionally the support structure of the unit for any damage after a use of long period of time.



If the structure is not repaired immediately, the unit could topple down to cause a personal injury.

Do not place any objects on or climb on the unit.

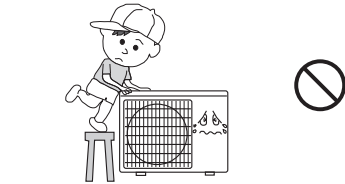

When cleaning the system, stop the operation and turn off the power switch.



Cleaning should never be done while the internal fans are running with high speed.

Do not put water containers on the unit such as a flower vase, etc.



If the structure is not repaired immediately, the unit could topple down to cause a personal injury.

Do not try to repair or reconstruct by yourself.

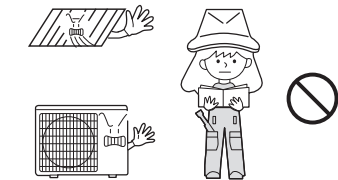

## CAUTIONS FOR TRANSFER OR REPAIR

### ⚠ WARNING

Modification of the system is strictly prohibited. When the system needs a repair, consult your dealer.



Improper practice of repair could cause water leakage, electric shock or fire.

When the air conditioner is relocated, contact your dealer or a professional installer.



Improper practice of installation could cause water leakage, electric shock or fire.

# ■ Safety Precautions

## The machine is adaptive in following situation

1. Applicable ambient temperature range:

			Rated	Maximum	Minimum
Cooling	Indoor	DB °C	27	32	18
		WB °C	19	23	14
	outdoor	DB °C	35	43	10
		WB °C	24	26	6
Heating	Indoor	DB °C	20	27	15
		WB °C	14.5	--	--
	outdoor	DB °C	7	24	-7
		WB °C	6	18	--

- If the supply cord is damaged, it must be replaced by the manufacturer or its service agent or a similar qualified person.
- If the fuse on PC board is broken please change it with the type of T 3.15A /250VAC.
- The wiring method should be in line with the local wiring standard.
- The power cable and connecting cable are self-provided. The power cable should be H07RN-F 5G 4.0mm<sup>2</sup>(for AD52NAHBEA) or H07RN-F 5G 2.5mm<sup>2</sup>(forAD28NAHBEA(380-400V, 3N~, 50Hz), AD36NAHBEA, AD42NAHBEA) or H05RN-F 3G 4.0mm<sup>2</sup>(for AD242AHBEA). H05RN-F 3G 6.0mm<sup>2</sup>(for AD28NAHBEA(1PH, 220-230V~,50Hz)). The connecting cable should be H05RN-F 4G 0.75mm<sup>2</sup>  
All the cables shall have got the European authentication certificate. During installation, when the connecting cables break off, it must be assured that the grounding wire is the last one to be broken off.
- The breaker of the air conditioner should be all-pole switch; and the distance between its two contacts should be no less 3mm.
- The indoor unit installation height is at least 2.5m.

# ■ Parts and Functions

---

## Indoor Unit

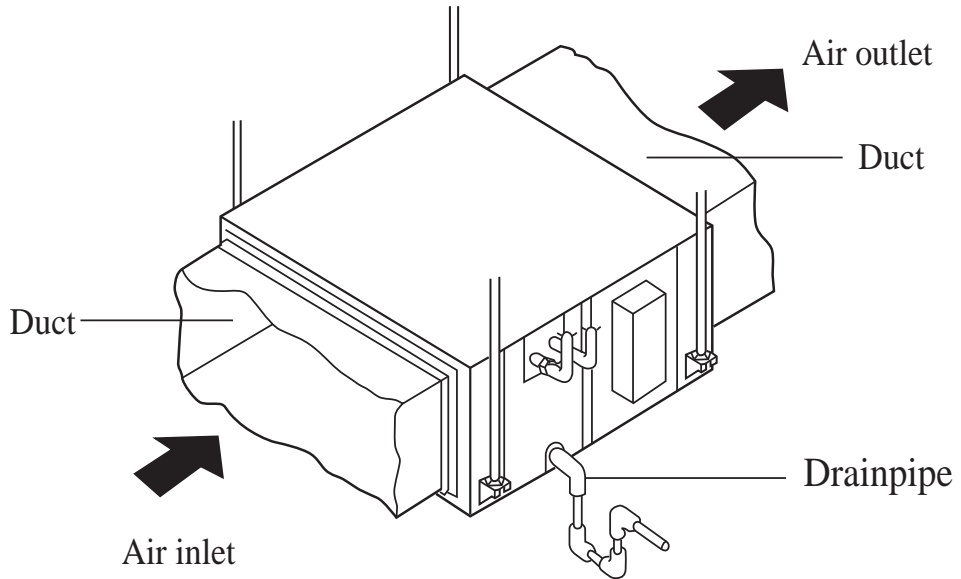

# ■ Malfunction

please check the following things about your air conditioner before making a service call.

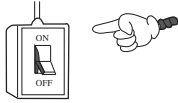
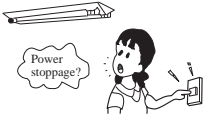
<b>Unit fails to start</b>			
<p><b>Is the power source switch adjust cut in?</b></p>  <p>Power supply switch is not ON.</p>	<p><b>Is city supply power in normal?</b></p> 	<p><b>Isn't the signal receiving section exposed to the direct sunlight or strong illumination?</b></p>	<p><b>Isn't the earth leakage breaker in action?</b></p> <p>It is dangerous. Turn off the power supply switch immediately and contact the sales dealer.</p>
<b>Cooling or heating is not sufficient</b>			
<p><b>Is the thermostat adjust as required?</b></p>	<p><b>Isn't the air filter dirty?</b></p>	<p><b>Isn't any doors or windows left open?</b></p>	<p><b>Doesn't any obstacle exist at the air inlet or outlet?</b></p>
<p><b>Isn't the swing louver horizontal? (At HEATING mode)</b> If swing louver is horizontal, the blow wind does not reach floor.</p>	<b>Cooling is not sufficient</b>		
	<p><b>Isn't sun-shine invading direct?</b></p>	<p><b>Isn't any unexpected heating load generated?</b></p>	<p><b>Isn't the room much crowded?</b></p>
<p><b>The wind does not blow during heating operation</b> Isn't it warming up?</p>			



When the air conditioner does not operate properly after you have checked the above mentioned items or when the following phenomenon is observed, stop the operation of the air conditioner and contact your sales dealer.

- The fuse or breaker often shuts down.
- Water drops off during cooling operation.
- There is a irregularity in operation or abnormal sound is audible.
- When the CHECK LED1 (red) flickers, an irregularity has occurred in the air conditioner.

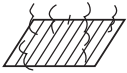

# ■ Malfunction

## The followings are not malfunction

<p>Water flowing sound is heard.</p> 	<p>When the air conditioner is started, when the compressor starts or stops during operation or when the air conditioner is stopped, it sometimes sounds "shuru shuru" or "gobo gobo". It is the flowing sound of the refrigerant, and it is not a trouble.</p>
<p>Cracking sound is heard.</p>	<p>This is caused by heat expansion or contraction of plastics.</p>
<p>It smells.</p>	<p>Air which blows out from the indoor unit sometimes smells. The smell results from residents of tobacco smoke or cosmetics stuck inside of unit.</p>
<p>During operation, white fog comes out of indoor unit.</p> 	<p>When the air conditioner is used at restaurant etc. where dense edible oil fume is always exists, white fog sometimes blows out of air outlet during operation. In this case consult sales dealer for cleaning the heat exchanger.</p>
<p>It is switched into the FAN mode during cooling.</p>	<p>To prevent frost from being accumulated on the indoor unit heat exchanger, it is sometimes automatically switched to the FAN mode but it will soon return to the cooling mode.</p>
<p>The air conditioner can not be restarted soon after it stops.</p> 	<p>Even if the operation switch is turned on, cooling, dehumidifying or heating is not operable for three minutes after the conditioner is stopped. Because the protecting circuit is activated. (During this time air conditioner operates in fan mode.)</p> 
<p>Air does not blow or the fan speed can not be changed during dehumidifying</p>	<p>When it is excessively cooled during dehumidifying, the blower automatically repeats reducing and lowering the fan speed.</p>
<p>During operation, operation mode has changed over automatically.</p>	<p>Isn't the AUTO mode selected? In the case of AUTO mode, operation mode is changed automatically from cooling to heating or vise-versa according to the room temperature.</p>
<p>Water or steam generates from the outdoor unit during heating.</p>	<p>This results when frost accumulated on the outdoor unit is removed (during defrosting operation).</p>

# Care and Maintenance

## Points to observe

Turn off the power supply switch.



Do not touch with wet hand.



Do not use hot water or volatile liquid.



### CAUTION

- Do not open the inlet grill until fan stops completely.
- Fan will continue rotating for a while by the law of inertia after operation is being stopped.

## Cleaning

1. Clean the air filter by lightly tapping it or with the cleaner. It is more effective to clean the air filter with water.  
If the air filter is very dirty, dissolve neutral detergent in the lukewarm water (approx. 30°C), rinse the air filter in the water, and thoroughly wash the air filter off the detergent in the plain water.
2. After drying the air filter, set it up on the air conditioner.



### CAUTION

- Do not dry the air filter with fire.
- Do not run the air conditioner without the air filter.

## Care and Cleaning of the unit

- Clean with soft and dry cloth.
- If it is very dirty, dissolve neutral detergent in the lukewarm water and make the cloth wet with the water. After wiping, clean off the detergent using clean water.

## Post-Season Care

- Operate the unit with FAN mode on a fair day for about half a day to dry the inside of the unit well.
- Stop operation and turn off the power supply switch. Electric power is consumed even the air conditioner is in stop.
- Clean the air filter and set it in the place.

## Pre-Season Care

See that there are no obstacles blocking the air inlet and air outlet of both indoor and outdoor units.

- Make sure that the air filter is not dirty.
- Cut in the power supply switch 12 hours before starting run.

# ■ For Preparation of Heating("Hot Keep")

"HOT KEEP" is operated in the following cases.

- When heating is started:

In order to prevent blowing out of cool wind, the indoor unit fan stopped according to the room temperature which heating operation is started. Wait for approx. 2 to 3 minute, and the operation will be automatically changed to the ordinary heating mode.

- Defrosting operation (in the heating mode):

When it is liable to frost. the heating operation is stopped automatically for 5 to 12 minutes once per approx. one hour, and defrosting is operated. After defrosting is completed, operation mode is automatically changed to ordinary heating operation.

- When the room thermostat is actuated:

When room temperature increases and room temperature controller actuates, the fan speed is automatically changed to stop under low temperature condition of indoor heat exchanger. When room temperature decreases, air conditioner automatically changes over to ordinary heating operation.



## ■ WARMING OPERATION

- Heat pump type warming

With the heat pump type warming, the mechanism of heat pump that concentrate heat of outdoor air with the help of refrigerant to warm the indoor space, is utilized.

- Defrosting operation

When a room is warmed with a heat pump type air conditioner, frost accumulates on the heat exchanger of outdoor unit along with the drop of indoor temperature. Since the accumulated frost reduces the effect of warming, it is necessary to automatically switch the operation to the defrosting mode. During the defrosting operation, heating operation is interrupted.

- Atmospheric temperature and warming capacity

Warming capacity of heat pump type air conditioner decreases along with the drop of outdoor temperature.

When the warming capacity is not sufficient, it is recommended to use another heating implement.

- Period of warm-up

Since the heat pump type air conditioner employs a method to circulate warm winds to warm the entire space of a room, it takes time before the room temperature rises.



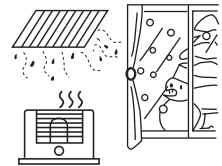

It is recommendable to start the operation a little earlier in a very cold morning.



# ■ Is The Unit Installed Correctly

Confirm the following items for safe and comfortable use of air conditioner.

The installation work is to be burden on the sales dealer, and do not conduct it by yourself.

<b>Installation place</b>		
<p><b>Avoid installing the air conditioner near the place where possibility of inflammable gas leakage exists.</b></p>  <p>Explosion (Ignition) may occur.</p>	<p><b>Install the unit at well ventilated place.</b></p>  <p>If some obstacle exist, it may cause capacity reduction or noise increase.</p>	<p><b>Install the air conditioner firmly on the foundation that can fully support the weight of the unit.</b></p>  <p>If not, it may cause vibration or noise.</p>
<p><b>Select the place so as not to annoy neighbor with the hot air or noise.</b></p>  	<p><b>Snow protection work is necessary where outdoor unit is blocked up by snow.</b></p> <p>For details consult your sales dealer.</p>	<p>It is advisable not to install the air conditioner at the following special place. It may cause malfunction, consult the sales dealer when you have to install the unit on such a place.</p> <ul style="list-style-type: none"> <li>● The place where corrosive gas generates (Hot spring area etc.)</li> <li>● The place where salt breeze blows (Seaside etc.)</li> <li>● The place where dense soot smoke exists</li> <li>● The place where humidity is extraordinarily high</li> <li>● The place where near the machine which radiates the electromagnetic wave</li> <li>● The place where voltage variation is considerably large</li> </ul>

## Electric work

The electric work must be burden on the authorized engineer with qualification for electric work and grounding work, and the work must be conducted in accordance with electric equipment technical standard.

- The power source for the unit is to be of exclusive use.
- An earth leakage breaker should be installed.(This is necessary to prevent electric shock.)
- The unit must be grounded.

## When you change your address or the installation place

Special technology is required for removal or reinstallation of air conditioner, consult the sales dealer. Besides, construction expense is charged for removal or reinstallation.

## For inspection and maintenance

The capacity of air conditioner will decrease by contamination of inside of unit when it is used for about three years although depending upon the circumstances under which it is used, and so in addition to the usual maintenance service, special inspection/maintenance service is necessary. It is recommended to make a maintenance contract (charged) by consulting your sales dealer.

# ■ Installation Manual For Indoor Unit

## 1. Safety precautions

- Please read these "Safety Precautions" first then accurately execute the installation work.
- Though the precautionary points indicated herein are divided under two headings, **⚠ WARNING** and **⚠ CAUTION**, those points which are related to the strong possibility of an installation done in error resulting in death or serious injury are listed in the **⚠ WARNING** section. However, there is also a possibility of serious consequences in relationship to the points listed in the **⚠ CAUTION** section as well. In either case, important safety related information is indicated, so by all means, properly observe all that is mentioned.
- After completing the installation, along with confirming that no abnormalities were seen from the operation tests, please explain operating methods as well as maintenance methods to the user (customer) of this equipment, based on the owner's manual.  
Moreover, ask the customer to keep this sheet together with the owner's manual.

### **⚠ WARNING**

- This system should be applied to places as office, restaurant, residence and the like. Application to inferior environment such as engineering shop could cause equipment malfunction.
- Please entrust installation to either the company which sold you the equipment or to a professional contractor. Defects from improper installations can be the cause of water leakage, electric shocks and fires.
- Execute the installation accurately, based on following the installation manual. Again, improper installations can result in water leakage, electric shocks and fires.
- When a large air-conditioning system is installed to a small room, it is necessary to have a prior planned countermeasure for the rare case of a refrigerant leakage, to prevent the exceeding of threshold concentration. In regards to preparing this countermeasure, consult with the company from which you purchased the equipment, and make the installation accordingly. In the rare event that a refrigerant leakage and exceeding of threshold concentration does occur, there is the danger of a resultant oxygen deficiency accident.
- For installation, confirm that the installation site can sufficiently support heavy weight. When strength is insufficient, injury can result from a falling of the unit.
- Execute the prescribed installation construction to prepare for earthquakes and the strong winds of typhoons and hurricanes, etc. Improper installations can result in accidents due to a violent falling over of the unit.
- For electrical work, please see that a licensed electrician executes the work while following the safety standards related to electrical equipment, and local regulations as well as the installation instructions, and that only exclusive use circuits are used.  
Insufficient power source circuit capacity and defective installation execution can be the cause of electric shocks and fires.
- Accurately connect wiring using the proper cable, and insure that the external force of the cable is not conducted to the terminal connection part, through properly securing it. Improper connection or securing can result in heat generation or fire.
- Take care that wiring does not rise upward, and accurately install the lid/service panel. Its improper installation can also result in heat generation or fire.
- When setting up or moving the location of the air conditioner, do not mix air etc. or anything other than the designated refrigerant (R407C) within the refrigeration cycle.  
Rupture and injury caused by abnormal high pressure can result from such mixing.
- Always use accessory parts and authorized parts for installation construction. Using parts not authorized by this company can result in water leakage, electric shock, fire and refrigerant leakage.

### **⚠ CAUTION**

- Execute proper grounding. Do not connect the ground wire to a gas pipe, water pipe, lightning rod or a telephone ground wire. Improper placement of ground wires can result in electric shock.
- The installation of an earth leakage breaker is necessary depending on the established location of the unit. Not installing an earth leakage breaker may result in electric shock.
- Do not install the unit where there is a concern about leakage of combustible gas.  
The rare event of leaked gas collecting around the unit could result in an outbreak of fire.
- For the drain pipe, follow the installation manual to insure that it allows proper drainage and thermally insulate it to prevent condensation. Inadequate plumbing can result in water leakage and water damage to interior items.

# Installation Manual For Indoor Unit

## ⚠ NOTICE

All Wiring of this installation must comply with NATIONAL, STATE AND LOCAL REGULATIONS. These instructions do not cover all variations for every kind of installation circumstance. Should further information be desired or should particular problems occur, the matter should be referred to your local distributor.

## ⚠ WARNING

BE SURE TO READ THESE INSTRUCTIONS CAREFULLY BEFORE BEGINNING INSTALLATION. FAILURE TO FOLLOW THESE INSTRUCTIONS COULD CAUSE SERIOUS INJURY OR DEATH, EQUIPMENT MALFUNCTION AND/OR PROPERTY DAMAGE.

### 1. Before installation [Before finishing installation, do not throw the attached parts installation needs]

- Confirm the way to move the unit to the installation place.
- Before moving the unit to the installation place, do not remove their packages.  
When have to remove the package, use a soft material or protection board with rope to lift the unit assembly to avoid unit damage or bumping a scrape.

### 2. Choose installation place

#### (1) The chosen installation place should meet the following requirements and get the user's consent.

- Place ensures ideal airflow distribution.
- The passage of airflow has no obstacles.
- When importing outside air, it should be imported directly from outdoors. (if the pipe can not be extended, it also can not be imported from top)
- Place ensures enough space for maintenance.
- The pipe length between indoor and outdoor unit is in the permitted limit (referring to outdoor unit installation part).
- The indoor unit, outdoor unit, electric wire and connection wire is at least 1m away from television and radio. This is to avoid the image disturbance and noise caused by the above-mentioned home appliance. (Even if 1m away, if the electromagnetic wave is too strong, it can also cause noise.)

#### (2) The height of ceiling

- The indoor unit can install on the ceiling, which height is no more than 3m.

#### (3) Install and use the hoisting screw. Check if the installation place can bear the weight of unit assembly.

- If not certain, strengthen it before install the unit.

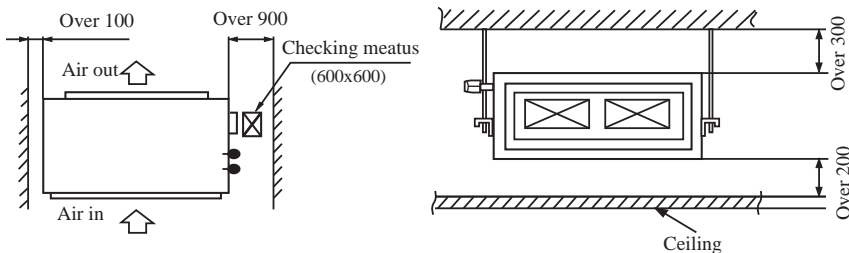

# Installation Manual For Indoor Unit

## 3. Preparation before installation

### (1) The position relation among hoisting screw (unit: mm)

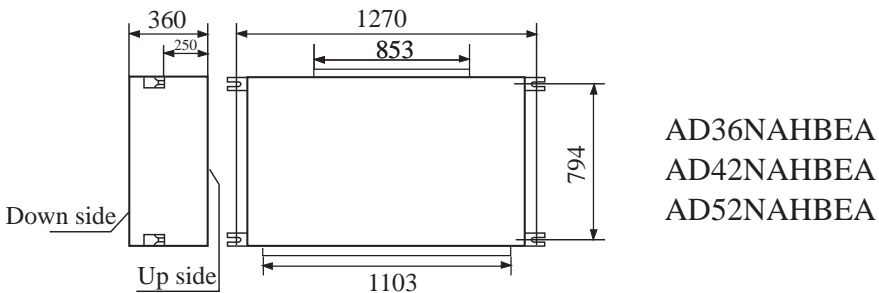
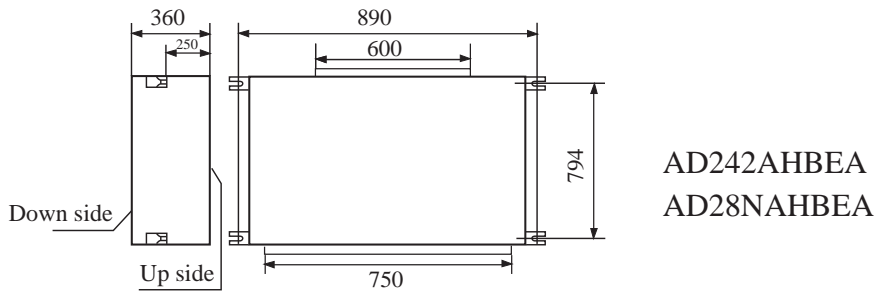

### (2) If necessary, cut the opening installation and checking needed on the ceiling. (If has ceiling)

- Before installation, finish the preparation work of all the pipes (refrigerant, drainage) and wire (wire controller connection wire, indoor and outdoor unit connection wire) of indoor unit, so that after installation, they can be immediately connected with outdoor unit.
- Cut the opening on the ceiling. Maybe it needs to strengthen the ceiling to keep the ceiling even and flat and prevent the ceiling from vibration. For details, please consult to the builder.

### (3) Hanger bolts installation

- Use care of the piping direction when the unit is installed.

(Use M10 screw bolt)

In order to bear the weight of the unit, for existed ceiling, using foundation screw bolt, for new ceiling, using burying embedded screw bolt, burying screw bolt or spot supplied other parts.

Before going on installation, adjust the gaps with ceiling.

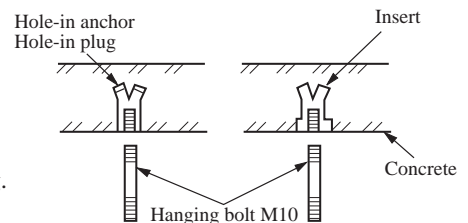

# Installation Manual For Indoor Unit

## 4. Installation of indoor unit

- Fix the indoor unit to the hanger bolts.  
If required, it is possible to suspend the unit to the beam, etc.  
Directly by use of the bolts without using the hanger bolts.

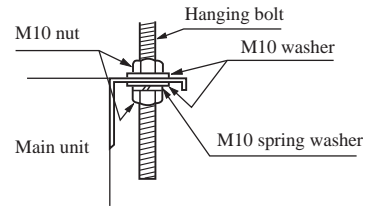

### Note

When the dimensions of main unit and ceiling holes does not match, it can be adjusted with the slot holes of hanging bracket.

### Adjusting to the levelness

- Adjust the out-of levelness using a level or by the following method.
- Make adjustment so that the relation between the lower surface of the unit proper and water level in the hose becomes as given below.

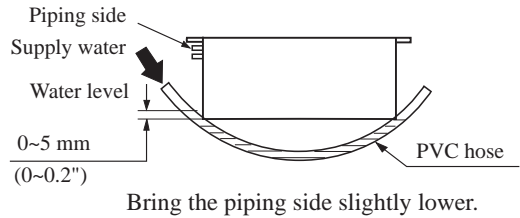

- Unless the adjustment to the levelness is made properly, malfunctioning or failure of the float switch may occur.

## 5. Drain Piping

- Drain piping should always be in a downhill grade (1/50~1/100) and avoid riding across an elevation or making traps.

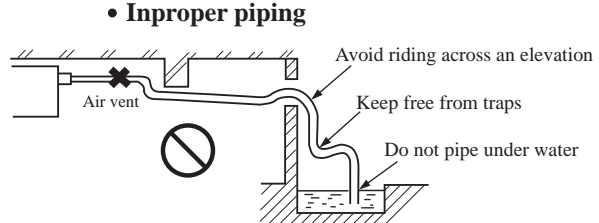
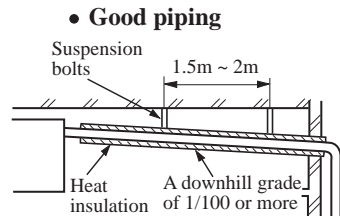

- When connecting the drain pipe to unit, pay sufficient attention not to apply excess force to the piping on the unit side. Also, fix the piping at a point as close as possible to the unit.

- For drain pipe, use hard PVC general purpose pipe VP-25(I.D.1") which can be purchased locally. When connecting, insert a PVC pipe end securely into the drain socket before tightening securely using the attached drain hose and clamp. Adhesive must not be used connection of the drain socket and drain hose (accessory).

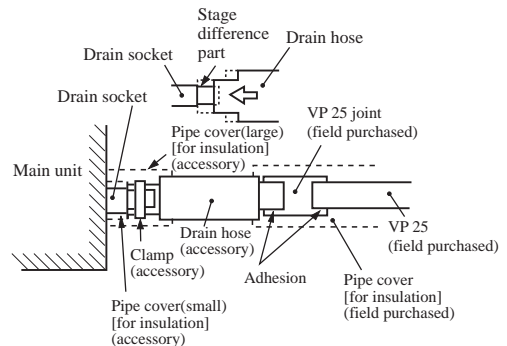



# Installation Manual For Indoor Unit

- (d) When constructing drain piping for several units, position the common pipe about 100 mm below the drain outlet of each unit as shown in the sketch. Use VP-30(1 1/4") or thicker pipe for this purpose.

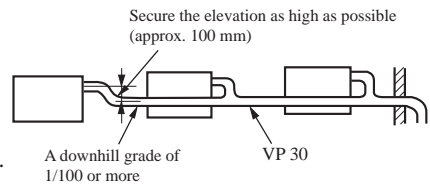

- (e) The stiff PVC pipe put indoor side should be heat insulated.
- (f) Avoid putting the outlet of drain hose in the places with irritant gas generated. Do not insert the drain hose directly into drainage, where the gas with sulfur may be generated.
- (g) Backwater bend  
Because the drain spout is at the position, which negative pressure may occur. So with the rise of water level in the drain pan, water leakage may occur. In order to prevent water leakage, we designed a backwater bend.  
The structure of backwater bend should be able to be cleaned. As the below figure shown, use T type joint.

- As figure shown, set a backwater bend in the middle of drain hose.

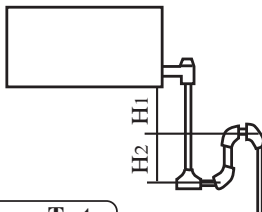

$H1=100\text{mm}$  or the static pressure of air sending motor  
 $H2=1/2H1$  (or between 50~100mm)

## Drainage Test

- ① Conduct a drainage test after completion of the electrical work.
- ② During the trial, make sure that drain flows properly through the piping and that no water leaks from connections.
- ③ In case of a new building, conduct the test before it is furnished with the ceiling.
- ④ Be sure to conduct this test even when the unit is installed in the heating season.

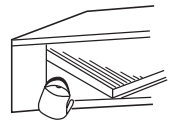

## Procedures

- ① Supply about 1000 cc of water to the unit through the air outlet using a feed water pump.
- ② Check the drain while cooling operation.

## 6. Installation of air suction and discharging duct

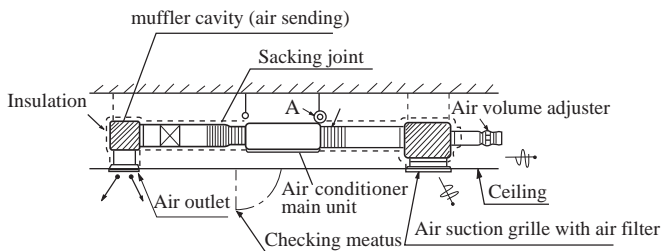

Enlarging chart of profile chart A  
Vibration resistance hook

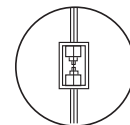

Please consult the after-sales service worker of Haier Air Conditioner for the choosing and installation of suction inlet, suction duct, discharging outlet and discharging duct. Calculating the design drawing and outer static pressure, and choose the discharging duct with proper length and shape.

# Installation Manual For Indoor Unit

- The length difference among every duct is limited below 2:1.
- Reduce the length of duct as possible as can.
- Reduce the amount of bend as possible as can.
- Use heat insulation material to bind and seal the part connecting main unit and the flare part of air discharging duct. Perform duct installation work, before the fitment of ceiling.

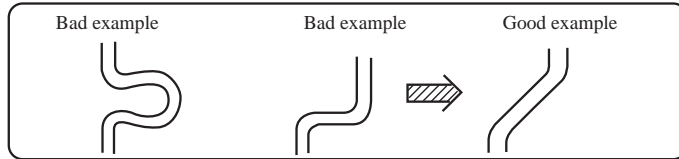

## 7. Calculation method of the dimension of the simple quadrate air duct

Presuming the unit length friction impedance of the duct is 1Pa/m, when the dimension of one side of the air duct is fixed as 250mm, as shown below:

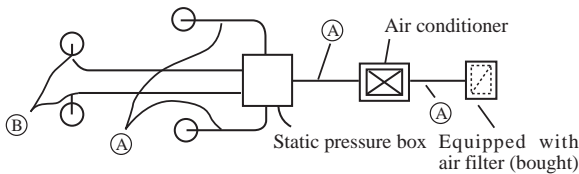

	AD36NAHBEA AD42NAHBEA AD52NAHBEA	AD242AHBEA AD28NAHBEA		
	Air volume	Duct(mmxmm)	Air volume	Duct(mmxmm)
(A)	2400m <sup>3</sup> /h (40m <sup>3</sup> /min)	250x560	1200m <sup>3</sup> /h (20m <sup>3</sup> /min)	250x310
(B)	600m <sup>3</sup> /h (10m <sup>3</sup> /min)	250x190	300m <sup>3</sup> /h (5m <sup>3</sup> /min)	250x120

- The calculation of duct resistance (the simple calculation is as follow table)

Straight part	Calculate as per 1m length 1Pa, 1Pa/m
Bend part	Each bend takes as a3~4m long straight duct
Air out part	Calculate as 25Pa
Static pressure box	Calculate as 50Pa/each
Air inlet grille (with air filter)	Calculate as 40Pa/each

- The chosen chart of simple duct

Note: 1Pa/m=0.1mmAg/m

Air volume Item	Shape	Square duct
	Dimension	
m <sup>3</sup> /h(m <sup>3</sup> /n)		(mmxmm)
100	250 x	60
200	250 x	90
300	250 x	120
400	250 x	140
500	250 x	170
600(10)	250 x	190
800	250 x	230
1,000	250 x	270
1,200(20)	250 x	310
1,400	250 x	350
1,600	250 x	390

Air volume Item	Shape	Square duct
	Dimension	
m <sup>3</sup> /h(m <sup>3</sup> /n)		(mmxmm)
1,800(30)	250 x	430
2000	250 x	470
2400	250 x	560
3,000(50)	250 x	650
3,500	250 x	740
4,000	250 x	830
4,500	250 x	920
5,000	250 x	1000
5,500	250 x	1090
6,000(100)	250 x	1180

# ■ Installation Manual For Indoor Unit

## 8. The attentive matters in installation of air suction and discharging duct

- Recommend to use anti-frost and sound-absorbing duct. (locally bought)
- The duct installation work should be finished before the fitment of ceiling.
- The duct must be heat insulated.
- The specific air-discharging outlet should be installed at the place where the airflow can be reasonably distributed.
- The surface should leave a checking meatus for checking and maintenance.

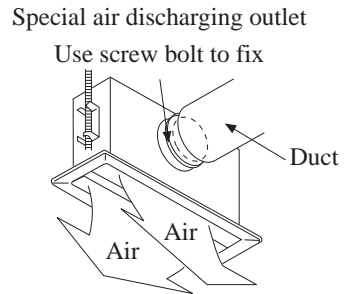

## 9. The examples of improper installation

- Do not use air in duct and take the ceiling inner side instead. The result is because of the irregular outer air mass, strong wind and sunshine, the humidity is increased.
- There may be water drop on the outside of duct. For cement and other new constructions, even if not taking ceiling inner side as duct, the humidity will also be so high. At this time, use glass fiber to perform heat preservation to the whole. (use iron net to bind the glass fiber)
- Maybe exceeding the unit operation limit (for example: when indoor dry bulb temperature is 35°C, wet bulb temperature 24°C), it may lead to overload of compressor.
- Affected by the capacity of air discharging fan, the strong wind in the outer duct and wind direction, when unit air sending volume exceeds the limit, the discharged water of heat exchanger will overflow, leading to water leakage.

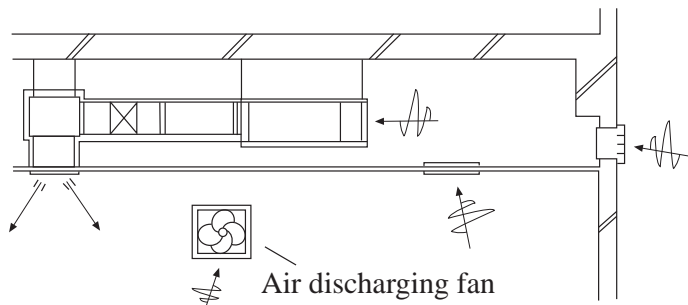

Improper example

# ■ Installation Manual For Indoor Unit

## 10. The operation method of fan controller

Through the fan controller switch in the electric box, the air volume of this unit can be continuously adjusted.

It is unnecessary to adjust air volume through the duct side wind level (unit outside static adjustment).

The air volume set should be in the operation air volume range.

Figure I shows the position of fan controller in the electric box and operation method.

After finishing the electric work, perform test run. According to the main points in Figure II making the chosen switch No. accordant. And confirm if it reaches the needed air volume.

### Note:

- 1) When operating the fan controller, it is possible to touch the electric charging part, so do cut off the power supply.
- 2) Do not set the dial at the position less than 1.
- 3) The figure circled in Figure II indicate the capacity number of fan controller. The non-listed capacity number may exceed the permitted operation capacity range, so it is impossible to operate.
- 4) When delivering from factory, the capacity number of fan controller is set at "No.5".

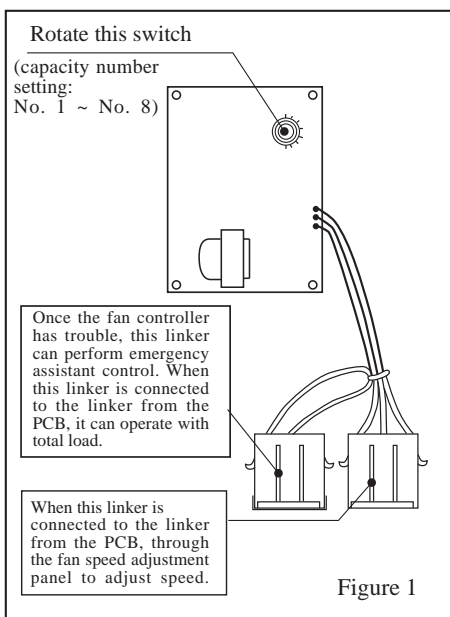

Figure 1

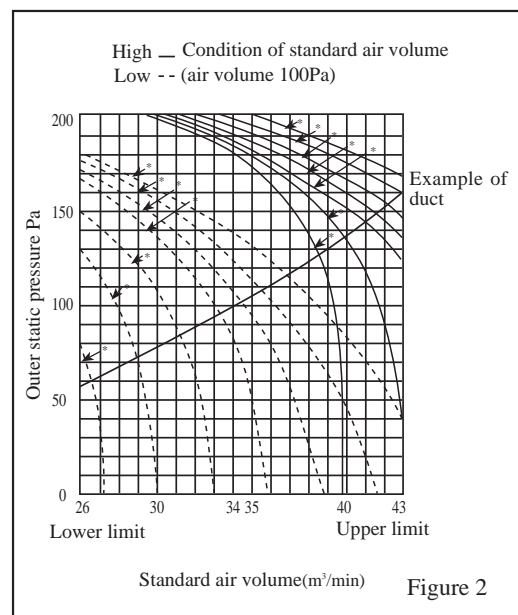

Figure 2

### ● The example of the method of choosing capacity number:

- 1) If the unit is in high-speed operation, needing take outer static pressure is 180Pa in capacity air volume 34m<sup>3</sup>/min as working condition point, according to Figure II "The characteristic chart of air volume", the capacity number of fan controller is No. 2.
- 2) If the unit is in low speed operation, needing take outer static pressure is 60Pa in capacity air volume 32m<sup>3</sup>/min as working condition point, according to Figure II "The characteristic chart of air volume", the capacity number of fan controller is No. 4.

# Installation Manual For Indoor Unit

## 11. Refrigerant pipe

[The air side pipe, liquid side pipe must be faithfully heat insulated, if no heat insulation, it may cause water leakage.]

- The outdoor unit has been charged with refrigerant.
- When connect the pipe to the unit or dismantling the pipe from the unit, please follow the figure shown, use spanner and torque spanner together.
- When connect cone nut, the inner side and outside of cone nut should paste with refrigerant oil. Use hand to twist 3-4 rings, then fasten with spanner.
- Referring to Table I to confirm the fasten torque. (too tight may damage nut leading to leakage)
- Check if the connection pipe leaks, then do heat insulation treatment, as below figure shown.
- Only use seal cushion to bind the pipe joint.

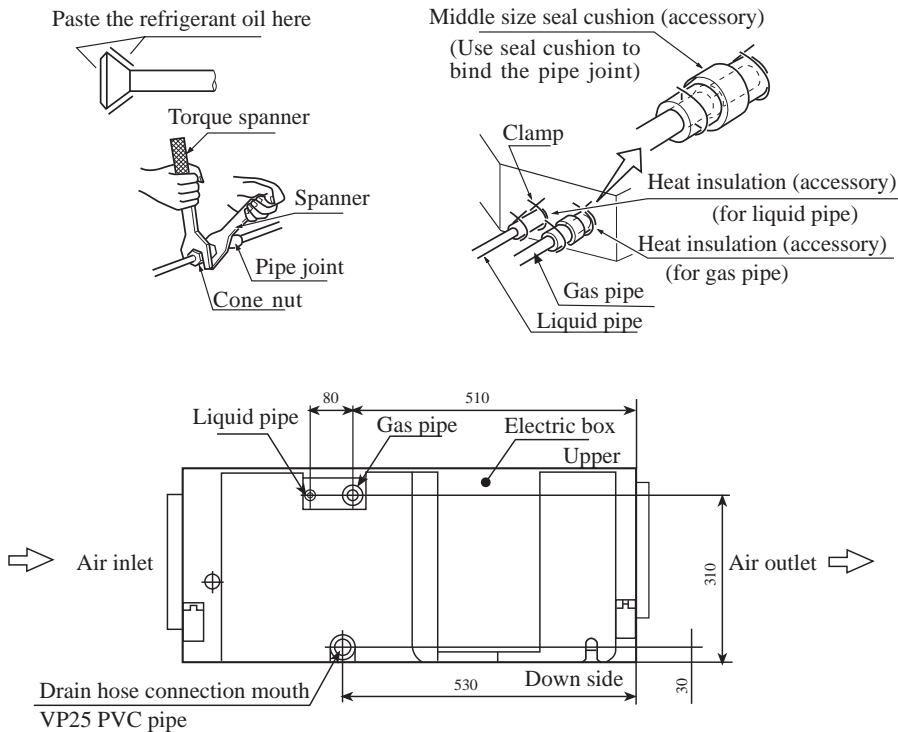

Specification of pipe (mm)	Tighten torque	Cone dimension A (mm)	Cone
Φ 9.52	3270~3990 N·cm (333~407 kgf·cm)	12.0~12.4	
Φ 15.88	6180~7540 N·cm (630~770 kgf·cm)	18.6~19.0	
Φ 19.05	9720~11860 N·cm (990~1210 kgf·cm)	22.9~23.3	

# ■ Installation Manual For Electric Wiring

## 5. Electric wiring

### ⚠ WARNING

**DANGER OF BODILY INJURY OR DEATH**  
 TURN OFF ELECTRIC POWER AT CIRCUIT BREAKER OR POWER SOURCE BEFORE MAKING ANY ELECTRIC CONNECTIONS. GROUND CONNECTIONS MUST BE COMPLETED BEFORE MAKING LINE VOLTAGE CONNECTIONS.

#### (1) Selection of size of power supply and interconnecting wires.

##### Precautions for Electric wiring

- Electric wiring work should be conducted only by authorized personnel.
- Do not connect more than three wires to the terminal block. Always use round type crimped terminal lugs with insulated grip on the ends of the wires.
- Use copper conductor only.

Select wire sizes and circuit protection from table below. (This table shows 20 m length wires with less than 2% voltage drop.)

Item Model	Phase	Circuit breaker		Power source wire size (minimum) (mm <sup>2</sup> )	Earth leakage breaker	
		Switch breaker (A)	Overcurrent protector rated capacity (A)		Switch breaker (A*)	Leak current(mA)
AD28NAHBEA AD36NAHBEA AD42NAHBEA AD52NAHBEA	3	30	20	2.5	30	30
AD242AHBEA	1	40	26	4.0	40	30
<b>AD28NAHBEA</b>	<b>1</b>	<b>40</b>	<b>30</b>	<b>6.0</b>	<b>40</b>	<b>30</b>

#### (2) Wiring connection

Make wiring to supply power to the outdoor unit, so that the power for the indoor unit is supplied by terminals.

AD242AHBEA

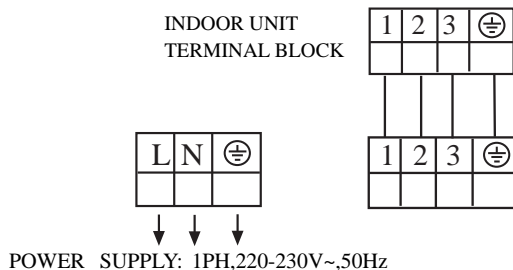

AD28NAHBEA  
 AD36NAHBEA  
 AD42NAHBEA  
 AD52NAHBEA

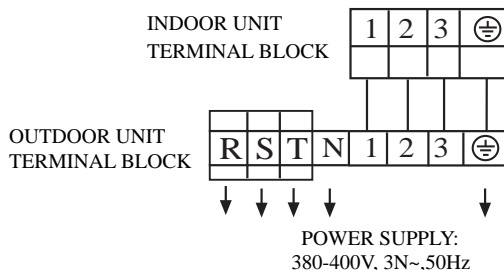

## Free Manuals Download Website

<http://myh66.com>

<http://usermanuals.us>

<http://www.somanuals.com>

<http://www.4manuals.cc>

<http://www.manual-lib.com>

<http://www.404manual.com>

<http://www.luxmanual.com>

<http://aubethermostatmanual.com>

Golf course search by state

<http://golfingnear.com>

Email search by domain

<http://emailbydomain.com>

Auto manuals search

<http://auto.somanuals.com>

TV manuals search

<http://tv.somanuals.com>