

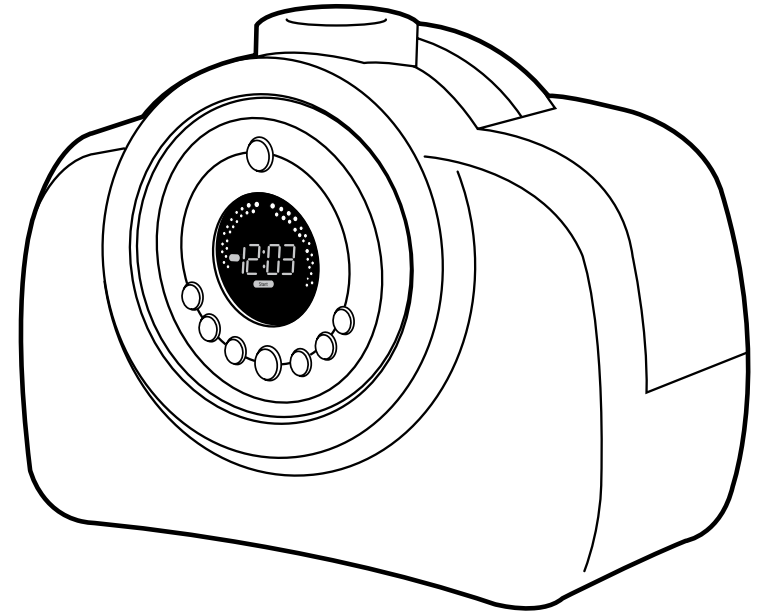

guardian
technologies

USE & CARE INSTRUCTIONS



Ultrasonic Digital Humidifier Remanufactured

Model No. R3010

30-Day Limited Warranty

www.guardiantechnologies.com

1.866.603.5900

English

E - 1

Spanish

S - 1

Date Purchased

month _____

year _____

READ AND SAVE THESE INSTRUCTIONS PRODUCT SPECIFICATIONS AND PARTS

SPECIFICATIONS

Model Number: R3010
Humidifying Mode: Combination
Power Supply: AC120V, 60Hz
Power Consumption: 140W (40W at cool humidification)
Humidity Capacity: About 350 cc/hr. (at highest setting and warm humidification)
Tank Capacity: 1.4 gallons
Successive Humidity Hours: Up to approximately 72-hours depending on environmental conditions
Dimensions: Width 14.5 inches - Height 12 inches - Depth 9 inches
Weight: 8.8 pounds (not including packaging)

PARTS

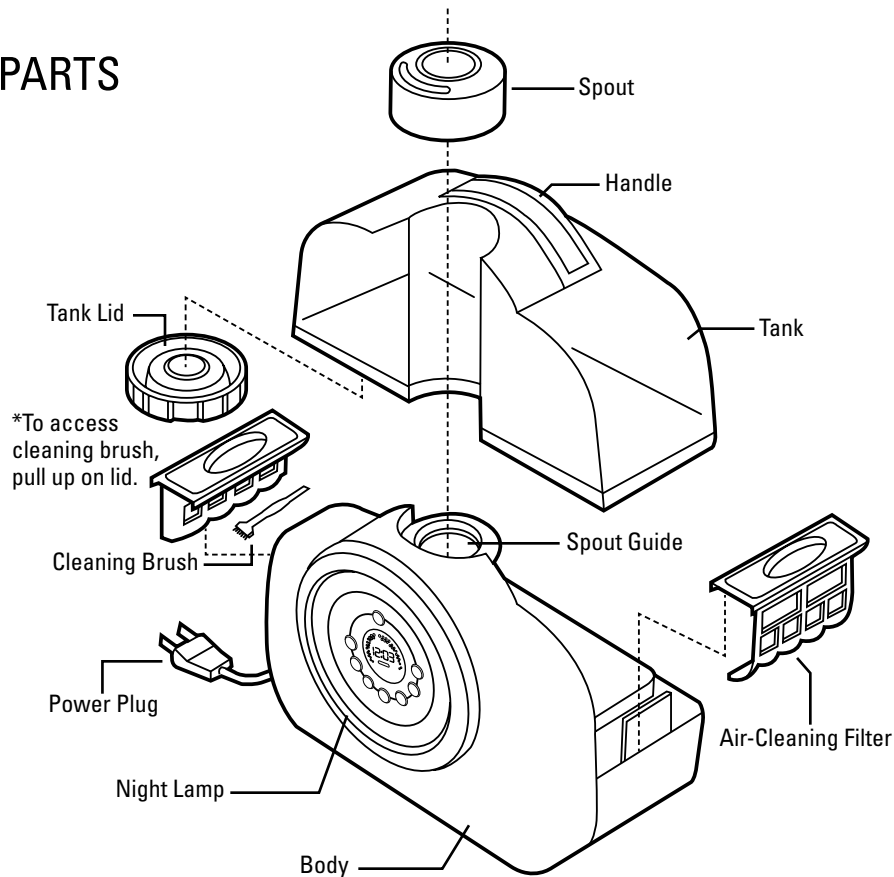

READ AND SAVE THESE INSTRUCTIONS CONTROL PANEL BUTTON FUNCTIONS

Night Light/Lamp

Provides a soft ring of blue light with ON/OFF switch.

Select/Set

Change between programming mode and normal mode.

Hour

Select the hour for timer start/off or clock (actual time).

Minute

Select the minute for timer start/off or clock (actual time).

Power

Turns humidifier on/off for normal usage and programming mode.

Warm or Cool Mist Selection

Select humidifying temperature based on need. Warm humidity will use more power but will humidify your room quicker.

Spray Control

Adjusts spray between low, medium, high and turbo.

Display On/Off

Turns off display lights.

Water Shortage Indicator

When the unit is low on water the Refill LED on the front panel will light up, and the unit will shut off. Simply add more water to continue use.

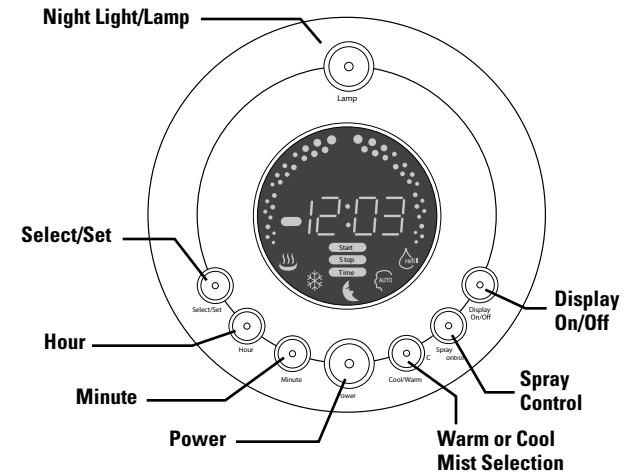

ADDITIONAL FEATURES

Silver Clean Technology

Small silver particles have been added to the water tank to help fight the growth of mold and mildew on the surface of the water tank.

Silent Operation

Uses ultrasonic technology for quiet operation while you sleep.

READ AND SAVE THESE INSTRUCTIONS

WARNINGS



This product should be used only in accordance with the specifications outlined in this manual. Usage other than what has been specified here may result in serious injury.

- Disassembly, repair or remodeling by an unauthorized person may result in serious harm.
- Do not use if plug is damaged or loose.
- Keep this product out of the reach of children and away from pets.
- Be careful not to put water in the humidity spout.
- Before filling or cleaning the unit, make sure it is unplugged.
- Once the humidifier has been turned on, do not move it.
- Do not move when in operation.
- Do not remove the water tank from the unit while it is on.
- Do not handle the adapter plug with wet hands.
- Do not excessively bend, twist or pull the power cord.
- Avoid placing this product where the humidity is pointed directly at an electrical object.
- Do not directly inhale the humidity.
- Do not place this product on a sloped or unstable surface.
- When not in use, unplug the unit.
- Do not fill the water tank with hot or boiling water.
- Do not use this product in direct sunlight, or near a gas stove or heater.
- Do not use if the water tank becomes cracked or damaged.
- Do not keep this product running for an extended period of time.
- Do not clean the unit or water tank with detergents or chemicals of any kind.
- Do not use this product near any other electronic device.
- Do not cover the humidity opening at any time during use.
- Do not use this product near a sink.
- Do not drink water from the water tank.
- Do not place this product on an absorbent surface.
- Do not pour anything but water into the water tank.

Failure to comply with the warnings listed above may result in electric shock or serious injury.

DIRECTIONS FOR USE

Make sure the unit is unplugged.

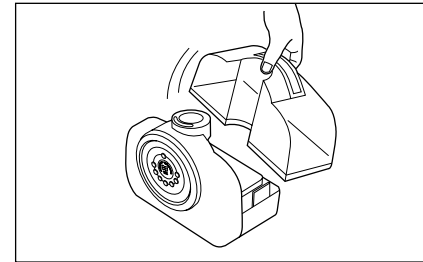

1. Separate the tank from the body of the unit.

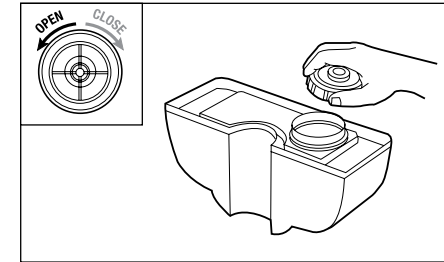

2. Open the tank lid, turning it to the left.

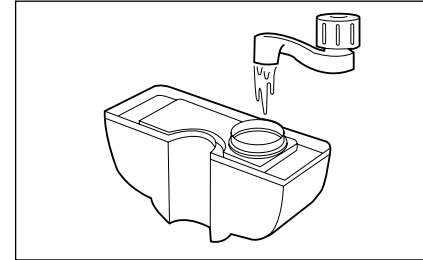

3. Pour cool, clean water directly into the tank. Do not pour anything but water into the water tank.

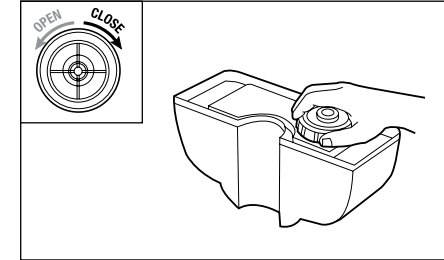

4. Close the tank lid, turning it to the right.

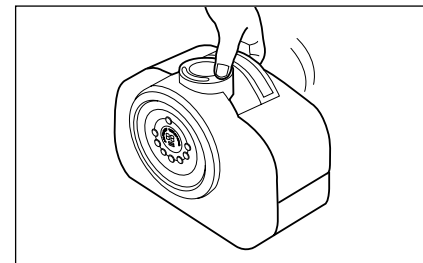

5. Attach the tank to the body of the unit.

DIRECTIONS FOR USE IN NORMAL MODE (NO TIMER)

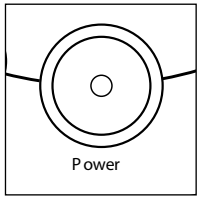

1. Power Button

Before turning on make sure there is water in the unit.
Press the Power Button.

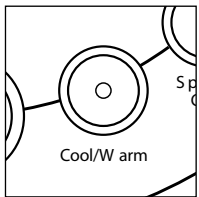

2. Warm or Cool Mist Button

Press to select warm or cool mist. Water temperature is maintained at room temperature for cool setting and 80 degrees for warm.

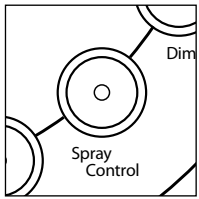

3. Spray Control Button

When you press the Spray Control Button there are four options to choose from:

- Press once for **WEAK**
- Press twice for **MIDDLE**
- Press three times for **STRONG**
- Press four times for **TURBO**



***You will notice the lights get higher as the spray increases.**

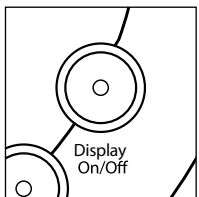

4A. Light Options - Display Button

Press the Display Button to turn the display lights ON or OFF.

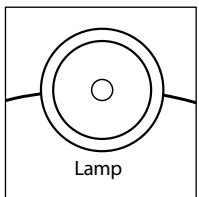

4B. Light Options - Night Light Feature

Press the Lamp Button at the top of the unit to illuminate the night light feature.



5. Water Refill Button

When the Water Refill Button lights up it is time to refill the water tank.

DIRECTIONS FOR USE IN PROGRAMMABLE MODE

The programmable mode allows you to set the timer to turn the humidifier both on/off at a daily predetermined time. This mode also allows the clock to be programmed.

FIRST TURN POWER BUTTON ON.

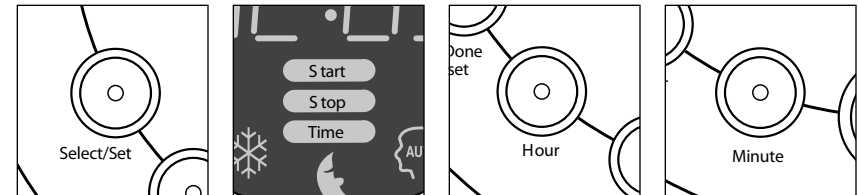

Program Start

1. Push Select/Set Button until "START" is blinking on display.
2. While "START" is blinking, select the desired start time using Hour and Minute buttons (AM or PM as indicated).
3. Select Cool/Warm preference.
4. Select Spray Control preference.
5. "START" indicator will remain lit once programmed.

Program Stop

1. Push Select/Set Button until "STOP" is blinking on display.
2. While "STOP" is blinking, select the desired end time using Hour and Minute buttons (AM or PM as indicated).
3. "STOP" indicator will remain lit once programmed.
4. To cancel program, press and hold select/set button for two seconds (START and STOP buttons will not be lit).

Clock Set

1. Clock must be set in order for timer to work properly.
2. Push Select/Set Button until "TIME" is blinking on display.
3. Select actual time using Hour and Minute Buttons (AM or PM as indicated).

MAINTENANCE

- Always unplug the unit before servicing it in any way.
- The temperature of the water remaining in the unit after use may be HIGH.
- Do not submerge the unit in water, or allow water to enter anywhere on the unit except the designated water tank.

INSIDE THE BODY OF THE UNIT

Pour excess water out of the unit, but do not allow it to enter the hole where the water vapor comes out. Wash out the unit with fresh water, using the cleaning brush and a soft cloth as needed.

OUTER SURFACE OF THE UNIT

Wipe the surface of the unit with a soft, damp cloth if needed.

WATER TANK

If water spots remain in the water tank, wipe the inside with a soft cloth. DO NOT use soap or detergents.

AIR FILTER

Gently wipe away debris from the filter with a soft cloth. This filter does NOT need to be replaced.

ULTRASONIC DISK

Remove spray spout (Fig. 1) and use the enclosed cleaning brush to regularly remove build up and deposits from this area (Fig. 2). Diluted vinegar will help to prevent this build up.

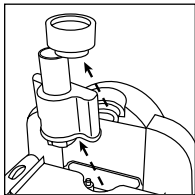

Fig. 1

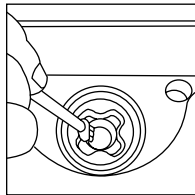

Fig. 2

STORAGE

- Fully dry the inside and outside of the unit before storing it.
- DO NOT leave water in the unit.
- Store in a cool, dry place.

TROUBLESHOOTING GUIDE

| PROBLEM | SOLUTION |
|--------------------------------------------|-----------------------------------------------------------------------------------------------------------------------------------------------------------------------------------------------------------------------------------|
| Water vapor & humidity are not produced. | Power Plug: Unplug and then try again. Power Failure: When the power is returned, try again. Tank Installation: Make sure the water tank is correctly attached. Make sure spring on tank cap moves freely when pushed. |
| Air blows but water vapor is not produced. | Excessive Water: Remove a certain amount of water from the tank. The desired humidity is lower than the current temperature: Increase the desired humidity. Detergent residue in the tank: Wash the tank out and try again. |
| Humidity level is low. | The surface of the ultrasonic metal disk may be dirty: Wipe it off with a dry, soft cloth. Clean with diluted vinegar. The water in the unit is too cold: Replace with cool, but not cold water. |
| Warm humidity is not produced. | It may take 10-15 minutes before warm humidity is created. The mist may not feel warm to the touch. Check to see if base of unit feels warm to the touch. If so then warm mist is being produced. |
| The humidity has a bad smell. | Poor maintenance or dirty water: Clean the product thoroughly, and fill it with fresh water. |
| White dust is forming on nearby furniture. | Hard water will deposit a certain amount of dust. Dust in the air settles because of the added humidity in the room. *Use distilled water if this becomes a nuisance. |

Free Manuals Download Website

<http://myh66.com>

<http://usermanuals.us>

<http://www.somanuals.com>

<http://www.4manuals.cc>

<http://www.manual-lib.com>

<http://www.404manual.com>

<http://www.luxmanual.com>

<http://aubethermostatmanual.com>

Golf course search by state

<http://golfingnear.com>

Email search by domain

<http://emailbydomain.com>

Auto manuals search

<http://auto.somanuals.com>

TV manuals search

<http://tv.somanuals.com>