

GRACO®

Infant Car Bed

Child Restraint System

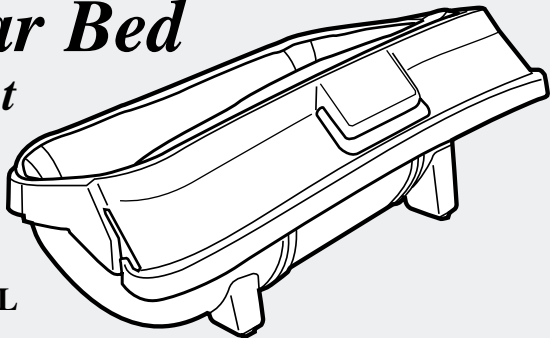

OWNER'S MANUAL
Model 8403

⚠ WARNING

Your child's safety depends on you installing and using this car bed correctly. **READ THIS MANUAL!** Return this manual to the storage pocket provided on the underside of the car bed for quick reference.

© 1999 Graco 403-9-99 IS1904

Table of Contents

1. Important Safety Information	4-8
1.1 About Your Child	4
1.2 About Using this Car Bed in Your Vehicle.....	5
1.3 About Airbags	6
1.4 When the Car Bed is Not Occupied	7
1.5 About the Life and Condition of this Car Bed	7-8
1.6 When the Car Bed is Not in the Vehicle	8
2. Choosing a Suitable Location for the Car Bed	9-17
2.1 Some Basic Requirements	9-10
2.2 Be Sure Your Vehicle Seat Meets All of These Requirements	11
2.3 Consider Accident Statistics and Information about Airbags	12
2.4 Be Sure Your Vehicle Seat Belt is Safe to Use	13-18
A. Seat Belt Systems that are NOT Safe for Use with the Car Bed ...	13-15
B. Seat Belt Systems that are Suitable for Use with the Car Bed	16-17
3. Features and Components of the Car Bed	18
4. Positioning and Securing Your Child in the Car Bed	19-22
5. Securing the Car Bed in Your Vehicle	23-29

6. Cleaning and Maintenance	30-33
7. Registering Your Car Bed	34

Contacting Graco

Our goal is to make every product the best it can be! We are also committed to supporting our products after purchase. If you would like to speak to Graco about your product, please call our **Customer Service Department at 1-888-224-6549** or visit our Internet website, www.gracobaby.com. Our knowledgeable staff is ready to answer any questions you may have concerning parts, use or maintenance. When you call, please have the model and serial numbers ready so your call may be processed quickly and efficiently.

**Keep this manual in the storage pocket
located on the underside of the car bed.**

1. Important Safety Information

No child restraint can guarantee protection from injury. However, proper use of this car bed reduces the risk of serious injury or death to your child in the event of a sharp turn, sudden stop or crash.

Do not install or use this car bed until you read and understand the instructions in this manual and in your vehicle owner's manual. Do not let others install or use the car bed unless they understand how to use it.

1.1 About Your Child

- Premature and/or low birth weight infants usually have special medical needs. Consult your doctor about how to transport your child and about their need for supervision.
- This car bed is designed for use only by children who weigh 9 lbs. (4.1 kg) or less and whose height is 20 inches (51 cm) or less. Using this car bed with a child who is heavier than 9 lbs. or more than 20 inches in height may increase the risk of serious injury or death. Once your child outgrows the car bed, consult with your physician about transferring the child into a rear-facing safety seat or another special needs product for a larger child.
- **NEVER LEAVE YOUR CHILD UNATTENDED.**

1.2 About Using this Car Bed in Your Vehicle

- Your child can be injured in a vehicle even if you are not in a crash. More common events such as sudden braking and sharp turns can injure your child if the car bed is not properly installed or if your child is not properly secured in the car bed.
- Do not place apnea monitors, oxygen tanks, or other medical equipment inside the car bed. Keep this equipment outside of the car bed, secured under the seat or on the floor. If not secured, it can be thrown around and may injure occupants in the event of a sharp turn, sudden stop or crash.
- There are many kinds of vehicles, seat belt systems, and occupant protection systems. As a result, it is not possible for this manual to tell you everything you need to know about putting this car bed in your vehicle. You must carefully follow the instructions provided by the vehicle owner's manual as well as the information in this manual.
- Some vehicles do not have **any** safe location for this car bed, and many vehicles have seat belt systems that must not be used with the car bed because those systems will not safely hold the car bed in place. Again, you must refer to both this manual and your vehicle owner's manual.
- This car bed conforms to all applicable Federal Motor Vehicle Safety Standards.
- This Restraint is certified for use in Motor Vehicles. This Restraint is not certified for use in aircraft.

1.3 About Airbags

- With some child restraint systems, such as rear-facing infant seats, an inflating airbag can strike the child restraint and kill or seriously injure a child.

With regard to this car bed and airbags, our tests and investigations indicate that an inflating airbag will not strike a properly installed car bed and result in serious injury or death. Presently, Graco is not aware of any airbags that will strike a properly installed car bed and injure a child. However, airbags offer no benefit to children in car beds. Also, airbag designs are changing rapidly, and it is impossible to say that new designs will not present a risk of injury or death to a child in a car bed.

As a result, before placing the car bed in a seating location that has an airbag, consider the following:

- Most rear seats do not have airbags, and according to accident statistics, children are safer when properly restrained in rear vehicle seating positions rather than front seating positions.
- Always follow the recommendations of your vehicle manufacturer. See your vehicle owner's manual and/or contact your vehicle manufacturer for more information about using this car bed in a seating location that has an airbag.
- To avoid any possibility of injury from an inflating airbag, place the car bed in a seating location that does not have one.

1.4 When the Car Bed is Not Occupied

- The surface of the car bed can become very hot if the car bed is left in the sun. Contact with these parts can burn your child's skin. Cover the car bed with a blanket if it will be exposed to the sun, and always check the surface of the car bed before putting your child in it.
- Never leave a car bed unsecured in your vehicle. An unsecured car bed can be thrown around and may injure occupants in the event of a sharp turn, sudden stop or crash.

1.5 About the Life and Condition of this Car Bed

- Replace this car bed with a new car bed after an accident of any kind. An accident can cause damage to the car bed that you cannot see.
- After your child has outgrown the car bed, or has moved on to a rear-facing infant restraint, discard the car bed. Never give this car bed to someone else. Destroy the car bed and place it in a garbage bag to assure that it will not be reused.
- Do not use the car bed after the expiration date stamped on the bottom of the car bed shell.
- Do not modify your car bed or use any accessories or parts supplied by other manufacturers.

- Never use the car bed if it has damaged or missing parts. Do not use a cut, frayed or damaged car bed harness. You can order a new harness by calling **1-888-224-6549**.

1.6 When the Car Bed is Not in the Vehicle

To avoid injury or death from suffocation, falls and other hazards:

- Always secure child in harness straps whenever child is in the car bed.
- When carrying the car bed, use the handles at both ends of the car bed as shown.
- Always place the car bed on a firm and level surface. Never place the car bed on soft or plush surfaces that may allow the car bed and infant to roll over. If the car bed tips over, your child can suffocate.
- Do not place car bed near the edge of surfaces such as tables or counters. To prevent falls, stay within arm's reach whenever the car bed is not on floor/ground.
- Never leave child unattended while child is in car bed.

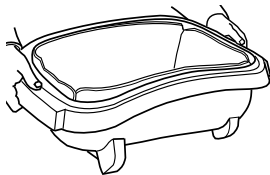

2. Choosing a Suitable Location for the Car Bed

WARNING

Some seating positions in your vehicle are not safe locations for this car bed. For example, none of the seats on the driver's side of the vehicle are safe for this car bed.

In addition, there may be some vehicles that do not have **any** seating positions that can be used safely. Improper placement of the car bed increases the risk of serious injury or death.

Follow the instructions in this section and in your vehicle owner's manual to select a location for the car bed. If you are not sure where to place the car bed in your vehicle, contact your vehicle manufacturer or Graco Children's Products Inc., **1-888-224-6549**.

2.1 Some Basic Requirements

To reduce the risk of head and neck injuries in the event of a crash, your child's **head** must be positioned as close to the center of the car as possible, and never next to a door or the side of the vehicle.

- Never place the car bed on the driver's side of a vehicle (seats **A** and **B**) **1**.

Only the center and passenger side seating positions (**C**, **D**, **E**, **F** and **G**) are potential locations for this car bed if all other requirements are met.

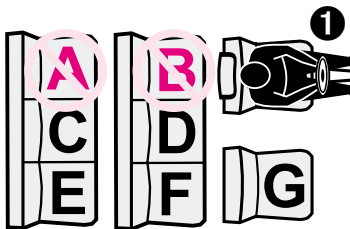

- The car bed must be positioned so that the child's head is near the center of the vehicle.

This means that when the car bed is properly installed, your child's feet will always be toward the passenger side of the vehicle **2**.

- Whenever possible, keep the seat next to the child's head clear of passengers or any objects, such as child restraints, boxes, groceries, monitors, etc.

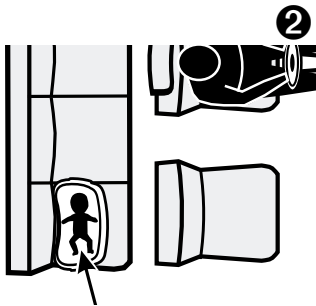

Feet toward
passenger side
of vehicle

2.2 Be Sure Your Vehicle Seat Meets All of These Requirements

- **THE VEHICLE SEAT MUST FACE FORWARD.** Do not place car bed in a rear-facing vehicle seat ❸ or a side-facing vehicle seat ❹.

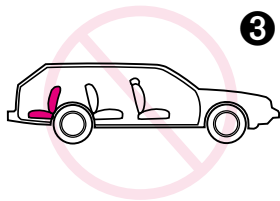

- Only use this car bed on vehicle seats with seat backs that lock in an upright position. Do not use seats that can fold down without having to release a lock or latch of some kind. These seats can fly forward and strike the child in a sudden stop or crash.

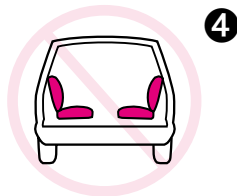

- See your vehicle owner's manual or contact the vehicle manufacturer to make sure the vehicle manufacturer permits child restraint use in the location that you select.

2.3 Consider Accident Statistics and Information about Airbags

- According to accident statistics, children are safer when properly restrained in rear vehicle seating positions, rather than in front seating positions.
- Before placing the car bed in a seating location with an airbag, read section 1.3 on page 6.

2.4 Be Sure Your Vehicle Seat Belt is Safe to Use

WARNING

Many seat belt systems are NOT safe to use with this car bed, even though they can easily be routed around the car bed and look similar to other seat belts that are safe to use.

Carefully read this section for information on seat belt systems and also refer to your vehicle owner's manual and any labels on your vehicle's seat belt. If you are unsure whether your seat belts are safe to use with the car bed, contact the vehicle manufacturer or call Graco at **1-888-224-6549**.

A. Seat Belt Systems that are NOT Safe for Use with the Car Bed

DO NOT use the following types of vehicle belt systems with your car bed. They will not hold the car bed securely in place. The metal locking clip provided with this product will NOT make any of these seat belts safe.

- **DO NOT** use a lap belt that stays loose and can move until it locks in a crash or sudden stop. This belt has an Emergency Locking Retractor, E.L.R. It is often seen in combination with a motorized shoulder belt. Since these lap belts will loosen if pulled on slowly, the car bed may shift to an unsafe position. This seat belt will NOT safely restrain the car bed ❶. However, you may be able to convert your E.L.R. belt to one that is safe to use. See your vehicle owner's manual for more information or contact your vehicle manufacturer.

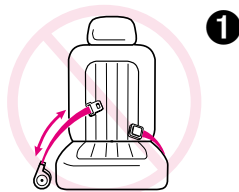

- **DO NOT** use a lap/shoulder combination belt where each strap has a retractor at one end and is attached to the latchplate at the other end of the belt. This seat belt will NOT safely restrain the car bed ❷.

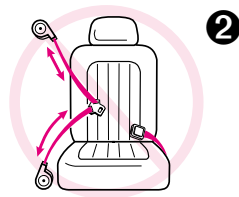

- **DO NOT** use a seat belt that is attached to the door in any way. This type of belt is designed to open with the door and automatically surround the passenger when the door is closed. This seat belt will **NOT** safely restrain the car bed **3**.

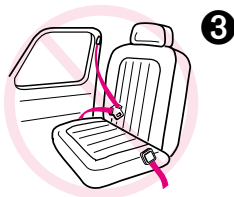

- **DO NOT** use a seat belt that is anchored forward of the seat crease. This seat belt will **NOT** safely restrain the car bed **4**.

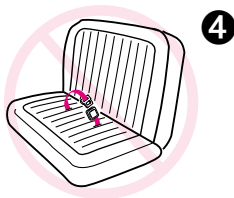

- **DO NOT** use a shoulder belt that moves along a track to automatically surround the passenger when the door is closed. This seat belt will **NOT** safely restrain the car bed **5**.

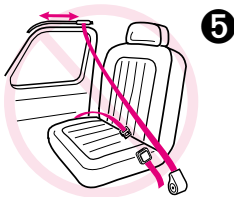

If you have one of the above seat belt systems, do not use it to secure the car bed. Look for a vehicle seat location that has a suitable seat belt (see the next section) or contact your vehicle manufacturer about installing a seat belt system that can be used to secure the car bed.

B. Seat Belt Systems that are Suitable for Use with the Car Bed

The following vehicle belt systems can be used with your car bed, if the seat location meets all other requirements of these instructions and the requirements in your vehicle owner's manual.

- **Lap belt that is manually adjusted and stays tight.** This type of seat belt is tightened by pulling on the excess belt once it is buckled. This type of seat belt is most often found in rear center seating positions **1**.

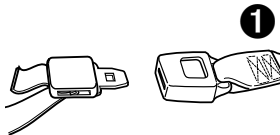

- **Lap belt that cannot lengthen once it is buckled.** This belt has an automatic locking retractor (A.L.R.) that does not allow the seat belt to lengthen without unbuckling the belt and starting over **2**.

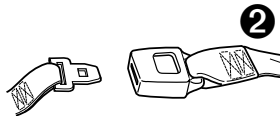

- **Lap/shoulder combination belt with a locking latchplate.** Once it is buckled, this type of belt has a latchplate that will not allow the lap portion of the belt to loosen. This seat belt does not require a locking clip ③.

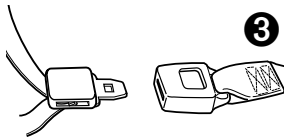

- **Lap/shoulder combination belt with a latchplate that can slide freely along the belt.** This type of belt **MUST** be converted to prevent movement of the lap portion of the belt. You must use the locking clip provided with the car bed, unless your vehicle's seat belt can be converted in another way that is described in your vehicle owner's manual. Failure to use the locking clip or convert the seat belt in another way will allow the car bed to move out of position. See your vehicle owner's manual or contact your vehicle manufacturer for more information ④.

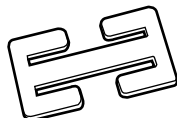
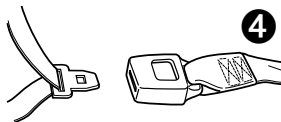

Locking clip

3. Features and Components of the Car Bed

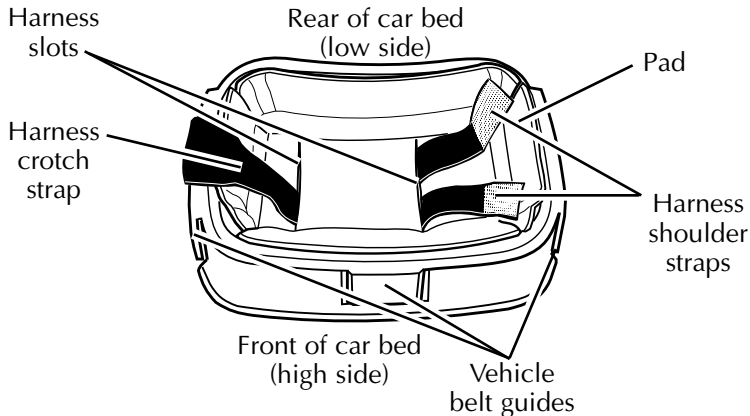

Locking Clip

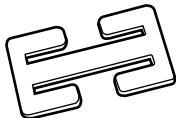

The locking clip is stored at the rear of the car bed. You will need to use it with certain types of vehicle seat belts.

4. Positioning and Securing Your Child in the Car Bed

Premature and/or low birth weight infants have special medical needs that will influence how your child should lay in the car bed. This car bed is designed so babies can lay on their backs or on their sides. Under certain circumstances, it may be preferable to have babies lie on their stomachs. Consult your doctor about how your child should be positioned for travel. If it is necessary for your child to lie on their stomach, never use additional padding or blankets in the head area or near the baby's face. Always watch your baby closely.

WARNING

Failure to properly position and secure your child in the car bed increases the risk of serious injury or death in the event of a sharp turn, sudden stop or crash. Even when the car bed is not in a vehicle, secure your child with the harness.

In a crash, the car bed provides NO protection for your child unless the harness straps are properly secured.

Follow these instructions carefully to properly position and secure your child.

1. Make sure that your child is dressed in appropriate clothing which:
 - a. Allows the crotch strap to pass through your child's legs.
 - b. Keeps the shoulder straps on your child's shoulders.

If a blanket is used for additional warmth, it must be placed outside the harness straps and tucked around your child. Make sure no blankets or other articles cover the ventilation holes in the pad.

2. If your child is to lie on their back or stomach, slide the harness along the harness slots toward the low side of car bed ❶. If your child is to lie on their side, slide harness to the high side ❷. In either position, adjust harness straps so the bottom of the "U" where shoulder straps join is at the edge of the harness slot ❸.
3. Inspect the harness straps to be sure they are clean. Dirty, lint-filled harness straps may not hold your child securely. See the Cleaning and Maintenance section (page 30) for more information on cleaning the harness.

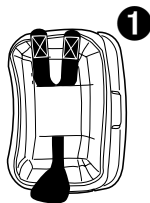

Lying on back



Lying on side



Bottom of "U"

- Place your child in the car bed so child's head is at the end with the ventilation slots. Refer to label on the front of the car bed.
(The illustrations below show child laying on back. Your child may need to lay in a different position depending on your doctor's instructions.)
- Position your child's shoulders at harness slot opening ④.
- Bring the crotch strap between your child's legs ⑤. Check that crotch strap does not extend into baby's neck and chin area. If it does, reposition the harness according to step 2.
- Wrap one shoulder strap over your child's shoulder ⑥. Press the shoulder strap and crotch strap together. Then wrap second strap over the other shoulder, and press onto first shoulder strap and crotch strap ⑦.

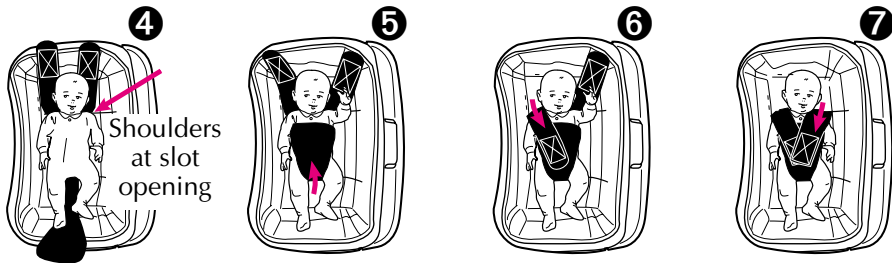

8. Check that harness straps are not twisted. Twisted straps can create slack in the harness and reduce the protection provided by the car bed.
9. To be sure the straps are secure, pull up on the harness where the crotch and shoulder straps meet **1**.
10. Check that harness is snug on your child's shoulders. You should not be able to insert more than one finger between the harness and your child's shoulders **2** **3**.

**1**

Child
on
back

**2**

Child
on
side

**3**

Failure to keep the harness straps flat (not twisted) and snug on your child's shoulders increases the risk of serious injury or death.

5. Securing the Car Bed in Your Vehicle

There are many kinds of vehicles, seat belts, and occupant protection systems. As a result, it is not possible for this manual to tell you everything you need to know about putting this car bed in your vehicle. You must carefully follow the instructions provided by your vehicle manufacturer, as well as the information in this manual. Before proceeding, be sure you have read and understood section 2.4 (page 13) about safe and unsafe seat belt systems.

WARNING

Failure to properly secure the car bed within the vehicle increases the child's risk of serious injury or death in the event of a sharp turn, sudden stop or crash.

Carefully follow these instructions and those in your vehicle owner's manual to be sure your car bed is properly located, positioned, and held tightly at all times.

Preparation and Initial Safety Checks

1. Make sure you have selected a suitable location for the car bed as explained in section 2 (page 9). Remember not to place child on the driver's side, and remember to position child so feet are toward the passenger side of the vehicle.
2. If a front passenger seat is used, slide the vehicle seat rearward as far as possible from the dashboard.
3. Be sure that the vehicle seat back is locked in position. Do not use seats that can fold down without having to release a lock or latch of some kind.
4. Place the car bed on the vehicle seat so that:
 - a. All four of the car bed's feet are resting on the vehicle seat **1**, and
 - b. The car bed is against the vehicle seat back.

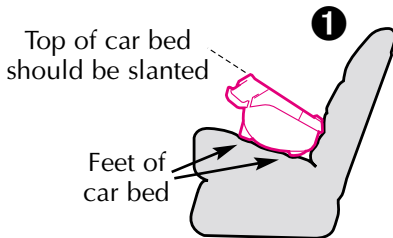

5. Thread the seat belt through all three guides as shown for a lap-only belt **2** and for a lap/shoulder belt **3**. There is no need to thread the shoulder portion of the belt through the three guides.

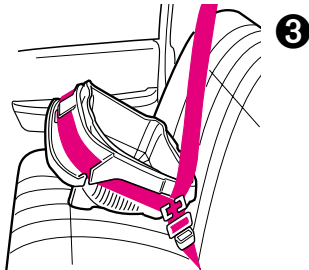
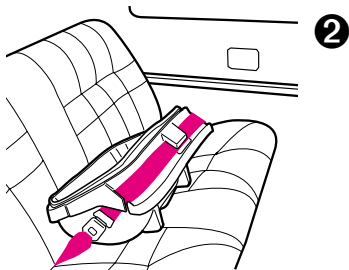

6. Buckle the seat belt. Make sure the buckle tongue goes into the correct buckle, and not the adjacent one **4**. **The seat belt should not be twisted or turned.**

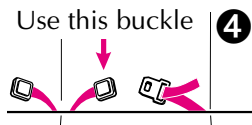

7. Some seat belts in the center rear seating position may be too short to fit around the car bed. **DO NOT** use a belt extender. Move the car bed to another seating position on the passenger side of the vehicle.

8. Now the vehicle seat belt must be tightened.

When tightening the seat belt around the car bed, make sure there is no slack on either side of the car bed or along the belt path.

To create a very tight installation, first remove your child from the car bed. Push down hard with one hand in the middle of the car bed while pulling on the vehicle belt with the other hand to tighten it ❶.

- If you have a lap-only belt, go to step 9.
- If you have a lap/shoulder combination belt, go to step 10.



9. Tightening a lap-only belt:

- An **automatically adjusted lap belt** ❷ is tightened by feeding the seat belt back into its retractor while pushing down hard on the car bed. Make sure that the seat belt is locked in place and very tight.

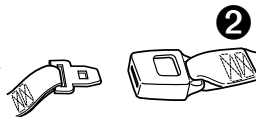

- A **manually adjusted lap belt ③** is tightened by pulling on the excess belt while pushing down hard on the car bed. However, you may have trouble tightening the belt because of the upright angle at which you must pull. You may have to unbuckle the seat belt, estimate a seat belt length that will make the seat belt very tight, then buckle it again.

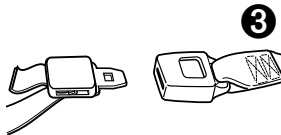

10. Tightening a lap/shoulder combination belt:

- A **lap/shoulder combination belt with a locking latchplate ④** is tightened by pulling hard on the shoulder portion of the seat belt while pushing down hard on the car bed. However, you may have trouble tightening the belt because of the upright angle at which you must pull. You may have to unbuckle the seat belt, estimate a seat belt length that will make the seat belt very tight, then buckle it again.

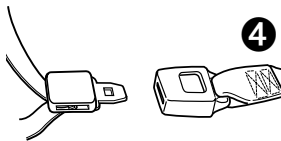

- A lap/shoulder combination belt with a latchplate that can slide freely along the belt ❶ requires the locking clip, unless your vehicle's seat belt can be converted in another way, described in your vehicle owner's manual. See your vehicle owner's manual to find out if your seat belt can be converted to prevent movement of the lap portion of the belt. Otherwise, the locking clip **MUST** be used.

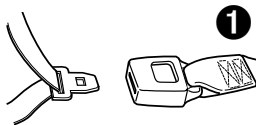

To install the locking clip:

- Tighten the buckled seat belt by pushing down hard on the car bed and pulling hard on the shoulder belt.
- While continuing to push down on the car bed, let go of the shoulder strap and pinch the two straps together just behind the buckle tongue.
- While still pinching the straps together, unbuckle the seat belt. Do not allow the straps to slip.
- Connect the lap belt to the shoulder belt by placing the locking clip on the belts about $\frac{1}{2}$ inch from the buckle tongue as shown ❷.
- Re-buckle and pull hard on the lap belt to be sure it does not move.
- Repeat this procedure if the lap belt is loose or lengthens when pulled.

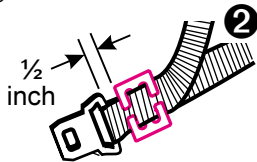

Final Safety Checks

11. Make sure child is secured with the harness according to section 4, “Positioning and Securing Your Child in the Car Bed” (page 19).
12. Make sure that apnea monitors, oxygen tanks, or other medical equipment are not placed inside the car bed. Keep this equipment outside of the car bed, secured under the seat or on the floor.
13. Make sure that the car bed is properly secured by the vehicle seat belt system by performing the following checks **EVERY TIME YOU DRIVE WITH YOUR CHILD**:
 - a. Make sure all four feet of the car bed are resting on the vehicle seat.
 - b. **PULL SLOWLY BUT FIRMLY** on the side handles of the car bed to make sure the vehicle seat belt does not lengthen at all and that the seat belt is fastened very tightly around the car bed. It should not move side-to-side or front-to-back. If you find that your vehicle seat belt becomes loose, make sure you have followed steps 1-10 correctly, or see section 2, “Choosing a Suitable Location for the Car Bed” (page 9). **DO NOT** use this seating location if the seat belt does not hold the car bed very tightly.

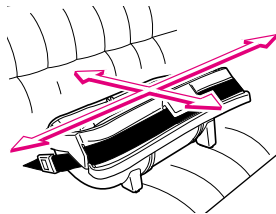

6. Cleaning and Maintenance

- To clean the car bed pad:
 1. Remove the seat pad. **DO NOT USE CAR BED** without the seat pad.
 2. Machine wash on delicate cycle and drip-dry.
 3. Reinstall the car bed pad according to the instructions on pages 31-33.
- Car bed plastic shell may be cleaned by wiping with a mild soap and water solution. **DO NOT USE BLEACH** or household detergents. Use of bleach or detergents may weaken plastic parts, which may break in a crash.
- Harness straps must be kept clean. The straps may be hand washed with soap and warm water and drip dry. **DO NOT** machine wash the harness. Doing so may weaken the harness straps or clog the hook/loop fastener so that the harness may not hold your child in a sharp turn, sudden stop or crash. If the harness cannot be cleaned, order a new one from Graco at **1-888-224-6549**.

Reinstalling Pad and Harness

If pad and harness have been removed for washing or replacement, it is very important to properly reinstall them in your car bed. Ventilation slots in pad must be at the same end as ventilation slots in plastic car bed shell, and harness must be positioned to properly hold your child. Follow these instructions.

1. Turn the car bed upside down. With fuzzy side of harness facing UP (see illustration on page 32), thread both ends of the harness into the slots in the car bed as shown. **The double shoulder straps MUST be inserted in the harness slot next to the ventilation slots.** Make sure straps are not twisted.
2. Turn the car bed right side up. With printed side of pad facing UP, line up the side of the pad that has ventilation holes with the ventilation slots in the car bed. See illustration on page 33.
3. Lower pad into the car bed. Thread the harness straps through the slots in the pad.

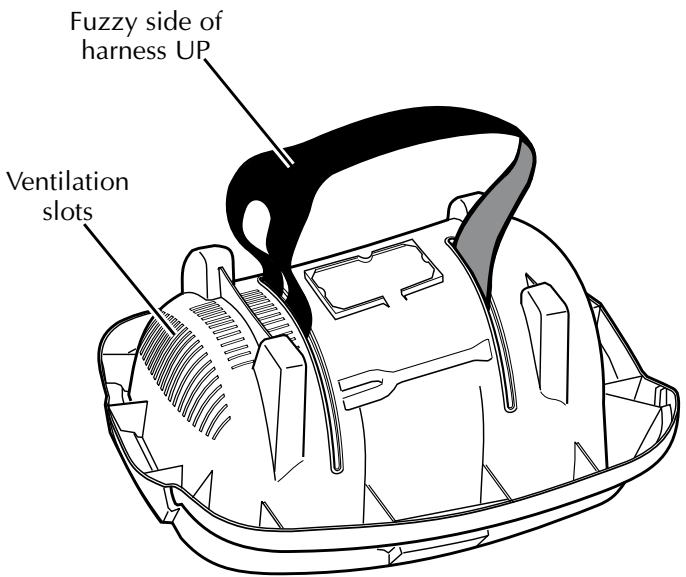

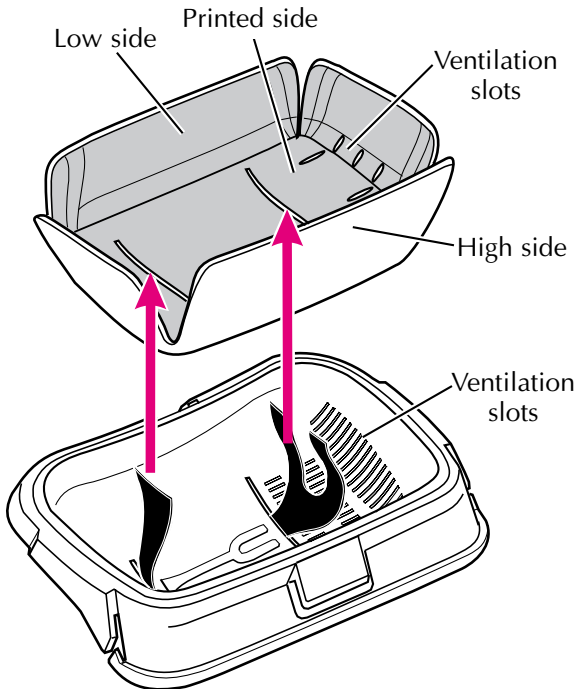

7. Registering Your Car Bed

Model No. _____

Serial No. _____

Purchase Date _____

Dear Customer,

Please fill in the above information. The model and serial numbers can be found on a label underneath your car bed.

Fill out the prepaid registration postcard attached to the pad and mail it today. Child restraints could be recalled for safety reasons. You must register this restraint to be reached in a recall. Send your name, address and serial number to:

Graco Children's Products Inc.
P.O. Box 100
Elverson, PA, 19520-9974
or call **1-888-224-6549**.

For recall information, call the U.S. Government's Auto Safety Hotline at 1-800-424-9393 (202-366-0123 in D.C. area).

GRACO®

Graco Children's Products Inc.
Elverson, PA 19520
1-888-224-6549

A Division of
NewellRubbermaid

Free Manuals Download Website

<http://myh66.com>

<http://usermanuals.us>

<http://www.somanuals.com>

<http://www.4manuals.cc>

<http://www.manual-lib.com>

<http://www.404manual.com>

<http://www.luxmanual.com>

<http://aubethermostatmanual.com>

Golf course search by state

<http://golfingnear.com>

Email search by domain

<http://emailbydomain.com>

Auto manuals search

<http://auto.somanuals.com>

TV manuals search

<http://tv.somanuals.com>