

# *Fahrenheit*

DVD-34A

## OWNER'S MANUAL Mobile Video System

---

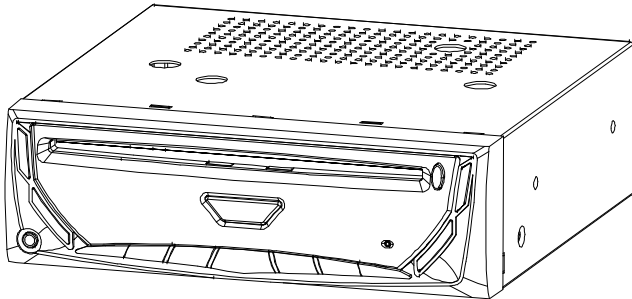
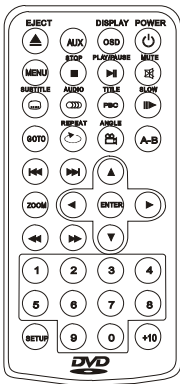

- Multi-subtitle Languages Function
- Multi-audio Languages Function
- Multi-angle Function
- Parental Control

# FEATURES

Compatible with PAL DVD (Video CD) and NTSC DVD (Video CD)

This player can play discs recorded in either PAL or NTSC format.

- A single LSI chip now integrates all major DVD playback circuit functions including MPEG2 decoder, video D/A converter, and audio decoders. L/R stereo analog audio outputs for connection to existing head unit aux inputs. Video output is composite
- video.  
Supplied remote handles multi-function software (multi-language audio-track/subtitle, multi-angle, multi-story, etc.), plus all basic functions.

**Use Authorized Service Centres**

Do not attempt to disassemble or adjust this precision product. Please refer to the Service Centre list included with this product for service assistance.

**For Installation**

The unit should be installed in a horizontal position with the front end up at a convenient angle, but not more than 30°.

## USE THIS PRODUCT SAFELY

**When Driving**

Keep the volume level low enough to be aware of road and traffic conditions.

**When Car Washing**

Do not expose the product to water or excessive moisture. This could cause electrical shorts, fire or other damage.

**When Parked**

Parking in direct sunlight can produce very high temperatures inside your vehicle. Give the interior a chance to cool down before starting playback.

**Use the Proper Power Supply**

This product is designed to operate with a 12 volt DC, negative ground battery system (the regular system in a North American car).

**Protect the Disc Mechanism**

Avoid inserting any foreign objects into the slot of this player.

Failure to observe this may cause malfunction due to the precise mechanism of this unit.

# CONTENTS

---

<b>Safety Information</b> .....	4
<b>Disc Notes</b> .....	5
<b>Installation</b> .....	6
<b>Electric Connection</b> .....	7
<b>Remote Control</b> .....	8
Preparing the Remote Control.....	9
<b>Basic Operation</b> .....	10
On-Screen Display Function.....	11
Multi-audio Language Function.....	11
Title Menu Function (For DVD only).....	12
Multi-subtitle Language Function (For DVD only).....	12
Multi-angle Function (For DVD only).....	12
MP3 Disc Play.....	12
Using the FM modulator(For FM modulator version only).....	12
<b>Setup</b> .....	13
Initial Setup.....	13
General Setup.....	13
Speaker Setup.....	15
Audio Setup.....	15
Preferences Setup.....	16
Defaults Table .....	19
<b>Specifications</b> .....	20

# SAFETY INFORMATION

---

## **CAUTION:**

MOBILE DVD PLAYER IS A CLASS I LASER PRODUCT. HOWEVER THIS MOBILE DVD PLAYER USES A VISIBLE/INVISIBLE LASER BEAM WHICH COULD CAUSE HAZARDOUS RADIATION EXPOSURE IF DIRECTED. BE SURE TO OPERATE THE MOBILE DVD PLAYER CORRECTLY AS INSTRUCTED. USE OF CONTROLS OR ADJUSTMENTS OR PERFORMANCE OF PROCEDURES OTHER THAN THOSE SPECIFIED HEREIN MAY RESULT IN HAZARDOUS RADIATION EXPOSURE. DO NOT OPEN COVERS AND - DO NOT REPAIR YOURSELF. REFER SERVICING TO QUALIFIED PERSONNEL.

## **WARNING:**

- TO REDUCE THE RISK OF FIRE OR ELECTRIC SHOCK, DO NOT EXPOSE THIS EQUIPMENT TO RAIN OR MOISTURE.
- TO REDUCE THE RISK OF FIRE OR ELECTRIC SHOCK, AND ANNOYING INTERFERENCE, USE ONLY THE RECOMMENDED ACCESSORIES.
- THIS DEVICE IS INTENDED FOR CONTINUOUS OPERATION.

This product incorporates copyright protection technology that is protected by method claims of certain U.S. patents and other intellectual property rights owned by Macrovision Corporation and other rights owners. Use of this copyright protection technology must be authorized by Macrovision Corporation, and is intended for home and other limited viewing uses only unless otherwise authorized by Macrovision Corporation. Reverse engineering or disassembly is prohibited.

## **Region Management Information:**

This Mobile DVD Player is designed and manufactured to respond to the Region Management Information that is recorded on a DVD disc. If the Region number described on the DVD disc does not correspond to the Region number of this Mobile DVD Player, this Mobile DVD Player cannot play this disc.

# DISC NOTES

## Disc formats supported by this player



DVD  
12 cm disc  
(Single-sided disc only)



Video CD  
12 cm disc  
CD



12 cm disc  
MP3



12 cm disc

## Discs which cannot be played with this player

- DVD-ROM
- DVD-R/DVD-RAM
- CDV
- CD-G

## Handling and Cleaning

- Dirt, dust, scratches and warping disc will cause misoperation.
- Do not place stickers or make scratches on discs.
- Do not warp discs.  
A disc should always be kept in its case when not in use to prevent from damaging.
- Do not place discs in the following places:
  1. Direct sunlight
  2. Dirty, dusty and damp areas
  3. Near car heaters
  4. On the seats or dashboard

## Disc Cleaning

Use a dry soft cloth to wipe the surface. If the disc is quite dirty, use a soft cloth slightly moistened with isopropyl (rubbing) alcohol. Never use solvents such as benzine, thinner or conventional record cleaners as they may mar the surface of the disc.

## Note:

A disc may become somewhat scratched (although not enough to make it unusable) depending on your handle it and conditions in the usage environment.

## Note :

these scratches are not an indication of any problem with the player.

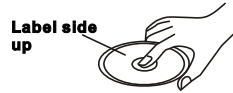

Label side up



Do not touch the underside of the disc



Do not bend

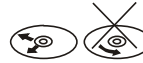

Wipe the disc from center toward the outside edge

## Preparing New Discs with Rough Spots

A new disc may have rough edges on its inside and outside edges. If a disc with rough edges is used, the proper setting will not be performed and the player will not play the disc. Therefore, remove the rough edges in advance by using a ball point pen or pencil as shown on the right. To remove the rough edges, press the side of the pen or pencil against the inside and outside edges of the disc.

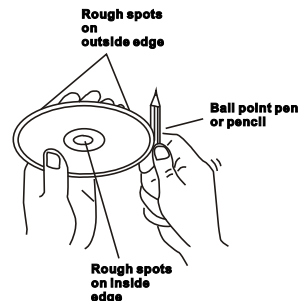

Rough spots on outside edge

Ball point pen or pencil

Rough spots on inside edge

# INSTALLATION

---

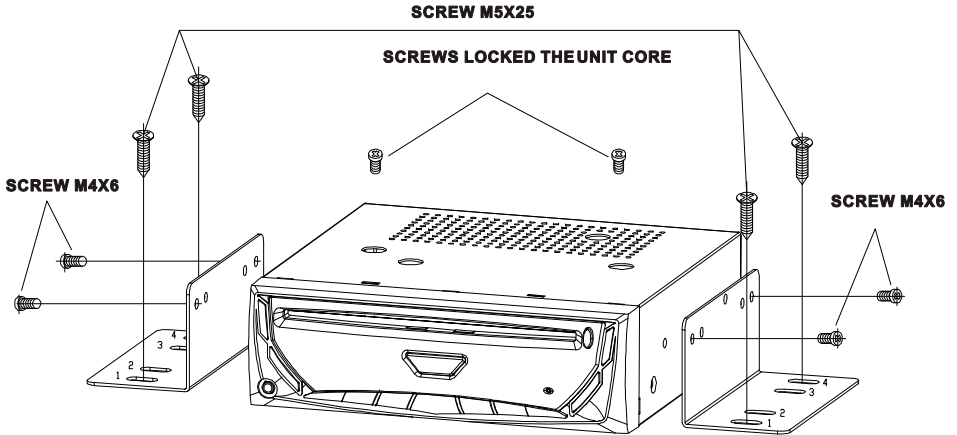

## Note:

1. First remove the two screws that lock the unit core, then attach the brackets on both sides of unit with screws (M4x6), last install the unit with screws (M5x25).
2. When fix the unit, you can slide the screw (M5x25) to left side or right side to meet your needed position. In the figure above, select 1 and 3 position to fix the bracket, and you can also select 2 and 4 position to fix the bracket.

# ELECTRIC CONNECTION

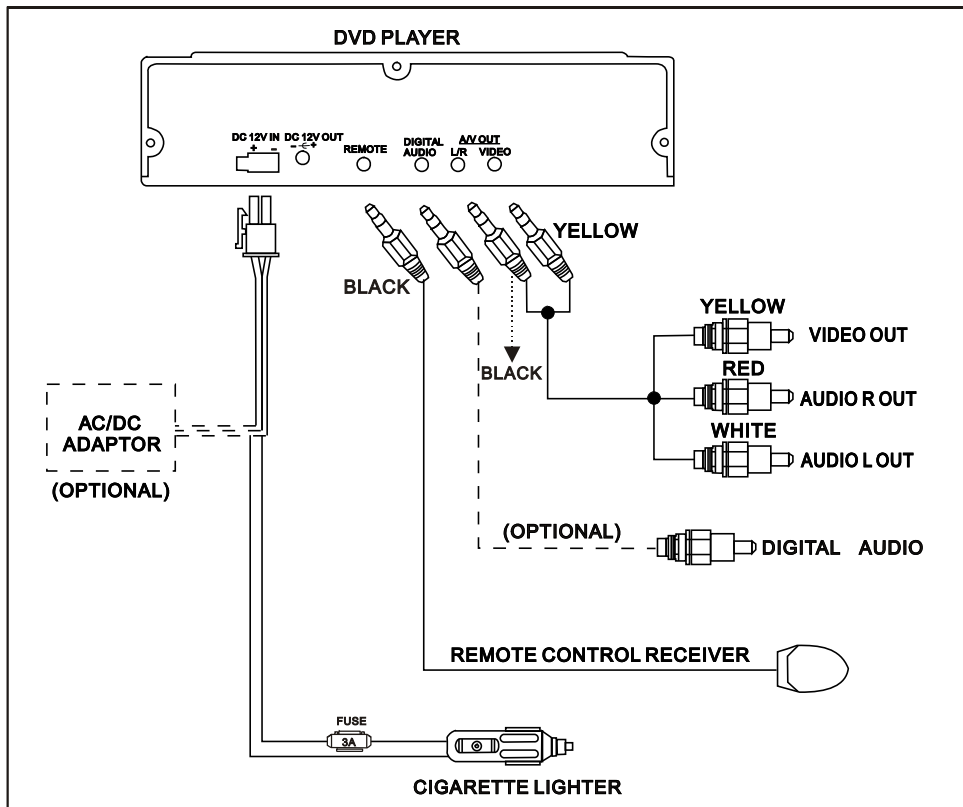

# REMOTE CONTROL

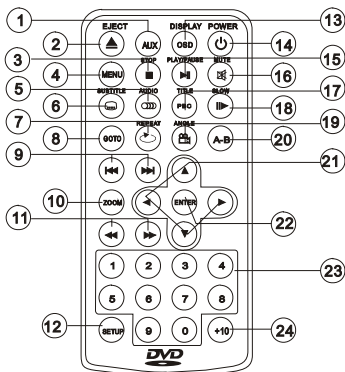

- |                                                                                                                                                                                                                                                                                                                                                                                                                     |                                                                                                                                                                                                                                                                                                                                                                                                                                                                                                                                                                                                                                                                                                                                                                                                                                                                                                                                                                                                                                                                                                                                                                                                                                                                                                                                                                                                                                                                                                                                                                                                                                                                                                                           |
|---------------------------------------------------------------------------------------------------------------------------------------------------------------------------------------------------------------------------------------------------------------------------------------------------------------------------------------------------------------------------------------------------------------------|---------------------------------------------------------------------------------------------------------------------------------------------------------------------------------------------------------------------------------------------------------------------------------------------------------------------------------------------------------------------------------------------------------------------------------------------------------------------------------------------------------------------------------------------------------------------------------------------------------------------------------------------------------------------------------------------------------------------------------------------------------------------------------------------------------------------------------------------------------------------------------------------------------------------------------------------------------------------------------------------------------------------------------------------------------------------------------------------------------------------------------------------------------------------------------------------------------------------------------------------------------------------------------------------------------------------------------------------------------------------------------------------------------------------------------------------------------------------------------------------------------------------------------------------------------------------------------------------------------------------------------------------------------------------------------------------------------------------------|
| <p>1. AUX</p> <p>2. EJECT</p> <p>3. STOP</p> <p>4. MENU</p> <p>5. AUDIO</p> <p>6. SUBTITLE</p> <p>7. REPEAT</p> <p>8. GO TO</p> <p>9. ⏩ / ⏪</p> <p>10. ZOOM</p> <p>11. ⏩ / ⏪</p> <p>12. SETUP</p> <p>13. DISPLAY</p> <p>14. ⏻ POWER</p> <p>15. ⏸</p> <p>16. MUTE</p> <p>17. TITLE/PBC</p> <p>18. SLOW</p> <p>19. ANGLE</p> <p>20. A-B</p> <p>21. ▲ / ▼ / ► / ◀</p> <p>22. ENTER</p> <p>23. 0 - 9</p> <p>24. +10</p> | <p>Press the AUX to switch to external Audio/Video input. <b>(AUX is enabled in Disc Mode only)</b></p> <p>Press it to eject the disc from the disc compartment.</p> <p>Press it to stop playback.</p> <p>Press MENU to display the root menu of the DVD disc.</p> <p>Changing of the AUDIO soundtrack on multi-audio soundtrack DVD disc. Changing of the sound mode of the VCD/CD disc</p> <p>Changing of the SUBTITLE language on multi-subtitle language DVD disc</p> <p>Switch the Repeat mode of DVD/VCD/CD disc</p> <p>Disc search button, cooperatively used with numeric buttons</p> <p>Press ► to skip to the next track &amp; press ⏪ to skip back one track</p> <p>Press it to zoom the picture in scale x1.5, x2.0, x3.0</p> <p>Press ► to start forward rapidly &amp; ⏪ to reverse rapidly</p> <p>Display the SETUP menu</p> <p>Display statistical disc information during playback</p> <p>Press POWER to turn the unit ON or OFF.</p> <p>Press once to pause a play, press again to resume continuous playback</p> <p>Press it to eliminate the sound immediately</p> <p>Display the TITLE menu that is stored in DVD disc changing between PBC ON and PBC OFF on the VCD disc</p> <p>Changing for slow forward/reverse playback motion</p> <p>Changing of the view angle on multi-angle DVD disc</p> <p>Press it to repeat between two selected sports on DVD or VCD disc.</p> <p>Cursor buttons in MENU mode. Note: For models without built-in FM Modulator, the ▲ / ▼ buttons can be used for volume up/down control.</p> <p>Confirm the Track/Chapter selected with the number key or selected with the cursor buttons on TV screen</p> <p>Numeric buttons</p> <p>Press it to select 10th digits</p> |
|---------------------------------------------------------------------------------------------------------------------------------------------------------------------------------------------------------------------------------------------------------------------------------------------------------------------------------------------------------------------------------------------------------------------|---------------------------------------------------------------------------------------------------------------------------------------------------------------------------------------------------------------------------------------------------------------------------------------------------------------------------------------------------------------------------------------------------------------------------------------------------------------------------------------------------------------------------------------------------------------------------------------------------------------------------------------------------------------------------------------------------------------------------------------------------------------------------------------------------------------------------------------------------------------------------------------------------------------------------------------------------------------------------------------------------------------------------------------------------------------------------------------------------------------------------------------------------------------------------------------------------------------------------------------------------------------------------------------------------------------------------------------------------------------------------------------------------------------------------------------------------------------------------------------------------------------------------------------------------------------------------------------------------------------------------------------------------------------------------------------------------------------------------|



# REMOTE CONTROL

---

## Preparing the Remote Control

### Inserting the Batteries

1. Remove the battery cover as the direction indicated by the arrow.
2. Put the battery properly with the positive and negative terminals of the batteries are oriented indicated.
3. Close the battery cover.

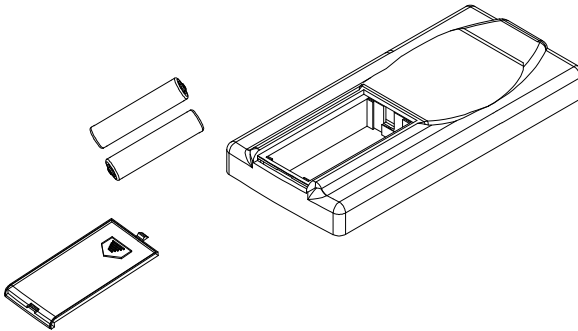

### Using the Remote Control

Face the remote control towards the player front face IR mark (remote control signal receiver).

Operation angle: About +30 degree in each the direction of the front of the IR mark.

To prevent damage to the unit, be sure to follow the connection diagram (page 7).

# BASIC OPERATION

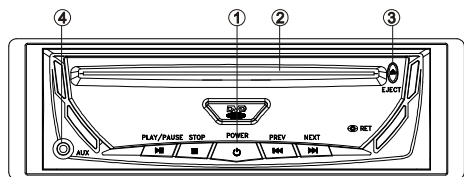

## Loading a DVD/VCD/CD Disc

1. Turn the ignition on the accessory position.
2. Press the POWER button (1).
3. Insert the disc with printed side facing up into the disc slot (2).
4. The player starts playback automatically.

## Ejecting a Disc

Press **▲** (EJECT) button (3) to eject the disc.

## Stopping Play

-Brief press the **■** (Stop) button to stop the unit playback, when press the **▶▶** (Play) button it can continuous normal playback.

-Press **■**(Stop) button twice, it will stop the playback and go back to initial Track/Chapter.

## Rapid Forward/Rapid Reverse

Press **▶▶** FF & **◀◀** REW during play. Each time the button is pressed, the speed of rapid forward/reverse changes according to the disc as follow.

DVD/VCD/CD/MP3

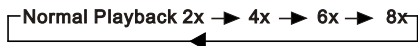

## Skipping Track

Press **◀◀** / **▶▶** on the remote handset or front panel during playback.

Press **▶▶** to skip to next track, and **◀◀** to back one track.

**Note:** For some VCD 2.0 discs (PBC-playback control), **▶▶** and **◀◀** buttons may be unavailable.

## Slow Motion Play

Press slow button during playback. Each time the button is pressed, the slow modes are changes according to the disc as follow.

DVD:

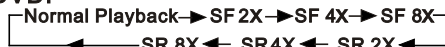

VCD:

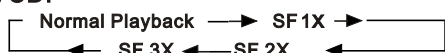

**Note:** For VCD in any slow mode press ENTER button to return to normal playback.

## Pause (still picture)

Pressing **⏸** during playback will stop play temporary. Return to normal playback, press **▶▶** once again.

## Repeat

Press the REPEAT button to select repeat mode as follow.

DVD:

Press the REPEAT button to select repeat mode as follow.



VCD/CD:

Press the REPEAT button to select repeat mode as follow.



1. Continuously repeat at the current chapter/track, when selected REP-ONE mode.

2. Select REP-ALL mode to continuously repeat all chapter/track on the current disc.

3. When the player finish playback the current disc last chapter/track, it will stop display the elapsed time. When selected REPEAT OFF mode (REP-ONE & REP-ALL disappear at the screen display).

4. REPEAT feature does not support VCD2.0(with PBC ON).

## Aux input jack (4)

When the unit connect external A/V you can press the AUX on the remote controller to switch to the aux input mode

# BASIC OPERATION

## Reset



Reset button is placed on the front panel and must be activated with a ball point pen or thin metal object. Reset button is to be activated for the following reasons:

- Initial installation of the unit when all wiring is completed.
- All the function buttons do not operate.
- Error symbol on the display.

## Remote Sensor (IR)

Point the remote handset to the remote sensor. Receive the signal from remote handset.

## Turning the player on/off

Press the  (POWER) button on front of panel or press  (POWER) button on remote control to turn the player on or off.

## On-Screen Display Function

Press the DISPLAY button during playback to display the contents of the current disc on the screen.

Example:

DVD:

- (1) Press DISPLAY for the first time:

T: 01/03 C: 002/025 P:00:02:27  
TITLE ELAPSED

Title Number, Total Title Number, Chapter Number, Total Chapter Number of this Title of the disc currently being played will be shown on the screen, along with the elapsed time.

- (2) Press DISPLAY for the second time:

T: 01/03 C: 002/025 P:01:05:27  
TITLE REMAIN

- (3) Press DISPLAY for the third time:

T: 01/03 C: 002/025 P:00:02:20  
CHAPTER ELAPSED

- (4) Press DISPLAY for the fourth time:

T: 01/03 C: 002/025 P:00:03:15  
CHAPTER REMAIN

- (5) Press DISPLAY for the fifth time: The message on the screen will be cleared.

Video CD/SVCD/CD:

- (1) Press DISPLAY for the first time:

T:03/17P:00:00:25  
SINGLE ELAPSED

- (2) Press DISPLAY for the second time:

T:03/17P:00:01:25  
SINGLE REMAIN

- (3) Press DISPLAY for the third time:

T:03/17P:00:01:25  
TOTALELAPSED

- (4) Press DISPLAY for the fourth time:

T:03/17P:00:01:25  
TOTALREMAIN

- (5) Press DISPLAY for the fifth time: The message on the screen will be cleared.

Mp3:

Each time DISPLAY is pressed, the message displayed on screen changes as follows:

CHAPTER ELAPSED → CHAPTER REMAIN

## Multi-audio Language Function

DVD:

Press AUDIO during playback. Each time the button is pressed, number of the audio soundtrack language changes on sequential order.

Notes:

-The language number is different according to the disc.  
-Some disc only contain one language soundtrack.

-When no different language soundtrack are recorded  will be display at screen left top corner.

VCD/CD:

Press AUDIO during playback.

It is possible to switch the sound between monaural and stereo sound.

MONO LEFT → MONORIGHT → STEREO

# BASIC OPERATION

## TITLE Menu Function

### DVD:

If the DVD has multiple titles recorded on the disc. It can select preferred title from the title menu to start playback.

1. Press TITLE during playback.

The title menu is display.

2. Press the cursor button shown in TV screen, select preferred title by the cursor button and confirmed by ENTER key.

### VCD:

Press TITLE button while the disc is playing, you can switch between "PBC on" and "PBC off" mode.

## Multi-subtitle Language Function

(For DVD only)

Press SUBTITLE during playback.

Each time the button is pressed, number of the subtitle language changes in sequential order.

### Notes:

-The language number is different according to the disc.

-Some discs only contain one subtitle language.

-When no different subtitle language are recorded,  will be displayed at screen left top corner.

## Multi-angle Function

(For DVD only)

Press ANGLE during playback.

Each time the button is pressed, number of the angle changes in sequential order.

### Notes:

-The angle number is different according to the disc.

-The function only work for disc having scenes recorded at different angles.

-When no different angle are recorded  will be displayed at screen left top corner.





## MP3 Disc Play

MP3 disc is playing in the DISC

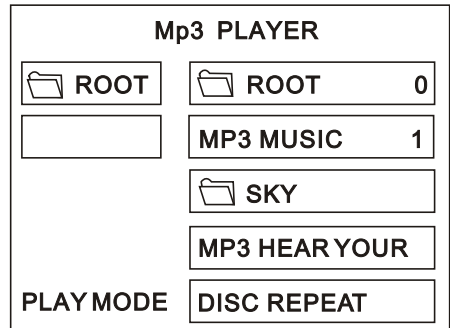
REPEAT mode by default.

For example:



Use  /  /  /  buttons to select the item or folder, then press ENTER button. When select PLAY MODE, press the REPEAT button repeatedly to select three kinds of play mode.

REP-ONE:

Play the same song over and over again.

FOLDER REPEAT:

Play all songs in the current directory in sequence, over and over again.

DISC REPEAT:

Play all songs in the disc over and over again.

In the playback, use  or  to skip an item ahead or back.

: Rapid reverse, : Rapid advance

Note: The FOLDER cannot be selected during playing. It can be selected after

 (Stop) button pressed.

## Using the FM Modulator (optional)

1. Setup the The FM Modulator in the preference setup menu to turn on (note: the unit is initially set to FM Modulator ON)

2. In cd Playing, open the radio and tune the radio frequency to as same in the General setup (88.7 MHz or 88.9MHz) (Note :The unit initially set to 88.7MHz)

3. At this time ,the radio can be receive the audio to listing.

# SETUP

## INITIAL SETUP

SETUP MENU ---MENU PAGE

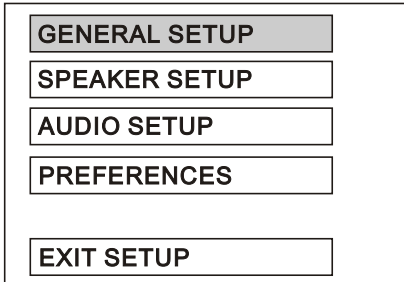

1. Press **SETUP** in the stop mode.  
(Press the stop button twice to ensure the player under **STOP** mode.)

2. The initial **SETUP** menu is displayed.

3. Select the preferred item by using the **▲ / ▼** buttons.

4. Press **ENTER** buttons.

### a. GENERAL SETUP

This setup page includes all the item of TV display & audio output feature. The detail please refer to **GENERAL SETUP MENU**.

### b. SPEAKER SETUP

This is to activate the audio output from **DOLBY AC3 5.1 DOWNMIX** to 2 channel mode. Please refer to **SPEAKER SETUP MENU**.

### c. AUDIO SETUP

This setup page includes all the items for **AUDIO**. Please refer to **AUDIO SETUP MENU**.

### d. PREFERENCE SETUP

This setup page includes all the configuration of support feature. The detail please refer to **PREFERENCES SETUP MENU**.

## GENERAL SETUP

--- GENERAL PAGE ---

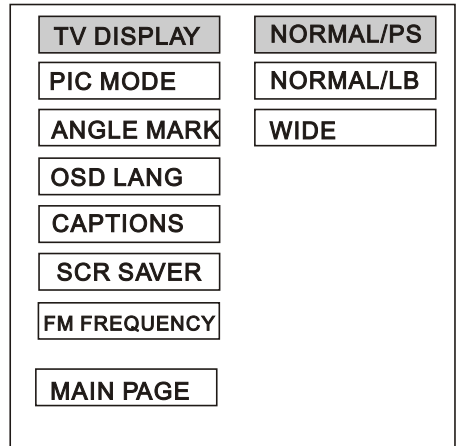

Video Material	TV Screen			
	Normal	Pan Scan	Letter-box	Wide(16:9)
4:3				

### TV display setup

This is to select the appropriate TV aspect (4:3 or 16:9) according to the connected TV set.

#### Normal/PS (For 4:3 TV)

Played back in the **PAN & SCAN** style.  
(If connected to wide-screen TV, the left and right edges are cut off.)

#### Normal/LB (For 4:3 TV)

Played back in letterbox style.  
(If connected to wide-screen TV, black bands appear at top and bottom of the screen.)

#### Wide (For 16:9 TV)

Select when a wide-screen TV set is connected.

# SETUP

## ---GENERAL PAGE ---

TV DISPLAY	
PIC MODE	AUTO
ANGLE MARK	HI-RES
OSD LANG	N-FLICKER
CAPTIONS	
SCR SAVER	
FM FREQUENCY	
MAIN PAGE	

### PIC mode setup

Select AUTO, the player PIC mode will depend on DVD disc.

Select HI-RES format for best image resolution.

Select N-FLICKER format on format on image or picture under noise affect.

## ---GENERAL PAGE ---

TV DISPLAY	
PIC MODE	
ANGLE MARK	
OSD LANG	ENGLISH
CAPTIONS	FRENCH
SCR SAVER	GERMAN
FM FREQUENCY	ITALIAN
	SPANISH
MAIN PAGE	

### OSD LANG type setup

Select the preferred OSD language by using the ▲ / ▼ buttons.

## --- GENERAL PAGE ---

TV DISPLAY	
PIC MODE	
ANGLE MARK	ON
OSD LANG	OFF
CAPTIONS	
SCR SAVER	
FM FREQUENCY	
MAIN PAGE	

### ANGLE MARK display setup

If it is set to ON, when the multi-angle DVD disc is playing,  (the angle mark) will appear on the screen; if it is set to OFF, the mark will not appear.

## --- GENERAL PAGE ---

TV DISPLAY	
PIC MODE	
ANGLE MARK	
OSD LANG	
CAPTIONS	ON
SCR SAVER	OFF
FM FREQUENCY	
MAIN PAGE	

### CAPTIONS setup

Activate the CAPTIONS feature by selecting ON. And release this feature by selecting OFF.

# SETUP

--- GENERAL PAGE ---

TV DISPLAY	
PIC MODE	
ANGLE MARK	
OSD LANG	
CAPTIONS	
SCR SAVER	ON
FM FREQUENCY	OFF
MAIN PAGE	

## SCR SAVER setup

Select the SCR SAVER output ON/OFF

---GENERAL PAGE---

TV DISPLAY	
PIC MODE	
ANGLE MARK	
OSD LANG	
CAPTIONS	
SCR SAVER	
FM FREQUENCY	88.7MH z
	88.9MH z
MAIN PAGE	

## FM Modulator Frequency setup

Select the preferred FM frequency by using the ▲ / ▼ buttons

**NOTE: The built-in FM Modulator is an optional feature.**

## SPEAKER SETUP

--- SPEAKER SETUP PAGE ---

DOWNMIX	LT/RT
	STEREO
MAIN PAGE	

This is to activate the audio output from DOLBYAC3 5.1 DOWNMIX to 2 channel mode. Select the preferred SPEAKER connection by using the cursor buttons.

- Select the LT/RT to activate the Dolby surround compatible output.
- Select the STEREO to activate simple stereo mode.

## AUDIO SETUP

---AUDIO SEUTP---

AUDIO OUT	ANALOG
OP MODE	SPDIF/RAW
DYNAMIC	SPDIF/PCM
LPCM OUTPUT	
MAIN PAGE	

## AUDIO OUT

This is to activate the audio output from ANALOG mode to SPDIF/RAW mode to SPDIF/PCM mode.

# SETUP

## ---AUDIO SETUP---

AUDIO OUT	
OP MODE	LINE OUT
DYNAMIC	RF REMOD
LPCM OUTPUT	
MAIN PAGE	

### OP MODE

There are two operating modes for the Dolby Digital decoder: LINE OUT and RF REMOD.

## ---AUDIO SETUP---

AUDIO OUT	
OP MODE	
DYNAMIC	
LPCM OUTPUT	LPCM 48K
MAIN PAGE	LPCM 96K

### LPCM OUTPUT

Select the LPCM OUTPUT between LPCM 48K and LPCM 96K.

## ---AUDIO SETUP---

AUDIO OUT	
OP MODE	
DYNAMIC	
LPCM OUTPUT	
MAIN PAGE	

FULL
6/8
4/8
2/8
OFF

### Dynamic Range Control

Select DRC and adjust the dynamic range of a Dolby Digital encoded program. There are 8 steps between full compression and off compression.

## PREFERENCES SETUP

### ---PREFERENCES PAGE---

TV TYPE	AUTO
AUDIO	NTSC
SUBTITLE	PAL
DISC MENU	
PARENTAL	
PASSWORD	
DEFAULTS	
FM MODULATOR	
Mp3 PLAYER	
MAIN PAGE	

### TV type setup

This player can play discs recorded in either PAL or NTSC format. Select NTSC format, when you connected to NTSC TV. Select PAL format, when you connected to PAL TV. Select AUTO format, the player TV output format will according to the DVD disc format.



# SETUP

## ---PREFERENCES PAGE ---

TV TYPE	
AUDIO	
SUBTITLE	ENGLISH
DISC MENU	FRENCH
PARENTAL	SPANISH
PASSWORD	CHINESE
DEFAULTS	JAPANESE
FM MODULATOR	GERMAN
Mp3 PLAYER	ITALIAN
MAIN PAGE	

**AUDIO language setup**  
Select the preferred AUDIO soundtrack by using the cursor buttons.

## ---PREFERENCES PAGE ---

TV TYPE	
AUDIO	
SUBTITLE	
DISC MENU	ENGLISH
PARENTAL	FRENCH
PASSWORD	SPANISH
DEFAULTS	CHINESE
FM MODULATOR	JAPANESE
Mp3 PLAYER	GERMAN
	ITALIAN
MAIN PAGE	

**DISC MENU language setup**  
Select the preferred DISC MENU language by using the cursor buttons.

## ---PREFERENCES PAGE ---

TV TYPE	
AUDIO	
SUBTITLE	ENGLISH
DISC MENU	FRENCH
PARENTAL	SPANISH
PASSWORD	CHINESE
DEFAULTS	JAPANESE
FM MODULATOR	GERMAN
Mp3 PLAYER	ITALIAN
	OFF
MAIN PAGE	

**SUBTITLE language setup**  
Select the preferred SUBTITLE language by using the cursor buttons.

## ---PREFERENCES PAGE ---

TV TYPE	1G
AUDIO	2
SUBTITLE	3PG
DISC MENU	4PG13
PARENTAL	5
PASSWORD	6PG-R
DEFAULTS	7NC-17
FM MODULATOR	8 ADULT
Mp3 PLAYER	NO PARENTAL
MAIN PAGE	

**PARENTAL**  
Select suitable parental guidance by the cursor buttons and conformed by pressing ENTER button.

# SETUP

## ---PREFERENCES PAGE ---

TV TYPE	
AUDIO	
SUBTITLE	
DISC MENU	
PARENTAL	
PASSWORD	CHANGE
DEFAULTS	
FM MODULATOR	
Mp3 PLAYER	
MAIN PAGE	

### PASSWORD

Select the change and press ENTER button. Type the old password (The initial factory code is 3308) and key in 4 characters password now you want to use, and retype again to confirm key in correctly.

## ---PREFERENCES PAGE ---

TV TYPE	
AUDIO	
SUBTITLE	
DISC MENU	
PARENTAL	
PASSWORD	
DEFAULTS	
FM MODULATOR	ON
Mp3 PLAYER	OFF
MAIN PAGE	

### FM Modulator ON/OFF setup

Activate the FM Modulator feature by selecting ON. And release this feature by selecting OFF.

**NOTE: The built-in FM Modulator is an optional feature.**

## ---PREFERENCES PAGE ---

TV TYPE	
AUDIO	
SUBTITLE	
DISC MENU	
PARENTAL	
PASSWORD	
DEFAULTS	RESET
FM MODULATOR	
Mp3 PLAYER	
MAIN PAGE	

### DEFAULTS

Select reset to become factory initial setting.

## ---PREFERENCES PAGE ---

TV TYPE	
AUDIO	
SUBTITLE	
DISC MENU	
PARENTAL	
PASSWORD	
DEFAULTS	
FM MODULATOR	
Mp3 PLAYER	NO MENU
MAIN PAGE	WITH MENU

### Mp3 PLAYER

In this item, you can select NO MENU mode or WITH MENU mode.

# SETUP

---

## DEFAULTS TABLE

<b>General Setup</b>	<b>TV Display</b>	<b>Normal/PS</b>
	<b>PIC Mode</b>	<b>AUTO</b>
	<b>Angle Mark</b>	<b>ON</b>
	<b>OSD Language</b>	<b>English</b>
	<b>Captions</b>	<b>ON</b>
	<b>SCR Saver</b>	<b>ON</b>
<b>Speaker Setup</b>	<b>Downmix</b>	<b>Stereo</b>
<b>Audio Setup</b>	<b>Audio out</b>	<b>Analog</b>
	<b>OP Mode</b>	<b>Line Out</b>
	<b>Dynamic</b>	<b>FULL</b>
	<b>LPCM Out</b>	<b>LPCM96K</b>
<b>Preferences</b>	<b>TV Type</b>	<b>AUTO</b>
	<b>Audio</b>	<b>English</b>
	<b>Subtitle</b>	<b>English</b>
	<b>DISC Menu</b>	<b>English</b>
	<b>Parental</b>	<b>NO PARENTAL</b>
	<b>Password</b>	<b>3308</b>
	<b>DEFAULTS</b>	<b>RESET</b>
	<b>FM MODULATOR</b>	<b>ON</b>
	<b>Mp3 Player</b>	<b>With Menu</b>

# SPECIFICATIONS

---

Supply Voltage	: 12V DC (11V-15V), test voltage 14.4V, negative ground
Current Consumption	: Less than 2A
Signal System	: Composite video 1.0Vp-p 75 $\Omega$
Discs Played	: (1)DVD-VIDEO Disc 5"(12 cm) single-sided, single-layer 5"(12 cm) single-sided, double-layer (2)Compact Disc (CD-DA, VIDEO CD) 5"(12cm) disc
Audio Output Level	: 600 $\Omega$ (2 ch 2.0Vrms)
Audio Signal Output Characteristics	: (1)Frequency Response 20 Hz - 20 KHz (2)S/N Ratio 90 dB (JIS) (3)Wow and Flutter Below measurable limits

**Note:**

Specifications and design are subject to modification, without notice, due to improvements in technology.

This product incorporates copyright protection technology that is protected by method claims of certain U.S. patents and other intellectual property rights owned by Macrovision Corporation and other rights owners. Use of this copyright protection technology must be authorized by Macrovision Corporation, and is intended for home and other limited viewing uses only unless otherwise authorized by Macrovision Corporation. Reverse engineering or disassembly is prohibited.

## Free Manuals Download Website

<http://myh66.com>

<http://usermanuals.us>

<http://www.somanuals.com>

<http://www.4manuals.cc>

<http://www.manual-lib.com>

<http://www.404manual.com>

<http://www.luxmanual.com>

<http://aubethermostatmanual.com>

Golf course search by state

<http://golfingnear.com>

Email search by domain

<http://emailbydomain.com>

Auto manuals search

<http://auto.somanuals.com>

TV manuals search

<http://tv.somanuals.com>