



# GUIDE REMOTE\*



*This changes everything!<sup>SM</sup>*

*User's Manual*

*RD5000*

# Table of Contents

<b>Introduction</b>	<b>3</b>
1. <b>Evolve GUIDE Remote*</b>	3
2. Computer Requirements	4
3. Key Descriptions	5
a. Key Layout	5
b. Key Function Descriptions	6
<b>Getting Started</b>	<b>8</b>
1. Activate Remote Control	8
a. Install Batteries	8
b. Install <b>RemoteLinker*</b> Software	9
c. Connect <b>RemoteLinker</b> Cable	10
2. Start <b>RemoteLinker</b> Software	11
3. Activate Remote Control at Website	11
4. Sync Remote Control	12
5. Setup Remote Control	13
a. Setup a TV	13
b. Setup Other Devices	15
c. Remove a Device	19
6. Setup <b>DirectTune*</b>	20
a. Determining <b>DirectTune</b> Device	20
b. Setup <b>DirectTune</b> Device	21
<b>Using the Remote</b>	<b>25</b>
1. Channel Screen	25
2. Changing Modes	26
3. Using the GUIDE Key	27
a. Accessing Program Listings, Suggestions and Reminders	27
b. Program Listings	28
Browsing and Tuning	29
Quick Browse	30
c. Program Descriptions	31
Accessing and Tuning	31
Quick Browse	32
d. Suggestions	33
e. Reminders	34
Reminders Notification	34
Accessing the Reminders List	35
Personal Reminders	35
4. Using Interactivity Keys	36
a. Interactivity Keys	36
b. Interactivity Offers	37
c. Browsing Interactivity Offers	39

# Table of Contents

5. Using the MENU Key	40
a. Menu Screen	40
b. Remote Support	41
c. Time and Date	42
6. Using the ADVANCED Key	43
a. Extended Function Screen	43
b. Accessing the Extended Function Screen	44
7. Using the LIGHT Key	45
8. Promo Screens	45
a. Informational	45
b. Request a Link	46
c. Request an Email	46
d. Channel Tuning	46
e. Channel Promo Screens	47
f. Browsing Promos	47
9. Alert Screens	49
<b>Advanced Settings</b>	<b>50</b>
1. View Device Settings	50
2. View <b>DirecTune</b> * Settings	50
3. Adjust <b>DirecTune</b> Method	51
4. Adjust <b>DirecTune</b> Speed	53
5. Channel Key Settings	55
6. Add or Clear Channel Lock	57
7. Add or Clear Volume Lock	59
<b>Troubleshooting</b>	<b>61</b>
1. General	61
2. Setting up	62
3. Syncing	62
<b>FAQ</b>	<b>63</b>
<b>Specifications</b>	<b>65</b>
<b>License Agreement</b>	<b>66</b>
<b>Privacy Policy</b>	<b>69</b>
<b>Index</b>	<b>70</b>

# Introduction

## 1. Evolve GUIDE Remote\*

---

The **Evolve GUIDE Remote\*** (**GUIDE Remote\***) is more than a universal remote control—it is the ultimate interactive device for TV and Internet users. The **GUIDE Remote** has state-of-the-art features that provide you and your family with hand-held, instantaneous access to weekly TV Listings, games, viewer rewards and valuable discounts. It allows you to request information about your favorite programs while you watch TV, and then interact with your requested information on your computer (PC) using the Internet.

The screen on your **GUIDE Remote** is always on, providing instant access to the TV program listings, Interactivity Offers and special Promo Offers.

Please use this manual to become familiar with your remote. The **GUIDE Remote** can control up to 16 devices, including TVs, VCRs, Cable settop boxes, Satellite receivers, CD players, stereo receivers, digital tape players, phonographs and home automation systems. In fact, the **GUIDE Remote** has built-in control codes for nearly every make and model of infrared (IR) controlled device.

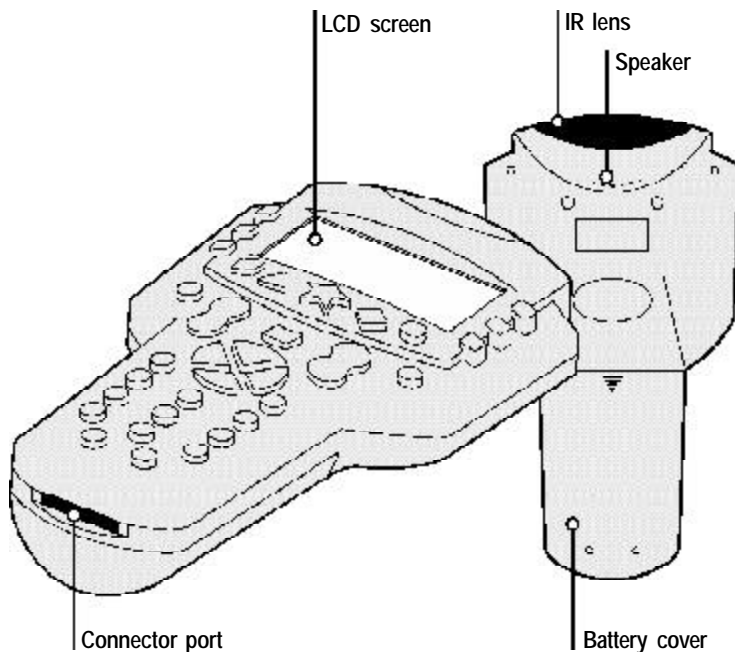

## 2. Computer Requirements

---

The following system is recommended for software installation and use:

- A PC running Windows 95/98, Windows ME, Windows NT Workstation version 4.0+, Windows 2000 or Windows XP.
- An Internet Explorer 5.0+, Netscape 4.0+ or AOL 5.0+ Web Browser.  
(NOTE: Microsoft Internet Explorer 5.0 *must* be installed on your computer even if it is not your default browser, because RemoteLinker uses resource files provided only with Internet Explorer.)
- One available RS-232 Serial Port.
- A CD ROM Drive.
- At least 5 MB free hard disk space.
- At least 8 MB RAM.
- An active connection to the Internet.

## 3. Key Descriptions

### ■ Key Layout



Keys shown in gray are used to navigate and control what appears on the remote screen.

All other keys operate like those found on regular remote controls.

# Introduction

## ■ Key Function Descriptions



Press this key to voice your opinion. Rate what you're watching with the push of a button. See what others think.



Press this key to save money. Find coupons, deals, and savings related to what you're watching.



Press this key to win big. Enter sweepstakes and contests with incredible ease; earn points for valuable bonuses.



Press this key to buy smart. Find great stuff related to advertisers and your favorite TV shows.



Press this key to find out more. Get more information about the show you're watching.



Press this key to access the three types of TV Listings: **Program Listings, Suggestions, and Reminders.**



Press this key to access the Main Menu. You can configure and setup the remote the way you like it.



Press these keys to navigate in the screen.



Press this key to choose highlighted item(s) and/or request links to Promo Offers on the screen.



Press this key to quit the current operation.



Press this key to access the remote functions that are not represented on the **GUIDE Remote\*** keypad ( i.e. sleep, play, PIP, etc.).

# Introduction



Press this key to select which device you want the remote to control.



Press this key to select which device you want the remote to control.



Turns on or off the backlight on the screen.



Turns on or off the device your remote is currently controlling.



Changes channels up or down.



Adjusts volume up or down.



Turns the volume on or off.



Tunes your TV back to the previous channel watched.



Press these keys to tune to a channel on your TV.



Press this key if needed by your device after you use the digit keys to tune to a channel.



# Getting Started

## 1. Activate Remote Control

### ■ Install Batteries

The battery cover is located on the back of the remote. Pay close attention to the direction of the batteries, making sure the poles (+ and -) are aligned as indicated in the battery compartment.

Remove battery case cover to install the batteries in the remote control:

- 1 Press firmly on the arrow on the back of the remote to remove the battery cover.
- 2 Insert four new 1.5-volt AA alkaline batteries, taking care to align the poles (+ and -) as indicated in the battery compartment.

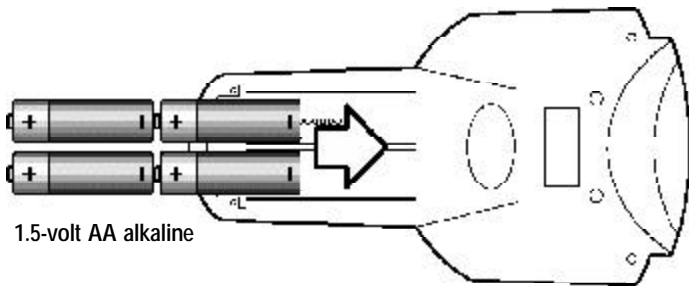

- 3 Close the battery cover.

- ▶ *Note* A Low Battery icon  appears on the top of all display screens when the battery power is low.
- ▶ *Note* The batteries in your **GUIDE Remote\*** should last about three months, depending on how much you use it. If the remote will not be in use for three or more weeks, it is suggested that you remove the batteries to avoid damage to the remote.
- ▶ *Note* Your remote will not lose its device settings when you remove and reinstall batteries. However, you will need to either sync your remote or set the time and date manually (see page 42) for your remote to work properly.

# Getting Started

## Install *RemoteLinker*\* Software

The *RemoteLinker*\* software is an easy-to-use utility for downloading TV Listings and uploading your saved Interactivity Offer requests to our Website.

- 1 IMPORTANT:** Temporarily disable any PDA syncing and anti-virus software, and if necessary, restart your computer.
- 2** Insert the *RemoteLinker* Software CD into your CD-ROM drive.
- 3** Double click on **RemoteLinkerInstall.exe** file in the CD-ROM.
- 4** Follow the installation instructions on the screen until finished.
- 5** Once the software is installed, when prompted, select the **“Yes, I want to launch RemoteLinker now”** option.

---

► *Note*      *In step 3, you can also start the RemoteLinkerInstall.exe by selecting START and RUN from the Taskbar. Type D:\RemoteLinkerInstall.exe (Replace D: with the letter of your CD-ROM drive if necessary). Click OK or press the Enter key.*

► *Note*      ***Palm Users:*** *You should disable your Palm software before you install the RemoteLinker\* software. Additionally, if the GUIDE Remote\* and Palm share the same serial port, you are required to disable the Palm software before you sync your remote.*

► *Help*      *If you are having trouble installing the RemoteLinker software, try the following:*  
- *Check the Readme file in the RemoteLinker program folder.*  
- *Check and verify that your computer meets the minimum system requirements. (see page 4)*  
- *Temporarily turn off any PDA syncing, anti-virus or screen-saver software on your computer.*

# Getting Started

## ■ Connect *RemoteLinker\** Cable

Before you connect the *RemoteLinker\** cable, you should determine the COM port to which you will be attaching the cable. If your computer is on, perform the shutdown procedure recommended by the manufacturer and turn it off. Turn your computer back on after connecting the cable as indicated below.

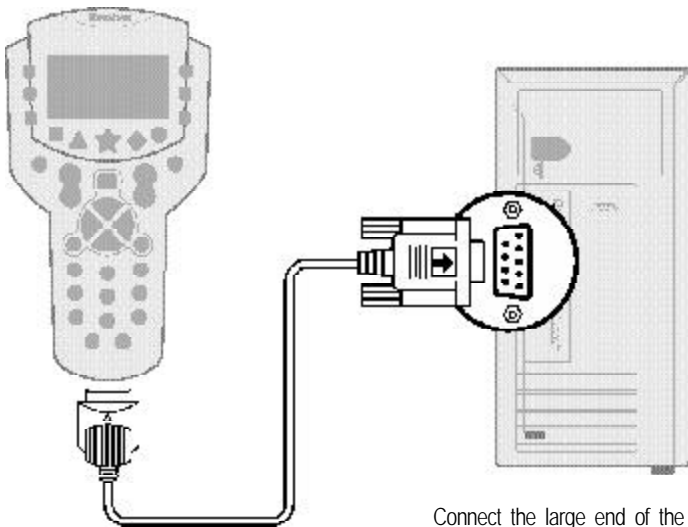

Connect the small end of the cable to the bottom of your **GUIDE Remote**.

Connect the large end of the cable to the PC serial port.

- *Note* If you have more than one serial port, make sure that the **RemoteLinker\*** software is configured to the one that you're using. To access COM port settings, right-click on the **RemoteLinker** icon  located in the lower right hand corner of your computer screen. Choose **Settings**. Select the correct COM port to which you will be connecting the cable and click **Apply**.

# Getting Started

## 2. Start RemoteLinker\* Software

---

### ■ Initiating Web Activation

- 1 Make sure you are connected to the Internet. *YOU MUST BE ONLINE*
- 2 Double-click the **RemoteLinker\*** icon  located in the lower right hand corner of your computer screen, in the system tray near the system clock, to start activating your remote. You may need to wait a few seconds for the activation page to show up on your browser.

- 
- ▶ *Note* Double-clicking on the **RemoteLinker\*** icon will take you to the Remote Activation page at our Website. Follow the step-by-step instructions on the Website to finish the activation process successfully.
  - ▶ *Note* If you have problems starting the **RemoteLinker** software please refer to "Syncing" on page 62.

## 3. Activate Remote Control at Website

---

### ■ Activating and Signing Up

When you double-clicked on the **RemoteLinker** icon, you started the activation and sign-up process at [www.GuideRemote.com](http://www.GuideRemote.com). The instructions on the Website will ask you to do the following:

- 1 Identify how you obtained your **GUIDE Remote\***.
- 2 Enter your email address, which *MUST BE A VALID EMAIL ADDRESS*.

- 
- ▶ *Note* At the end of the activation and sign-up process we will send you a confirmation email. Click on the link in the email to complete the activation process.

- 3 Enter your ZIP CODE and SERVICE TYPE.
- 4 Select your SERVICE PROVIDER.
- 5 Enter your PROFILE.

# Getting Started

- 6 Enter your **PASSWORD**.
- 7 Select your channels. *THESE ARE THE CHANNELS FOR YOUR PROGRAM LISTINGS.*
- 8 Select up to 2 Critics for **Suggestions**.
- 9 **REVIEW** your settings. Make sure everything is correct.
- 10 *CHECK YOUR EMAIL AND CLICK ON THE LINK TO COMPLETE THE ACTIVATION PROCESS.*

## 4. Sync Remote Control

---

### ■ Download your TV Listings (Program Listings, Program Descriptions, Suggestions, and Reminders)

- 1 Connect your **GUIDE Remote\*** to your computer, if it is not already connected.
- 2 Double-click on the **RemoteLinker\*** icon  located in the lower right hand corner of your computer screen, in the system tray, to download and get your **Program Listings, Program Descriptions, Suggestions, and Reminders**.

- *Note Prior to double-clicking on the **RemoteLinker\*** icon to download, you must be connected to the Internet and also logged in at our Website. Otherwise, if you're not logged in, your browser will be directed to the Login page at the Website. You'll then have to enter a username (email address) and password to log in. Double-click on the **RemoteLinker** icon again to start the downloading process.*

# Getting Started

## 5. Setup Remote Control

### ■ Setup a TV

Setting up your **GUIDE Remote\*** to operate your TV is an easy process. To set up a new a TV (or to add new ones later on), perform the following steps:

- 1 Turn on the device that you will be setting up.

- 2  Press the **MENU** key to enter the Main Menu.

- 3  Highlight *Setup a Device* and press the **SELECT** key.



- 4  Highlight *Television* and press the **SELECT** key.



- 5  Highlight the brand of your TV and press the **SELECT** key.



*If you cannot find your brand on the list, you can choose the brand “~UNKNOWN~” (the last choice on the list).*

- **Note** *Choosing “~UNKNOWN~” brand requires you to test all the codes in the library. Although one of these codes may work for your device, we cannot guarantee it.*

-  **Tip** *To scroll quickly through the list, press and hold the Up or Down Arrow key.*

# Getting Started

6

Read and follow the instructions on the screen.



Press the **Down Arrow** key to read all the text.



Press the **Right Arrow** key to continue.



7



To test codes, point the remote toward the TV and press keys like "POWER", "VOL", "CHAN", etc.

If the keys respond, highlight **Yes** and press the **SELECT** key, then go to step 8.

If the keys do not respond, highlight **No** and press the **SELECT** key. (repeat step 7 to test the next code)

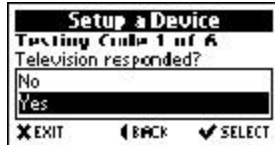

8



Once a code is found that operates your device, basic setup is complete.

Press the **Right Arrow** key.



- **Note** If more than one of any type of device is setup in your remote (i.e. 2 or more TVs or VCRs), they will be sequentially numbered (i.e. TV, TV#2, TV#3 or VCR, VCR#2, VCR#3, etc.). The devices will appear in the order that you set them up.

# Getting Started

## Setup Devices

Setting up your **GUIDE Remote** to operate additional devices such as VCR, Cable Box, Satellite Receiver, CD Player, Audio Receiver, Amplifier and Tape, DAT, Phonograph, DVD, Laser Disk and Home Control is an easy process.

To setup these types of devices, perform the following steps:

- 1 Turn on the device that you will be setting up.

- 2  Press the **MENU** key to enter the Main Menu.

- 3  Highlight **Setup a Device** and press the **SELECT** key.



- 4  Highlight the device type you wish to set up (i.e. TV, VCR, Cable Box, etc.) and press the **SELECT** key.



*For this example, we will setup a VCR.*



# Getting Started

5



Highlight the brand of your device and press the **SELECT** key.

*For this example, we will setup a Panasonic VCR.*

*If you can not find the brand on the list, you can choose the brand "-UNKNOWN-" (the last choice on the list).*

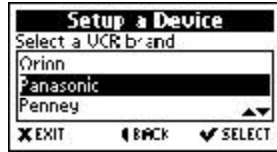

▶ Note

*Choosing "-UNKNOWN-" brand requires you to test all the codes in the library. Although one of these codes may work for your device, we cannot guarantee it.*



Tip

*To scroll quickly through the list, press and hold the Up / Down Arrow key.*

6

Read and follow the instructions on the screen.



Press the **Down Arrow** key to read all the text.



Press the **Right Arrow** key to continue.



## Getting Started

7



To test codes, point the remote towards the device and press keys like "POWER", "VOL", "CHAN", etc. Or, to access keys such as "PLAY", "STOP", "SLEEP", etc. see the first note below.



If the keys respond, highlight **Yes** and press the **SELECT** key, then go to step 8.

If the keys do not respond, highlight **No** and press the **SELECT** key. (repeat step 7 to test the next code)

*If the keys you want to test are not on the remote, access the Extended Function Screen by pressing the **ADVANCED** key and follow step 7b.*

- ▶ **Note** Most devices can be tested using the "hard" keys on the remote like "POWER", "VOL", "CHAN" etc. However, depending on the device, such as stereo receivers, CD players, digital tape players, etc., you may be required to access the Extended Function Screen because the hard keys are not on the remote (i.e. Play, Stop, Menu, Contrast, etc.). (see step 7b)
- ▶ **Note** There is a possibility that more than one code will work when setting up your device. After you have completed setup, if you cannot find a function in the Extended Function Screens, remove the device and try setting up the device again using a different code.

# Getting Started

7b



Press the **ADVANCED** key to access the Extended Function Screen.

7c



To test codes, highlight a function from the list and press the **SELECT** key. Only functions which are also present on your original remote will work on your device.



Press the **Up / Down Arrow** key to access additional functions.



When you're finished testing, press the **Right Arrow** key.



*Note*

*When testing functions from the list, you must pick the correct function as on your original remote. There may be many other additional functions on the list that do not relate to your device. If the appropriate functions respond, you have found the right code.*

7d



If the keys respond, highlight **Yes** and press the **SELECT** key then, go to step 8.

If the keys do not respond, highlight **No** and press the **SELECT** key. (repeat step 7b to test the next code)



8



Once a code is found that operates your device, basic setup is complete.

Press the **Right Arrow** key.



# Getting Started

## Remove a Device

You may remove a device from setup at any time. To remove a device from setup in your **GUIDE Remote**, perform the following steps:

- 1  Press the **MENU** key to enter the Main Menu.

- 2  Highlight **Remove a Device** and press the **SELECT** key.



- ▶ *Note* If you remove a **DirecTune\*** device you will see a caution screen. In addition, you will not be able to tune from within the TV Listings, or access Interactivity Offers.

- 3  Highlight the device you want to remove and press the **SELECT** key.



- 4  If you really want to remove this device, highlight **Yes** and press the **SELECT** key.



- ▶ *Note* If you highlight **No** and press the **SELECT** key or press the **EXIT** key at this time, you will retain your current settings.

- 5  The device has been removed.  
Press the **Right Arrow** key.



### 6. Setup *DirecTune*\*

---

The device you use to change channels (typically your TV, cable box, or satellite box) is referred to as your *DirecTune*\* device. *DirecTune* lets you jump directly to a TV channel from within the TV Listings. Your remote needs to know what device is responsible for changing channels, such as your TV, cable box, satellite box or VCR. It also needs to know the procedure for changing channels (for instance, whether or not you have to press an "enter" button after selecting a channel).

Please identify the *DirecTune* device in **Setup DirecTune** when the screen prompts you. Only one device can be set up as the *DirecTune* device. Therefore, you should set up all your devices prior to setting up a *DirecTune* device. You may change the *DirecTune* device settings at anytime.

#### ■ Determining *DirecTune*\* Device

Which device should you set up as your *DirecTune* device? To assist you in determining which device should be set up as your *DirecTune* device, see below.

- The **TV** is recommended as the *DirecTune* device in the following configurations:  
**TV or TV + VCR or TV + Cable-without-a-box or TV + VCR + Cable-without-a-box**  
*Cable-without-a-box indicates that your cable line is connected to your TV or VCR and you use your TV to tune channels.*
- The **Cable box** is recommended as the *DirecTune* device in the following configurations:  
**Cable box + TV or Cable box + TV + VCR**
- The **Satellite receiver** is recommended as the *DirecTune* device in the following configurations:  
**Satellite receiver + TV or Satellite receiver + TV + VCR**
- The **VCR** is recommended as the *DirecTune* device if you use your VCR to tune channels.

# Getting Started

## Setup *DirectTune*\* Device

To setup a *DirectTune* device, perform the following steps:

1 Turn on the *DirectTune* device that you will be setting up.

2  Press the **MENU** key to enter the Main Menu.

3  Highlight **Setup DirectTune** and press the **SELECT** key.



4 Read and follow the instructions on the screen.



Press the **Down Arrow** key to read all the text.



Press the **Right Arrow** key to continue.



# Getting Started



- 5 Highlight your  **DirecTune**  device and press the  **SELECT**  key.



- *Note* In step 5, you will see all your devices listed. Please be advised that your  **DirecTune**  device can only be one of the following: TV, Cable, Satellite, or VCR. (see page 20 to determine your  **DirecTune**  device)



- 6 Read and follow the instructions on the screen and press the  **Right Arrow**  key to continue.



- 7 Highlight the appropriate digit tuning method for your TV and press the  **SELECT**  key.

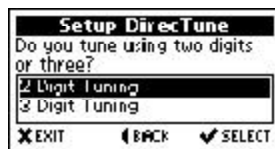

- *Note* If you were to tune to channel 23 using the number keypad, highlight  **2 Digit Tuning**  if you press 2+3 or  **3 Digit Tuning**  if you press 0+2+3.

# Getting Started

8



Highlight the method you use to tune channels and press the **SELECT** key.

If you choose **Press 2 + 3** or **Press 2 + 3 + Enter**, go to step 9.

If you choose **Press 2 + 3 + Other**, go to step 8b.



► *Note*

For most devices, you tune channels by pressing number keys or by pressing number keys followed by the **ENTER** key.

► *Note*

For some Cable box and Satellite receivers: If you press number keys and some key other than **ENTER** such as "Go", "Select", "OK", etc. to tune channels, highlight "Press 2 + 3 + Other" and press the **SELECT** key.

8b



Read and follow the instructions on the screen and press the **Right Arrow** key to continue.



8c



Highlight the appropriate key function for **Other** and press the **SELECT** key. (go to step 9)

For this example, the **"Other"** function is **Select**.

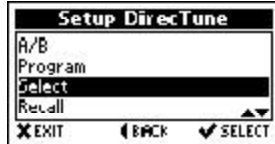

► *Note*

The **"Other"** function refers to a command you use to tune a channel after you press the digit keys.



# Getting Started

- 9  Read and follow the instructions on the screen and press the **Right Arrow** key to continue.



- 10  Test the **CHAN+ / CHAN-** key to see if your TV tunes channels properly.



Press the **Right Arrow** key when you are finished testing.

- 11  If your TV tunes channels properly, highlight **Yes** and press the **SELECT** key. (go to step 12)



If your TV does not tune channels properly, highlight **No** and press the **SELECT** key. (repeat step 10)

- *Note* Depending on your device you might need to test several tuning methods to find the correct one.

- 12  **DirecTune** setup is complete. Press the **Right Arrow** key.



- *Note* If you experience problems tuning channels after you set up **DirecTune\***, you should first try changing the **DirecTune Speed** in: **Main Menu > Remote Settings > Advanced Settings > Adjust DirecTune Speed** (see page 53). If this doesn't work then try changing the **DirecTune Method** in: **Main Menu > Remote Settings > Advanced Settings > Adjust DirecTune Method** (see page 51).

# Using the Remote

## 1. Channel Screen

The Channel screen is probably the most important and informative screen in the **GUIDE Remote\***. It tells you about the program you are watching, Interactivity Offers, current device mode, time and day. If the remote is controlling the **DirecTune\*** device, this screen is displayed whenever you tune to a channel.

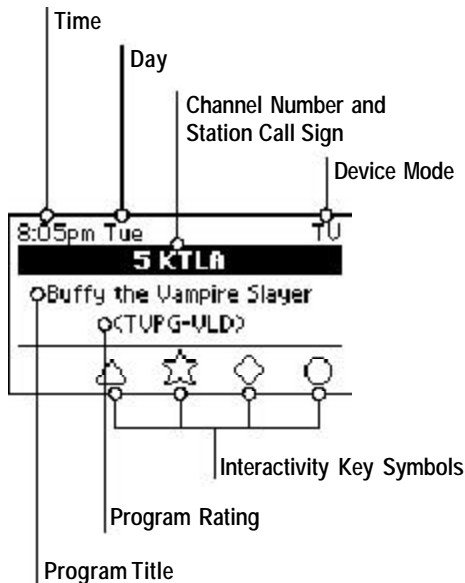

- ▶ *Note* To access the Channel screen, simply press the EXIT key. The Channel Screen appears only if your remote is controlling the **DirecTune\*** device.
- ▶ *Note* Some shows do not have Interactivity Offers. Shows without Interactivity Offers will not have Interactivity Key Symbols on the bottom of the Channel Screen.
- ▶ *Note* The Channel Screen in your remote will only show program titles, ratings and Interactivity Offers for channels you selected to appear in your Program Listings at the Website.

# Using the Remote

## 2. Changing Modes

- Set up all the devices you want to control with your **GUIDE Remote\***. Changing modes to control a device of your choice is fast and easy.

To change modes, perform the following steps:

- 1  Press the **Mode Right** or **Mode Left** key and a small popup screen will appear at the top of the remote screen indicating the current mode.



- 2  Press the **Mode Right** or **Mode Left** key again to switch to different modes. Continue pressing the **MODE** keys until you find the device you want to control.



- ▶ *Note* The current mode for your device is always indicated on the Channel and Promo Screens (see page 45).
- ▶ *Note* If there are no devices setup in your remote and you press a **MODE** key, a "NO DEVICES" popup appears.
- ▶ *Note* If more than one of any type of device is setup in your remote (i.e. 2 or more TVs or VCRs), they will be sequentially numbered (i.e. TV, TV#2, TV#3 or VCR, VCR#2, VCR#3, etc.). The devices will appear in the order that you set them up.

# Using the Remote

## 3. Using the GUIDE Key

### ■ Accessing Program Listings, Program Descriptions, Suggestions and Reminders

Your new **GUIDE Remote\*** contains three types of TV Listings, **Program Listings**, **Suggestions** and **Reminders**. You may also add detailed **Program Descriptions** by selecting that option at [www.GuideRemote.com](http://www.GuideRemote.com).

Press the **GUIDE** key to access **Program Listings**, **Program Descriptions**, **Suggestions** and **Reminders** in turn. Each press of the **GUIDE** key toggles to the next listing type.

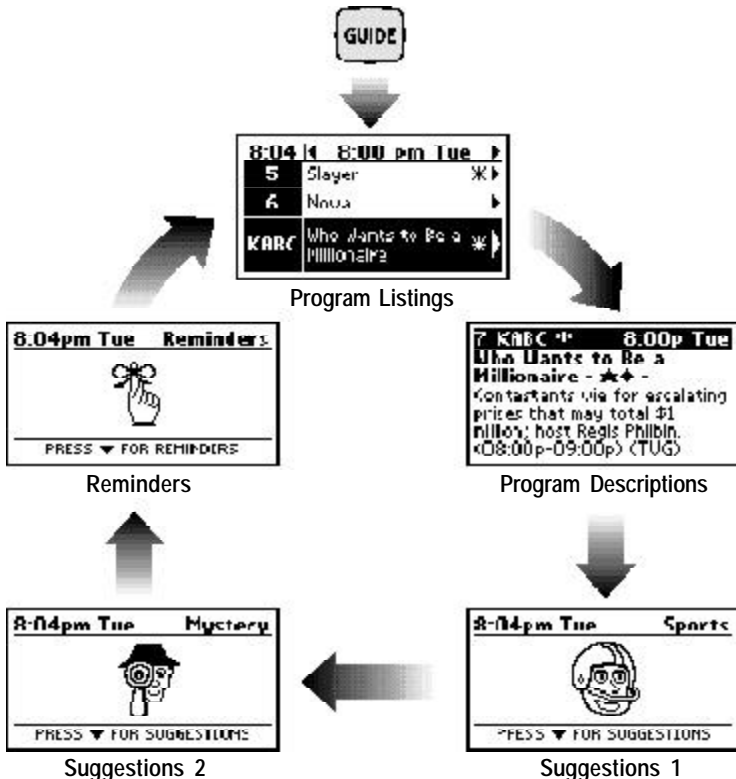

▶ *Note* The first type of TV Listings you will access are the Program Listings.

# Using the Remote

## Program Listings

**Program Listings** are TV Listings for up to 7 days that you personalize at our Website. Below is an example of a typical screen you will see when scrolling through the **Program Listings**. When you become familiar with the various items indicated on the screen, they will assist you in navigating quickly through the TV Listings in your remote.

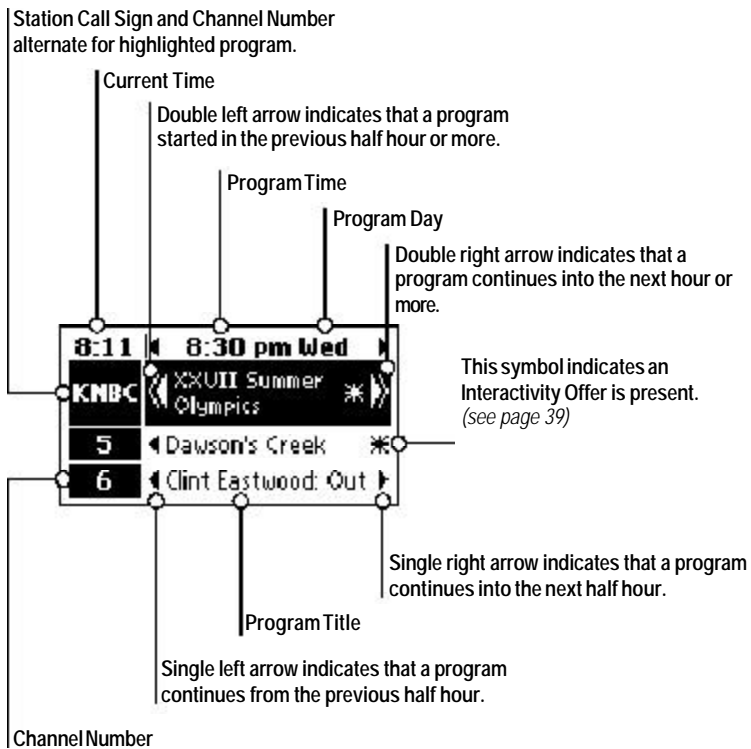

 **Tip** You can access the Program Listings at any time even if the remote is not controlling the **DirecTune**\* device. When you tune from within the Program Listings, the remote will automatically control your **DirecTune** device.

 **Tip** You can customize your CHAN + / CHAN - key to follow the channel lineup of your Program Listings. (see Channel Key Settings on page 55)

# Using the Remote

## Browsing and Tuning

One of the most beneficial features of the **GUIDE Remote\*** is being able to find a show in the **Program Listings** and tune directly to it with a single keypress.

To tune to a show in the **Program Listings**, perform the following steps:

-  Press the **GUIDE** key to enter the **Program Listings**.

▶ *Note* If you are in *Suggestions or Reminders*, continue pressing the **GUIDE** key until you access the *Program Listings*.

-  Press the **Up / Down Arrow** key to move the highlight bar to the channel you want to watch.

 Press the **Left / Right Arrow** key to see what show is on in the previous or next time slot.

 Press the **SELECT** key to tune to the highlighted show.



 *Tip* To scroll quickly through the *Program Listings* press and hold the *Up / Down* or *Left / Right Arrow* key. (see *Quick Browse* page 30)

▶ *Note* If you continue to hold the *Left / Right Arrow* key you will eventually see an "End of TV Listings" popup. This indicates that you have reached the beginning or end of *Program Listings*.

▶ *Note* If you highlight a show that is not currently airing and you press the **SELECT** key, your TV will tune to the channel you highlighted even if the show is not on TV at that time.

▶ *Note* Once you tune to a channel, a *Channel Screen* will appear with details about the show you're watching. (see page 25)

▶ *Note* You may tune from within the *Program Listings* only if you have set up a **DirecTune\*** device.

# Using the Remote

## Quick Browse

Quick Browse allows you to quickly navigate the **Program Listings**. There are two types of quick browse: Channel and Time.

### Channel Quick Browse

This feature allows you to quickly navigate the channels in the **Program Listings**.



Press and hold the **Up / Down Arrow** key and a channel popup will appear.

Continue to hold the key until the channel you want to watch appears. Release the key to return to the **Program Listings**.



### Time Quick Browse

This feature allows you to quickly navigate among time slots in the **Program Listings**.



Press and hold the **Left / Right Arrow** key and a time popup will appear.

Continue to hold the key until the desired time slot appears. Release the key to return to the **Program Listings**.



# Using the Remote



## Program Descriptions

The **Program Descriptions** in your **GUIDE Remote\*** give you detailed information about the show you want to watch. Besides brief info about the show, **Program Descriptions** tell you when the show starts and ends, actors in the show, ratings, and Interactivity Offers. Additionally, you can browse and request Interactivity Offers from the present, past, or the future within **Program Descriptions**. (see Interactivity Offers on page 37-39)

## Accessing and Tuning

To access the Program Descriptions, perform the following steps:

- 1  Press the **GUIDE** key to enter the **Program Listings**.

- 2   
 Press the **Up / Down Arrow** key to move the highlight bar to the channel you want to watch.

-  Press the **Left / Right Arrow** key to see what show is on in the previous or next time slots.

-  Press the **GUIDE** key to access the **Program Descriptions** for the highlighted show.

- 3  Press the **SELECT** key to tune to the described show.



 **Tip** Press the **Up / Down** or **Left / Right Arrow** key in the **Program Descriptions** to see the show descriptions of other channels.

 **Note** If you see an arrow pointing down on the bottom right of the screen, this indicated that the show description continues into the next screen. Press the **Down Arrow** key to access the next screen.



# Using the Remote

## Quick Browse

Quick Browse allows you to quickly navigate the **Program Descriptions**. There are two types of quick browse: Channel and Time.

### Channel Quick Browse

This feature allows you to quickly navigate the channels in the **Program Descriptions**.



Press and hold the **Up / Down Arrow** key and a channel popup will appear.

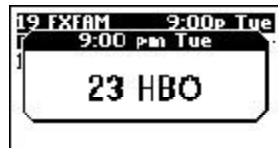

Continue to hold the key until the channel you want to watch appears. Release the key to return to the **Program Descriptions**.

### Time Quick Browse

This feature allows you to quickly navigate among time slots in the **Program Descriptions**.



Press and hold the **Left / Right Arrow** key and a time popup will appear.



Continue to hold the key until the desired time slot appears. Release the key to return to the **Program Descriptions**.

# Using the Remote

## Suggestions

**Suggestions** are TV show recommendations by our critics. Whether you are into classic movies, sports or comedies, our critics create a list of TV shows for you based on the types of shows you like to watch. Choose up to 2 critics at our Website and download the **Suggestions** into your remote. You may change your critics at any time at the Website.



To view the list of **Suggestions** by our critics in your remote, perform the following steps:

-  Press the **GUIDE** key until you see your **Suggestions** critic screen.

► *Note* Press the **GUIDE** key again to access your next **Suggestions** critic. (see page 27)

-  Press the **Down Arrow** key to access the **Suggestions** list.



-   
 Press the **Up / Down Arrow** key to browse the **Suggestions** list.



-  Press the **SELECT** key to tune to a highlighted show.

► *Note* If you highlight a show that is not currently airing and you press the **SELECT** key, your TV will tune to the channel you highlighted even if the show is not on TV at that time.

► *Note* Expired **Suggestions** are automatically deleted from the **Suggestions** list.

# Using the Remote

## Reminders

**Reminders** are TV programs you want to be prompted to watch at their scheduled times. Never miss taping or watching a show again. Set **Reminders** at the Website and the **GUIDE Remote\*** will beep and flash to remind you before the show begins.

Find out more about setting up **Reminders** at the Website in the *Support* section.

## Reminders Notification

If you have set up **Reminders** at the Website and have synced your remote, the **GUIDE Remote** will notify you by beeping and flashing 5 minutes prior to the scheduled show time and again at the start of the show.

To view the list of **Reminders** when the screen beeps and flashes, perform the following steps:

1



Press the **Down Arrow** key to access the list.

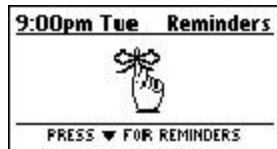

2



Press the **SELECT** key to tune to the highlighted show.





- ▶ *Note*     *The highlighted show is the one that you are being reminded to watch.*
- ▶ *Note*     *The Reminders screen automatically appears when the remote beeps and flashes.*

# Using the Remote

## Accessing the Reminders List

To view the list of **Reminders** in the remote, perform the following steps:

1  Press the **GUIDE** key until you see the **Reminders** screen.

2  Press the **Down Arrow** key to access the list.



3  Press the **Up / Down Arrow** key to browse the list.



Press the **SELECT** key to tune to a highlighted show.

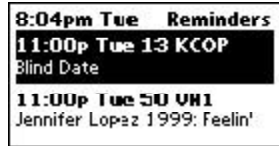

▶ *Note* If you highlight a show that is not currently airing and you press the **SELECT** key, your TV will tune to the channel you highlighted even if the show is not on TV at that time.

▶ *Note* Expired Reminders are automatically deleted from the Reminders list.

## Personal Reminders

**Personal Reminders** allow you to set your remote to remind you of a personal event you want to remember. If you have set up **Personal Reminders** at the Website and have synced your remote, the **GUIDE Remote\*** will prompt you by flashing and beeping at the scheduled time.

Find out more about setting up **Personal Reminders** at the Website in the *Support* section.

# Using the Remote

## 2. Using Interactivity Keys

**Interactivity keys** give you a chance to review and save exciting web offers related to TV programs or Ads. There is even a special key to express your opinion on a show you're watching. Browse the **Program Listings** to search for **Interactivity Offers** and tune to the show to find out what specific offers are available. Sync your remote and take advantage of web links in the *Links* section at our Website.

### Interactivity Keys

There are five Interactivity keys on the **GUIDE Remote**, **VOTE**, **CLIP**, **WIN**, **SHOP** and **INFO**. These keys allow you to review **Interactivity Offers** and request related links accessible from our Website.

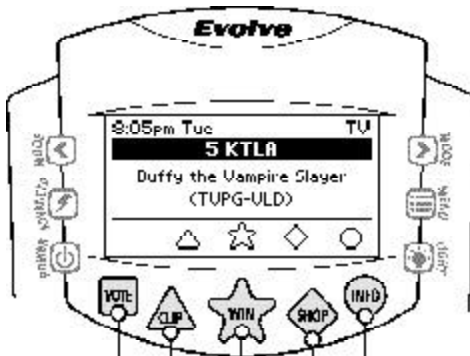

#### Find Out More

Get more information about the show you're watching.

#### Buy Smart

Find great stuff related to advertisers and your favorite TV shows.

#### Win Big

Enter sweepstakes and contests with incredible ease. Earn points for valuable bonuses.

#### Save Money





Find coupons, deals and savings related to what you're watching.

#### Voice Your Opinion

Rate what you're watching with the push of a button. See what others think at the Website.

# Using the Remote

## Interactivity Offers

Requesting **Interactivity Offers** is easy. Look for Interactivity Key Symbols     in the lower part of the Channel Screen (see page 25). If you see a symbol, press the corresponding Interactivity key to review the web offers. If you want more information, press the same key again and links related to the offers will appear on our Website next time you sync your **GUIDE Remote\***.

## Requesting Web Offers

To review and request web offers, perform the following steps:

-  Look for **Interactivity Key Symbols** on the bottom of the Channel screen.  
  
Press the appropriate Interactivity key(s) (**VOTE**, **CLIP**, **WIN**, **SHOP**, or **INFO**) to see web offers.

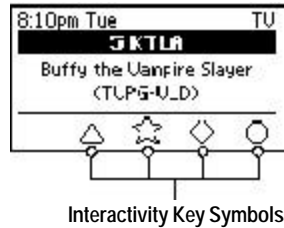

*For this example, we will use the **SHOP** key.*

- *Note* If the Channel Screen is not currently displayed, press the **EXIT** key.

-  Review web offers and press the same key again to save your request.



- *Note* Press the **EXIT** key if you want to cancel your request at this time.

- Your request is logged.  
  
To get your request, sync your remote and visit the **Links** section at our Website.

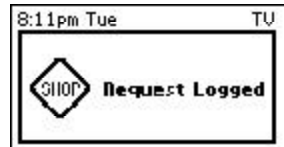

- *Note* You can only request Interactivity Offers while you're controlling the **DiracTune** device.

# Using the Remote

## Express Your Opinion with the Vote Key

If you really like the show you're watching or think it's so-so, let us know. Vote on any show at any time. You can rate shows as Excellent, Good, Okay, So-So or Bad.

To express your opinion on a show you're watching on TV, perform the following steps:

1



Press the **VOTE** key.

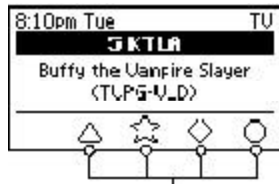

Interactivity Key Symbols

2



Press the **Up / Down Arrow** key to find the rating you want.

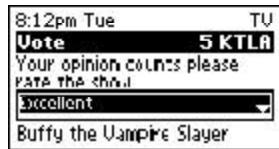

Press the **SELECT** or **VOTE** key to rate the show.

3

Your request is logged.

To view the results and see how others voted, sync your remote and visit the [Links](#) section at our Website.

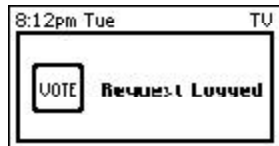

- ▶ **Note** You can only request Interactivity Offers while you're controlling the **DirecTune** device.

# Using the Remote

## ■ Browsing Interactivity Offers

If you want to see what shows have Interactivity Offers available, access the **Program Listings** and look for the Interactivity Offer Symbol  next to the program titles. Find out what Interactivity Offers are available in two ways.

(1) In **Program Listings**, highlight a show and press the **SELECT** key to access the Channel Screen. Look for Interactivity Key Symbols on the screen. (see *the Channel screen on page 25*)

(2) Look for Interactivity Offer Symbols in **Program Listings** and press the **GUIDE** key to access **Program Descriptions**. You will see Interactivity Key Symbols after the title of the show.

- The Interactivity Offer Symbol  appears next to the program titles in the **Program Listings**.



Interactivity Offer Symbol

- The Interactivity Offer Symbol  appears in the Quick Browse popup. (see *Quick Browse on page 30*)



Interactivity Offer Symbol

- Interactivity Key Symbols also appear in the **Program Descriptions**.





# Using the Remote

## 5. Using the MENU Key

You can configure or adjust settings, view settings and get support on the various features in the **GUIDE Remote\*** using the **MENU** key.

### Menu Screen

Below is an example of a typical menu screen. When you become familiar with the various items indicated, you will be able to navigate smoothly and easily within menu screens.



This symbol indicates that you can move the highlight bar up or down.

Press the SELECT key to choose the highlighted item on the screen.

Press the Left arrow key to go back to the previous screen.

Press the EXIT key to quit what you're doing and launch the Channel screen.

► *Note* You may press the EXIT key at any time to leave the menu.

# Using the Remote

## Remote Support

Your **GUIDE Remote\*** contains support and help information. Included in the support section under the Main Menu is a brief tutorial describing many **GUIDE Remote** features, including Interactivity keys, Mode selection, Navigation, the **ADVANCED** key, and Remote Control setup.

There are four Remote Support sections in the remote: **Help**, **Tour**, **About Remote** and **Contact Info**.

To access Remote Support press the **MENU** key. Highlight **Remote Support** and press the **SELECT** key.

### Help

Access **Help** for general assistance with key descriptions, remote features and settings, and additional information.



### Tour

Take the **Tour** for a brief tutorial describing many of the remote's primary features, including basic use, **Program Listings**, **Suggestions**, **Reminders**, Navigation, Interactivity Keys, and other useful information.



### About Remote

Find out the date the TV Listings expire, the electronic serial number, and additional remote-related information in **About Remote**.



### Contact Info

Find out how to contact us, or visit us at [www.GuideRemote.com](http://www.GuideRemote.com).



# Using the Remote

## Time and Date

The time and date are accurately updated automatically each time you sync your **GUIDE Remote\***. Additionally, you may set the time and date manually, for instance if batteries are removed and replaced.

To set the time and date manually, perform the following steps:

1 Press the **MENU** key and **SELECT** *Remote Settings > Time and Date*

2  Highlight **Set Time and Date** and press the **SELECT** key.





▶ *Note* If you choose *Display Time and Date* you will only be able to view the time and date and not adjust them.

3  Read and follow the instructions on the screen.

Press the **Right Arrow** key to continue.



4  Press the **Up / Down Arrow** key to adjust the numbers.

 Press the **Left / Right Arrow** key to change the cursor position. (*blinking indicates cursor position*)

 Press the **SELECT** key when you're finished.



▶ *Note* When you see the alert screen: "TIME AND DATE RESET," you can set the time and date as described in this section. However, we recommend that you sync your remote at [www.GuideRemote.com](http://www.GuideRemote.com) for the most accurate setting.

# Using the Remote

## 6. Using the ADVANCED Key

The **ADVANCED** key displays the Extended Function Screen. You can access all the key functions that are on your original remote when you press this key. A lightning-bolt ⚡ symbol next to the device mode indicates that you are in the Extended Function Screen.

### Extended Function Screen

Below is an example of a typical Extended Function Screen. When you become familiar with the various items indicated, you will be able to navigate smoothly and easily to the desired extended functions listed on the screens.

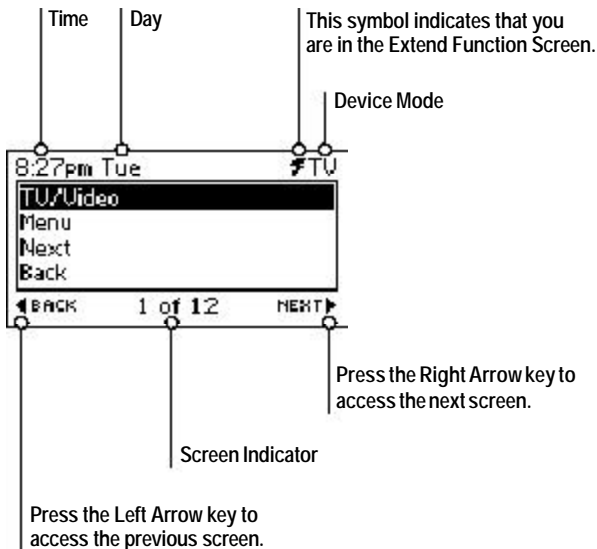

- ▶ **Note** *In the Extended Function Screens you may see more key functions than were on your original remote. If a particular function does not work for your device, verify that the function was designed to work with your original remote.*

# Using the Remote

## ■ Accessing the Extended Function Screen

To access the Extended Function Screen, perform the following steps:

- 1**  Press the **ADVANCED** key.

▶ *Note* If you are in the menu system, press the **EXIT** key and then press the **ADVANCED** key to access the Extended Function Screens.

- 2**  Press the **Up / Down Arrow** key to move the highlight bar.

 Press the **Left / Right Arrow** key to access the previous or next screen.

 Press the **SELECT** key to send a command to the device.

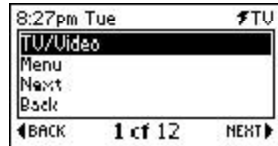

▶ *Note* You may see more functions in the Extended Function Screen than were on your original remote. If you experience a command not working, verify that you have selected a function that works on your original remote.

 *Tip* You don't have to exit the Extended Function Screen to change device modes. Press the **MODE** keys to change modes.

# Using the Remote

## 7. Using the LIGHT Key

Another key feature of the **GUIDE Remote\*** is the glow-in-the-dark **LIGHT** key that illuminates the LCD screen when pressed.

To use the **LIGHT** key, perform the following steps:



Press the **LIGHT** key to turn on the backlight.

Press the **LIGHT** key again while it is on to turn the backlight off.

- ▶ **Note** *The backlight will automatically turn itself off to save energy when the remote is idle. If you press keys other than the LIGHT key while the light is on the backlight will stay on. It will turn off if you stop pressing keys for several seconds.*

## 8. Promo Screens

The screen on your **GUIDE Remote\*** often displays messages and promotional offers. These are our Promo Screens. They tell you about new and exciting shows, suggest special offers or introduce you to some of our partners.

There are five kinds of Promo screens:

### ■ Informational

These screens give you information only. They tell you when a show is on or they may remind you to sync your remote.



- ▶ **Note** *To access the Promo Screens press the EXIT key at any time.*



## Using the Remote

### Request a Link

These screens offer you a link to an interesting or helpful website. You'll recognize these links by the  mark on the screen. If you're interested in what you see, click the **SELECT** key on your remote to save your request.



### Request an Email

These screens offer you a chance to receive a fun and informative email such as a horoscope, news, trivia games and more. You'll recognize these links by the  with a small envelope . If you're interested in what you see, click the **SELECT** key on your remote to save your request.

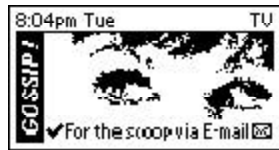

### Channel Tuning

These screens will help you tune to a special program or channel. When you press the **SELECT** key you will automatically tune to the suggested channel.



# Using the Remote

## Channel Promo screens

Channel Promo Screens will sometimes appear when you tune to a specific network or show on TV. These Promo Screens will generally give you information about the current network or future shows. These screens will disappear after a few seconds and will reappear when you press various keys on the remote.

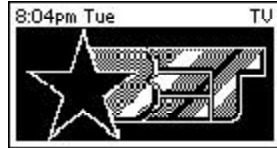

## Browsing Promos

Promo Screens will appear on your remote if it is idle for a couple of minutes or more. The Promo Screens will automatically change every few minutes. If you want to see all of the screens you can scroll through them one at a time.

To browse the Promo Screens, perform the following steps:



Press the **Left / Right Arrow** key to access all the Promo Screens.



▶ **Note** You must be viewing a Promo Screen in order to access other promo screens. If you are not currently viewing a Promo Screen, press the EXIT key.

▶ **Note** The graphics depicted in some screens are for illustration only and are for the user's convenience. Any references to third parties in the screens do not constitute sponsorship, endorsement, or approval of the GUIDE Remote by them. All trademarks, product names, company names and logos appearing on the screens are the property of their respective owners.



## 9. Alert Screens

The **GUIDE Remote\*** has various alert screens that will help you to operate the remote smoothly. Below are some examples of the types of screens that you might encounter.

### ■ No *DirectTune\** Device Found

You will see this screen when you try to exit out of a menu and did not setup a *DirectTune* device.



### ■ Please setup *DirectTune*...

You will see this screen when you press an Interactivity key and did not setup a *DirectTune* device. This screen will also appear if you did not set up a *DirectTune* device before attempting to request promos.

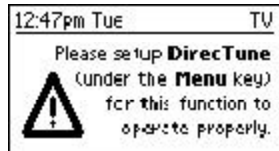

### ■ Please setup *DirectTune*

You will see this screen when you try to tune from within the **Program Listings** and did not set up a *DirectTune* device.



- ▶ *Note* To avoid seeing these screens, setup a *DirectTune\** device under the **MENU** key. (see page20 to setup *DirectTune*)

### ■ Time and Date Reset

You will see this screen when you install new batteries. You can set the time and date manually by pressing the **Right Arrow** key and going into the Set Time and Date section in the menu. For most accurate settings, we recommend that you log onto our Website and sync your remote.



# Using the Remote

## ■ Sorry, Offers Have Expired

You will see this screen when you press an Interactivity key and your TV Listings have expired. Log in at our Website and sync your remote to update your **Program Listings**.



## ■ Sorry, Requests Are Full

You will see this screen when you press an Interactivity key and you have exceeded the limit for requests. Log in at our Website and sync your remote, then try again.



## ■ Sorry, TV Listings Have Expired

You will see this screen when you press any of the Interactivity keys and your TV Listings have expired. Log in at our Website and sync your remote to update your TV Listings.



## ■ Sorry, Offers Have Expired

You will see this screen when you press an Interactivity key in the **Program Listings** and your Interactivity Offers have expired. Log in at our Website and sync your remote to update your **Program Listings** and Interactivity Offers.

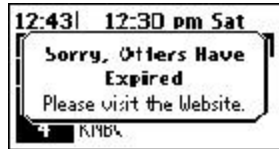

## ■ End of TV Listings

You will see this screen when you press the **Left / Right Arrow** key enough times to reach either the start or end of the **Program Listings**. Log in at our Website and sync your remote to update your **Program Listings**.

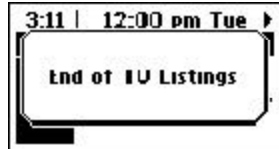

# Advanced Settings

## 1. View Device Settings

Under **View Device Settings**, you may examine the current setup of devices in your remote, including brand name, device type, control code, Volume Lock and Channel Lock.

To view device settings in your remote, perform the following steps:

- 1 Press the **MENU** key and *SELECT Remote Settings > Advanced Settings > View Device Settings*

- 2  Press the **Down Arrow** key to scroll down to see all of the settings for the device.



- 2 Press the **Right Arrow** key to view the settings for the next device.



- *Note* Press the **Right Arrow** key until you have viewed all of the device settings. If you continue to press the **Right Arrow** key you will return to the *Advanced Settings* menu.

## 2. View DirecTune\* Settings

Under **View DirecTune\* Settings**, you may examine the *DiracTune* settings in your remote, such as the *DiracTune* Device, *DiracTune* Speed and *DiracTune* Method.

To view *DiracTune* settings in your remote, perform the following steps:

- 1 Press the **MENU** key and *SELECT Remote Settings > Advanced Settings > View DirecTune Settings*

- 2  Press the **Right Arrow** key when you are finished reviewing.



# Advanced Settings

## 3. Adjust *DirectTune*\* Method

*DirectTune*\* can operate your TV tuning device using two different methods. If your channels are not changing properly after you setup *DirectTune*, first try adjusting the *DirectTune* speed (see page 53). If your channels still do not change properly, try the other *DirectTune* method.

To change the *DirectTune* Method, perform the following steps:

- 1 Press the **MENU** key and **SELECT Main Menu > Remote Settings > Advanced Settings > Adjust DirectTune Method**

- 2 Read and follow the instructions on the screen.



Press the **Down Arrow** key to read all the text.



Press the **Right Arrow** key to continue.



- 3 Highlight a Method and press the **SELECT** key.



Test the **CHAN+ / CHAN-** key to see if your TV tunes channels properly.



Press the **Right Arrow** key when you are finished testing.

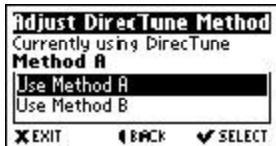

## Advanced Settings

5



If your TV tunes channels properly, highlight **Yes** and press the **SELECT** key. (go to step 6)

If your TV does not tune channels properly, highlight **No** and press the **SELECT** key. (repeat step 3)



- ▶ **Note** You may press the **EXIT** key at any time prior to selecting **Yes** to retain the current settings.

6



Adjusting  **DirecTune**  Method is complete.

Press the **Right Arrow** key.



# Advanced Settings

## 4. Adjust *DirecTune*\* Speed

The *DirecTune*\* speed in your remote can be set to tune your TV faster or slower. If your channels are not changing properly or seem to change too slowly, you can adjust the *DirecTune* speed.

To adjust the *DirecTune* speed, perform the following steps:

- 1 Press the **MENU** key and *SELECT Remote Settings > Advanced Settings > Adjust DirecTune Speed*

- 2 Read and follow the instructions on the screen.



Press the **Down Arrow** key to read all the text.



Press the **Right Arrow** key to continue.



- 3 Highlight a speed and press the **SELECT** key.



# Advanced Settings

- 4  Test the **CHAN+ / CHAN-** key to see if your TV tunes channels properly.



Press the **Right Arrow** key when you are finished.



- 5  If your TV tunes channels properly, highlight **Yes** and press the **SELECT** key. (go to step 6)

If your TV does not tune channels properly, highlight **No** and press the **SELECT** key. (repeat step 3)



- 6  Adjusting the **DiracTune** Speed is complete.

Press the **Right Arrow** key.



- ▶ **Note** If you experience problems after you tried all the **DiracTune\*** speeds, try adjusting the **DiracTune** method. (see page 51)

## 5. Channel Key Settings

Channel Key Settings allow you to operate the Channel keys in two different ways.

(1) The default setting in your remote is for the **CHAN + / CHAN -** key to change channels independent of the **Program Listings** you selected at the website. Therefore, when you press Channel keys your TV will tune to *all* the channels you get from your Service Provider (i.e. antenna, cable or satellite)

(2) You may choose to setup the **CHAN + / CHAN -** key to match your **Program Listings** lineup. In that case, when you press the Channel keys your TV will tune only to those channels in your **Program Listings** lineup. This gives you the flexibility to customize the channels however you like.

To set **CHAN + / CHAN -** key to match **Program Listings**, perform the following steps:

1 Press the **MENU** key and *SELECT Main Menu > Remote Settings > Advanced Settings > Channel Key Settings*

2 Read and follow the instructions on the screen.



Press the **Down Arrow** key to read all the text.



Press the **Right Arrow** key to continue.

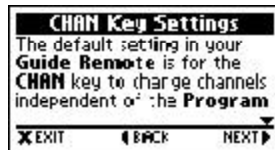



## Advanced Settings

3



Highlight **Yes** or **No** and press the **SELECT** key.

*For this example, we will select **Yes** to set the **CHAN + / CHAN -** key to match **Program Listings**.*



4



Channel Key Settings are complete.

Press the **Right Arrow** key.

*The **CHAN + / CHAN -** key is set to match the channel lineup in your **Program Listings**.*



# Advanced Settings

## 6. Add or Clear Channel Lock

Add or Clear Channel Lock in your **GUIDE Remote** allows you to set the **CHAN + / CHAN -** and **LAST** keys to control the device of your choice. For example, while you are using the remote to control your TV, the **CHAN + / CHAN -** and **LAST** keys could operate your cable box instead. By default, when you first set up your devices, each is set to control its own channel functions.

To Add or Clear Channel Lock for a device, perform the following steps:

*In the following example, we will be setting up Channel Lock so that **CHAN + / CHAN -** and **LAST** on a Toshiba TV will actually operate a Scientific Atlanta cable box instead. In other words, when you are controlling the Toshiba TV and you press the **CHAN + / CHAN -** and **LAST** keys, you will be changing the channels using the Scientific Atlanta cable box.*

- 1 Press the **MENU** key and **SELECT Remote Settings > Advanced Settings > Add or Clear Channel Lock**

- 2 Read and follow the instructions on the screen.



Press the **Down Arrow** key to read all the text.



Press the **Right Arrow** key to continue.



- ▶ *Note* You can view your current Channel Lock settings in the View Device Settings section: **Main Menu > Remote Settings > Advanced Settings > View Device Settings.**
- ▶ *Note* The default Channel Lock setting is for each device to control its own channel functions.

# Advanced Settings

3



Highlight the device you want to set Channel Lock on and press the **SELECT** key.

*For this example, we will set Channel Lock on a Toshiba TV. Therefore, when your remote is controlling the Toshiba TV, the **CHAN + / CHAN -** and **LAST** keys can be set to control another device of your choice.*



4



Read and review the current Channel Lock settings and press the **Right Arrow** key to continue.



5



Highlight the device that you want to control instead and press the **SELECT** key.

*For this example, we will select a Scientific Atlanta cable box. Therefore, when the remote is controlling the Toshiba TV, the **CHAN + / CHAN -** and **LAST** keys will control the Scientific Atlanta cable box instead.*



6



Channel Lock set up is complete.

Press the **Right Arrow** key.



# Advanced Settings

## 7. Add or Clear Volume Lock

Add or Clear Volume Lock in the **GUIDE Remote** allows you to set the **VOL + / VOL -** and **MUTE** keys to control the device of your choice. For example, while you are using the remote to control your cable box, the **VOL + / VOL -** and **MUTE** keys could operate your TV instead. By default, when you first set up your devices, each device is set to control its own volume functions.

To Add or Clear Channel Lock for a device, perform the following steps:

*In the following example, we will be setting up Volume Lock on so that **VOL + / VOL -** and **MUTE** on a Scientific Atlanta cable box will actually operate a Toshiba TV instead. In other words, when you are controlling the Scientific Atlanta cable box and you press the **VOL + / VOL -** or **MUTE** key, you will be changing the volume using the Toshiba TV.*

**1** Press the **MENU** key and **SELECT Main Menu > Remote Settings > Advanced Settings > Add or Clear Volume Lock**

**2** Read and follow the instructions on the screen.



Press the **Down Arrow** key to read all the text.



Press the **Right Arrow** key to continue.



► **Note** You can view your current Volume Lock settings in the View Device Settings section: **Main Menu > Remote Settings > Advanced Settings > View Device Settings.**

► **Note** The default Volume Lock setting is for each device to control its own volume functions.

# Advanced Settings



Highlight a device you want to set Volume Lock on and press the **SELECT** key.

*For this example, we will set Volume Lock on a Scientific Atlanta cable box. Therefore, when your remote is controlling the Scientific Atlanta cable box, the **VOL + / VOL -** and **MUTE** keys can be set to control another device of your choice.*



Read and review the current Volume Lock settings and press the **Right Arrow** key to continue.

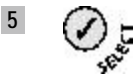

Highlight the device you want to control and press the **SELECT** key.

*For this example, we will select a Toshiba TV. Therefore, when the remote is controlling the Scientific Atlanta cable box, the **VOL + / VOL -** and **MUTE** keys will control the Toshiba TV instead.*

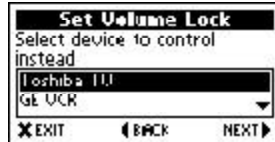

Volume Lock set up is complete.

Press the **Right Arrow** key.



# Troubleshooting

## General

### The Display is blank

- Make sure fresh batteries are properly installed.

### Devices do not respond to commands

- Make sure the remote is in the correct mode. See the top-right corner of the screen to check the current mode of the remote control.
- The battery power may be too low. If the Low Battery icon is displayed on the screen, replace all old batteries with new ones.
- The remote may not be pointed in the direction of the device. Point the remote directly at the desired device.
- The device may be too far away from the remote. Move to within 30 feet of the device.
- Something may be blocking the communication between the remote and the device. Check for objects that might be blocking the signal from the remote.
- Make sure the device you are trying to operate is an IR-compatible unit.

### CHAN + / CHAN - is skipping channels

- The battery power may be too low. If the Low Battery icon is displayed on the screen, replace all old batteries with new ones.
- Check your **Program Listings** for channel order. Pressing the **CHAN+ / CHAN-** key should tune to channels in the same sequence that appears in your **Program Listings**. If the Program Listings is missing a channel you want, visit the Website and edit your **Program Listings** in the *Settings* section.
- Try modifying the **DirecTune\*** speed in *Main Menu > Remote Settings > Advanced Settings > Adjust DirecTune Speed*. (see page 53)
- Try modifying the **DirecTune** method in *Main Menu > Remote Settings > Advanced Settings > Adjust DirecTune Method*. (see page 51)
- The remote may not be pointed in the direction of the device. Point the remote directly at the desired device.

### The Channel Screen is displaying different channel information from what's on TV.

- The remote may not be pointed in the direction of the device. Point the remote directly at the desired device and try again.
- The battery power may be too low. If the Low Battery icon is displayed on the screen, replace all old batteries with new ones.
- Retune the channel using the numeric key pad or by pressing the **CHAN+ / CHAN-** key.

- 
- *Note* If this problem persists too frequently, try adjusting the **DirecTune\*** speed or method. (see pages 51, 53)

# Troubleshooting

## The Time and Date Reset screen is displayed

- You will see this screen when you install new batteries. You can set the time and date manually in the remote (see page 42) or login to our Website and sync the remote.

## Setting up

### The brand name for my device is not listed

- Choose an UNKNOWN brand (last one on the list) and follow the setup procedure. (see Page 16 step 5)

### I made mistakes while setting up

- Press the **Left Arrow** key to go back to previous screens. Press the **MENU** key to start all over.

### I can't find the key functions on the remote to test the codes

- Access the Extended Function Screen by pressing the **ADVANCED** key and test the functions listed in the Extended Function Screen. (see pages 17, 18)

### None of the codes work for my device

- In a highly unlikely event, if none of the codes work for your device you can setup again and choose an UNKNOWN brand when you are asked to choose the brand for your device. You will be testing all the codes in the library. Although one of these codes may work for your device, we cannot guarantee it.

## Syncing

### I can't sync the remote

- Make sure you are connected to the Internet before syncing the remote.
- Make sure that the **RemoteLinker\*** cable is properly connected to the remote and the computer before syncing the remote.
- Check to see if the **RemoteLinker** software is configured to communicate with the serial port that is connected to the **RemoteLinker** cable. To access COM port settings, right-click on the **RemoteLinker** icon located in the lower right corner of your computer screen. Choose Settings. Select the number of the COM port to which you will be connecting the cable and click Apply.
- Make sure that no other software is using the serial port that **RemoteLinker** software is attempting to use.
- Read the Readme.wri file in Program Files\ RemoteLinker.

▶ *Note* If the **RemoteLinker\*** cable is not properly connected to your remote and the computer, you will see a "Trouble communicating with the remote" dialog box on the computer. Check and verify that the **RemoteLinker** cable is properly connected.

▶ *Note* If there is a communication error within your computer system, you will see a "Cannot initialize the serial port" dialog box on your computer. Make sure your serial port is not in conflict with any other software.

## What is my *DirecTune*\* device?

- This is the device that you use in your system to change channels (typically a TV, cable box, satellite receiver or VCR). To determine the  *DirecTune* device for your system, see page 20 for more details.

## The remote is in VCR mode, but where are the VCR keys?

- The VCR key functions are located in the Extended Function Screen under the **ADVANCED** key. To access them, press the **ADVANCED** key. Highlight the desired function and press the **SELECT** key to send the command.

- .....
- ▶ *Note* You may see more functions in the Extended Function Screen than were on your original remote. If you experience a command not working, verify that you have selected a function that works on your original remote.

## Why are there no program titles in the Program Listings?

- The **GUIDE Remote**\* stores up to seven days of TV Listings. If you have not downloaded the listings from the Website in more than seven days, the program titles will be blank. The program titles will appear again in your remote after you log in at our Website and sync your remote.
- Check to see if your time and date is set correctly. To access the time and date settings, press the **MENU** key and **SELECT Remote Settings > Time and Date > Display Time and Date**. If incorrect, set the correct time and date. (see page 42)

## How often should I sync my remote to update my TV Listings?

- We recommend that you sync your remote at least once a week. This ensures you have up-to-date TV Listings in your remote.

## Why are my Interactivity keys (VOTE, CLIP, WIN, SHOP, and INFO) not working?

- Make sure you have a  *DirecTune*\* device setup. (see page 20)
- Make sure that the remote is controlling the  *DirecTune* device. If not, press the **MODE** keys to access the  *DirecTune* device.
- Make sure that the TV Listings have not expired. To check the TV Listings expiration date, press the **MENU** key and **SELECT Remote Support > About Remote**. If the TV Listings have expired, log in at our website and sync your remote.

## I want to see my Interactivity Offer requests right away. Is this possible?

- Yes. You can sync your remote as often as you want. To review your InteractivityOffer requests, go to the Links sections at [www.GuideRemote.com](http://www.GuideRemote.com).



**Why can't I get seven days of TV Listings in my remote?**

- Some digital cable and satellite systems have hundreds of channels and unless you remove some from your listings at the Website, you might not be able to download a full seven days of listings into your remote. In the *Settings* section at the Website, reduce the number of channels in your listings to increase the number of days you can download into your remote.
- If you attempt to download **Program Descriptions** into your remote, and have a large channel lineup (generally greater than 65 channels), you may receive fewer than a full seven days of TV Listings. Try turning off the **Program Descriptions** option in the *Settings* section at the website and sync your remote again.

**Why are there no Program Descriptions for my Program Listings?**

- If **Program Descriptions** do not appear in your remote, go to the *Settings* section at the Website, turn on the option and sync your remote. **Program Descriptions** will then appear in your remote.

**Where can I review my requested Interactivity Offers and promos?**

- Log in to our Website and sync your remote. Then visit the *Links* in the *Members* section.

**How do I go back to the Channel Screen to see the Interactivity Opportunities?**

- First, you must have **DirectTune\*** setup in your remote. Then, click the **EXIT** key to access the Channel screen.

**How do I find out what my current DirectTune device is?**

- Go to View **DirectTune** Device by pressing the **MENU** key and **SELECT Remote Settings > Advanced Settings > View DirectTune Device**.

**How do I turn off the screen?**

- The screen on the remote is always on so that you have instant access to the TV Listings, Interactivity Offers, and special Promo Offers.

**Why is my TV tuning channels too slowly?**

- You may be able to adjust the **DirectTune** speed to change channels faster with your remote. (see *Adjust DirectTune Speed on page 53*)

**Why are some of my original remote functions not listed in the Extended Function Screen?**

- There is a possibility that more than one code will work when setting up your device. After you have completed setup, if you cannot find a function in the Extended Function Screens, remove the device and try setting up the device again using a different code.

# Specifications

## ■ Technical Specifications

### ■ Display Screen

1.1" x 2.1" (27.5 mm x 52.6 mm) LCD Screen  
Resolution 128 x 64  
Backlight with 20 second time-out for power management

### ■ Dimensions

3.3" x 6.3" x 1.6"

### ■ Weight

10 ounces

### ■ Serial Cable

Length: 6.0ft (1.8m)  
Computer RS-232 serial port connector  
9-pin, D-shell (female)

### ■ Memory

2 MB non-volatile flash memory  
512KB RAM

### ■ Batteries

4 - AA 1.5V batteries  
Battery life: 90 days with typical use

### ■ Operating Temperature

5°C (41°F) to +45°C (113°F)

### ■ Storage Temperature

0°C (32°F) to +55° (131°F)

# License Agreement

## Software License Agreement

This End User Software License Agreement ("Agreement") is between Evolve Products, Inc. ("Licensor") and you, the end user ("Licensee").

- 1. Grant of License.** Subject to the terms and conditions of this Agreement, Licensor grants Licensee a non-exclusive, nonsublicenseable license to use the software described below ("Software"). The Software is licensed and not sold. Licensee acknowledges and agrees that the Software contains trade secrets and other proprietary information of Licensor and Licensor's suppliers, and that Licensor and Licensor's suppliers retain all title to and, except as expressly and unambiguously licensed herein, all right and interest in the Software and all intellectual property rights worldwide therein. Software Description: The computer software, including without limitation, the operating system, file system, graphics system, and user applications embedded in, or subsequently downloaded to a remote control device sold by Licensor (the "Device").
- 2. Restrictions.** Licensee may use the one copy of the Software embedded in the Device. Licensee may not remove or in anyway disassemble the Software contained in the Device. The Software is licensed as a single product and may not be separated into its component parts for any reason whatsoever. Licensee shall not (and shall not allow any third party to) (i) decompile, disassemble, or otherwise reverse engineer (except to the extent expressly permitted under applicable law) or attempt to reconstruct or discover any of Licensor's source code, underlying ideas, algorithms, trade secrets or other proprietary information by any means whatsoever, (ii) remove any product identification, copyright or other notices, or (iii) provide, lease, lend, use for timesharing or service bureau purposes or otherwise use or allow others to use the Software to or for the benefit of third parties.
- 3. Termination.** This Agreement is effective until terminated. This Agreement will terminate automatically in the case of a breach of Section 2. (Restrictions). Upon termination, Licensee shall immediately cease all use of the Software and return or destroy all copies of the Software and all portions thereof and so certify to Licensor. Except for the license and except as otherwise expressly provided herein, the terms of the Agreement shall survive termination. Termination is not an exclusive remedy and all other remedies will be available whether or not the Agreement is terminated.
- 4. No Government Use.** Licensee represents that it is not a U.S. government agency and it is not acquiring the license pursuant to a U.S. government contract or with U.S. government funds; the license does not authorize or allow use by, or funded by, any U.S. governmental entity.

# License Agreement

5. **Warranty Disclaimer.** For a period of ninety (90) days, following Licensee's receipt thereof, Company warrants that the Software will substantially conform to Company's published specifications therefore, Licensee expressly acknowledges and agrees that, except as expressly set forth above, the Software is provided "AS-IS" and that use of the Software is at Licensee's sole risk.

**LICENSOR EXPRESSLY DISCLAIMS ALL WARRANTIES, EXPRESSED OR IMPLIED, INCLUDING, BUT NOT LIMITED TO, THE IMPLIED WARRANTY OF MERCHANTABILITY, FITNESS FOR A PARTICULAR PURPOSE AND NON-INFRINGEMENT. LICENSOR DOES NOT WARRANT THAT THE SOFTWARE WILL MEET LICENSEE'S REQUIREMENTS, OR THAT OPERATION OF THE SOFTWARE WILL BE UNINTERRUPTED OR ERROR-FREE, OR THAT DEFECTS IN THE SOFTWARE WILL BE CORRECTED. SOME STATES DO NOT ALLOW THE EXCLUSION OF IMPLIED WARRANTIES.**

6. **LIABILITY LIMITATION.** UNDER NO CIRCUMSTANCES, INCLUDING, WITHOUT LIMITATION, NEGLIGENCE, SHALL LICENSOR BE LIABLE FOR THE COST OF PROCUREMENT OF SUBSTITUTE GOODS, SERVICES OR TECHNOLOGY, OR FOR ANY INCIDENTAL, SPECIAL, OR CONSEQUENTIAL DAMAGES RESULTING FROM THE USE, OR INABILITY TO USE THE SOFTWARE, EVEN IF LICENSOR HAS BEEN ADVISED OF THE POSSIBILITY OF SUCH DAMAGES. SOME STATES DO NOT ALLOW THE LIMITATION OR EXCLUSION OF LIABILITY FOR INCIDENTAL OR CONSEQUENTIAL DAMAGES. IN NO EVENT SHALL LICENSOR'S TOTAL LIABILITY UNDER THIS AGREEMENT FOR ALL DAMAGES, LOSSES, AND CAUSES OF ACTION ((WHETHER IN CONTRACT, TORT (INCLUDING NEGLIGENCE) OR OTHERWISE)) EXCEED THE AMOUNT OF LICENSE FEES PAID TO LICENSOR HEREUNDER. THIS SECTION 6 DOES NOT LIMIT LIABILITY FOR DEATH OR BODILY INJURY OF A PERSON.
7. **General.** This Agreement may not be assigned or amended except with Licensor's prior written consent. No failure to exercise any right hereunder will operate as a waiver thereof. If any provision of this Agreement shall be adjudged by any court of competent jurisdiction to be unenforceable or invalid, that provision shall be limited or eliminated to the minimum extent necessary so that this Agreement shall otherwise remain in full force and effect and enforceable. This Agreement shall be construed pursuant to the laws of the State of California and the United States without regard to conflicts of laws provisions thereof and without regard to the United Nations Convention on Contracts for the International Sale of Goods. Licensee shall not export or remove the Software or any portion or direct product thereof from the country in which Licensee received delivery of the Software from Company. The sole jurisdiction and venue for actions related to the subject

## *License Agreement*

matter hereof shall be the California State and U.S. federal courts having within their jurisdiction the location of Company's principal place of business. The prevailing party in any action to enforce this Agreement shall be entitled to recover costs and expenses including reasonable attorneys' fees. The parties agree that a material breach of this Agreement by Licensee would cause irreparable injury to Licensor for which monetary damages would not be an adequate remedy and that the Licensor shall be entitled to equitable relief in addition to any remedies it may have hereunder or at law. This Agreement is the complete and exclusive statement of the mutual understanding of the parties, and supersedes and cancels all previous written and oral agreements and communications relating to the subject matter of this Agreement.

# Privacy Policy

## ■ Privacy Policy Summary

Respecting your rights to privacy is a top priority for us. We have published our Privacy Policy in detail on the web site, [www.GuideRemote.com](http://www.GuideRemote.com)\*, and we invite you to carefully read and understand it. Here we will just summarize the main points.

In order for the Evolve Network to function as intended, we must record, compile and store certain data. This includes data related to your personal demographics, remote use and television viewing.

For internal purposes, we use personal information provided by you to improve and customize your user experience. This includes providing customized TV listings in the form of **Suggestions** and **Reminders**, responding to your requests for information and performing the services for which such data was collected.

For external purposes, we collect data related to your web site experience, TV viewing habits and response to advertising carried on the **GUIDE Remote**\*. This data is compiled and sold to third parties, such as television networks and advertisers, on an aggregate basis. Although collected on each individual remote, once uploaded to our Network, this data is not associated in any way with your individual personal profile or information. We will never sell individual personal information to third parties. It is, however, an important part of our business to market aggregated demographic and activity information concerning our users to third parties, and we take steps to use this information responsibly. To maintain your privacy, in any instance where we collect personally identifiable data, we maintain this information separately from all aggregated data sold to third parties. Except where necessary, you have the option not to provide personal demographic information. You have the opportunity to opt-out of having your personal information used for purposes not directly related to our Network at the point where we ask for such information, or by sending us an email to [support@evolvecomm.com](mailto:support@evolvecomm.com).

If you have any further questions or comments after viewing our full Privacy Policy on the web site, please email us at [support@evolvecomm.com](mailto:support@evolvecomm.com). We hope you have a great experience using your new **GUIDE Remote**, and we pledge to responsibly protect any personal information you provide to us as you use it.

# Index

## A

- AA batteries, 8
- About Remote, 41
- Activate Remote Control, 8
  - Install Batteries, 8
  - Install RemoteLinker\* Software, 9
  - Install RemoteLinker Cable, 10
  - Start RemoteLinker Software, 11
- Add or Clear Channel Lock, 57, 58
- Add or Clear Volume Lock, 59, 60
- Adjust DirecTune\* Method, 51, 52
- Adjust DirecTune Speed, 53, 54
- ADVANCED key, 6, 17, 18, 43, 44
  - Accessing, 44
- Alert screens, 48, 49
  - End of TV Listings, 49
  - Expired, 49
  - No DirecTune Device Found, 48
  - Please setup DirecTune..., 48
  - Sorry, Offers Have Expired, 49
  - Sorry, Requests are Full, 49
  - Sorry, TV Listings Have Expired, 49
  - Time and Date Reset, 48
  - Arrow keys, 6

## B

- Backlight, 45
- Batteries, 8, 65
  - Installation, 8
  - Low Battery icon, 8
- Battery Cover, 3, 8
- Beep and Flash, 34

## C

- Changing Modes, 25
- Channel keys, 7, 24, 51, 54
  - Testing, 24, 51, 54
- Channel Key Settings, 55
- Channel Lock, 57
- Channel number, 25, 28
- Channel Promo screens, 47

- Channel Quick Browse, 30, 32
- Channel Screen, 25, 37
- Channel Tuning, 46
- CLIP key, 6, 36, 37
- Computer Requirements, 4

## D

- Day, 25
- Date settings, 42
- Determining DirecTune\* Device, 20
- Devices, 15
  - Remove, 19
  - Setup, 15
- DirecTune, 20
  - Determining, 20
  - Setting, 21
- DirecTune Method, 51
- DirecTune Speed, 53
- Display Screen, 65
- Download TV Listings, 12

## E

- ENTER key, 7
- EXIT key, 6
- Extended Function Screen, 43
  - Accessing, 44
  - Advanced key, 43
  - Testing, 17, 18
- Extended Function Symbol, 43

## F

- FAQ, 63, 64
- Flash, 34

## G

- GUIDE key, 6, 27

## H

- Help, 41

# Index

## I

- INFO key, 6, 36, 37
- Informational (Promo Screen), 45
- Interactivity keys, 5, 36, 37, 38
  - Browsing, 39
  - CLIP key, 6, 36, 37
  - INFO key, 6, 36, 37
  - Offers, 37, 39
  - SHOP key, 6, 36, 37
  - VOTE key, 6, 36, 38
  - WIN key, 6, 36, 37
- Interactivity Key Symbols, 25, 37
- Interactivity Offers, 37
- Interactivity Offer Symbol, 28, 39

## K

- Key Function Descriptions, 6, 7
- Key Layout, 5

## L

- LAST key, 7
- LIGHT key, 7, 45
- Low battery icon, 8

## M

- MENU key, 6, 40
  - Using, 40
- Menu Screen, 40
- MODE keys, 7, 26
- Mode popup, 26
- MUTE key, 7

## N

- Navigation keys, 6
- NO DirecTune Device Found, 48
- Numeric keys, 7

## O

- Offers
  - Interactivity, 37
  - Promos, 45

## P

- Personal Reminders, 35
- POWER key, 7
- Program Listings, 28
  - Accessing, 27
  - Browsing and Tuning, 29
  - Quick Browse, 30
- Program Title, 25, 28
- Program Rating, 25
- Promo Screens, 45
  - Browsing promos, 47
  - Channel promo screens, 47
  - Channel Tuning, 46
  - Informational, 45
  - Request a link, 46
  - Request an email, 46

## Q

- Quick Browse, 30, 32
  - Channel Quick Browse, 30, 32
  - Time Quick Browse, 30, 32

## R

- Reminders, 34
  - Accessing, 27
  - Notification, 34
  - Personal Reminders, 35
  - Setting, 34
  - Tuning, 34, 35
- RemoteLinker\* Cable, 10
- RemoteLinker Icon, 10, 11
- RemoteLinker Software, 9, 11
- Remote Support, 41
  - About Remote, 41
  - Contact Info, 41
  - Help, 41
  - Tour, 41
- Remove a Device, 19
- Request an Email, 46
- Request a Link, 46
- Request Logged, 37, 38



# Index

## S

- SELECT key, 6
- Serial COM port, 10
- Set Time and Date, 42
- Setting Reminders, 34
- Setup Devices, 15
  - Testing codes with
    - ADVANCED key, 17, 18
- Setup DirecTune\*, 20, 21
- Setup a TV, 13
- SHOP key, 6, 36, 37
- Specifications, 65
- Station Call Sign, 25, 28
- Suggestions, 27, 33
  - Accessing, 27
  - Tuning, 33
- Sync Remote Control, 12

## T

- Time, 25, 28, 42
- Time and Date, 42
- Time and Date Reset, 48
- Time Quick Browse, 30, 32
- Tour, 41
- Troubleshooting, 61, 62
  - General, 61
  - Setting up, 62
  - Syncing, 62
- Evolve GUIDE Remote\*, 3

## U

- UNKNOWN brand, 13, 16

## V

- View Device Settings, 50
- View DirecTune\* Settings, 50
- Volume keys, 7
- Volume Lock, 59
- VOTE key, 6, 36, 38

## W

- Web offers, 37
- WIN key, 6, 36, 37



## Safety

Be sure to read all the safety information before you begin to use this product.  
CAUTION: TO REDUCE THE RISK DAMAGE TO YOUR EVOLVE GUIDE REMOTE, DO NOT REMOVE COVER (OR BACK). NO USER SERVICEABLE PARTS INSIDE. REFER SERVICING TO QUALIFIED SERVICE PERSONNEL.



## FCC NOTICE

This equipment was tested and complies with Part 15 of the FCC rules. Operation is subject to the following conditions: (1) this device may not cause harmful interference, and (2) this device must accept any interference received, including interference that may cause undesired operation.



## Service

This product should be serviced only by trained and qualified personnel.

For future reference, attach your sales receipt, and/or write down the date you purchased or received this product as a gift. This information will be required if service should be needed during the warranty period.

Model Number: \_\_\_\_\_

Serial Number: \_\_\_\_\_

Purchase Date: \_\_\_\_\_

Purchased At: \_\_\_\_\_

## ▶ **Limited Warranty**

The manufacturer of the **Evolve GUIDE Remote** warrants the product free from defects in material and workmanship for a period of 90 days from the date of purchase. This warranty applies to the original purchaser and is non-transferable. The remote will be replaced or repaired free of charge if found to be defective within the warranty period. This warranty does not cover the cost of shipping or handling.

## ▶ **Exclusions and Limitations**

This warranty does not cover:

1. Damage due to any accident, misuse, abuse, negligence, fire, water, lightning, or other acts of Nature.
2. Damage due to improper battery installation, tampering, alteration or repair performed or attempted by anyone other than an authorized **GUIDE Remote** service technician.
3. Damage in transit to finish or outer case.
4. Consequential damage to any other items used in connection with this product due to a defect in the product, or any other loss not specified in this warranty.

Some states do not allow limitations or exclusions on implied warranties or how long they remain in effect, so the above limitations may not apply to you.

## ▶ **Evolve GUIDE Remote\* User's Manual**

United States and international copyright laws protect the **Evolve GUIDE Remote** and User's Manual. No part of this manual may be copied or reproduced in any form without the express written consent of Evolve Communications, Inc. Information in this manual may be subject to change without notice.

The graphics depicted in some screens are for illustration only and are for the user's convenience. Any references to third parties in the screens do not constitute sponsorship, endorsement, or approval of the **GUIDE Remote** by them. All trademarks, product names, company names, and logos appearing on the screens are the property of their respective owners.

The Evolve logo, Evolve GUIDE Remote, GUIDE Remote, DirecTune and RemoteLinker are trademarks of Evolve Communications, Inc.

## ▶ **Service and Customer Support Contact**

**Email:** [Support@EvolveComm.com](mailto:Support@EvolveComm.com)

**Website:** [www.GuideRemote.com](http://www.GuideRemote.com)

**US Mail:** Evolve Communications, Inc.

152 Technology Drive, Suite 200  
Irvine, CA 92618



# **GUIDE REMOTE\***

**Evolve Communications, Inc.**  
152 Technology Drive, Suite 200  
Irvine, CA 92618

This product is covered by US Patents  
6002450, 5410326 and 5907322.  
Additional patents pending.

Printed in USA

## Free Manuals Download Website

<http://myh66.com>

<http://usermanuals.us>

<http://www.somanuals.com>

<http://www.4manuals.cc>

<http://www.manual-lib.com>

<http://www.404manual.com>

<http://www.luxmanual.com>

<http://aubethermostatmanual.com>

Golf course search by state

<http://golfingnear.com>

Email search by domain

<http://emailbydomain.com>

Auto manuals search

<http://auto.somanuals.com>

TV manuals search

<http://tv.somanuals.com>