



EVERFOCUS

1/3" Sony CCD Aluminum Box Housing
Color Camera
Operation Instructions

Model No. **EQ350/EQ250**

Please read this manual first for correct installation and operation. This manual should be retained for future reference. The information in this manual was current when published. The manufacturer reserves the right to revise and improve its products. All specifications are therefore subject to change without notice.

PRECAUTIONS

1. Do not install the camera near electric or magnetic fields.

Install the camera away from TV, radio transmitter, magnet, electric motor, transformer, audio speakers since the magnetic fields generate from above devices will distort the video images.

2. Never disassemble the camera nor put impurities in it.

Disassembly or impurities may result in trouble or fire.

3. Never face the camera toward the sun.

Direct sunlight or severe ray may cause fatal damage to sensor and internal circuit.

4. Keep the power cord away from water and liquid.

Touching the wet power cord may result in electric shock.

5. Never install the camera in areas exposed to water, oil or gas.

Water, oil or gas may result in failure, electric shock or fire.

6. Cleaning

Do not touch the surface of sensor by hand directly. Use a soft cloth to remove the dirt from the camera body. Use lens tissue or a cotton swab and ethanol to clean the sensor and the camera lens.

7. Do not operate the camera beyond the specified temperature, humidity or power source ratings.

Use the camera at temperatures within -10°C~50°C (14°F~122°F) and humidity between 20%~ 80%. The input power source are 12VDC/24VAC; 100~240VAC.

PREFACE

The EQ series is a solid-state color video camera specially designed for high quality surveillance applications. It incorporates break through DSP technology that provides most reliable and accurate color picture in security industry. The camera is compatible with C-mount or CS-mount lenses and come with an easy back-focus adjustment for user-friendly installation.

FEATURES

- Industry leading super high-res. with 560 TVL (EQ350 model), 380TVL(EQ250)
- Revolutionary integrated 10-bit Digital Signal Processor (DSP) delivers sharp color images and excellent picture quality
- Wide range automatic electronic shutter: 1/60 (1/50) ~ 1/100,000
- Auto line lock with external phase adjustment
- C/mount or CS-mount adjustable with easy back-focus adjustment wheel on the camera
- Smart FL mode for fluorescent light or 1/100 sec (NTSC)
- Utilizing innovative Pure Vision Technology

STANDARD ACCESSORIES

- Camera Unit x 1
- Accessory Pack includes
 - Mounting Base for bracket
 - M2 Screws x 4 for fixing mounting base
 - Lens Plug Connector
- Manual x 1

SPECIFICATIONS

Type	EQ350	EQ250
Pickup Device	1/3" SONY Super HAD CCD	
Picture Elements	NTSC: 768(H) x 494(V) PAL: 752(H) x 582(V)	NTSC: 510(H) x 492(V) PAL: 500(H) x 582(V)
Video Format	NTSC or PAL	
Scanning System	NTSC: 525 TV lines, 60 fields/sec PAL: 625 TV lines, 50 fields/sec	
Horizontal Resolution	560TVL	380TVL
Sensitivity	0.5Lux/F=1.2	0.3Lux/F=1.2
S/N Ratio	Over 48dB(AGC off)	
Electronic Shutter	1/50(1/60)~1/100,000	
Lens Type	C/CS mount Video Drive / Direct Drive	
Back Light Comp.	ON/OFF Switch	
Auto Gain Control	ON/OFF Switch	
Fluorescent Light	ON/OFF Switch	
Auto White Balance	Yes	
Gamma Correction	0.45	
Video Output	BNC 1.0Vp-p , 75ohm	
Sync. Mode	Line Lock/Internal Sync	
Power Source	2 types: 100VAC~240VAC 12VDC/24VAC	
Power Consumption	100VAC~240VAC 12W max 24VAC 7W max 12VDC 4.5W max	
Dimensions	57(W) X 51(H) X 140.2(D) mm; 2.25"(W) X 2"(H) X 5.52"(D)	
Weight	0.5kg ; 1.1lbs	
Operating Temperature	-10°C~50°C ; 14°F~122°F (20%~80% Humidity)	
Certification	FCC,CE	

DIMENSIONS

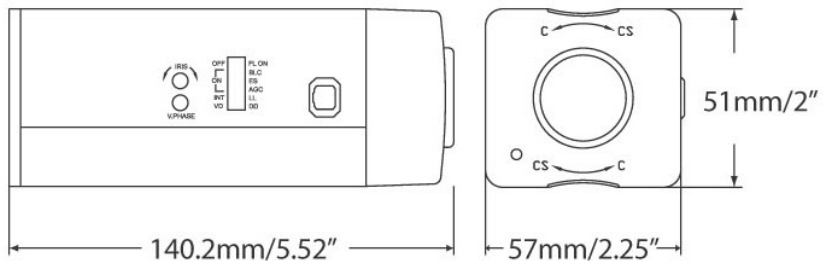

(Unit:mm/inch)

HARDWARE OVERVIEW

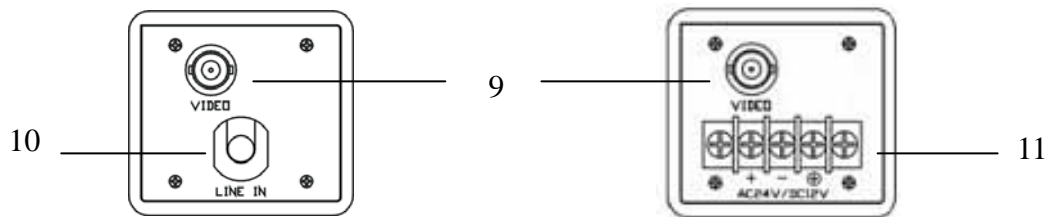
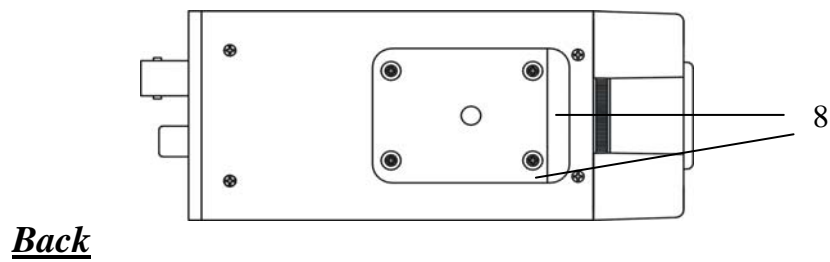
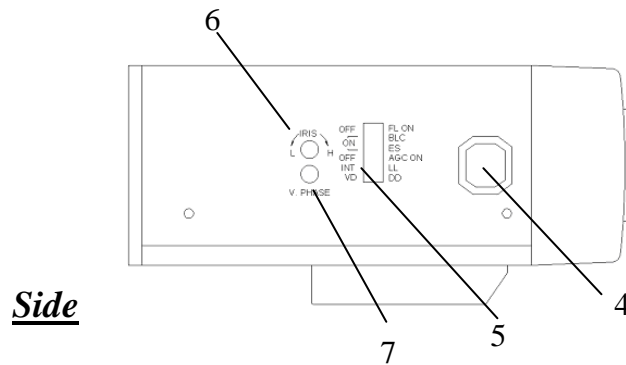
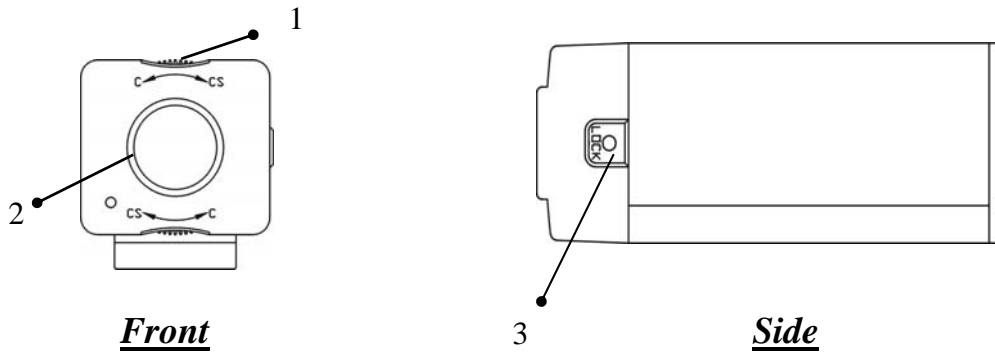

Pigtail Power Model without Audio

Dual Power Model without Audio

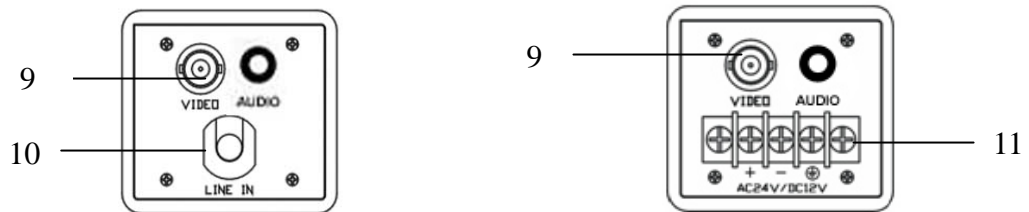

Pigtail Power Model with Audio

Dual Power Model with Audio

1. C/CS mount Focus Switch Ring

Use this ring to adjust the appropriate focal length according to the type of lens. Rotate the ring clockwise for the CS-mount lens, rotate it counterclockwise for the C-mount lens. The factory setting is CS-mount.

2. Lens Mount

To mount an appropriate C-mount or CS-mount lens.

3. Locking Screw

Use the locking screw to fix the focal length for **preventing losing focus**.

4. DC Lens Connector (4 pin socket)

To connect to the lens plug of the auto iris lens.

5. Camera Setting DIP Switches

There are 6 DIP switches located on the sideboard, which are for camera setting. The switches in order from top is **Flickerless, Back Light Compensation, Electronic Shutter, Automatic Gain Control, Line-Lock and Auto Iris Lens type**. Please see camera DIP switch setting section.

6. IRIS Level Control

Brightness Level can be adjusted from the IRIS level VR while using the direct drive lens.

Turn counterclockwise to L to get darker picture.

Turn clockwise to H to get brighter picture.

7. V-Phase Adjustment Screw

The vertical phase may require adjustment to synchronize the vertical phase of the camera with other camera in the system when it is being used in the line-lock sync mode. Make the adjustment when the vertical phase of the camera does not match with other cameras.

8. Mounting Base and Fixing Screws

The mounting base can be attached to either the top or the bottom of the camera, fix the mounting base onto the camera by using the 4 fixing screws in the accessory pack.

9. Video Output Connector

BNC VBS 1.0 Vp-p, 75ohm

10. Power Cable (EQ series)

Power cable varies in different model

11. Power Pigtail Cable / Power Terminal Pin (EQ series "A")

It varies in different models.

12. Audio Output (optional)

It varies in different models, RCA connector

INSTALLATION

1. Remove the lens cover cap.
2. If a C-mount lens is used, please make sure to turn the C-mount/CS-mount focus switch ring **at C position** before fixing the lens. **The default is CS mount.**
3. Screw the lens firmly onto the lens mount. Insert the lens plug into the DC lens connector if the auto iris lens is used.
4. Tighten the focus locking screw.
5. Connect the video output of the camera to a color monitor or other video device through a 75 ohm type coaxial cable with BNC female connector.
6. Connect the Power.
7. Once the image appears on the monitor, adjust the focus and diaphragm of the lens to obtain the best picture.
8. If the subject is not in focus when adjusting focus of lens, **turn the C-mount/CS-mount focus switch ring to do focal length adjustment as following:**
 - i. Loosen the locking screw of the focal length adjustment ring.
 - ii. Take picture of subject at a distance more than 20m away from the camera.
 - iii. Rotate the focal length adjustment ring to bring the subject in focus.
 - iv. Tighten the locking screw while the adjustment is completed.

Camera Setting DIP Switch

Fluorescent ON/OFF

This is a compensation function for against the images flicker fiercely during fluorescent light condition. Shooting the images in fluorescent light by using turn on the Fluorescent function, the default setting is Off.

BLC (Back Light Compensation) ON/OFF

When BLC is turned on, the AGC, ES and IRIS operating point is determined by averaging over the center area instead of entire field-of-view, so that a dimly-lit foreground object at center area can be clearly distinguished from brightly-lit backgrounds.

BLC should not be used unless it is needed to compensate for back-lit. The default setting is OFF.

ES (Electronic Shutter) OFF/ON

ES ON: The camera continuously adjusts the shutter speed from 1/60 (NTSC), 1/50 (PAL) second to 1/100,000 second according to the luminance conditions of the scene.

ES OFF: The shutter speed is fixed at 1/60 (NTSC), 1/50 (PAL) second.

Set ES OFF, when auto iris lens is used or flicker is observed under a very bright fluorescent lamp. Otherwise, turn ES on for optimum performance. The default setting is ON.

AGC (Automatic Gain Control) OFF/ON

AGC ON: The sensitivity increases automatically when light is low.

AGC OFF: A-low-noise picture is obtained under a low light condition.

The default setting is ON.

LL (Line-Lock) OFF/ON

To select the sync mode between Internal Sync.(LL off) and Line-Lock (LL on).

Set the line-lock off, the camera will synchronize to the internal time base. Set the line-lock on, the camera's vertical synchronization can be driven by the AC signal in the power lines.

Note: The cameras feature AC line lock for external synchronization, using the AC power

frequency (60Hz) is possible but not available in using DC or other operation power such as NTSC in 50Hz or PAL in 60Hz power system.

VD/DD (Auto Iris lens Type)

For video drive auto iris lens, please set switch to VD. For direct drive iris lens, set switch to DD. The default setting is DD. Wire the cable of lens to lens connector according to the following table.

	<u>Pin1</u>	<u>Pin2</u>	<u>Pin3</u>	<u>Pin4</u>	Lens Connector
Video Drive	+12V	GND	VD-IRIS	GND	1 3
Direct Drive	Cnt-	Cnt+	⁶ Drv+	Drv-	2 4

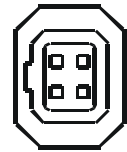

EverFocus Electronics Corp.

Head Office:

12F, No.79 Sec. 1 Shin-Tai Wu Road,
Hsi-Chih, Taipei, Taiwan
TEL: +886-2-26982334
FAX: +886-2-26982380
www.everfocus.com.tw

USA L.A. Office:

1801 Highland Ave. Unit A
Duarte, CA 91010, U.S.A.
TEL: +1-626-844-8888
FAX: +1-626-844-8838
www.everfocus.com

USA N.Y. Office:

415 Oser Avenue Unit S
Hauppauge, NY 11788
TEL: 631-436-5070
FAX: 631-436-5027
www.everfocus.com

Europe Office:

Albert-Einstein-Strasse 1
D-46446 Emmerich, Germany
TEL: 49-2822-9394-0
www.everfocus.de

China Office:

Room B-05D-1, KESHI PLAZA , Shangdi
Information Industry Base,
Haidian District, Beijing China
100085
TEL: +86-10-62973336/37/38/39
FAX: +86-10-62971423
www.everfocus.com.cn

Japan Office:

1809 WBG MARIBU East 18F,
2-6 Nakase.Mihama-ku.
Chiba city 261-7118, Japan
TEL: +81-43-212-8188
FAX: +81-43-297-0081
www.everfocus.com

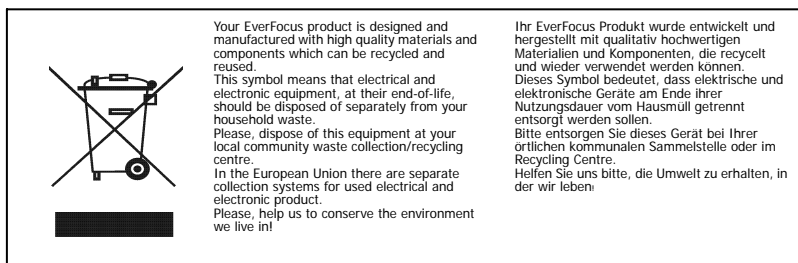

P/N: MED3G03000_Ver.B

Free Manuals Download Website

<http://myh66.com>

<http://usermanuals.us>

<http://www.somanuals.com>

<http://www.4manuals.cc>

<http://www.manual-lib.com>

<http://www.404manual.com>

<http://www.luxmanual.com>

<http://aubethermostatmanual.com>

Golf course search by state

<http://golfingnear.com>

Email search by domain

<http://emailbydomain.com>

Auto manuals search

<http://auto.somanuals.com>

TV manuals search

<http://tv.somanuals.com>