

gogo Kidz® Travelmate

Safety & Operating Instructions



Model UNIQR

Go-Go Babyz® Corporation

Downloaded from www.Scribd.com. All Manuals Search And Download.

EXPRESS LIMITED WARRANTY

Go-Go Babyz Corporation ("Go-Go Babyz") warrants this product to be free from defects in materials and workmanship for a period of one year from the date of purchase. Go-Go Babyz will repair or replace, at its sole option, the defective product within that one-year time period.

If you have a problem with your Go-Go Babyz product or are not satisfied with it, please contact Go-Go Babyz Customer Service at 1.888.686.2552.

This express limited warranty does not cover:

- (1) Pick-up, delivery, or freight charges.
- (2) Corrosion caused by improper storage or failure to reasonably protect the product from salt water and adverse conditions.
- (3) Deterioration due to lack of maintenance and cleaning as specified in the product instructions.

Go-Go Babyz SHALL NOT BE LIABLE FOR ANY INCIDENTAL OR CONSEQUENTIAL DAMAGES ARISING FROM BREACH OF ANY EXPRESS OR IMPLIED WARRANTY ON THIS PRODUCT. ANY IMPLIED WARRANTY, INCLUDING IMPLIED WARRANTIES OF MERCHANTABILITY AND FITNESS FOR A PARTICULAR PURPOSE, IS LIMITED TO THE DURATION OF THE EXPRESS, LIMITED WARRANTY (ONE-YEAR FROM THE DATE OF PURCHASE).

Under no circumstance shall any liability of Go-Go Babyz under this Express Limited Warranty, or otherwise, exceed the price of the defective product or parts.

Note: Some states do not allow the exclusion or limitation on incidental or consequential damages, so the above limitation may not apply to you. Some states do not allow limitations on how long an implied warranty lasts, so the above limitation may not apply to you.

This Express Limited Warranty gives you specific legal rights, and you may have other rights, which vary from state to state.

CONTACT GO-GO BABYZ' CUSTOMER SERVICE FOR INFORMATION AND ALL RETURNS:

Go-Go Babyz Returns
7013 Realm Drive, Suite C
San Jose, CA 95119
408.360.0653

Safety ..	4
General Information for Attaching the gogo Kidz	6
Attaching to Non-Britax Car Seats.....	7
Attaching to a Britax® or Fisher Price® car seat	8
Commercial Airlines, Car Seats and the gogo Kidz Travelmate	9
Care and Maintenance	10

DO NOT USE the gogo Kidz® Travelmate until you read and understand these instructions. Your child's safety depends on you reading and following these instructions.

 **WARNING: NEVER LEAVE CHILD UNATTENDED.**

 **WARNING: AVOID SERIOUS INJURY FROM FALLING OR SLIDING OUT. ALWAYS USE CAR SEAT RESTRAINT SYSTEM.**

Be sure to follow the manufacturer's instructions on how to properly secure your child in their car seat.

 **WARNING: DO NOT EXCEED WEIGHT AND SIZE LIMITATIONS OF THE CAR SEAT MANUFACTURER OR 50 LBS. MAXIMUM.**

This product is to be used as an add-on to your toddler car seat. The warnings and instructions are in addition to the safety manual provided by your car seat manufacturer.

 **WARNING: DO NOT LEAVE THE GOGO KIDZ ATTACHED TO A CAR SEAT WHILE DRIVING IN AN AUTOMOBILE. THE GOGO KIDZ HAS NOT BEEN TESTED IN COMBINATION WITH THE CAR SEATS IN ANY CRASH TESTING PROGRAM AND INJURY TO YOUR CHILD COULD OCCUR.**

 **WARNING: TO AVOID INJURY, KEEP CHILD AWAY FROM TELESCOPING HANDLE AND THUMBSCREWS. THIS IS NOT A TOY.**

 **WARNING: ALWAYS ENSURE THUMBSCREWS ARE TIGHT WHENEVER THE GOGO KIDZ IS ATTACHED TO THE CAR SEAT.**

Injury to your child could result if the unit were to come off accidentally when traveling with your child.

The thumbscrews may loosen over time or have been loosened without a parent's knowledge. Always check the thumbscrews prior to using the gogo Kidz.

 **WARNING: DO NOT USE WHILE EXERCISING**

Do not use this product while running, jogging, in-line skating or participating in other athletic activities.

 **WARNING: EXCESSIVE WEIGHT, PARCELS, OR ACCESSORY ITEMS PLACED OR HUNG ON THE HANDLE MAY CAUSE THE UNIT TO BECOME UNSTABLE.**

Do not place parcels or accessory items on the handle in excess of 3 pounds.

Do not allow children to play with or hang onto the gogo Kidz.

 **WARNING: DO NOT ALLOW CHILDREN TO CLIMB INTO OR OUT OF THE CAR SEAT WHILE GOGO KIDZ IS SECURED, UNLESS YOU ARE HOLDING THE GOGO KIDZ AND INSTRUCTING THE CHILD.**

 **WARNING: NEVER USE THE GOGO KIDZ ON STAIRWAYS OR ESCALATORS.**

 **WARNING: THE GOGO KIDZ IS DESIGNED TO ROLL.**

Make sure the front of the car seat is on the floor and the entire unit is on a flat surface before letting go of the handle.

Accessories which are not approved by the manufacturer or distributor should not be used.

 **WARNING: PLASTIC MATERIAL WILL WEAKEN OVER TIME IF EXPOSED TO EXCESSIVE HEAT OR LIGHT. USE OF THIS PRODUCT SHOULD BE DISCONTINUED 5 YEARS FROM THE DATE OF MANUFACTURER, AS SHOWN ON THE PRODUCT.**

General Attaching Information

General instructions for attaching the gogo Kidz® Travelmate to your car seat.

PLEASE SEE ASSEMBLY AND ATTACHING GUIDE FOR STEP BY STEP INSTRUCTIONS



Arrows pointing to car seat ribs

Most car seats have two ribs that go from top to bottom on the back of the car seat with a space between them. The handle area on the back of the gogo Kidz plate goes between the ribs in the space with the smooth, front side of the plate facing out.

Align the two support tabs on the bottom of the gogo Kidz plate at the bottom of the ribs to help support the car seat.

Lay the gogo Kidz plate on the back of the car seat. The wheels should be able to rotate freely.

Use appropriate attachment (i.e. short or long strap, retainer bar or j-bolts) and fasten to the plate and car seat.



Arrows pointing to support tabs

NOTE: Some car seats do not have these two long ribs in the back. For these types of seats, the support tabs on the bottom of the gogo Kidz should be located underneath the base itself.

NOTE: You may be required to move the bar on the back that adjusts shoulder straps to allow the handle to sit properly.

NOTE: The seat recline angle may have to be adjusted to make room for the support tabs or the wheels on some seats.

Attach the tether strap to the handle of the gogo Kidz plate to ensure the gogo Kidz is secure.

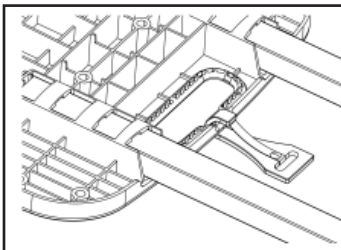

Attaching the tether clip to the gogo Kidz

RECOMMENDED CAR SEATS

The gogo Kidz® Travelmate will accommodate most convertible and toddler car seats. Please refer to the list of recommended car seats, located on the back page, to ensure a safe fit. Go-Go Babyz is continually testing new seats with the gogo Kidz and will update our web site frequently whenever we discover a new match or to confirm which seats will not fit with the gogo Kidz. If you do not see your car seat listed on the product box or manual, please check our web site to see if we have had to opportunity to test it with the gogo Kidz.

Instructions below are for attaching to Non-Britax / Fisher Price Car Seats.

You will use two thumbscrews, the short strap with two cleats attached by two o-rings and the tether strap from the car seat.

1. Place the seat face down on the floor.

2. Align the plate.

Align the two support tabs on the back side of the gogo Kidz plate to the bottom of the car seat and lay the gogo Kidz plate on the back of the car seat. (Please refer to general information if you are having difficulty)

3. Attach the strap.

Begin by securing the end of the strap that has only one grommet to either the left or right side of the gogo Kidz plate. Insert a thumbscrew into the highest hole possible on the plate and thread the thumbscrew into the cleat. The strap should be in between the plate and the cleat. Leave the strap loose because you will tighten it later. Make sure the strap is not twisted. Once one side is attached, thread the strap through the seat belt opening of the car seat.

NOTE: The cleat can be relocated if necessary to fit the needs of your particular car seat. To change the location of the cleat, remove the o-ring that attaches the cleat to the strap. Place the cleat over the proper hole and replace the o-ring.

6. Attach the other side of the strap.

Insert the thumbscrew into the other side of the plate, at the same height as the first side. Begin threading thumbscrew into the cleat. Retighten the first thumbscrew until it is almost flush with the plate. Then retighten the second thumbscrew again.

7. Test the connection.

Once the strap is tightened, lift the car seat and gogo Kidz into the upright position and test the connection by pulling on the handle and moving the gogo Kidz side to side. Retighten the strap.

8. Attach the tether strap.

The tether strap is connected to the car seat and attached onto the handle of the gogo Kidz plate (as shown on the general information page).

NOTE: ALWAYS SECURE YOUR CHILD WITH THE SAFETY HARNESS PROVIDED BY THE CAR SEAT MANUFACTURER.

Attaching to Non-Britax Car Seats



Make sure tabs align with ribs at the bottom of the car seat. Use opening if available

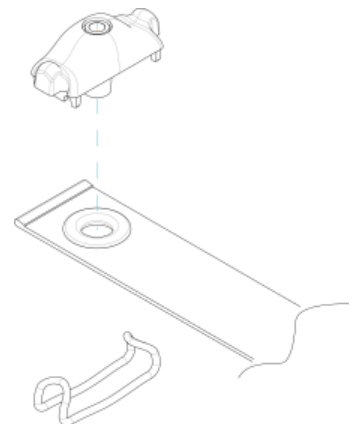

Adjusting the cleat on the strap

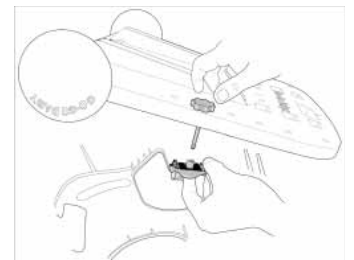

Leave thumbscrew loose until you begin threading opposite side, and then tighten

Attaching to a Britax® or Fisher Price® car seat



Shown above on Britax® Roundabout®



Shown above on Britax® Wizard®

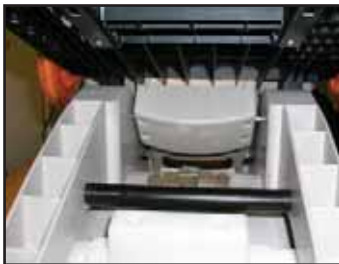

Looking in from the top of the seat (above) bottom (below)



Attaching to the Britax® & Fisher Price® car seats

NOTE: The gogo Kidz does not attach to the Britax® Parkway™

To attach to the Britax® or Fisher-Price® car seats, you will use two thumbscrews, the retainer bar and the tether strap from the car seat.

1. Place the seat face down on the floor.

2. Insert retainer bar.

Place the retainer with the flat side lying against the car seat. If you are using a Wizard® or Boulevard™ car seat, place the retainer bar above the metal bar on the back of the car seat.

3. Align the plate.

Align the support tabs at the bottom of the gogo Kidz plate with the bottom of the car seat and lay the gogo Kidz plate on the back of the car seat.

4. Insert thumbscrews.

Insert the thumbscrews into the two holes located in the center of the plate and tighten. You may need to hold the bar closer to the plate with your other hand while screwing in the thumbscrews. Retighten the first thumbscrew after tightening the second.

5. Test the connection.

Once the retainer bar been attached to the plate and the gogo Kidz is secure, lift the car seat and pull the gogo Kidz into the upright position. Test the connection by pulling on the handle and moving the gogo Kidz side to side. Retighten the thumbscrews as needed.

6. Attach the versa-tether strap.

Pull 10 inches of the “versa-tether” strap from the pouch that is located on the rear of the seat near the top. Pull the strap over the handle and tighten the “versa-tether” by pulling on the end of the tether strap. Place excess strap back into the pouch. Tuck in all remaining latch and tether straps in order not to get tangled when in use.

NOTE: ALWAYS SECURE YOUR CHILD WITH THE SAFETY HARNESS PROVIDED BY THE CAR SEAT MANUFACTURER.

Does the gogo Kidz® Travelmate fit down the aisle of an airplane? Can I leave it attached on an airplane? Any suggestions about the car seat and the airplanes?

Commercial Airlines, car seats and the gogo Kidz® Travelmate

Going Through Security

Some x-ray machines at the airport may be smaller and your car seat with the gogo Kidz Travelmate attached may not fit through the machine. We suggest asking the Security Personnel to "hand wand" your car seat with the gogo Kidz attached just like a stroller. Model UNIQR has quick release wheels so if needed you can remove the wheels to allow your car seat to fit through the smaller machines.

Airplane Aisles

The gogo Kidz is 16 ½ inches wide and fits down the aisle of most commercial airplanes. However, many car seats are wider and they may not fit down the aisle of the coach section. A practical approach is to have your child out of the seat and expect to carry the seat to your assigned seat, once you reach the coach section. The handle on the gogo kidz makes this easier to do than carrying the car seat by itself.

Airplane Seats

There are dozens of car seat manufacturers with multiple models of car seats. THE GOGO KIDZ® TRAVELMATE HAS NOT BEEN TESTED IN COMBINATION WITH THE CAR SEATS IN ANY CRASH TESTING PROGRAM. Remove the gogo Kidz and either stow it in the overhead bin or "gate check it." Fortunately, the gogo Kidz is very easy to put on and take off. Only one thumbscrew needs to be removed for the strap version and two thumbscrews for the Britax®, Fisher-Price® and Recaro® seats.

Note: We recommend you remove the strap and keep it with you if you check the gogo Kidz® Travelmate at the gate.

There have been reports of the aircraft seat belt buckle being stuck behind car seats, creating a removal problem at destination. You may wish to ask the flight attendant for a seat belt extender to eliminate the potential for this problem.

Other Airplane Information

We are updating our web site, www.gogobabyz.com, to include information and links that offer some very good general information about traveling with children on airplanes, safety issues and other practical suggestions. We recommend you take the time to review this information.

Before connecting the gogo Kidz to your car seat, make sure the unit is assembled correctly and all parts and fasteners are secure.

After assembly pull horizontally on the back of the gogo Kidz to make certain the guides are aligned properly and there is no slippage.

Confirm that thumbscrews are tight.

Periodically check that the handle, axle and wheels are secure.

Replace any damaged parts immediately.

Clean with a damp cloth and wipe dry.

Do not store unit outside exposed to rain or extreme sunlight.

Do not place heavy items on top of unit when storing it.



WARNING: PLASTIC MATERIAL WILL WEAKEN OVER TIME IF EXPOSED TO EXCESSIVE HEAT OR LIGHT. USE OF THIS PRODUCT SHOULD BE DISCONTINUED 5 YEARS FROM THE DATE OF MANUFACTURER, AS SHOWN ON THE PRODUCT.

Thank you!

Thank you for your recent order. We wish you many happy travels with your new gogo Kidz® Travelmate!

Our goal for Go-Go Babyz is to offer innovative, high quality and safe products to make life easier when you and your baby are “on the go.”

We welcome suggestions and comments. Go-Go Babyz is dedicated to making our current products and features easier to use. Please send ideas for new features, products or general feedback to us at info@gogobabyz.com.

In addition, we have created a photo gallery on our web site for families, like us, using Go-Go Babyz products. Please feel free to email or mail us any photos of you and your children using our products and we would be happy to share them on our Family Photo Gallery page.

Thank you again for your purchase. We appreciate your business.

Sincerely,

The Go-Go Babyz Family

Toll Free: 888.686.2552

www.gogobabyz.com



Free Manuals Download Website

<http://myh66.com>

<http://usermanuals.us>

<http://www.somanuals.com>

<http://www.4manuals.cc>

<http://www.manual-lib.com>

<http://www.404manual.com>

<http://www.luxmanual.com>

<http://aubethermostatmanual.com>

Golf course search by state

<http://golfingnear.com>

Email search by domain

<http://emailbydomain.com>

Auto manuals search

<http://auto.somanuals.com>

TV manuals search

<http://tv.somanuals.com>