

OWNER'S MANUAL & SERVICE GUIDE

**ST**

**EZGO 480**



**EZGO**

A Textron Company

## MANUAL INFORMATION

For any questions on material contained in this manual, contact a representative for clarification.

Read and understand all labels located on the vehicle. Always replace any damaged or missing labels.

On steep hills it is possible for vehicles to coast at greater than normal speeds encountered on a flat surface. To prevent loss of vehicle control and possible serious injury, speeds should be limited to no more than the maximum speed on level ground. (See vehicle specification.) Limit speed by applying the service brake.

Catastrophic damage to the drive train components due to excessive speed may result from driving the vehicle above specified speed. Damage caused by excessive speed may cause a loss of vehicle control, is costly, is considered abuse and will not be covered under warranty.

Be sure that this manual remains as part of the permanent service record should the vehicle be re-sold.

Throughout this guide, **NOTE**, **CAUTION** and **WARNING** will be used.

**NOTE** A **NOTE** indicates a condition that should be observed.

**CAUTION** A **CAUTION** indicates a condition that may result in damage to the vehicle.

**WARNING** A **WARNING** indicates a hazardous condition which could result in severe injury or death.

Please observe these notes, cautions, and warnings; be aware that servicing a vehicle requires mechanical skill and a regard for conditions that could be hazardous. Improper service or repair may damage the vehicle or render it unsafe.

**WARNING** *Engine exhaust from this product contains chemicals known, in certain quantities, to cause cancer, birth defects, or other reproductive harm.*

**NOTE** *The exhaust emissions of this vehicles' engine complies with regulations set forth by the Environmental Protection Agency (EPA) of the United States of America (USA) at time of manufacture. Significant fines could result from modifications or tampering with the engine, fuel, ignition or air intake systems.*

**WARNING** *Battery posts, terminals and related accessories contain lead and lead compounds. Wash hands after handling.*

**NOTE** *This spark ignition system meets all requirements of the Canadian Interference-Causing Equipment Regulations.*

*Ce système d'allumage par étincelle de véhicule respecte toutes les exigences du Règlement sur le matériel brouilleur du Canada.*

# OWNER'S MANUAL & SERVICE GUIDE

## ST 480

E-Z-GO Division of Textron Inc. reserves the right to make design changes without obligation to make these changes on units previously sold and the information contained in this manual is subject to change without notice.

E-Z-GO Division of Textron Inc. is not liable for errors in this manual or for incidental or consequential damage that result from the use of material in this manual.

CUSTOMER SERVICE DEPARTMENT IN USA PHONE: 1-800-241-5855 FAX: 1-800-448-8124

OUTSIDE USA PHONE: 010-1-706-798-4311 FAX: 010-1-706-771-4609

E-Z-GO DIVISION OF TEXTRON INC., P.O. BOX 388 AUGUSTA, GEORGIA 30903-0388 USA

**i**

## NOTES

---

To obtain a copy of the limited warranty applicable to the vehicle, call or write a local Distributor, authorized Branch or the Warranty Department with vehicle serial number and manufacture date code.

The use of non Original Equipment Manufacturer (OEM) approved parts may void the warranty.

Tampering with or adjusting the governor to permit vehicle to operate at above factory specifications will void the vehicle warranty.

When servicing engines, all adjustments and replacement components must be per original vehicle specifications in order to maintain the United States of America Federal and State emission certification applicable at the time of manufacture.

### BATTERY PROLONGED STORAGE

All batteries will self discharge over time. The rate of self discharge varies depending on the ambient temperature and the age and condition of the battery.

A fully charged battery will not freeze in winter temperatures unless the temperature falls below -75° F (-60° C).

# TABLE OF CONTENTS

TITLE	PAGE	TITLE	PAGE
<b>MANUAL INFORMATION</b> .....	<b>Inside Front Cover</b>	SERVICE BRAKE PEDAL .....	3-10
<b>NOTES</b> .....	<b>i</b>	PARK BRAKE .....	3-10
<b>SAFETY INFORMATION</b> .....	<b>2-1</b>	HORN .....	3-10
<b>OPERATION AND SERVICE INFORMATION</b> .....	<b>3-1</b>	DIFFERENTIAL LOCK .....	3-10
<b>BEFORE INITIAL USE</b> .....	<b>3-1</b>	<b>LOAD BED</b> .....	<b>3-11</b>
<i>Fig. 1 Initial Service Chart</i> .....	3-2	ELECTRIC LIFT BED OPERATION .....	3-11
<b>TERRAIN</b> .....	<b>3-2</b>	<i>Fig. 12 Electric Lift Switch</i> .....	3-11
<b>VEHICLE CAPACITY</b> .....	<b>3-2</b>	<b>OPERATING THE VEHICLE</b> .....	<b>3-12</b>
<b>MODIFICATIONS TO VEHICLE</b> .....	<b>3-3</b>	RUN-IN .....	3-13
<b>COMMON SENSE OPERATION</b> .....	<b>3-3</b>	<i>Fig. 13 Check Oil Level on Dipstick</i> .....	3-13
<b>POWER CONSUMPTION</b> .....	<b>3-3</b>	COLD STARTING .....	3-13
<b>ENVIRONMENTAL CONCERNS</b> .....	<b>3-4</b>	STARTING AND DRIVING .....	3-14
<b>OPTIONAL WINCH</b> .....	<b>3-4</b>	STARTING THE VEHICLE ON A HILL .....	3-14
OPERATION OF THE WINCH .....	3-4	COASTING .....	3-14
<i>Fig. 2 Winch Mounted to Vehicle</i> .....	3-4	FUEL .....	3-15
<i>Fig. 3 Winch Remote Control</i> .....	3-5	<i>Fig. 14 Fueling</i> .....	3-15
<i>Fig. 4 Winch Clutch Knob</i> .....	3-5	BATTERY .....	3-15
WINCH APPLICATIONS .....	3-5	LABELS AND PICTOGRAMS .....	3-16
<i>Fig. 5 Never Operate Winch with Less Than</i> <i>Five Turns Around Drum</i> .....	3-6	SUN TOP AND WINDSHIELD .....	3-16
<i>Fig. 6 Do Not Hook Cable to Itself</i> .....	3-7	12 VOLT POWER OUTLET .....	3-16
<i>Fig. 7 Use a Nylon Sling and Install a Damper when Winching</i> .....	3-7	<i>Fig. 15 12 Volt Power Outlet</i> .....	3-16
<i>Fig. 8 Do Not Pull at Angle</i> .....	3-8	TOWING A TRAILER .....	3-16
<b>CONTROLS AND INDICATORS</b> .....	<b>3-8</b>	<b>VEHICLE CLEANING AND CARE</b> .....	<b>3-17</b>
KEY/LIGHT SWITCH .....	3-8	VEHICLE CLEANING .....	3-17
<i>Fig. 9 Key/Light Switch, Low Oil Pressure Light and Fuel Gauge</i> .....	3-8	VEHICLE CARE PRODUCTS .....	3-17
DIRECTION SELECTOR .....	3-9	<b>REPAIR</b> .....	<b>3-18</b>
<i>Fig. 10 Console Controls</i> .....	3-9	LIFTING THE VEHICLE .....	3-18
CHOKE .....	3-9	<i>Fig. 16 Lifting the Vehicle</i> .....	3-19
FUEL GAUGE .....	3-9	WHEELS AND TIRES .....	3-19
LOW OIL PRESSURE INDICATOR LIGHT .....	3-9	Tire Repair .....	3-19
ACCELERATOR PEDAL .....	3-9	Wheel Installation .....	3-20
<i>Fig. 11 Accelerator, Brake and Horn</i> .....	3-10	<i>Fig. 17 Wheel Installation</i> .....	3-21
		LIGHT BULB REPLACEMENT .....	3-21
		<i>Fig. 18 Headlight and Turn Signal Bulb Replacement</i> .....	3-21
		<i>Fig. 19 Tail and Brake Light Bulb Replacement</i> .....	3-21
		FUSE REPLACEMENT .....	3-21
		VEHICLE WITH A DISCHARGED BATTERY .....	3-22
		<b>TRANSPORTING VEHICLE</b> .....	<b>3-22</b>

# TABLE OF CONTENTS

TITLE	PAGE	TITLE	PAGE
TOWING .....	3-22	SPARK PLUGS .....	3-37
NEUTRAL LOCK .....	3-22	BRAKES .....	3-37
<i>Fig. 20 Neutral Lock</i> .....	3-23	Daily Brake Test .....	3-37
HAULING .....	3-22	PROLONGED STORAGE .....	3-38
<b>SERVICE AND MAINTENANCE .....</b>	<b>3-23</b>	HARDWARE .....	3-38
SERIAL NUMBER PLATE LOCATION .....	3-25	<i>Fig. 37 Torque Specifications and Bolt Grades</i> .....	3-39
<i>Fig. 21 Serial Number Plate Location</i> .....	3-25	CAPACITIES AND REPLACEMENT PARTS .....	3-40
PERIODIC SERVICE SCHEDULE .....	3-26	<i>Fig. 38 Capacities and Replacement Parts</i> .....	3-40
<i>Fig. 22 Periodic Service Schedule</i> .....	3-26	<b>GENERAL SPECIFICATIONS.....</b>	<b>4-1</b>
TIRE INSPECTION .....	3-28	ST 480 .....	4-1
SEAT PROP .....	3-28	<i>Fig. 1 Vehicle Dimensions</i> .....	4-2
<i>Fig. 23 Seat Prop</i> .....	3-29	<i>Fig. 2 Vehicle Incline Specifications</i> .....	4-3
REPLACING THE FUEL FILTER .....	3-29	<i>Fig. 3 Vehicle Turning Clearance Diameter</i> .....	4-4
CHECKING THE OIL LEVEL .....	3-29	<b>LIMITED WARRANTY .....</b>	<b>5-1</b>
<i>Fig. 24 Oil Fill Cap, Dipstick and Fuel Filter</i> .....	3-30	<b>DECLARATION OF CONFORMITY .....</b>	<b>6-1</b>
<i>Fig. 25 Clean Entire Dipstick</i> .....	3-30	<b>LABELS AND PICTOGRAMS .....</b>	<b>APPENDIX A</b>
<i>Fig. 26 Check Oil Level on Dipstick</i> .....	3-30		
CHANGING THE OIL .....	3-30		
<i>Fig. 27 Oil Viscosity Chart</i> .....	3-31		
CHANGING THE OIL FILTER .....	3-32		
<i>Fig. 28 Oil Drain and Filter</i> .....	3-32		
LUBRICATION .....	3-32		
<i>Fig. 29 Lubrication Points</i> .....	3-32		
AIR CLEANER INSPECTION AND REPLACEMENT .....	3-33		
Pre-Cleaner Service .....	3-33		
Cartridge Service .....	3-33		
<i>Fig. 30 Air Cleaner</i> .....	3-33		
REAR AXLE .....	3-34		
Checking the Lubricant Level .....	3-34		
<i>Fig. 31 Add, Check and Drain Rear Axle Lubricant</i> .....	3-34		
STARTER/GENERATOR BELT TENSION .....	3-34		
<i>Fig. 32 Check Belt Tension with Gauge</i> .....	3-35		
<i>Fig. 33 Check Belt Tension with Finger</i> .....	3-35		
Adjusting the Belt .....	3-35		
<i>Fig. 34 Adjust Belt Tension</i> .....	3-35		
BATTERY CLEANING .....	3-36		
<i>Fig. 35 Preparing Acid Neutralizing Solution</i> .....	3-36		
AIR INTAKE AND COOLING FINS .....	3-36		
<i>Fig. 36 Cleaning Air Intake and Cooling Fins</i> .....	3-37		

## SAFETY INFORMATION

*Read all of manual to become thoroughly familiar with this vehicle. Pay particular attention to all Notes, Cautions and Warnings*

The Owner's Manual and Service Guide has been designed to assist in maintaining the vehicle in accordance with procedures developed by the manufacturer. Adherence to these procedures and trouble-shooting tips will ensure the best possible service from the product. To reduce the chance of personal injury and/or property damage, the following instructions must be carefully observed:

### GENERAL

Many vehicles are used for a variety of tasks beyond the original intended use of the vehicle; therefore, it is impossible to anticipate and warn against every possible combination of circumstances that may occur.

Good common sense and prudent driving practices do more to prevent accidents and injury than all of the warnings and instructions combined. The manufacturer strongly suggests that the owner-operator read this entire Owner's Manual and Service Guide paying particular attention to the CAUTIONS and WARNINGS contained therein. It is further recommended that other operators be encouraged to do the same.

If you have any questions, contact your closest representative or write to the address on the back cover of this publication, Attention: Product Service Department.

- E-Z-GO Division of Textron Inc. is not liable for errors in this manual or for incidental or consequential damages that result from the use of the material in this manual.
- E-Z-GO Division of Textron Inc. reserves the right to make design changes without obligation to make these changes on units previously sold and the information contained in this manual is subject to change without notice.
- This vehicle conforms to the current applicable standard for safety and performance requirements.
- These vehicles are designed and manufactured for off-road use. They do not conform to Federal Motor Vehicle Safety Standards of the United States of America (USA) and are not equipped for operation on public

streets. Some communities may permit these vehicles to be operated on their streets on a limited basis and in accordance with local ordinances.

- Vehicle capacity is limited to a maximum of two persons.
- Never modify the vehicle in any way that will alter the weight distribution of the vehicle, decrease its stability or increase the speed beyond the factory specification. Such modifications can cause serious personal injury or death. Modifications that increase the speed and or weight of the vehicle will extend the stopping distance and may reduce the stability of the vehicle. Do not make any such modifications or changes. The manufacturer prohibits and disclaims responsibility for any such modifications or any other alteration which would adversely affect the safety of the vehicle.

### GENERAL OPERATION

The following information is very important in the operation of the vehicle. The operator should read, understand and **always** observe the following:

- Use the vehicle in a responsible manner and maintain the vehicle in safe operating condition.
- Read, understand and observe all warnings and operation instruction labels affixed to the vehicle.
- Follow all safety rules established in the area where the vehicle is being operated.
- Reduce speed to compensate for unsuitable terrain or conditions.
- Apply service brake to control speed on steep grades.
- Reduce speed in wet areas.
- Use extreme caution and reduced speed when approaching sharp or blind turns.
- Use extreme caution and reduced speed when driving over loose terrain.
- Use extreme caution and reduced speed in areas where pedestrians are present.

# SAFETY INFORMATION

---

Read all of manual to become thoroughly familiar with this vehicle. Pay particular attention to all Notes, Cautions and Warnings

## MAINTENANCE

The following information is very important in the maintenance of the vehicle. The person performing maintenance procedures should read, understand and **always** observe the following:

- Maintain your vehicle in accordance with the manufacturer's periodic service schedule.
- Ensure that mechanics performing repairs are trained and qualified to do so.
- Follow the manufacturer's directions if you perform maintenance on your own vehicle. Be sure to disable the vehicle before performing any maintenance. Disabling includes removing the key from the key switch and removal of a battery wire.
- Insulate any tools used within the battery area in order to prevent sparks or battery explosion caused by shorting the battery terminals or associated wiring. Remove the battery or cover exposed terminals with an insulating material.
- Check the polarity of each battery terminal and be sure to rewire the battery correctly.
- Use specified replacement parts. Never use replacement parts of lesser quality.
- Use only tools recommended by the manufacturer.
- Determine that tools and procedures not specifically recommended by the manufacturer will not compromise the safety of personnel nor jeopardize the safe operation of the vehicle.
- Support the vehicle using wheel chocks and jack stands. Never get under a vehicle that is supported by a jack. Lift the vehicle in accordance with the manufacturer's instructions.
- Never attempt to perform vehicle maintenance in an area where exposed flame is present or persons are smoking.

- Be aware that a vehicle that is not performing as designed is a potential hazard and must not be operated until inspected and repaired.
- The manufacturer cannot anticipate all dangerous situations. People attempting to maintain or repair the vehicle must have the skill and experience to recognize and protect themselves from potential dangerous situations. These situations could result in severe personal injury or death and damage to the vehicle. Use extreme caution and if unsure as to the potential for injury refer the repair or maintenance to a qualified mechanic.
- Test drive the vehicle after any repairs are made or maintenance procedures performed to assure the vehicle is safe to return to service. All tests must be conducted in a safe area that is free of both vehicular and pedestrian traffic.
- Replace damaged or missing warning, caution or information labels.
- Keep complete records of the maintenance history of the vehicle.

## VENTILATION

- Always store gasoline vehicles in a well ventilated area to prevent gasoline fumes from accumulating.
- Never fuel a vehicle in an area that is subject to flame or spark. Pay particular attention to natural gas or propane water heaters and furnaces.
- Never work around or operate a vehicle in an environment that does not ventilate exhaust gases from the area. Carbon monoxide is a dangerous gas that can cause unconsciousness and is potentially lethal.



## OPERATION AND SERVICE INFORMATION

Read all of manual to become thoroughly familiar with this vehicle. Pay particular attention to all Notes, Cautions and Warnings



Thank you for purchasing a light duty utility vehicle. Before driving the vehicle, we ask you to spend some time reading this Owner's Manual and Service Guide and the Operating and Maintenance Instructions manual provided by the engine manufacturer. These manuals contain the information that will assist you in the safe operation of the vehicle. They will also assist you in maintaining this highly reliable vehicle. Some illustrations may show items that are optional for your vehicle.

This vehicle has been designed and manufactured as a 'World Vehicle'. Some countries have individual requirements to comply with their specifications; therefore, some sections may not apply in your country.

Most of the service procedures in this guide can be accomplished using common automotive hand tools. Contact your service representative on servicing the vehicle in accordance with the Periodic Service Schedule.

Service Parts Manuals, Technician's Repair and Service Manuals and engine Repair Manuals are available from a local Distributor, an authorized Branch or the Service Parts Department. When ordering parts or requesting information for your vehicle, provide vehicle model, serial number and manufacture date code.

### BEFORE INITIAL USE

**NOTE** Record the four digit key number and store in a safe place. Individual keys can **only** be replaced if the key number is known. Without a key number, the entire ignition switch will have to be replaced if keys are lost.

Read, understand and follow the safety label on the instrument panel (Ref Appendix A). Be sure you understand how to operate the vehicle, its equipment and how to use it safely. Maintaining good performance depends to a large extent on the operator.

**! WARNING !** *Improper use of this vehicle could result in severe injury or death. The ST Series vehicle is a light duty utility vehicle. It is NOT an all terrain vehicle (ATV).*

*This vehicle is not a toy and using it while engaging in horseplay is dangerous.*

*Plan carefully before using the vehicle to go significant distances over questionable terrain. Remember that a one hour drive may take many hours to walk out should you run out of fuel or be stranded by becoming stuck on unsuitable terrain.*

*Hydrogen gas is generated as a natural part of the lead acid battery charging process. A 4% concentration of hydrogen gas is explosive and could cause severe injury or death. Charging must take place in an area that is adequately venti-*

# OPERATION AND SERVICE INFORMATION

Read all of manual to become thoroughly familiar with this vehicle. Pay particular attention to all Notes, Cautions and Warnings

lated (minimum of 5 air exchanges per hour).

To reduce the chance of battery explosion that could result in severe injury or death, never smoke around or charge batteries in an area that has open flame or electrical equipment that could cause an electrical arc.

Before a new vehicle is put into operation, the items shown in the INITIAL SERVICE CHART must be performed (Ref Fig. 1 on page 3-2).

ITEM	SERVICE OPERATION
Battery	Charge battery
Seats	Remove protective plastic covering
Brakes	Check operation and adjust if necessary
	Check hydraulic brake fluid level
Tires	Check air pressure (see SPECIFICATIONS)
Fuel	Fill tank with correct fuel
Engine	Check oil level (Initial change after 5 - 8 hours)
Keys	Record key number and store in safe location

Fig. 1 Initial Service Chart

Vehicle battery must be fully charged before initial use.

Check for correct tire inflation. See GENERAL SPECIFICATIONS.

Check for oil or fuel leaks that could have developed in shipment from the factory.

Check for a firm brake pedal. Determine and record braking distance required to stop vehicle for future brake performance tests.

Record and keep key number.

Remove the protective clear plastic, that protect the seat bottom and back rest during shipping, before placing the vehicle in service.

## TERRAIN

The vehicle is designed for use on improved roads (but not on public highways). The vehicle may also be used on established trails or open terrain that is free from stumps, large rocks or holes.

The vehicle should not be used to cross water.

## VEHICLE CAPACITY



**WARNING** Due to the variety of ways the vehicle may be used, it is important that the operator consider any potential hazards before use to prevent serious injury or death.

The vehicle may be used to transport a **maximum of two people within the operator/passenger compartment** and cargo in the load bed. **Never carry passengers in the load bed.** The total payload is 800 lbs. (363 kg). The weight of the driver and passenger plus any options or accessories must be deducted from the total payload rating to determine the load bed capacity. Remember that towing a trailer will reduce the payload of the vehicle itself.

Remember that volume of your load can be misleading. Loading the vehicle to its rated capacity with dry sand, fertilizer, sod, etc. can be handled with complete safety. The same load when wet will grossly overload the vehicle and increase the potential for roll over and damage to the vehicle.

## OPERATION AND SERVICE INFORMATION

Read all of manual to become thoroughly familiar with this vehicle. Pay particular attention to all Notes, Cautions and Warnings

### MODIFICATIONS TO VEHICLE



*Changes to the weight distribution or the center of gravity may make it unstable or prone to roll over which could result in injury or death to the operator or passenger.*

Do not modify the vehicle in any manner that will change the weight distribution of the vehicle. Changes to the weight distribution or the center of gravity may make it unstable or prone to roll over which could result in injury or death to the operator or passenger.

### COMMON SENSE OPERATION

**This vehicle is not a toy.** If not operated properly and responsibly, it can cause severe injury or death to the operator, passenger or bystanders. All operators should possess a valid driver's license. Children should not be permitted to operate the vehicle. Children may not have the skill, judgement or strength to operate this or similar vehicles.

Alcohol, drugs and many over the counter medications reduce the ability of the driver to operate the vehicle safely. Always review side effects of any medication with a doctor or pharmacist before operating vehicle.

Protective clothing and an approved motorcycle helmet are recommended for operator and passenger at all times.

When driving at full speed on a dirt road, loose surfaces or wet grass, vehicle stopping distance will increase. If the vehicle is fully loaded, it will take longer to stop than with no load. When operating vehicle in wet weather conditions, remember that the brakes may need to be **lightly** applied in order to provide enough friction to dry the brake unit. If wet, the brakes will lose much of their effect.

Slow down when in unfamiliar terrain. Slow down when cresting a hill in an area that you are unfamiliar with.

Some hills are too steep to climb. If you attempt to climb a hill that is too steep or if you are unable to achieve adequate traction, **do not attempt to turn around on the hill. Slowly back straight down the hill using the service brake to control speed.**

### POWER CONSUMPTION

The vehicle uses a combination starter/generator to both start the engine and charge the battery. The engine will not idle; therefore, the battery cannot be charged while the vehicle is stopped. Do not operate accessory items (such as accessory lights, radios, winch, etc.) excessively while the vehicle is stopped.

**CAUTION** Overuse of accessories may drain the battery and leave insufficient reserve to start the vehicle.

The generator is only capable of supplying 35 amps; therefore, operation of all accessories could result in the discharge of the battery even though the engine is running and the generator operating. Discharging the battery is known as deep cycling. The battery is not a deep cycle model, but is a starting battery. Multiple deep cycling of the battery will result in the premature failure of the battery.

Vehicle battery must be fully charged before initial use.



*Hydrogen gas is generated as a natural part of the lead acid battery charging process. A 4% concentration of hydrogen gas is explosive and could cause severe*

## OPERATION AND SERVICE INFORMATION

Read all of manual to become thoroughly familiar with this vehicle. Pay particular attention to all Notes, Cautions and Warnings

**injury or death. Charging must take place in an area that is adequately ventilated (minimum of 5 air exchanges per hour).**

**To reduce the chance of battery explosion that could result in severe injury or death, never smoke around or charge batteries in an area that has open flame or electrical equipment that could cause an electrical arc.**

### ENVIRONMENTAL CONCERNS

As a responsible user, practice respect for all wildlife and their habitat. Respect private property and comply with all local laws and regulations governing the use of light duty utility vehicles. Do not tamper with the exhaust system or governor. The exhaust system has been tuned to the engine for maximum performance. Removal or modification of the exhaust is annoying to other people and will not improve the performance of the vehicle.

#### **⚠ WARNING ⚠**

**To prevent severe injury or death while driving, be aware of the following:**

**Environmental hazards such as steep slopes, overhanging limbs, etc.**

**Danger of fire when vehicle is operated over dry combustible organic material.**

When driving, be aware of environmental hazards such as steep slopes, overhanging limbs, etc. Be aware of the danger of fire when the vehicle is operated over dry combustible organic material.

### OPTIONAL WINCH

This vehicle may be equipped with an optional winch. Read, understand and follow all of the following information on the operation and use of the winch before attempting to operate it.

#### OPERATION OF THE WINCH

The winch can be mounted at the front or rear of the vehicle and moved to accommodate different situations. At the front, it is mounted under the center of the front cowl to a bracket attached to the front axle as shown (Ref Fig. 2 on page 3-4). At the rear, the winch is mounted upside down in the hitch receiver.

**NOTE** *If mounting winch at rear of vehicle, the winch must be mounted upside down.*

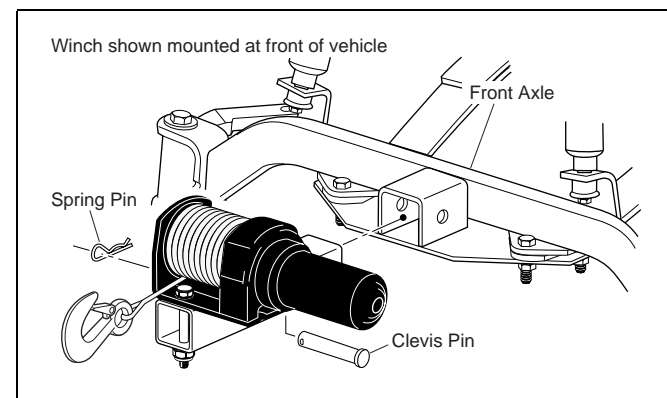

Fig. 2 Winch Mounted to Vehicle

## OPERATION AND SERVICE INFORMATION

Read all of manual to become thoroughly familiar with this vehicle. Pay particular attention to all Notes, Cautions and Warnings

Before moving the winch, unplug the winch connector from the wire harness. To move the winch from one end of the vehicle to the other, remove the spring pin, pull out the clevis pin and remove the winch mount tube from the receiver. Move to opposite end of vehicle and install by inserting clevis pin and securing with spring pin. Plug the winch connector into wire harness.

The winch remote control plugs into the receptacle on the driver side of the seat support (Ref Fig. 3 on page 3-5).

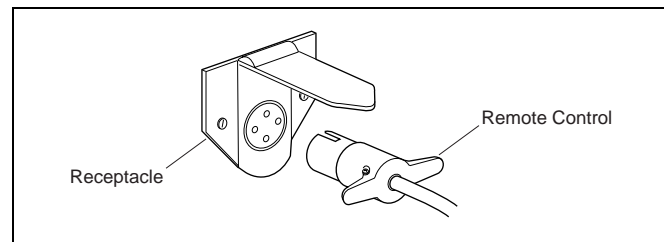

Fig. 3 Winch Remote Control

To unwind the cable, locate the clutch knob on the winch. Pull out knob and rotate 90° to lock out. Using handsaver bar, pull cable from winch drum. Leave at least five turns of cable on drum. Re-engage drum by turning clutch knob 90°, returning it to original position (Ref Fig. 4 on page 3-5).

To wind cable, use handsaver bar to keep tension on the cable while activating remote. When winding cable, make sure the cable winds tightly and evenly onto the drum leaving no gaps that could cause premature wear to the cable. When using winch under a load, operate the remote control from as far to the side of the vehicle as possible. Do not

operate winch while sitting in passenger seat. Read the following section (Winch Applications) before attempting to operate winch.

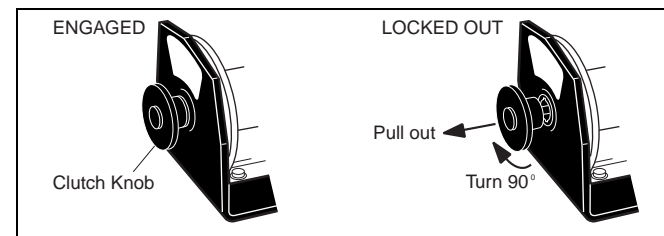

Fig. 4 Winch Clutch Knob

### WINCH APPLICATIONS

The winch may be used for a number of purposes, including pulling the vehicle if it loses traction on unsuitable terrain.

**⚠ WARNING ⚠** *Improper use of the winch could result in a number of conditions that could cause severe injury or death to operator, occupants of vehicle or bystander.*

It is impossible to predict all conditions that the winch could be used, therefore the following warnings should not be considered as complete. Before operating the winch, consider the possible dangers and take precautions to protect yourself, your passenger and any bystanders.

**⚠ WARNING ⚠** *To prevent severe injury or death to operator, occupants or bystanders, select the object to which the cable is attached with the following considerations:  
Make sure the object cannot be pulled over or otherwise damaged.*

## OPERATION AND SERVICE INFORMATION

Read all of manual to become thoroughly familiar with this vehicle. Pay particular attention to all Notes, Cautions and Warnings

*The object the winch is attached to could fall on the vehicle and it's occupants.*

*If attaching the winch to a dead tree, a section could fall.*

When pulling vehicle with winch, pull straight only. **Do not permit the cable to contact the side of the drum.**

**⚠ WARNING ⚠** *Do not pull vehicle at angle. If the vehicle is pulled at an angle, it could turn over causing severe injury or death to anyone in the area. The winch cable could also become overstressed and break causing severe injury or death to anyone struck by the cable.*

If the vehicle becomes stuck or 'hung up' on an obstruction, the vehicle may be moved using the winch.

The winch may be installed in either the front or rear receiver and held in place with the locking pin provided.

**⚠ WARNING ⚠** *To prevent severe injury or death, read and understand the following before attempting to use the winch:*

*The winch is not intended to be used in any hoisting operation.*

*The rolling load capacity of the winch decreases with the steepness of the slope.*

*The winch is designed for intermittent duty only. The electric motor should not be allowed to become excessively hot. If the motor becomes uncomfortably hot to the touch, stop winching and allow the motor to cool.*

*Always wear thick leather gloves when handling the wire cable.*

*Replace frayed wire cable with a direct factory replacement only.*

*Never operate the winch with less than five (5) full turns of cable around the drum (Ref Fig. 5 on page 3-6).*

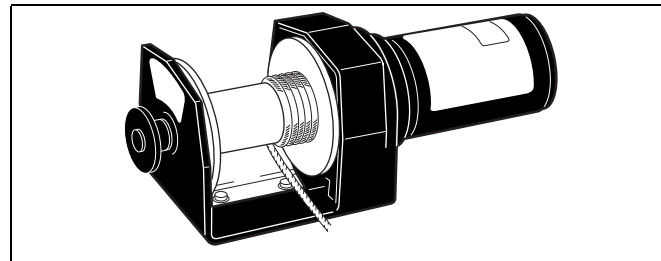

**Fig. 5 Never Operate Winch with Less Than Five Turns Around Drum**

*If the winch motor stalls from overloading, do not continue to activate the winch remote control. The wire cable may become overstressed.*

*Do not attempt to pull loads exceeding 1500 lbs. (680 kg).*

*To pull out the cable, the free spool clutch knob must be used. Pull out and rotate the knob. If the cable is under any load the clutch may not release easily. Jog out some of the cable to release the tension and operate clutch. Pull out the desired amount of cable and secure. Engage the drum by rotating the knob until it snaps in place. Never operate the winch unless the clutch is engaged.*

*Have all persons and pets leave the area while operating winch. Never allow anyone to remain in the vehicle.*

## OPERATION AND SERVICE INFORMATION

Read all of manual to become thoroughly familiar with this vehicle. Pay particular attention to all Notes, Cautions and Warnings

To prevent damage to the wire cable, never hook the cable to itself. Always use a nylon sling (Ref Fig. 6 on page 3-7) (Ref Fig. 7 on page 3-7).

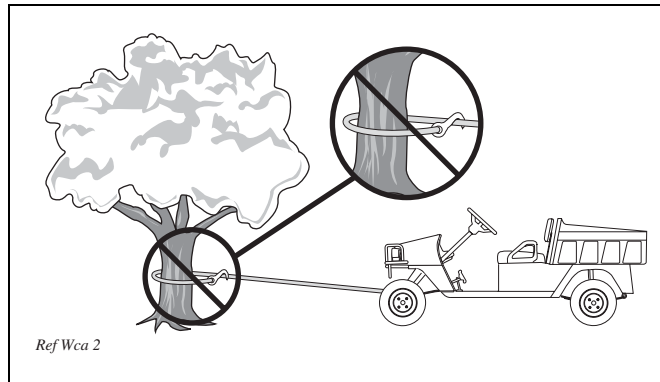

Fig. 6 Do Not Hook Cable to Itself

Stay clear of the winch, the cable and the cable hook. Place a heavy cloth, jacket or blanket over the cable to act as a damper should the cable break when operating the winch (Ref Fig. 7 on page 3-7).

Remember that the winch operation will drain the battery and may leave insufficient power to start the vehicle.

When operating the winch, keep the entire area in view.

Never release the free spool clutch while the cable is under load.

Never work around the winch drum or the winch cable while it is under tension.

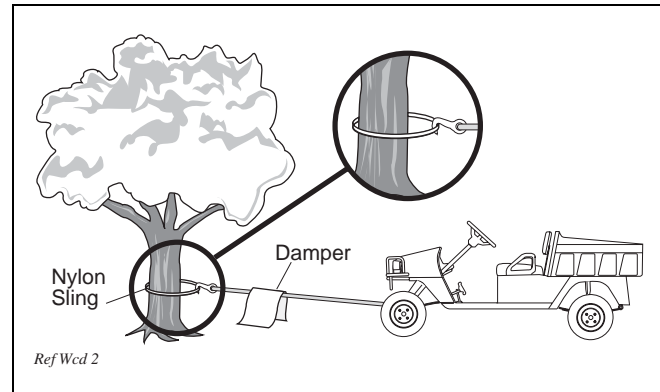

Fig. 7 Use a Nylon Sling and Install a Damper when Winching

Unplug the winch switch before working on the winch drum in order to prevent inadvertent operation.

When operating winch, take up slack slowly. Stop winch before cable becomes tight and inspect all winching connections. Check winch attachment, hook attachment, nylon sling (if required) and load attachment.

Do not pull at an angle. This will cause the wire cable to pile up on one end of the winch. This may jam the winch causing damage to the cable and/or the winch. Pulling the vehicle at an angle can cause damage to the front suspension and may cause the vehicle to overturn. When pulling vehicle, pull straight only (Ref Fig. 8 on page 3-8).

If the vehicle is being used as an anchor to winch a load, it should have the parking brake set and chocks installed on

## OPERATION AND SERVICE INFORMATION

Read all of manual to become thoroughly familiar with this vehicle. Pay particular attention to all Notes, Cautions and Warnings

### CONTROLS AND INDICATORS

Vehicle controls and indicators consist of:

- key/light switch
- direction selector
- choke
- fuel gauge
- low oil pressure light
- accelerator pedal
- brake pedal
- park brake
- horn
- differential lock

#### KEY/LIGHT SWITCH

Located on the dash panel, this switch enables the basic electrical system of the vehicle to be turned on and off by turning the key. To prevent inadvertent operation of the vehicle when left unattended, the key should be turned to the 'OFF' position and removed (Ref Fig. 9 on page 3-9).

If the vehicle is equipped with lights, the key switch has a position to operate them, indicated by the light icon.

**NOTE** If the vehicle is equipped with factory installed custom accessories, some accessories remain operational with the key switch in the 'OFF' position.

#### DIRECTION SELECTOR

**CAUTION** To reduce the possibility of

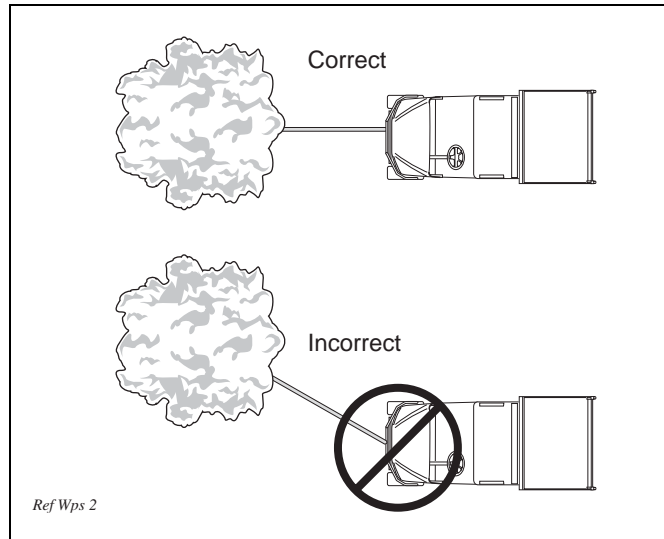

Fig. 8 Do Not Pull at Angle

*all wheels.*

*Never use the winch to lift people or other overhead loads.*

*Do not use the winch to secure loads. Use a tie down designed for the job.*

*Do not apply shock loads to the winch.*

*Do not attempt to modify or weld the winch.*



## OPERATION AND SERVICE INFORMATION

Read all of manual to become thoroughly familiar with this vehicle. Pay particular attention to all Notes, Cautions and Warnings

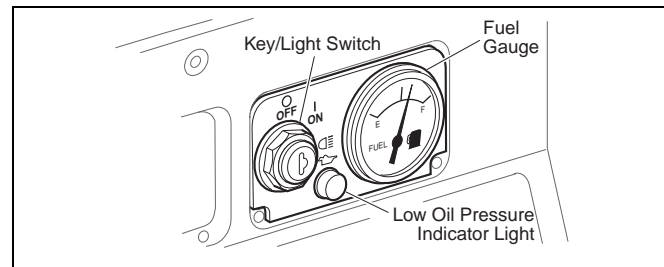

**Fig. 9 Key/Light Switch, Low Oil Pressure Light and Fuel Gauge**  
**component damage, the vehicle must be completely stopped before moving the direction selector.**

Located on the console between the seats, this lever permits the selection of either forward or reverse (Ref Fig. 10 on page 3-9). The vehicle should be left in forward when unattended.

### CHOKE

The choke is used to aid cold starting (Ref Fig. 10 on page 3-9). See 'Cold Starting' (Refer to page 3-14) for instructions on using the choke properly.

### FUEL GAUGE

An electric fuel gauge is located to the right side of the key/light switch. It indicates the amount of fuel in the tank (Ref Fig. 9 on page 3-9).

### LOW OIL PRESSURE INDICATOR LIGHT

A low oil pressure indicator light is located on the dash panel (Ref Fig. 9 on page 3-9). If oil pressure drops below 1 - 4 psi (.1 - .2 kg/cm<sup>2</sup>), the oil pressure switch will activate the light. Check oil level (Refer to page 3-

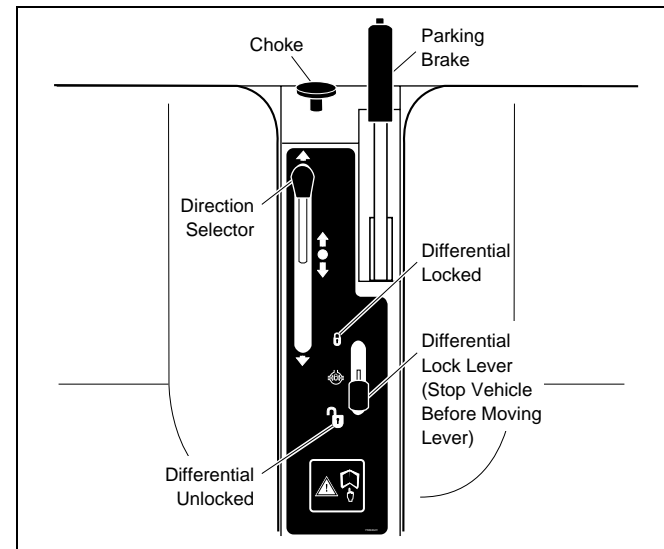

**Fig. 10 Console Controls**

29). If oil level is between ADD and FULL mark on dipstick, a mechanical problem exists within the engine and the vehicle **must not be driven**. Contact a local Distributor or authorized Branch.

**CAUTION** To prevent engine damage, do not operate engine until oil pressure is corrected. Do not overfill engine. Too much oil may cause smoking or allow oil to enter the air filter enclosure.

## OPERATION AND SERVICE INFORMATION

Read all of manual to become thoroughly familiar with this vehicle. Pay particular attention to all Notes, Cautions and Warnings

If oil level is below ADD mark on dipstick, add oil to bring level to FULL mark (Refer to page 3-29). Drive vehicle a short distance and check oil pressure. If oil pressure light does not come on, continue to use vehicle.

### ACCELERATOR PEDAL



**WARNING** *Unintentional movement of the accelerator pedal may cause the vehicle to move which could result in severe injury or death.*

With the key switch 'ON', depressing the accelerator pedal starts the engine and the vehicle begins to move in the direction selected. When the pedal is released, the engine will stop (Ref Fig. 11 on page 3-10). To stop the vehicle more quickly, depress the service brake.

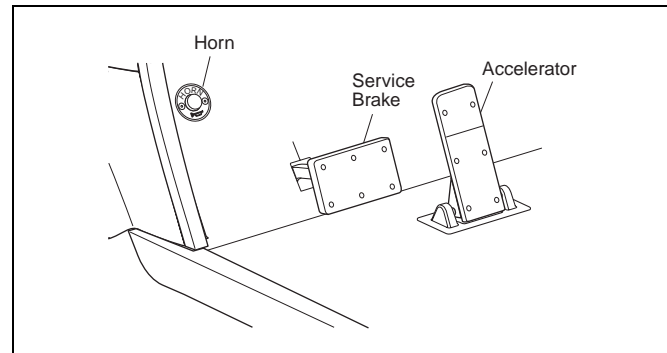

Fig. 11 Accelerator, Brake and Horn

### SERVICE BRAKE PEDAL

Depressing the foot operated service brake pedal activates the wheel brakes, slowing or stopping the vehicle (Ref Fig. 11 on page 3-10).

### PARK BRAKE

The hand operated park brake is located on the console between the front seats (Ref Fig. 10 on page 3-9). The brake is engaged when the handle is raised and disengaged when the handle is in the full down position.

When leaving the vehicle unattended, engage the park brake by raising the handle until it locks in place. To release the park brake, depress the release button in the end of the handle while slightly raising the handle, then lower the park brake handle.

### HORN

The horn is operated by pushing the horn button located on the upper floorboard to the left of the brake pedal (Ref Fig. 11 on page 3-10).

### DIFFERENTIAL LOCK

The rear drive axle is equipped with a manually operated locking differential. With the differential **unlocked**, if one drive wheel loses traction, all available power is transferred to that wheel until it regains traction. With the differential **locked**, power is distributed to both drive wheels at all times. Always disengage the differential lock after traction is regained. With the differential locked, steering effort and tire wear is increased due to the outside tire dragging during turns.



**NOTE** *The differential lock should only be used when additional traction is required. Continued use of the*

## OPERATION AND SERVICE INFORMATION

Read all of manual to become thoroughly familiar with this vehicle. Pay particular attention to all Notes, Cautions and Warnings

differential lock may cause excessive wear to the rear tires.

**CAUTION** The vehicle must be completely stopped before engaging or disengaging the differential lock. Failure to stop will damage the differential.

To engage the differential lock, stop vehicle and push the lock lever forward towards the red 'locked' symbol (Ref Fig. 10 on page 3-9).

To disengage the differential lock, stop the vehicle and push the differential lock lever backward towards the green 'unlocked' symbol. After unlocking, the differential may remain locked if driving is resumed in a straight line. This is a normal occurrence caused by pressure remaining against the gears and not allowing the locking mechanism to release. To avoid this, simply turn the vehicle as acceleration begins or accelerate in reverse.

### LOAD BED

**WARNING** To reduce the possibility of severe injury or death, read, understand and follow the Danger label affixed to the front of the load bed.

The electric lift bed is the standard bed for the ST480.

A load bed warning label is affixed to the front of the bed. See Appendix A. For safe operation of the vehicle, this label must be understood. See the load bed warning label for maximum load. The load must be positioned in the bed as far forward as possible, distributed in such a way that its center of gravity must not be higher than height noted on label, and secured. Failure to follow these instructions may result in severe

injury, damage the vehicle and/or cause the vehicle to tip over. Use extra care when operating loaded vehicle.

Do not permit any one to ride in the bed.

Do not drive the vehicle with the load bed raised or with the tailgate unsupported.

When using the electric lift on the ST 480, be sure to avoid backing up to the edge of a drop off, such as a loading dock or ravine. A misjudgment of distance or an unstable surface could result in the vehicle falling backwards.

Before operating load bed, check to ensure no one is behind the vehicle.

**WARNING** Never fill a gas can in the bed of a vehicle. Static discharge could ignite gasoline vapor and cause an explosion.

Always place a gas can on the ground before filling. Never fill a gas can in the bed of the vehicle. Static electricity is built up during the fueling process and could discharge causing the gasoline vapor to ignite.

### ELECTRIC LIFT BED OPERATION

**WARNING** Exercise caution while operating the electric lift bed to ensure clothing is not caught during lifting or lowering procedure. Severe injury could result if bed is lowered and traps fingers or other body parts.

The electric lift switch is located on the driver side of the front seat panel. Move the switch lever up to raise the load bed and down to lower (Ref Fig. 12 on page 3-12).

## OPERATION AND SERVICE INFORMATION

Read all of manual to become thoroughly familiar with this vehicle. Pay particular attention to all Notes, Cautions and Warnings

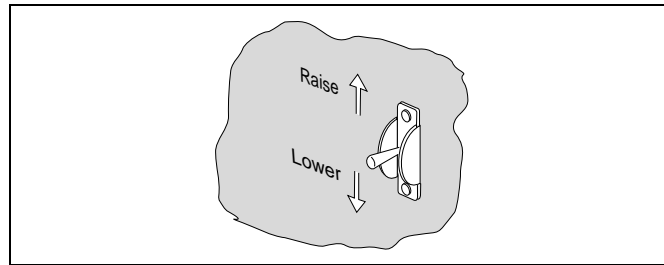

Fig. 12 Electric Lift Switch

### OPERATING THE VEHICLE

**CAUTION** Improper use of the vehicle or the lack of proper maintenance may result in damage or decreased performance.

Read and understand the following warnings before attempting to operate the vehicle.

**WARNING** To reduce the possibility of severe injury or death resulting from loss of vehicle control, the following warnings must be observed:

When driving vehicle, consider the terrain, traffic conditions and the environmental factors which effect the terrain and the ability to control the vehicle.

Use extra care and reduced speed when driving on poor surfaces, such as loose dirt, wet grass, gravel, etc.

Stay in areas suitable for a light duty utility vehicle. Avoid rough, unimproved trails, areas with large rocks, stumps

or holes and avoid steep slopes.

Maintain a safe speed when driving down hill. Use service brake to control speed when traveling down an incline. A sudden stop or change of direction may result in loss of control.

Slow down before and during turns. All turns should be made at reduced speed.

Never drive vehicle up, down, or across an incline that exceeds 14° (25% grade).

When driving the vehicle on unfamiliar terrain, drive the vehicle slowly, especially when cresting a hill.

If the vehicle is unable to climb a hill, do NOT attempt to turn it around. Turning the vehicle sideways on a hill could result in the vehicle rolling over. Slowly back down the hill using the service brake to control speed.

When operating the electric dump, do not back up to a drop off, such as a loading dock or ravine. Misjudgment or an unstable surface could cause the vehicle to fall backward into the drop off.

**WARNING** To reduce the possibility of severe injury or death resulting from improper vehicle operation, the following warnings must be observed:

The vehicle is a light duty utility vehicle. It is not an ATV (All Terrain Vehicle).

The vehicle is not a toy and engaging in horseplay is dangerous.

The vehicle should not be operated on public highways. It

## OPERATION AND SERVICE INFORMATION

Read all of manual to become thoroughly familiar with this vehicle. Pay particular attention to all Notes, Cautions and Warnings

is not designed to comply with any DOT requirements.

The vehicle should be operated by persons with a valid driver's license. Children should not operate this vehicle.

Refer to GENERAL SPECIFICATIONS for seating capacity.

Use the park brake when the vehicle is parked.

To prevent inadvertent movement when the vehicle is to be left unattended, engage the park brake, move direction selector to forward position, turn key to 'OFF' position and remove key.

Make sure that the direction selector is in correct position before attempting to start the vehicle.

Always bring the vehicle to a complete stop before shifting the direction selector and/or differential lock.

Do not take vehicle out of 'gear' while in motion (coast).

Check the area behind the vehicle before operating in reverse.

All occupants must be seated. Keep entire body inside vehicle and hold on while vehicle is in motion.

The vehicle is not equipped with seat belts and is not designed with roll over protection. The top and windshield do not provide protection from falling or flying objects.

A motorcycle helmet and protective clothing are recommended for operator and passenger at all times.

Do not permit anyone in the load bed while vehicle is in motion.

Use caution when operating the electric dump. Do not allow anyone behind the vehicle when operating the unit.

When operating the winch, observe all warnings and safe-

ty decals on the vehicle. Read, understand and follow the instructions located in the front part of this manual.

Do not winch at an angle. Do not exceed winch capacity.

### RUN-IN

Check for oil or fuel leaks that could have developed in shipment from the factory. Avoid full throttle starts and rapid acceleration until the engine has achieved operating temperature.

All engines consume more oil than normal during the first hours of operation. As internal moving parts are run-in, oil consumption should gradually decrease until the rate of consumption stabilizes.

Check the oil level per the Periodic Service Schedule. Add oil if the level on the dipstick indicates that oil is in the add oil range (Ref Fig. 13 on page 3-13).

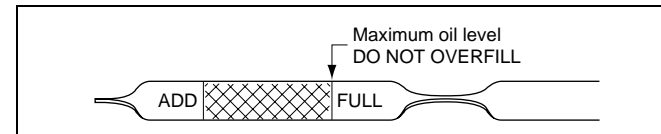

Fig. 13 Check Oil Level on Dipstick

**CAUTION** Never overfill the engine with oil, foaming may result and oil may enter the breather system.

**NOTE** Both the oil dipstick and fill cap must be in place before operating the engine. Failure to install the dipstick and fill cap will result in oil becoming contaminated and/or oil being discharged into the engine compartment.

## OPERATION AND SERVICE INFORMATION

Read all of manual to become thoroughly familiar with this vehicle. Pay particular attention to all Notes, Cautions and Warnings

The oil should be changed in accordance with the Periodic Service Schedule while the engine is warm. See SERVICE AND MAINTENANCE for checking oil level and changing oil procedures.

### COLD STARTING

Starting a cold engine **may** require use of the choke. Depress the accelerator approximately 1" (2.5 cm) or until the starter just begins to operate. Pull the choke out if required. Accelerate slowly and push the choke in completely when the engine runs smoothly.

**CAUTION** Do not allow the starter to operate continuously for more than 10 seconds. Allow 30 seconds between starting attempts. If the vehicle does not start on the third attempt, turn the key switch off, set the park brake and determine the cause of the problem.

If the vehicle had been running and the engine does not start within 10 seconds, use the choke.

### STARTING AND DRIVING

**WARNING** To reduce the possibility of roll-back which could result in severe injury or vehicle damage, do not release the service brake until engine has started.

To operate vehicle:

- Apply the service brake, place the key in the key switch and turn it to the 'ON' position.
- Move the direction selector to the direction desired.
- Release the park brake by pressing the release button in the end of the handle while slightly raising the handle. Then lower the

parking brake handle.

- Slowly depress the accelerator pedal to start the engine. Release service brake when engine starts.
- When the accelerator pedal is released, the ignition circuit is de-energized and the engine stops. To stop the vehicle more quickly, depress the **service brake pedal**.

**NOTE** When the direction selector is in the reverse position, a warning signal will sound to indicate that the vehicle is ready to run in reverse.

### STARTING THE VEHICLE ON A HILL

**WARNING** To reduce the possibility of roll-back which could result in severe injury or vehicle damage, do not release the service brake until engine has started.

**CAUTION** Do not hold vehicle on hill by using the accelerator and engine. This will cause premature and excessive wear to drive train components.

To reduce the possibility of permanent damage to the drive system, it is important to prevent excessive roll-back when starting the vehicle on a hill.

Place left foot on service brake and release the park brake. Depress accelerator with right foot and release the service brake by lifting left foot.

### COASTING

**WARNING** To reduce the possibility of severe injury or death from coasting at

## OPERATION AND SERVICE INFORMATION

Read all of manual to become thoroughly familiar with this vehicle. Pay particular attention to all Notes, Cautions and Warnings

*above recommended speeds, limit speed with service brake.*

On steep hills, it is possible for the vehicle to coast at greater than normal speeds encountered on a flat surface. To reduce the possible loss of vehicle control and severe drivetrain damage, speeds should be limited to no more than the maximum governed speed on level ground (see GENERAL SPECIFICATIONS). Limit speed by applying service brake.

### FUEL

**⚠ WARNING ⚠** *To reduce the possibility of severe injury or death from improper fuel handling:*

*Do not smoke near the fuel tank.*

*Do not refuel near open flame or electrical items which could produce a spark.*

*Always handle gasoline in a well ventilated area.*

*Always wear eye protection to protect against splashed fuel and fuel vapors.*

*Always allow adequate space for the expansion of gasoline. Leave at least 1" (2.5 cm) space below bottom of filler neck.*

*Inspect fuel cap, tank and other components for leaks or deterioration that could cause a hazardous condition.*

The fuel tank is located under the seat on the passenger side of the vehicle (Ref Fig. 14 on page 3-15). Fill the tank with fresh, clean, automotive grade gasoline (Ref Fig. 38 on page 3-40). High altitude or heavy use/load applications may benefit from higher octane gasoline.

**Do not** use gasoline which contains Methanol.

**CAUTION** Some fuels, called oxygenated or reformulated gasoline, are gasoline blended with alcohols or ethers. Excessive amounts of these blends can damage the fuel system or cause performance problems. If any undesirable operating symptoms occur, use gasoline with a lower percentage of alcohol or ether.

**Do not overfill the fuel tank. Allow adequate space for the expansion of gasoline. Leave at least 1" (2.5 cm) space below bottom of filler neck.**

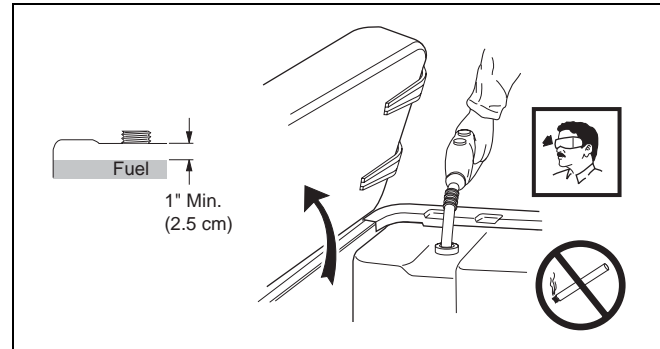

Fig. 14 Fueling

### BATTERY

**CAUTION** Excessive use of accessories may drain the battery and leave insufficient reserve to start the vehicle.

## OPERATION AND SERVICE INFORMATION

Read all of manual to become thoroughly familiar with this vehicle. Pay particular attention to all Notes, Cautions and Warnings

The vehicle uses a combination starter/generator to both start the engine and charge the battery. The engine will not idle; therefore, the battery cannot be charged while the vehicle is stopped. Do not operate accessory items (such as accessory lights, radios, winch, etc.) excessively while the vehicle is stopped.

The generator is capable of supplying 35 amps; therefore, operation of all accessories could result in the discharge of the battery even though the engine is running and the generator operating. Discharging the battery is known as deep cycling. The battery is not a deep cycle model, but is a starting battery. Multiple deep cycling will result in the premature failure of the battery.

If the vehicle battery has become discharged, it must be charged using a 12 Volt charger that is rated at 10 amps or less and in accordance with all instructions provided by the manufacturer of the charger.

### LABELS AND PICTOGRAMS

Vehicles may be labeled with pictograms as a method of conveying information or warnings. Appendix A illustrates and explains pictograms that may appear on the vehicle. Not all pictograms shown in Appendix A will be found on your vehicle.

### SUN TOP AND WINDSHIELD



**The sun top does not provide protection from roll over or falling objects.**

**The windshield does not provide protection from tree limbs or flying objects.**

The sun top and windshield provide some protection from the elements; however, they will not keep the operator and passenger dry in a

downpour. This vehicle is not equipped with seat belts and the sun top has not been designed to provide roll over protection. In addition, the sun top does not protect against falling objects nor does the windshield protect against flying objects and tree limbs. Keep arms and legs inside of vehicle while it is moving.

### 12 VOLT POWER OUTLET

**CAUTION** Overuse of accessories may drain the battery and leave insufficient reserve to start the vehicle.

A 12 volt power outlet, rated at 15 amps, is located to the left side of the key/light switch (Ref Fig. 15 on page 3-16). It provides constant power for accessories equipped with a 12 volt plug.

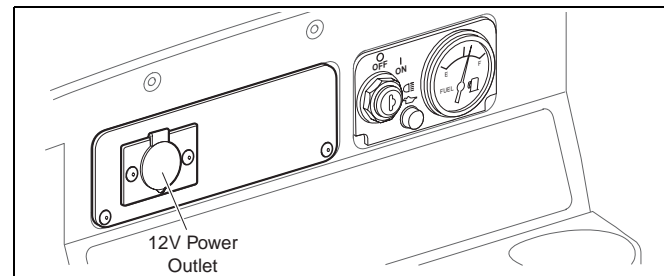

Fig. 15 12 Volt Power Outlet

### TOWING A TRAILER

The vehicle is equipped with a receiver that can be fitted with a standard 1 7/8" ball. The trailer and its load must not exceed 500 lbs (227



## OPERATION AND SERVICE INFORMATION

Read all of manual to become thoroughly familiar with this vehicle. Pay particular attention to all Notes, Cautions and Warnings

kg) and no more than 50 lbs (23 kg) tongue weight may be attached to the hitch. Remember that the overall capacity of the vehicle, operator, passenger, contents of load bed and accessories must be reduced to compensate for the trailer and load.

The range of motion of the trailer is limited by the ball and hitch. The trailer should not be used on rough trails or over objects such as logs, large rocks, holes, etc.

Never install baskets or extensions using the hitch receivers (front or rear). Such items will change the performance characteristics of vehicle and result in unsafe handling, possible roll over or vehicle damage.

### VEHICLE CLEANING AND CARE

#### VEHICLE CLEANING



**WARNING** To reduce the possibility of severe injury or vehicle damage, read and understand all instructions supplied by manufacturer of pressure washer.

**CAUTION** When pressure washing exterior of vehicle, do not use pressure in excess of 700 psi. To reduce the possibility of cosmetic damage, do not use any abrasive or reactive solvents to clean plastic parts.

It is important that proper techniques and cleaning materials be used. Using excessive water pressure may cause severe injury to operator or bystander, damage to seals, plastics, seat material, body finish or electrical system. Do not use pressure in excess of 700 psi to wash exterior of vehicle.

Clean windshield with lots of water and a clean cloth. Minor scratches may be removed using a commercial plastic polish or Plexus® plastic cleaner available from the service parts department.

Normal cleaning of vinyl seats and plastic or rubber trim requires the use of a mild soap solution applied with a sponge or soft brush and wipe with a damp cloth.

Removal of oil, tar, asphalt, shoe polish, etc. will require the use of a commercially available vinyl/rubber cleaner.

The painted surfaces of the vehicle provide attractive appearance and durable protection. Frequent washing with lukewarm or cold water and mild detergent is required to preserve the painted surfaces.

Occasional cleaning and waxing with non-abrasive products designed for 'clear coat' automotive finishes will enhance the appearance and durability of the painted surfaces.

Corrosive materials used as fertilizers or for dust control can collect on the underbody of the vehicle. These materials will cause corrosion of underbody parts unless flushed occasionally with plain water. Thoroughly clean any areas where mud or other debris can collect. Sediment packed in closed areas should be loosened to ease its removal, taking care not to chip or otherwise damage paint.



**NOTE** If the engine does not start or runs improperly after washing, remove the spark plug wires (by pulling the spark plug boots, never the wires). Dry all connections with forced air. Reinstall the wires.

# OPERATION AND SERVICE INFORMATION

Read all of manual to become thoroughly familiar with this vehicle. Pay particular attention to all Notes, Cautions and Warnings

## VEHICLE CARE PRODUCTS

To help maintain the vehicle there are several products available through local Distributors, authorized Branches, or the Service Parts Department.

- Touch-up paint specially formulated to match vehicle colors for use on both metal and molded plastic bodies. (P/N 28140-G\*\* and 28432-G\*\* for solid colors; 75831-G\*\* for camouflage colors)
- Battery Protectant formulated to form a long-term, flexible, non-tacky, dry coating that will not crack, peel or flake over a wide temperature range. (P/N 75500-G01)
- White Lithium Grease designed to provide lubrication protection in areas where staining or discoloring is a problem, or in areas of extreme temperature ranges. (P/N 75502-G01)
- Penetrant/Lubricant, a 4-in-1 product that penetrates seized parts, lubricates leaving a light lubricating film, reduces corrosion by adhering to wet or dry surfaces and displaces moisture, sealing against future moisture return. (P/N 75503-G01)
- Multi-purpose Cleaner and Degreaser that contains natural, environmentally safe solvents. (P/N 75504-G01)
- Multi-purpose Hand Cleaner is an industrial strength cleaner containing no harsh solvents, yet gently lifts grease off hands. May be used with or without water. (P/N 75505-G01)
- Battery Cleaner that neutralizes battery acids and dissolves terminal corrosion and can be rinsed with water. (P/N 75506-G01)
- Biodegradable Cleaner that breaks down grease to be easily wiped or rinsed away. (P/N 75507-G01)
- Multi-purpose Value Pack sampler includes 4 ounce (118 ml)

aerosol cans of Battery Protector, Penetrant/Lubricant, White Lithium Grease, and Carburetor and Choke Cleaner. (P/N 75508-G01)

- Plexus® plastic cleaner and polish removes minor scratches from windshield. (P/N 28433-G\*\*)

## REPAIR

### LIFTING THE VEHICLE

Tool List	Qty. Required
Floor jack .....	1
Jack stands.....	4
Chocks.....	4



**WARNING** *To prevent possible injury or death resulting from a vehicle falling from a jack, be sure the vehicle is on a firm and level surface. Never get under a vehicle while it is supported by a jack. Use jack stands and test the stability of the vehicle on the stands. Always place chocks in front and behind the wheels not being raised. Use extreme care since the vehicle is extremely unstable during the lifting process.*

Some servicing operations may require the rear wheels or the entire vehicle be raised.

Install chocks in front and behind each front wheel (Ref Fig. 16 on page 3-19). Center jack under rear bumper. Raise vehicle and locate a jack stand under the outer end of each rear axle.

Lower jack and test the stability of the vehicle on the two jack stands.

## OPERATION AND SERVICE INFORMATION

Read all of manual to become thoroughly familiar with this vehicle. Pay particular attention to all Notes, Cautions and Warnings

Place the jack at the center of the front axle. Raise the vehicle and position jack stands under the frame crossmember as indicated.

Lower jack and test the stability of vehicle on the four jack stands.

If only front or rear of vehicle is to be raised, place the chocks in front and behind each wheel not being raised in order to stabilize the vehicle.

Lower the vehicle by reversing the lifting sequence.

### WHEELS AND TIRES

**NOTE** Standard tires for this vehicle are uni-directional and should never be moved from one side of vehicle to the other.

This vehicle comes standard with uni-directional tires. Left side tires should always remain on the left side of the vehicle. Right side tires should always remain on the right side of the vehicle. Uni-directional tires have an arrow on the sidewall indicating direction of rotation when moving forward. Tire condition should be inspected per the Periodic Service Schedule (Ref Fig. 22 on page 3-26). Inflation pressures should be checked when the tires are cool. Be sure to install valve dust cap after checking or inflating.

### Tire Repair

Tool List	Qty. Required
Lug wrench, 3/4" .....	1
Impact socket, 3/4", 1/2" drive .....	1
Impact wrench, 1/2" drive .....	1
Torque wrench, 1/2" drive .....	1

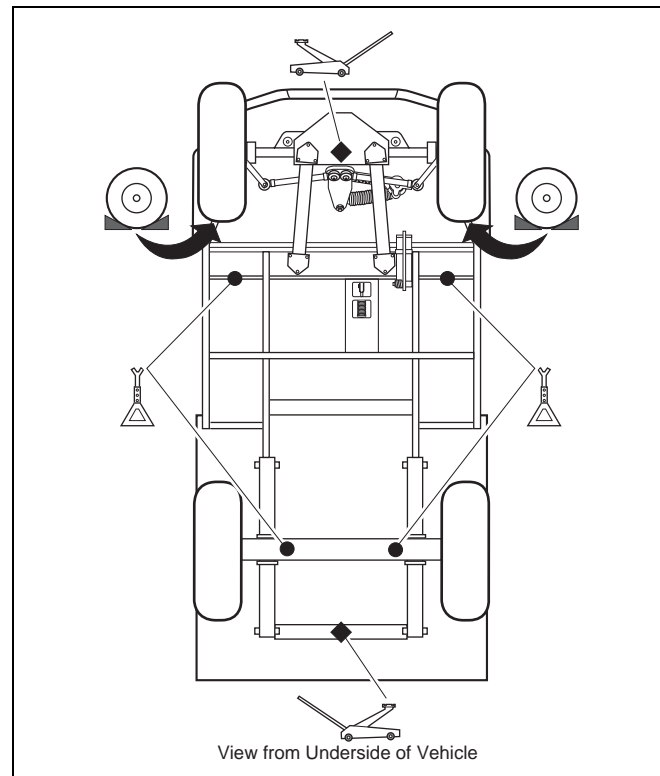

Fig. 16 Lifting the Vehicle

## OPERATION AND SERVICE INFORMATION

Read all of manual to become thoroughly familiar with this vehicle. Pay particular attention to all Notes, Cautions and Warnings

### ⚠ WARNING ⚠

**A tire explosion can cause severe injury or death. Never exceed inflation pressure rating on tire sidewall.**

*To reduce the possibility of tire explosion, pressurize tire with small amount of air applied intermittently to seat beads. Due to the low volume of the small tires, overinflation can occur in seconds. Never exceed the tire manufacturer's recommendation when seating a bead. Protect face and eyes from escaping air when removing valve core.*

*To reduce the possibility of severe injury caused by a broken socket when removing wheels, use only sockets designed for impact wrench use.*

*Use caution when inflating tires. Overinflation could cause the tire to separate from the wheel or cause the tire to explode, either of which could cause severe injury.*

Use caution when inflating tires. Due to the low volume of the small tires, overinflation can occur in seconds. Overinflation could cause the tire to separate from the wheel or cause the tire to explode.

Tire inflation will depend on the type of tires fitted but under no condition should inflation pressure be higher than recommended on the tire sidewall. Standard and optional tires should be inflated to pressure designated in GENERAL SPECIFICATIONS on page 4-1. If pressure is not designated in GENERAL SPECIFICATIONS, inflate to pressure designated on tire sidewall. **All four tires** should have the same pressure for optimum handling characteristics. Be sure to install the valve dust cap after checking or inflating.

The vehicle is fitted with low pressure tubeless tires mounted on one piece rims. When removing wheels with an impact wrench, use

only impact sockets. Regular sockets are not designed for impact pressures exerted by power tools.

Generally, the most cost effective way to repair a puncture in the tread is to use a commercial tire plug.

### NOTE

*Tire plug tools and plugs are available at most automotive parts outlets and have the advantage of not requiring the tire be removed from the wheel.*

If the tire is flat, raise vehicle and remove wheel. Refer to 'Lifting the Vehicle' for proper lifting procedure and safety information. Inflate tire to maximum recommended pressure. Immerse the tire in water to locate the leak and mark with chalk. Insert tire plug in accordance with manufacturer's specifications.

### ⚠ WARNING ⚠

**To reduce the possibility of severe injury, be sure mounting/demounting machine is anchored to floor.**

**Wear OSHA approved safety equipment when mounting/demounting tires.**

If the tire is to be removed or mounted, the tire changing machine manufacturer's recommendations must be followed in order to reduce possibility of severe injury. Be sure to position tire on wheel correctly. Arrow on tire indicates rotation when moving forward.

### Wheel Installation

### CAUTION

**To reduce the possibility of component damage, do not tighten lug nuts to more than 85 ft. lbs. (115 Nm) torque.**

### NOTE

*It is important to follow the 'cross sequence' pattern when installing lug nuts. This will assure even seating of the wheel against the hub.*

## OPERATION AND SERVICE INFORMATION

Read all of manual to become thoroughly familiar with this vehicle. Pay particular attention to all Notes, Cautions and Warnings

With the valve stem to the outside, mount the wheel onto the hub with lug nuts. Be sure to position the wheel on hub correctly with arrow indicating direction of rotation when moving forward. Finger tighten lug nuts in a 'cross sequence' pattern (Ref Fig. 17 on page 3-21). Tighten lug nuts to 50 - 85 ft. lbs. (70 - 115 Nm) torque in 20 ft. lbs. (30 Nm) increments following the 'cross sequence' pattern.

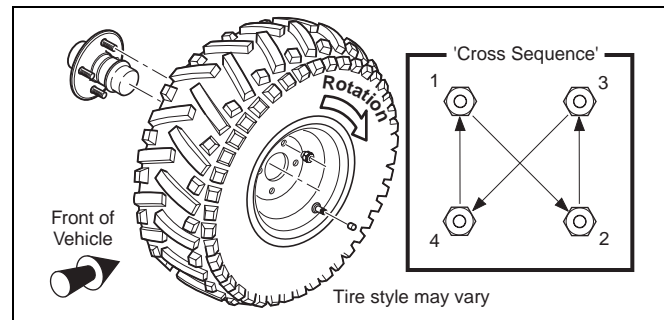

Fig. 17 Wheel Installation

### LIGHT BULB REPLACEMENT

For vehicles with headlights mounted in cowl, locate the two screws on backside of cowl that secure headlight (Ref Fig. 18 on page 3-21). Remove screws, pull headlight out and disconnect wires. Connect wires to new headlight, install in cowl and secure with screws previously removed.

To replace the turn signal light bulb, support turn signal housing from backside of cowl while removing two screws securing lens (Ref Fig. 18 on page 3-21). Install new bulb and replace lens.

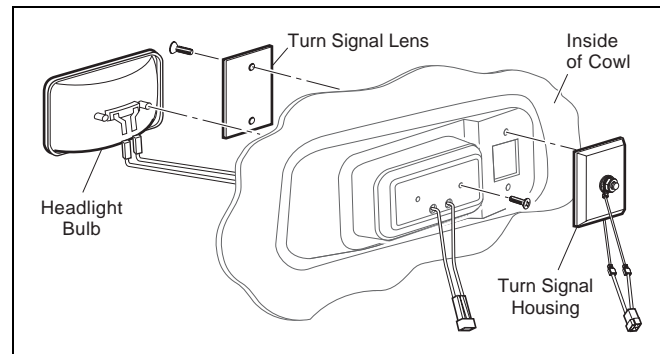

Fig. 18 Headlight and Turn Signal Bulb Replacement

To replace the tail and brake light bulb, roll the rubber bezel from around the edge of the taillight and remove lens (Ref Fig. 19 on page 3-22). Install replacement bulb and replace lens.

### FUSE REPLACEMENT

To replace fuses, locate the fuse block under the driver side seat. Pull out old fuse and replace with a new automotive type fuse. Headlight and taillight bulbs and fuses are available from a local Distributor, an authorized Branch or the Service Parts Department.

### VEHICLE WITH A DISCHARGED BATTERY



**WARNING**

To reduce the possibility of severe injury or death from inadvertent motion, do not attempt to 'jump start' a vehicle.

## OPERATION AND SERVICE INFORMATION

Read all of manual to become thoroughly familiar with this vehicle. Pay particular attention to all Notes, Cautions and Warnings

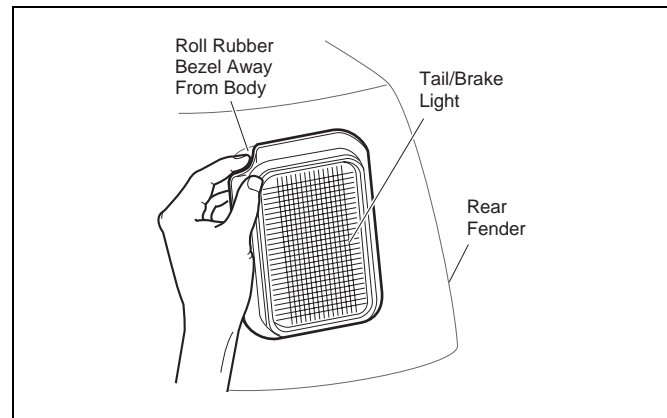

Fig. 19 Tail and Brake Light Bulb Replacement

The vehicle is equipped with a starter/generator and does not idle. When starting the engine, the starter/generator functions as a starter and with the engine running, it functions as a generator.

With the short running times associated with this kind of vehicle, the generator is more than adequate to maintain the battery charge level. The generator is not designed to charge a discharged battery.

When engine starts, the clutches engage and cause vehicle to move making 'jump starting' both dangerous and impractical.

If the vehicle battery has become discharged, it must be charged using a 12 Volt charger that is rated at 10 amps or less. Read and understand all instructions provided by the manufacturer of the charger.

3-22

## TRANSPORTING VEHICLE

### TOWING



**This vehicle is not designed to be towed.**

It is recommended that the vehicle be moved by placing the entire vehicle on a trailer, flatbed truck or other suitable transport.

### NEUTRAL LOCK

To prevent the driven clutch from turning the rear wheels during service operations, a neutral lock is located under the passenger side of the console panel (Ref Fig. 20 on page 3-23).

To operate:

Turn the key switch to 'OFF' and raise the passenger seat. Place the direction selector in the forward position. Reach under the passengers side of console panel and rotate the neutral lock lever clockwise until it snaps into the slot in the direction selector bracket as shown. Next, pull the direction selector handle to the rear until it locks in place in the neutral position. When in this position, the direction selector remains locked in the neutral position. To activate the direction selector, pull the neutral lock lever out of the slot and rotate counter-clockwise until it snaps into the detent position in the direction selector bracket.

### HAULING



**To reduce the possibility of severe injury or death while transporting vehicle:**

**Secure the vehicle and contents.**

## OPERATION AND SERVICE INFORMATION

Read all of manual to become thoroughly familiar with this vehicle. Pay particular attention to all Notes, Cautions and Warnings

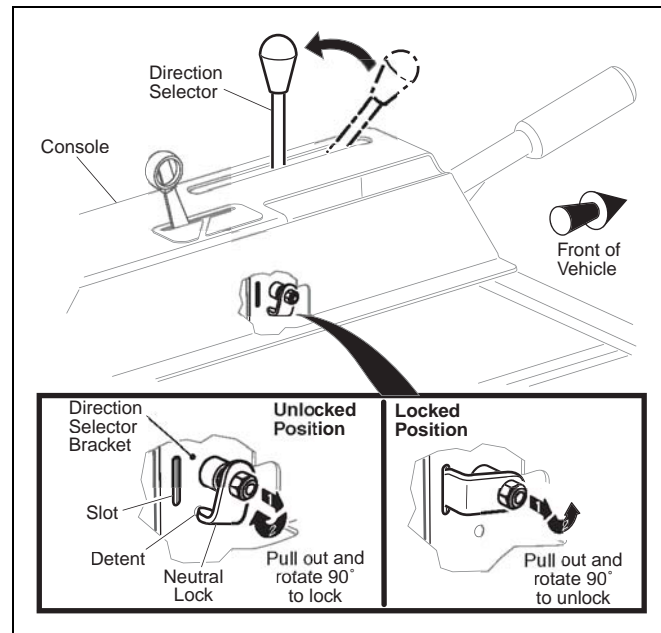

Fig. 20 Neutral Lock

**Never ride on vehicle being transported.**

**Always remove windshield before transporting.**

**Maximum speed with sun top installed is 50 mph (80 kph).**

If the vehicle is to be transported at highway speeds, the sun top must be removed. When transporting vehicle below highway speeds, check

for tightness of hardware and cracks in sun top at mounting points. Always remove windshield when transporting. Always check that the vehicle and contents are adequately secured before transporting. The rated capacity of the trailer or truck must exceed the weight of the vehicle (see GENERAL SPECIFICATIONS for vehicle weight) and load. Lock the park brake and secure the vehicle using ratchet tie downs.

### SERVICE AND MAINTENANCE

**⚠ WARNING ⚠** To reduce the possibility of severe injury or death from improper servicing techniques:

**Do not attempt any type of servicing operations before reading and understanding all notes, cautions and warnings in this manual.**

**Any servicing requiring adjustments to be made to the powertrain while the engine is running must be made with both drive wheels raised and vehicle properly supported on jack stands.**

**To reduce the possibility of engine damage, never operate vehicle at full throttle for more than 4 - 5 seconds while vehicle is in a 'no load' condition.**



**Wear eye protection when working on the vehicle. Use extra care when working around batteries, or using solvents or compressed air.**

**To reduce the possibility of causing an electrical arc, which could result in a battery explosion, turn off all electrical loads from the battery before removing battery wires.**

## OPERATION AND SERVICE INFORMATION

Read all of manual to become thoroughly familiar with this vehicle. Pay particular attention to all Notes, Cautions and Warnings



**Wrap wrenches with vinyl tape to reduce the possibility of a dropped wrench 'shorting out' a battery, which could result in an explosion.**

**Reduce the possibility of accidental starting by removing and grounding spark plug wires and disconnecting battery at negative terminal before servicing.**

**The electrolyte in a battery is an acid solution which can cause severe burns to the skin and eyes. Treat all electrolyte spills to the body and eyes with extended flushing with clear water. Contact a physician immediately.**

**Any electrolyte spills should be neutralized with a solution of 1/4 cup (60 ml) sodium bicarbonate (baking soda) dissolved in 1 1/2 gallons (6 liters) of water and flushed with water.**

**Aerosol containers of battery terminal protectant must be used with extreme care. Insulate metal container to reduce the possibility of can contacting battery terminals which could result in an explosion.**

**Always install a positive stop to prevent load bed from unexpectedly falling.**

It is in the best interest of both vehicle owner and service technician, to carefully follow the procedures recommended in this manual. Preventative maintenance, applied at recommended intervals, is the best guarantee for keeping the vehicle both dependable and economical.

This vehicle will give years of satisfactory service, providing it receives regular maintenance. Refer to the Periodic Service Schedule for appropriate service intervals (Ref Fig. 22 on page 3-26). Refer to Lubrication Points for appropriate lubrication locations (Ref Fig. 29 on page 3-32).

3-24

In any product, components will fail to perform properly as the result of normal use, age, wear or abuse.

A vehicle requiring repair indicates the vehicle is no longer functioning as designed and should be considered potentially hazardous. Use extreme care when working on any vehicle. When diagnosing, removing or replacing any components that are not operating properly, consider the safety of yourself and those around you, should the component move unexpectedly.

Some components are heavy, spring loaded, highly corrosive, explosive, may produce amperage or reach high temperatures. Gasoline, carbon monoxide, battery acid and hydrogen gas could result in serious bodily injury to the technician/mechanic and bystanders if not treated with utmost caution. Be careful not to place hands, face, feet or body in a location that could expose them to injury should an unforeseen dangerous situation occur.



**WARNING**

**To prevent personal injury or death, observe the following:**

**Before working on the vehicle,**

**remove all jewelry (rings, watches, necklaces, etc.)**

**Be sure that no loose clothing or hair can contact moving parts.**

**Use care not to touch hot objects.**

**Raise entire vehicle and support on jack stands before attempting to run or adjust powertrain.**

**Hydrogen gas is formed when charging batteries. Do not charge batteries without adequate ventilation.**

**Do not permit open flame or anyone to smoke in an area that is being used for charging batteries. A concentration**



## OPERATION AND SERVICE INFORMATION

Read all of manual to become thoroughly familiar with this vehicle. Pay particular attention to all Notes, Cautions and Warnings

of 4% hydrogen gas or more is explosive.

Engine exhaust gas (carbon monoxide) is deadly. Carbon monoxide is an odorless, colorless gas that is formed as a natural part of incomplete combustion of hydrocarbon fuels. Carbon monoxide is a dangerous gas that can cause unconsciousness and is potentially lethal.

The following are symptoms of carbon monoxide inhalation:

- Dizziness
- Vomiting
- Intense headache
- Muscular twitching
- Weakness and sleepiness
- Throbbing in temples

If any of these symptoms are experienced, get fresh air immediately. Never work around or operate a vehicle in an environment that does not ventilate exhaust gases from the area.

### SERIAL NUMBER PLATE LOCATION

The serial number and manufacturing date code are located on a plate on the passenger side of the dash housing of the vehicle (Ref Fig. 21 on page 3-25).

Design changes take place on an ongoing basis. In order to obtain correct components for the vehicle, the manufacturing date code, serial number and vehicle model must be provided when ordering service parts.

**CAUTION** To prolong vehicle life, some

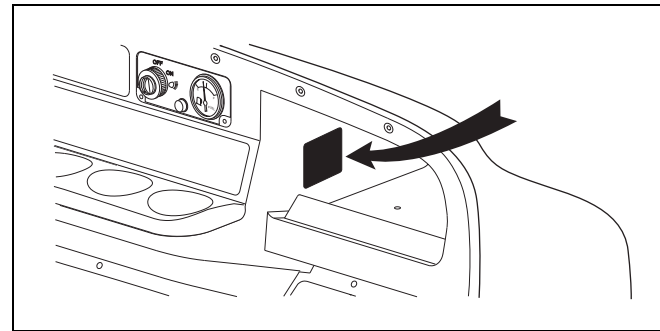

Fig. 21 Serial Number Plate Location

**maintenance items must be serviced more frequently on vehicles used under severe driving conditions such as extreme temperatures, extreme dust/debris conditions, frequent use with maximum load.**

To access powertrain for routine maintenance, lift seats. Additional access may be obtained by raising or removing the load bed. For major repair, refer to appropriate Technician's Repair and Service Manual.

Some service procedures may require the vehicle to be lifted. Refer to LIFTING THE VEHICLE for proper lifting procedure and safety information.

# OPERATION AND SERVICE INFORMATION

Read all of manual to become thoroughly familiar with this vehicle. Pay particular attention to all Notes, Cautions and Warnings

## PERIODIC SERVICE SCHEDULE

✓ Check	◆ Clean, Adjust, etc.	▲ Replace
To perform service that is listed in this schedule but not described in this manual, contact a local Service Representative or see the Repair and Service Manual for this vehicle.		
<b>NOTE:</b> Some maintenance items must be serviced more frequently on vehicles used under severe driving conditions		
DAILY		
	<b>BEFORE USE:</b> ✓ Check oil level (Refer to page 3-29), see Note 1 on Pg. 3-40 ✓ Check service brake general operation ✓ Check park brake function ✓ Check warning device function in reverse ✓ Check tire condition ✓ Check overall vehicle condition ◆ Clean fins and inside blower housing (Refer to page 3-36), see Note 3 on Pg. 3-40	
WEEKLY		
TIRES	✓ Examine for cuts, excessive wear and pressure, see GENERAL SPECIFICATIONS	
WHEELS	✓ Check for bent rims, missing or loose lug nuts	
FUEL GAUGE	✓ Check for proper operation (at fueling), and fuel cap vent is free of dirt	
STARTER/GENERATOR BELT	✓ Check for tension, wear, cracks (Refer to page 3-34)	
25 HOURS (includes items listed in previous table & the following)		
WIRING	✓ Check all wiring for loose connections and broken/missing insulation	
ACCELERATOR	✓ Check for smooth movement - DO NOT LUBRICATE CABLE	
BRAKE FLUID (HYDRAULIC BRAKES)	✓ Check level, add if required (DOT 3) and check for leakage (Refer to page 3-37)	
PARK BRAKE	✓ Check brake performance and adjust if required	
CHOKE CABLE	✓ Check for smooth movement and adjustment - DO NOT LUBRICATE CABLE	
CARBURETOR LINKAGE	✓ Check attachment, adjust as required	
DIRECTION SELECTOR	✓ Check for smooth movement and attachment, adjust as required	
ENGINE	◆ Clean foam pre-cleaner (Refer to page 3-33), see Note 3 on Pg. 3-40 ✓ Check for unusual noise, vibration, acceleration, oil leaks	

Fig. 22 Periodic Service Schedule

## OPERATION AND SERVICE INFORMATION

*Read all of manual to become thoroughly familiar with this vehicle. Pay particular attention to all Notes, Cautions and Warnings*

STEERING ASSEMBLY	✓ Check for abnormal play, tightness of all hardware
TIE RODS/LINKAGES	✓ Check for excessive play, bent components or loose connections
REAR AXLE	✓ Check for leakage, add SAE 30 oil as required (Refer to page 3-34)
<b>50 HOURS (includes items listed in previous tables &amp; the following)</b>	
ENGINE	▲ Change oil, DO NOT OVERFILL (Refer to page 3-30), see Note 1 and Note 2 on Pg. 3-40 ✓ Check spark plug wires for cracks/loose connections
EXHAUST	✓ Inspect/clean spark arrester
FRONT AXLE	✓ Check for damage to axle and loose or missing hardware
FRONT SHOCK ABSORBERS	✓ Check for oil leakage and loose fasteners
FRONT SPRINGS	✓ Check for loose hardware, cracks at attachments
FRONT WHEEL ALIGNMENT	✓ Check for unusual tire wear, align if required
PARKING (PARK) BRAKE	✓ Check for binding cables ✓ Check for damage or wear ◆ Lubricate as required, use light oil. DO NOT LUBRICATE CABLES
REAR SHOCK ABSORBERS	✓ Check for oil leakage, loose mounting hardware
ENGINE ELECTRICAL SYSTEM	✓ Check coil/spark plug wires for cracks/loose connections
FUEL SYSTEM	✓ Check for leaks at tank, cap, system lines, filters, pump, carburetor ✓ Check system lines for cracks/deterioration
THROTTLE/GOVERNOR LINKAGE	✓ Check operation and governed speed
HARDWARE AND FASTENERS	✓ Check for loose or missing hardware and components ◆ Tighten or replace missing hardware
<b>100 HOURS (includes items listed in previous tables &amp; the following)</b>	
BATTERY	◆ Clean battery & terminals
ENGINE	▲ Change oil filter (Refer to page 3-32), see Note 1 on Pg. 3-40 ▲ Change air cleaner cartridge if damaged or dirty (Refer to page 3-33), see Note 3 on Pg. 3-40
DIRECTION SELECTOR	✓ Check for wear and smooth movement (lubricate shaft with light oil if required)
KING PINS	✓ Check for excessive play and tightness of retaining nuts ◆ Lubricate, use wheel bearing grease
STEERING ASSEMBLY	◆ Lubricate unit and idler arm, use wheel bearing grease

**Fig. 22 Periodic Service Schedule**

# OPERATION AND SERVICE INFORMATION

Read all of manual to become thoroughly familiar with this vehicle. Pay particular attention to all Notes, Cautions and Warnings

RACK END BALL JOINT	◆ Lubricate, use wheel bearing grease
REAR AXLE	✓ Check for unusual noise and loose or missing mounting hardware
DRIVE BELT	✓ Check for cracks, fraying and excessive wear
<b>250-300 HOURS or YEARLY (includes items listed in previous tables &amp; the following)</b>	
FRONT WHEEL BEARINGS	✓ Check and adjust as required, see Technician's Repair and Service Manual
REAR AXLE	✓ Check lubricant, add lubricant (SAE 30 oil) as required (Refer to page 3-34)
SERVICE BRAKES	◆ Clean, see Technician's Repair and Service Manual ✓ Check brake shoe linings, see Technician's Repair and Service Manual
FUEL FILTER	◆ Replace (Refer to page 3-29)
SPARK PLUGS	◆ Replace, gap new plugs (Ref. Capacities and Replacement Parts on page 3-40)(Refer to page 3-37)
MUFFLER/EXHAUST	✓ Check mounting hardware; check for leaks at head and muffler gaskets
VALVES	✓ Check valve clearance, refer to Briggs & Stratton® Repair Manual (P/N 272144) for VANGUARD™ V-Twin Overhead Valve Engines
<b>500 HOURS</b>	
REAR AXLE	▲ Replace lubricant
CYLINDER HEAD AND PISTONS	◆ Clean combustion chamber deposits, refer to Briggs & Stratton® Repair Manual (P/N 272144) for VANGUARD™ V-Twin Overhead Valve Engines

Fig. 22 Periodic Service Schedule

**Note 1** - Change oil after first 8 hours, then after every 50 hours.

**Note 2** - Change oil every 25 hours when operating under heavy load or in high temperatures.

**Note 3** - Clean more often under dusty conditions or when airborne debris is present. Clean foam pre-cleaner first and replace paper cartridge if dirty. Replace either if showing signs of damage.

## TIRE INSPECTION

Tire condition should be inspected per the Periodic Service Schedule (Ref Fig. 22 on page 3-26). Inflation pressures should be checked when the tires are cool. Be sure to install the valve dust cap after checking or inflating.

## SEAT PROP

The driver seat is equipped with a prop for use every time the seat is raised. To use, lift seat up against steering wheel to allow the prop to move over the center console flange (Ref Fig. 23 on page 3-29).

## OPERATION AND SERVICE INFORMATION

Read all of manual to become thoroughly familiar with this vehicle. Pay particular attention to all Notes, Cautions and Warnings

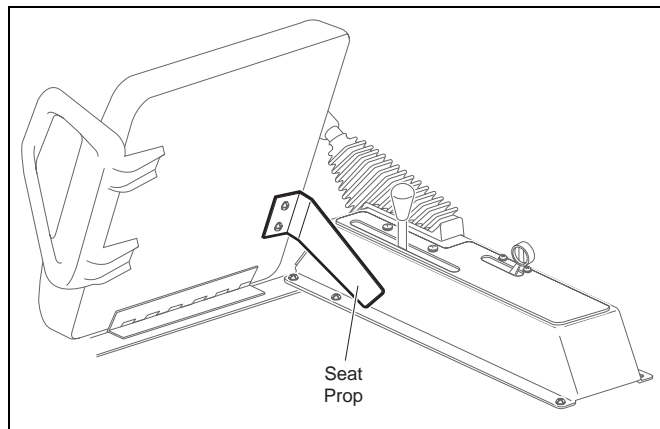

Fig. 23 Seat Prop

### REPLACING THE FUEL FILTER

**⚠ WARNING ⚠** To prevent a possible explosion, do not smoke near the fuel tank or in an area where gasoline is being handled. Do not perform procedures involving fuel system near open fire or electrical items which could produce a spark.

Do not handle gasoline in an area that is not adequately ventilated.

Always wear safety glasses to prevent possible eye injury from gasoline or gasoline vapor.

To replace fuel filter, use a pair of pliers to move clamps off ends of filter and pull filter up higher than the fuel pump to reduce the amount of gas that will spill (Ref Fig. 24 on page 3-30). Remove hose coming from

fuel tank first and plug. Remove filter from hose going to fuel pump and discard.

**NOTE** Orient direction of new fuel filter according to the FLOW arrow on the side of filter.

Install new fuel filter and reposition the clamps over the inlet and outlet.

### CHECKING THE OIL LEVEL

Tool List	Qty. Required
Clean cloth .....	2

**CAUTION** Never overfill the engine with oil, foaming may result and oil may enter the breather system.

**NOTE** When adding oil between oil changes, do not mix brands and viscosity grades of oil. Both the oil dipstick and fill cap must be in place before operating the engine. Failure to install the dipstick and fill cap will result in oil becoming contaminated and/or oil being discharged into the engine compartment.

Check oil level daily before starting the engine. The vehicle must be on a level surface with the parking brake engaged. Use a cloth to wipe clean the oil dipstick handle and oil fill cap (Ref Fig. 24 on page 3-30). This is necessary to prevent debris from falling into the engine.

Remove the dipstick and wipe off the entire area indicated with a clean cloth (Ref Fig. 25 on page 3-30).

Insert the dipstick **fully** into the dipstick tube and remove. Examine the level of oil on the dipstick. Oil should be at the FULL mark (Ref Fig. 26 on page 3-30).

# OPERATION AND SERVICE INFORMATION

Read all of manual to become thoroughly familiar with this vehicle. Pay particular attention to all Notes, Cautions and Warnings

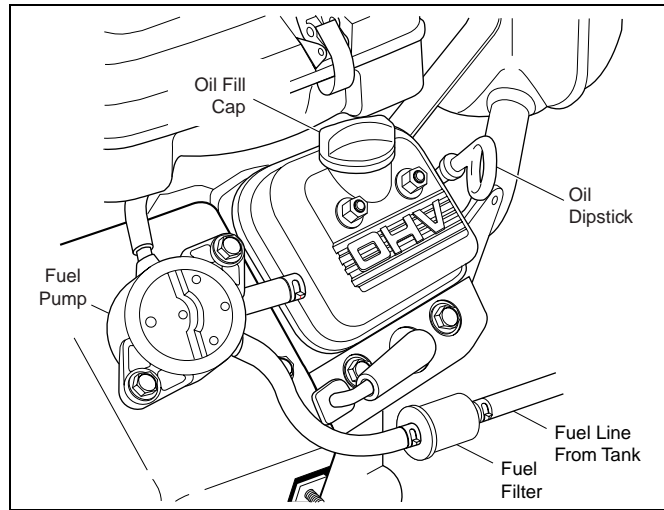

Fig. 24 Oil Fill Cap, Dipstick and Fuel Filter

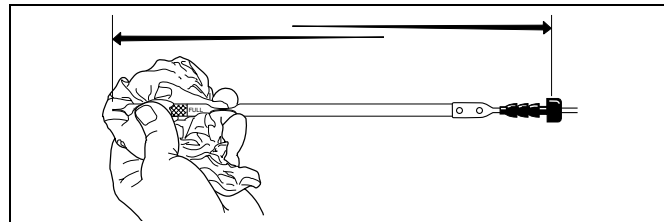

Fig. 25 Clean Entire Dipstick

If oil is required, remove oil fill cap and add oil slowly to bring level to the FULL mark. **Do not overfill.**

Replace dipstick **fully** into dipstick tube and firmly replace the oil fill cap.

**NOTE** When adding oil between oil changes, do not mix brands and viscosity grades of oil. Both the oil dipstick and fill cap must be in place before operating the engine. Failure to install the dipstick and fill cap will result in oil becoming contaminated and/or oil being discharged into the engine compartment.

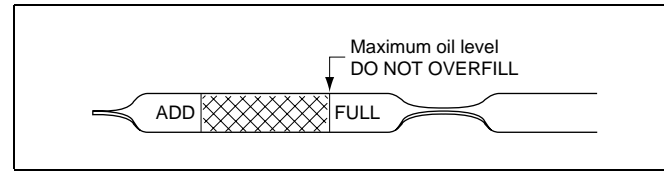

Fig. 26 Check Oil Level on Dipstick

## CHANGING THE OIL

Tool List	Qty. Required
Pliers.....	1
Oil drain pan .....	1
Clean cloth.....	2

For maximum performance and longevity, the engine oil should be replaced after the first five (5) to eight (8) hours of operation. After the initial oil change, it should be changed per the Periodic Service Schedule (Ref Fig. 22 on page 3-26).

## OPERATION AND SERVICE INFORMATION

Read all of manual to become thoroughly familiar with this vehicle. Pay particular attention to all Notes, Cautions and Warnings

The oil must be high quality detergent oil classified 'For Service SF, SG, SH, SJ' or higher. Do not use special additives and do not mix oil with gasoline. The selection of oil viscosity is dependent upon the climate in which the vehicle will be used. Most vehicles require SAE 30 oil; however, vehicles used in cold climates will require a multi-viscosity oil (Ref Fig. 27 on page 3-31).

Synthetic oil meeting ILSAC GF-2, API certification mark and API service symbol with 'SJ/CF ENERGY CONSERVING' or higher, is an acceptable oil at all temperatures. **Use of synthetic oil does not alter required oil change intervals.**

**NOTE** Do not use special additives in recommended oil.  
Do not mix oil with gasoline.

**CAUTION** Air cooled engines run hotter than automotive engines. The use of non-synthetic multi-viscosity oils (5W-30, 10W-30, etc.) in temperatures above 40° F (4° C) will result in higher than normal oil consumption. When using a multi-viscosity oil, check oil level more frequently.

SAE 30 oil, if used below 40° F (4° C) will result in hard starting and possible engine bore damage due to inadequate lubrication.

**WARNING** To reduce the possibility of severe injury, wear rubber gloves to protect skin from exposure to hot, used oil and degreaser. These fluids contain chemicals known to cause cancer.

The oil should be changed with the engine warm. Park the vehicle on a level surface, engage the parking brake and remove the key. Place a

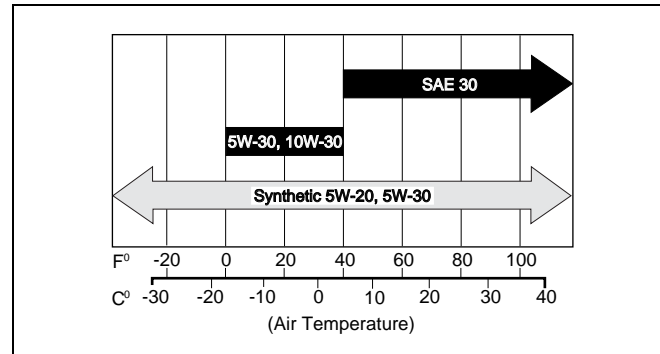

Fig. 27 Oil Viscosity Chart

drain pan under the engine. Wipe the oil fill cap clean with a cloth and remove the cap (Ref Fig. 24 on page 3-30).

Clean the area around the oil drain valve (Ref Fig. 28 on page 3-32). Open the valve and allow the oil to drain through the hole in the engine mounting plate. Close valve once oil has drained.

Add 1 quart (1 liter) of oil. Start and drive vehicle at a slow speed for 30 seconds. Stop and turn off vehicle on a level surface and wait 30 seconds for the oil to settle to the bottom of the engine. Check for leaks. Slowly add more oil to bring level to the FULL mark on dipstick. **Do not overfill.**

Replace dipstick **fully** into the dipstick tube and firmly replace the oil fill cap.

# OPERATION AND SERVICE INFORMATION

Read all of manual to become thoroughly familiar with this vehicle. Pay particular attention to all Notes, Cautions and Warnings

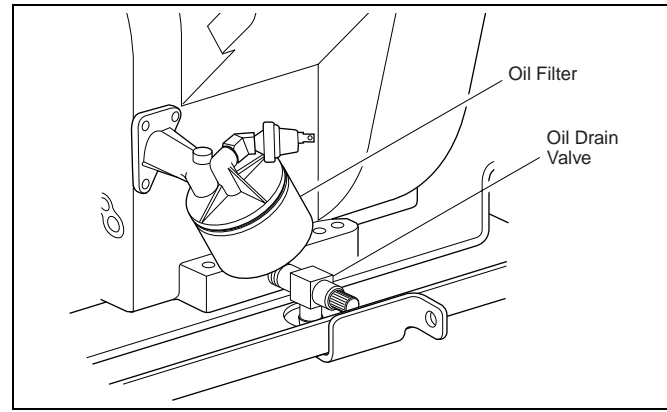

Fig. 28 Oil Drain and Filter

## CHANGING THE OIL FILTER

### Tool List

	Qty. Required
Oil filter wrench, to fit 3" (76 mm) oil filter.....	1
Oil drain pan.....	1
Clean cloth.....	2

Clean the area around the oil filter and oil drain. Drain engine oil per 'Changing the Oil' and remove oil filter (Ref Fig. 28 on page 3-32). Make sure the seal came off with filter and is not stuck to the engine.

Wipe around the sealing surface of filter mount with a clean, lint free cloth. Lightly oil the seal on the new filter with fresh, clean oil. Screw filter on by hand until the seal contacts the filter mount. Tighten 1/2 to 3/4 turn more. Refill engine with new oil per 'Changing the Oil'.

3-32

## LUBRICATION

**CAUTION** Do not use more than three (3) pumps of grease in each grease fitting at any one time. Excess grease may cause grease seals to fail or grease migration into areas that could damage components.

Putting more than three pumps of grease in a grease fitting could damage grease seals and cause premature bearing failure (Ref Fig. 29 on page 3-32).

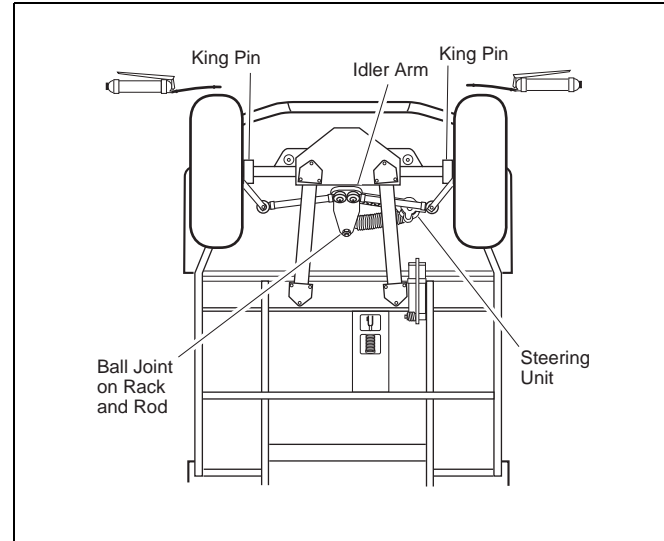

Fig. 29 Lubrication Points



## OPERATION AND SERVICE INFORMATION

Read all of manual to become thoroughly familiar with this vehicle. Pay particular attention to all Notes, Cautions and Warnings

### AIR CLEANER INSPECTION AND REPLACEMENT

The air cleaner is a dual filter cleaner, equipped with a foam pre-cleaner over a conventional paper cartridge. The filters must be serviced per the Periodic Service Schedule (Ref Fig. 22 on page 3-26) for optimum engine life and performance.

**CAUTION** To prevent engine damage, be careful not to let debris fall into the carburetor when servicing the air cleaner.

To prevent water entering air cleaner and causing starting or engine problems, replace air cleaner cover making sure the entire flange around the bottom of the cover fits over the top edge of the air cleaner base. Secure with the spring clips.

Access the filters by unsnapping the spring clip on each side of the air cleaner and removing the air cleaner cover (Ref Fig. 30 on page 3-33). If necessary, vacuum or wipe out any loose dirt or trash from the air cleaner base.

#### Pre-Cleaner Service

**NOTE** The foam pre-cleaner is to be used dry. Do not put oil on the foam.

Carefully remove pre-cleaner from cartridge and wash it in liquid detergent and water. Rinse. Dry by squeezing pre-cleaner in a clean cloth. Do not put oil on the pre-cleaner. Install pre-cleaner over cartridge. Replace air cleaner cover making sure the entire flange around bottom of cover fits over the top edge of the air cleaner base. Secure with the spring clips.

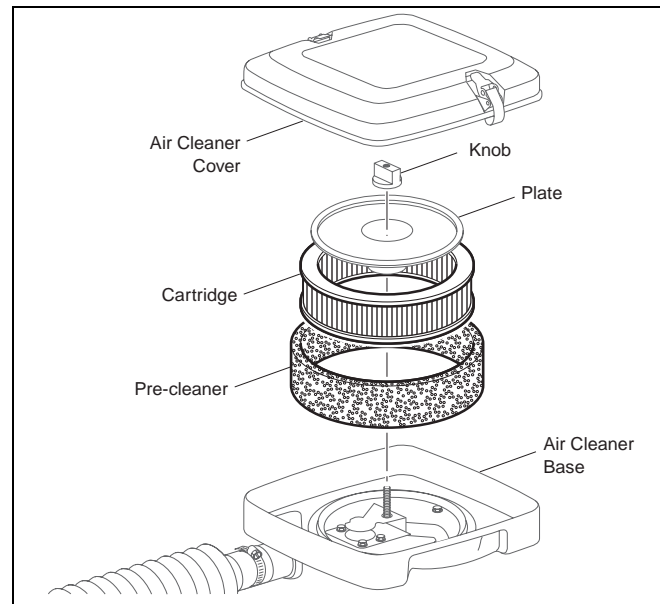

Fig. 30 Air Cleaner

#### Cartridge Service

**CAUTION** Do not use petroleum solvents, pressurized water, or compressed air to clean cartridge. Doing so will damage the cartridge and will damage the engine.

**NOTE** The paper cartridge is a dry unit. Do not use oil on the cartridge.

# OPERATION AND SERVICE INFORMATION

Read all of manual to become thoroughly familiar with this vehicle. Pay particular attention to all Notes, Cautions and Warnings

Unscrew the knob securing the cartridge to the air cleaner base and remove plate. Remove cartridge and inspect. Replace if too dirty to clean or at the first sign of filter paper deterioration. Clean cartridge by gently tapping on a flat surface.

**CAUTION** To reduce the possibility of engine damage from ingesting unfiltered air, ensure plate is centered and correctly seated on top of cartridge before securing with knob.

Place cartridge in air cleaner base. Install plate centered and fully seated on top of cartridge. Secure with knob and install pre-cleaner over cartridge.

Replace air cleaner cover making sure that the entire flange around the bottom of the cover fits over the top edge of the air cleaner base. Secure with the spring clips.

## REAR AXLE

The rear axle is provided with a lubricant level check plug located on the driver side at the rear of the housing (Ref Fig. 31 on page 3-34). Unless leakage is evident, an annual lubricant check is sufficient.

### Checking the Lubricant Level

Tool List	Qty. Required
Wrench, 13 mm .....	1
Funnel .....	1

Clean area around check and fill plugs. Remove the check plug. The correct lubricant level is **just** below the bottom of the threaded hole. If lubricant is to be added, remove the fill plug and add lubricant (SAE 30 oil) using a funnel. Add lubricant slowly until lubricant starts to seep

3-34

from the check plug hole. Install the check plug and the fill plug. In the event that the lubricant is to be replaced, a drain plug is provided at the bottom of the differential housing. Capacity of axle is 48 oz. (1.4 liters).

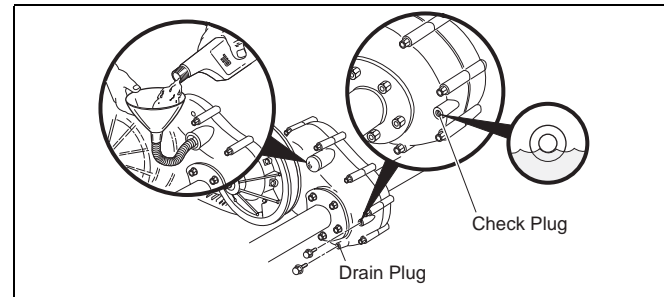

Fig. 31 Add, Check and Drain Rear Axle Lubricant

## STARTER/GENERATOR BELT TENSION

Tool List	Qty. Required
Belt tension gauge .....	1
Wrench, 3/4" .....	1
Wrench, 1/2" .....	2
Socket, 1/4" hex bit, 3/8" drive .....	1
Ratchet, 3/8" drive .....	1
Socket, 3/4", 3/8" drive .....	1
Socket, 1/2", 3/8" drive .....	1
Pry bar .....	1
Torque wrench, 3/8" drive, ft. lbs. ....	1

## OPERATION AND SERVICE INFORMATION

Read all of manual to become thoroughly familiar with this vehicle. Pay particular attention to all Notes, Cautions and Warnings

The starter/generator belt tension should be checked after the first 15-20 hours of operation and set to 75 - 80 lbs. (34 - 36 kg).

**NOTE** A loose belt can cause audible vibration and squeal.

Tighten a **new** starter/generator belt to 90 - 110 lbs. (41 - 50 kg) tension when a gauge is applied half way between the two pulleys (Ref Fig. 32 on page 3-35).

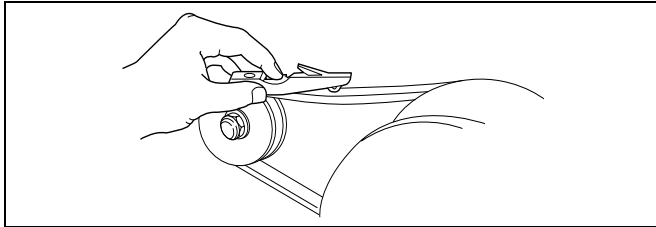

Fig. 32 Check Belt Tension with Gauge

Although not as accurate, the belt may be depressed with a finger. A maximum deflection of 3/8" (1 cm) is acceptable for a **new** belt (Ref Fig. 33 on page 3-35).

Tighten an **existing** belt to 75 - 80 lbs. (34 - 36 kg) tension using the same technique and inspect for cracking or wear. A maximum deflection of 1/2" (13 mm) is acceptable.

### Adjusting the Belt

Loosen front and back pivot bolts of starter/generator (Ref Fig. 34 on page 3-35).

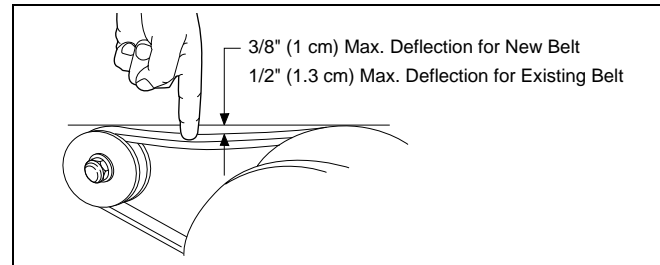

Fig. 33 Check Belt Tension with Finger

Loosen adjusting bolt. Use pry bar to force starter/generator towards front of vehicle until proper belt tension is achieved. Hold starter/generator in place and tighten adjusting bolt.

Tighten pivot bolts to 25 ft. lbs. (35 Nm) torque.

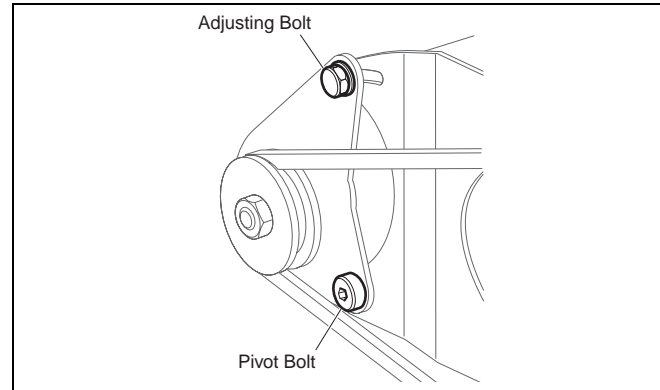

Fig. 34 Adjust Belt Tension

## OPERATION AND SERVICE INFORMATION

Read all of manual to become thoroughly familiar with this vehicle. Pay particular attention to all Notes, Cautions and Warnings

### BATTERY CLEANING

**CAUTION** To reduce the possibility of damage to vehicle or floor, neutralize acid before rinsing battery.

To reduce the possibility of damage to electrical components while cleaning, do not use a pressure washer.

Cleaning should take place per the Periodic Service Schedule (Ref Fig. 22 on page 3-26).

When cleaning the outside of the battery and terminals, first spray with a solution of sodium bicarbonate (baking soda) and water to neutralize any acid deposits before rinsing with clear water.

Use of a water hose without first neutralizing any acid, will move acid from the top of the battery to another area of the vehicle or storage facility where it will attack the metal structure or the concrete/asphalt floor. Additionally, a residue will be left on the battery which is conductive and will contribute to the discharge of the battery.

**WARNING** To reduce the possibility of battery explosion that could result in severe injury or death, do not use metallic spray wand to clean battery and keep all smoking materials, open flame or sparks away from the battery.

The correct cleaning technique is to spray the top and sides of the battery with a solution of sodium bicarbonate (baking soda) and water. This solution is best applied with a plastic spray bottle. The solution should consist of 2 teaspoons (10 ml) of sodium bicarbonate (baking soda) mixed with 1 quart (1 liters) of clear water (Ref Fig. 35 on page 3-36). In addition to the battery, special attention should be paid to metal

components adjacent to the battery which should also be sprayed with the sodium bicarbonate (baking soda) solution.

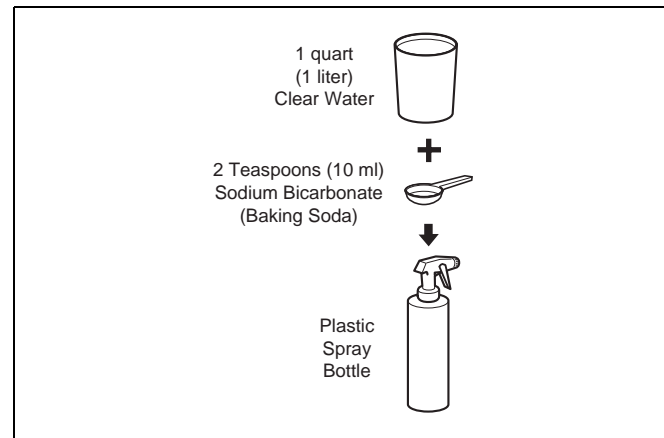

Fig. 35 Preparing Acid Neutralizing Solution

Allow the solution to sit for at least three minutes; use a soft bristle brush or cloth to wipe the tops of the battery to remove any residue that could contribute to the self discharge of the battery. Rinse the entire area with low pressure clear water. Do not use a pressure washer.

### AIR INTAKE AND COOLING FINS

**WARNING** To prevent possible burns, engine parts should be kept clean to reduce risk of overheating and ignition of accumulated debris.

## OPERATION AND SERVICE INFORMATION

Read all of manual to become thoroughly familiar with this vehicle. Pay particular attention to all Notes, Cautions and Warnings

After every off road use, allow to cool and then check for a build up of dirt and debris in the air intake and cooling fins. Dirt and debris may clog the engine's air cooling system. Clean areas shown to prevent engine damage (Ref Fig. 36 on page 3-37). Keep linkages, springs and controls clean. Keep area around muffler free of any combustible material.

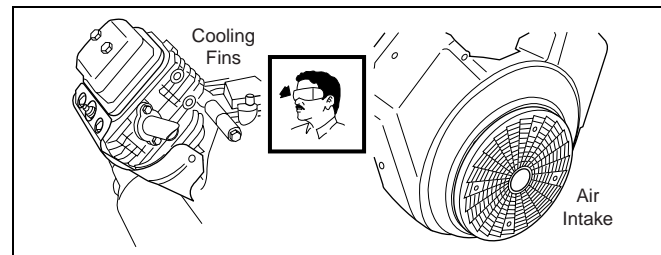

Fig. 36 Cleaning Air Intake and Cooling Fins

### SPARK PLUGS

Tool List	Qty. Required
Spark plug socket, 5/8", 1/2" drive .....	1
Ratchet, 1/2" drive .....	1
Plug gauge, wire type .....	1
Anti-seize compound .....	AR
Torque wrench, 1/2" drive, ft. lbs. ....	1

**CAUTION** Use care not to over-tighten the plug. Over-tightening can cause damage to the aluminum cylinder head threads.

Remove and inspect the spark plugs at intervals per the Periodic Service Schedule (Ref Fig. 22 on page 3-26). All new spark plugs should be properly gapped before installation (Ref Fig. 38 on page 3-40). Apply a light coat of anti-seize compound and tighten to 15 ft. lbs. (20 Nm) torque.

Fouled spark plugs are indicated by a wet, black appearance. This could be caused by a dirty air filter element or other restrictions in the air intake system. Incorrectly adjusted valves, spark plug wires which are in poor condition or poor quality fuel could also contribute to the problem.

**NOTE** Do not sand blast spark plugs. They should be cleaned by scraping or wire brushing by hand and washing in a commercial solvent.

### BRAKES

The master cylinder is located under the driver side seat.

It is important to maintain proper fluid levels in the brake master cylinder. The fill cap for the cylinder is located under the seat. When checking the fluid, wipe off any dirt from the fill cap before removing it to prevent contamination. Fluid level should be maintained at 1/4" (6 mm) below the top of the housing. Use DOT 3 automotive brake fluid.

#### Daily Brake Test

**WARNING** To prevent severe injury or death resulting from operating a vehicle with improperly operating brake system, the braking system must be properly maintained. All driving brake tests must be done in a safe location with regard for the safety of all personnel.

## OPERATION AND SERVICE INFORMATION

Read all of manual to become thoroughly familiar with this vehicle. Pay particular attention to all Notes, Cautions and Warnings

After the vehicle has been put into service, it is recommended that the brakes be checked daily by performing the following test:

Depress the brake pedal. The pedal should have some free travel and then become hard. A brake pedal that has no free travel, excessive free travel or a spongy feel is indicating that a brake inspection is required. A brake pedal that falls after it is applied indicates a leak in the master or wheel cylinders. Check for adequate brake fluid level. Adjust brakes if required and inspect system for fluid leaks.

### PROLONGED STORAGE

**⚠ WARNING ⚠** *To prevent serious injury or death resulting from a possible explosion:*

*Do not handle fuel in an area that is not adequately ventilated. Do not smoke near the fuel tank or refuel near open flame or electrical items which could produce a spark.*

*Store vehicle in a clean, dry area. Do not store in same area as a stove, furnace, water heater, or other appliance that uses a pilot light or has a device that can create a spark.*

*When refueling, inspect the fuel cap for leaks or breaks that could result in fuel spillage.*

*Always wear safety glasses while refueling to prevent possible eye injury from gasoline or gasoline vapor.*

*Keep hands, clothing and jewelry away from moving parts. Use care not to contact hot objects. Raise the rear of the vehicle and support on jack stands before attempting to run the engine.*

Preparing the engine for a prolonged storage period (30 days or more) calls for a few simple steps to prevent a build up of varnish and gum in the carburetor and corrosion in the engine.

- Raise the rear of the vehicle and support on jack stands. Refer to 'Lifting the Vehicle' for proper lifting procedure and safety information.
- Disconnect the fuel hose **at the fuel tank** and plug hose.
- With proper ventilation, depress the accelerator pedal and allow engine to run until it stops due to lack of fuel.
- Remove spark plugs (Refer to page 3-37) and pour about 1 oz. (30 ml) of engine oil into each cylinder. Replace spark plugs, ground spark plug wires and use starter to turn engine over a few seconds to distribute oil.
- Add a gasoline additive to the tank in accordance with the manufacturer's recommendations.
- Reattach fuel line to tank and drive the vehicle for several minutes to circulate the additive through the carburetor.
- While engine is still warm, change oil (Refer to page 3-30).
- Clean body, chassis and engine of debris, mud, chaff or grass (Refer to page 3-36).

### HARDWARE

Periodically, the vehicle should be inspected for loose fasteners. Fasteners should be tightened in accordance with the Torque Specifications table (Ref Fig. 37 on page 3-39).

Use care when tightening fasteners and refer to the Technician's Repair and Service Manual for specific torque values.

## OPERATION AND SERVICE INFORMATION

Read all of manual to become thoroughly familiar with this vehicle. Pay particular attention to all Notes, Cautions and Warnings

Generally, three grades of hardware are used in the vehicle. Grade 5 hardware can be identified by the three marks on the hexagonal head and grade 8 hardware is identified by 6 marks on the head. Unmarked hardware is Grade 2 (Ref Fig. 37 on page 3-39).







<b>ALL TORQUE FIGURES ARE IN FT. LBS. (Nm)</b>										
Unless otherwise noted in text, tighten all hardware in accordance with this chart.										
This chart specifies 'lubricated' torque figures. Fasteners that are plated or lubricated when installed are considered 'wet' and require approximately 80% of the torque required for 'dry' fasteners.										
BOLT SIZE	1/4"	5/16"	3/8"	7/16"	1/2"	9/16"	5/8"	3/4"	7/8"	1"
Grade 2 	4 (5)	8 (11)	15 (20)	24 (33)	35 (47)	55 (75)	75 (102)	130 (176)	125 (169)	190 (258)
Grade 5 	6 (8)	13 (18)	23 (31)	35 (47)	55 (75)	80 (108)	110 (149)	200 (271)	320 (434)	480 (651)
Grade 8 	6 (8)	18 (24)	35 (47)	55 (75)	80 (108)	110 (149)	170 (230)	280 (380)	460 (624)	680 (922)
BOLT SIZE	M4	M5	M6	M8	M10	M12	M14			
Class 5.8 (Grade 2) 	1 (2)	2 (3)	4 (6)	10 (14)	20 (27)	35 (47)	55 (76.4)			
Class 8.8 (Grade 5) 	2 (3)	4 (6)	7 (10)	18 (24)	35 (47)	61 (83)	97 (131)			
Class 10.9 (Grade 8) 	3 (4)	6 (8)	10 (14)	25 (34)	49 (66)	86 (117)	136 (184)			

Fig. 37 Torque Specifications and Bolt Grades

## OPERATION AND SERVICE INFORMATION

Read all of manual to become thoroughly familiar with this vehicle. Pay particular attention to all Notes, Cautions and Warnings

### CAPACITIES AND REPLACEMENT PARTS

Fuel Tank / Fuel	6.0 gal (22.5 liters) 87 Octane
Engine Oil	1 1/2 qt (1.4 liters)
Oil Filter	P/N 492932
Air Cleaner Filter	P/N 394018
Pre-Cleaner Filter	P/N 272490
Spark Plugs	CHAMPION RC12YC (P/N 491055) .030" (.76 mm) Gap
Starter/Generator Belt	P/N 75690-G01
Clutch Belt	P/N 75691-G01
Rear Axle Oil	40 oz (1.2 liters)
Fuse	15 amp (P/N 35212-G01) 7.5 amp (P/N 35212-G05)
Headlight Bulb	P/N 20209-G3
Turn Signal Bulb	#1157 (P/N 21759-G1)
Tail Light Bulb	#1157 (P/N 21759-G1)

Fig. 38 Capacities and Replacement Parts



# GENERAL SPECIFICATIONS

## ST 480

### STANDARD EQUIPMENT:

BATTERY .....	One 12 Volt Maintenance Free (515 CCA, 82 Minute Reserve)
ENGINE .....	16 H.P. (11.9 kW) 29.2 ci (480 cc) Twin Cylinder, Overhead Valve Pressurized Lubrication with Spin Off Filter Magnetron™ Ignition with Transistor Module Replaceable Dry Cartridge Air Filter with Pre-Filter & Remote Intake Fixed Jet Bowl Carburetor, Pulse Fuel Pump
TRANSAXLE.....	13.32:1 Helical geared with Differential Lock and Ground Speed Governor
TRANSMISSION.....	Automatic Continuously Variable Transmission (CVT)
FUEL TANK.....	6 Gallon (23 Liters) Tank, 36 lbs. (16 kg) Fuel Weight
BRAKES.....	Dual Rear Wheel, Self-Adjusting Hydraulic Drum Brakes
PARKING BRAKE.....	Hand Operated Mechanical Parking Brake
FRONT SUSPENSION.....	Leaf Springs with Hydraulic Shock Absorbers
REAR SUSPENSION.....	Leaf Springs with Hydraulic Shock Absorbers
STEERING .....	Single Reduction Rack & Pinion
STEERING WHEEL.....	Dual Handgrips
SEATING.....	Cushion Foam/Vinyl Cover Bucket Seats, Hip Restraint/Hand Hold
SEATING CAPACITY.....	Operator & 1 Passenger
TOTAL LOAD CAPACITY.....	800 lbs. (365 kg) Including Operator, Passenger, Accessories & Cargo 500 lbs. (230 kg) Maximum Bed Load
SPEED.....	16.5 mph (26.5 kph) Max
CHASSIS .....	Powder Coated (DuraShield™), Welded Tubular Steel
VEHICLE PROTECTION.....	Tubular Steel Front Bumper with Brush Guards
BODY .....	Flexible Impact Resistant DuraShield™ Injection Molded TPO (Thermoplastic Olefin) with Base Coat/Clear Coat Front Cowl. DuraShield™ Powder Coated Steel Rear Body
STANDARD COLOR(S).....	ST Series: Hunter Green; ST ADVANTAGE Series: RealTree® Advantage Camo Body and Load Bed

DASH PANEL .....	Scuff Resistant Glass Fiber Reinforced Plastic (Thermoplastic Olefin) with 4 Drink Holders
LOAD BED.....	Rotomolded cross link polyethylene & Electric Dump
LOAD BED FEATURES.....	Hinged Removable Tailgate, Removable Bed Sides
LIGHTING/HORN (Standard).....	Dual Halogen Headlights, Horn
TIRES (Standard).....	22 x 9 - 10 Stryker I® (Uni-directional)
TIRE PRESSURE.....	12 - 16 psi (85 - 110 kPa)
WEIGHT (Without Fuel).....	1100 lbs (480 kg)
OPERATING CONTROLS & INSTRUMENTATION .....	Removable Key, 'Deadman' Accelerator Control, Direction Selector, Audible Reverse Warning, Analog Fuel Gauge, Low Oil Pressure Indicator and 12 Volt Power Outlet

Specifications subject to change without notice.

# GENERAL SPECIFICATIONS

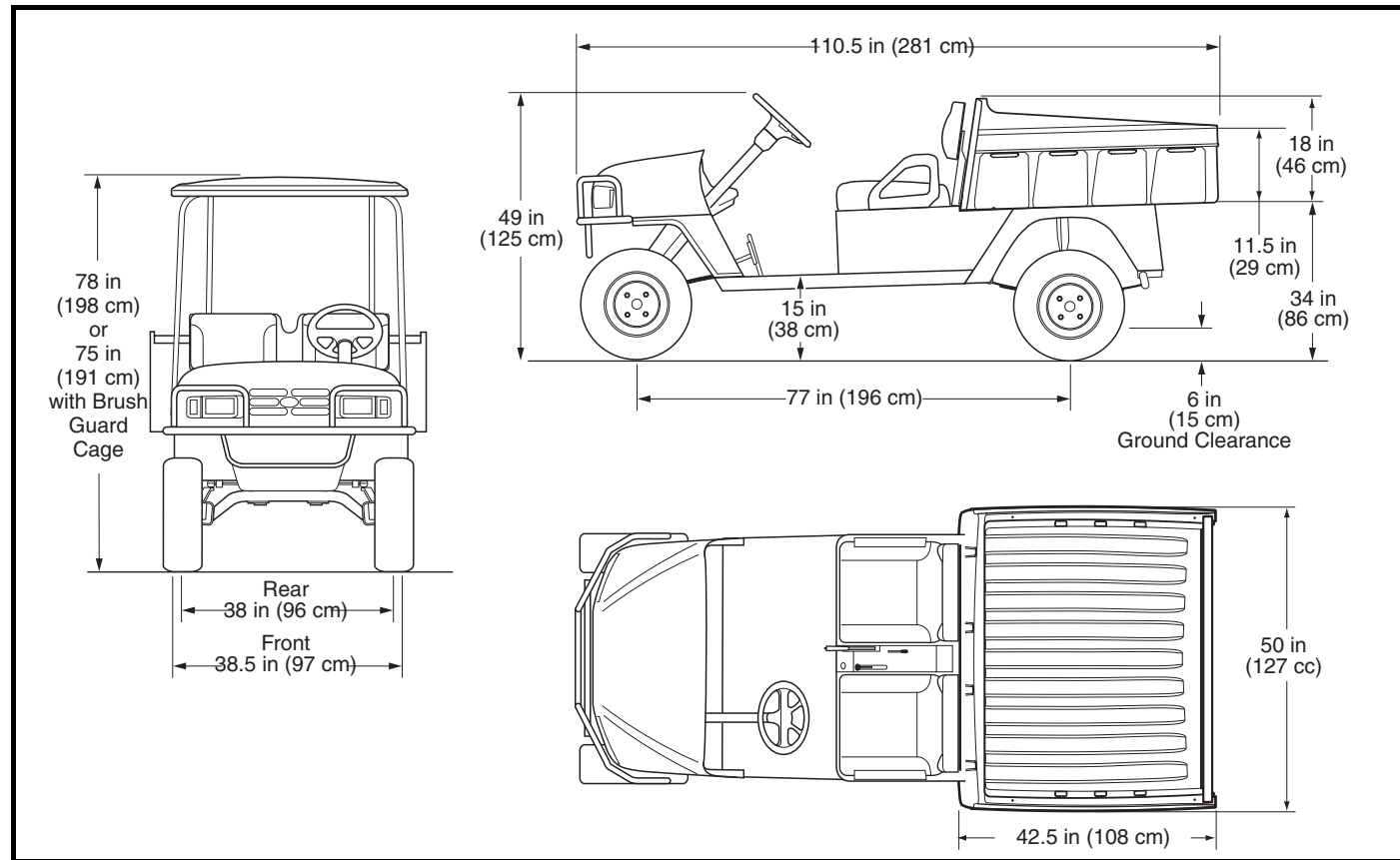

Fig. 1 Vehicle Dimensions

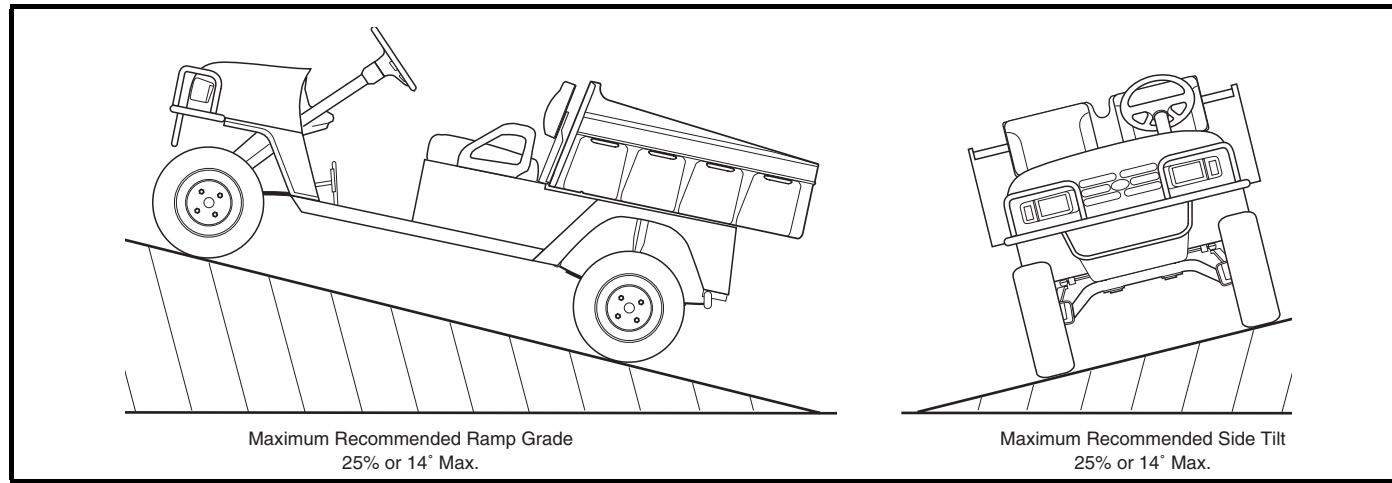

Fig. 2 Vehicle Incline Specifications

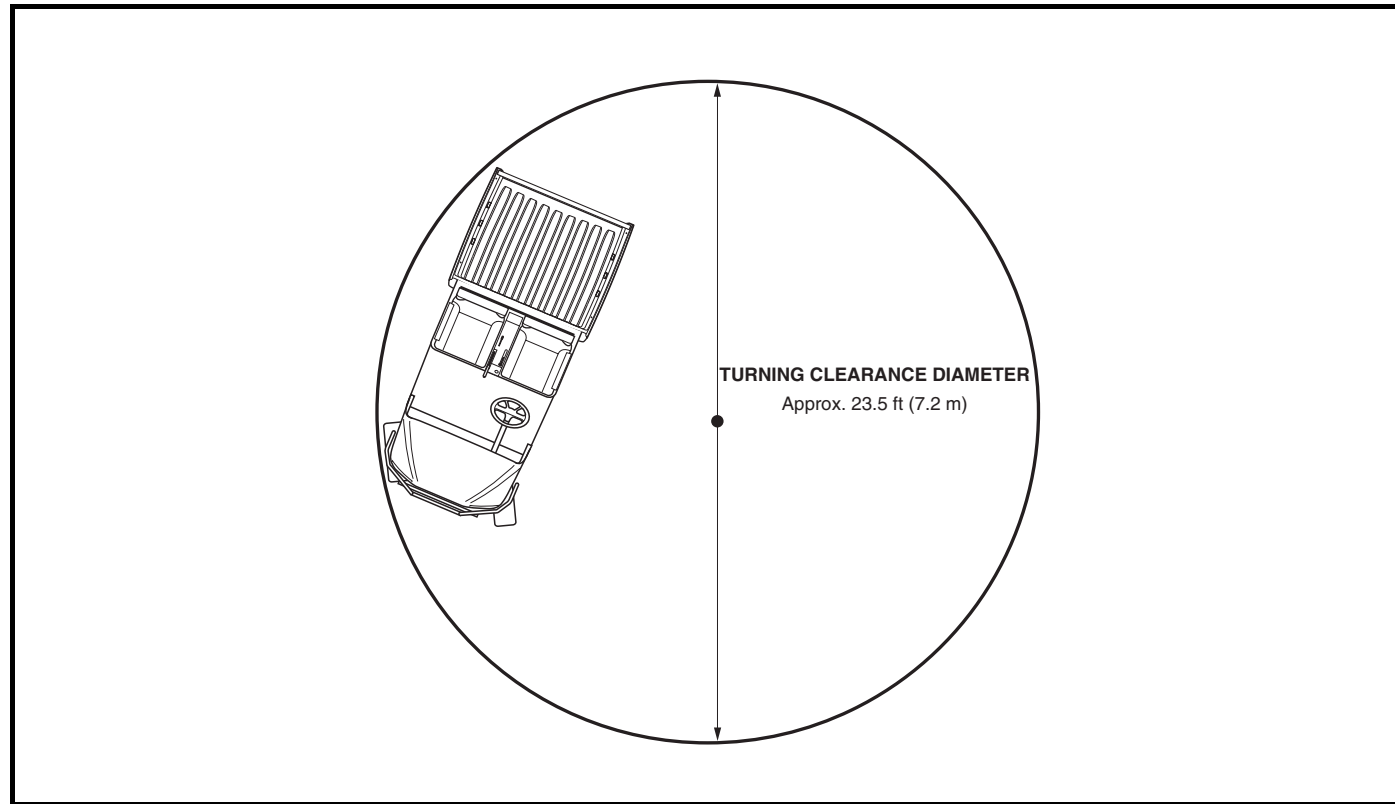

Fig. 3 Vehicle Turning Clearance Diameter

**EMISSION CONTROL SYSTEM WARRANTY**

**STATEMENT**

**(Owner's Defect Warranty Rights and Obligations)**

Refer to the Briggs & Stratton® Operating & Maintenance Instructions, provided with vehicle, for Emission Control System Warranty information.

**ENGINE OWNER WARRANTY POLICY**

Refer to the Briggs & Stratton® Operating & Maintenance Instructions, provided with vehicle, for Engine Warranty information.

**LIMITED WARRANTY** 

---

**Notes:** \_\_\_\_\_  
\_\_\_\_\_  
\_\_\_\_\_  
\_\_\_\_\_  
\_\_\_\_\_  
\_\_\_\_\_  
\_\_\_\_\_  
\_\_\_\_\_  
\_\_\_\_\_  
\_\_\_\_\_  
\_\_\_\_\_  
\_\_\_\_\_  
\_\_\_\_\_  
\_\_\_\_\_  
\_\_\_\_\_  
\_\_\_\_\_  
\_\_\_\_\_  
\_\_\_\_\_  
\_\_\_\_\_  
\_\_\_\_\_

NOT AVAILABLE AT TIME OF PUBLICATION





# LABELS AND PICTOGRAMS

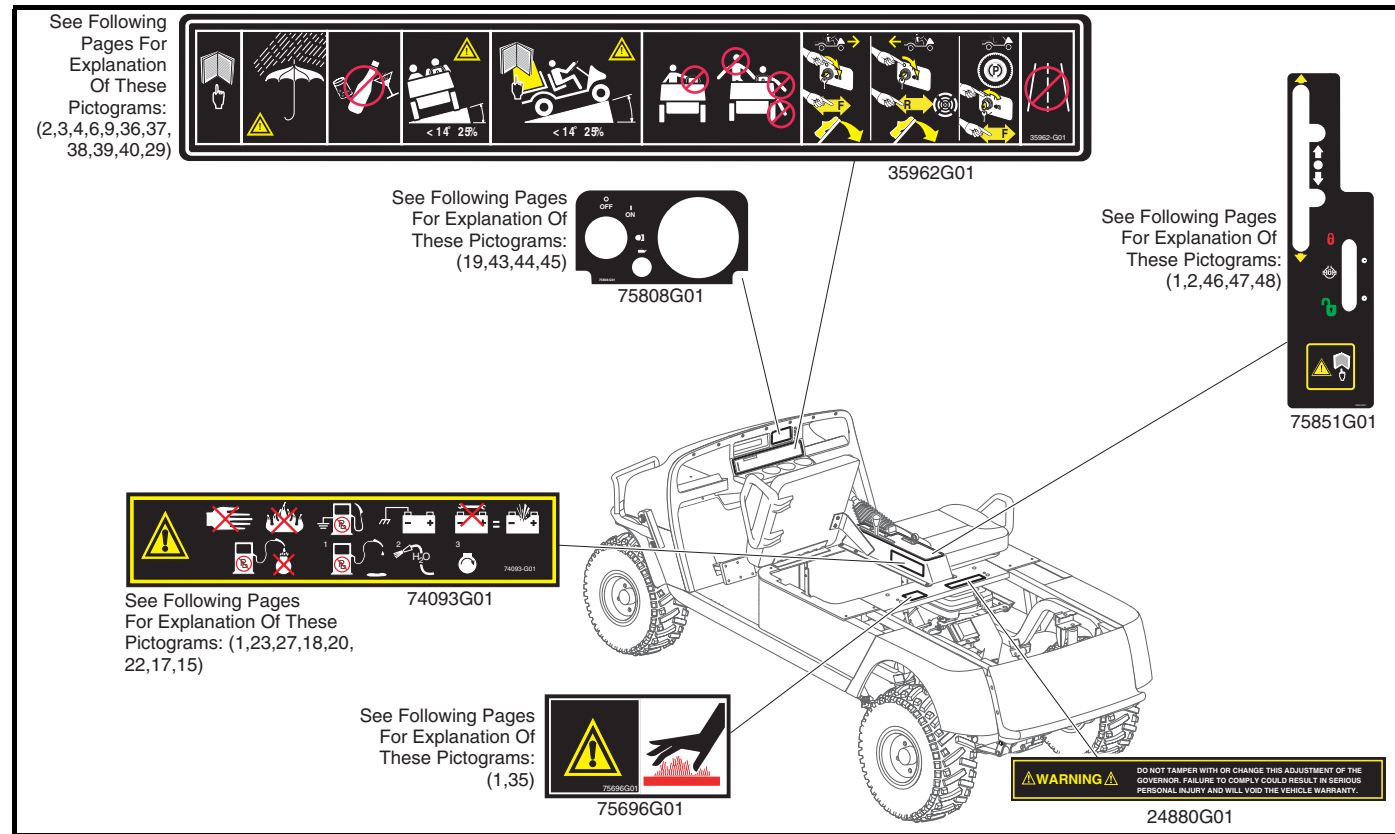

Fig. 1 Label Locations

## Appendix A-1

# LABELS AND PICTOGRAMS

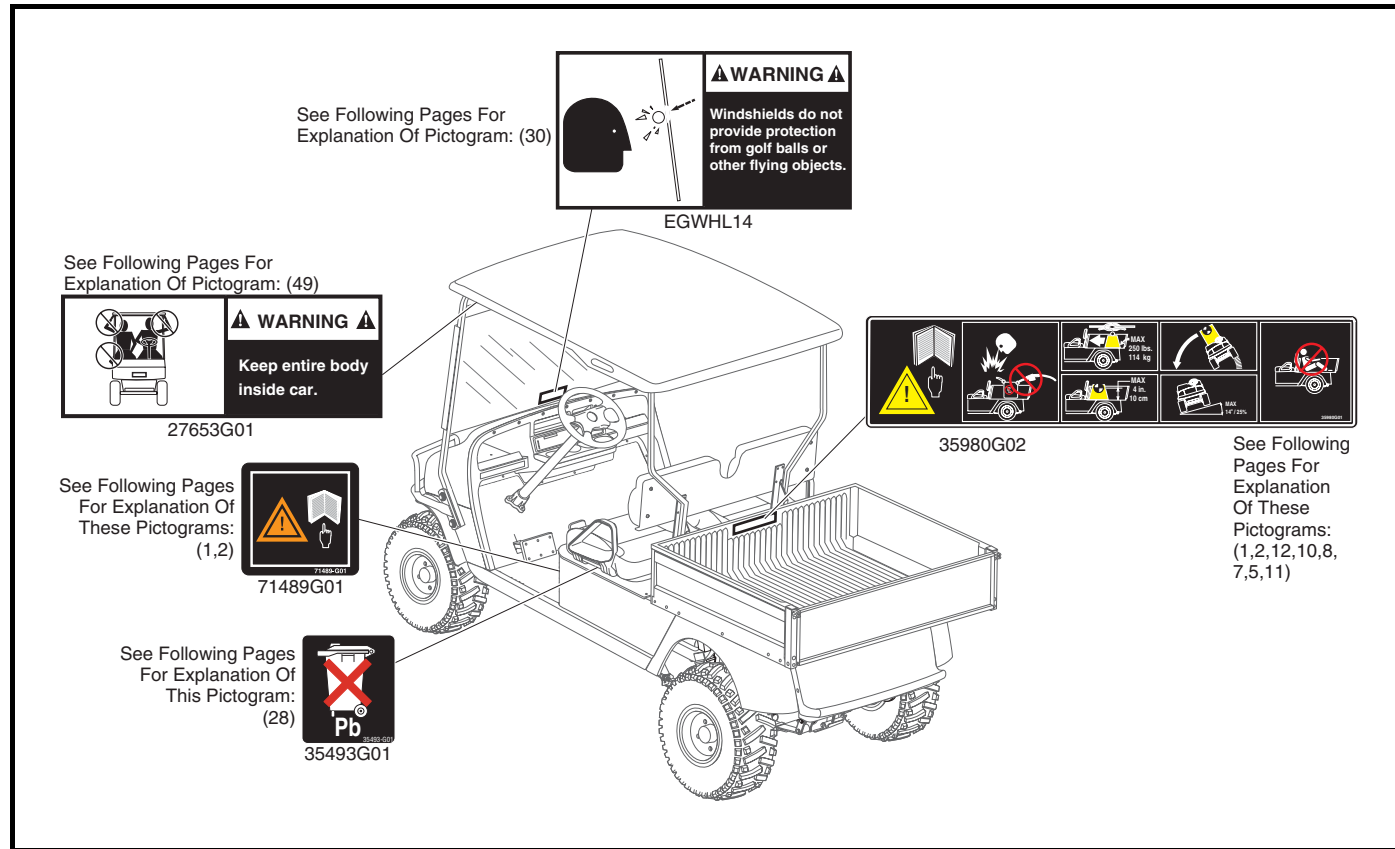

Fig. 2 Label Locations (Continued)

## Appendix A-2

# LABELS AND PICTOGRAMS







1.		<b>WARNING</b>	5.		MAXIMUM CROSS HILL/RAMP ANGLE AS SPECIFIED
2.		READ MANUAL	6.		<b>WARNING</b> MAXIMUM CROSS HILL/RAMP ANGLE AS SPECIFIED
3.		<b>WARNING</b> USE CAUTION IN INCLEMENT WEATHER	7.		LOAD WITH HIGH CENTER OF GRAVITY COULD RESULT IN TIP OVER
4.		<b>WARNING</b> DO NOT OPERATE IF USING ALCOHOL OR DRUGS	8.		LOAD CENTER OF GRAVITY, MAXIMUM HEIGHT

Fig. 3 Pictogram Definitions

## Appendix A-3

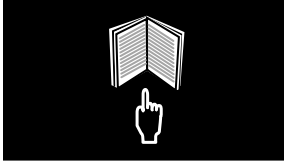
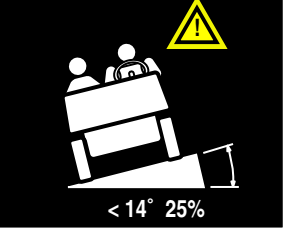
**LABELS AND PICTOGRAMS**



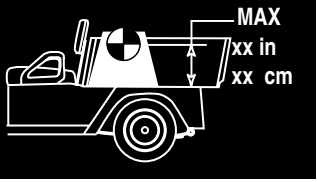

9.		<p><b>WARNING</b>          READ MANUAL          FOR MAXIMUM          LOAD BED          CAPACITY.          MAXIMUM          RAMP/HILL</p>	12.		<p><b>DANGER OF EXPLOSION</b>          DO NOT FILL GAS CAN          IN LOAD BED</p>
10.		<p>SECURE LOAD          AS FAR FORWARD          AS POSSIBLE.          MAXIMUM LOAD          BED CAPACITY</p>	13.		<p><b>WARNING</b>          MAXIMUM          LOAD &amp;          CENTER OF          GRAVITY.          KEEP LOAD          AS FAR          FORWARD          AS POSSIBLE.          DO NOT RIDE          IN LOAD BED</p>
11.		<p>DO NOT RIDE IN          LOAD BED</p>	14.		<p>KEEP HANDS          &amp; FINGERS          AWAY FROM          DUMP BED.          DO NOT          STAND BEHIND          DUMP BED</p>

Fig. 4 Pictogram Definitions (Continued)

Appendix A-4

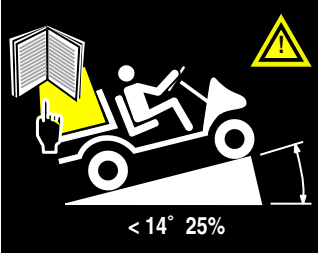
# LABELS AND PICTOGRAMS

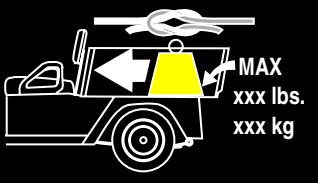
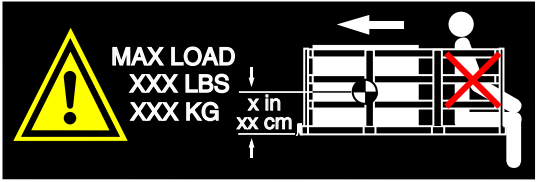

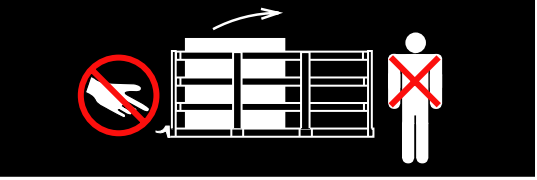







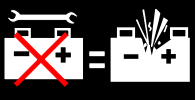

15.		CLEAN UP GASOLINE SPILLS WITH WATER BEFORE STARTING ENGINE	22.		SHORTING BATTERY TERMINALS MAY CAUSE EXPLOSION
16.		UNLEADED GASOLINE	23.		NO TAMPERING. KEEP HANDS OUT
17.		DO NOT SPILL FUEL ON A HOT ENGINE	24.		WARNING CORROSIVE
18.		GROUND FUEL PUMP	25.		WARNING EXPLOSIVE
19.		LOW OIL PRESSURE	26.		WARNING LETHAL VOLTAGE
20.		NEGATIVE GROUND BATTERY	27.		DO NOT EXPOSE TO FLAME
21.		DO NOT CONNECT POSITIVE BATTERY TERMINAL TO GROUND			

Fig. 5 Pictogram Definitions (Continued)

Appendix A-5

# LABELS AND PICTOGRAMS







28.		DO NOT DISPOSE OF BATTERIES IN LANDFILL	33.		WEAR EYE PROTECTION
29.		DO NOT DRIVE ON HIGHWAY	34.		NO SMOKING
30.		WINDSHIELDS DO NOT PROVIDE PROTECTION FROM FLYING OBJECTS	35.		HOT SURFACE
31.		BATTERIES ARE HEAVY. USE CARE LIFTING	36.		OPERATE FROM DRIVERS SIDE ONLY
32.		USE INSULATED TOOLS			

Fig. 6 Pictogram Definitions (Continued)

## Appendix A-6

<b>37.</b>		<p>KEEP ARMS AND LEGS WITHIN VEHICLE</p>	<b>40.</b>		<p>TO LEAVE A GASOLINE POWERED VEHICLE IN PARK: * APPLY PARKING BRAKE * TURN KEY TO OFF * MOVE DIRECTION SELECTOR TO FORWARD</p>
<b>38.</b>		<p>TO OPERATE VEHICLE IN FORWARD: * TURN KEY TO ON * MOVE DIRECTION SELECTOR TO FORWARD * DEPRESS ACCELERATOR PEDAL AND ACCELERATE SMOOTHLY</p>	<b>41.</b>		<p>TO LEAVE AN ELECTRIC POWERED VEHICLE IN PARK: * APPLY PARKING BRAKE * TURN KEY TO OFF * MOVE DIRECTION SELECTOR TO NEUTRAL</p>
<b>39.</b>		<p>TO OPERATE VEHICLE IN REVERSE: * TURN KEY TO ON * MOVE DIRECTION SELECTOR TO REVERSE * AN AUDIBLE DEVICE WILL SOUND * DEPRESS ACCELERATOR PEDAL AND ACCELERATE SMOOTHLY</p>	<b>42.</b>		<p>KEEP CLEAR HAND OR FINGERS CAN BE TRAPPED</p>

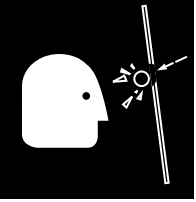
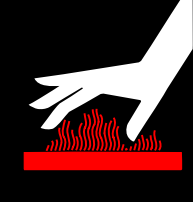
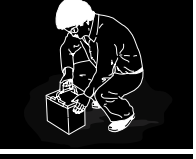
Fig. 7 Pictogram Definitions (Continued)

# LABELS AND PICTOGRAMS





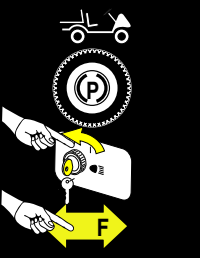
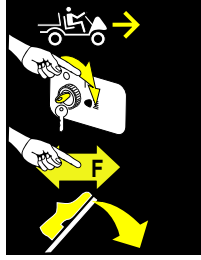
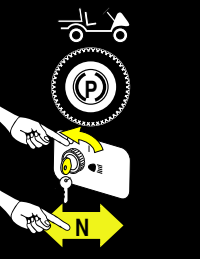
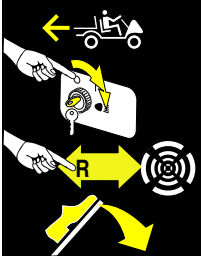
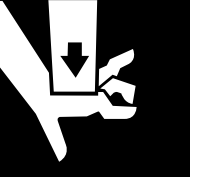

43.		ON POSITION			
44.		OFF POSITION			
45.		HEADLIGHTS			
46.		UNLOCKED			
47.		LOCKED			
			48.		DIFFERENTIAL LOCKED
			49.		WARNING KEEP ENTIRE BODY INSIDE CAR

Fig. 8 Pictogram Definitions (Continued)



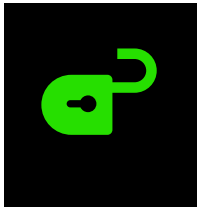

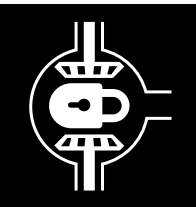
*Starting Model Year 2004*



A Textron Company

E-Z-GO Division of Textron Inc.  
P. O. Box 388 Augusta, Georgia 30903-0388 USA  
Inside USA Phone: 1-800-241-5855, FAX: 1-800-448-8124  
Outside USA Phone: 010-1-706-798-4311, FAX: 010-1-706-771-4609

Copyrighted Material  
This manual may not be reproduced in whole or  
in part without the express permission of  
E-Z-GO Division of Textron Inc.  
Technical Communications Department

76211-G01

## Free Manuals Download Website

<http://myh66.com>

<http://usermanuals.us>

<http://www.somanuals.com>

<http://www.4manuals.cc>

<http://www.manual-lib.com>

<http://www.404manual.com>

<http://www.luxmanual.com>

<http://aubethermostatmanual.com>

Golf course search by state

<http://golfingnear.com>

Email search by domain

<http://emailbydomain.com>

Auto manuals search

<http://auto.somanuals.com>

TV manuals search

<http://tv.somanuals.com>