



VENTED DECORATIVE APPLIANCE OWNER'S OPERATION AND INSTALLATION MANUAL



We recommend that our products be installed and serviced by professionals who are certified in the U.S. by NFI (National Fireplace Institute).
www.nficertified.org

ANSI Z21.60-2003
CSA 2.26-2003

APPROVED

**MODELS VTD-18NV-JHB, VTD-18PV-JHB, VTD-24NV-JHB,
VTD-24PV-JHB, VTD-30NV-JHB AND VTD-30PV-JHB**

WARNING: If the information in this manual is not followed exactly, a fire or explosion may result causing property damage, personal injury or loss of life.

- Do not store or use gasoline or other flammable vapors and liquids in the vicinity of this or any other appliance.
- **WHAT TO DO IF YOU SMELL GAS**
 - Do not try to light any appliance.
 - Do not touch any electrical switch; do not use any phone in your building.
 - Immediately call your gas supplier from a neighbor's phone. Follow the gas supplier's instructions.
 - If you cannot reach your gas supplier, call the fire department.
- Installation and service must be performed by a qualified installer, service agency or the gas supplier.

INSTALLER: Leave this manual with the appliance
CONSUMER: Retain this manual for future reference.

For more information, visit www.desatech.com

TABLE OF CONTENTS

Safety Information	2	Specifications	12
Product Identification	4	Troubleshooting	13
Local Codes.....	5	Service Hints	17
Unpacking.....	5	Technical Service.....	17
Product Features.....	5	Replacement Parts.....	17
Optional Accessories.....	5	Accessories	17
Installation	5	Wiring Diagrams	17
Operating Appliance	10	Illustrated Parts Breakdown and Parts List.....	18
Inspecting Burners.....	12	Warranty Information	Back Cover
Cleaning and Maintenance.....	12		

SAFETY INFORMATION

WARNING: Improper installation, adjustment, alteration, service or maintenance can cause injury or property damage. Refer to this manual for correct installation and operational procedures. For assistance or additional information consult a qualified installer, service agency or the gas supplier.

This appliance may be installed in an aftermarket,* permanently located, manufactured (mobile) home, where not prohibited by local codes.

This appliance is only for use with the type of gas indicated on the rating plate. This appliance is not convertible for use with other gases.

* Aftermarket: Completion of sale, not for purpose of resale, from the manufacturer

WARNING: This appliance is for installation only in a solid-fuel burning masonry or UL127 factory-built fireplace, constructed of noncombustible material and connected to a working flue. (See page 6 for minimum flue opening.)

WARNING: This is a gas-fired heater. It uses air (oxygen) from the room in which it is installed. Provisions for adequate combustion and ventilation air must be provided. Refer to the *National Fuel Gas Codes, ANSI Z233.1/NFPA 54, Section 5.3, Air for Combustion and Ventilation.*

State of Massachusetts: The installation must be made by a licensed plumber or gas fitter in the Commonwealth of Massachusetts.

SAFETY INFORMATION

Continued

⚠ WARNING: This product contains and/or generates chemicals known to the State of California to cause cancer or birth defects or other reproductive harm.

⚠ WARNING: Keep flue open when operating unit.

IMPORTANT: Read this owner's manual carefully and completely before trying to assemble, operate or service this log set. Improper use of this log set can cause serious injury or death from burns, fire, explosion, electrical shock and carbon monoxide poisoning.

⚠ DANGER: Carbon monoxide poisoning may lead to death!

Carbon Monoxide Poisoning: Early signs of carbon monoxide poisoning resemble the flu, with headaches, dizziness or nausea. If you have these signs, the log set may not be working properly. **Get fresh air at once!** Have log set serviced. Some people are more affected by carbon monoxide than others. These include pregnant women, people with heart or lung disease or anemia, those under the influence of alcohol and those at high altitudes.

Natural and Propane/LP Gas: Natural and propane/LP gas are odorless. An odor-making agent is added to the gas. The odor helps you detect a gas leak. However, the odor added to the gas can fade. Gas may be present even though no odor exists.

Make certain you read and understand all warnings. Keep this manual for reference. It is your guide to safe and proper operation of this log set.

⚠ WARNING: Any change to this log set or its controls can be dangerous.

⚠ WARNING: Do not use a blower insert, heat exchanger insert or other accessory not approved for use with this appliance.

⚠ WARNING: This appliance is equipped for use with type of gas indicated on rating plate.

⚠ WARNING: Do not allow fans to blow directly into the fireplace. Avoid any drafts that alter burner flame patterns.

Due to high temperatures, the appliance should be located out of traffic and away from furniture and draperies.

Do not place clothing or other flammable material on or near the appliance. Never place any objects on the heater.

Appliance base assembly becomes very hot when running. Keep children and adults away from hot surface to avoid burns or clothing ignition. Log set will remain hot for a time after shutdown. Allow surface to cool before touching.

Carefully supervise young children when they are in the room with log set. When using handheld remote accessory keep selector switch in the OFF position to prevent children from turning on burners with remote.

You must operate this log set with a fireplace screen in place. Make sure fireplace screen is closed before running log set.

SAFETY INFORMATION

Continued

Keep the log set area clear and free from combustible materials, gasoline and other flammable vapors and liquids.

Children and adults should be alerted to the hazard of high temperature and should stay away to avoid burns or clothing ignition.

1. Do not place propane/LP supply tank(s) inside any structure. Locate propane/LP supply tank(s) outdoors (propane/LP units only).
2. If you smell gas
 - shut off gas supply
 - do not try to light any appliance
 - do not touch any electrical switch; do not use any phone in your building
 - immediately call your gas supplier from a neighbor's phone. Follow the gas supplier's instructions
 - if you cannot reach your gas supplier, call the fire department
3. Never install the log set
 - in a recreational vehicle
 - where curtains, furniture, clothing or other flammable objects are less than 42" from the front, top or sides of the log set.
 - in high traffic areas
 - in windy or drafty areas
4. Before installing in a solid fuel burning fireplace, the chimney flue and firebox must be cleaned of soot, creosote, ashes and loose paint by a qualified chimney cleaner. Creosote will ignite if highly heated. Inspect chimney flue for damage. If damaged, repair flue before operating appliance.
5. Do not operate heater if any log is broken. Do not operate heater if a log is chipped (diminished or larger).
6. This log set is designed to be smokeless. If logs ever appear to smoke, turn off appliance and call a qualified service person. **Note:** During initial operation, slight smoking could occur due to log curing and the burning of manufacturing residues. You may wish to add more ventilation by opening a window.
7. To reduce the creation of soot, follow the instructions in *Cleaning and Maintenance*, page 12.

8. The installation and provisions for combustion and ventilation air must conform with the *National Fuel Gas Codes, ANSI Z233.1/NFPA 54, Section 5.3, Air for combustion and Ventilation.*
9. To prevent performance problems, do not use propane/LP fuel tank of less than 100 lb. capacity (propane/LP units only).
10. Do not run log set
 - where flammable liquids or vapors are used or stored
 - under dusty conditions
11. Do not burn solid fuel in the fireplace after installing the log set. Do not use this log set to cook food or burn paper or other objects.
12. Do not use heater if any part has been exposed to or under water. Immediately call a qualified service technician to inspect the room heater and to replace any part of the control system and any gas control which has been under water.
13. Turn log set off and let cool before servicing, installing or repairing. Only a qualified service person should install, service or repair log set.
14. Provide adequate clearances around air openings.

PRODUCT IDENTIFICATION

⚠ WARNING: Failure to position the parts in accordance with these diagrams or failure to use only parts specifically approved with this appliance may result in property damage or personal injury.

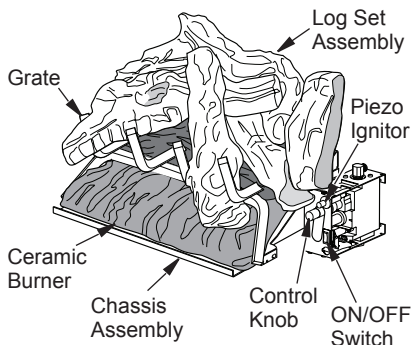

Figure 1 - Product Identification

LOCAL CODES

Install and use log set with care. Follow all local codes. In the absence of local codes, use the latest edition of the *National Fuel Gas Code ANSI Z223.1/NFPA 54**

*Available from:

American National Standards Institute, Inc.
1430 Broadway
New York, NY 10018
National Fire Protection Association, Inc.
Battery march park
Quincy, MA 02269

UNPACKING

 **CAUTION:** Do not remove the data plates from the grate assembly. The data plates contain important warranty and safety information.

1. Remove log set assembly from carton. *Note:* Do not pick up assembly by logs. This could damage unit. Always handle assembly by grate.
2. Remove control cover floor media components.
3. Remove all protective packaging applied to log set for shipment.
4. Check all items for any shipping damage. If damaged, promptly inform dealer where you bought appliance.

PRODUCT FEATURES

This unitized log set is tested and approved to *ANSI Z21.60-2003* and *CSA 2.26-2003* as a vented decorative appliance.

PIEZO IGNITOR

This unit has a piezo ignitor. This system requires no matches, batteries or other sources to light appliance.

OPTIONAL ACCESSORIES

- VTD-HLCN/P - Converts valve from ON/OFF to HI/LO
- OFSM-RCN/P - Converts valve from ON/OFF to HI/LO for use with hand-held ON/OFF remote (included)
- OF-RC - Converts ON/OFF valve for use with hand-held ON/OFF remote

See *Accessories*, page 17.

INSTALLATION

 **WARNING:** Before installing in a solid fuel burning fireplace, the chimney flue and firebox must be cleaned of soot, creosote, ashes and loose paint by a qualified chimney cleaner. Creosote will ignite if highly heated. A dirty chimney flue may create and distribute soot within the house. Inspect chimney flue for damage. If damaged, repair flue damper before operating appliance.

 **WARNING:** Make sure selector switch is in the OFF position before installing appliance.

NOTICE: Installation, service and repair of this appliance must be performed by a qualified installer, service agency, company or gas supplier experienced with this type of gas appliance. Only factory authorized components listed in these instructions may be used in accordance with the manufacturer's instructions and all codes and requirements of the authority having jurisdiction. Any modifications to or use of unauthorized components or accessory items will void the manufacturer's warranty and may result in a hazardous condition.

 **WARNING:** Do not place lava rocks and log scraps on burner.

CHECK GAS TYPE

Use the correct gas type (natural or propane/LP) for your unit. If your gas supply is not correct, DO NOT install this into your fireplace. See the dealer where you bought the appliance for proper type.

INSTALLATION

Continued

⚠ WARNING: This appliance is equipped for (natural or propane/LP) gas. Field conversion is not permitted.

INSTALLATION AND CLEARANCES

The charts in Figure 2 indicate technical information regarding the installation of your gas log set. Please make sure that all of the specifications shown are applicable before installation is attempted.

MINIMUM FIREBOX SIZES				
MODEL	FRONT WIDTH	BACK WIDTH*	DEPTH	HEIGHT
VTD-18NV-JHB VTD-18PV-JHB	28"	16"	14"	18"
VTD-24NV-JHB VTD-24PV-JHB	29 3/4"	20"	15 1/2"	18"
VTD-30NV-JHB VTD-30PV-JHB	36"	27"	18"	18"

*At depth indicated

BURNER ORIFICE				
LOG SIZE	NATURAL		PROPANE/LP	
	INCHES	NO.	INCHES	NO.
18"	0.1495	25	0.0935	42
24"	0.1570	22	0.0980	40
30"	0.1660	19	0.1015	38

SPECIFICATIONS (W.C.)			
FUEL INLET PRESSURE	MANIFOLD PRESSURE		MANIFOLD PRESSURE
	MIN.	MAX.	
NG	5"	10.5"	3.5
LP	11"	14"	10

Figure 2 - Technical Information Charts

FLUE OPENING SPECIFICATIONS

Note: This vented appliance must be installed only in a solid-fuel burning fireplace constructed of noncombustible material. The fireplace must include a flue and venting system with the minimum openings shown in Figure 3.

MODEL	BURNER	BTU INPUT	MINIMUM VENT OPENING
VTD-18NV-JHB VTD-18PV-JHB	18" Ramp	59,000	8" dia.
VTD-24NV-JHB VTD-24PV-JHB	24" Ramp	69,000	8" dia.
VTD-30NV-JHB VTD-30PV-JHB	30" Ramp	74,000	8" dia.

Figure 3 - Specifications

VENTING SPECIFICATIONS FOR INSTALLATION

The fireplace chimney flue and vent must be drafting properly. To check the vent for proper drafting: Light a tightly rolled newspaper on one end and place it at the inside front edge of the fireplace. Observe the smoke and be sure the vent is properly drawing it up the chimney. If the smoke spills out into the room, extinguish the flame and remove any obstruction until proper venting is achieved.

The chimney flue must have a minimum free air opening of 43" during operation of this log set. A damper clamp is provided to fix the damper in position.

The minimum flue sizes shown in Figure 2 are based on a 6' chimney height using round pipe. Your minimum flue size will vary based on input rate and chimney height. Refer to the *National Fuel Gas Code ANSI Z223.1/NFPA 54, Section 6.6*, for details.

INSTALLING DAMPER CLAMP

Secure the damper stop clamp to the edge of the damper as shown in Figure 4. If for any reason this clamp doesn't work on your fireplace, another suitable clamp or permanent stop must be installed, or the damper blade must be cut or removed.

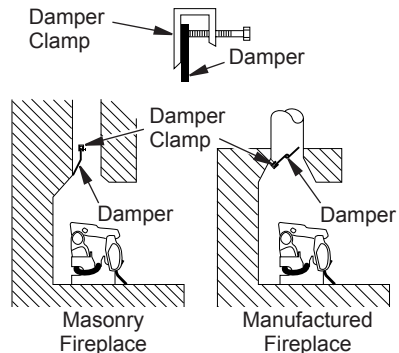

Figure 4 - Attaching Damper Clamp

INSTALLATION

Continued

INSTALLING APPLIANCE ASSEMBLY

⚠ WARNING: If installing in a sunken fireplace, special care is needed. You must raise the fireplace floor to allow access to appliance control panel. This will insure adequate air flow and guard against sooting and controls being damaged. Raise fireplace floor with noncombustible material. Make sure material is secure.

⚠ CAUTION: Do not pick up appliance assembly by logs. This could damage unit. Only handle assembly by grates.

IMPORTANT: Make sure the appliance is level. If unit is not level, unit will not work properly.

Installation Items Needed

- control cover kit (provided with appliance)
 - approved flexible gas hose and fittings (provided with appliance) (if allowed by local codes)
 - sealant (resistant to propane/LP gas, not provided)
1. Apply pipe joint sealant lightly to male threads of gas fitting (not provided). Connect approved flexible gas hose to inlet side of gas control valve (see Figure 5).
 2. Position appliance in fireplace.
 3. Connect to gas supply. See *Connecting To Gas Supply*.

Flexible Gas Hose
(If Allowed by Local Codes)

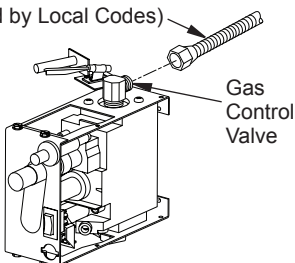

Figure 5 - Attaching Flexible Gas Hose to Gas Control Valve

CONNECTING TO GAS SUPPLY

⚠ WARNING: This appliance requires a 3/8" NPT (National Pipe Thread) inlet connection to the pressure regulator.

⚠ WARNING: A qualified service person must connect heater to gas supply. Follow all local codes.

⚠ CAUTION: Never connect propane/LP fireplace directly to the propane/LP supply. This unit requires an external regulator (not supplied). Install the external regulator between the unit and propane/LP supply

⚠ WARNING: Never connect natural gas fireplace to private (non-utility) gas wells. This gas is commonly known as wellhead gas.

Installation Items Needed

Before installing log set, make sure you have the items listed below.

- external regulator (supplied by installer)
- piping (check local codes)
- sealant (resistant to propane/LP gas)
- equipment shutoff valve *
- test gauge connection *
- sediment trap
- tee joint
- pipe wrench
- approved flexible gas line with gas connector (if allowed by local codes) (provided)

* A CSA design-certified equipment shutoff valve with 1/8" NPT tap is an acceptable alternative to test gauge connection. Purchase the optional CSA design-certified equipment shutoff valve from your dealer. See *Accessories*, page 17.

INSTALLATION

Continued

For propane/LP units, the installer must supply an external regulator. The external regulator will reduce incoming gas pressure. You must reduce incoming gas pressure to between 11 and 14 inches of water. If you do not reduce incoming gas pressure, regulator damage could occur. Install external regulator with the vent pointing down as shown in Figure 6. Pointing the vent down protects it from freezing rain or sleet.

CAUTION: Use only new, black iron or steel pipe. Internally-tinned copper tubing may be used in certain areas. Check your local codes. Use pipe of 1/2" diameter or greater to allow proper gas volume to heater. If pipe is too small, undue loss of volume will occur.

Installation must include an equipment shutoff valve, union and plugged 1/8" NPT tap. Locate NPT tap within reach for test gauge hook up. NPT tap must be upstream from log set (see Figure 7).

IMPORTANT: Install equipment shutoff valve in an accessible location. The equipment shutoff valve is for turning on or shutting off the gas to the appliance.

Check your building codes for any special requirements for locating equipment shutoff valve to fireplaces.

Apply pipe joint sealant lightly to male NPT threads. This will prevent excess sealant from going into pipe. Excess sealant in pipe could result in clogged heater valves.

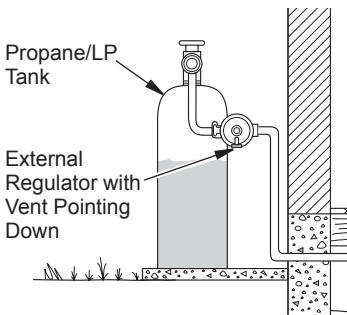

Figure 6 - External Regulator with Vent Pointing Down

WARNING: Use pipe joint sealant that is resistant to liquid petroleum (LP) gas.

We recommend that you install a sediment trap in supply line as shown in Figure 7. Locate sediment trap where it is within reach for cleaning. Install in piping system between fuel supply and appliance. Locate sediment trap where trapped matter is not likely to freeze. A sediment trap traps moisture and contaminants. This keeps them from going into heater controls. If sediment trap is not installed or is installed wrong, heater may not run properly.

CAUTION: Avoid damage to gas control. Hold gas control with wrench when connecting it to gas piping and/or fittings.

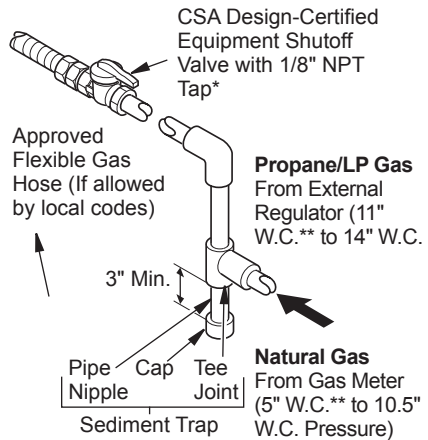

Figure 7 - Gas Connection

* Purchase the optional CSA design-certified shutoff valve from your dealer. See *Accessories*, page 17.

** Minimum inlet pressure for purpose of input adjustment.

INSTALLATION

Continued

CHECKING GAS CONNECTIONS

⚠ WARNING: Test all gas piping and connections, internal and external to unit, for leaks after installing or servicing. Correct all leaks at once.

⚠ WARNING: Never use an open flame to check for a leak. Apply a noncorrosive leak detection fluid to all joints. Bubbles forming show a leak. Correct all leaks at once.

⚠ CAUTION: Make sure external regulator has been installed between propane/LP supply and appliance. See guidelines under *Connecting to Gas Supply*, page 7.

PRESSURE TESTING GAS SUPPLY PIPING SYSTEM

Test Pressures In Excess Of 1/2 PSIG (3.5 kPa)

1. Disconnect appliance with its individual equipment shutoff valve from gas supply piping system. Pressure in excess of 1/2 psig will damage appliance regulator.
2. Cap off open end of gas pipe where equipment shutoff valve was connected.
3. Pressurize supply piping system by either opening propane/LP supply tank valve for propane/LP gas or opening main gas valve located on or near gas meter for natural gas, or using compressed air.
4. Check all joints of gas supply piping system. Apply noncorrosive leak detection fluid to gas joints. Bubbles forming show a leak.
5. Correct all leaks at once.
6. Reconnect log set and equipment shutoff valve to gas supply. Check reconnected fittings for leaks.

Test Pressures Equal To or Less Than 1/2 PSIG (3.5 kPa)

1. Close equipment shutoff valve (see Figure 8).
2. Pressurize supply piping system by either using compressed air or opening main gas valve located on or near gas meter.
3. Check all joints from gas meter to equipment shutoff valve for natural gas or propane/LP supply to equipment shutoff valve for propane/LP (see Figure 9 or 10). Apply noncorrosive leak detection fluid to all joints. Bubbles forming show a leak.
4. Correct all leaks at once.

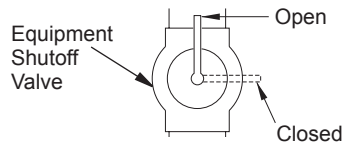

Figure 8 - Equipment Shutoff Valve

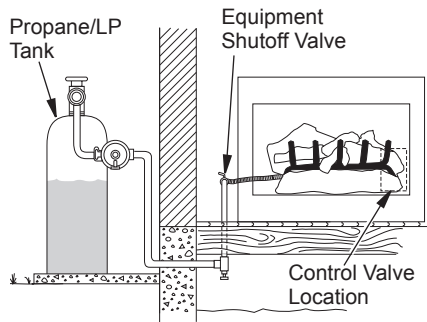

Figure 9 - Checking Gas Joints (Propane/LP Gas Only)

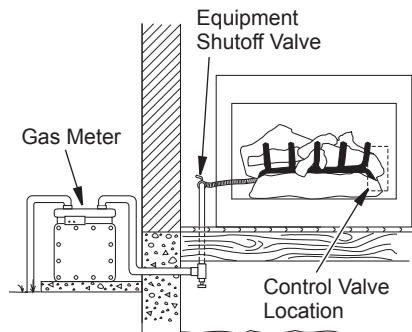

Figure 10 - Checking Gas Joints (Natural Gas Only)

INSTALLATION

Continued

PRESSURE TESTING APPLIANCE GAS CONNECTIONS

1. Open equipment shutoff valve (see Figure 8, page 9).
2. Open main gas valve located on or near gas meter for natural gas or open propane/LP supply tank valve.
3. Make sure control knob of appliance is in the OFF position.
4. Check all joints from equipment shutoff valve to gas control (see Figures 9 or 10, page 9). Apply noncorrosive leak detection fluid to all joints. Bubbles forming show a leak.
5. Correct all leaks at once.
6. Light appliance (see *Operating Appliance*). Check all other internal joints for leaks.
7. Turn off appliance (see *To Turn Off Gas to Appliance*, page 11)..

OPERATING APPLIANCE

**FOR YOUR SAFETY
READ BEFORE LIGHTING**

 **WARNING:** Keep flue open when operating unit.

 **WARNING:** If you do not follow these instructions exactly, a fire or explosion may result causing property damage, personal injury or loss of life.

- A. This appliance has a pilot which must be lighted by hand. When lighting the pilot, follow these instructions exactly.
- B. **BEFORE LIGHTING** smell all around the appliance area for gas. Be sure to smell next to the floor because some gas is heavier than air and will settle on the floor.

WHAT TO DO IF YOU SMELL GAS

- Do not try to light any appliance.
- Do not touch any electric switch; do not use any phone in your building.
- Immediately call your gas supplier from a neighbor's phone. Follow the gas supplier's instructions.
- If you cannot reach your gas supplier, call the fire department.

- C. Use only your hand to push in or turn the gas control knob. Never use tools. If the knob will not push in or turn by hand, don't try to repair it, call a qualified service technician or gas supplier. Force or attempted repair may result in a fire or explosion.
- D. Do not use this appliance if any part has been under water. Immediately call a qualified service technician to inspect the appliance and to replace any part of the control system and any gas control which has been under water.

LIGHTING INSTRUCTIONS

NOTICE: During initial operation of new appliance, metallic components may emit an odor as paint and assembly compounds are heated and cure. Be sure to provide adequate fresh air if odors are detected.

 **WARNING:** Damper handle will be hot if appliance has been running.

 **CAUTION:** A mild gas flash may occur within 10 seconds of normal shutdown of this appliance. Remain clear of the hearth area for the entire shutdown process to avoid possible injury.

1. STOP! Read the safety information in column 1.
2. Make sure equipment shutoff valve is fully open.
3. Set selector switch in the OFF position.
4. Press in and turn control knob clockwise  to the OFF position (see Figure 11, page 11).

 **WARNING:** Burners will come on automatically within one minute when the selector switch is in the ON position after the pilot is lit.

OPERATING APPLIANCE

Continued

5. Wait five (5) minutes to clear out any gas. Then smell for gas, including near the floor. If you smell gas, STOP! Follow "B" in the safety information, page 10. If you don't smell gas, go to the next step.

6. Press in and turn control knob counterclockwise  to the PILOT position. Press in control knob for five (5) seconds (see Figure 11).

Note: You may be running this appliance for the first time after hooking up to gas supply. If so, the control knob may need to be pressed in for 30 seconds or more. This will allow air to bleed from the gas system.

7. With control knob pressed in, press and release ignitor button. This will light pilot. If needed, keep pressing ignitor button until pilot lights.

Note: If pilot does not stay lit, contact a qualified service person or gas supplier for repairs. Until repairs are made, light pilot with match. To light pilot with match, see *Manual Lighting Procedure*.

8. Keep control knob pressed in for 30 seconds after lighting pilot. After 30 seconds, release control knob.

• If control knob does not pop out when released, contact a qualified service person or gas supplier for repairs.

Note: If pilot goes out, repeat steps 4 through 8.

9. Slightly push in and turn control knob counterclockwise  to the ON position.

10. Wait one minute and switch selector switch to the ON position to light burners. **Note:** AUTO is not functional.

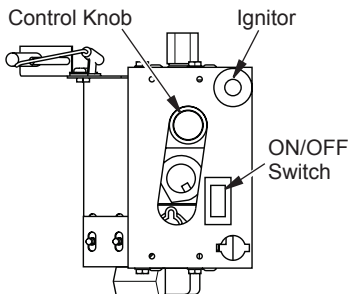

Figure 11 - Control Knob and Ignitor Button

11. Set flame adjustment knob to any level between HI and LO. Optional conversion kit only.

Note: Unit is shipped from the factory with preset flame and manual on/off switch only (see *Accessories* on page 17 for complete list of accessories and conversion kits).

CAUTION: Do not try to adjust heating levels by using the equipment shutoff valve.

WARNING: Make sure the selector switch is in the OFF position when you are away from home for long periods of time. Appliance will come on automatically with selector switch in the ON position.

TO TURN OFF GAS TO APPLIANCE

Shutting Off Appliance

1. Turn control knob clockwise  to the OFF position.
- 2a. Set selector switch in the OFF position.
- 2b. If Using Optional Hand-Held Remote: Set selector switch in the OFF position to prevent draining battery.

Shutting Off Burner Only (pilot stays lit)

You may shut off the burners and keep the pilot lit by doing one of the following:

1. Turn control knob clockwise  to the PILOT position.
2. Use remote control manual OFF button.
3. Set selector switch in the OFF position.

MANUAL LIGHTING PROCEDURE

1. Follow steps 1 through 6 under *Lighting Instructions*, page 10.
2. Depress control knob and light pilot with match.
3. Keep control knob pressed in for 30 seconds after lighting pilot. After 30 seconds, release control knob. Now follow steps 9 through 11 under *Lighting Instructions*.

INSPECTING BURNERS

BURNER FLAME PATTERN

Check flame pattern often. Figure 12 shows correct burner flame pattern.

NOTICE: Do not mistake orange flames with yellow tipping. Dirt or other fine particles are burned by appliance, causing brief patches of orange flame.

If burner flame pattern is incorrect, as shown in Figure 13

- turn appliance off (see *To Turn Off Gas to Appliance*)
- see *Troubleshooting*, page 13



Figure 12 - Correct Burner Flame Pattern

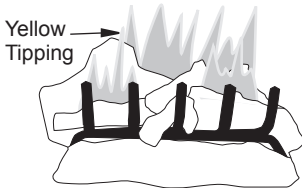

Figure 13 - Incorrect Burner Flame Pattern

CLEANING AND MAINTENANCE

WARNING: Turn off heater and let cool before cleaning.

CAUTION: You must keep control areas, burner and circulating air passageways of fireplace clean. Inspect these areas of fireplace before each use. Have fireplace and chimney inspected yearly by a qualified service person. Fireplace may need more frequent cleaning due to excessive lint from carpeting, bedding material, pet hair, etc.

SPECIFICATIONS

VTD-18NV-JHB

- Rating (Variable): 59,000 Btu/Hr
- Type Gas: Natural
- Ignition: Piezo
- Manifold Pressure: 3.5" W.C.
- Inlet Gas Pressure (in. of water):
Max - 10.5" W.C., Min* - 5.0" W.C.

VTD-24NV-JHB

- Rating (Variable): 69,000 Btu/Hr
- Type Gas: Natural
- Ignition: Piezo
- Manifold Pressure: 3.5" W.C.
- Inlet Gas Pressure (in. of water):
Max - 10.5" W.C., Min* - 5.0" W.C.

VTD-30NV-JHB

- Rating (Variable): 74,000 Btu/Hr
- Type Gas: Natural
- Ignition: Piezo
- Manifold Pressure: 3.5" W.C.
- Inlet Gas Pressure (in. of water):
Max - 10.5" W.C., Min* - 5.0" W.C.

VTD-18PV-JHB

- Rating (Variable): 59,000 Btu/Hr
- Type Gas: Propane/LP
- Ignition: Piezo
- Manifold Pressure: 10" W.C.
- Inlet Gas Pressure (in. of water):
Max - 14" W.C., Min* - 11" W.C.

VTD-24PV-JHB

- Rating (Variable): 69,000 Btu/Hr
- Type Gas: Propane/LP
- Ignition: Piezo
- Manifold Pressure: 10" W.C.
- Inlet Gas Pressure (in. of water):
Max - 14" W.C., Min* - 11" W.C.

VTD-30PV-JHB

- Rating (Variable): 74,000 Btu/Hr
- Type Gas: Propane/LP
- Ignition: Piezo
- Manifold Pressure: 10" W.C.
- Inlet Gas Pressure (in. of water):
Max - 14" W.C., Min* - 11" W.C.

*For purpose of input adjustment

TROUBLESHOOTING

⚠ WARNING: Turn off log set and let cool before servicing. Only a qualified service person should service and repair log set.

⚠ CAUTION: Never use a wire, needle, or similar object to clean ODS/pilot. This can damage ODS/pilot unit.

Note: All troubleshooting items are listed in order of operation.

OBSERVED PROBLEM	POSSIBLE CAUSE	REMEDY
When ignitor button is pressed, there is no spark at pilot	1. Ignitor electrode not connected to ignitor cable	1. Reconnect ignitor cable
	2. Ignitor cable pinched or wet	2. Free ignitor cable if pinched by any metal or tubing. Keep ignitor cable dry
	3. Piezo ignitor nut is loose	3. Tighten nut holding piezo ignitor to base panel of log set. Nut is located behind base panel
	4. Broken ignitor cable	4. Replace ignitor cable
	5. Bad piezo ignitor	5. Replace piezo ignitor
	6. Ignitor electrode positioned wrong or broken	6. Replace ignitor electrode
When ignitor button is pressed, there is spark at pilot but no ignition	1. Gas supply turned off or equipment shutoff valve closed	1. Turn on gas supply or open equipment shutoff valve
	2. Control knob not in PILOT position	2. Turn control knob to PILOT position
	3. Control knob not pressed in while in PILOT position	3. Press in control knob while in PILOT position
	4. Air in gas lines when installed	4. Continue holding down control knob. Repeat igniting operation until air is removed
	5. Depleted gas supply (propane/LP only)	5. Contact local propane/LP gas company
	6. Pilot is clogged	6. Clean pilot (see <i>Cleaning and Maintenance</i> , page 12) or replace pilot assembly
	7. Gas regulator setting is not correct	7. Replace gas regulator

TROUBLESHOOTING

OBSERVED PROBLEM	POSSIBLE CAUSE	REMEDY
Pilot lights but flame goes out when control knob is released	<ol style="list-style-type: none"> 1. Control knob not fully pressed in 2. Control knob not pressed in long enough 3. Safety interlock system has been triggered 4. Equipment shutoff valve not fully open 5. Pilot flame not touching thermocouple, which allows thermocouple to cool, causing pilot flame to go out. This problem could be caused by one or both of the following: A) Low gas pressure B) Dirty or partially clogged pilot 6. Thermocouple connection loose at control valve 7. Thermocouple damaged 8. Control valve damaged 	<ol style="list-style-type: none"> 1. Press in control knob fully 2. After pilot lights, keep control knob pressed in 30 seconds 3. Wait one minute for safety interlock system to reset. Repeat ignition operation 4. Fully open equipment shutoff valve 5. A) Contact local natural or propane/LP gas company B) Clean pilot (see <i>Cleaning and Maintenance</i>, page 13) or replace pilot assembly 6. Hand tighten until snug, then tighten 1/4 turn more 7. Replace pilot assembly 8. Replace control valve
One or both burner does not light after ODS/pilot is lit	<ol style="list-style-type: none"> 1. Inlet gas pressure is too low 2. Burner orifice clogged 3. Mislocated crossover tube 4. Remote selector in OFF position 5. Wire disconnected from gas control 	<ol style="list-style-type: none"> 1. Contact local natural or propane/LP gas company 2. Clean burner (see <i>Cleaning and Maintenance</i>, page 12) or replace burner orifice 3. Contact qualified service person 4. Put remote selector in ON position 5. See <i>Wiring Diagram</i>, page 17
Delayed ignition of burner	<ol style="list-style-type: none"> 1. Manifold pressure is too low 2. Burner orifice clogged 3. Mislocated crossover tube 	<ol style="list-style-type: none"> 1. Contact local natural or propane/LP gas company 2. Clean burner (see <i>Cleaning and Maintenance</i>, page 12) or replace burner orifice 3. Contact qualified service person
Burner backfiring during combustion	<ol style="list-style-type: none"> 1. Burner orifice is clogged or damaged 2. Damaged burner 3. Gas regulator defective 	<ol style="list-style-type: none"> 1. Clean burner (see <i>Cleaning and Maintenance</i>, page 12) or replace burner orifice 2. Replace damaged burner 3. Replace gas regulator

TROUBLESHOOTING

Continued

OBSERVED PROBLEM	POSSIBLE CAUSE	REMEDY
Orange flame in burner during burner combustion	<ol style="list-style-type: none">1. Not enough air2. Gas regulator defective	<ol style="list-style-type: none">1. Check burner for dirt and debris. If found, clean burner (see <i>Cleaning and Maintenance</i>, page 12)2. Replace gas regulator
Slight smoke or odor during initial operation	<ol style="list-style-type: none">1. Residues from manufacturing processes and logs curing	<ol style="list-style-type: none">1. Problem will stop after a few hours of operation
Appliance produces a whistling noise when burners are lit	<ol style="list-style-type: none">1. Turning control knob to HI position when burners are cold2. Air in gas line3. Air passageways on appliance blocked4. Dirty or partially clogged burner orifice(s)	<ol style="list-style-type: none">1. Turn control knob to LO position and let warm up for a minute2. Operate burners until air is removed from line. Have gas line checked by local natural or propane/LP gas company3. Observe minimum installation clearances (see page 6)4. Clean burners (see <i>Cleaning and Maintenance</i>, page 12) or replace burner orifice
White powder residue forming within burner box or on adjacent walls or furniture	<ol style="list-style-type: none">1. When heated, vapors from furniture polish, wax, carpet cleaners, etc. may turn into white powder residue	<ol style="list-style-type: none">1. Turn appliance off when using furniture polish, wax, carpet cleaners, or similar products
Remote does not function	<ol style="list-style-type: none">1. Battery is not installed. Battery power is low	<ol style="list-style-type: none">1. Replace batteries in receiver and remote control
Appliance produces a clicking/ticking noise just after burners are lit or shut off	<ol style="list-style-type: none">1. Metal expanding while heating or contracting while cooling	<ol style="list-style-type: none">1. This is common with most appliances. If noise is excessive, contact qualified service person

TROUBLESHOOTING

Continued



WARNING: If you smell gas

- Shut off gas supply.
- Do not try to light any appliance.
- Do not touch any electrical switch; do not use any phone in your building.
- Immediately call your gas supplier from a neighbor's phone. Follow the gas supplier's instructions.
- If you cannot reach your gas supplier, call the fire department.

IMPORTANT: Operating log set where impurities in air exist may create odors. Cleaning supplies, paint, paint remover, cigarette smoke, cements and glues, new carpet or textiles, etc., create fumes. These fumes may mix with combustion air and create odors. These odors will disappear over time.

OBSERVED PROBLEM	POSSIBLE CAUSE	REMEDY
Appliance produces unwanted odors	<ol style="list-style-type: none">1. Appliance burning vapors from paint, hair spray, glues, cleaners, chemicals, new carpet, etc. (See <i>IMPORTANT</i> statement above)2. Low fuel supply (propane/LP only)3. Gas leak. See Warning statement at top of page	<ol style="list-style-type: none">1. Open flue to maximum. Stop using odor causing products while appliance is running2. Refill supply tank (propane/LP only)3. Locate and correct all leaks (see <i>Checking Gas Connections</i>, page 9)
Appliance shuts off in use (ODS operates)	<ol style="list-style-type: none">1. Not enough fresh air is available2. Low line pressure3. ODS/pilot is partially clogged	<ol style="list-style-type: none">1. Open window and/or door for ventilation2. Contact local natural or propane/LP gas company3. Clean ODS/pilot (see <i>Cleaning and Maintenance</i>, page 13)
Gas odor even when control knob is in OFF position	<ol style="list-style-type: none">1. Gas leak. See Warning statement at top of page2. Control valve or gas control defective	<ol style="list-style-type: none">1. Locate and correct all leaks (see <i>Checking Gas Connections</i>, page 9)2. Replace control valve or gas control
Gas odor during combustion	<ol style="list-style-type: none">1. Foreign matter between control valve and burner2. Gas leak. See Warning statement at top of page	<ol style="list-style-type: none">1. Take apart gas tubing and remove foreign matter2. Locate and correct all leaks (see <i>Checking Gas Connections</i>, page 9)

SERVICE HINTS

When Gas Pressure is Too Low

- pilot will not stay lit
- burners will have delayed ignition
- heater will not produce specified heat
- (for propane/LP units) propane/LP gas supply may be low

You may feel your gas pressure is too low. If so, contact your local propane/LP or natural gas supplier.

TECHNICAL SERVICE

You may have further questions about installation, operation or troubleshooting. If so, contact DESA's Technical Service Department at 1-866-672-6040. When calling please have your model and serial numbers of your heater ready.

You can also visit DESA's technical services web site at www.desatech.com.

REPLACEMENT PARTS

Note: Use only original replacement parts. This will protect your warranty coverage for parts replaced under warranty.

PARTS UNDER WARRANTY

Contact authorized dealers of this product. If they can't supply original replacement part(s), call DESA's Technical Service Department at 1-866-672-6040. When calling DESA, have ready

- your name and address
- model and serial numbers of your log set
- how log set was malfunctioning
- type of gas used (propane/LP or natural gas)
- purchase date

Usually, we will ask you to return the part to the factory.

PARTS NOT UNDER WARRANTY

Contact authorized dealers of this product. If they can't supply original replacement part(s), call DESA at 1-866-672-6040 for referral information. When calling DESA, have ready

- model number of your log set
- the replacement part number

ACCESSORIES

Purchase these appliances from your local dealer. If they can not supply these accessories, call DESA at 1-866-672-6040 for referral information. You can also write to the address listed on the back page of this manual.

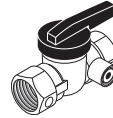

EQUIPMENT SHUTOFF VALVE GA5010

Equipment shutoff valve with 1/8" NPT tap. Fits 1/2" pipe.

LAVA ROCK - GA6060 (Not Shown)

Order when additional rock is desired (1.8 lb. bag).

DAMPER CLAMP - GA6080 (Not Shown)

Permanently opens chimney flue damper for vented operation.

ON/OFF REMOTE CONVERSION KIT OF-RC

Converts ON/OFF valve for use with hand-held ON/OFF remote

HI/LO CONVERSION KIT VTD-HLCN (NG), VTD-HLCP (LP)

Converts valve from ON/OFF to HI/LO

ON/OFF - HI/LO REMOTE CONVERSION KIT - OFSM-RCN (NG) OFSM-RCP (LP)

Converts valve from ON/OFF to HI/LO for use with hand-held ON/OFF remote (included)

WIRING DIAGRAMS

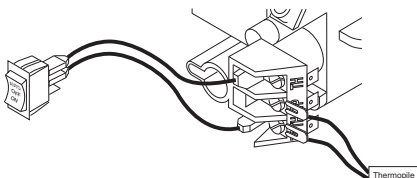

ON/OFF REMOTE MODELS ONLY

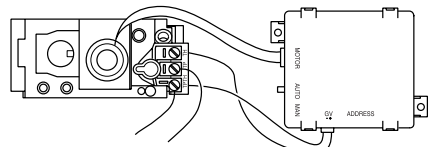

ON/OFF-HI/LO REMOTE MODELS ONLY

ILLUSTRATED PARTS BREAKDOWN

MODELS VTD-18NV-JHB, VTD-24NV-JHB, VTD-30NV-JHB

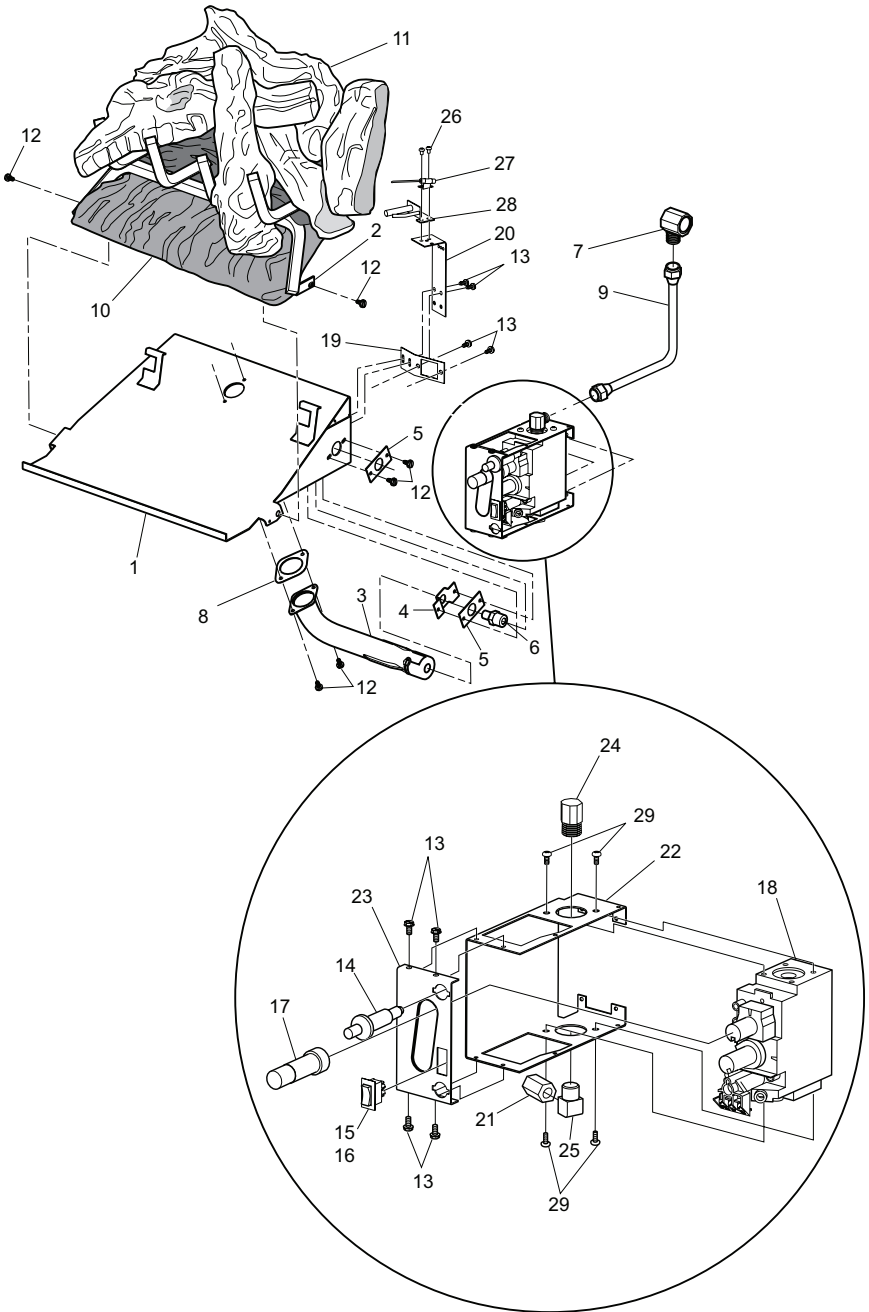

PARTS LIST

This list contains replaceable parts used in your heater. When ordering parts, follow the instructions listed under *Replacement Parts* on page 17 of this manual.

KEY NO.	PART NO.	DESCRIPTION							QTY.	
			VTD-18NV-JHB	VTD-18PV-JHB	VTD-24NV-JHB	VTD-24PV-JHB	VTD-30NV-JHB	VTD-30PV-JHB		
1	112801-01	Chassis	•	•					1	
	112801-02	Chassis			•	•			1	
	112801-03	Chassis					•	•	1	
2	112803-01	Grate	•	•					1	
	112803-02	Grate			•	•			1	
	112803-03	Grate					•	•	1	
3	112372-07	Venturi/Shutter	•	•					1	
	112372-08	Venturi/Shutter			•	•			1	
	112372-09	Venturi/Shutter					•	•	1	
4	112804-03	Bracket	•	•	•	•	•	•	1	
5	112804-04	Plate	•	•	•	•	•	•	2	
6	112371-09	Orifice, NG	•						1	
	24771	Orifice, LP		•					1	
	112371-10	Orifice, NG			•				1	
	23102	Orifice, LP				•			1	
	112371-11	Orifice, NG					•		1	
	26209	Orifice, LP					•	•	1	
7	14325	Elbow 90°, 1/2 FPT x 3/8 FLRE	•	•	•	•	•	•	1	
8	112370-01	Gasket	•	•	•	•	•	•	1	
9	901232-01	Flexible Gas Line	•	•	•	•	•	•	1	
10	112832-01	Ceramic Burner	•	•					1	
	112832-02	Ceramic Burner			•	•			1	
	112832-03	Ceramic Burner					•	•	1	
11	112833-04	Log Assembly	•	•					1	
	112833-05	Log Assembly			•	•			1	
	112833-06	Log Assembly					•	•	1	
12	111800-01	Screw, #10 Self THD							10	
13	M11084-26	Screw, 10-16 x 0.380	•	•	•	•	•	•	8	
14	097159-04	Piezo Ignitor	•	•	•	•	•	•	1	
15	099998-01	Switch	•	•	•	•	•	•	1	
16	103284-02	Wire Harness	•	•	•	•	•	•	1	
17	103784-01	ON/OFF Extension Knob	•	•	•	•	•	•	1	
18	14512	Valve, MV NG	•	•	•	•	•	•	1	
	14513	Valve, MV LP		•	•	•	•	•	1	
19	112804-05	Valve Bracket	•	•	•	•	•	•	1	
20	114395-01	Pilot Bracket	•	•			•	•	1	
	114395-02	Pilot Bracket			•				1	
21	116910-01	Brass 3/8 NPT Coupling	•	•	•	•	•	•	1	
22	117005-01	Shroud	•	•	•	•	•	•	1	
23	117005-02	Face Plate	•	•	•	•	•	•	1	
24	14264	Elbow 90°, Brass 3/8M x 3/8 FLRE	•	•	•	•	•	•	1	
25	901062-01	Brass Elbow	•	•	•	•	•	•	1	
26	901075-01	Screw, PH #8 x 0.25	•	•	•	•	•	•	2	
27	901072-01	Ignitor Electrode	•	•	•	•	•	•	1	
28	901073-01	Pilot	•	•	•	•	•	•	1	
29	111816-01	Screw, 10-32 x 0.38	•	•	•	•	•	•	4	
PARTS AVAILABLE - NOT SHOWN										
	112363-01	Log Scrap Kit #1	•	•	•	•	•	•	•	1
	112364-01	Log Scrap Kit #2	•	•	•	•	•	•	•	1
	114371-01	Warning Plate	•	•	•	•	•	•	•	1
	114366-10	Rating Plate	•							1
	114366-13	Rating Plate		•						1
	114366-11	Rating Plate			•					1
	114366-14	Rating Plate				•				1
	114366-12	Rating Plate					•			1
	114366-15	Rating Plate						•		1
	112799-01	Ember Flakes Kit	•	•	•	•	•	•	•	1
	26839	Rock Wool	•	•	•	•	•	•	•	1

WARRANTY INFORMATION

KEEP THIS WARRANTY

Hearth Kit Model _____
Log Set Model _____
Serial No. _____
Date Purchased _____

Always specify model and serial numbers when communicating with the factory.

We reserve the right to amend these specifications at any time without notice. The only warranty applicable is our standard written warranty. We make no other warranty, expressed or implied.

LIMITED WARRANTY VENTED GAS LOGS

DESA warrants this product to be free from defects in materials and components four (4) years for the burner system and a lifetime for logs from the date of first purchase, provided that the product has been properly installed, operated and maintained in accordance with all applicable instructions. To make a claim under this warranty the Bill of Sale or cancelled check must be presented.

This warranty is extended only to the original retail purchaser. This warranty covers the cost of part(s) required to restore this heater to proper operating condition and an allowance for labor when provided by a DESA Authorized Service Center. Warranty part(s) MUST be obtained through authorized dealers of this product and/or DESA who will provide original factory replacement parts. Failure to use original factory replacement parts voids this warranty. The heater MUST be installed by a qualified installer in accordance with all local codes and instructions furnished with the unit.

This warranty does not apply to parts that are not in original condition because of normal wear and tear or parts that fail or become damaged as a result of misuse, accidents, lack of proper maintenance or defects caused by improper installation. Travel, diagnostic cost, labor, transportation and any and all such other costs related to repairing a defective heater will be the responsibility of the owner.

TO THE FULL EXTENT ALLOWED BY THE LAW OF THE JURISDICTION THAT GOVERNS THE SALE OF THE PRODUCT; THIS EXPRESS WARRANTY EXCLUDES ANY AND ALL OTHER EXPRESSED WARRANTIES AND LIMITS THE DURATION OF ANY AND ALL IMPLIED WARRANTIES, INCLUDING WARRANTIES OF MERCHANTABILITY AND FITNESS FOR A PARTICULAR PURPOSE TO FOUR (4) YEARS ON BURNER SYSTEM AND A LIFETIME ON LOGS FROM THE DATE OF FIRST PURCHASE; AND DESA'S LIABILITY IS HEREBY LIMITED TO THE PURCHASE PRICE OF THE PRODUCT AND DESA SHALL NOT BE LIABLE FOR ANY OTHER DAMAGES WHATSOEVER INCLUDING INDIRECT, INCIDENTAL OR CONSEQUENTIAL DAMAGES.

Some states do not allow a limitation on how long an implied warranty lasts or an exclusion or limitation of incidental or consequential damages, so the above limitation on implied warranties or exclusion or limitation on damages may not apply to you.

This warranty gives you specific legal rights and you may also have other rights that vary from state to state.

For information about this warranty write:

DESA[™]

2701 Industrial Drive
P.O. Box 90004
Bowling Green, KY 42102-9004
www.desatech.com



114370 02
NOT A UPC

114370-02
Rev. C
01/06

Free Manuals Download Website

<http://myh66.com>

<http://usermanuals.us>

<http://www.somanuals.com>

<http://www.4manuals.cc>

<http://www.manual-lib.com>

<http://www.404manual.com>

<http://www.luxmanual.com>

<http://aubethermostatmanual.com>

Golf course search by state

<http://golfingnear.com>

Email search by domain

<http://emailbydomain.com>

Auto manuals search

<http://auto.somanuals.com>

TV manuals search

<http://tv.somanuals.com>