

DENON

AV SURROUND RECEIVER

AVR-686

OPERATING INSTRUCTIONS

MODE D'EMPLOI

SAFETY PRECAUTIONS



CAUTION
RISK OF ELECTRIC SHOCK
DO NOT OPEN



CAUTION:

TO REDUCE THE RISK OF ELECTRIC SHOCK, DO NOT REMOVE COVER (OR BACK). NO USER-SERVICEABLE PARTS INSIDE. REFER SERVICING TO QUALIFIED SERVICE PERSONNEL.



The lightning flash with arrowhead symbol, within an equilateral triangle, is intended to alert the user to the presence of uninsulated "dangerous voltage" within the product's enclosure that may be of sufficient magnitude to constitute a risk of electric shock to persons.



The exclamation point within an equilateral triangle is intended to alert the user to the presence of important operating and maintenance (servicing) instructions in the literature accompanying the appliance.

WARNING:

TO REDUCE THE RISK OF FIRE OR ELECTRIC SHOCK, DO NOT EXPOSE THIS APPLIANCE TO RAIN OR MOISTURE.

FCC INFORMATION (For US customers)

1. PRODUCT

This product complies with Part 15 of the FCC Rules. Operation is subject to the following two conditions: (1) this product may not cause harmful interference, and (2) this product must accept any interference received, including interference that may cause undesired operation.

2. IMPORTANT NOTICE: DO NOT MODIFY THIS PRODUCT

This product, when installed as indicated in the instructions contained in this manual, meets FCC requirements. Modification not expressly approved by DENON may void your authority, granted by the FCC, to use the product.

3. NOTE

This product has been tested and found to comply with the limits for a Class B digital device, pursuant to Part 15 of the FCC Rules. These limits are designed to provide reasonable protection against harmful interference in a residential installation.

This product generates, uses and can radiate radio frequency energy and, if not installed and used in accordance with the instructions, may cause harmful interference to radio communications. However, there is no guarantee that interference will not occur in a particular installation. If this product does cause harmful interference to radio or television reception, which can be determined by turning the product OFF and ON, the user is encouraged to try to correct the interference by one or more of the following measures:

- Reorient or relocate the receiving antenna.
- Increase the separation between the equipment and receiver.
- Connect the product into an outlet on a circuit different from that to which the receiver is connected.
- Consult the local retailer authorized to distribute this type of product or an experienced radio/TV technician for help.

SAFETY INSTRUCTIONS

1. Read Instructions – All the safety and operating instructions should be read before the product is operated.
2. Retain Instructions – The safety and operating instructions should be retained for future reference.
3. Heed Warnings – All warnings on the product and in the operating instructions should be adhered to.
4. Follow Instructions – All operating and use instructions should be followed.
5. Cleaning – Unplug this product from the wall outlet before cleaning. Do not use liquid cleaners or aerosol cleaners.
6. Attachments – Do not use attachments not recommended by the product manufacturer as they may cause hazards.
7. Water and Moisture – Do not use this product near water – for example, near a bath tub, wash bowl, kitchen sink, or laundry tub; in a wet basement; or near a swimming pool; and the like.
8. Accessories – Do not place this product on an unstable cart, stand, tripod, bracket, or table. The product may fall, causing serious injury to a child or adult, and serious damage to the product. Use only with a cart, stand, tripod, bracket, or table recommended by the manufacturer, or sold with the product. Any mounting of the product should follow the manufacturer's instructions, and should use a mounting accessory recommended by the manufacturer.
9. A product and cart combination should be moved with care. Quick stops, excessive force, and uneven surfaces may cause the product and cart combination to overturn.
10. Ventilation – Slots and openings in the cabinet are provided for ventilation and to ensure reliable operation of the product and to protect it from overheating, and these openings must not be blocked or covered. The openings should never be blocked by placing the product on a bed, sofa, rug, or other similar surface. This product should not be placed in a built-in installation such as a bookcase or rack unless proper ventilation is provided or the manufacturer's instructions have been adhered to.
11. Power Sources – This product should be operated only from the type of power source indicated on the marking label. If you are not sure of the type of power supply to your home, consult your product dealer or local power company. For products intended to operate from battery power, or other sources, refer to the operating instructions.
12. Grounding or Polarization – This product may be equipped with a polarized alternating-current line plug (a plug having one blade wider than the other). This plug will fit into the power outlet only one way. This is a safety feature. If you are unable to insert the plug fully into the outlet, try reversing the plug. If the plug should still fail to fit, contact your electrician to replace your obsolete outlet. Do not defeat the safety purpose of the polarized plug.
13. Power-Cord Protection – Power-supply cords should be routed so that they are not likely to be walked on or pinched by items placed upon or against them, paying particular attention to cords at plugs, convenience receptacles, and the point where they exit from the product.
15. Outdoor Antenna Grounding – If an outside antenna or cable system is connected to the product, be sure the antenna or cable system is grounded so as to provide some protection against voltage surges and built-up static charges. Article 810 of the National Electrical Code, ANSI/NFPA 70, provides information with regard to proper grounding of the mast and supporting structure, grounding of the lead-in wire to an antenna discharge unit, size of grounding conductors, location of antenna-discharge unit, connection to grounding electrodes, and requirements for the grounding electrode. See Figure A.
16. Lightning – For added protection for this product during a lightning storm, or when it is left unattended and unused for long periods of time, unplug it from the wall outlet and disconnect the antenna or cable system. This will prevent damage to the product due to lightning and power-line surges.
17. Power Lines – An outside antenna system should not be located in the vicinity of overhead power lines or other electric light or power circuits, or where it can fall into such power lines or circuits. When installing an outside antenna system, extreme care should be taken to keep from touching such power lines or circuits as contact with them might be fatal.
18. Overloading – Do not overload wall outlets, extension cords, or integral convenience receptacles as this can result in a risk of fire or electric shock.
19. Object and Liquid Entry – Never push objects of any kind into this product through openings as they may touch dangerous voltage points or short-out parts that could result in a fire or electric shock. Never spill liquid of any kind on the product.
20. Servicing – Do not attempt to service this product yourself as opening or removing covers may expose you to dangerous voltage or other hazards. Refer all servicing to qualified service personnel.
21. Damage Requiring Service – Unplug this product from the wall outlet and refer servicing to qualified service personnel under the following conditions:
 - a) When the power-supply cord or plug is damaged,
 - b) If liquid has been spilled, or objects have fallen into the product,
 - c) If the product has been exposed to rain or water,
 - d) If the product does not operate normally by following the operating instructions. Adjust only those controls that are covered by the operating instructions as an improper adjustment of other controls may result in damage and will often require extensive work by a qualified technician to restore the product to its normal operation,
 - e) If the product has been dropped or damaged in any way, and
 - f) When the product exhibits a distinct change in performance – this indicates a need for service.
22. Replacement Parts – When replacement parts are required, be sure the service technician has used replacement parts specified by the manufacturer or have the same characteristics as the original part. Unauthorized substitutions may result in fire, electric shock, or other hazards.
23. Safety Check – Upon completion of any service or repairs to this product, ask the service technician to perform safety checks to determine that the product is in proper operating condition.
24. Wall or Ceiling Mounting – The product should be mounted to a wall or ceiling only as recommended by the manufacturer.
25. Heat – The product should be situated away from heat sources such as radiators, heat registers, stoves, or other products (including amplifiers) that produce heat.

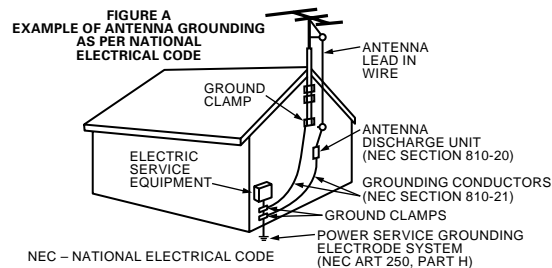

■ System setup / Configuration système

Speaker Configuration  page 38, 39

*Front	Large	1
*Center	Small	2
*Surr.	Small	3
*S.Back	Small	4
*S.Back	2sp>	5
*Subwoofer	Yes	6

Delay Time  page 39, 40

*Front L	12ft	7
*Front R	12ft	8
*Center	12ft	9
*Surr.L	10ft	10
*Surr.R	10ft	11
*S.Back L	10ft	12
*S.Back R	10ft	13
*SW	12ft	14

Subwoofer Mode Crossover Frequency  page 40

*SW Mode	Norm	15
*Cr.Over	80Hz	16

Test Tone  page 41

*TEST TONE	Yes<	17
------------	------	----

Digital In Assignment  page 42

*COAX1	CD	18
*COAX2	AUX	19
*OPT1	DVD	20
*OPT2	TU	21

Video Input Mode  page 42

*DVD	Auto	22
*TV	Auto	23
*UCR	Auto	24

Audio Delay  page 43

*A.Delay	0ms	25
----------	-----	----

Auto Surround Mode  page 43

*Auto Surr.	ON	26
-------------	----	----

Ext. In Subwoofer Level  page 43

*Ext.In SW	+15dB	27
------------	-------	----

Power Amp Assignment  page 43

*P.AMP	S.Back	28
--------	--------	----

Getting Started

Thank you for choosing the DENON AVR-686 A/V Surround Receiver. This remarkable component has been engineered to provide superb surround sound listening with home theater sources, such as DVD, as well as providing outstanding high fidelity reproduction of your favorite music sources.

As this product is provided we recommend with an immense array of features, before you begin hookup and operation that you review the contents of this manual before proceeding.

Contents

Getting Started

Accessories	2
Before using	2
Cautions on installation	2
Cautions on handling	2
Preparing the remote control unit	2
Inserting the batteries	3
Operating range of the remote control unit	3
Part names and functions	
Front panel	3
Remote control unit	4

Easy Setup and Operation

Easy setup flow	4
Speaker system layout	5
Speaker connections	5, 6
Connecting a DVD player and monitor TV	7
Auto Setup	
Connecting a microphone	8
Turning on the power	8
Starting Auto Setup	9
About error messages	10
Playing a DVD with surround sound	10

Connecting Other Sources

Cable indications	11
The video conversion function	11
Connecting a TV/DBS tuner	12
Connecting a video camera or video game	12
Connecting the external inputs (EXT. IN) terminals	12
Connecting a CD player	12
Connecting a VCR	13
Connecting a tape deck, CD recorder or MD recorder	13
Connecting the antenna terminals	13, 14
Connecting the MULTI ZONE terminals	
ZONE2 speaker out connections	14
Connecting the power supply cord	15

Basic Operation

Playback

Playing the input source	16
Playback using the external input (EXT. IN) terminals	16
Turning the sound off temporarily (MUTING)	16
Listening over headphones	17
Combining the currently playing sound with the desired image (VIDEO SELECT)	17
Selecting the front speakers	17
Checking the currently playing program source	17
Input mode	17, 18

Surround

Playing audio sources (CDs and DVDs)	18
2-channel playback modes	18
Dolby Pro Logic IIx (Pro Logic II) mode	19, 20
DTS NEO:6 mode	21, 22
Dolby Digital mode and DTS surround	22, 23
Night mode	24
Adjusting the audio delay	24

DENON original surround modes

Surround modes and their features	25
DSP surround simulation	26, 27
Tone control setting	
• Adjusting the sound quality	28
• Tone defeat mode	28
Channel Level	28

Listening to the radio

Auto preset memory	29
Auto tuning	29
Manual tuning	30
Preset stations	30
Recalling preset stations	30

Advanced Operation

Remote control unit

Operating DENON audio components	31
Preset memory	32
Operating a component stored in the preset memory	32~34
Punch through	34

Multi zone music entertainment system

Remote control unit operations during multi-source playback	36
---	----

Other functions

Recording the program source (recording the source currently being monitored)	37
Last function memory	37
Initialization of the microprocessor	37

Advanced Setup

Front display

.....	38
-------	----

System Setup

Setting the Speaker Configuration	38, 39
Setting the Delay Time	39, 40
Setting the Subwoofer Mode and Crossover Frequency	40
Setting the Test Tone	41
Setting the Digital In Assignment	42
Setting the Video Input Mode	42
Setting the Audio Delay	43
Setting the Auto Surround Mode	43
Setting the Ext. In Subwoofer Level	43
Setting the Power Amp Assignment	43

System setup items and default values

.....	44
-------	----

Troubleshooting

.....	45
-------	----

Additional information

.....	46~51
-------	-------

Specifications

.....	52
-------	----

List of preset codes

.....	End of this manual
-------	--------------------

Getting Started

Accessories

Check that the following parts are included in addition to the main unit:

- | | |
|---------------------------------------|------------------------------------|
| ① Operating instructions1 | ⑤ R6P/AA batteries2 |
| ② Warranty1 | ⑥ AM loop antenna1 |
| ③ Service station list1 | ⑦ FM indoor antenna1 |
| ④ Remote control unit (RC-1001).....1 | ⑧ Omnidirectional microphone.....1 |



Before using

Pay attention to the following before using this unit:

• Moving the unit

To prevent short-circuits or damaged wires in the connection cables, always unplug the power supply cord and disconnect the connection cables between all other audio components when moving the unit.

• Before turning the power switch on

Check once again that all connections are correct and that there are not problems with the connection cables. Always set the power switch to the standby position before connecting and disconnecting connection cables.

• Store these instructions in a safe place.

After reading, store this instructions along with the warranty card in a safe place.

• Note that the illustrations in these instructions may differ from the actual unit for explanation purposes.

• V. AUX terminals

The AVR-686's front panel is equipped with V. AUX terminals. Remove the cap covering the terminals when you want to use them.

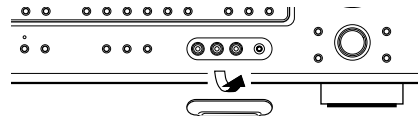

Getting Started

Cautions on installation

Noise or disturbance of the picture may be generated if this unit or any other electronic equipment using microprocessors is used near a tuner or TV. If this happens, take the following steps:

- Install this unit as far away as possible from the tuner or TV.
- Run the antenna wires from the tuner or TV away from this unit's power supply cord and input/output connection cables.
- Noise or disturbance tends to occur particularly when using indoor antennas or 300 Ω/ohm feeder wires. **We recommend using outdoor antennas and 75 Ω/ohm coaxial cables.**

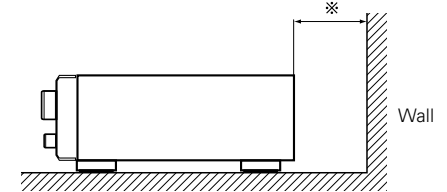
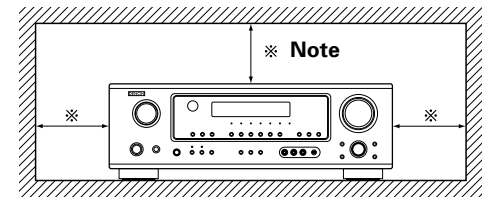

Note:

For heat dispersal, do not install this unit in a confined space such as a bookcase or similar enclosure.

Cautions on handling

• Switching the input source when input terminals are not connected.

A clicking noise may be produced if the input source is switched when nothing is connected to the input terminals. If this happens, either turn down the MASTER VOLUME control knob or connect components to the input terminals.

• Muting of PRE OUT terminals, PHONES jack and SPEAKER terminals.

The PRE OUT terminals, PHONES jack and SPEAKER terminals include a muting circuit. Because of this, the output signals are greatly attenuated for several seconds after the power switch is turned on or the input source, surround mode or any other set-up is changed. If the volume is turned up during this time, the output will be very high after the muting circuit stops functioning. Always wait until the muting circuit turns off before adjusting the volume.

• Whenever the power switch is in the STANDBY state, the unit is still connected to AC line voltage.

Please be sure to turn off the power switch or unplug the cord when you leave home for, say, a vacation.

Preparing the remote control unit

The included remote control unit (RC-1001) can be used to operate not only the AVR-686 but other remote control compatible DENON components as well. In addition, the memory contains control signals for other remote control units, so it can be used to operate non-DENON remote control compatible products.

Getting Started

Inserting the batteries

- 1 Remove the remote control unit's rear cover.

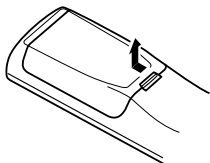

- 2 Set two R6P/AA batteries in the battery compartment in the indicated direction.

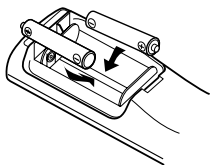

- 3 Put the rear cover back on.

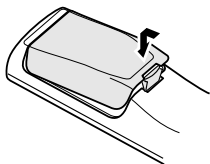

Notes on batteries:

- Replace the batteries with new ones if the set does not operate even when the remote control unit is operated nearby the unit. (The included batteries are only for verifying operation.)
- When inserting the batteries, be sure to do so in the proper direction, following the “+” and “-” marks in the battery compartment.
- To prevent damage or leakage of battery fluid:
 - Do not use a new battery together with an old one.
 - Do not use two different types of batteries.
 - Do not short-circuit, disassemble, heat or dispose of batteries in flames.
- If the battery fluid should leak, carefully wipe the fluid off the inside of the battery compartment and insert new batteries.
- When replacing the batteries, have the new batteries ready and insert them as quickly as possible.

Operating range of the remote control unit

- Point the remote control unit at the remote sensor on the main unit as shown in the diagram.
- The remote control unit can be used from a straight distance of approximately 23 feet from the main unit, but this distance will be shorter if there are obstacles in the way or if the remote control unit is not pointed directly at the remote sensor.
- The remote control unit can be operated at a horizontal angle of up to 30 degrees with respect to the remote sensor.

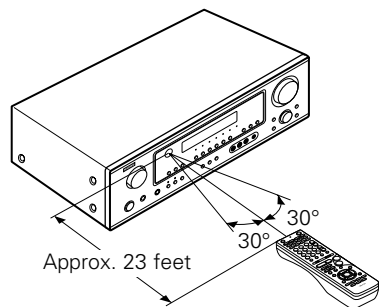

NOTE:

- It may be difficult to operate the remote control unit if the remote sensor is exposed to direct sunlight or strong artificial light.
- Do not press buttons on the main unit and remote control unit simultaneously. Doing so may result in malfunction.
- Neon signs or other devices emitting pulse-type noise nearby may result in malfunction, so keep the set as far away from such devices as possible.

Getting Started

Part names and functions

Front panel

For details on the functions of these parts, refer to the pages given in parentheses ().

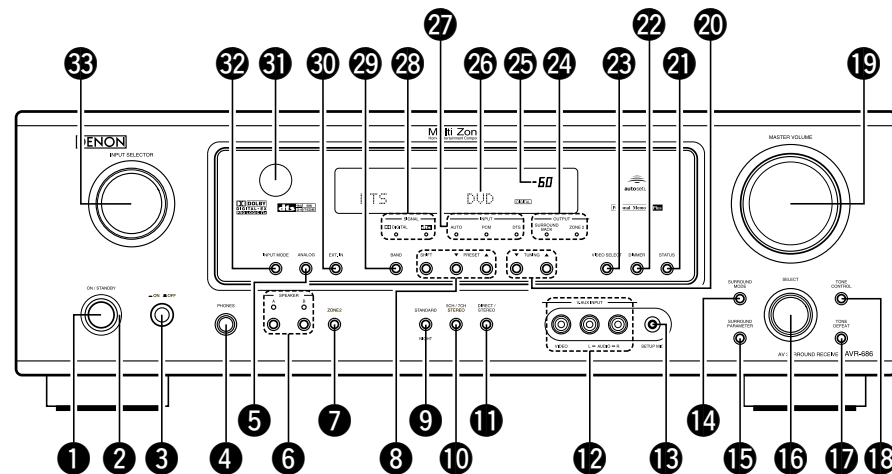

- | | |
|---|---|
| 1 Power ON/STANDBY switch(8) | 18 TONE CONTROL button(28) |
| 2 Power indicator(8) | 19 MASTER VOLUME control knob(16) |
| 3 Power switch(8, 37) | 20 TUNING Δ (up)/∇ (down) buttons(29) |
| 4 Headphones jack (PHONES)(17) | 21 STATUS button(17, 23) |
| 5 ANALOG button(18) | 22 DIMMER button(17) |
| 6 SPEAKER A/B buttons(17, 37) | 23 VIDEO SELECT button(17) |
| 7 ZONE2 button(35) | 24 OUTPUT indicator(22) |
| 8 Preset station select buttons(29, 30) | 25 Master volume indicator(16) |
| 9 STANDARD/NIGHT button(19~24) | 26 Display |
| 10 5CH/7CH STEREO button(25) | 27 INPUT mode indicator(18) |
| 11 DIRECT/STEREO button(18) | 28 SIGNAL indicator(18) |
| 12 V. AUX INPUT terminals(12) | 29 BAND button(29) |
| 13 SETUP MIC jack(8) | 30 EXT. IN button(16) |
| 14 SURROUND MODE button(16) | 31 Remote control sensor(3) |
| 15 SURROUND PARAMETER button(19) | 32 INPUT MODE button(17) |
| 16 SELECT knob(16, 19, 28) | 33 INPUT SELECTOR knob(16) |
| 17 TONE DEFEAT button(28) | |

Speaker system layout

Basic system layout

The following is an example of the basic layout for a system consisting of eight speaker systems and a television monitor:

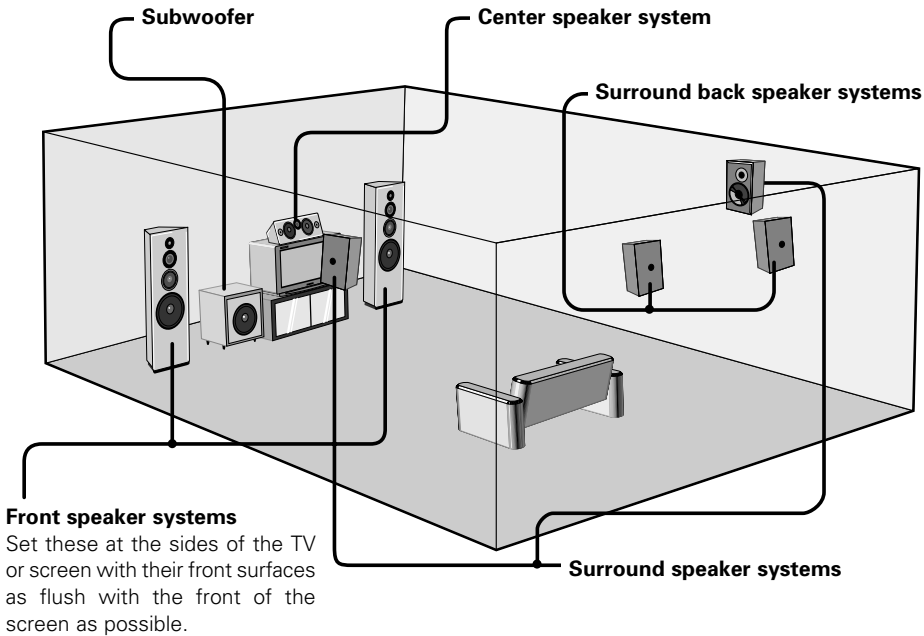

Speaker connections

- Connect the speaker terminals with the speakers making sure that like polarities are matched (\oplus with \oplus , \ominus with \ominus). Mismatching of polarities will result in weak central sound, unclear orientation of the various instruments, and the stereo image being impaired.
- When making connections, take care that none of the individual conductors of the speaker cable come in contact with adjacent terminals, with other speaker cable conductors, or with the rear panel.

NOTE:

NEVER touch the speaker terminals when the power is on. Doing so could result in electric shocks.

Speaker impedance

- When speaker systems A and B are used separately, speakers with an impedance of 6 to 16 Ω /ohms can be connected for use as front speakers.
- Be careful when using two pairs of front speakers (A + B) at the same time, since speakers with an impedance of 12 to 16 Ω /ohms in this case must be used.
- Speakers with an impedance of 6 to 16 Ω /ohms can be connected for use as center and surround and surround back speakers.
- The protector circuit may be activated if the unit is operated for long periods of time at high volumes when speakers with an impedance lower than the specified impedance are connected.

Note on speaker impedance

The protector circuit may be activated if the unit is operated for long periods of time at high volumes when speakers with an impedance lower than the specified impedance (for example speakers with an impedance of less than 4 Ω /ohms) are connected. If the protector circuit is activated, the speaker output is cut off. Turn off the unit's power, wait for the unit to cool down, improve the ventilation around the unit, then turn the power back on.

Connecting the speaker cables

1. Loosen by turning counterclockwise.
2. Insert the cable.
3. Tighten by turning clockwise.

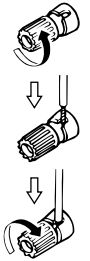

Connecting banana plugs

Banana plug
Turn clockwise to tighten, then insert the banana plug.

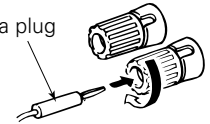

Protector circuit

This unit is equipped with a high-speed protection circuit. The purpose of this circuit is to protect the speakers under circumstances such as when the output of the power amplifier is inadvertently short-circuited and a large current flows, when the temperature surrounding the unit becomes unusually high, or when the unit is used at high output over a long period which results in an extreme temperature rise.

When the protection circuit is activated, the speaker output is cut off and the power supply indicator flashes. Should this occur, please follow these steps: be sure to switch off the power of this unit, check whether there are any faults with the wiring of the speaker cables or input cables, and wait for the unit to cool down if it is very hot. Improve the ventilation condition around the unit and switch the power back on.

If the protection circuit is activated again even though there are no problems with the wiring or the ventilation around the unit, switch off the power and contact a DENON service center.

Easy Setup and Operation

Easy Setup and Operation

■ Connections

When making connections, also refer to the operating instructions of the other components.

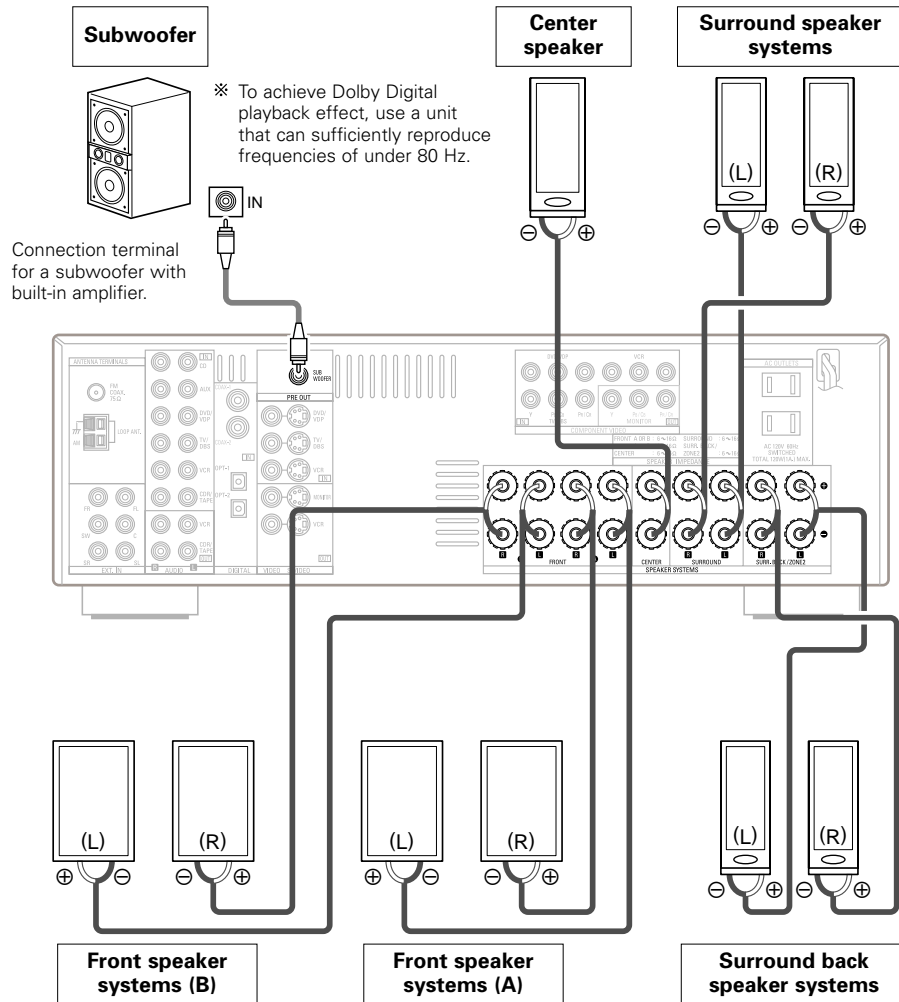

Precautions when connecting speakers:

If a speaker is placed near a TV or video monitor, the colors on the screen may be disturbed by the speaker's magnetism. If this should happen, move the speaker away to a position where it does not cause this effect.

NOTE:

- When using only one surround back speaker, connect it to the left channel.

Easy Setup and Operation

Connecting a DVD player and monitor TV

- To connect the video output from the DVD player to the AVR-686, you only need to choose one connection type. Component video connection offers the best quality (and is required for progressive DVD playback), followed by S-Video, while composite video offers the lowest picture quality of the three connection types. For more information about the video up conversion function (page 11).
- To connect the digital audio output from the DVD player, you can choose from either the coaxial or optical connections. If you choose to use the coaxial connection, it needs to be assigned. For more information about Digital Input Assignment (page 42).
- Connect a non-DVD video disc player (such as a laser disc, VCD/SVCD, or future high definition disc player) to the DVD/VDP terminals in the same way.

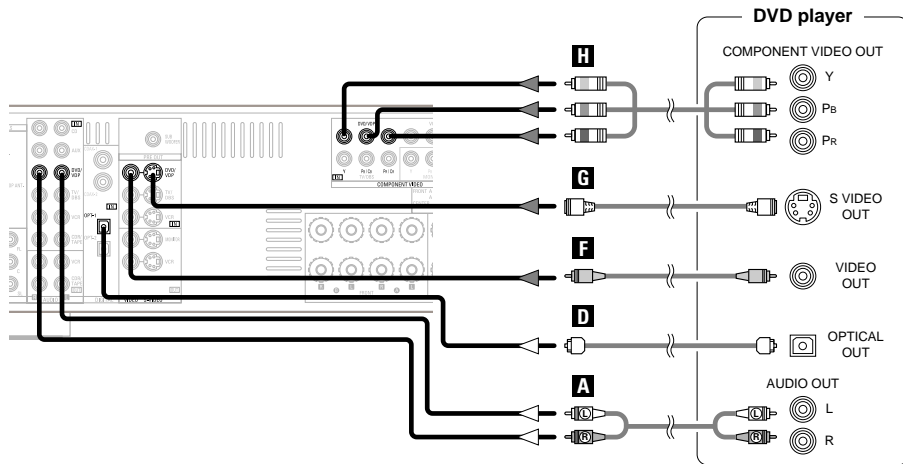

* Audio signal flow is shown with white arrows; video signal flow is shown with gray arrows.

Easy Setup and Operation

- For best picture quality (especially with progressive DVD and other high definition sources), choose the component video connection to your monitor TV. S-Video and composite video outputs are also provided if your TV does not have component video inputs.

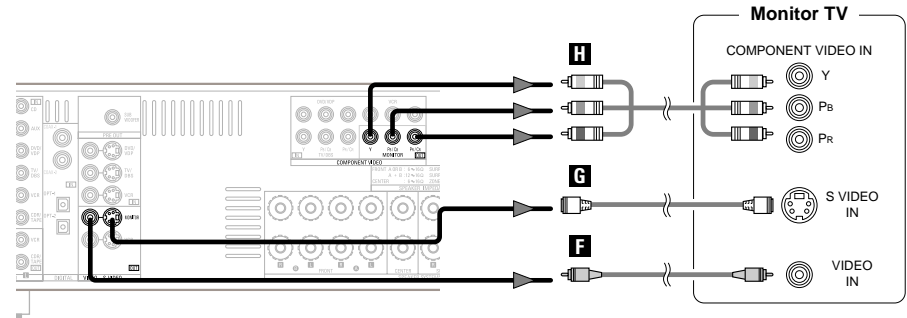

NOTE:

- The component video input and/or output terminals may be labeled differently on some TVs, monitors or video components (Y, Pb, Pr; Y, Cb, Cr; Y, B-Y, R-Y). Check the owner's manuals for the other components for further information.

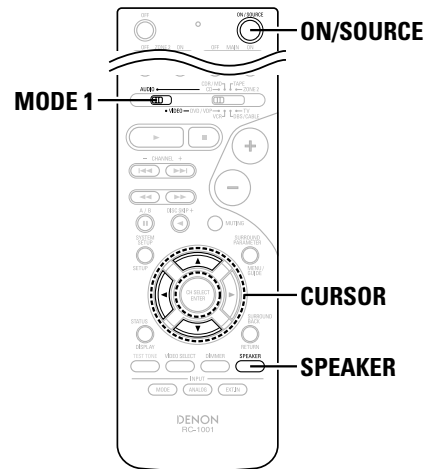
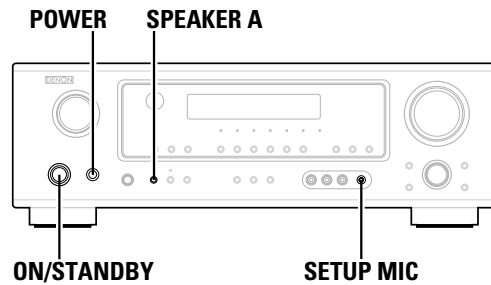

Auto Setup

The Auto Setup function of this unit performs an analysis of the speaker system to permit an appropriate automatic setting.

Measurement and setting details

- ①: This sets the speaker connection, polarity, and bass reproduction ability.
- ②: This sets the delay time from each speaker corresponding to the listening position.
- ③: This sets the volume that is output from each speaker.



For accurate measurements

- Keep quiet during the auto setup procedure. It is recommended that you turn off the power of any air-conditioner, projector or other equipment that may produce noise.
- Do not stand between the microphone and speakers while Auto Setup is performed.
- Do not place any obstacles between the microphone and speakers. Also, be sure to point the speakers towards the listening position.

NOTE:

- A loud test tone is output during the measurement. Please consider this should you be planning night time measurements, and consider not allowing small children into the listening room at this time.
- The Auto Setup is not displayed when "MUTING", "HEADPHONE ONLY" is selected.

Connecting a microphone

- 1** Connect the microphone for Auto Setup to the **SETUP MIC** jack on the front panel of the unit.

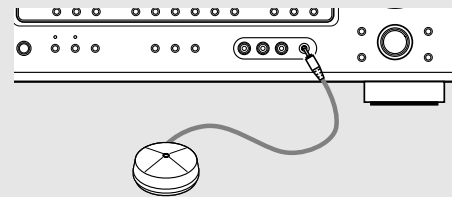

- 2** Place the microphone for Auto Setup at the actual listening position which will be at the same height as your ears.

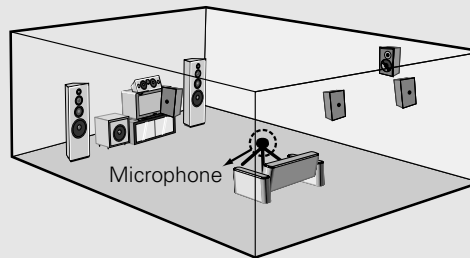

※ Place the microphone on a tripod or level surface.

Turning on the power

- 1** Turn on your subwoofer.
- 2** Turn on your monitor (TV).
- 3** Press the **POWER** switch.

 - **ON:**
The power turns on and the indicator lights.
Set the **POWER** switch to this position to turn the power on and off from the included remote control unit.
 - **OFF:**
The power turns off and the indicator is off.
In this position, the power cannot be turned on and off from the remote control unit.

- 4** Press the **ON/STANDBY** switch on the main unit or **ON/SOURCE** button on the remote control unit.
 - Turn on the power.

- 5** Press the **SPEAKER A** button to turn the speakers on.
- 6** Set the **MODE 1** switch to "AUDIO" (only when operating with the remote control unit).

Easy Setup and Operation

Starting Auto Setup

1 Press the CURSOR ◀ button to start the Auto Setup.

- Start the measurements.

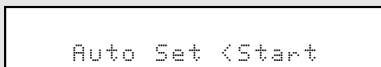

※ Measurement of each channel is performed as follows:

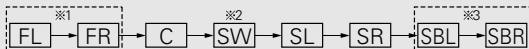

- ※ 1: Only the front speakers (A) are measured, front speakers (B) are not available. Even if the front speakers (B) are set, the setting automatically switches to the front speakers (A) once measurements are completed.
- ※ 2: The subwoofer speaker is measured twice.

- ※ 3: When "ZONE2" is selected, this is not displayed (☞ page 43). After each channel is measured, "Calculating" appears. The display switches to the speaker check display automatically.

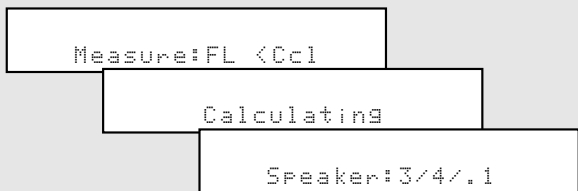

Check the results of the speaker detection

Example: 7.1-channel systems

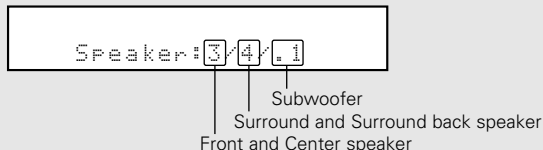

2 Press the CURSOR ▲ or ▼ button to select "Store", then press the CURSOR ◀ button.

Store:
Store the checked measurement values.
All parameters are stored.

Cancel:
Cancel the checked measurement values.

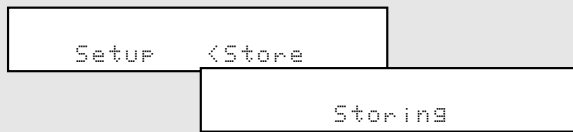

3 Disconnect the setup mic to finish Auto Setup.



- Measurement is cancelled if the **MASTER VOLUME** control knob is operated while the Auto Setup is performed.
- **If the output volume and crossover frequency of your subwoofer speaker can be changed, then set the volume to halfway and the crossover filter to maximum or switch off the low-pass filter.**
- **The speaker configuration, delay time and channel level measurement values can be checked using the system setup function (☞ page 38 ~ 41).**

Easy Setup and Operation

About automatic retry

To confirm the results of the measurements, remeasurement is automatically performed.

Remeasurement is performed up to 2 times. During this time, "Retry1" or "Retry2" is displayed on the display.

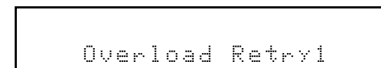

NOTE:

- When measurements have been made using the measurement microphone, speakers with built-in filters, such as a subwoofer, might be set to a value that differs from the physical distance because of the internal electrical delay.

Easy Setup and Operation

Easy Setup and Operation

About error messages

- These error displays may be displayed when performing Auto Setup measurement and the automatic measurements can not be completed because of the speaker arrangement, measurement environment, or other factors. Please check the following matters, reset the pertinent items, and measure again.
- When there is too much noise in the room, the speakers may not be detected properly. Should this happen, perform the measurements when the noise level is low, or switch off the power of the equipment that is producing the noise for the duration of the measurements.

Press the **CURSOR** Δ or ∇ button to select the items, then press the **CURSOR** \triangleleft button.

Display example	Cause	Measures
<div style="border: 1px solid black; padding: 5px; text-align: center;">Caution:SP None</div> <div style="border: 1px solid black; padding: 5px; text-align: center;">FL</div>	① The speakers required for producing suitable reproduction have not been detected. <ul style="list-style-type: none"> • The front L or front R speaker was not properly detected. • Only one channel of the surround speakers was detected. • Sound was output from the R channel when only one surround back speaker was connected. • The surround back speaker was detected, but the surround speaker was not detected. 	<ul style="list-style-type: none"> • Check that the pertinent speakers are properly connected.
<div style="border: 1px solid black; padding: 5px; text-align: center;">Caution :Phase</div> <div style="border: 1px solid black; padding: 5px; text-align: center;">FL/R</div>	② The speaker polarity is connected in reverse.	<ul style="list-style-type: none"> • Check the polarity of the pertinent speakers. For some speakers, this display may be displayed even though the speakers are properly connected. If so, select "Skip\blacktriangleleft".
<div style="border: 1px solid black; padding: 5px; text-align: center;">Caution</div> <div style="border: 1px solid black; padding: 5px; text-align: center;">Overload <Exit</div>	③ When accurate measurements cannot be made due to the input level of the microphone being too high.	<ul style="list-style-type: none"> • Set up the speakers so that their position is farther away from the listening position. • Lower the volume of the subwoofer speaker.

Playing a DVD with surround sound

1 Disconnect the microphone from the unit.

2 Select the input source to be played.

3 Select the play (surround) mode.

4 Start DVD playback.

5 Adjust the volume.

Connecting Other Sources

Cable indications

The hookup diagrams on the subsequent pages assume the use of the following optional connection cables (not supplied).

Audio cable	Video cable
<p>A Analog terminal (Stereo)</p> <p>(White) (Red) </p> <p style="text-align: center;">Pin-plug cable</p>	<p>F Video terminal</p> <p>(Yellow) </p> <p style="text-align: center;">Video cable (75 Ω/ohm video pin-plug cable)</p>
<p>B Analog terminal (Monaural, for subwoofer)</p> <p> </p> <p style="text-align: center;">Pin-plug cable</p>	<p>G S-Video terminal</p> <p> </p> <p style="text-align: center;">S-Video cable</p>
<p>C Digital terminal (Coaxial)</p> <p>(Orange) </p> <p style="text-align: center;">Coaxial cable (75 Ω/ohm pin-plug cable)</p>	<p>H Component video terminal</p> <p>(Green) (Y) (Blue) (PB/Cb) (Red) (Pr/Cr)</p> <p style="text-align: center;">Component video cable</p>
<p>D Digital terminal (Optical)</p> <p> </p> <p style="text-align: center;">Optical cable (Optical fiber cable)</p>	<p style="text-align: center;">Signal direction</p> <p>Audio signal </p> <p style="text-align: center;">IN OUT OUT IN</p> <p>Video signal </p> <p style="text-align: center;">IN OUT OUT IN</p>
<p>E Speaker terminal</p> <p>+ -</p> <p style="text-align: center;">Speaker cable</p>	

NOTE:

- Do not plug in the power supply cord until all connections have been completed.
- When making connections, also refer to the operating instructions of the other components.
- Be sure to connect the left and right channels properly (left with left, right with right).
- Note that binding pin-plug cables together with power supply cords or placing them near a power transformer will result in hum or other noise.

Connecting Other Sources

The video conversion function

With the AVR-686, the Video signal and the S-Video signal which were inputted are mutually converted. And also the Video signal and the S-Video signal which were inputted are converted into a higher quality.

The flow of the video signals.

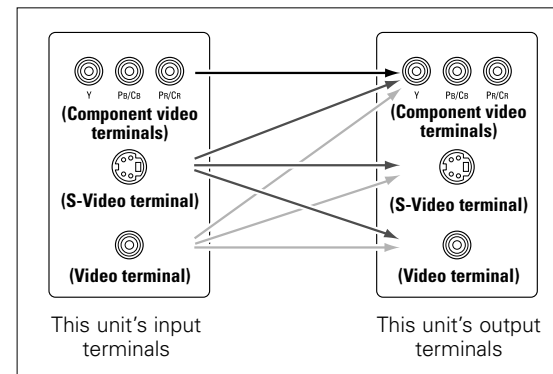

Cautions on the video conversion function:

When the component video terminals are used to connect the AVR-686 with a TV (or monitor, projector, etc.) and the video (yellow) or S-Video terminals are used to connect the AVR-686 with a VTR, depending on the combination of the TV and VTR the picture may flicker in the horizontal direction, be distorted, be out of sync not display at all when playing video tapes. If this happens, connect a commercially available video stabilizer, etc., with a TBC (time base corrector) function between the AVR-686 and the VTR, or if your VTR has a TBC function, turn it on.

Connecting Other Sources

Connecting a TV/DBS tuner

- For best picture quality choose the component video connection to your TV or DBS tuner. S-Video and composite video inputs are also provided if your TV or DBS tuner does not have component video outputs.
- To connect the digital audio output from the TV or DBS tuner, you can choose from either the coaxial or optical connections. If you choose to use the coaxial connection, it needs to be assigned. For more information about Digital Input Assignment (page 42).

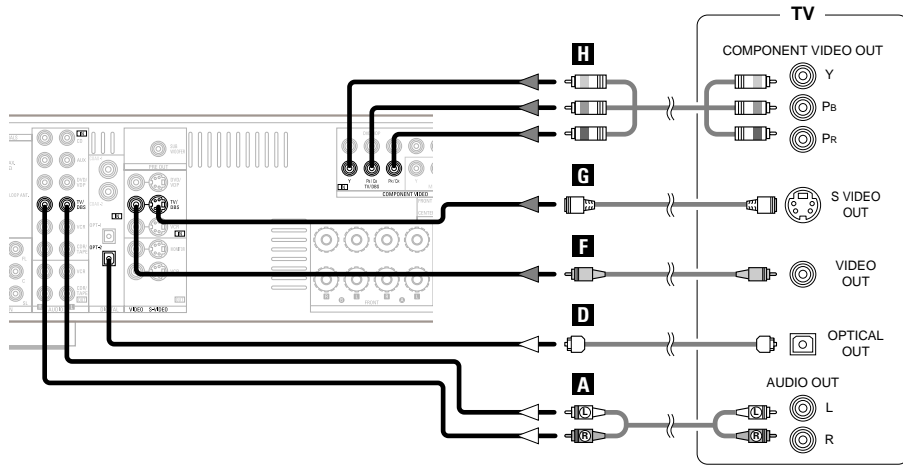

Connecting a video camera or video game

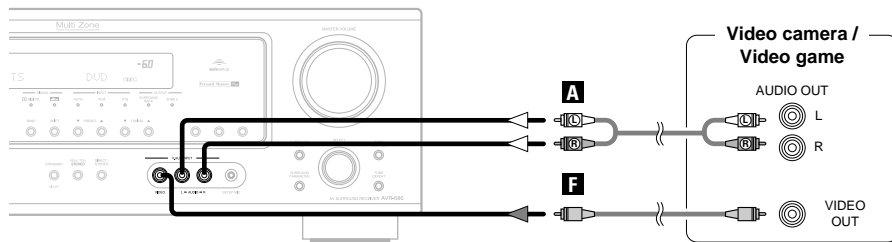

Connecting Other Sources

Connecting the external inputs (EXT. IN) terminals

- These terminals are for inputting multi-channel audio signals from an external decoder, or a component with a different type of multi-channel decoder, such as a DVD Audio player, a multi-channel Super Audio CD player, or another future multi-channel sound format decoder.
- The video signal connection is the same as that for a DVD player.
- For instructions on playback using the external input (EXT. IN) terminals (page 16).

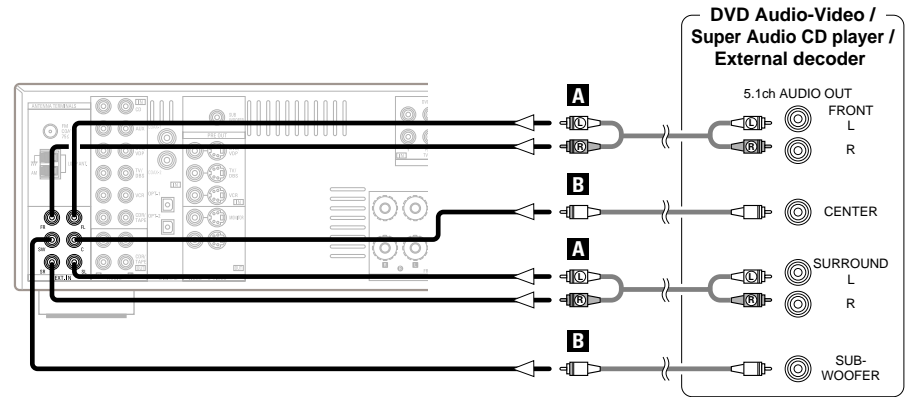

- With discs on which special copyright protection measures have been taken, the digital signals may not be output from the DVD player. In this case, connect the DVD player's analog multi-channel output to the AVR-686's EXT. IN terminals for playback. Also refer to your DVD player's operating instructions.

Connecting a CD player

To connect the digital audio output from the CD player, you can choose either coaxial or optical connection. If you choose to use the optical connection, it needs to be assigned. For more information about Digital Input Assignment (page 42).

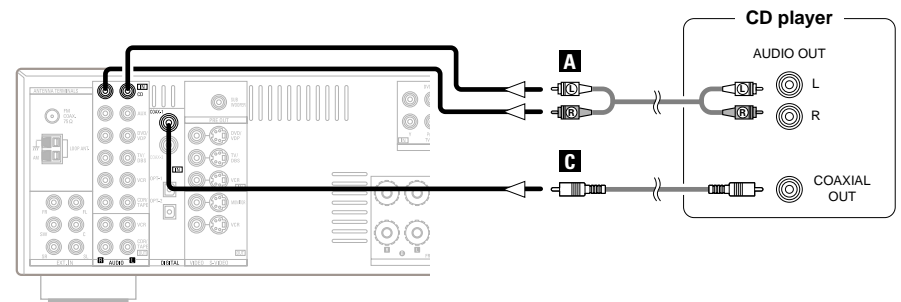

Connecting Other Sources

Connecting a VCR

- For best picture quality choose the component video connection to your VCR. S-Video and composite video outputs are also provided.
- If you wish to perform analog dubbing from a digital source, such as a DVD recorder to an analog recorder such as a cassette deck, you will need to connect the analog inputs and outputs as shown below, in addition to the digital audio connections.

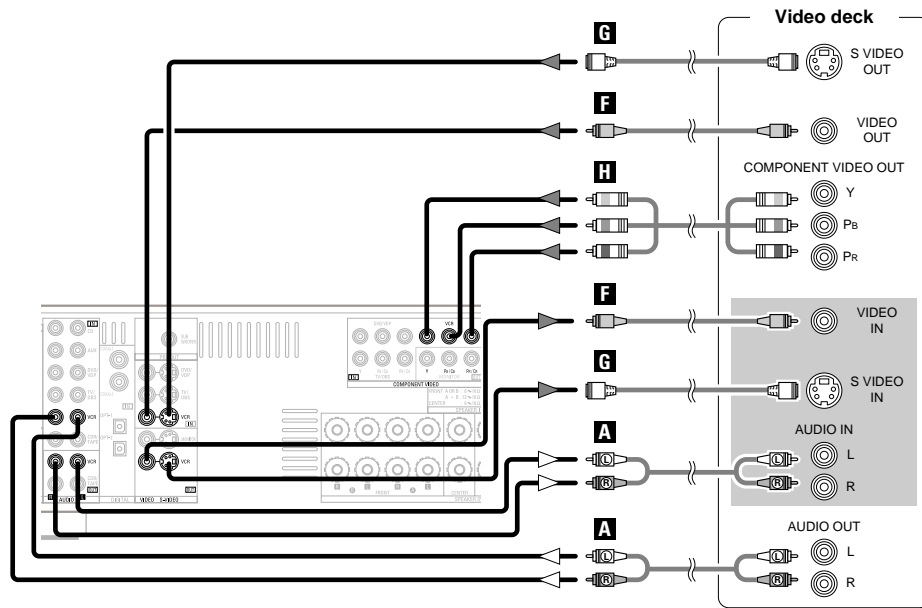

NOTE:

- When recording to a VCR recorder, it is necessary that the type of cable used with the playback source equipment be the same type that is connected to the AVR-686 VCR OUTPUT terminal.

Example: VCR IN → S-Video cable : VCR OUT → S-Video cable
 VCR IN → Video cable : VCR OUT → Video cable

Connecting Other Sources

Connecting a tape deck, CD recorder or MD recorder

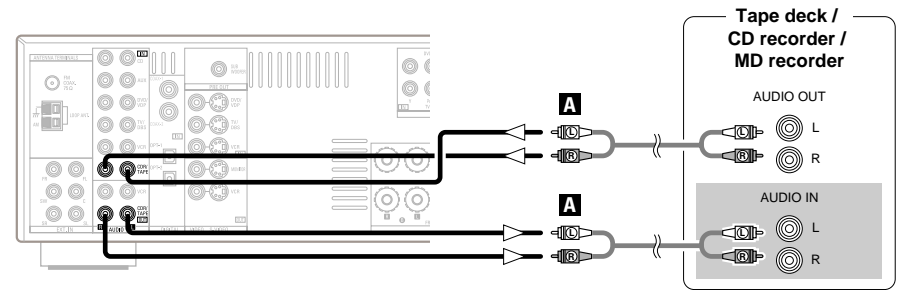

- If humming noise is generated, move the tape deck further away from the source of such noise.

Connecting the antenna terminals

An FM antenna cable plug can be connected directly to the unit.

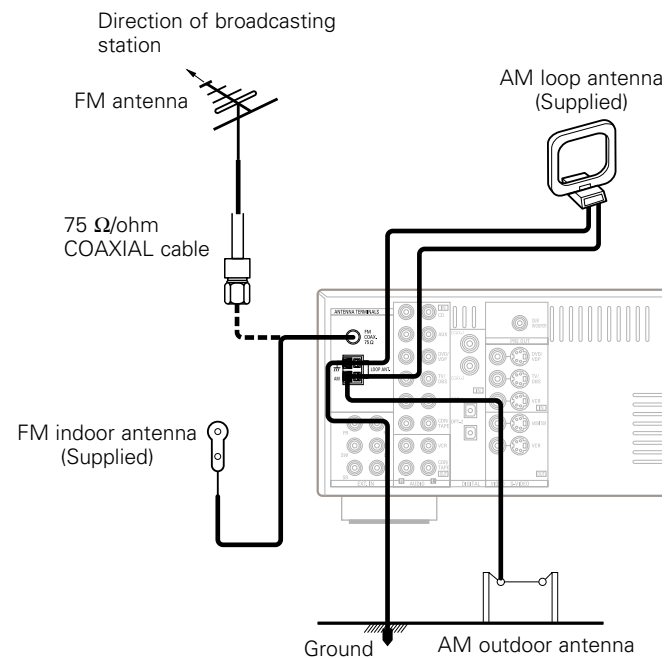

Connecting Other Sources

■ AM loop antenna assembly

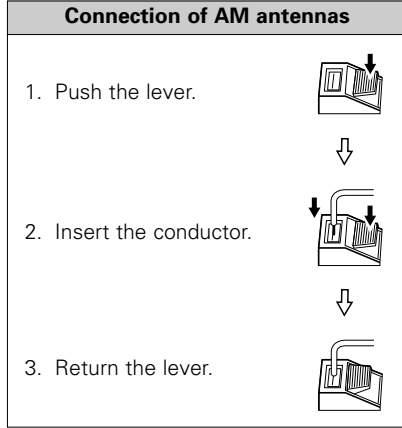
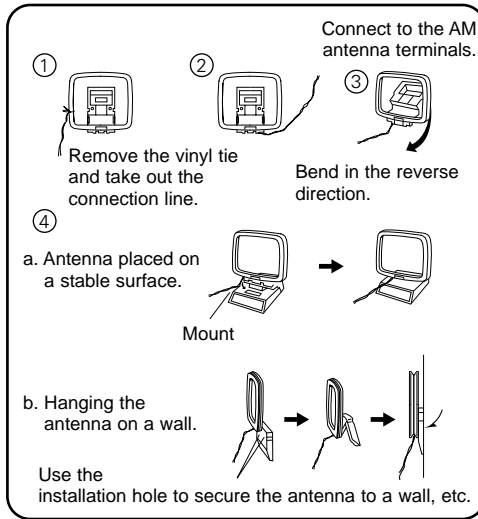

Note to CATV system installer:
 This reminder is provided to call the CATV system installer's attention to Article 820-40 of the NEC which provides guidelines for proper grounding and, in particular, specifies that the cable ground shall be connected to the grounding system of the building, as close to the point of cable entry as practical.

NOTE:

- Do not connect two FM antennas simultaneously.
- Even if an external AM antenna is used, do not disconnect the AM loop antenna.
- Make sure the AM loop antenna lead terminals do not touch metal parts of the panel.

Connecting the MULTI ZONE terminals

* For instructions on operations using the MULTI ZONE functions (page 35, 36).

Connecting Other Sources

ZONE2 speaker out connections

- When the power amplifier is assigned to the ZONE2 output channel at "Power Amp Assignment", the surround back speaker terminals can be used as the ZONE2 speaker out terminals (page 35).
- The connections diagram below is an example for when the surround back speaker is assigned to the ZONE2 stereo 2 channel. In this case, surround back speaker out can not be used for MAIN ZONE.

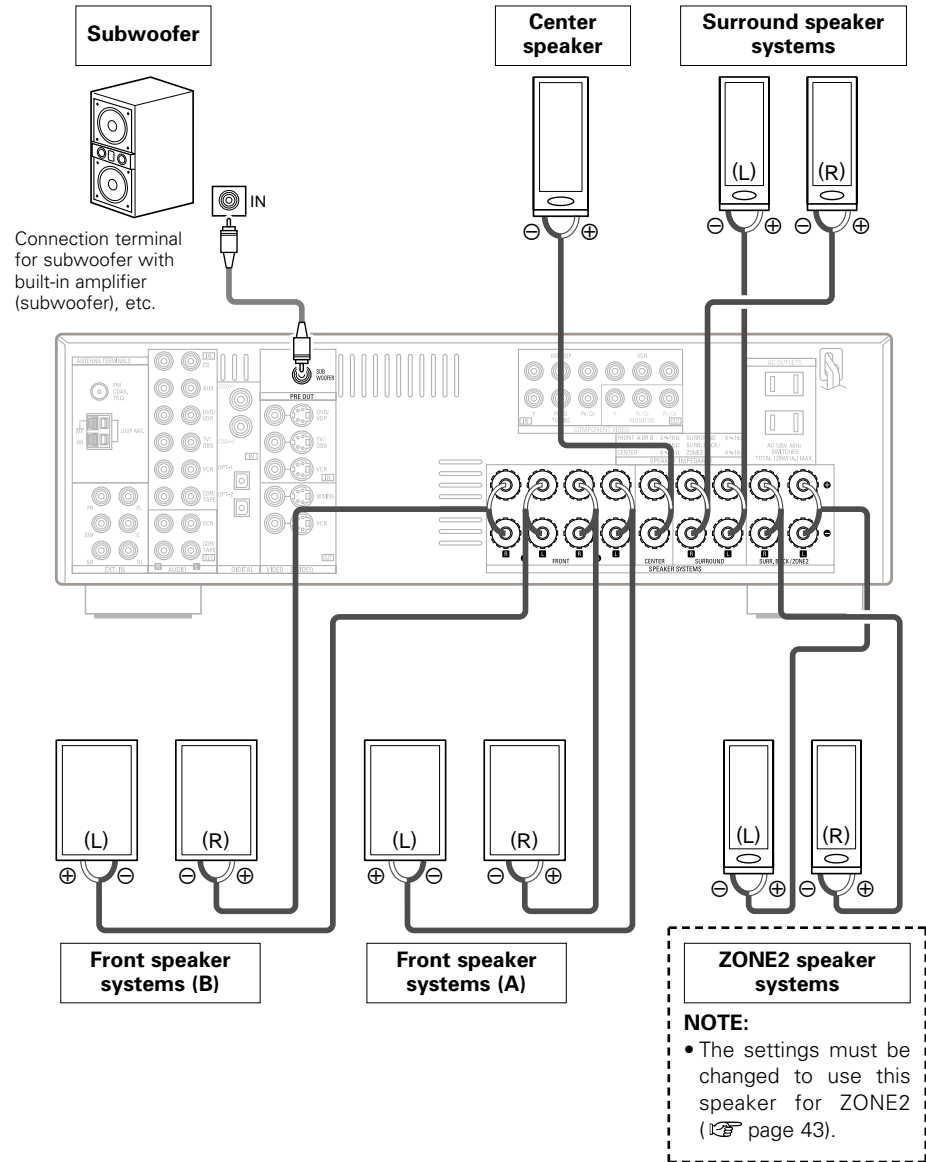

Connecting Other Sources

Connecting Other Sources

Connecting the power supply cord

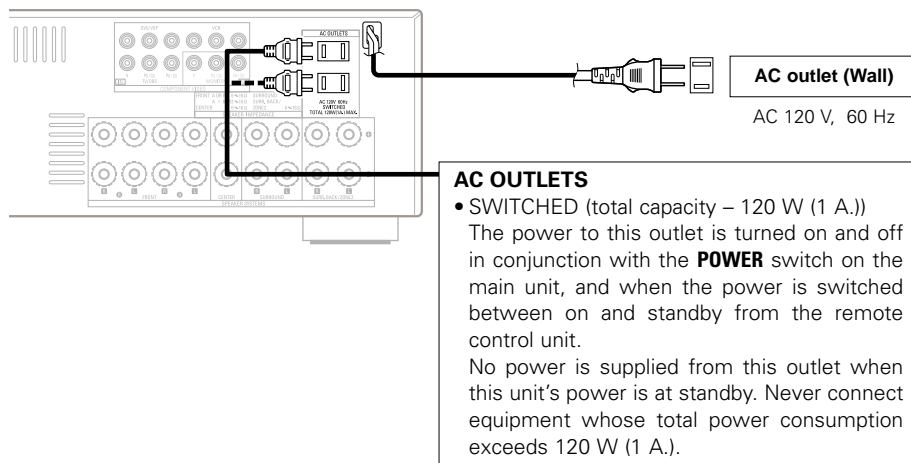
**NOTE:**

- Only use the AC OUTLETS for connecting audio equipment. Never use it for hair driers, TVs or other electrical appliances.

Basic Operation

Playback

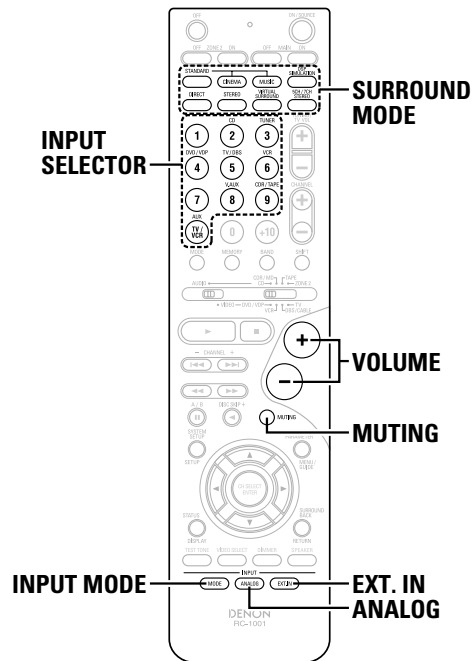
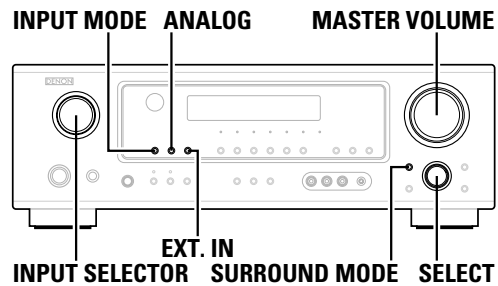

Playing the input source

1 Select the input source to be played.

Example: CD

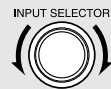

(Main unit)



(Remote control unit)

2 Select the play (surround) mode.

Example: STEREO



(Main unit)



(Remote control unit)

※ To select the surround mode while adjusting the surround parameters, tone defeat or tone control, press the **SURROUND MODE** button and then operate the selector.

3 Start playback on the selected component.

※ For operating instructions, refer to the component's manual.

4 Adjust the volume.



(Main unit)



(Remote control unit)

The volume level is displayed on the master volume level display.

※ The volume can be adjusted within the range of -70 to 0 to 18 dB, in steps of 1 dB. However, when the channel level is set as described (page 28), if the volume for any channel is set at +1 dB or greater, the volume cannot be adjusted up to 18 dB. (In this case the maximum volume is adjusted to "18 dB — (Maximum value of channel level)".)

Playback using the external input (EXT. IN) terminals

The signals being input to the external decoder input terminals are played without passing through the surround circuitry.

Press the **EXT. IN** button to select the external input.



- Cancelling the external input mode:
Press the **INPUT MODE** or **ANALOG** button to switch to the desired input mode (page 17, 18).
- The external input mode can be set for any input source. To watch video while listening to sound, select the input source to which the video signal is connected, then set this mode.
- If the subwoofer output level is too high, set the "SW ATT." surround parameter to "ON".

NOTE:

- When the input mode is set to the external input (EXT. IN), the play mode (DIRECT, VIRTUAL SURROUND, STEREO, STANDARD (DOLBY/DTS SURROUND), 5CH/7CH STEREO or DSP SIMULATION) cannot be selected.
- In play modes other than the external input mode, the signals connected to the EXT. IN terminals cannot be reproduced. In addition, signals cannot be output from channels not connected to the input terminals.

Turning the sound off temporarily (MUTING)

Use this to turn off the audio output temporarily.

Press the **MUTING** button.



- Canceling the MUTING mode:
 - ① Press the **MUTING** button again.
 - ② Press the **VOLUME** button on the remote control unit, or adjust the volume up or down via the front panel **MASTER VOLUME** knob.

Basic Operation

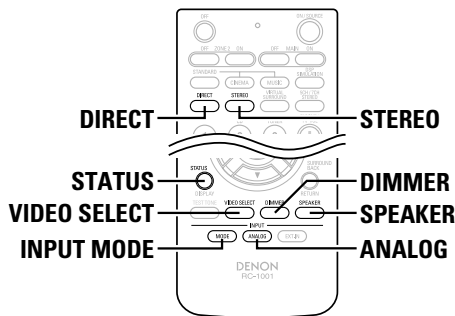
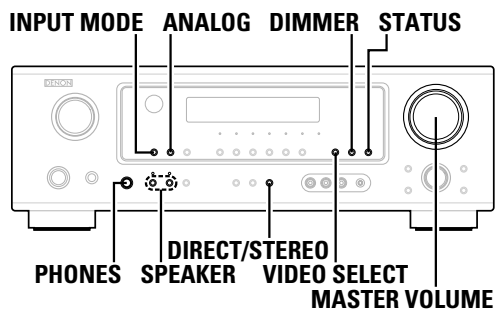

Listening over headphones

Connect the headphones to the **PHONES** jack.

- The speaker output is automatically turned off when headphones are connected.

NOTE:

- To prevent hearing loss, do not raise the volume level excessively when using headphones.

Combining the currently playing sound with the desired image (VIDEO SELECT)

Press the **VIDEO SELECT** button repeatedly until the desired source appears on the display.

IN=V SOURCE

- ※ Use this switch to monitor a video source other than the audio source.



• Canceling simulcast playback:

- ① Select "SOURCE" by pressing the **VIDEO SELECT** button.
- ② Switch the program source to the component connected to the video input terminals.

Selecting the front speakers

Press the **SPEAKER A** or **B** button to turn the corresponding speaker pair on.

- ※ The front speaker A, B setting can be also be changed with the **SPEAKER** button on the remote control unit.

Checking the currently playing program source

■ **Front panel display**

Press the **STATUS** button.

- ※ Descriptions of the unit's operations are also displayed on the front panel display. In addition, the display can be switched to check the unit's operating status while playing a source.

■ **Using the dimmer function**

Press the **DIMMER** button.

- ※ The display brightness changes in four steps (bright, medium, dim and off).

Basic Operation

Input mode

The AVR-686 has an **AUTO** signal detection mode that automatically identifies the type of incoming audio signals, but is also equipped with a manual mode that can be switched according to the type of input audio signals.

■ **Selecting the AUTO, PCM and DTS modes**

Press the **INPUT MODE** button.

- ※ The mode switches as shown below each time the **INPUT MODE** button is pressed:



AUTO (auto mode):

In this mode, the types of signals being input to the digital and analog input terminals for the selected input source are detected and the program in the AVR-686's surround decoder is selected automatically upon playback. This mode can be selected for all input sources other than TUNER.

The presence or absence of digital signals is detected, the signals input to the digital input terminals are identified and decoding and playback are performed automatically with the DTS, Dolby Digital or PCM (2 channel stereo) format. If no digital signal is being input, the analog input terminals are selected.

Use this mode to play Dolby Digital signals.

PCM (exclusive PCM signal playback mode):

Decoding and playback are only performed when PCM signals are being input.

Note that noise may be generated when using this mode to play signals other than PCM signals.

DTS (exclusive DTS signal playback mode):

Decoding and playback are only performed when DTS signals are being input.

Basic Operation

■ Selecting the analog mode

Press the **ANALOG** button to switch to the analog input.

ANALOG (exclusive analog audio signal playback mode):
The signals input to the analog input terminals are decoded and played.

NOTE:

- Input mode when playing DTS sources:
Noise will be output if DTS-compatible CDs or LDs are played in the "ANALOG" or "PCM" mode.
When playing DTS-compatible sources, be sure to connect the source component to the digital input terminals (OPTICAL/COAXIAL) and set the input mode to "DTS".

■ Input mode display

- In the AUTO mode

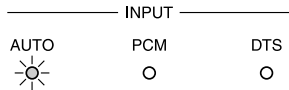

Depending on the input signal.

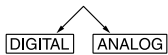

- In the DIGITAL PCM mode

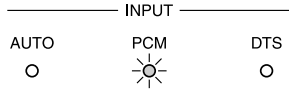

DIGITAL

- In the DIGITAL DTS mode

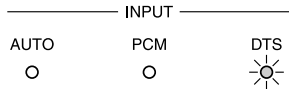

DIGITAL

- In the ANALOG mode

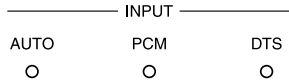

ANALOG

■ Input signal display

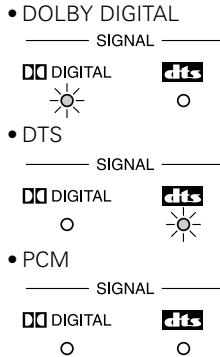

※ The "DIGITAL" indicator lights when digital signals are being input properly. If the "DIGITAL" indicator does not light, check whether the Digital In Assignment setup (page 42) and connections are correct and whether the component's power is turned on.

Surround

Playing audio sources (CDs and DVDs)
2-channel playback modes

- The AVR-686 is equipped with 2-channel playback modes exclusively for music.
- Select the mode to suit your tastes.

■ DIRECT mode

Use this mode to achieve good quality 2-channel sound while watching images. In this mode, the audio signals bypass such circuits as the tone circuit and are transmitted directly, resulting in good quality sound.

Press the **DIRECT/STEREO** button on the main unit or the **DIRECT** button on the remote control unit to select the **DIRECT** mode.

NOTE:

- The "DIGITAL" indicator will light when playing CD-ROMs containing data other than audio signals, but no sound will be heard.

Basic Operation

■ STEREO mode

Use this mode to adjust the tone and achieve the desired sound while watching images.

Press the **DIRECT/STEREO** button on the main unit or the **STEREO** button on the remote control unit to select the **STEREO** mode.

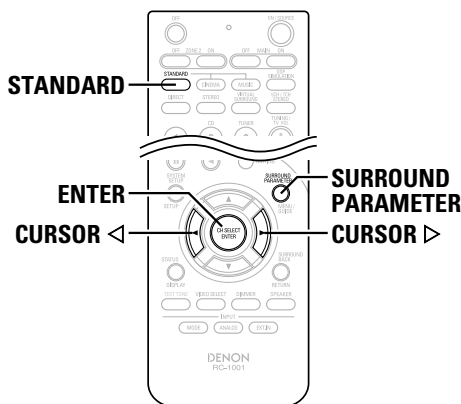
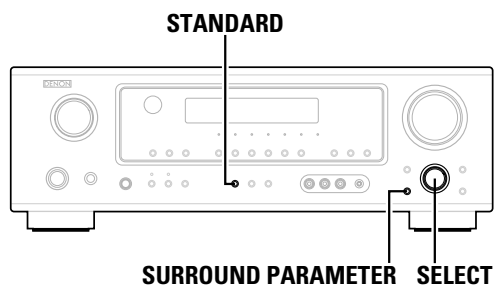

Dolby Pro Logic IIx (Pro Logic II) mode

- To play in the PLIIx mode, set "S. BackSp" at the "Speaker Configuration" setting to "1sp" or "2sp".
- To play in the PLIIx mode, set "Surround Back" at the "Power Amp Assign." setting.

1 Press the STANDARD button to select the Dolby Pro Logic IIx mode.

- The Dolby Pro Logic II indicator lights.



※ The mode switches as shown below each time the button is pressed.



2 Play a program source.

※ For operating instructions, refer to the manuals of the respective components.

3 Press the SURROUND PARAMETER button to select the surround parameter mode.



4 Turn the SELECT knob, and press the CURSOR < or > button to select the optimum mode for the source.

※ When the "SURROUND BACK" parameter is set to "ON". (Set "S. Back" at system setup to "Small" or "Large".)

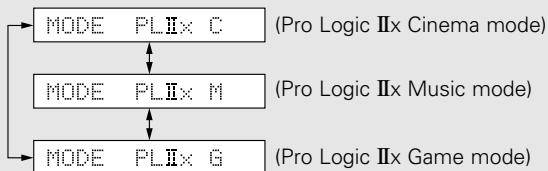

※ When the "SURROUND BACK" parameter is set to "OFF". (Set "S. Back" at system setup to "None".)

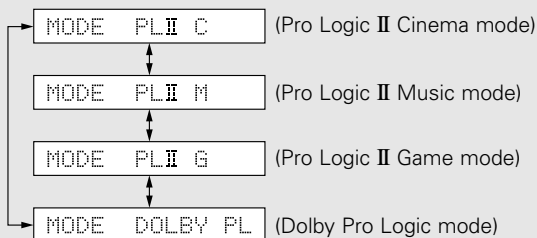

5 Press the SURROUND PARAMETER button to select the various parameters.

※ The mode switches as shown below each time the button is pressed.

• When the Cinema mode:

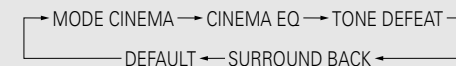

• When the Music mode:

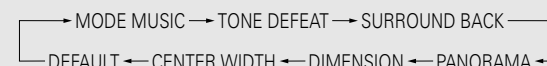

• When the Game mode:

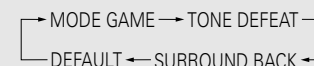

• When the Dolby Pro Logic mode:

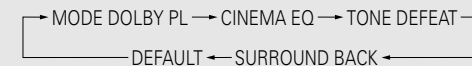

※ If you do want the bass and treble to be adjusted, turn off the tone defeat mode.

6 Turn the SELECT knob, and press the CURSOR < or > button to set the various surround parameters.

※ When the surround parameters are set using the buttons on the main unit, stop operating the buttons after completing the settings. The settings are automatically finalized and the normal display reappears after several seconds.

• Cinema EQ setting:



- **PANORAMA setting**

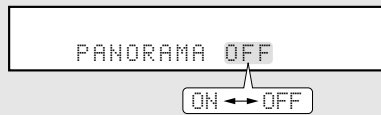

- **DIMENSION setting**

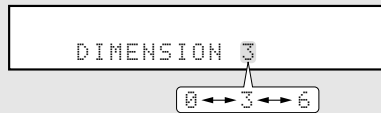

- **CENTER WIDTH setting**



- **TONE DEFEAT setting**

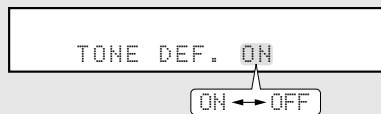

- **SURROUND BACK SPEAKER setting**

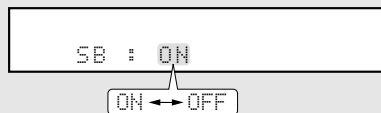

- **D. COMP. setting**

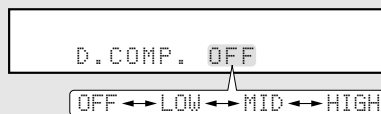

※ This parameter is displayed during DOLBY DIGITAL playback.

- **DEFAULT setting**

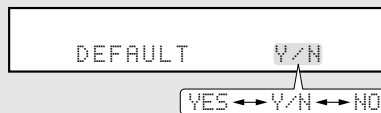

※ Select "YES" to reset to the factory defaults.

7 Press the **ENTER** button to finish the surround parameter mode.



- When making parameter settings, the display will return to the regular condition several seconds after the last button was pressed and the setting will be completed.

■ Surround parameters ①

Pro Logic IIx and Pro Logic II Mode:

The Cinema mode is for use with stereo television shows and all programs encoded in Dolby Surround.

The Music mode is recommended for stereo music and surround-encoded stereo music sources.

The Pro Logic mode offers the same robust surround processing as original Pro Logic in case the source content is not of optimum quality.

The Game mode is for playing games. The game mode can only be used with 2-channel audio sources.

Select one of the modes ("Cinema", "Music", "Pro Logic" or "Game").

- **Panorama Control:**

This mode extends the front stereo image to include the surround speakers for an exciting "wraparound" effect with side wall imaging.

Select "OFF" or "ON".

- **Dimension Control:**

This control gradually adjusts the soundfield either towards the front or towards the rear.

The control can be set in 7 steps from 0 to 6.

- **Center Width Control:**

This control adjusts the center image so it may be heard only from the center speaker; only from the left/right speakers as a phantom image; or from all three front speakers to varying degrees.

The control can be set in 8 steps from 0 to 7.

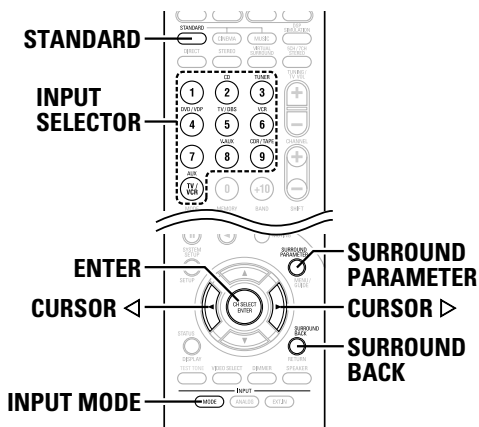
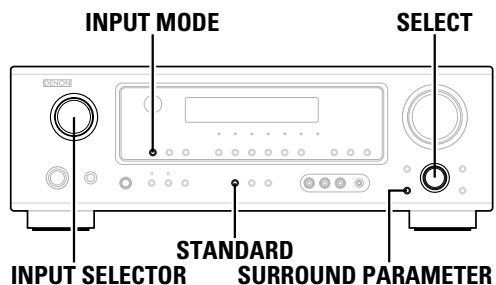

DTS NEO:6 mode

1 Press the **STANDARD** button to select the **DTS NEO:6** mode.

※ The mode switches as shown below each time the button is pressed.



2 Play a program source.

3 Press the **SURROUND PARAMETER** button to select the surround parameter mode.

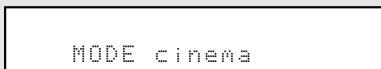

4 Turn the **SELECT** knob, and press the **CURSOR** ◀ or ▶ button to select the optimum mode for the source.

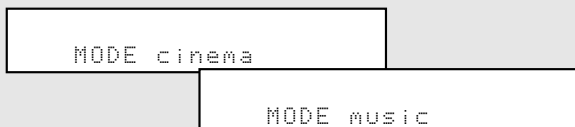

5 Press the **SURROUND PARAMETER** button to select the various parameters.

※ The mode switches as shown below each time the button is pressed.

• When the Cinema mode:

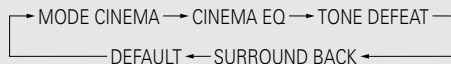

• When the Music mode:

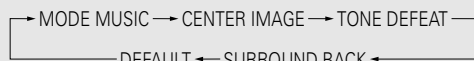

※ If you do want the bass and treble to be adjusted, turn off the tone defeat mode.

6 Turn the **SELECT** knob, and press the **CURSOR** ◀ or ▶ button to set the various surround parameters.

※ When the surround parameters are set using the buttons on the main unit, stop operating the buttons after completing the settings. The settings are automatically finalized and the normal display reappears after several seconds.

• **CINEMA EQ** setting:

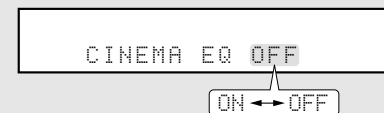

• **CENTER IMAGE** setting



• **TONE DEFEAT** setting

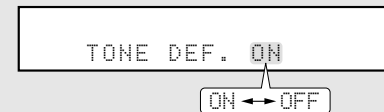

• **SURROUND BACK SPEAKER** setting

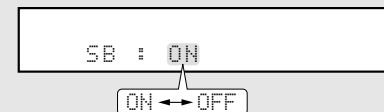

• **D. COMP.** setting

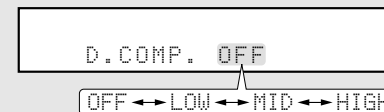

※ This parameter is displayed during DOLBY DIGITAL playback.

• **DEFAULT** setting



※ Select "YES" to reset to the factory defaults.

7 Press the **ENTER** button to finish the surround parameter mode.

Basic Operation



- When making parameter settings, the display will return to the regular condition several seconds after the last button was pressed and the setting will be completed.

■ Surround parameters ②

DTS NEO:6 Mode:

• Cinema:

This mode is optimum for playing movies. Decoding is performed with emphasis on separation performance to achieve the same atmosphere with 2-channel sources as with 6.1-channel sources.

This mode is effective for playing sources recorded in conventional surround formats as well, because the in-phase component is assigned mainly to the center channel (C) and the reversed phase component to the surround (SL, SR and SB channels).

• Music:

This mode is suited mainly for playing music. The front channel (FL and FR) signals bypass the decoder and are played directly so there is no loss of sound quality, and the effect of the surround signals output from the center (C) and surround (SL, SR and SB) channels add a natural sense of expansion to the sound field.

CENTER IMAGE (0.0 to 1.0: default 0.3):

The center image parameter for adjusting the expansion of the center channel in the DTS NEO:6 MUSIC mode has been added.

Dolby Digital mode and DTS surround (only with digital input)

1 Select an input source set to digital (COAXIAL/OPTICAL) (page 42).

Example: DVD

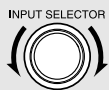

(Main unit)



(Remote control unit)

2 Press the INPUT MODE button to set the input mode to "AUTO" or "DTS".

3 Press the STANDARD button to select the STANDARD (Dolby/DTS Surround) mode.

4 Play a program source with the or symbol.

- The Dolby Digital indicator lights when playing Dolby Digital sources. DIGITAL — Lights
- The DTS indicator lights when playing DTS sources. — Lights

- ※ Operate the SURROUND BACK button to switch Surround Back CH ON/OFF. SURROUND BACK — Lights
- The SURROUND BACK indicator lights when the SURROUND BACK button is on.

5 Press the SURROUND PARAMETER button to select the various parameters.

- ※ The parameter switches as shown below each time the button is pressed.

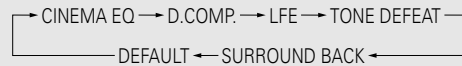

- ※ If you do want the bass and treble to be adjusted, turn off the tone defeat mode.

6 Turn the SELECT knob, and press the CURSOR ◀ or ▶ button to set the various surround parameters.

- ※ The mode switches as shown below each time the button is pressed.

• CINEMA EQ setting:



• D. COMP. setting

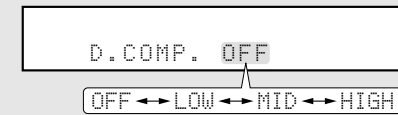

- ※ This parameter is displayed during DOLBY DIGITAL playback.

• LFE setting

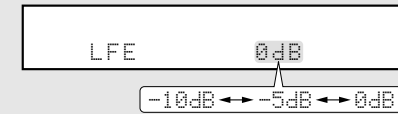

• TONE DEFEAT setting



• SURROUND BACK SPEAKER setting

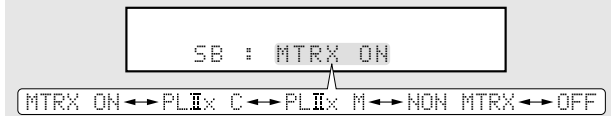

- ※ This parameter is displayed during DOLBY DIGITAL playback.

• DEFAULT setting



- ※ Select "YES" to reset to the factory defaults.

7 Press the ENTER button to finish the surround parameter mode.



- When making parameter settings, the display will return to the regular condition several seconds after the last button was pressed and the setting will be completed.

Basic Operation

■ Surround parameters ③

CINEMA EQ. (Cinema Equalizer):

The Cinema EQ function gently decreases the level of the extreme high frequencies, compensating for overly-bright sounding motion picture soundtracks. Select this function if the sound from the front speakers is too bright.

This function only works in the Dolby Pro Logic IIx, Dolby Digital, DTS Surround and DTS NEO:6 modes. (The same contents are set for all operating modes.)

D.COMP. (Dynamic Range Compression):

Motion picture soundtracks have tremendous dynamic range (the contrast between very soft and very loud sounds). For listening late at night, or whenever the maximum sound level is lower than usual, the Dynamic Range Compression allows you to hear all of the sounds in the soundtrack (but with reduced dynamic range). (This only works when playing program sources recorded in Dolby Digital or DTS). Select one of the four parameters ("OFF", "LOW", "MID" (middle) or "HIGH"). Set to "OFF" for normal listening.

LFE (Low Frequency Effect):

This sets the level of the LFE (Low Frequency Effect) sounds included in the source when playing program sources recorded in Dolby Digital or DTS.

If the sound produced from the subwoofer sounds distorted due to the LFE signals when playing Dolby Digital or DTS sources when the peak limiter is turned off with the subwoofer peak limit level setting, adjust the level as necessary.

Program source and adjustment range:

1. Dolby Digital: -10 dB to 0 dB
2. DTS Surround: -10 dB to 0 dB

※ **When DTS encoded movie software is played, it is recommended that the LFE LEVEL be set to 0 dB for correct DTS playback.**

※ **When DTS encoded music software is played, it is recommended that the LFE LEVEL be set to -10 dB for correct DTS playback.**

TONE:

This enables tone control. This can be set individually for the separate surround modes other than DIRECT mode.

SB CH OUT (Surround Back):

(1) Multi-channel source

- **OFF:**
Playback is conducted without using the surround back speaker.
- **NON MTRX:**
The same signals as those of the surround channels are output from the surround back channels.
- **MTRX ON:**
The surround back channel is reproduced using digital matrix processing.
- **ES MTRX:**
When playing DTS signals, the surround back signals undergo digital matrix processing for playback.
- **ES DSCRT:**
When a signal identifying the source as a discrete 6.1-channel source is included in the DTS signals, the surround back signals included in the source are played.
- **PLIIx Cinema:**
Processing is performed with the Cinema mode of the PLIIx decoder and the surround back channel is reproduced.
- **PLIIx Music:**
Processing is performed with the Music mode of the PLIIx decoder and the surround back channel is reproduced.

(2) 2ch source

- **OFF:**
Playback is conducted without using the surround back speaker.
- **ON:**
Playback is conducted using the surround back speaker.

Basic Operation

■ Dialogue normalization

The dialog normalization function is activated automatically when playing Dolby Digital program sources.

Dialog normalization is a basic function of Dolby Digital which automatically normalizes the dialog level (standard level) of the signals which are recorded at different levels for different program sources, such as DVD, DTV and other future formats that will use Dolby Digital.

These contents can be verified with the **STATUS** button.

OFFSET - 4dB

The number indicates the normalization level when the currently playing program is normalized to the standard level.

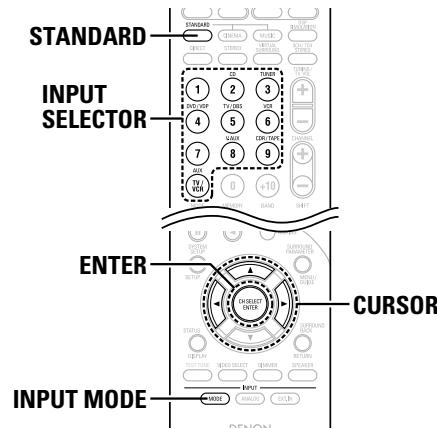
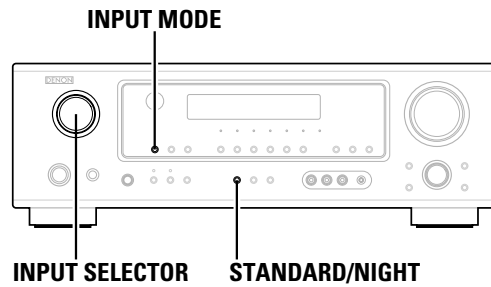

Night mode

When listening at night or at lower volumes, the night mode improves listenability.

Press and hold the NIGHT button for several seconds to enter the night mode.



- Canceling night mode: Press and hold the **NIGHT** button again.
- The night mode only works when playing program sources recorded in Dolby Digital or DTS.

Adjusting the audio delay

- When watching a DVD or other video source, the picture on the monitor may seem delayed with respect to the sound. In this case, adjust the audio delay to delay the sound and synchronize it with the picture.
- The audio delay setting is stored separately for each input source.
- This adjustment can be performed with the system setup (page 43) or from the remote control unit, as described below.

1 Select the input source.

Example: DVD

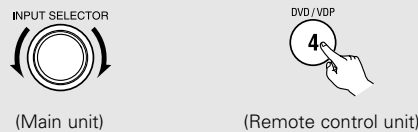

2 Press the INPUT MODE button to set the input mode to "AUTO".

3 Select Dolby/DTS Surround.

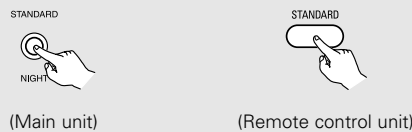

4 Play a program source (DVD, etc.).

5 Press the CURSOR Δ button to switch to the audio delay adjustment display.

6 Press the CURSOR < or > button to set the delay time (0 ms ~ 200 ms).

※ With a movie source, for example, adjust so that the movement of the actors' lips is synchronized with the sound.

7 Press the ENTER button to complete the setting.



- The audio delay setting does not apply when playing in the EXT. IN mode or in the analog input direct or stereo mode.

DENON original surround modes

This unit is equipped with a high performance DSP (Digital Signal Processor) which uses digital signal processing to synthetically recreate the sound field. One of 7 preset surround modes can be selected according to the program source and the parameters can be adjusted according to the conditions in the listening room to achieve a more realistic, powerful sound.

Surround modes and their features

1	5CH/7CH STEREO	The front left channel signals are output to the surround and surround back left channels, the front right channel signals are output to the surround and surround back right channels, and the in-phase component of the left and right channels is output to the center channel. Use this mode to enjoy stereo sound.
2	MONO MOVIE (NOTE)	Select this when watching monaural movies for a greater sense of expansion.
3	ROCK ARENA	Use this mode to achieve the feeling of a live concert in an arena with reflected sounds coming from all directions.
4	JAZZ CLUB	This mode creates the sound field of a live house with a low ceiling and hard walls. This mode gives jazz a very vivid realism.
5	VIDEO GAME	Use this to enjoy video game sources.
6	MATRIX	Select this to emphasize the sense of expansion for music sources recorded in stereo. Signals consisting of the component difference of the input signals (the component that provides the sense of expansion) processed for delay are output from the surround channel.
7	VIRTUAL	Select this mode to enjoy a virtual sound field, produced from the front 2-channel speakers or headphones.

※ Depending on the program source being played, the effect may not be very noticeable.
In this case, try other surround modes, without worrying about their names, to create a sound field suited to your tastes.

NOTE: When playing sources recorded in monaural, the sound will be one-sided if signals are only input to one channel (left or right), so input signals to both channels. If you have a source component with only one audio output (monophonic camcorder, etc.) obtain a "Y" adapter cable to split the mono output to two outputs, and connect to the L and R inputs.

Personal memory plus

This set is equipped with a personal memorize function that automatically memorizes the surround modes and input modes selected for the different sources. When the input source is switched, the modes set for that source last time it was used are automatically recalled.

※ The surround parameters, tone control settings and playback level balance for the different output channels are memorized for each surround mode.

Basic Operation

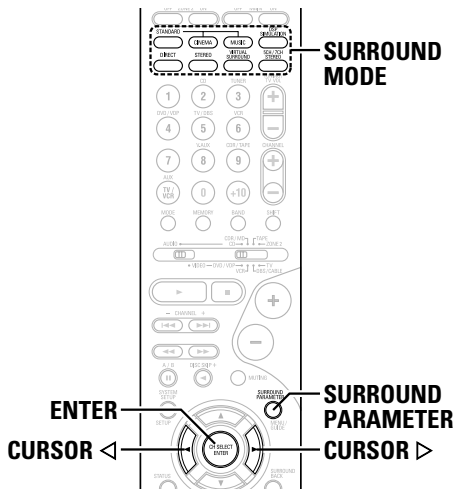

DSP surround simulation

To operate the surround mode and the surround parameters from the remote control unit

1 Select the surround mode for the input channel.

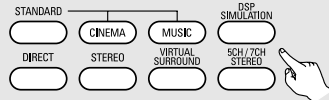

(Remote control unit)

The surround mode switches in the following order each time the **DSP SIMULATION** button is pressed:

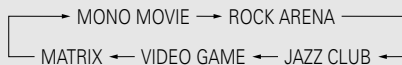

2 Press the **SURROUND PARAMETER** button to enter the surround parameter setting mode.

The surround parameter switches in the following order each time the **SURROUND PARAMETER** button is pressed for the different surround modes.

When the **MONO MOVIE, ROCK ARENA, JAZZ CLUB** and **VIDEO GAME** mode:

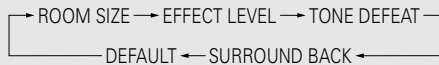

When the **MATRIX** mode:

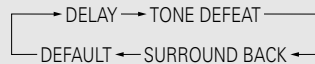

When the **VIRTUAL** mode:

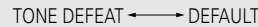

If you do want the bass and treble to be adjusted, turn off the tone defeat mode.

3 Press the **SURROUND PARAMETER** button to select the various parameters.

4 Press the **CURSOR** button to set the various parameters.

ROOM SIZE setting:

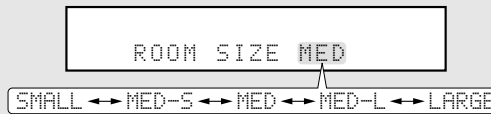

EFFECT LEVEL setting



DELAY TIME setting

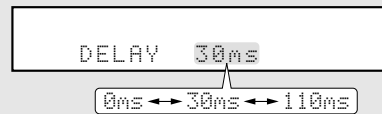

Basic Operation

D. COMP. setting

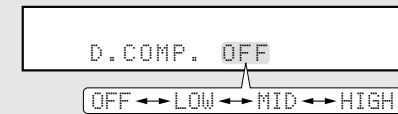

This parameter is displayed during DOLBY DIGITAL playback.

LFE setting

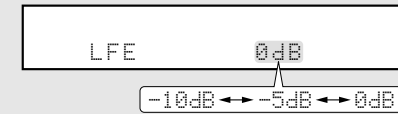

This parameter is displayed during DOLBY DIGITAL and DTS playback.

TONE DEFEAT setting

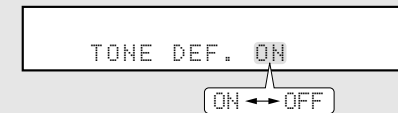

SURROUND BACK SPEAKER setting

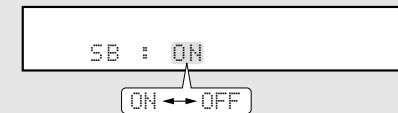

This parameter is displayed during DOLBY DIGITAL playback.

DEFAULT setting



Select "YES" to reset to the factory defaults.

5 Press the **ENTER** button to finish the surround parameter mode.



When making parameter settings, the display will return to the regular condition several seconds after the last button was pressed and the setting will be completed.

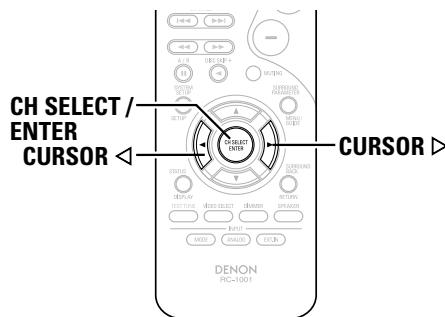
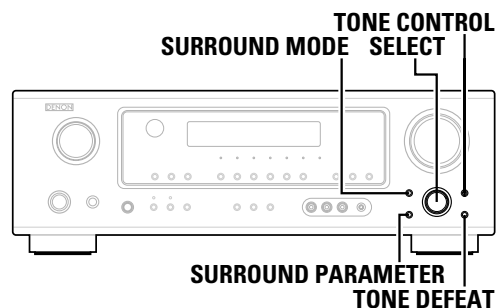

■ Operating the surround mode and the surround parameters from the main unit's panel

1 Turn the **SELECT** knob to select the surround mode.

※ When turned clockwise:



※ When turned counterclockwise:



※ To select the surround mode while adjusting the surround parameters, tone defeat or tone control, press the **SURROUND MODE** button, then operate the selector.

2 Press and hold in the **SURROUND PARAMETER** button to select the parameter you want to set.

※ The parameters which can be set differ for the different surround modes are displayed. (Refer to "Surround modes and parameters" (page 51).)

3 Display the parameter you want to adjust, then turn the **SELECT** knob to set it.



• When making parameter settings, the display will return to the regular condition several seconds after the last button was pressed and the setting will be completed.

■ Surround parameters ④

ROOM SIZE:

This sets the size of the sound field. There are five settings: "small", "med.s" (medium-small), "medium", "med.l" (medium-large) and "large". "small" recreates a small sound field, "large" a large sound field.

EFFECT LEVEL:

This sets the strength of the surround effect. The level can be set in 15 steps from 1 to 15. Lower the level if the sound seems distorted.

DELAY TIME:

The delay time can be set within the range of 0 to 110 ms only in the matrix mode.

TONE CONTROL:

This can be set individually for each surround mode except DIRECT.

Basic Operation

Basic Operation

Tone control setting**■ Adjusting the sound quality (tone)**

The tone control function will not work in the DIRECT mode.

1 Press the TONE CONTROL button.

- ※ The tone switches as follows each time the **TONE CONTROL** button is pressed.

BASS ← → TREBLE

2 Turn the SELECT knob to adjust the level of the bass or treble.

- ※ To increase the bass or treble:
Turn the control clockwise. (The bass or treble sound can be increased up to +12 dB in steps of 2 dB.)
- ※ To decrease the bass or treble:
Turn the control counterclockwise. (The bass or treble sound can be decreased down to -12 dB in steps of 2 dB.)

■ Tone defeat mode

If you do not want the bass and treble to be adjusted, turn on the tone defeat mode.

Press the TONE DEFEAT button.

- ※ The signals do not pass through the bass and treble adjustment circuits, thus resulting in higher quality sound.

Channel Level

You can adjust the channel level either according to the playback sources or to suit your taste, as described below.

1 Press the CH SELECT button to select the speaker whose level you want to adjust.

- ※ The channel switches as shown below each time the button is pressed.

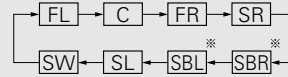

- ※ When the surround back speaker setting is set to "1sp" for "Speaker Configuration", this is set to "SB".
- ※ "SB" appears only when the "Power Amp Assign." setting is the surround back mode.

2 Press the CURSOR ◀ or ▶ button to adjust the level of the selected speaker.

- ※ The default setting of the channel level is 0 dB.
- ※ The level of the selected speaker can be adjusted within the range of +12 to -12 dB by pressing the **CURSOR** buttons.
- ※ The SW channel level can be turned off by decreasing it one step from -12 dB.

OFF ↔ -12 dB ↔ +12 dB

Basic Operation

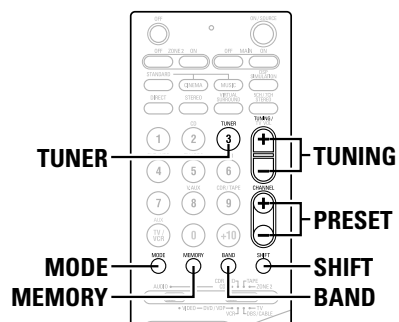
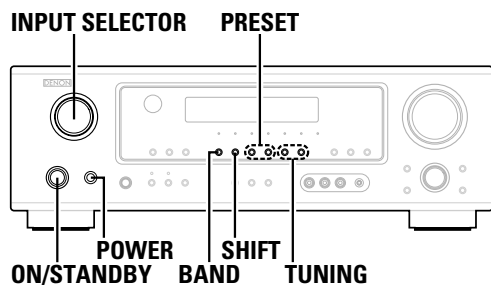

Listening to the radio

Auto preset memory

This unit is equipped with a function for automatically searching for FM broadcast stations and storing them in the preset memory.

Hold the **PRESET ▲** button and press the **POWER** switch on the main unit.

- The unit automatically begins searching for FM broadcast stations.

※ When the first FM broadcast station is found, that station is stored in the preset memory at channel A1.

Subsequent stations are automatically stored in order at preset channels A1 to A8, B1 to B8, C1 to C8, D1 to D8, E1 to E8, F1 to F8 and G1 to G8 for a maximum of 56 stations.

※ Channel A1 is tuned in after the auto preset memory operation is completed.



- If an FM station cannot be preset automatically due to poor reception, use the "Manual tuning" operation to tune in the station, then preset it using the manual "Preset memory" operation.
- To interrupt this function, press the **ON/STANDBY** switch.

■ DEFAULT SETTINGS

Auto tuner presets	
A1 ~ A8	87.5 / 89.1 / 98.1 / 107.9 / 90.1 / 90.1 / 90.1 / 90.1 MHz
B1 ~ B8	520 / 600 / 1000 / 1400 / 1500 / 1710 kHz, 90.1 / 90.1 MHz
C1 ~ C8	90.1 MHz
D1 ~ D8	90.1 MHz
E1 ~ E8	90.1 MHz
F1 ~ F8	90.1 MHz
G1 ~ G8	90.1 MHz

Basic Operation

Auto tuning

1 Set the input source to "TUNER".



(Main unit)



(Remote control unit)

2 Watching the display, press the **BAND** button to select the desired band (AM or FM).

3 Press the **MODE** button to set the auto tuning mode.

Lights



4 Press the **TUNING (+) or (-)** button.

※ Automatic searching begins, then stops when a station is tuned in.



- When in the auto tuning mode on the FM band, the "STEREO" indicator lights on the display when a stereo broadcast is tuned in. At open frequencies, the noise is muted and the "TUNED" and "STEREO" indicators turn off.

Manual tuning

- 1** Set the input source to “TUNER”.
- 2** Watching the display, press the **BAND** button to select the desired band (AM or FM).
- 3** Press the **MODE** button to set the manual tuning mode.

※ Check that the display’s “AUTO” indicator turns off.

- 4** Press the **TUNING (+)** or **(-)** button to tune in the desired station.

※ The frequency changes continuously when the button is held in.



- When the manual tuning mode is set, FM stereo broadcasts are received in monaural and the “STEREO” indicator turns off.

Preset stations

- 1** Use the “Auto tuning” or “Manual tuning” operation to tune in the station to be preset in the memory.
- 2** Press the **MEMORY** button.
- 3** Press the **SHIFT** button and select the desired memory block (A to G).
- 4** Press the **PRESET (+)** or **(-)** button to select the desired preset channel (1 to 8).
- 5** Press the **MEMORY** button again.
 - Store the station in the preset memory.



- To preset other channels, repeat steps 1 to 4.
A total of 56 broadcast stations can be preset — 8 stations (channels 1 to 8) in each of blocks A to G.

Recalling preset stations

- 1** Watching the display, press the **SHIFT** button to select the preset memory block.
- 2** Watching the display, press the **PRESET ▲ (+)** or **▼ (-)** button to select the desired preset channel.

Advanced Operation

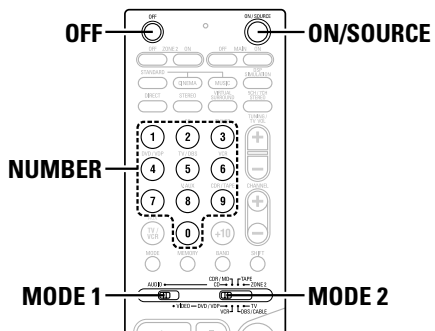

Remote control unit

Operating DENON audio components

1 Set the **MODE 1** switch to “AUDIO”.

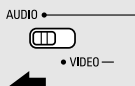

2 Set the **MODE 2** switch to the position for the component to be operated (CD, CDR/MD or TAPE).

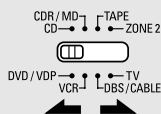

3 Operate the audio component.

- ※ For details, refer to the component’s operating instructions.
- ※ While this remote control is compatible with a wide range of infrared controlled components, it may be the case that some component models cannot be operated with this remote control.

1. CD player (CD), CD recorder and MD recorder (CDR/MD) system buttons

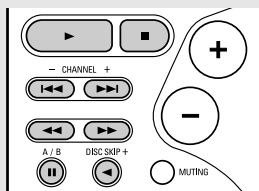

- ◀▶ : Manual search (forward and reverse)
- : Stop
- ▶ : Play
- ◀▶▶ : Auto search (cue)
- ⏸ : Pause
- DISC SKIP + : Switch discs (for CD changers only)

2. Tape deck (TAPE) system buttons

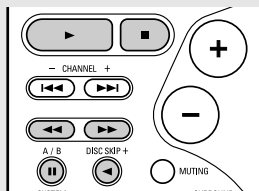

- ◀◀ : Rewind
- ▶▶ : Fast-forward
- : Stop
- ▶ : Forward play
- ◀ : Reverse play
- A/B : Switch between decks A and B

3. Tuner system buttons

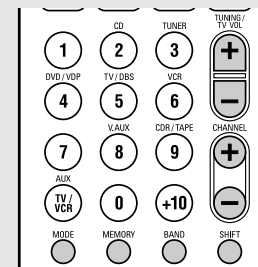

- SHIFT : Switch preset channel range
- CHANNEL +, - : Preset channel up/down
- TUNING +, - : Frequency up/down
- BAND : Switch between the AM and FM bands
- MODE : Switch between auto and mono
- MEMORY : Preset memory



• TUNER can be operated when the switch is at “AUDIO” position.

Advanced Operation

Preset memory

- DENON and other makes of components can be operated by setting the preset memory.
- This remote control unit can be used to operate components of other manufacturers without using the learning function by registering the manufacturer of the component as shown in the list of preset codes (End of this manual).
- Operation is not possible for some models.

1 Set the MODE 1 switch to “AUDIO” or “VIDEO”.

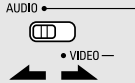

※ Set to the AUDIO side for the CD, TAPE or CDR/MD position, and to the VIDEO side for the DVD/VDP, DBS/CABLE, VCR or TV position.

2 Set the MODE 2 switch to the component to be registered.

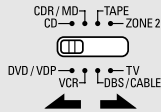

3 Press the ON/SOURCE and OFF button at the same time.

- The indicator starts flashing.

4 Referring to the included list of preset codes, press the NUMBER buttons to input the preset code (a 3-digit number) for the manufacturer of the component whose signals you want to store in the memory.

5 To store the codes of another component in the memory, repeat steps 1 to 4.



- The signals for the pressed buttons are emitted while setting the preset memory. To avoid accidental operation, cover the remote control unit's transmitting window while setting the preset memory.
- Depending on the model and year of manufacture, this function cannot be used for some models, even if they are of makes listed in the list of preset codes.
- Some manufacturers use more than one type of remote control code. Refer to the included list of preset codes to change the number and verify correct operation.
- The preset memory can be set for one component only among the following: CDR/MD, DVD/VDP and DBS/CABLE.

■ The preset codes are as follows upon shipment from the factory and after resetting:

- TV, VCR HITACHI
- CD, TAPE DENON
- CDR/MD DENON (CDR)
- DVD/VDP DENON (DVD)
- DBS/CABLE ABC (CABLE)

Advanced Operation

Operating a component stored in the preset memory

1 Set the MODE 1 switch to “AUDIO” or “VIDEO”.

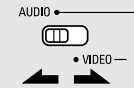

※ Set to the AUDIO side for the CD, TAPE or CDR/MD position, and to the VIDEO side for the DVD/VDP, DBS/CABLE, VCR or TV position.

2 Set the MODE 2 switch to the component you want to operate.

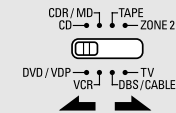

3 Operate the component.

- ※ For details, refer to the component's operating instructions.
- ※ Some models cannot be operated with this remote control unit.

1. Digital video disc player (DVD) system buttons

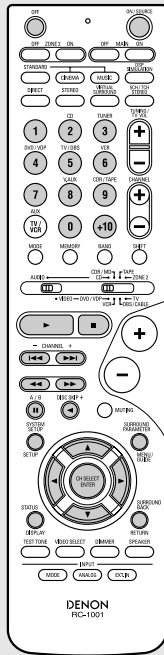

- ON/SOURCE** : Power on/standby
- OFF** : DENON DVD power off
- ◀▶** : Manual search (forward and reverse)
- : Stop
- ▶** : Play
- ◀◀▶▶** : Auto search (to beginning of track)
- ||** : Pause
- 0 ~ 9, +10** : Number
- DISC SKIP +** : Disc skip (for DVD changer only)
- DISPLAY** : Switch display
- MENU** : Menu
- RETURN** : Return
- SETUP** : Setup
- ▲, ▼, ◀, ▶** : Cursor up, down, left and right
- ENTER** : Enter setting

2. Video disc player (VDP) system buttons

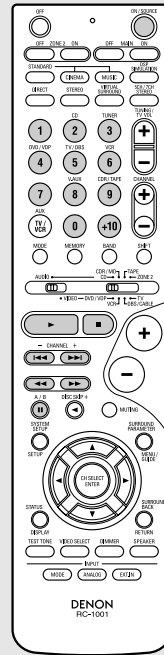

- ON/SOURCE** : Power on/standby
- ◀▶** : Manual search (forward and reverse)
- : Stop
- ▶** : Play
- ◀◀▶▶** : Auto search (cue)
- ||** : Pause
- 0 ~ 9, +10** : Number

3. Video deck (VCR) system buttons

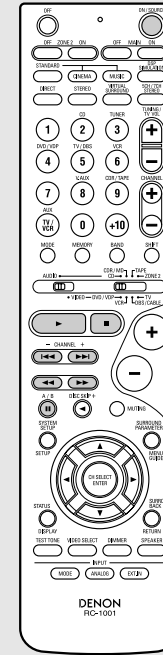

- ON/SOURCE** : Power on/standby
- ◀▶** : Manual search (forward and reverse)
- : Stop
- ▶** : Play
- ||** : Pause
- Channel +, -** : Channel up/down



- Some manufacturers use different names for the DVD remote control buttons, so also refer to the instructions on remote control for that component.

Advanced Operation

4. Digital broadcast satellite (DBS) tuner and cable (CABLE) system buttons

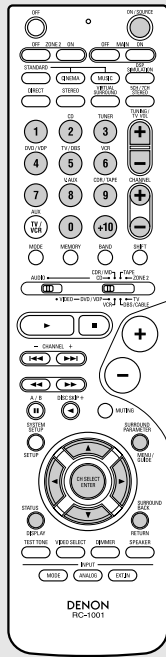

- ON/SOURCE** : Power on/standby
- MENU** : Menu
- RETURN** : Return
- ▲, ▼, ◀, ▶** : Cursor up, down, left and right
- ENTER** : Enter
- CHANNEL +, -** : Channel up/down
- 0 ~ 9, +10** : Channels
- DISPLAY** : Switch display
- VOL +, -** : Volume up/down

Advanced Operation

5. Monitor TV (TV) system buttons

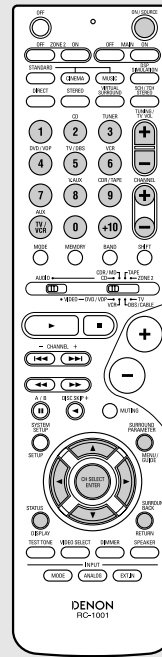

- ON/SOURCE** : Power on/standby
- MENU** : Menu
- RETURN** : Return
- ▲, ▼, ◀, ▶** : Cursor up, down, left and right
- ENTER** : Enter
- CHANNEL +, -** : Channel up/down
- 0 ~ 9, +10** : Channels
- DISPLAY** : Switch display
- TV/VCR** : Switch between TV and video player
- VOL +, -** : Volume up/down



- For CD, CDR, MD and TAPE components, the buttons can be operated in the same way as for DENON audio components (page 31).
- A TV can be operated when the switch is at the DVD/VDP, VCR, TV position.

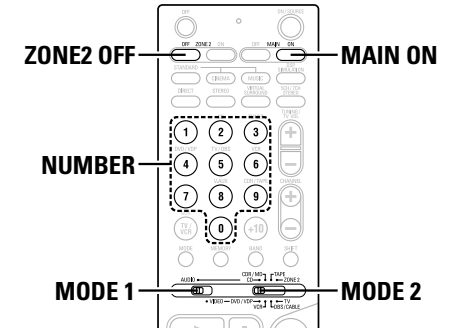

Punch through

“Punch Through” is a function allowing you to operate the **PLAY**, **STOP**, **MANUAL SEARCH** and **AUTO SEARCH** buttons on CD, TAPE, CDR/MD, DVD/VDP or VCR components when in the DBS/CABLE or TV mode. By default, nothing is set.

1 Set the **MODE 1** switch to “VIDEO”.

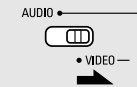

2 Set the **MODE 2** switch to the component to be registered (DBS/CABLE or TV).

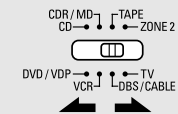

3 Press the **ZONE2 OFF** and **MAIN ON** buttons at the same time.

- The indicator starts flashing.

4 Input the number of the component you want to set.

	No.
CD	1
TAPE	2
CDR/MD	3
DVD/VDP	4
VCR	5
No setting	0

Multi zone music entertainment system

- ZONE2 speaker out can be used when "ZONE2" is selected at "Power Amp Assignment". In this case, surround back speaker out cannot be used for MAIN ZONE.
- When a sold separately room-to-room remote control unit (DENON RC-616, 617 or 618) is wired and connected between the MAIN ZONE and ZONE2, the remote-controllable devices in the MAIN ZONE can be controlled from ZONE2 using the remote control unit.



- For instructions on installation and operation of separately sold devices, refer to the devices' operating instructions.

■ When using the SURR.BACK/ZONE2 amplifier as the ZONE2

- To use the ZONE2, turn on the **ZONE2** button.
- The output of the ZONE2 SPEAKER OUT terminals can be adjusted with the remote control unit's **ZONE2 VOLUME** button.

[System configuration and connections example]

Using this unit's internal amplifier as the ZONE2.

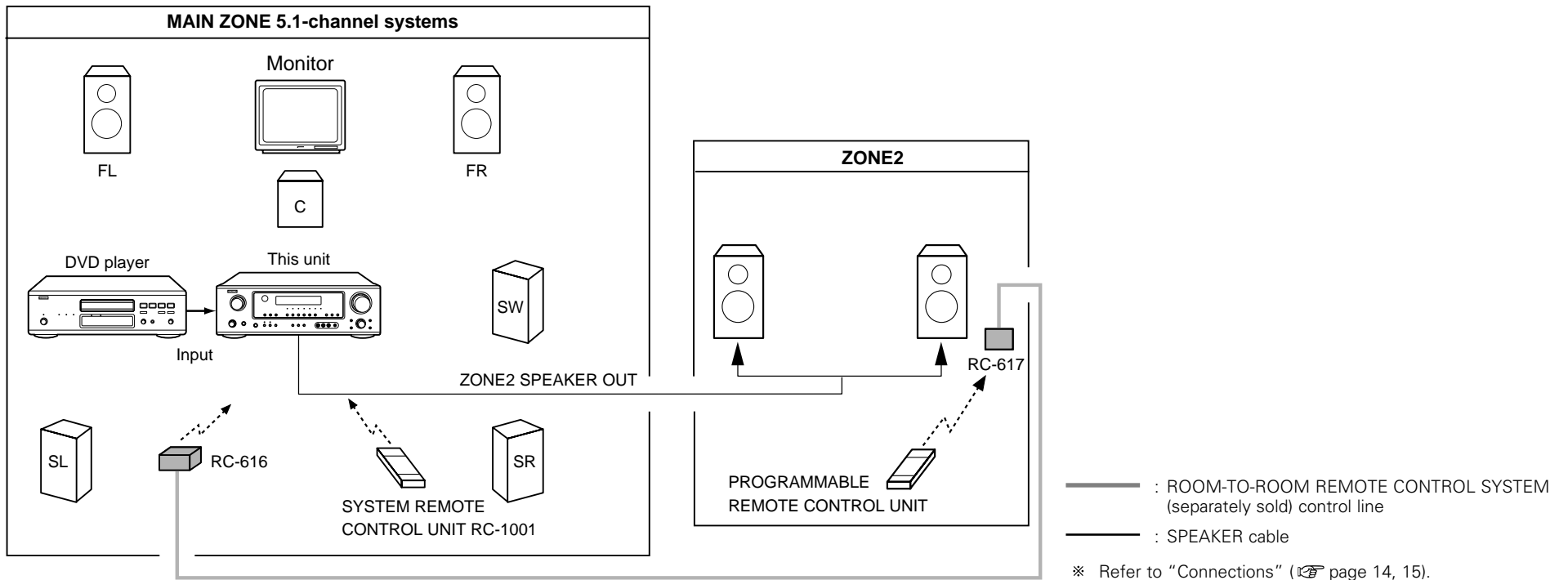

Advanced Operation

INPUT SELECTOR

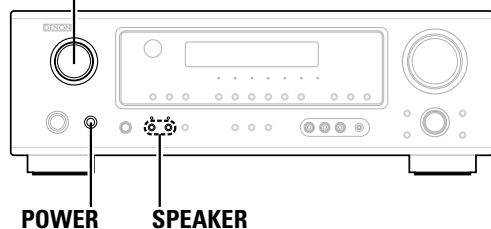

Other functions

Recording the program source (recording the source currently being monitored)

- 1** Select the input source to be played.
- 2** Select the input mode and play (surround) mode.
- 3** Start recording on the tape or video deck.

※ For instructions, refer to the component's operating instructions.



- The AUDIO IN's signal selected with the **INPUT SELECTOR** knob are output to the CDR/TAPE and VCR AUDIO OUT terminals.

■ Simultaneous recording

The signals of the source selected with the **INPUT SELECTOR** knob are output simultaneously to the CDR/TAPE and VCR REC OUT terminals. If a total of two tape and/or video decks are connected and set to the recording mode, the same source can be recorded simultaneously on every decks.

Last function memory

- This unit is equipped with a last function memory which stores the input and output setting conditions as they were immediately before the power is switched off. This function eliminates the need to perform complicated resettings when the power is switched on.
- The unit is also equipped with a back-up memory. This function provides approximately one week of memory storage when the main unit's **POWER** switch is off and the power supply cord disconnected.

Advanced Operation

Initialization of the microprocessor

If the indication on the display is not normal or if the operation of the unit is not correct, then the microprocessor should be reset by the following procedure.

- 1** Switch off the unit using the main unit's **POWER** switch.
- 2** Keep both **SPEAKER A** and **B** buttons depressed and turn on the unit by pressing the main unit's **POWER** switch.
- 3** Check that the entire display is flashing at 1-second intervals and release the buttons.
 - The microprocessor will be initialized.



- If step 3 does not work, start over from step 1.
- If the microprocessor has been reset, all the button settings are reset to the default values (the values set upon shipment from the factory).

Advanced Setup

Use System Setup to customize a variety of settings to suit your listening environment. For the contents of a system menu and the initial setting of this unit (page 44).

Front display

- You can change the settings using the buttons on the remote control unit.
- The AVR-686 is equipped with an alpha numeric front panel display that can also be used to check and adjust settings. Some representative front display examples are shown below.

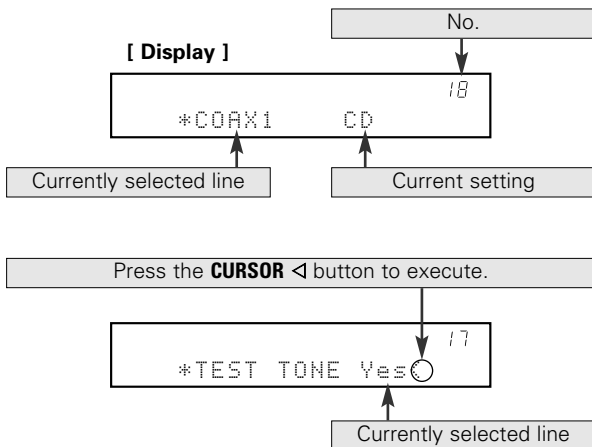
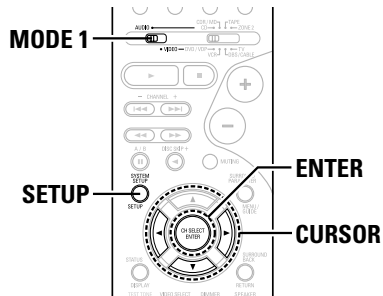

1 Set the **MODE 1** switch to “AUDIO”.

2 Press the **SETUP** button to enter the setting.

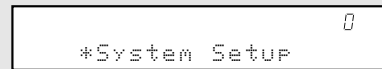

3 Press the **ENTER** or **CURSOR** ▾ button to select the setting, then press the **CURSOR** ◀ or ▶ button to select the parameter.



4 Press the **ENTER** or **CURSOR** ▾ button to confirm the new settings.



5 Press the **SETUP** button to finish system set up.

System Setup

Setting the Speaker Configuration

The composition of the signals output to each channel and the frequency response are adjusted automatically according to the combination of speakers actually being used.

1 Press the **CURSOR** ◀ or ▶ button to select your front speaker type, then press the **ENTER** or **CURSOR** ▾ button to switch to the center speaker setting.



2 Press the **CURSOR** ◀ or ▶ button to select your center speaker type, then press the **ENTER** or **CURSOR** ▾ button to switch to the surround speaker setting.



* When “Small” has been selected for the front speakers, “Large” cannot be selected for the center speaker.

3 Press the **CURSOR** ◀ or ▶ button to select your surround speaker type, then press the **ENTER** or **CURSOR** ▾ button to switch to the surround back speaker setting.



* When “Small” has been selected for the front speakers, “Large” cannot be selected for the surround speakers.

Advanced Setup

4 Press the **CURSOR** ◀ or ▶ button to select your surround back speaker type, then press the **ENTER** or **CURSOR** ▾ button to switch to the number of surround back speaker setting.



※ When "Small" has been selected for the surround speakers, "Large" cannot be selected for the surround back speakers.

5 Press the **CURSOR** ◀ or ▶ button to set the number of speakers to be used for the surround back channel, then press the **ENTER** or **CURSOR** ▾ button to switch to the subwoofer setting.



6 Press the **CURSOR** ◀ or ▶ button to select your subwoofer setting, then press the **ENTER** or **CURSOR** ▾ button to enter the settings and switch to the Delay Time setting.

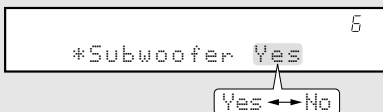

- Select "Large" or "Small" not according to the actual size of the speaker but according to the speaker's capacity for playing low frequency (bass sound below the frequency set for the Crossover Frequency) signals. If you are unsure, try comparing the sound at both settings (setting the volume to a level low enough so as not to damage the speakers) to determine the proper setting.

■ Parameters

Large:

Select this when using speakers that have sufficient ability to reproduce bass sound below the frequency set for the crossover frequency mode.

Small:

Select this when using speakers that do not have sufficient ability to reproduce bass sound below the frequency set for the crossover frequency mode. When this is set, bass sound with a frequency below the frequency set for the crossover frequency mode is sent to the subwoofer.

None:

Select this when no speakers are installed.

Yes / No:

Select "Yes" when a subwoofer is installed, "No" when a subwoofer is not installed.

2sp / 1sp:

Set the number of speakers to be used for the surround back channel.

※ If the subwoofer has sufficient low frequency playback capacity, good sound can be achieved even when "Small" is set for the front, center and surround speakers.

Advanced Setup

Setting the Delay Time

Input the distance between the listening position and each speaker to set the delay time for the surround playback.

Preparations:

Measure the distances between the listening position and the speakers.

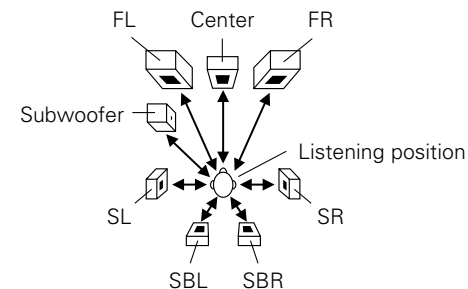

1 Press the **CURSOR** ◀ or ▶ button to set the distance from the front L speaker to the listening position, then press the **ENTER** or **CURSOR** ▾ button to switch to the front R speaker setting.

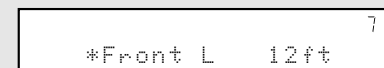

2 Press the **CURSOR** ◀ or ▶ button to set the distance from the front R speaker to the listening position, then press the **ENTER** or **CURSOR** ▾ button to switch to the center speaker setting.

3 Press the **CURSOR** ◀ or ▶ button to set the distance from the center speaker to the listening position, then press the **ENTER** or **CURSOR** ▾ button to switch to the surround L speakers setting.

4 Press the **CURSOR** ◀ or ▶ button to set the distance from the surround L speakers to the listening position, then press the **ENTER** or **CURSOR** ▾ button to switch to the surround R speaker setting.

Advanced Setup

5 Press the **CURSOR** ◀ or ▶ button to set the distance from the surround R speakers to the listening position, then press the **ENTER** or **CURSOR** ▾ button to switch to the surround back L speaker setting.

6 Press the **CURSOR** ◀ or ▶ button to set the distance from the surround back L speakers to the listening position, then press the **ENTER** or **CURSOR** ▾ button to switch to the surround back R speaker setting.

7 Press the **CURSOR** ◀ or ▶ button to set the distance from the surround back R speakers to the listening position, then press the **ENTER** or **CURSOR** ▾ button to switch to the subwoofer setting.

8 Press the **CURSOR** ◀ or ▶ button to set the distance from the subwoofer to the listening position, then press the **ENTER** or **CURSOR** ▾ button to enter the setting and switch to the Subwoofer Mode setting.



- The number changes in units of 1 foot each time one of the buttons is pressed. Select the value closest to the measured distance.
- **The difference in distance for the various speaker settings must not be greater than 20 ft.**

Setting the Subwoofer Mode and Crossover Frequency

Set the subwoofer mode and crossover frequency mode according to the speaker system being used.

1 Press the **CURSOR** ◀ or ▶ button to select the subwoofer mode, then press the **ENTER** or **CURSOR** ▾ button to enter the setting and switch to the crossover frequency setting.



2 Press the **CURSOR** ◀ or ▶ button to select the crossover frequency, then press the **ENTER** or **CURSOR** ▾ button to enter the setting and switch to the Test Tone setting.

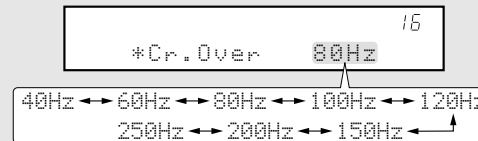

Assignment of low frequency signal range

The signals produced from the subwoofer channel are LFE signals (during playback of Dolby Digital or DTS signals) and the low frequency signal range of channels set to "SMALL" in the setup. The low frequency signal range of channels set to "LARGE" are produced from those channels.

Advanced Setup

■ Crossover Frequency

- When "Subwoofer" is set to "Yes" at the "Speaker Configuration" setting, set the frequency (Hz) below which the bass sound of the various speakers is to be output from the subwoofer (the crossover frequency).
- For speakers set to "Small", sound with a frequency below the crossover frequency is cut, and the cut bass sound is output from the subwoofer instead.
- (When "Subwoofer" is set to "No", the bass sound is output from the speakers set as "Large".)

NOTE:

- For ordinary speaker systems, we recommend setting the crossover frequency to 80 Hz. When using small speakers, however, setting the crossover frequency to a higher frequency may improve frequency response for frequencies near the crossover frequency.

■ Subwoofer Mode

- The subwoofer mode setting is only valid when "Large" is set for the front speakers and "Yes" is set for the subwoofer in "Setting the Speaker Configuration" (🔧 page 38, 39).
- When the "LFE+MAIN" playback mode is selected, the low frequency signal range of channels set to "Large" is produced simultaneously from those channels and the subwoofer channel. In this playback mode, the low frequency range expands more uniformly through the room, but depending on the size and shape of the room, interference may result in a decrease of the actual volume of the low frequency range.
- Selection of the "LFE" play mode will play the low frequency signal range of the channel selected with "Large" from that channel only. Therefore, the low frequency signal range that is played from the subwoofer channel is only the low frequency signal range of LFE (only during Dolby Digital or DTS signal playback) and the channels specified as "Small" in the setup menu.
- Select the play mode that offers the fullest bass.
- When the subwoofer is set to "Yes", bass sound is output from the subwoofer regardless of the subwoofer mode setting in surround modes other than Dolby/DTS.
- In surround modes other than Dolby Digital and DTS, if the subwoofer is set to "Yes", the low frequency portion is always output to the subwoofer channel. For details, refer to "Surround modes and parameters" (🔧 page 51).

Advanced Setup

Setting the Test Tone

- Use this setting to adjust to that the playback level between the different channel is equal.
- From the listening position, listen to the test tones produced from the speakers to adjust the level.
- The level can also be adjusted directly from the remote control unit.

- 1 Press the **CURSOR** ◀ button to switch the test tone mode.
 • Press the **ENTER** or **CURSOR** ▾ button to switch to the digital input (COAXIAL) setting.

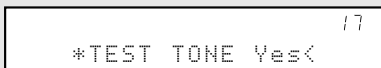

- 2 Press the **CURSOR** ◀ or ▶ button to select the test tone mode, then press the **CURSOR** ▾ button to start test tone.



Auto:
Adjust the level while listening to the test tones produced automatically from the different speakers.

Manual:
Select the speaker from which you want to produce the test tone to adjust the level.

- 3 Press the **CURSOR** ◀ or ▶ button to set the front L channel level, then press the **CURSOR** ▾ button to switch to the center channel level (manual mode).

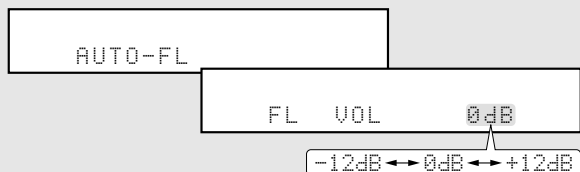

- 4 Press the **CURSOR** ◀ or ▶ button to set the center channel level, then press the **CURSOR** ▾ button to switch to the front R channel level (manual mode).

- 5 Press the **CURSOR** ◀ or ▶ button to set the front R channel level, then press the **CURSOR** ▾ button to switch to the surround R channel level (manual mode).

- 6 Press the **CURSOR** ◀ or ▶ button to set the surround R channel level, then press the **CURSOR** ▾ button to switch to the surround back R channel level (manual mode).

- 7 Press the **CURSOR** ◀ or ▶ button to set the surround back R channel level, then press the **CURSOR** ▾ button to switch to the surround back L channel level (manual mode).

- 8 Press the **CURSOR** ◀ or ▶ button to set the surround back L channel level, then press the **CURSOR** ▾ button to switch to the surround L channel level (manual mode).

- 9 Press the **CURSOR** ◀ or ▶ button to set the surround L channel level, then press the **CURSOR** ▾ button to switch to the subwoofer channel level (manual mode).

- 10 Press the **CURSOR** ◀ or ▶ button to set the subwoofer channel level, then press the **ENTER** button to finish the test tone.

- 11 Press the **ENTER** or **CURSOR** ▾ button to switch the Digital In Assignment (COAXIAL) setting.



- When adjusting the level of an active subwoofer system, you may also need to adjust the subwoofer's own volume control.
- When you adjust the channel levels while in the system setup channel level mode, the channel level adjustments made will affect all surround modes. Consider this mode a master channel level adjustment mode.
- After you have completed the system setup channel level adjustments, you can then activate the individual surround modes and adjust channel levels that will be remembered for each of those modes. Then, whenever you activate a particular surround sound mode, your preferred channel level adjustments for just that mode will be recalled. Check the instructions for adjusting channel levels within each surround mode (page 28).

■ Adjusting the test tone

- Before playing with the surround function, be sure to use the test tones to adjust the playback level from the different speakers. This adjustment can be performed with the system setup or from the remote control unit, as described below.
- Adjusting with the remote control unit using the test tones is only possible in the "Auto" mode and only effective in the STANDARD (DOLBY/DTS SURROUND) modes. The adjusted levels for the different modes are automatically stored in the memory.

- 1 Press the **STANDARD** button to select the STANDARD (DOLBY/DTS SURROUND) modes.

- 2 Press the **TEST TONE** button.
 - Test tones are output from the different speakers.

- 3 Press the **CURSOR** ◀ or ▶ button to adjust so that the volume of the test tones is the same for all the speakers.

- 4 After completing the adjustment, press the **TEST TONE** button again.

Advanced Setup

Setting the Digital In Assignment

This setting assigns the digital input terminals of the AVR-686 for the different input sources.

- 1 Press the **CURSOR** ◀ or ▶ button to assign the input function connected to the **COAXIAL 1** input terminal, then press the **ENTER** or **CURSOR** ▽ button to switch the **COAXIAL 2** input setting.

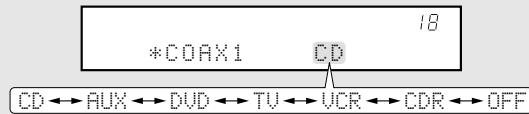

- 2 Press the **CURSOR** ◀ or ▶ button to assign the input function connected to the **COAXIAL 2** input terminal, then press the **ENTER** or **CURSOR** ▽ button to switch the **OPTICAL 1** input setting.

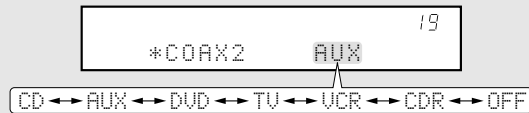

- 3 Press the **CURSOR** ◀ or ▶ button to assign the input function connected to the **OPTICAL 1** input terminal, then press the **ENTER** or **CURSOR** ▽ button to switch the **OPTICAL 2** input setting.

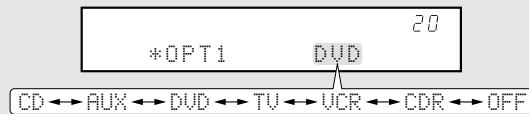

- 4 Press the **CURSOR** ◀ or ▶ button to assign the input function connected to the **OPTICAL 2** input terminal, then press the **ENTER** or **CURSOR** ▽ button to switch the **Video Input Mode** setting.

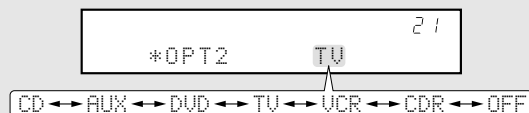

- Select "OFF" if nothing is connected.
- "TUNER" and "V. AUX" cannot be selected.

Setting the Video Input Mode

Select the input signal to be output to the composite S-Video and component monitor output terminals using the video conversion function.

- 1 Press the **CURSOR** ◀ or ▶ button to select the video input mode, then press the **ENTER** or **CURSOR** ▽ button to switch the input source (**TV**) setting.



- 2 Press the **CURSOR** ◀ or ▶ button to select the video input mode, then press the **ENTER** or **CURSOR** ▽ button to switch the input source (**VCR**) setting.

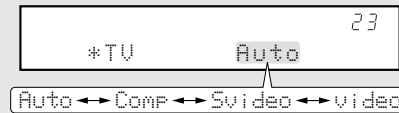

- 3 Press the **CURSOR** ◀ or ▶ button to select the video input mode, then press the **ENTER** or **CURSOR** ▽ button to switch the **Audio Delay** setting.

**Auto:**

When there are multiple input signals, the input signals are detected and the input signal to be output from the video monitor output terminal is selected automatically in the following order: component video, S-Video, composite video.

Component:

The signal connected to the component video terminal is always played.

Video conversion is not conducted, so no image is output from the monitor output terminal when there is no input signal to the component terminal.

S-Video:

The signal connected to the S-Video terminal is always played. The S-Video input signal is converted and output from the composite and component monitor output terminal.

Video:

The signal connected to the composite video terminal is always played. The composite video input signal is up-converted and output from the S-Video and component monitor output terminals.



- Down-converting from the component video signal to the S-Video and composite video signal is not possible, so when not using the component video monitor output terminal connect the player using the S-Video or composite video input terminal (ⓘ page 11).

Advanced Setup

Setting the Audio Delay

- When watching a DVD or other video source, the picture on the monitor may seem delayed with respect to the sound. In this case, adjust the audio delay to delay the sound and synchronize it with the picture.
- The audio delay setting is stored separately for each input source.

Press the **CURSOR** ◀ or ▶ button to set the delay time, then press the **ENTER** or **CURSOR** ▾ button to switch the Auto Surround Mode setting.

※ With a movie source, for example, adjust so that the movement of the actors' lips is synchronized with the sound.

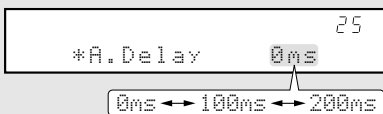

- The audio delay setting does not apply when playing in the EXT. IN mode or in the analog input direct mode or stereo mode.
- By default, this menu is not displayed when no digital signals are being input.

Setting the Auto Surround Mode

The surround mode used last for the three types of input signals shown below is stored in the memory, and the signal is automatically played with that surround mode the next time it is input.

Note that the surround mode setting is also stored separately for the different input sources.

- ① Analog and PCM 2-channel signals (STEREO)
- ② 2-channel signals in the Dolby Digital, DTS or another multi-channel format (DOLBY PLIIx Cinema)
- ③ Multi-channel signals in the Dolby Digital, DTS or another multi-channel format (DOLBY/DTS SURROUND)

※ Default settings are indicated in ().

Press the **CURSOR** ◀ or ▶ button to select the Auto Surround mode, then press the **ENTER** or **CURSOR** ▾ button to switch the Ext. In Subwoofer Level setting.

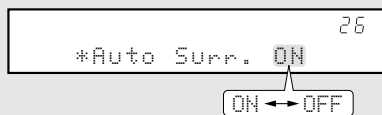

Advanced Setup

Setting the Ext. In Subwoofer Level

Set the method of playback of the analog input signal connected to the EXT. IN terminal.

Press the **CURSOR** ◀ or ▶ button to select the ext. in subwoofer channel level playback, then press the **ENTER** or **CURSOR** ▾ button to switch the Power Amp Assignment setting.



Setting the Power Amp Assignment

Make this setting to switch the power amplifier for the surround back channel to ZONE2.

Power Amp Assign.	SPEAKER OUT	
	MAIN ZONE	ZONE2
Surround back	7.1ch system	-
ZONE2	5.1ch system	2ch system

Press the **CURSOR** ◀ or ▶ button to select "S. Back" or "ZONE2", then press the **ENTER** or **CURSOR** ▾ button if you want to start the settings over from the beginning.

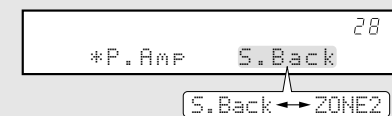

System setup items and default values (set upon shipment from the factory)

System Setup		Default settings					Page		
1	Auto Setup	Set this to switch the surround back channel's power amplifier for ZONE2 use.		Surround Back			8~10		
2	Speaker Configuration	Input the combination of speakers in your system and their corresponding sizes (SMALL for regular speakers, LARGE for full-size, full-range) to automatically set the composition of the signals output from the speakers and the frequency response.		Front Sp.	Center Sp.	Subwoofer	Surround Sp.	Surround Back Sp.	38, 39
		Large	Small	Yes	Small	Small / 2sp			
3	Delay Time	This parameter is for optimizing the timing with which the audio signals are produced from the speakers and subwoofer according to the listening position.		Front L & R	Center	Subwoofer	Surround L & R	Surround Back L & R	39, 40
		12 ft	12 ft	12 ft	10 ft	10 ft			
4	Subwoofer Mode	This selects the subwoofer speaker for playing deep bass signals.		Subwoofer mode = Normal					40
5	Crossover Frequency	Sets the frequency (Hz) below which the bass sound of the various speakers is to be output from the subwoofer.		80 Hz					40
6	Test Tone	This adjusts the volume of the signals output from the speakers and subwoofer for the different channels in order to obtain optimum effects.		Front L & R	Center	Subwoofer	Surround L & R	Surround Back L & R	41
		0 dB	0 dB	0 dB	0 dB	0 dB			
7	Digital In Assignment	This assigns the digital input terminals for the different input sources.		Input source	CD	AUX	DVD / VDP	TV / DBS	42
				Digital Inputs	COAXIAL1	COAXIAL2	OPTICAL1	OPTICAL2	
8	Video Input Mode	Sets the input signal to be output from the monitor output terminal.		AUTO					42
9	Audio Delay	Sets the audio delay to delay the sound and synchronize it with the picture.		0 ms					43
10	Auto Surround Mode	Auto surround mode function setting.		Auto Surround Mode = ON					43
11	Ext. In SW Level	Sets the Ext. In Subwoofer channel playback level.		Ext. In SW Level = +15 dB					43
12	Power Amp Assignment	Sets this to switch the surround back channel's power amplifier for ZONE2 use.		Surround Back					43

Troubleshooting

If a problem should arise, first check the following.

1. Are the connections correct?
2. Have you operated the receiver according to the operating instructions?
3. Are the speakers, turntable and other components operating properly?

If this unit is not operating properly, check the items listed in the table below. Should the problem persist, there may be a malfunction. Disconnect the power immediately and contact your store of purchase.





Symptom	Cause	Measures	Page
Display not lit and sound not produced when POWER switch set to on.	• Power supply cord not plugged in securely.	• Check the insertion of the power supply cord plug.	15
		• Turn the power on with the remote control unit after turning the POWER switch on.	8
Display lit but sound not produced.	• Speaker cables not securely connected. • Improper setting of the INPUT SELECTOR knob. • Volume control set to minimum. • MUTING is on. • Digital signals not input. Digital input selected.	• Connect securely.	6
		• Set to a suitable position.	16
		• Turn volume up to suitable level.	16
		• Switch off MUTING.	16
Display not lit and power indicator is flashing rapidly.	• Speaker terminals are short-circuited. • The ventilation holes of the set are blocked. • The unit is operating at continuous high power conditions and/or with inadequate ventilation.	• Input digital signals or select input terminals to which digital signals are being input.	18
		• Switch power off, connect speakers properly, then switch power back on.	5, 6
		• Turn off the set's power, then ventilate it well and allow it to cool down. Once the set has cooled down, turn the power back on.	2, 5
Sound produced only from one channel.	• Incomplete connection of speaker cables. • Incomplete connection of input/output cables.	• Turn off the set's power, then ventilate it well and allow it to cool down. Once the set has cooled down, turn the power back on.	2, 5
		• Connect securely.	5, 6
Positions of instruments reversed during stereo playback.	• Reverse connections of left and right speakers or left and right input/output cables.	• Connect securely.	5-7, 11-15
		• Connect securely.	5, 6
Howling noise produced when volume is high.	• Speaker systems too close together. • Floor is unstable and vibrates easily.	• Check left and right connections.	6
		• Separate as much as possible. • Use cushions to absorb speaker vibrations transmitted by floor.	—

Symptom	Cause	Measures	Page
Sound is distorted.	• Stylus pressure too weak. • Dust or dirt on stylus.	• Apply proper stylus pressure.	—
		• Check stylus.	—
This unit does not operate properly when remote control unit is used.	• Batteries dead. • Remote control unit too far from this unit. • Obstacle between this unit and remote control unit. • Different button is being pressed. • ⊕ and ⊖ ends of batteries inserted in reverse.	• Replace with new batteries.	3
		• Move closer.	3
		• Remove obstacle.	3
		• Press the proper button.	—
		• Insert batteries properly.	3

NOTE:

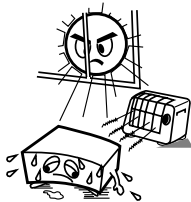
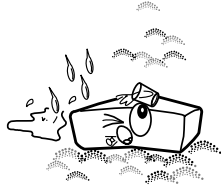
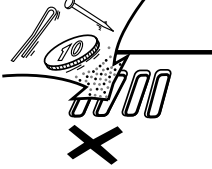
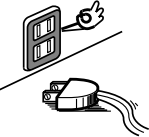
• For ordinary speaker systems, we recommend setting the crossover frequency to 80 Hz. When using small speakers, however, setting the crossover frequency to a high frequency may improve frequency response for frequencies near the crossover frequency.

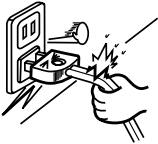
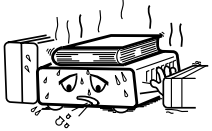
NOTE ON USE

 Avoid high temperatures. Allow for sufficient heat dispersion when installed in a rack.	 Keep the apparatus free from moisture, water, and dust.	 Do not let foreign objects into the apparatus.
	 Unplug the power cord when not using the apparatus for long periods of time.	 Do not let insecticides, benzene, and thinner come in contact with the apparatus.
 Handle the power cord carefully. Hold the plug when unplugging the cord.	 * (For apparatuses with ventilation holes) Do not obstruct the ventilation holes.	 Never disassemble or modify the apparatus in any way.

Additional Information

Optimum surround sound for different sources

There are currently various types of multi-channel signals (signals or formats with more than two channels).

Types of multi-channel signals

Dolby Digital, Dolby Pro Logic, DTS, high definition 3-1 signals (Japan MUSE Hi-Vision audio), DVD-Audio, Super Audio CD, MPEG multi-channel audio, etc.

“Source” here does not refer to the type of signal (format) but the recorded content. Sources can be divided into two major categories.

Types of sources

Movie audio:

Signals created to be played in movie theaters. In general sound is recorded to be played in movie theaters equipped with multiple surround speakers, regardless of the format (Dolby Digital, DTS, etc.).

Movie theater sound field

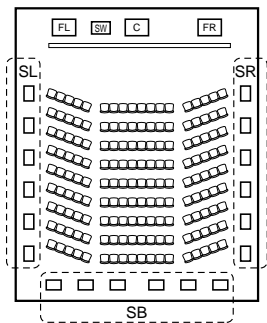

Multiple surround speakers (For 6.1-channel system)

Listening room sound field

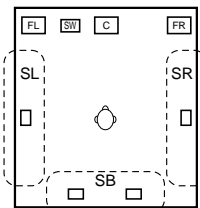

In this case it is important to achieve the same sense of expansion as in a movie theater with the surround channels. To do so, in some cases the number of surround speakers is increased (to four or eight) or speakers with bipolar or dipolar properties are used.

- SL : Surround L channel
- SR : Surround R channel
- SB : Surround back channel (1 speaker or 2 speakers)

Other types of audio:

These signals are designed to recreate a 360° sound field using three to five speakers.

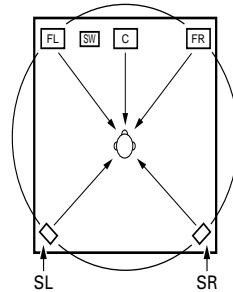

In this case the speakers should surround the listener from all sides to create a uniform sound field from 360°. Ideally the surround speakers should function as “point” sound sources in the same way as the front speakers.

These two types of sources thus have different properties, and different speaker settings, particularly for the surround speakers, are required in order to achieve the ideal sound.

Additional Information

Surround back speakers

A 6.1-channel system is a conventional 5.1-channel system to which the “surround back” (SB) channel has been added. This makes it easy to achieve sound positioned directly behind the listener, something that was previously difficult with sources designed for conventional multi surround speakers. In addition, the acoustic image extending between the sides and the rear is narrowed, thus greatly improving the expression of the surround signals for sounds moving from the sides to the back and from the front to the point directly behind the listening position.

Change of positioning and acoustic image with 5.1-channel systems

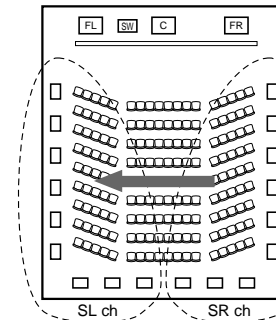

Movement of acoustic image from SR to SL

Change of positioning and acoustic image with 6.1-channel systems

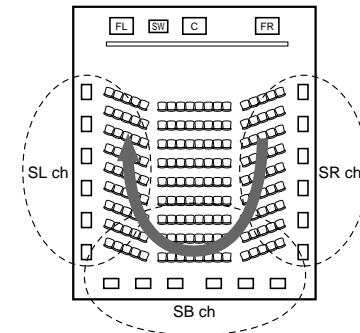

Movement of acoustic image from SR to SB to SL

Additional Information

With this set, speaker(s) for 1 or 2 channels are required to achieve a 6.1-channel system (DTS-ES, etc.). Adding these speakers, however, increases the surround effect not only with sources recorded in 6.1 channels but also with conventional 2- to 5.1-channel sources. Furthermore, all the DENON original surround modes (page 25) are compatible with 7.1-channel playback, so you can enjoy 7.1-channel sound with any signal source.

Number of surround back speakers

Though the surround back channel only consists of 1 channel of playback signals for 6.1-channel sources (DTS-ES, etc.), we recommend using two speakers. When using speakers with dipolar characteristics in particular, it is essential to use two speakers.

Using two speakers results in a smoother blend with the sound of the surround channels and better sound positioning of the surround back channel when listening from a position other than the center.

Placement of the surround left and right channels when using surround back speakers

Using surround back speakers greatly improves the positioning of the sound at the rear. Because of this, the surround left and right channels play an important role in achieving a smooth transition of the acoustic image from the front to the back. As shown in the diagram above, in a movie theater the surround signals are also produced from diagonally in front of the listeners, creating an acoustic image as if the sound were floating in space. To achieve these effects, we recommend placing the speakers for the surround left and right channels slightly more towards the front than with conventional surround systems. Doing so sometimes increases the surround effect when playing conventional 5.1-channel sources in the 6.1 surround or DTS-ES Matrix 6.1 mode. Check the surround effects of the various modes before selecting the surround mode.

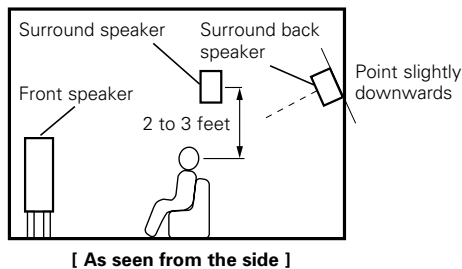
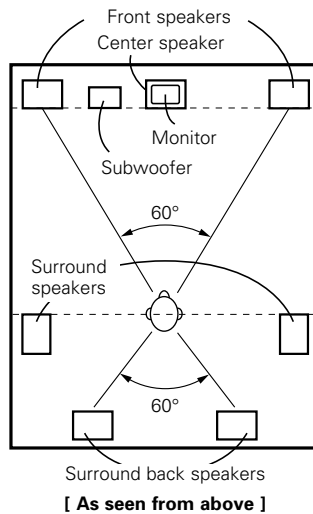

- Set the front speakers with their front surfaces as flush with the TV or monitor screen as possible. Set the center speaker between the front left and right speakers and no further from the listening position than the front speakers.
- Consult the owner's manual for your subwoofer for advice on placing the subwoofer within the listening room.
- If the surround speakers are direct-radiating (monopolar), then place them slightly behind and at an angle to the listening position and parallel to the walls at a position 2 to 3 feet above ear level at the prime listening position.
- When using two surround back speakers, place them at the back facing the front at a narrower distance than the front left and right speakers. When using one surround back speaker, place it at the rear center facing the front at a slightly higher position 0 to 0.7 feet than the surround speakers.
- We recommend installing the surround back speaker(s) at a slightly downward facing angle. This effectively prevents the surround back channel signals from reflecting off the monitor or screen at the front center, resulting in interference and making the sense of movement from the front to the back less sharp.

Additional Information

② Setting for primarily watching movies using diffusion type speakers for the surround speakers

For the greatest sense of surround sound envelopment, diffuse radiation speakers such as bipolar types, or dipolar types, provide a wider dispersion than is possible to obtain from a direct radiating speaker (monopolar). Place these speakers at either side of the prime listening position, mounted above ear level.

Path of the surround sound from the speakers to the listening position

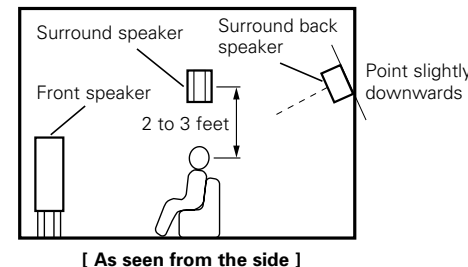
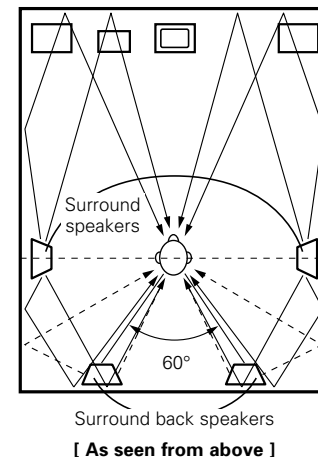

- Set the front speakers, center speaker and subwoofer in the same positions as in example (1).
- It is best to place the surround speakers directly at the side or slightly to the front of the viewing position, and 2 to 3 feet above the ears.
- Same as surround back speaker installation method (1). Using dipolar speakers for the surround back speakers as well is more effective.
- The signals from the surround channels reflect off the walls as shown in the diagram above, creating an enveloping and realistic surround sound presentation.

Additional Information

[2] When not using surround back speakers

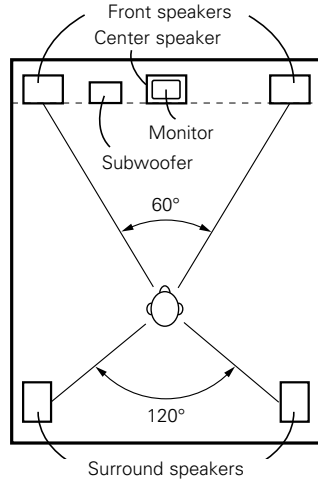

[As seen from above]

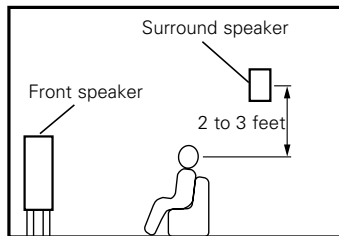

[As seen from the side]

- Set the front speakers with their front surfaces as flush with the TV or monitor screen as possible. Set the center speaker between the front left and right speakers and no further from the listening position than the front speakers.
- Consult the owner's manual for your subwoofer for advice on placing the subwoofer within the listening room.
- If the surround speakers are direct-radiating (monopolar), then place them slightly behind and at an angle to the listening position and parallel to the walls at a position 2 to 3 feet above ear level at the prime listening position.

Surround

The AVR-686 is equipped with a digital signal processing circuit that lets you play program sources in the surround mode to achieve the same sense of presence as in a movie theater.

[1] Dolby Surround

① Dolby Digital

Dolby Digital is the multi-channel digital signal format developed by Dolby Laboratories. Dolby Digital consists of up to "5.1" channels – front left, front right, center, surround left, surround right, and an additional channel exclusively reserved for additional deep bass sound effects (the Low Frequency Effects –LFE– channel, also called the ".1" channel, containing bass frequencies of up to 120 Hz). Unlike the analog Dolby Pro Logic format, Dolby Digital's main channels can all contain full range sound information, from the lowest bass, up to the highest frequencies – 22 kHz. The signals within each channel are distinct from the others, allowing pinpoint sound imaging, and Dolby Digital offers tremendous dynamic range from the most powerful sound effects to the quietest, softest sounds, free from noise and distortion.

■ Dolby Digital and Dolby Pro Logic

Comparison of home surround systems	Dolby Digital	Dolby Pro Logic
No. of recorded channels (elements)	5.1 ch	2 ch
No. of playback channels	5.1 ch	4 ch
Playback channels (max.)	L, R, C, SL, SR, SW	L, R, C, S (SW – recommended)
Audio processing	Digital discrete processing Dolby Digital encoding / decoding	Analog matrix processing Dolby Surround
High frequency playback limit of surround channel	20 kHz	7 kHz

Additional Information

■ Dolby Digital compatible media and playback methods

Symbol indicating Dolby Digital compatibility: DIGITAL

The following are general examples. Also refer to the player's operating instructions.

Media	Dolby Digital output terminals	Playback method (reference page)
LD (VDP)	Coaxial Dolby Digital RF output terminal ※ 1	Set the input mode to "AUTO" (☞ page 17, 18).
DVD	Optical or coaxial digital output (same as for PCM) ※ 2	Set the input mode to "AUTO" (☞ page 17, 18).
Others (satellite broadcasts, CATV, etc.)	Optical or coaxial digital output (same as for PCM)	Set the input mode to "AUTO" (☞ page 17, 18).

- ※ 1: Please use a commercially available adapter when connecting the Dolby Digital RF output terminal of the LD player to the digital input terminal. Please refer to the instruction manual of the adapter when making connection.
- ※ 2: Some DVD digital outputs have the function of switching the Dolby Digital signal output method between "bit stream" and "(convert to) PCM". When playing in Dolby Digital surround on the AVR-686, switch the DVD player's output mode to "bit stream". In some cases players are equipped with both "bit stream + PCM" and "PCM only" digital outputs. In this case connect the "bit stream + PCM" terminals to the AVR-686.

② Dolby Pro Logic II

- Dolby Pro Logic II is a new multi-channel playback format developed by Dolby Laboratories using feedback logic steering technology and offering improvements over conventional Dolby Pro Logic circuits.
- Dolby Pro Logic II can be used to decode not only sources recorded in Dolby Surround (※) but also regular stereo sources into five channels (front left, front right, center, surround left and surround right) to achieve surround sound.

Additional Information

- Whereas with conventional Dolby Pro Logic the surround channel playback frequency band was limited, Dolby Pro Logic **II** offers a wider band range (20 Hz to 20 kHz or greater). In addition, the surround channels were monaural (the surround left and right channels were the same) with previous Dolby Pro Logic, but with Dolby Pro Logic **II** they are played as stereo signals.
- Various parameters can be set according to the type of source and the contents, so it is possible to achieve optimum decoding (🔧 page 51).

③ Dolby Pro Logic IIx

Dolby Pro Logic **IIx** furthers the matrix decoding technology of Dolby Pro Logic **II** to decode audio signals recorded on two channels into up to 7.1 playback channels, including the surround back channel. Dolby Pro Logic **IIx** also allows 5.1-channel sources to be played in up to 7.1 channels. The mode can be selected according to the source. The Music mode is best suited for playing music, the Cinema mode for playing movies, and the Game mode for playing games. The Game mode can only be used with 2-channel audio sources.

※ Sources recorded in Dolby Surround

- These are sources in which three or more channels of surround have been recorded as two channels of signals using Dolby Surround encoding technology.
- Dolby Surround is used for the sound tracks of movies recorded on DVDs, LDs and video cassette tapes, as well as for stereo broadcast signals from FM radio, TV, satellite broadcasts and cable TV.
- Decoding these signals with Dolby Pro Logic **II** makes it possible to achieve multi-channel surround playback. The signals can also be played on ordinary stereo equipment, in which case they provide normal stereo sound.
- There are two types of DVD Dolby surround recording signals.
 - ① 2-channel PCM stereo signals
 - ② 2-channel Dolby Digital signals
- When either of these signals is input to the AVR-686, the surround mode is automatically set to Dolby Pro Logic **II** when the DOLBY/DTS SURROUND mode is selected.

■ Sources recorded in Dolby Surround are indicated with the logo symbol shown below

Dolby Surround logo symbol: 

Manufactured under license from Dolby Laboratories. "Dolby", "Pro Logic" and the double-D symbol are trademarks of Dolby Laboratories.

[2] DTS Digital Surround

Digital Theater Surround (also called simply DTS) is a multi-channel digital signal format developed by Digital Theater Systems.

DTS offers the same "5.1" playback channels as Dolby Digital (front left, front right, center, surround left and surround right) as well as the stereo 2-channel mode. The signals for the different channels are fully independent, eliminating the risk of deterioration of sound quality due to interference between signals, crosstalk, etc.

DTS features a relatively higher bit rate as compared to Dolby Digital (1234 kbps for CDs and LDs, 1536 kbps for DVDs) so it operates with a relatively low compression rate. Because of this the amount of data is great, and when DTS playback is used in movie theaters, a separate CD-ROM synchronized with the film is played.

With LDs and DVDs, there is of course no need for an extra disc; the pictures and sound can be recorded simultaneously on the same disc, so the discs can be handled in the same way as discs with other formats.

There are also music CDs recorded in DTS. These CDs include 5.1-channel surround signals (compared to two channels on current CDs). They do not include picture data, but they offer surround playback on CD players that are equipped with digital outputs (PCM type digital output required).

DTS surround track playback offers the same intricate, grand sound as in a movie theater, right in your own listening room.

■ DTS compatible media and playback methods

Symbols indicating DTS compatibility:  and 

The following are general examples. Also refer to the player's operating instructions.

MANUFACTURED UNDER LICENSE FROM DIGITAL THEATER SYSTEMS, INC.
 U.S. PAT. NO'S. 5,451,942; 5,956,674; 5,974,380; 5,978,762; 6,226,616; 6,487,535 AND OTHER U.S. AND WORLDWIDE PATENTS ISSUED AND PENDING.
 "DTS", "DTS-ES", "Neo:6", AND "DTS 96/24" ARE TRADEMARKS OF DIGITAL THEATER SYSTEMS, INC. © 1996, 2003 DIGITAL THEATER SYSTEMS, INC. ALL RIGHTS RESERVED.

Additional Information

Media	Dolby Digital output terminals	Playback method (reference page)
CD	Optical or coaxial digital output (same as for PCM) ※ 2	Set the input mode to "AUTO" or "DTS" (🔧 page 17, 18). Never set the mode to "ANALOG" or "PCM". ※ 1
LD (VDP)	Optical or coaxial digital output (same as for PCM) ※ 2	Set the input mode to "AUTO" or "DTS" (🔧 page 17, 18). Never set the mode to "ANALOG" or "PCM". ※ 1
DVD	Optical or coaxial digital output (same as for PCM) ※ 3	Set the input mode to "AUTO" or "DTS" (🔧 page 17, 18).

- ※ 1: DTS signals are recorded in the same way on CDs and LDs as PCM signals. Because of this, the un-decoded DTS signals are output as random "hissing" noise from the CD or LD player's analog outputs. If this noise is played with the amplifier set at a very high volume, it may possibly cause damage to the speakers. To avoid this, be sure to switch the input mode to "AUTO" or "DTS" before playing CDs or LDs recorded in DTS. Also, never switch the input mode to "ANALOG" or "PCM" during playback. The same holds true when playing CDs or LDs on a DVD player or LD/DVD compatible player. For DVDs, the DTS signals are recorded in a special way so this problem does not occur.
- ※ 2: The signals provided at the digital outputs of a CD or LD player may undergo some sort of internal signal processing (output level adjustment, sampling frequency conversion, etc.). In this case the DTS-encoded signals may be processed erroneously, in which case they cannot be decoded by the AVR-686, or may only produce noise. Before playing DTS signals for the first time, turn down the master volume to a low level, start playing the DTS disc, then check whether the DTS indicator on the AVR-686 (🔧 page 23) lights before turning up the master volume.
- ※ 3: A DVD player with DTS-compatible digital output is required to play DTS DVDs. A DTS Digital Output logo is featured on the front panel of compatible DVD players. Recent DENON DVD player models feature DTS-compatible digital output – consult the player's owner's manual for information on configuring the digital output for DTS playback of DTS-encoded DVDs.

Additional Information

[3] DTS-ES Extended Surround™

DTS-ES Extended Surround is a new multi-channel digital signal format developed by Digital Theater Systems Inc. While offering high compatibility with the conventional DTS Digital Surround format, DTS-ES Extended Surround greatly improves the 360-degree surround impression and space expression thanks to further expanded surround signals. This format has been used professionally in movie theaters since 1999.

In addition to the 5.1 surround channels (FL, FR, C, SL, SR and LFE), DTS-ES Extended Surround also offers the SB (Surround Back, sometimes also referred to as "surround center") channel for surround playback with a total of 6.1 channels. DTS-ES Extended Surround includes two signal formats with different surround signal recording methods, as described below.

■ DTS-ES™ Discrete 6.1

DTS-ES Discrete 6.1 is the newest recording format. With it, all 6.1 channels (including the SB channel) are recorded independently using a digital discrete system. The main feature of this format is that because the SL, SR and SB channels are fully independent, the sound can be designed with total freedom and it is possible to achieve a sense that the acoustic images are moving about freely among the background sounds surrounding the listener from 360 degrees.

Though maximum performance is achieved when sound tracks recorded with this system are played using a DTS-ES decoder, when played with a conventional DTS decoder the SB channel signals are automatically down-mixed to the SL and SR channels, so none of the signal components are lost.

■ DTS-ES™ Matrix 6.1

With this format, the additional SB channel signals undergo matrix encoding and are input to the SL and SR channels beforehand. Upon playback they are decoded to the SL, SR and SB channels. The performance of the encoder used at the time of recording can be fully matched using a high precision digital matrix decoder developed by DTS, thereby achieving surround sound more faithful to the producer's sound design aims than with conventional 5.1- or 6.1-channel systems.

In addition, the bit stream format is 100% compatible with conventional DTS signals, so the effect of the Matrix 6.1 format can be achieved even with 5.1-channel signal sources. Of course it is also possible to play DTS-ES Matrix 6.1 encoded sources with a DTS 5.1-channel decoder.

When DTS-ES Discrete 6.1 or Matrix 6.1 encoded sources are decoded with a DTS-ES decoder, the format is automatically detected upon decoding and the optimum playing mode is selected. However, some Matrix 6.1 sources may be detected as having a 5.1-channel format, so the DTS-ES Matrix 6.1 mode must be set manually to play these sources. (For instructions on selecting the surround mode (see page 23.)

The DTS-ES decoder includes another function, the DTS Neo:6 surround mode for 6.1-channel playback of digital PCM and analog signal sources.

■ DTS Neo:6™ surround

This mode applies conventional 2-channel signals to the high precision digital matrix decoder used for DTS-ES Matrix 6.1 to achieve 6.1-channel surround playback. High precision input signal detection and matrix processing enable full band reproduction (frequency response of 20 Hz to 20 kHz or greater) for all 6.1 channels, and separation between the different channels is improved to the same level as that of a digital discrete system.

DTS Neo:6 surround includes two modes for selecting the optimum decoding for the signal source.

• DTS Neo:6 Cinema

This mode is optimum for playing movies. Decoding is performed with emphasis on separation performance to achieve the same atmosphere with 2-channel sources as with 6.1-channel sources.

This mode is effective for playing sources recorded in conventional surround formats as well, because the in-phase component is assigned mainly to the center channel (C) and the reversed phase component to the surround (SL, SR and SB) channels.

• DTS Neo:6 Music

This mode is suited mainly for playing music. Changes in the sound quality are reduced by decoding with emphasis on the front channel signals (FL and FR), and a natural sense of expansion is given to the sound field by the effect of the surround signals output from the center (C) and surround (SL, SR and SB) channels.

Additional Information

[4] DTS 96/24

The sampling frequency, number of bits and number of channels used for recording of music, etc., in studios have been increasing in recent years, and there are a growing number of high quality signal sources, including 96 kHz/24-bit 5.1-channel sources.

For example, there are high picture/sound quality DVD video sources with 96 kHz/24-bit stereo PCM audio tracks.

However, because the data rate for these audio tracks is extremely high, there are limits to recording them on two channels only, and since the quality of the pictures must be restricted it is common to only include still pictures.

In addition, 96 kHz/24-bit 5.1-channel surround is possible with DVD audio sources, but DVD audio players are required to play them with this high quality.

DTS 96/24 is a multi-channel digital signal format developed by Digital Theater Systems Inc. in order to deal with this situation. Conventional surround formats used sampling frequencies of 48 or 44.1 kHz, so 20 kHz was about the maximum playback signal frequency. With DTS 96/24, the sampling frequency is increased to 96 or 88.2 kHz to achieve a wide frequency range of over 40 kHz.

In addition, DTS 96/24 has a resolution of 24-bits, resulting in the same frequency band and dynamic range as 96 kHz/24-bit PCM. As with conventional DTS Surround, DTS 96/24 is compatible with a maximum of 5.1 channels, so sources recorded using DTS 96/24 can be played in high sampling frequency, multiple channel audio with such normal media as DVD videos and CDs.

Thus, with DTS 96/24, the same 96 kHz/24-bit multi-channel surround sound as with DVD-Audio can be achieved while viewing DVD-Video images on a conventional DVD-Video player (*1). Furthermore, with DTS 96/24 compatible CDs, 88.2 kHz/24-bit multi-channel surround can be achieved using normal CD/LD players (*1).

Even with the high quality multi-channel signals, the recording time is the same as with conventional DTS surround sources.

What's more, DTS 96/24 is fully compatible with the conventional DTS surround format, so DTS 96/24 signal sources can be played with a sampling frequency of 48 kHz or 44.1 kHz on conventional DTS or DTS-ES surround decoders (*2).

*1 A DVD player with DTS digital output capabilities (for CD/LD players, a player with digital outputs for conventional DTS CDs/LDs) and a disc recorded in DTS 96/24 are required.

*2 The resolution is 24 or 20 bits, depending on the decoder.

Surround modes and parameters

Mode	Signals and adjustability in the different modes										
	Channel output					When playing Dolby Digital signals	When playing DTS signals	When playing PCM signals	When playing ANALOG signals	When playing Dolby Digital and DTS signals	
	FRONT L/R	CENTER	SURROUND L/R	SURROUND BACK L/R	SUBWOOFER					D. COMP.	LFE
DIRECT	○	×	×	×	⊙	○	○	○	○	○ (OFF)	○ (0 dB)
STEREO	○	×	×	×	⊙	○	○	○	○	○ (OFF)	○ (0 dB)
EXTERNAL INPUT	○	⊙	⊙	×	⊙	×	×	×	○	×	×
DOLBY PRO LOGIC II	○	⊙	⊙	⊙	⊙	○*	○*	○	○	○ (OFF)	○ (0 dB)
DOLBY PRO LOGIC IIx	○	⊙	⊙	⊙	⊙	○*	○*	○	○	○ (OFF)	○ (0 dB)
DTS NEO:6	○	⊙	⊙	⊙	⊙	○*	○*	○	○	○ (OFF)	○ (0 dB)
DOLBY DIGITAL	○	⊙	⊙	⊙	⊙	○	×	×	×	○ (OFF)	○ (0 dB)
DTS SURROUND	○	⊙	⊙	⊙	⊙	×	○	×	×	○ (OFF)	○ (0 dB)
5CH/7CH STEREO	○	⊙	⊙	⊙	⊙	○	○	○	○	○ (OFF)	○ (0 dB)
ROCK ARENA	○	⊙	⊙	⊙	⊙	○	○	○	○	○ (OFF)	○ (0 dB)
JAZZ CLUB	○	⊙	⊙	⊙	⊙	○	○	○	○	○ (OFF)	○ (0 dB)
VIDEO GAME	○	⊙	⊙	⊙	⊙	○	○	○	○	○ (OFF)	○ (0 dB)
MONO MOVIE	○	⊙	⊙	⊙	⊙	○	○	○	○	○ (OFF)	○ (0 dB)
MATRIX	○	⊙	⊙	⊙	⊙	○	○	○	○	○ (OFF)	○ (0 dB)
VIRTUAL	○	×	×	×	⊙	○	○	○	○	○ (OFF)	○ (0 dB)

○ : Signal / Adjustable
 × : No signal
 ⊙ : Turned on or off by speaker configuration setting

○ : Able
 × : Unable
 * : Only for 2 ch contents

○ : Able
 × : Unable

Mode	Signals and adjustability in the different modes													
	SB CH OUT (MODE)	TONE CONTROL	CINEMA EQ.	MODE	Surround parameter									
					ROOM SIZE	EFFECT LEVEL	DELAY TIME	SUBWOOFER ON/OFF	PRO LOGIC II / IIx only			NEO:6 MUSIC	EXT. IN	
									PANORAMA	DIMENSION	CENTER WIDTH	CENTER IMAGE	SW ATT	
DIRECT	×	×	×	×	×	×	×	×	○ (OFF)	×	×	×	×	×
STEREO	×	○ (0 dB)	×	×	×	×	×	×	×	×	×	×	×	×
EXTERNAL INPUT	×	×	×	×	×	×	×	×	×	×	×	×	×	○
DOLBY PRO LOGIC II	○	○ (0 dB)	○ (OFF)	○	×	×	×	×	×	○ (OFF)	○ (3)	○ (3)	×	×
DOLBY PRO LOGIC IIx	○	○ (0 dB)	○ (OFF)	○	×	×	×	×	×	○ (OFF)	○ (3)	○ (3)	×	×
DTS NEO:6	○	○ (0 dB)	○ (OFF)	○	×	×	×	×	×	×	×	×	○ (0.3)	×
DOLBY DIGITAL	○	○ (0 dB)	○ (OFF)	×	×	×	×	×	×	×	×	×	×	×
DTS SURROUND	○	○ (0 dB)	○ (OFF)	×	×	×	×	×	×	×	×	×	×	×
5CH/7CH STEREO	○	○ (0 dB)	×	×	×	×	×	×	×	×	×	×	×	×
ROCK ARENA	○	○ (0 dB)	×	×	○ (Medium)	○ (10)	×	×	×	×	×	×	×	×
JAZZ CLUB	○	○ (0 dB)	×	×	○ (Medium)	○ (10)	×	×	×	×	×	×	×	×
VIDEO GAME	○	○ (0 dB)	×	×	○ (Medium)	○ (10)	×	×	×	×	×	×	×	×
MONO MOVIE	○	○ (0 dB)	×	×	○ (Medium)	○ (10)	×	×	×	×	×	×	×	×
MATRIX	○	○ (0 dB)	×	×	×	×	○ (30 msec)	×	×	×	×	×	×	×
VIRTUAL	×	×	×	×	×	×	×	×	×	×	×	×	×	×

○ : Adjustable
 × : Not adjustable

Specifications

■ Audio section

• Power amplifier Rated output:

Front:	75 W +75 W (8 Ω/ohms, 20 Hz ~ 20 kHz with 0.08% T.H.D.) 110 W + 110 W (6 Ω/ohms, 1 kHz with 0.7% T.H.D.)
Center:	75 W (8 Ω/ohms, 20 Hz ~ 20 kHz with 0.08% T.H.D.) 110W (6 Ω/ohms, 1 kHz with 0.7% T.H.D.)
Surround:	75 W + 75 W (8 Ω/ohms, 20 Hz ~ 20 kHz with 0.08% T.H.D.) 110 W + 110 W (6 Ω/ohms, 1 kHz with 0.7% T.H.D.)
Surround Back:	75 W + 75 W (8 Ω/ohms, 20 Hz ~ 20 kHz with 0.08% T.H.D.) 110 W + 110 W (6 Ω/ohms, 1 kHz with 0.7% T.H.D.)

Output terminals:

Front:	A or B 6 ~ 16 Ω/ohms A + B 12 ~ 16 Ω/ohms
Center, Surround, Surr.Back:	6 ~ 16 Ω/ohms

• Analog

Input sensitivity / input impedance:

200 mV / 47 kΩ/kohms

Frequency response:

10 Hz ~ 100 kHz: +1, -3 dB (TONE DEFEAT ON)

S/N:

98 dB (IHF-A weighted) (TONE DEFEAT ON)

■ Video section

• Standard video terminals

Input / output level and impedance:

1 Vp-p, 75 Ω/ohms

Frequency response:

5 Hz ~ 10 MHz — +1, -3 dB

• S-Video terminals

Input / output level and impedance:

Y (brightness) signal — 1 Vp-p, 75 Ω/ohms

C (color) signal — 0.286 Vp-p, 75 Ω/ohms

Frequency response:

5 Hz ~ 10 MHz — +1, -3 dB

• Color component video terminal

Input / output level and impedance:

Y (brightness) signal — 1 Vp-p, 75 Ω/ohms

P_B/C_B (blue) signal — 0.7 Vp-p, 75 Ω/ohms

P_R/C_R (red) signal — 0.7 Vp-p, 75 Ω/ohms

Frequency response:

DC ~ 100 MHz — 0, -3 dB

■ Tuner section

[FM] (note: μV at 75 Ω/ohms,
0 dBf=1 × 10⁻¹⁵ W)

[AM]

Receiving Range:

87.50 MHz ~ 107.90 MHz

520 kHz ~ 1710 kHz

Usable Sensitivity:

1.0 μV (11.2 dBf)

18 μV

50 dB Quieting

Sensitivity:

MONO 1.6 μV (15.3 dBf)

STEREO 23 μV (38.5 dBf)

S/N (IHF-A):

MONO 77 dB (IHF-A weighted)

STEREO 72 dB (IHF-A weighted)

Total Harmonic Distortion

(at 1 kHz):

MONO 0.15 % (1 kHz)

STEREO 0.3 % (1 kHz)

■ General

Power supply:

AC 120 V, 60 Hz

Power consumption:

4.5 A

1 W max. (Standby)

Maximum external

dimensions:

434 (W) × 147 (H) × 417 (D) mm

(17-3/32" × 5-25/32" × 16-27/64")

Mass:

11.3 kg (24 lbs 15 oz)

■ Remote control unit (RC-1001)

Batteries:

R6P/AA Type (two batteries)

External dimensions:

55 (W) × 225 (H) × 34.5 (D) mm

(2-11/64" × 8-55/64" × 1-9/64")

Mass:

165 g (Approx. 5.8 oz) (including batteries)

* For purposes of improvement, specifications and design are subject to change without notice.

■ List of preset codes / Liste de codes pré-réglés
DVD

 Denon 014, ***[111]**

Aiwa 009

Hitachi 010

JVC 006, 011

Konka 012, 013

Magnavox 005

Mitsubishi 004

Panasonic 014

Philips 005, 015, 016, 017

Pioneer 003, 008

Sanyo 018

Sony 002, 019, 020

Toshiba 001, 021, 022

Zenith 023

VDP

Denon 028, 029, 112

Magnavox 026

Mitsubishi 028

Panasonic 029, 030

Philips 026

Pioneer 028, 031

RCA 032

Sony 033, 034, 035, 036

VCR

Admiral 081

Aiko 095

Aiwa 009

Akai 026, 027, 070, 072, 082, 083, 084

Alba 055

Amstrad 009

ASA 042

Asha 087

Audio Dynamic 005, 085

Audiovox 088

Beaumark 087

Broksonic 086, 093

Calix 088

Candle 006, 087, 088, 089, 090

Canon 049, 057

Capehart 025, 055, 056, 071

Carver 015

CCE 095

Citizen 006, 007, 087, 088, 089, 090, 095

Craig 007, 087, 088, 091, 115

Curtis Mathes 006, 049, 073, 080, 087, 090, 092

Cybernex 087

Daewoo 025, 055, 059, 074, 089, 093, 095, 096

Daytron 025, 055

DBX 005, 085

Dumont 053

Dynatech 009

Electrohome 001, 088, 097

Electrophonic 088

 Emerson 001, 009, 017, 027, 086, 088, 089, 092,
093, 097, 100, 101, 102, 103, 104, 117

Fisher 009, 028, 031, 053, 054, 091, 099, 115

 GE 007, 011, 049, 050, 051, 052, 073, 080,
087

Go Video 047, 048

Goldstar 000, 006, 012, 062, 088

Gradiente 094

Grundig 042

Harley Davidson 094

Harman Kardon 040, 062

Hi-Q 091

 Hitachi 009, 013, 023, 026, 058, ***[108]**, 109,
110, 111

 JC Penny 004, 005, 007, 023, 028, 049, 062, 085,
087, 088

Jensen 013, 026

 JVC 004, 005, 006, 026, 029, 043, 044, 045,
046, 085

 Kenwood 004, 005, 006, 026, 029, 033, 045, 085,
090

Kodak 088

Lloyd 009, 094

LXI 088

Magnavox 015, 016, 042, 049, 063, 106

Magnin 087

Marantz 004, 005, 006, 015, 042, 049, 085, 090

Marta 088

MEI 049

 Memorex 009, 033, 049, 053, 060, 081, 087, 088,
091, 094, 115

Metz 123, 124, 125, 126, 127, 128

MGA 001, 017, 027, 041, 097

MGN Technology 087

Midland 011

Minolta 013, 023

 Mitsubishi 001, 003, 008, 013, 014, 017, 027, 029,
039, 040, 041, 045, 097

Motorola 081

 Montgomery Ward 001, 002, 007, 009, 049, 063, 081, 115,
117

MTC 009, 087, 094

Multitech 007, 009, 011, 087, 090, 094

NAD 038

 NEC 004, 005, 006, 018, 026, 029, 045, 061,
062, 085

Nikko 088

Noblex 087

Optimus 081, 088

Optonica	021
Panasonic	024, 049, 064, 066, 067, 068, 069, 107
Perdio	009
Pentax	009, 013, 023, 058, 090
Philco	015, 016, 049
Philips	015, 021, 042, 049, 105
Pilot	088
Pioneer	005, 013, 029, 036, 037, 038, 045, 085
Portland	025, 055, 090
Proscan	063, 080
Pulsar	060
Quartz	033
Quasar	034, 035, 049
Radio Shack	001, 002, 021, 081, 087, 088, 091, 094, 097, 098, 115
Radix	088
Randex	088
RCA	007, 013, 019, 023, 058, 063, 064, 065, 073, 080, 082, 087
Realistic	009, 021, 031, 033, 049, 053, 081, 087, 088, 091, 094, 097, 098
Ricoh	055
Salora	033, 041
Samsung	007, 011, 051, 059, 070, 083, 087, 089, 113
Sanky	081
Sansui	005, 026, 029, 045, 061, 085, 114
Sanyo	032, 033, 053, 087, 091, 115, 116
SBR	042
Scott	017, 020, 086, 089, 093, 117
Sears	013, 023, 028, 031, 033, 053, 054, 088, 091, 098, 099, 115
Sentra	055
Sharp	001, 002, 021, 097
Shogun	087
Sony	075, 076, 077, 078, 079, 121, 122
STS	023

Sylvania	009, 015, 016, 017, 041, 049, 094
Symphonic	009, 094
Tandy	009
Tashiko	009, 088
Tatung	004, 026, 030
Teac	004, 009, 026, 094
Technics	024, 049
Teknika	009, 010, 022, 049, 088, 094
TMK	087, 092
Toshiba	013, 017, 020, 041, 059, 089, 098, 099, 117
Totevision	007, 087, 088
Unirech	087
Vectror Research	005, 062, 085, 089, 090
Victor	005, 045, 046, 085
Video Concepts	005, 027, 085, 089, 090
Videosonic	007, 087
Wards	013, 021, 023, 087, 088, 089, 091, 094, 097, 118, 119, 120
XR-1000	094
Yamaha	004, 005, 006, 026, 062, 085
Zenith	060, 078, 079

TV

Admiral	045, 121
Adventura	122
Aiko	054
Akai	016, 027, 046
Alleron	062
A-Mark	007
Amtron	061
Anam	006, 007, 036
Anam National	061, 147
AOC	003, 007, 033, 038, 039, 047, 048, 049, 133
Archer	007
Audiovox	007, 061

Bauer	155
Belcor	047
Bell & Howell	045, 118
Bradford	061
Brockwood	003, 047
Candle	003, 030, 031, 032, 038, 047, 049, 050, 122
Capehart	003
Celebrity	046
Circuit City	003
Citizen	029, 030, 031, 032, 034, 038, 047, 049, 050, 054, 061, 095, 122, 123
Concerto	031, 047, 049
Colortyme	003, 047, 049, 135
Contec	013, 051, 052, 061
Cony	051, 052, 061
Craig	004, 061
Crown	029
Curtis Mathes	029, 034, 038, 044, 047, 049, 053, 095, 118
Daewoo	027, 029, 039, 048, 049, 054, 055, 106, 107, 137
Daytron	003, 049
Dimensia	044
Dixi	007, 015, 027
Electroband	046
Electrohome	029, 056, 057, 058, 147
Elta	027
Emerson	029, 051, 059, 060, 061, 062, 118, 123, 124, 139, 148
Envision	038
Etron	027
Fisher	014, 021, 063, 064, 065, 118
Formenti	155
Fortress	012
Fujitsu	004, 062
Funai	004, 062

Futuretech	004
GE	020, 036, 037, 040, 044, 058, 066, 088, 119, 120, 125, 147
Goldstar	000, 015, 029, 031, 039, 048, 051, 056, 057, 067, 068, 069, 116
Grundy	062
Hitachi	029, 031, 051, 052, 070, 111, 112, 113, 124, *[134]
Hitachi Pay TV	151
Infinity	017, 071
Janeil	122
JBL	017, 071
JC Penny	020, 034, 039, 040, 041, 044, 048, 050, 058, 066, 069, 076, 088, 090, 095, 125, 136, 159
JCB	046
JVC	019, 051, 052, 072, 073, 091, 117, 126
Kawasho	018, 046
Kenwood	038, 056, 057
Kloss	010, 032
Kloss Novabeam	005, 122, 127, 131
KTV	074, 123
Loewe	071
Logik	144
Luxman	031
LXI	008, 014, 017, 024, 040, 044, 063, 071, 075, 076, 077, 118, 125
Magnavox	005, 010, 017, 030, 033, 038, 050, 056, 071, 078, 079, 085, 089, 108, 109, 110, 127, 131, 132, 145
Marantz	015, 017, 071, 080
Matsui	027
Memorex	014, 027, 045, 083, 118, 144
Metz	160, 161, 162, 163
MGA	001, 039, 048, 056, 057, 058, 065, 081, 083
Midland	125

Minutz	066
Mitsubishi	001, 016, 039, 048, 056, 057, 058, 065, 081, 082, 083, 105
Montgomery Ward	011, 020, 144, 145, 146
Motorola	121, 147
MTC	031, 034, 039, 048, 095
NAD	008, 075, 076, 128
National	002, 036, 061, 147
National Quenties	002
NEC	031, 038, 039, 048, 057, 084, 086, 135, 147
Nikko	054
NTC	054
Optimus	128
Optonica	011, 012, 093, 121
Orion	004, 139
Panasonic	002, 009, 017, 036, 037, 071, 141, 143, 147
Philco	005, 010, 030, 050, 051, 056, 079, 085, 127, 131, 132, 145, 147
Philips	005, 015, 017, 050, 051, 056, 078, 087, 088, 089, 131, 132, 147
Pioneer	124, 128, 142
Portland	054
Price Club	095
Proscan	040, 044, 125
Proton	035, 051, 092, 129
Pulsar	042
Quasar	036, 037, 074, 141
Radio Shack	011, 044, 063, 093, 118
RCA	040, 044, 125, 130, 137, 151, 152
Realistic	014, 063, 093, 118
Saisho	027
Samsung	003, 015, 034, 053, 055, 057, 094, 095, 136, 153
Sansui	139
Sanyo	013, 014, 021, 022, 063, 064, 081, 096

SBR	015
Schneider	015
Scott	062
Sears	008, 014, 021, 022, 023, 024, 025, 040, 052, 057, 062, 063, 064, 065, 073, 075, 076, 097, 098, 125, 159
Sharp	011, 012, 013, 026, 093, 099, 100, 104, 121
Siemens	013
Signature	045, 144
Simpson	050
Sony	043, 046, 138, 146, 150
Soundesign	030, 050, 062
Spectricon	007, 033
Squareview	004
Supre-Macy	032, 122
Supreme	046
Sylvania	005, 010, 017, 030, 078, 079, 085, 089, 101, 127, 131, 132, 145, 155
Symphonic	004, 148
Tandy	012, 121
Tatung	036, 124
Technics	037
Teknika	001, 030, 032, 034, 052, 054, 078, 083, 095, 144, 156, 157
Tera	035, 129
Toshiba	008, 014, 034, 063, 075, 076, 095, 097, 136, 158, 159
Universal	020, 066, 088
Victor	019, 073, 126
Video Concepts	016
Viking	032, 122
Wards	005, 045, 066, 078, 085, 088, 089, 093, 102, 103, 131, 132, 148
Zenith	042, 114, 115, 140, 144, 149
Zonda	007

CABLE

ABC	006, *[007], 008, 009
Archer	010, 011
Century	011
Citizen	011
Colour Voice	012, 013
Comtronic	014
Eastern	015
Garrard	011
Gemini	030, 033, 034
General Instrument	030, 031, 032
Hytex	006
Jasco	011
Jerrold	009, 016, 017, 026, 032
Magnavox	018
Movie Time	019
NSC	019
Oak	000, 006, 020
Panasonic	001, 005
Philips	011, 012, 013, 018, 021
Pioneer	002, 003, 022
RCA	029
Regency	015
Samsung	014, 023
Scientific Atlanta	004, 024, 025
Signal	014
SL Marx	014
Starcom	009
Stargate	014
Televue	014
Tocom	007, 016
TV86	019
Unika	011
United Artists	006
Universal	010, 011
Viewstar	018, 019
Zenith	027, 028

DBS (SATELLITE)

Alphastar	054
Chaparral	035, 036
Dishnet	053
Drake	037, 038
Echostar Dish	062, 066
GE	048, 055, 056
General Instruments	039, 040, 041
Grundig	070, 071, 072, 073
Hitachi	058, 059
Hughes Network	063, 064, 065, 069
JVC	057
Kathrein	074, 075, 076, 083
Magnavox	060
Nokia	070, 080, 084, 085, 086
Philips	060
Primestar	051
Proscan	048, 055, 056
RCA	048, 055, 056, 068
Realistic	042
Sierra I	036
Sierra II	036
Sierra III	036
Sony	049, 067
STS1	043
STS2	044
STS3	045
SRS4	046
Technisat	077, 078, 079, 081, 082
Toshiba	047, 050
Uniden	061
CD	
Denon	*[111]
Aiwa	001, 035, 043
Burmster	002
Carver	003, 035

Emerson	004, 005, 006, 007
Fisher	003, 008, 009, 010
JVC	018, 019
Kenwood	011, 012, 013, 014, 017
Magnavox	006, 015, 035
Marantz	016, 028, 035
MCS	016, 024
Onkyo	025, 027
Optimus	017, 020, 021, 022, 023
Philips	014, 032, 033, 035
Pioneer	006, 022, 030
Sears	006
Sony	023, 031
Teac	002, 009, 028
Technics	016, 029, 036
Wards	035, 037
Yamaha	038, 039, 040, 041
Zenith	042

CDR

Denon	*[111], 112
Philips	112

MD

Denon	113
Kenwood	003, 004
Onkyo	007
Sharp	005
Sony	006

TAPE

Denon	*[111]
Aiwa	001, 002
Carver	002
Harman/Kardon	002, 003
JVC	004, 005
Kenwood	006

Magnavox	002
Marantz	002
Onkyo	016, 018
Optimus	007, 008
Panasonic	012
Philips	002
Pioneer	007, 008, 009
Sony	013, 014, 015
Technics	012
Victor	004
Wards	007
Yamaha	010, 011

*[]: Preset codes set upon shipment from the factory.

*[]: Les codes pré-réglés diffèrent en fonction des livraisons de l'usine.

DVD preset codes Codes pré-réglés DVD	111	014
DENON	DVD-555	DVD-800
Model No.	DVD-755	DVD-1600
Modèle numéro	DVD-900	DVD-2000
	DVD-910	DVD-2500
	DVD-955	DVD-3000
	DVD-1000	DVD-3300
	DVD-1200	
	DVD-1500	
	DVD-1710	
	DVD-1910	
	DVD-2200	
	DVD-2800	
	DVD-2800II	
	DVD-2900	
	DVD-2910	
	DVD-3800	
	DVD-3910	
	DVD-5900	
	DVD-5910	
	DVD-9000	
	DVM-715	
	DVM-1800	
	DVM-1805	
	DVM-1815	
	DVM-2815	
	DVM-4800	

DENON
TOKYO, JAPAN
www.denon.com

Denon Brand Company, D&M Holdings Inc.
Printed in China 00D 511 4321 007

Free Manuals Download Website

<http://myh66.com>

<http://usermanuals.us>

<http://www.somanuals.com>

<http://www.4manuals.cc>

<http://www.manual-lib.com>

<http://www.404manual.com>

<http://www.luxmanual.com>

<http://aubethermostatmanual.com>

Golf course search by state

<http://golfingnear.com>

Email search by domain

<http://emailbydomain.com>

Auto manuals search

<http://auto.somanuals.com>

TV manuals search

<http://tv.somanuals.com>