

DENON

AV SURROUND RECEIVER **AVR-2805**

OPERATING INSTRUCTIONS
BEDIENUNGSANLEITUNG
MODE D'EMPLOI
ISTRUZIONI PER L'USO

INSTRUCCIONES DE OPERACION
GEBRUIKSAANWIJZING
BRUKSANVISNING

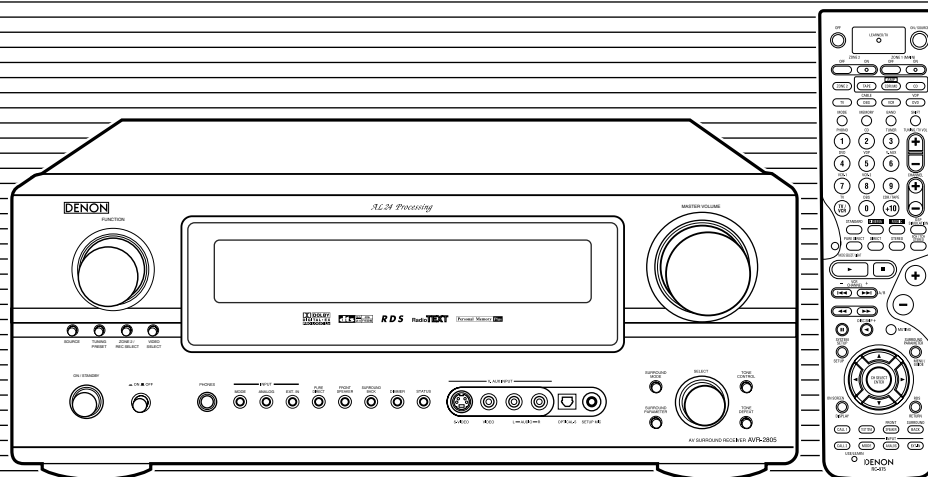

FOR ENGLISH READERS	PAGE	2	~	PAGE	61
FÜR DEUTSCHE LESER	SEITE	62	~	SEITE	120
POUR LES LECTEURS FRANCAIS	PAGE	121	~	PAGE	179
PER IL LETTORE ITALIANO	PAGINA	180	~	PAGINA	238
PARA LECTORES DE ESPAÑOL	PAGINA	239	~	PAGINA	297
VOOR NEDERLANDSTALIGE LEZERS	PAGINA	298	~	PAGINA	356
FOR SVENSKA LÄSARE	SIDA	357	~	SIDA	415



CAUTION
RISK OF ELECTRIC SHOCK
DO NOT OPEN



CAUTION: TO REDUCE THE RISK OF ELECTRIC SHOCK, DO NOT REMOVE COVER (OR BACK). NO USER SERVICEABLE PARTS INSIDE. REFER SERVICING TO QUALIFIED SERVICE PERSONNEL.



The lightning flash with arrowhead symbol, within an equilateral triangle, is intended to alert the user to the presence of uninsulated "dangerous voltage" within the product's enclosure that may be of sufficient magnitude to constitute a risk of electric shock to persons.



The exclamation point within an equilateral triangle is intended to alert the user to the presence of important operating and maintenance (servicing) instructions in the literature accompanying the appliance.

WARNING: TO REDUCE THE RISK OF FIRE OR ELECTRIC SHOCK, DO NOT EXPOSE THIS APPLIANCE TO RAIN OR MOISTURE.

• DECLARATION OF CONFORMITY

We declare under our sole responsibility that this product, to which this declaration relates, is in conformity with the following standards:
EN60065, EN55013, EN55020, EN61000-3-2 and EN61000-3-3.
Following the provisions of 73/23/EEC, 89/336/EEC and 93/68/EEC Directive.

• ÜBEREINSTIMMUNGSERKLÄRUNG

Wir erklären unter unserer Verantwortung, daß dieses Produkt, auf das sich diese Erklärung bezieht, den folgenden Standards entspricht:
EN60065, EN55013, EN55020, EN61000-3-2 und EN61000-3-3.
Entspricht den Verordnungen der Direktive 73/23/EEC, 89/336/EEC und 93/68/EEC.

• DECLARATION DE CONFORMITE

Nous déclarons sous notre seule responsabilité que l'appareil, auquel se réfère cette déclaration, est conforme aux standards suivants:
EN60065, EN55013, EN55020, EN61000-3-2 et EN61000-3-3.
D'après les dispositions de la Directive 73/23/EEC, 89/336/EEC et 93/68/EEC.

• DICHIARAZIONE DI CONFORMITÀ

Dichiaro con piena responsabilità che questo prodotto, al quale la nostra dichiarazione si riferisce, è conforme alle seguenti normative:
EN60065, EN55013, EN55020, EN61000-3-2 e EN61000-3-3.
In conformità con le condizioni delle direttive 73/23/EEC, 89/336/EEC e 93/68/EEC.
QUESTO PRODOTTO E' CONFORME
AL D.M. 28/08/95 N. 548

• DECLARACIÓN DE CONFORMIDAD

Declaramos bajo nuestra exclusiva responsabilidad que este producto al que hace referencia esta declaración, está conforme con los siguientes estándares:
EN60065, EN55013, EN55020, EN61000-3-2 y EN61000-3-3.

Siguiendo las provisiones de las Directivas 73/23/EEC, 89/336/EEC y 93/68/EEC.

• EENVORMIGHEIDSVKLAARING







Wij verklaren uitsluitend op onze verantwoordelijkheid dat dit product, waarop deze verklaring betrekking heeft, in overeenstemming is met de volgende normen:
EN60065, EN55013, EN55020, EN61000-3-2 en EN61000-3-3.

Volgens de bepalingen van de Richtlijnen 73/23/EEC, 89/336/EEC en 93/68/EEC.

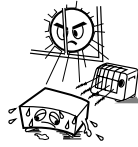
• ÖVERENSSTÄMMELSESINTYG

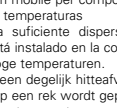
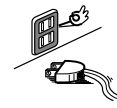
Härmed intygas helt på eget ansvar att denna produkt, vilken detta intyg avser, uppfyller följande standarder:
EN60065, EN55013, EN55020, EN61000-3-2 och EN61000-3-3.
Enligt stadgarna i direktiv 73/23/EEC, 89/336/EEC och 93/68/EEC.

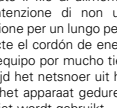
NOTE ON USE / HINWEISE ZUM GEBRAUCH / OBSERVATIONS RELATIVES A L'UTILISATION / NOTE SULL'USO NOTAS SOBRE EL USO / ALVORENS TE GEBRUIKEN / OBSERVERA

 <ul style="list-style-type: none"> • Avoid high temperatures. Allow for sufficient heat dispersion when installed on a rack. • Vermeiden Sie hohe Temperaturen. Beachten Sie, daß eine ausreichend Luftzirkulation gewährleistet wird, wenn das Gerät auf ein Regal gestellt wird. • Eviter des températures élevées. Tenir compte d'une dispersion de chaleur suffisante lors de l'installation sur une étagère. • Evitate di esporre l'unità a temperature alte. Assicuratevi che ci sia un'adeguata dispersione del calore quando installate l'unità in un mobile per componenti audio. • Evite altas temperaturas. Permita la suficiente dispersión del calor cuando está instalado en la consola. • Vermijd hoge temperaturen. Zorg voor een degelijk hitteafvoer indien het apparaat op een rek wordt geplaatst. • Undvik höga temperaturer. Se till att det finns möjlighet till god värmeavledning vid monteringen i ett rack. 	 <ul style="list-style-type: none"> • Keep the set free from moisture, water, and dust. • Halten Sie das Gerät von Feuchtigkeit, Wasser und Staub fern. • Protéger l'appareil contre l'humidité, l'eau et l'apoussièrè. • Tenete l'unità lontana dall'umidità, dall'acqua e dalla polvere. • Mantenga el equipo libre de humedad, agua y polvo. • Laat geen vochtigheid, water of stof in het apparaat binnendringen. • Utsätt inte apparaten för fukt, vatten och damm. 	 <ul style="list-style-type: none"> • Do not let foreign objects in the set. • Keine fremden Gegenstände in das Gerät kommen lassen. • Ne pas laisser des objets étrangers dans l'appareil. • E' importante che nessun oggetto è inserito all'interno dell'unità. • No deje objetos extraños dentro del equipo. • Laat geen vreemde voorwerpen in dit apparaat vallen. • Se till att främmande föremål inte tränger in i apparaten.
 <ul style="list-style-type: none"> • Unplug the power cord when not using the set for long periods of time. • Wenn das Gerät eine längere Zeit nicht verwendet werden soll, trennen Sie das Netzkabel vom Netzstecker. • Débrancher le cordon d'alimentation lorsque l'appareil n'est pas utilisé pendant de longues périodes. • Disinnestate il filo di alimentazione quando avete l'intenzione di non usare il filo di alimentazione per un lungo periodo di tempo. • Desconecte el cordón de energía cuando no utilice el equipo por mucho tiempo. • Neem altijd het netsnoer uit het stopcontact wanneer het apparaat gedurende een lange periode niet wordt gebruikt. • Koppla ur nätkabeln om apparaten inte kommer att användas i lång tid. 	 <ul style="list-style-type: none"> • Do not let insecticides, benzene, and thinner come in contact with the set. • Lassen Sie das Gerät nicht mit Insektiziden, Benzin oder Verdünnungsmitteln in Berührung kommen. • Ne pas mettre en contact des insecticides, du benzène et un diluant avec l'appareil. • Assicuratevi che l'unità non venga in contatto con insetticidi, benzolo o solventi. • No permita el contacto de insecticidas, gasolina y diluyentes con el equipo. • Laat geen insectenverdelgende middelen, benzine of verververdunner met dit apparaat in contact komen. • Se till att inte insektsmedel på spraybruk, bensen och thinner kommer i kontakt med apparatens hölje. 	 <ul style="list-style-type: none"> • Do not let insecticides, benzene, and thinner come in contact with the set. • Lassen Sie das Gerät nicht mit Insektiziden, Benzin oder Verdünnungsmitteln in Berührung kommen. • Ne pas mettre en contact des insecticides, du benzène et un diluant avec l'appareil. • Assicuratevi che l'unità non venga in contatto con insetticidi, benzolo o solventi. • No permita el contacto de insecticidas, gasolina y diluyentes con el equipo. • Laat geen insectenverdelgende middelen, benzine of verververdunner met dit apparaat in contact komen. • Se till att inte insektsmedel på spraybruk, bensen och thinner kommer i kontakt med apparatens hölje.
 <ul style="list-style-type: none"> • Handle the power cord carefully. Hold the plug when unplugging the cord. • Gehen Sie vorsichtig mit dem Netzkabel um. Halten Sie das Kabel am Stecker, wenn Sie den Stecker herausziehen. • Manipuler le cordon d'alimentation avec précaution. Tenir la prise lors du débranchement du cordon. • Maneggiare il filo di alimentazione con cura. Agire per la spina quando scollegate il cavo dalla presa. • Maneje el cordón de energía con cuidado. Sostenga el enchufe cuando desconecte el cordón de energía. • Hanteer het netsnoer voorzichtig. Houd het snoer bij de stekker vast wanneer deze moet worden aan- of losgekoppeld. • Hantera nätkabeln varsamt. Håll i kabeln när den kopplas från el-uttaget. 	 <ul style="list-style-type: none"> • Do not obstruct the ventilation holes. • Die Belüftungsöffnungen dürfen nicht verdeckt werden. • Ne pas obstruer les trous d'aération. • Non coprite i fori di ventilazione. • No obstruya los orificios de ventilación. • De ventilatieopeningen mogen niet worden beblokkeerd. • Täpp inte till ventilationsöppningarna. 	 <ul style="list-style-type: none"> • Never disassemble or modify the set in any way. • Versuchen Sie niemals das Gerät auseinander zu nehmen oder auf jegliche Art zu verändern. • Ne jamais démonter ou modifier l'appareil d'une manière ou d'une autre. • Non smontate mai, né modificate l'unità in nessun modo. • Nunca desarme o modifique el equipo de ninguna manera. • Nooit dit apparaat demonteren of op andere wijze modifieren. • Ta inte isär apparaten och försök inte bygga om den.
<p>CAUTION</p> <ul style="list-style-type: none"> • The ventilation should not be impeded by covering the ventilation openings with items, such as newspapers, table-cloths, curtains, etc. • No naked flame sources, such as lighted candles, should be placed on the apparatus. 	 <p>* (For sets with ventilation holes)</p> <ul style="list-style-type: none"> • Do not obstruct the ventilation holes. • Die Belüftungsöffnungen dürfen nicht verdeckt werden. • Ne pas obstruer les trous d'aération. • Non coprite i fori di ventilazione. • No obstruya los orificios de ventilación. • De ventilatieopeningen mogen niet worden beblokkeerd. • Täpp inte till ventilationsöppningarna. 	 <ul style="list-style-type: none"> • Please be care the environmental aspects of battery disposal. • The apparatus shall not be exposed to dripping or splashing for use. • No objects filled with liquids, such as vases, shall be placed on the apparatus.

- We greatly appreciate your purchase of the AVR-2805.
- To be sure you take maximum advantage of all the features the AVR-2805 has to offer, read these instructions carefully and use the set properly. Be sure to keep this manual for future reference, should any questions or problems arise.

“SERIAL NO. _____
PLEASE RECORD UNIT SERIAL NUMBER ATTACHED TO THE REAR OF THE CABINET FOR FUTURE REFERENCE”

■ INTRODUCTION

Thank you for choosing the DENON AVR-2805 Digital A / V Surround Receiver. This remarkable component has been engineered to provide superb surround sound listening with home theater sources such as DVD, as well as providing outstanding high fidelity reproduction of your favorite music sources. As this product is provided with an immense array of features, we recommend that before you begin hookup and operation that you review the contents of this manual before proceeding.

TABLE OF CONTENTS

1 Before Using.....3	10 Multi Zone.....38, 39
2 Cautions on Installation.....3	11 Surround.....39~44
3 Cautions on Handling.....3	12 DSP Surround Simulation.....45~48
4 Features.....4	13 Listening to the Radio.....48~52
5 Connections.....5~9	14 Last Function Memory.....52
6 Part Names and Functions.....9, 10	15 Initialization of the Microprocessor.....52
7 Setting up the System.....11~28	16 Troubleshooting.....52, 53
8 Remote Control Unit.....29~33	17 Additional Information.....53~60
9 Operation.....34~37	18 Specifications.....61

■ ACCESSORIES

Check that the following parts are included in addition to the main unit:

- | | |
|--------------------------------------|------------------------------------|
| ① Operating instructions.....1 | ⑤ R6P/AA batteries.....3 |
| ② Service station list.....1 | ⑥ AM loop antenna.....1 |
| ③ AC cord.....1 | ⑦ FM indoor antenna.....1 |
| ④ Remote control unit (RC-975).....1 | ⑧ Omnidirectional microphone.....1 |

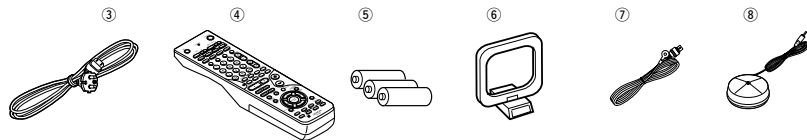

1 BEFORE USING

Pay attention to the following before using this unit:

- **Moving the set**
To prevent short circuits or damaged wires in the connection cords, always unplug the power cord and disconnect the connection cords between all other audio components when moving the set.
- **Before turning the power switch on**
Check once again that all connections are proper and that there are not problems with the connection cords. Always set the power switch to the standby position before connecting and disconnecting connection cords.
- **Store this instructions in a safe place.**
After reading, store this instructions along with the warranty in a safe place.
- **Note that the illustrations in this instructions may differ from the actual set for explanation purposes.**
- **V. AUX terminal**
The AVR-2805's front panel is equipped with a V. AUX terminal. Remove the cap covering the terminal when you want to use it.

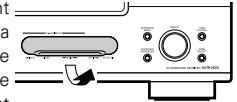

2 CAUTIONS ON INSTALLATION

- Noise or disturbance of the picture may be generated if this unit or any other electronic equipment using microprocessors is used near a tuner or TV. If this happens, take the following steps:
- Install this unit as far as possible from the tuner or TV.
 - Set the antenna wires from the tuner or TV away from this unit's power cord and input/output connection cords.
 - Noise or disturbance tends to occur particularly when using indoor antennas or 300 Ω/ohms feeder wires. **We recommend using outdoor antennas and 75 Ω/ohms coaxial cables.**

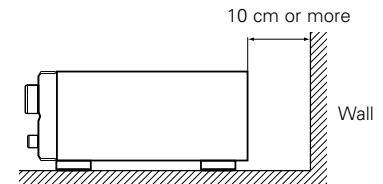
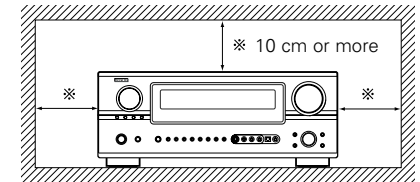

For heat dispersal, leave at least 10 cm of space between the top, back and sides of this unit and the wall or other components.

3 CAUTIONS ON HANDLING

- **Switching the input function when input jacks are not connected**
A clicking noise may be produced if the input function is switched when nothing is connected to the input jacks. If this happens, either turn down the MASTER VOLUME control or connect components to the input jacks.
- **Muting of PRE OUT jacks, HEADPHONE jack and SPEAKER terminals**
The PRE OUT jacks, HEADPHONE jack and SPEAKER terminals include a muting circuit. Because of this, the output signals are greatly reduced for several seconds after the power switch is turned on or input function, surround mode or any other-set-up is changed. If the volume is turned up during this time, the output will be very high after the muting circuit stops functioning. Always wait until the muting circuit turns off before adjusting the volume.
- **Whenever the unit is in the STANDBY state, the apparatus is still connected on AC line voltage. Please be sure to turn the power off (I Off) when you leave home for, say, a vacation.**

4 FEATURES

1. Dolby Digital

Using advanced digital processing algorithms, Dolby Digital provides up to 5.1 channels of wide-range, high fidelity surround sound. Dolby Digital is the default digital audio delivery system for DVD and North American DTV.

2. Dolby Pro Logic IIx compatibility

Dolby Pro Logic IIx furthers the matrix decoding technology of Dolby Pro Logic II to decode audio signals recorded on two channels into up to 7.1 playback channels, including the surround back channel. Dolby Pro Logic IIx also allows 5.1-channel sources to be played in up to 7.1 channels.

The mode can be selected according to the source. The Music mode is best suited for playing music, the Cinema mode for playing movies, and the Game mode for playing games. The Game mode can only be used with 2-channel audio sources.

3. Dolby Pro Logic II Game mode compatibility

In addition to the previously offered Music and Cinema modes, the AVR-2805 also offers a Game mode optimum for games.

4. DTS (Digital Theater Systems)

DTS provides up to 5.1 channels of wide-range, high fidelity surround sound, from sources such as laser disc, DVD and specially-encoded music discs.

5. DTS-ES Extended Surround and DTS Neo:6

The AVR-2805 can be decoded with DTS-ES Extended Surround, a multi-channel format developed by Digital Theater Systems Inc.

The AVR-2805 can be also decoded with DTS Neo:6, a surround mode allowing 6.1 channels playback of regular stereo sources.

6. DTS 96/24 compatibility

The AVR-2805 can be decoded with sources recorded in DTS 96/24, a multi-channel digital signal format developed by Digital Theater Systems Inc.

DTS 96/24 sources can be played in the multi-channel mode on the AVR-2805 with high sound quality of 96 kHz/24 bits or 88.2 kHz/24 bits.

7. Pure Direct Mode/AL24 Processing

The AVR-2805 is equipped with a pure direct mode allowing the effects of the video and digital circuitry to be shut down when playing CDs or records to achieve the ideal environment for analog playback, resulting in extremely high quality music playback. It is also equipped with AL24 processing which compensates the input digital data to produce the near analog waveforms which would be in a nature with 24 bits quality. AL24 processing operates when PCM data such as CD is inputted.

8. Auto Setup/Room EQ

Use of the microphone for setup applications measures the presence of speakers, the distance to the speakers, and other information, and permits automatic setup. The characteristics of each speaker can also be corrected.

9. Multi Zone Music Entertainment System

Multi Source Function:

This unit's Multi Source function lets you select different audio sources for listening. Different sources can thus be enjoyed in the main room (MAIN) and the subroom (ZONE2) simultaneously.

10. Future Sound Format Upgrade Capability via Eight Channel Inputs & Outputs

For future multi-channel audio format(s), the AVR-2805 is provided with 7.1 channel (seven main channels, plus one low frequency effects channel) inputs, along with a full set of 7.1 channel pre-amp outputs, controlled by the 8 channel master volume control. This assures future upgrade possibilities for any future multi-channel sound format.

11. Front input Terminal

The unit is equipped with a Front Input connector for the convenient connection of a video camera or other equipment.

12. Video Conversion Function

The AVR-2805 is equipped with a function for up-converting video signals.

Because of this, the AVR-2805's MONITOR OUT jack can be connected to the monitor (TV) with a set of cables offering a higher quality connection, regardless of how the player and the AVR-2805's video input jacks are connected.

13. Component Video Switching

In addition to composite video and "S" video switching, the AVR-2805 provides 3 sets of component video (Y, Pb/Cb, Pr/Cr) inputs, and one set of component video outputs to the television, for superior picture quality.

14. TRIGGER OUT

AVR-2805 is equipped with 2 systems of 12V TRIGGER OUT connections. Each output can be activated upon the selection of assigned. Main Zone inputs or zone2 inputs.

15. RS-232C Terminal

Includes a RS-232C port to support an AMX, Crestron integrated control system.

16. AC INLET

Detachable AC CORD is used.

17. Auto Surround Mode

This function stores the surround mode last used for an input signal in the memory and automatically sets that surround mode the next time that signal is input.

18. Large-sized fluorescent display

A large-sized fluorescent display is used which also permits a check of the input/output channels.

19. Audio delay

This is a function for delaying the audio signal with respect to the video signal. (0 to 200 msec)

20. Preset Memory Tuning

56-Station AM/FM Random Preset Memory tuning.

5 CONNECTIONS

- Do not plug in the AC cord until all connections have been completed.
- Be sure to connect the left and right channels properly (left with left, right with right).
- Insert the plugs securely. Incomplete connections will result in the generation of noise.
- Use the AC OUTLET for audio equipment only. Do not use them for hair driers, etc.**
- Note that binding pin plug cords together with AC cords or placing them near a power transformer will result in generating hum or other noise.
- Noise or humming may be generated if a connected audio equipment is used independently without turning the power of this unit on. If this happens, turn on the power of the this unit.

Connecting the audio components

- When making connections, also refer to the operating instructions of the other components.

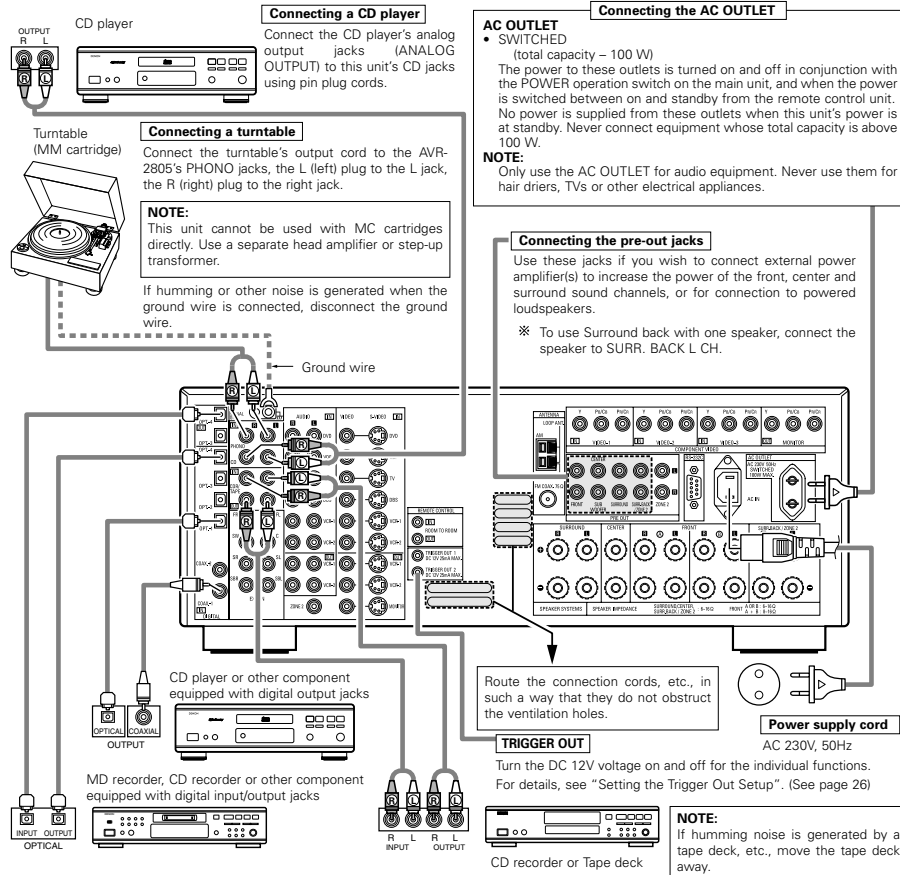

Connecting the video components

- To connect the video signal, connect using a 75 Ω/ohms video signal cable cord. Using an improper cable can result in a drop in video quality.
- When making connections, also refer to the operating instructions of the other components.
- The AVR-2805 is equipped with a function for up-converting video signals.
- The signal connected to the video signal terminal is output to the S-Video and component video monitor out terminals.
- The REC OUT terminals have no conversion function, so when recording only connect the video terminals.

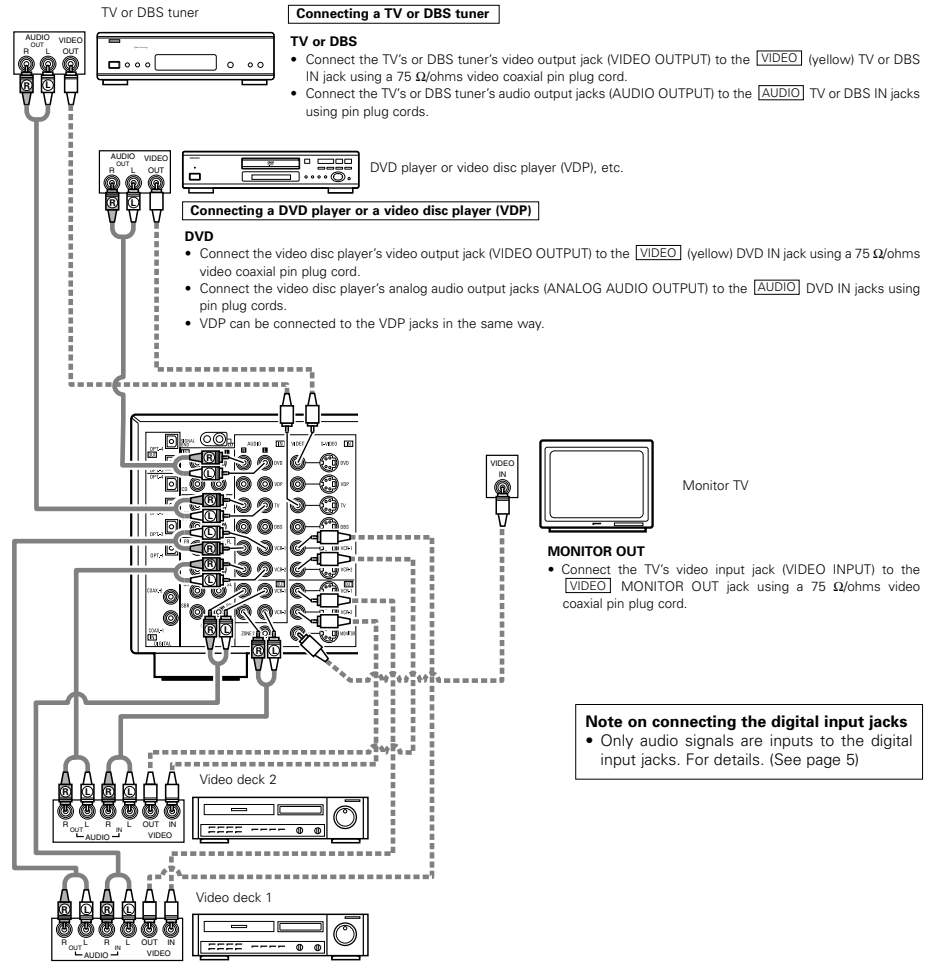

Connecting the video components equipped with S-Video jacks

- When making connections, also refer to the operating instructions of the other components.
- **A note on the S input jacks**
The input selectors for the S inputs and Video inputs work in conjunction with each other.
- The AVR-2805 is equipped with a function for converting video signals.
- The signal connected to the S-Video signal terminal is output to the composite video and component video monitor out terminals.
- The REC OUT terminals have no conversion function, so when recording only connect the S-Video terminals.

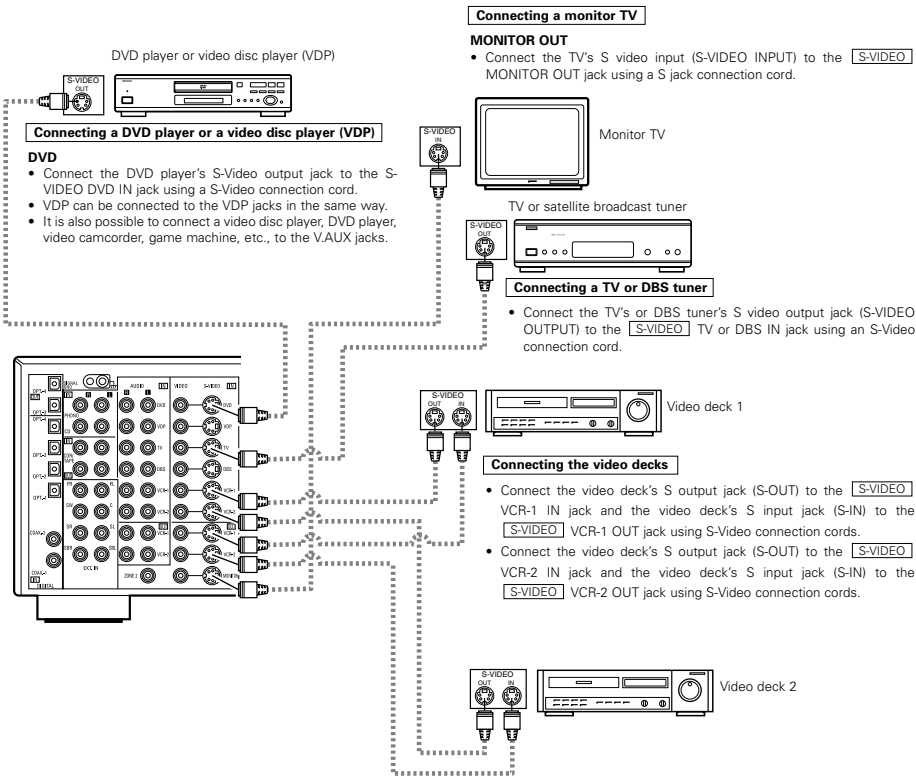

Connect the components' audio inputs and outputs as described. (See page 5)

Connecting the video component equipped with Color Difference (Component - Y, Pr/CR, Pb/CB) Video jacks

- When making connections, also refer to the operating instructions of the other components.
- The signals input to the color difference (component) video jacks are not outputs to the VIDEO output jack (yellow) or the S-Video output jack.
- Some video sources with component video outputs are labeled Y, Cb, Cr, or Y, Pb, Pr, or Y, R-Y, B-Y. These terms all refer to component video color difference output.
- The function assigned to the component video input can be changed at the system setup. For details, see "Setting the Video Input Mode". (See page 23)

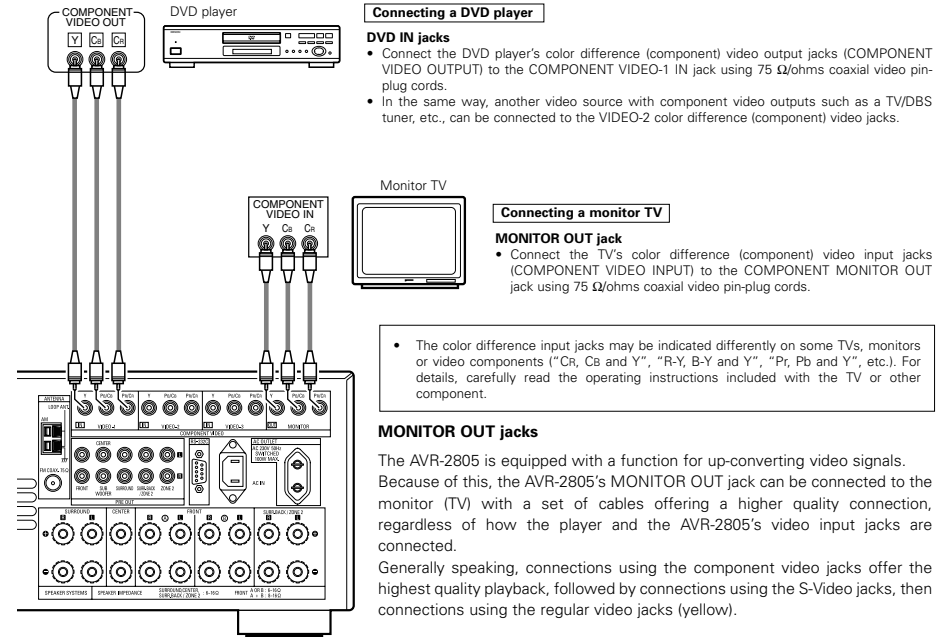

The color difference input jacks may be indicated differently on some TVs, monitors or video components ("Cr, Cb and Y", "R-Y, B-Y and Y", "Pr, Pb and Y", etc.). For details, carefully read the operating instructions included with the TV or other component.

The Video Conversion Function

With the AVR-2805, the Video signal and the S-video signal which were inputted are converted mutually. And also the Video signal and the S-Video signal which were inputted are converted into a higher quality.

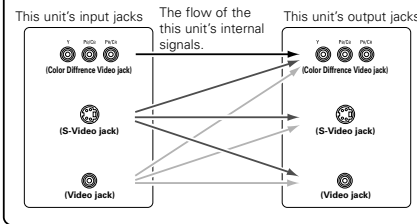

NOTE:

Down-converting from the component video signal to the S-Video and composite video signal is not possible, so when not using the component video monitor output terminal connect the player using the S-Video or composite video input terminal.

Cautions on the video conversion function:

When the component video terminals are used to connect the AVR-2805 with a TV (or monitor, projector, etc.) and the video (yellow) or S video terminals are used to connect the AVR-2805 with a VTR, depending on the combination of the TV and VTR the picture may flicker in the horizontal direction, be distorted, be out of sync or not display at all when playing video tapes. If this happens, connect a commercially available video stabilizer, etc., with a TBC (time base corrector) function between the AVR-2805 and the VTR, or if your VTR has a TBC function, turn it on.

Connecting the antenna terminals

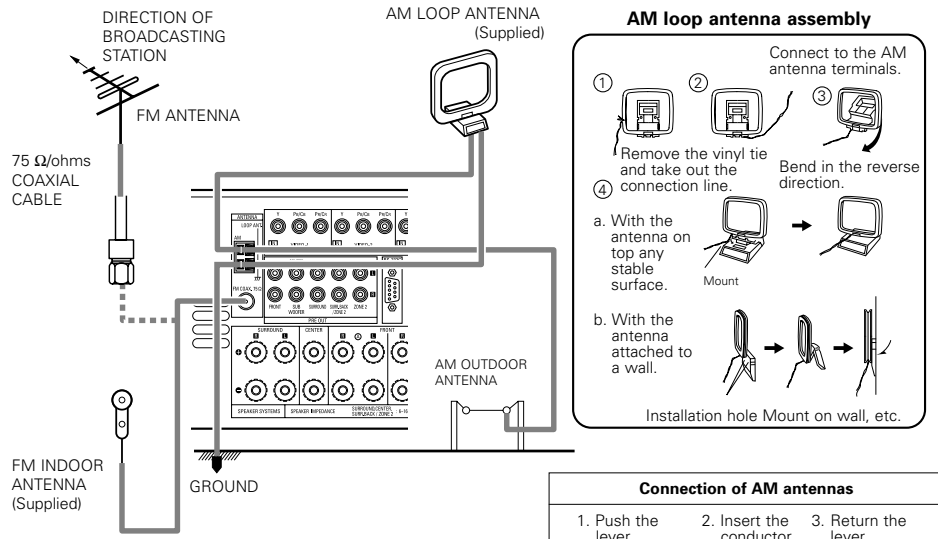

AM loop antenna assembly

Connect to the AM antenna terminals.

- Remove the vinyl tie and take out the connection line.
- Bend in the reverse direction.

a. With the antenna on top any stable surface. Mount

b. With the antenna attached to a wall. Installation hole Mount on wall, etc.

Connection of AM antennas

- Push the lever.
- Insert the conductor.
- Return the lever.

- An F-type FM antenna cable plug can be connected directly.

Notes:

- Do not connect two FM antennas simultaneously.
- Even if an external AM antenna is used, do not disconnect the AM loop antenna.
- Make sure AM loop antenna lead terminals do not touch metal parts of the panel.

Connecting the external input (EXT. IN) jacks

- These jacks are for inputting multi-channel audio signals from an outboard decoder, or a component with a different type of multi-channel decoder, such as a DVD Audio player, a multi-channel SACD player, or other future multi-channel sound format decoder.
- When making connections, also refer to the operating instructions of the other components.

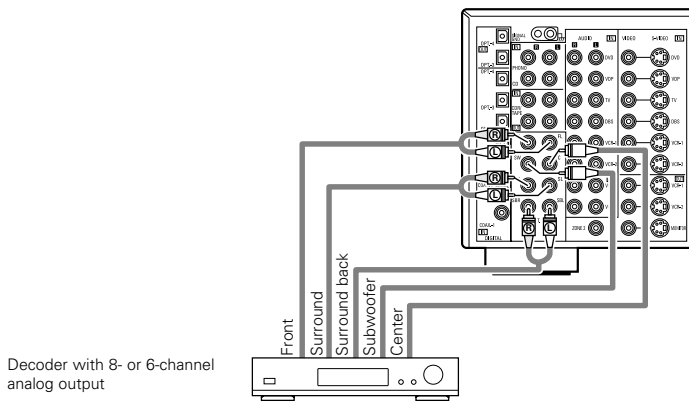

※ For instructions on playback using the external input (EXT. IN) jacks. (See page 35)

Connecting the MULTI ZONE jacks

※ For instructions on operations using the MULTI ZONE FUNCTIONS. (See pages 38, 39)

[1] ZONE2 preout CONNECTIONS

- If another power amplifier or pre-main (integrated) amplifier or is connected, the ZONE2 preout (variable/fixed level) jacks can be used to play a different program source in ZONE2 the same time. (See page 38)
- The ZONE2 video out is only for the ZONE2.

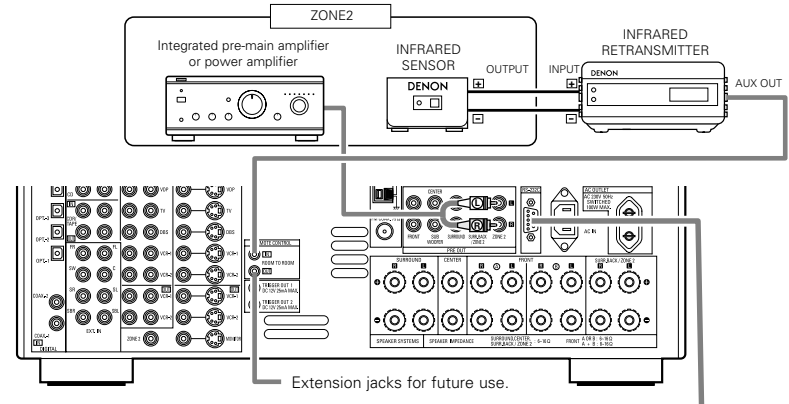

CONTROL terminal

Perform the following operation before using an external controller connected to the RS-232C terminal:

1. Press the ON/STANDBY button on the main unit and set the unit to the operating mode.
2. Perform the operation to turn off the power from the external control.
3. Check that the product has been set to the standby mode.

After checking the above, check the connections of the external controller. Operation is possible.

[2] ZONE2 SPEAKER OUT and PREOUT CONNECTIONS

- If another power amplifier or pre-main (integrated) amplifier is connected, the ZONE2 output terminals can be used to play a different program source in ZONE2 the same time.
- ZONE2 SPEAKER OUT can be used when "ZONE2" is selected at System Setup Menu "Power Amp Assign". In this case, Surround Back Speaker OUT cannot be used for MAIN ZONE. (See page 25)

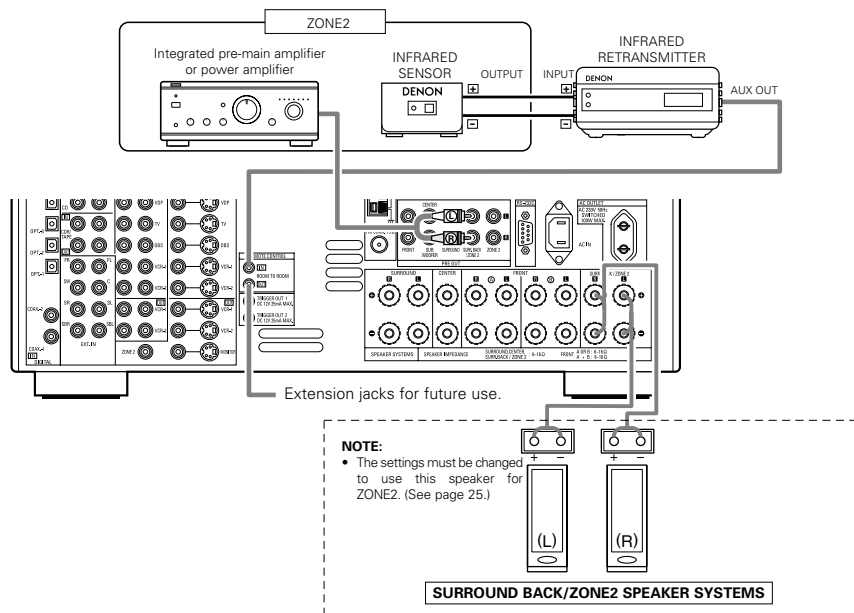

Speaker system connections

- Connect the speaker terminals with the speakers making sure that like polarities are matched (⊕ with ⊕, ⊖ with ⊖). Mismatching of polarities will result in weak central sound, unclear orientation of the various instruments, and the sense of direction of the stereo being impaired.
 - When making connections, take care that none of the individual conductors of the speaker cord come in contact with adjacent terminals, with other speaker cord conductors, or with the rear panel.
- Speaker Impedance**
- Speakers with an impedance of from 6 to 16 Ω/ohms can be connected for use as front, center, surround and surround back speakers.
 - Be careful when using two pairs of front speakers (A + B) at the same time, since use of speakers with an impedance of less than 8 Ω/ohms will lead to damage.
 - The protector circuit may be activated if the set is played for long periods of time at high volumes when speakers with an impedance lower than the specified impedance are connected.

NOTE:
NEVER touch the speaker terminals when the power is on.
Doing so could result in electric shocks.

Connecting the speaker terminals

1. Loosen by turning counterclockwise.
2. Insert the cord.
3. Tighten by turning clockwise.

Either tightly twist or terminate the core wires.

Protector circuit

- This unit is equipped with a high-speed protection circuit. The purpose of this circuit is to protect the speakers under circumstances such as when the output of the power amplifier is inadvertently short-circuited and a large current flows, when the temperature surrounding the unit becomes unusually high, or when the unit is used at high output over a long period which results in an extreme temperature rise. When the protection circuit is activated, the speaker output is cut off and the power supply indicator LED flashes. Should this occur, please follow these steps: be sure to switch off the power of this unit, check whether there are any faults with the wiring of the speaker cables or input cables, and wait for the unit to cool down if it is very hot. Improve the ventilation condition around the unit and switch the power back on. If the protection circuit is activated again even though there are no problems with the wiring or the ventilation around the unit, switch off the power and contact a DENON service center.

Note on speaker impedance

- The protector circuit may be activated if the set is played for long periods of time at high volumes when speakers with an impedance lower than the specified impedance (for example speakers with an impedance of lower than 4 Ω/ohms) are connected. If the protector circuit is activated, the speaker output is cut off. Turn off the set's power, wait for the set to cool down, improve the ventilation around the set, then turn the power back on.

Connecting the video component equipped with V. AUX jacks

To connect the video signal, connect using a 75 Ω/ohms video signal cable cord.

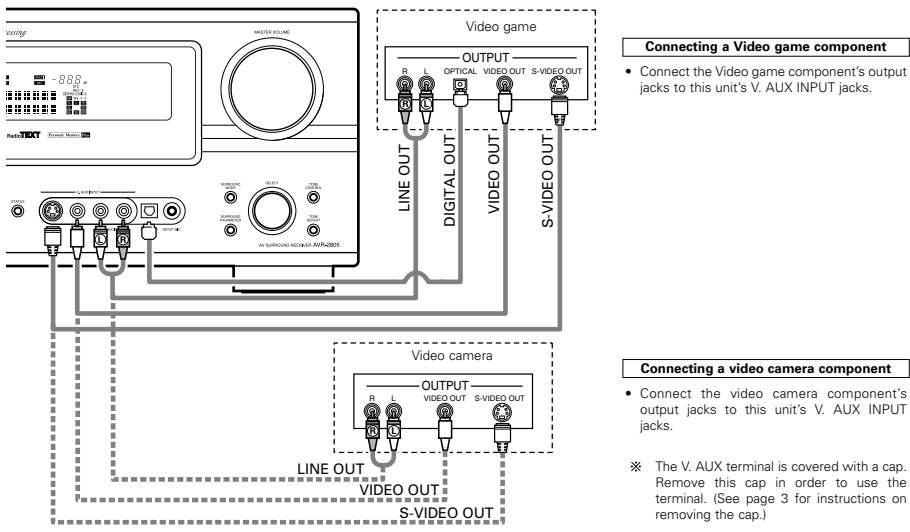

Connections

- When making connections, also refer to the operating instructions of the other components.

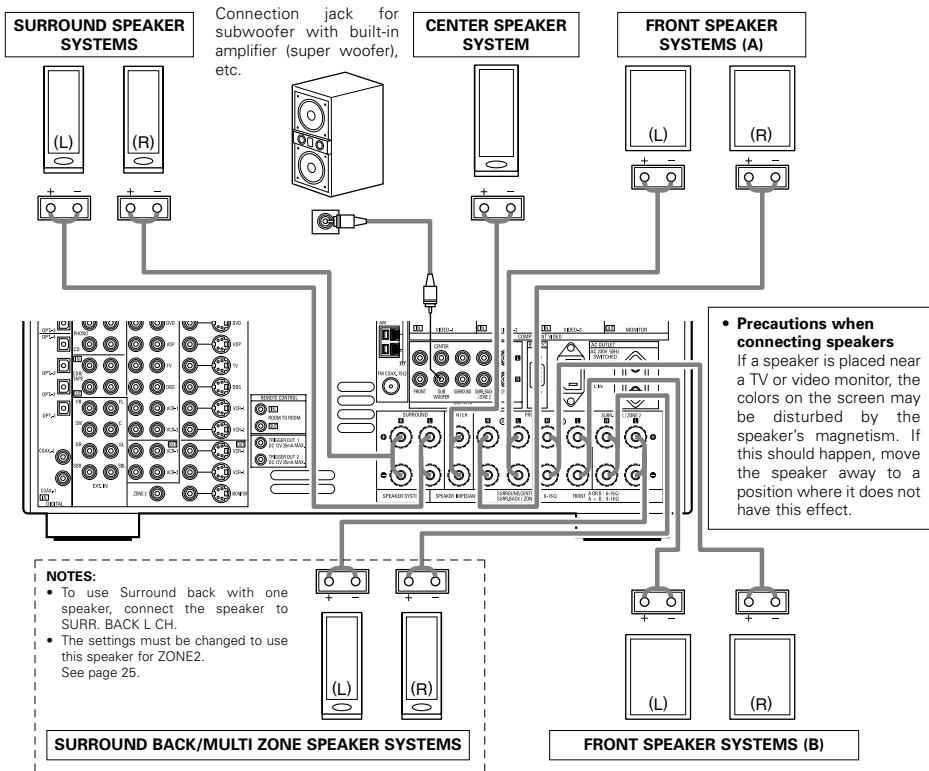

6 PART NAMES AND FUNCTIONS

Front Panel

- For details on the functions of these parts, refer to the pages given in parentheses ().

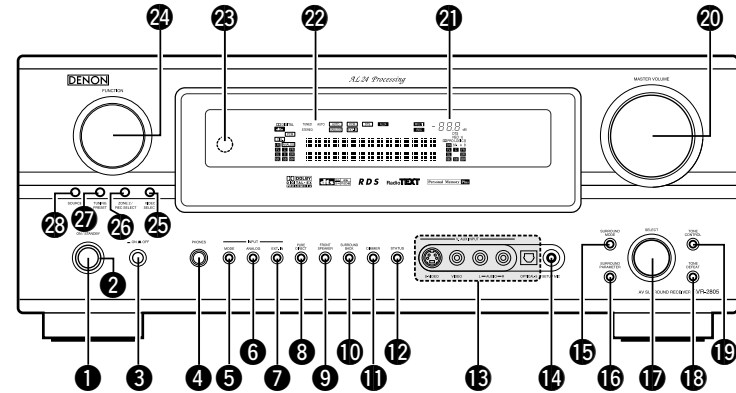

- 1 Power ON/STANDBY switch.....(34)
- 2 POWER indicator.....(34)
- 3 Power switch(34, 52)
- 4 Headphone jack (PHONES)(36)
- 5 INPUT MODE button(34)
- 6 ANALOG button(34)
- 7 EXT. IN button(34, 35)
- 8 PURE DIRECT button(36)
- 9 FRONT SPEAKER button(34)
- 10 SURROUND BACK button(42)
- 11 DIMMER button.....(37)
- 12 STATUS button(37)
- 13 V. AUX input jacks(8)
- 14 SETUP MIC jack.....(13)
- 15 SURROUND MODE button.....(35, 46)
- 16 SURROUND PARAMETER button(40~42)
- 17 SELECT knob.....(35, 36, 40~44, 46, 47)
- 18 TONE DEFEAT button(36)
- 19 TONE CONTROL button(36, 47)
- 20 MASTER VOLUME control(35)
- 21 MASTER VOLUME indicator (VOLUME LEVEL).....(35)
- 22 Display
- 23 Remote control sensor (REMOTE SENSOR)(29)
- 24 FUNCTION knob.....(34, 37, 38, 48, 49)
- 25 VIDEO SELECT button(37)
- 26 ZONE2/REC SELECT button(37, 38)
- 27 TUNING PRESET button(49)
- 28 SOURCE button(34)

Display

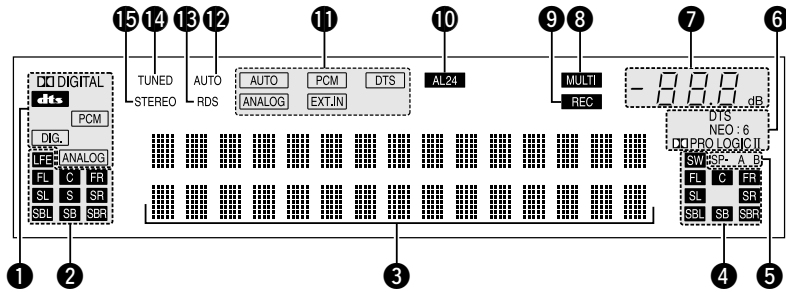

- 1** INPUT SIGNAL indicator
The respective indicator will light corresponding to the input signal.
- 2** INPUT SIGNAL CHANNEL indicator
The channels included in the input source will light.
This displays bitstream signal channel.
This does not light when signals are being input to the ANALOG or EXT.IN connectors.
- 3** Information display
This displays the surround mode, function name or setting value, etc.
- 4** OUTPUT SIGNAL CHANNEL indicator
The audio channels output from this unit will light.
- 5** SPEAKER indicator
This lights corresponding to the settings of the front speakers.
- 6** Decoder indicator
This lights when each decoder is operating.
- 7** MASTER VOLUME indicator
This displays the volume level.
The Setup item number is displayed in System Setup.
- 8** MULTI (ZONE) indicator
ZONE2 mode is selected in ZONE2/REC SELECT.
- 9** REC OUT SOURCE indicator
REC OUT mode is selected in ZONE2/REC SELECT.
- 10** AL24 indicator
The AL24 indicator lights when the PURE DIRECT, DIRECT and STEREO mode is selected in the PCM input signal.
- 11** INPUT MODE indicator
This lights corresponding to the setting of the INPUT mode.
- 12** AUTO indicator
This lights when the broadcast station is selected in the AUTO tuning mode.
- 13** RDS indicator
This lights when an RDS broadcast has been received.
- 14** TUNED indicator
This lights when an FM/AM broadcast has been received.
- 15** STEREO indicator
This lights when an FM stereo broadcast has been received.

Remote control unit

- For details on the functions of these parts, refer to the pages given in parentheses ().

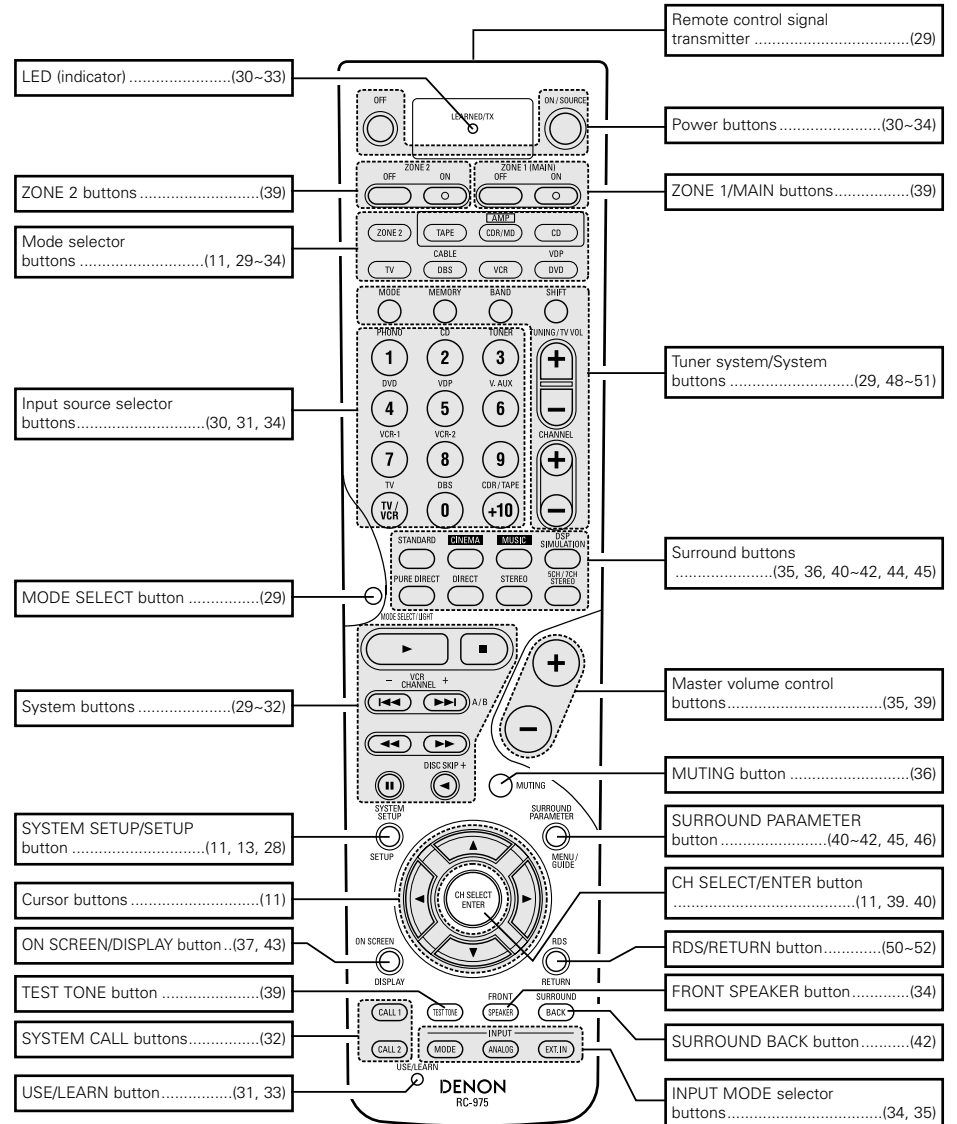

7 SETTING UP THE SYSTEM

- Once all connections with other AV components have been completed as described in "CONNECTIONS" (see pages 5 to 9), make the various settings described below on the monitor screen using the AVR-2805's on-screen display function. These settings are required to set up the listening room's AV system centered around the AVR-2805.

Use the following buttons to set up the system

- Use the following buttons to set up the system.

- Check that the remote control unit set to AMP mode. (TAPE, CDR/MD, CD)

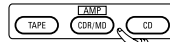

(Remote control unit)

2

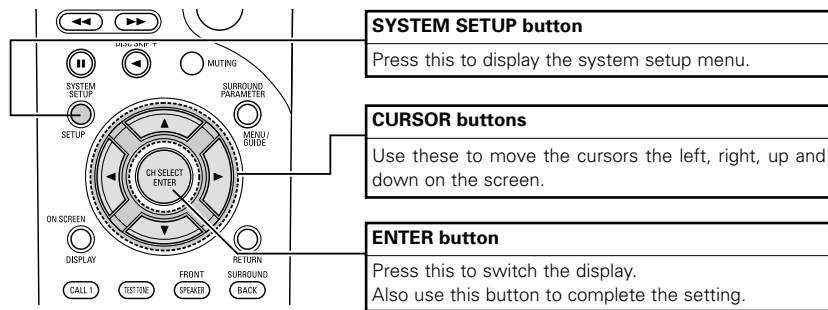

- System setup items and default values (set upon shipment from the factory)

1. Auto Setup/Room EQ

Auto Setup/Room EQ			Default settings
1	Auto Setup	Power Amp Assignment Set this to switch the surround back channel's power amplifier for use for zone2.	SURROUND BACK
2	Manual EQ Setup	This parameter is for optimizing the Room EQ with which the audio signals are produced from the speakers.	All Channel and Frequency=0 dB
3	Room EQ Setup	Set the Room EQ setting with All or Assign for each surround mode.	All
4	Direct Mode Setup	Set the ON/OFF setting of Room EQ, in the case of the surround mode is in Direct or Pure Direct.	OFF
5	Mic Input Select	Set this to switch the Mic Input jack for use for Mic or V.Aux L-channel input jack.	Mic

2. Speaker Setup

Speaker Setup		Default settings					
1	Speaker Configuration	Input the combination of speakers in your system and their corresponding sizes (SMALL for regular speakers, LARGE for full-size, full-range) to automatically set the composition of the signals output from the speakers and the frequency response.					
		Front Sp.	Center Sp.	Subwoofer	Surround Sp.	Surround Back Sp.	
2	Delay Time	This parameter is for optimizing the timing with which the audio signals are produced from the speakers and subwoofer according to the listening position.					
		Front L & R	Center	Subwoofer	Surround L & R	SBL & SBR	
3	Channel Level	This adjusts the volume of the signals output from the speakers and subwoofer for the different channels in order to obtain optimum effects.					
		Front L	Front R	Center	Surround L	Surround R	Surround Back L
4	Crossover Frequency	Set the frequency (Hz) below which the bass so of the various speaker is to be output from the subwoofer.					
5	Subwoofer Mode	This selects the subwoofer speaker for playing deep bass signals.					

3. Input Setup

Input Setup		Default settings										
1	Digital In Assignment	This assigns the digital input jacks for the different input sources.		Input source								
		COAX1	COAX2	OPT1	OFF	OPT2	OPT5	OPT3	OFF	OPT4		
2	Ext. In Subwoofer Level	Set the Ext. In Subwoofer terminal playback level.		Subwoofer = +15 dB								
3	Component In Assign	This assigns the color difference (component) video input jacks for the different input sources.		DVD	VDP	TV	DBS	VCR-1	VCR-2	V. AUX	—	—
		VIDEO 1	NONE	VIDEO 2	VIDEO 3	NONE	NONE	NONE	—	—		
4	Video Input Mode	Set the input signal to be output from the monitor output terminal.		AUTO								
5	Auto Tuner Presets	FM stations are received automatically and stored in the memory.		A1 ~ AB	87.5/89.1/98.1/108.0/90.1/90.1/90.1 MHz							
		B1 ~ BB	522/603/999/1404/1611 kHz, 90.1/90.1/90.1 MHz									
		C1 ~ CB	90.1 MHz									
		E1 ~ E8	90.1 MHz									
		F1 ~ F8	90.1 MHz									
G1 ~ GB	90.1 MHz											

4. Advanced Playback

Advanced Playback			Default settings
1	Audio Delay	Set the audio delay to delay time the sound and synchronize it with the picture.	0 ms
2	Dolby Digital Setup	Turn the audio compression on or off when down-mixing Dolby Digital signals.	OFF
3	Auto Surround Mode	Set the Auto surround mode function.	Auto Surround Mode = ON

5. Option Setup

Option Setup			Default settings										
1	Power AMP Assignment	Set this to switch the surround back channel's power amplifier for use for zone2.	Surround Back										
2	Zone2 vol. Level	This sets the output level the zone2 output jacks. This menu is not displayed, when "ZONE2" is selected at Option Setup "Power Amp Assign".	Variable										
3	Trigger Out1 Setup	Set the Trigger Out1 output for the each input sources.	ZONE=MAIN										
			PHONO	CD	TUNER	CDR/TAPE	DVD	VDP	TV	DBS	VCR-1	VCR-2	V. AUX
			OFF	OFF	OFF	OFF	ON	ON	ON	ON	ON	ON	ON
4	Trigger Out2 Setup	Set the Trigger Out2 output for the each input sources.	ZONE=2										
			PHONO	CD	TUNER	CDR/TAPE	DVD	VDP	TV	DBS	VCR-1	VCR-2	V. AUX
			ON	ON	ON	ON	ON	ON	ON	ON	ON	ON	ON
5	Muting Level	This sets the amount of attenuation at audio output muting.	-dB (minimum)										
6	On Screen Display	This sets whether or not to display the on-screen display that appears on the monitor screen when the controls on the remote control unit or main unit are operated. A setting to prevent flickering.	On Screen Display = ON / Mode 1										
7	Setup Lock	Set whether or not to lock the system setup settings so that they cannot be changed.	Setup Lock = OFF										

NOTES:

- The on-screen display signals are output with priority to the S-VIDEO MONITOR OUT jack during playback of a video component. For example, if the TV monitor is connected to both the AVR-2805's S-Video and video monitor output jacks and signals are input to the AVR-2805 from a video source (VDP, etc.) connected to both the S-Video and video input jacks, the on-screen display signals are output with priority to the S-Video monitor output. If you wish to output the signals to the video monitor output jack, do not connect a cord to the S-VIDEO MONITOR OUT jack. (For details, see page 28.)
- The AVR-2805's on-screen display function is designed for use with high resolution monitor TVs, so it may be difficult to read small characters on TVs with small screens or low resolutions.
- The setup menu is not displayed when headphone are being used.

• Speaker system layout

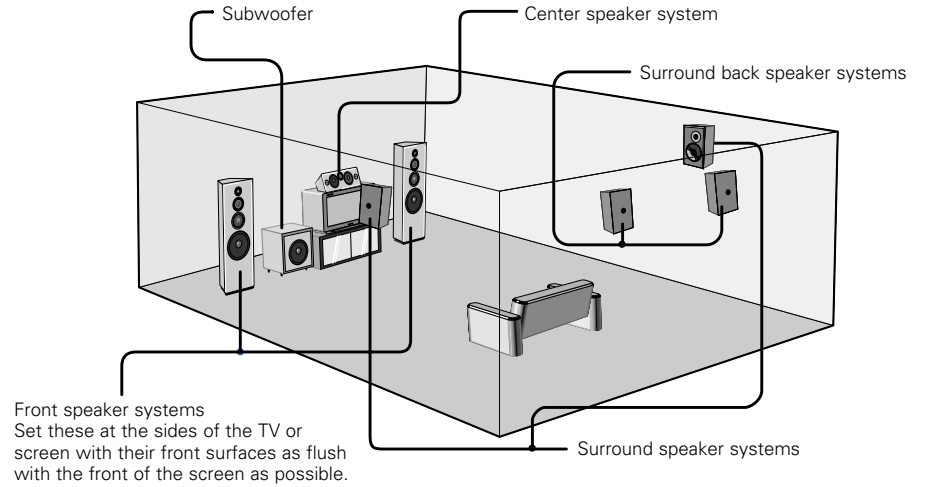

Basic system layout

- The following is an example of the basic layout for a system consisting of eight speaker systems and a television monitor:



Before setting up the system

- 1 Check that all the connections are correct, then turn on the main unit's power. Setup will not be possible when the unit is set to Pure Direct ON or when the headphones are plugged in. Therefore, please cancel the mode or reverse the condition.

- 2  Display the System Setup Menu.  (Remote control unit)

*System Setup
Auto Set/RoomEQ

System Setup Menu

- 1. Auto Setup/Room EQ
- 2. Speaker Setup
- 3. Input Setup
- 4. Advanced Playback
- 5. Option Setup

Exit

NOTES:

- The System Setup menu composition is of a layered design that includes the related items below the large table title as contained in the tables of Pages 11 and 12.
- Wherever your position in System Setup, one more press of the System Setup button permits a move to one level higher.

Auto setup/Room EQ

The Auto Setup function of this unit performs an analysis of the speaker system and measures the acoustic characteristics of your room to permit an appropriate automatic setting.

※ When performing Auto Setup, a microphone is required for the setup.

Measurement and setting details

- 1 **Speaker Config.:** This sets the speaker connection mode, polarity, and bass reproduction ability.
- 2 **Delay Time :** This sets the optimum delay time from each speaker corresponding to the listening position.
- 3 **Channel Level :** This sets the volume that is output from each speaker.
- 4 **Room EQ :** This sets the frequency response of each speaker.

NOTE:

- A loud test tone is output during the measurement. Please consider this should you be planning nighttime measurements, and consider not allowing small children into the listening room at this time.

Connecting the microphone for Auto Setup

- 1 Connect the microphone for Auto Setup to the Setup Mic connector on the front panel of the unit.

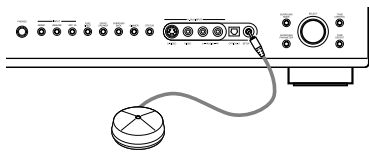



NOTE:

- When using other microphone. (See page 16)

- 2 Place the microphone for Auto Setup at the actual listening position which will be at the same height as your ears. Use a tripod or level surface at positioning.

1 Setting the Auto Setup / Room EQ



- 1  Select "Auto Setup / Room EQ" at the System Setup Menu.  (Remote control unit)

*System Setup
Auto Set/RoomEQ



System Setup Menu

- 1. Auto Setup/Room EQ
- 2. Speaker Setup
- 3. Input Setup
- 4. Advanced Playback
- 5. Option Setup

Exit

- 2  Display the Auto Setup / Room EQ menu.  (Remote control unit)

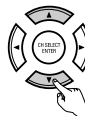
1-1 Setting the Auto Setup



- 1  Select "Auto Setup" at the Auto Setup / Room EQ Menu.  (Remote control unit)

*AutoSet/RoomEQ
Auto Setup

1. Auto Setup/Room EQ

- 1. Auto Setup
- 2. Manual EQ Setup
- 3. Room EQ Setup
- 4. Direct Mode Setup
- 5. Mic Input Select

Exit

- 2  Display the Auto Setup screen.  (Remote control unit)

- 3 Check the "Power Amp Assign" setting.
 - When "Surround Back" is selected, the test tone during Auto Setup will be output from the Surround Back speaker.
 - When "ZONE2" is selected, change the setting to "ZONE2". The test tone during Auto Setup is set so that it will not be output to ZONE2 (Another room).

- 1 Select the Power Amp Assign setting.
- 2 Select "Surround Back" or "ZONE2".

 (Remote control unit)

1-1. Auto Setup

Connect Microphone

Power Amp Assign
◀ SurroundBack ▶

Start
Cancel

 (Remote control unit)

*Auto Setup
P.AMP: SB

NOTE:

- When "ZONE2" is selected at System Setup Menu "Power Amp Assign", surround back speaker is not displayed as the target of setup in "2-1. Speaker Config.". The results is reflected in "5-1. Power Amp Assign".

4

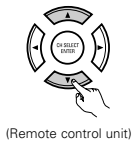

① Select the "Start".

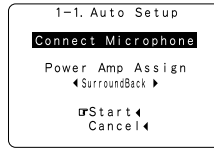

② Press the CURSOR left button.

5

Start the measurements.

Measurement of each channel is performed as follows. Display

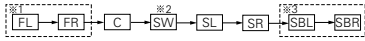

※1 Only the front speakers (A) is measured. Even if the front speakers (B) is set, the setting automatically switches to the front speakers (A) once measurements are completed.

※2 Subwoofer speaker is measured twice.

※3 When "ZONE2" is selected, this is not displayed. After each channel is measured, "Calculating" appears.

The display switches to Auto Setup check screen automatically.

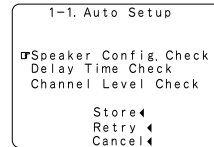
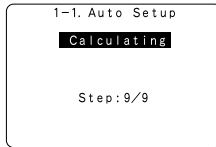
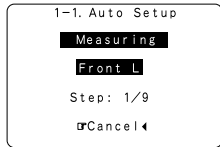

NOTES:

- Measurement is canceled when MASTER VOLUME is operated while the Auto Setup is performed.
- Set the volume to halfway and set the crossover frequency to the maximum or low pass filter off if your subwoofer can adjust the output volume and the crossover frequency.

About the error message

These error screens will be displayed when performing the measurements of Auto Setup / Room EQ and the automatic measurements can not be completed because of the speaker arrangement, measurement environment, or other factors. Please check the following matters, reset the pertinent items, and measure again. When there is too much noise in the room, the speakers may not be detected properly. Should this happen, perform the measurements when the noise level is low, or switch off the power of the equipment that is producing the noise for the duration of the measurements.

- ① This screen will be displayed when the speakers required for producing suitable reproduction have not been detected.
- The front L and front R speakers were not properly detected.
 - Only one channel of the surround speakers was detected.
 - Sound was output from the R channel when only one surround back speaker was connected.
 - The surround back was detected, but the surround speaker was not detected.

Check that the pertinent speakers are properly connected. (see page 9)

- ③ This screen will be displayed when accurate measurements cannot be made due to the input level to the microphone being too high.

Set up the speakers so that their position is farther away from the listening position. Lower the volume of the subwoofer.



- ④ This screen will be displayed when the measurement microphone is not connected, or when all of the speakers have not been detected.

Connect the measurement microphone to the microphone connector. Check the speaker connections.

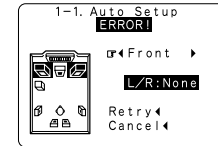

- ② This screen will be displayed when the speaker polarity is connected in reverse.

Check the polarity of the pertinent speakers. For some speakers, the screen below may be displayed even though the speakers are properly connected. If so, select "Skip".

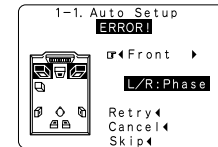

About automatic retry

Remeasurement starts automatically to receive proper result of measurement. Remeasurement is performed to 2 times, and "Retry1" or "Retry2" is displayed on screen during remeasurement.

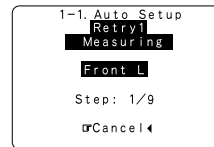

Check of the measurement results

1  Select the items.
The measurement results of each item can be checked here.

*Auto Setup
Sp Config.Check

1-1. Auto Setup

Speaker Config. Check
Delay Time Check
Channel Level Check

Store ←
Retry ←
Cancel ←

(Remote control unit)

2  Press the ENTER button and display the verification screen.

NOTE:

- When measurements have been made using the measurement microphone, speakers with a built-in filter such as subwoofers might be set with a value that differs from the physical distance because of the internal electrical delay.

[Speaker Config. Check]

Speaker Config. Check

Front Sp. [Large] [Small]
Center Sp. [Large] [Small]
Subwoofer [Yes] [No]

[Delay Time Check]

Delay Time Check

FL 3.60m
FR 3.60m
Center 3.60m
Subwoofer 3.60m

[Channel Level Check]

Channel Level Check

FL 0.0dB
FR 0.0dB
Center 0.0dB
Subwoofer 0.0dB

Speaker Config. Check

Surround Sp. [Large] [Small] [None]
Sp. Back. [Large] [Small] [None]

[Delay Time Check]

SL 3.00m
SR 3.00m
SBL 3.00m
SBR 3.00m

[Channel Level Check]

SL 0.0dB
SR 0.0dB
SBL 0.0dB
SBR 0.0dB

(Remote control unit)

3  If the check ends, press the ENTER button again.

(Remote control unit)

4  Select from the following three items based on the measurement results.

- Store : Set with the checked measurement value.
- Retry : Perform the measurement again.
- Cancel : Cancel the checked measurement value.

*Auto Setup
Store ←

1. Auto Setup

Speaker Config. Check
Delay Time Check
Channel Level Check

Store ←
Retry ←
Cancel ←

(Remote control unit)

5  When the "Store" is selected, all parameters are stored up.
When the "Retry" is selected, it measures again.

1-1. Auto Setup

Parameter Storing

(Remote control unit)

1-2 Setting the Manual EQ Setup

Adjust the tone of the various speakers except subwoofer while listening to the sound (music).

1  Select "Manual EQ Setup" at the Auto Setup / Room EQ Menu.

*AutoSet/RoomEQ
Manual EQ Setup

1. Auto Setup/Room EQ

1. Auto Setup
 2. Manual EQ Setup
3. Room EQ Setup
4. Direct Mode Setup
5. Mic Input Select
6. EQ Parameter Check

Exit

(Remote control unit)

2  Display the Manual EQ Setup screen.

*ManualEQ Setup
Channel : 4 FL →

1-2. Manual EQ Setup

Front L →

63Hz 0.0dB
125Hz 0.0dB
250Hz 0.0dB
500Hz 0.0dB
1kHz 0.0dB
2kHz 0.0dB
4kHz 0.0dB
8kHz 0.0dB

(Remote control unit)

3  Select the speaker to be set.
The display changes as follows.

*ManualEQ Setup
Channel : 4 FL →

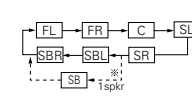

1-2. Manual EQ Setup

Front L →

63Hz 0.0dB
125Hz 0.0dB
250Hz 0.0dB
500Hz 0.0dB
1kHz 0.0dB
2kHz 0.0dB
4kHz 0.0dB
8kHz 0.0dB

Flashing

※ When the surround back speaker setting is set to "1spkr" at "Speaker Configuration", this is set to "SB".

(Remote control unit)

4  Select the frequency.

*ManualEQ Setup
63Hz : 4 0.0dB

1-2. Manual EQ Setup

Front L →

63Hz ← 0.0dB

125Hz 0.0dB
250Hz 0.0dB
500Hz 0.0dB
1kHz 0.0dB
2kHz 0.0dB
4kHz 0.0dB
8kHz 0.0dB

(Remote control unit)

5  Use the cursor left and right buttons to adjust the Gain level.

- Each frequency can be adjusted the range from -6 dB to +6 dB in 0.5 dB step.

(Remote control unit)

6  Enter the setting.
The Auto Setup / Room EQ Menu reappears.

(Remote control unit)

1-3 Setting the Room EQ Setup

Select the setting of an Equalizer that has been set with Auto Setup or Manual EQ.

1  Select "Room EQ Setup" at the Auto Setup / Room EQ Menu.

*AutoSet/RoomEQ
Room EQ Setup

1. Auto Setup/Room EQ
1. Auto Setup
2. Manual EQ Setup
3. Room EQ Setup
4. Direct Mode Setup
5. Mic Input Select
6. EQ Parameter Check
Exit

2  Display the Room EQ Setup screen.

*Room EQ Setup
SurMode: ALL

1-3. Room EQ Setup
Relation To
The Surround Mode
ALL ← Assign

3  Select All or Assign.

- All : The Equalizer to all Surround mode is set as once.
- Assign : The Equalizer to each surround mode is to set individually.

4  When the All is selected and press the ENTER button, display the Select the EQ Curve screen. Select the Equalizer setting.

*Room EQ Setup
RoomEQ: Normal

1-3. Room EQ Setup
Select the EQ Curve
Room EQ Normal

- OFF : The Equalizer is not used.
- Normal : Adjusts the frequency response of all speakers suitable for general surround system.
- Front : Adjusts the characteristics of each speaker to the characteristics of the front speakers.
- Flat : Adjusts the frequency response of all speakers flat.
This is suitable for music reproduction like ITU-R speaker setting.
- Manual : Selects the setting value that was set in the Manual EQ setup.

NOTES:

- The Equalizer setting of Normal, Front and Flat can be selected after performing the Auto Setup.
- When the speaker set as "None" with the Auto Setup is change to on manually, the equalizer of "Normal", "Front" and "Flat" cannot be used.
- The Equalizer setting can be selected by SURROUND PARAMETER button in Main unit or Remote control unit.
- When headphone is connected, the Room EQ cannot be used.

5  Enter the setting. The Auto Setup / Room EQ Menu reappears.

1-4 Setting the Direct Mode

Perform the ON/OFF setting of Room EQ when the surround mode is Direct or Pure Direct.

1  Select "Direct Mode Setup" at the Auto Setup / Room EQ Menu.

*AutoSet/RoomEQ
Direct Mode

1. Auto Setup/Room EQ
1. Auto Setup
2. Manual EQ Setup
3. Room EQ Setup
4. Direct Mode Setup
5. Mic Input Select
6. EQ Parameter Check
Exit

2  Display the Direct Mode Setup screen.

*Direct Mode
Room EQ OFF

1-4. Direct Mode Setup
DIRECT/PURE DIRECT
Room EQ ON OFF

3  Select ON or OFF. **4**  Enter the setting. The Auto Setup / Room EQ Menu reappears.

1-5 Setting the MIC Input Select

- Use this setting when using a microphone other than the included one for measurements when performing the auto setup procedure.
 - The microphone included with the AVR-2805 is a measurement microphone designed specifically for use during the auto setup procedure. Select "Mic" and connect the included microphone to the "SETUP MIC" mini-jack. When conducting the auto setup procedure using a separate high performance condenser microphone for measurements, select "V.AUX L" and connect the microphone to the "V.AUX Lch" pin jack.
- ※ Please ask the DENON Authorized Service Center about the usable microphone other than the included one.

1  Select "Mic Input Select" at the Auto Setup / Room EQ Menu.

*AutoSet/RoomEQ
Mic In Select

1. Auto Setup/Room EQ
1. Auto Setup
2. Manual EQ Setup
3. Room EQ Setup
4. Direct Mode Setup
5. Mic Input Select
6. EQ Parameter Check
Exit

2  Display the Mic Input Select screen. **3**  Select the Mic input jack or V.AUX L jack.

*Mic In Select
Mic

1-5. Mic Input Select
Mic V.AUX L

4  Enter the setting. The Auto Setup / Room EQ Menu reappears.

*Mic In Select
Mic

1-6 Check the EQ parameter

- The frequency characteristic of each speaker is rectified and the tone of the speaker is unified. The EQ parameters that were set in Auto Setup can be checked. This item is automatically displayed, after the measurement result of the "Auto Setup / Room EQ" is decided.

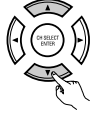
1  Select "EQ Parameter Check" at the Auto Setup / Room EQ Menu.

(Remote control unit)

*AutoSet/RoomEQ
Parameter Check

1. Auto Setup/Room EQ
 1. Auto Setup
 2. Manual EQ Setup
 3. Room EQ Setup
 4. Direct Mode Setup
 5. Mic Input Select
 6. EQ Parameter Check
 Exit

2  Display the EQ Parameter Check screen.

(Remote control unit)

*ParameterCheck
1:Normal

1-6. EQ Parameter Check
 1:Normal
 2:Front
 3:Flat
 Exit

3 Select the Equalizer curve.

 (Remote control unit)

5 Select the speaker channel.

 (Remote control unit)



4 Display the parameter screen.

(Remote control unit)

1:Normal EQ ◀ Front L ▶
 Freq Q Gain
 57Hz 0.1 -1.0dB
 110Hz 0.5 0.0dB
 250Hz 0.1 +0.5dB
 510Hz 1.3 +1.0dB
 1.1kHz 2.1 0.0dB
 2.6kHz 0.5 0.0dB
 4.8kHz 0.1 0.0dB
 10kHz 0.1 +3.0dB



6 Enter the setting.

(Remote control unit)

7  →  If the check ends, select "Exit" and press the ENTER button. The Auto Setup / Room EQ Menu reappears.

(Remote control unit) (Remote control unit)

1-6. EQ Parameter Check
 1:Normal
 2:Front
 3:Flat
 Exit

8  →  Select "Exit" and press the ENTER button at the Auto Setup / Room EQ Menu screen. The System Setup Menu reappears.

(Remote control unit) (Remote control unit)

1. Auto Setup/Room EQ
 1. Auto Setup
 2. Manual EQ Setup
 3. Room EQ Setup
 4. Direct Mode Setup
 5. Mic Input Select
 6. EQ Parameter Check
 Exit

2 Setting the Speaker Setup

- Crossover Frequency and Subwoofer Mode Setup is not displayed when not using a subwoofer.

1 Select "Speaker Setup" at the System Setup Menu.

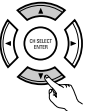

(Remote control unit)

*System Setup
2
Speaker Setup

System Setup Menu
 1. Auto Setup/Room EQ
 2. Speaker Setup
 3. Input Setup
 4. Advanced Playback
 5. Option Setup
 Exit

2 Display the Speaker Setup Menu screen.



(Remote control unit)

*Speaker Setup
2
Speaker Config.

2. Speaker Setup
 1. Speaker Config.
 2. Delay Time
 3. Channel Level
 4. Crossover Frequency
 5. Subwoofer Mode Setup
 Exit

2-1 Setting the type of speakers

- The composition of the signals output to each channels and the frequency response are adjusted automatically according to the combination of speakers actually being used.

1 Select "Speaker Config." at the Speaker Setup Menu.



(Remote control unit)

*Speaker Setup
2
Speaker Config.

2. Speaker Setup
 1. Speaker Config.
 2. Delay Time
 3. Channel Level
 4. Crossover Frequency
 5. Subwoofer Mode Setup
 Exit

2 Display the speaker configuration screen as below.



(Remote control unit)

3 Set whether speakers are connected or not and, if so, their size parameters.

① Select the speaker



(Remote control unit)

*Speaker Config
2
FrontSp: Large

2-1. Speaker Config.
 FrontSp.
 Center Sp.
 Surround Sp.
 Subwoofer
 Yes No

2-1. Speaker Config.
 Surround
 Sp. Back
 Large Small None
 DupLr DupRr

② Select the parameter



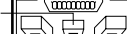

(Remote control unit)

Center Sp. 

Front Sp. 

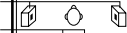
Subwoofer 

Surround Sp. 

Surround back Sp. 

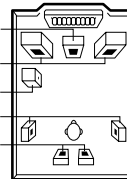

4 ENTER the setting.
The Speaker Setup Menu reappears.



(Remote control unit)

NOTE:

- Select "Large" or "Small" not according to the actual size of the speaker but according to the speaker's capacity for playing low frequency (bass sound below the frequency set for the Crossover Frequency) signals. If you do not know, try comparing the sound at both settings (setting the volume to a level low enough so as not to damage the speakers) to determine the proper setting.

• **Parameters**

- Large.....Select this when using speakers that have sufficient performance for reproducing bass sound below the frequency set for the Crossover Frequency mode.
- Small.....Select this when using speakers that do not have sufficient performance for reproducing bass sound below the frequency set for the Crossover Frequency mode. When this is set, bass sound with a frequency below the frequency set for the Crossover Frequency mode is sent to the subwoofer.
- None.....Select this when no speakers are installed.
- Yes/No.....Select "Yes" when a subwoofer is installed, "No" when a subwoofer is not installed.
- 2spkr/1spkrSet the number of speakers to be used for the surround back channel.
- ※ If the subwoofer has sufficient low frequency playback capacity, good sound can be achieved even when "Small" is set for the front, center and surround speakers.

2-2 Setting the Delay Time

- Input the distance between the listening position and each speakers to set the delay time for the surround playback.

Preparations:

Measure the distances between the listening position and the speakers (L1 to L5 on the diagram at the right).

- L1: Distance between center speaker and listening position
- L2: Distance between front speakers and listening position
- L3: Distance between surround speakers and listening position
- L4: Distance between surround back speakers and listening position
- L5: Distance between subwoofer and listening position

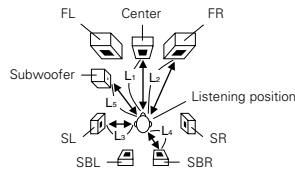

1

(Remote control unit)

Select "Delay Time" at the Speaker Setup Menu.

*Speaker Setup
Delay Time 2.2

2. Speaker Setup
 1. Speaker Config.
 2. Delay Time
 3. Channel Level
 4. Crossover Frequency
 5. Subwoofer Mode Setup
 Exit

2

(Remote control unit)

Display the Delay Time screen.

*Delay Time 2.2
Meters: Feet

2-2. Delay Time
 Set The Distance To Each Speakers
 Do You Prefer In Meters? / In Feet?
Meters <: >: Feet

3

(Remote control unit)

Select the desired unit, meters or feet.

2-2. Delay Time
 Set The Distance To Each Speakers
 Do You Prefer In Meters? / In Feet?
Meters <: >: Feet

Example: When "Meters" is selected

4 Once "Meters" or "Feet" is selected in step 3, the Delay Time screen appears automatically.

2-2. Delay Time
 Step < 0.1m >
 Default Yes <

2-2. Delay Time
 FL < 3.60m >
 FR 3.60m
 Center 3.60m
 Subwoofer 3.60m

2-2. Delay Time
 SL < 3.00m >
 SR 3.00m
 SBL 3.00m
 SBR 3.00m

*Delay Time 2.2
FL: 4 3.6m

5 Select the speaker to be set. The picture of the speaker selected blinks.

(Remote control unit)

6 Set the distance between the center speaker and listening position. The distance changes in units of 0.03 meters (0.1 foot) each time the button is pressed. Select the value closest to the measured distance.

2-2. Delay Time
 Step < 0.1m >
 Default Yes <

2-2. Delay Time
 FL 3.60m
 FR 3.60m
 Center 3.60m
 Subwoofer 3.60m

2-2. Delay Time
 SL < 3.00m >
 SR 3.00m
 SBL 3.00m
 SBR 3.00m

Example: When the distance is set to 3.6 m for the center speaker

※ If "Yes" is selected for "Default", the settings are automatically reset to the default values.

Please note that the difference of distance for every speaker should be 6.0 m (20 ft) or less. If you set an invalid distance, a CAUTION notice, such as screen right will appear. In this case, please relocate the blinking speaker(s) so that its distance is no larger than the value shown in highlighted line.

RELOCATE BLINKING SP!

 Step < 0.1m >
 Default Yes <

FL	4.50m
FR	4.50m
Center	3.60m
Subwoofer	9.60m

7 Enter the setting. The Speaker Setup Menu reappears. The AVR-2805 automatically sets the optimum surround delay time for the listening room.

(Remote control unit)

NOTE:

- If the distance unit is changed after the delay time is set, the settings are reset to the factory default values (see page 11).

2-3 Setting the Channel Level

- Use this setting to adjust so that the playback level between the different channels is equal.
- From the listening position, listen to the test tones produced from the speakers to adjust the level.
- The level can also be adjusted directly from the remote control unit. (For details, see page 39.)

1  Select "Channel Level" at the Speaker Setup Menu.

(Remote control unit)

2.3

*Speaker Setup
Channel Level

2. Speaker Setup

1. Speaker Config.
2. Delay Time
3. Channel Level
4. Crossover Frequency
5. Subwoofer Mode Setup

Exit

2  Display the Channel Level screen.

(Remote control unit)

2.3

*Channel Level
T.Tone: Auto

2-3. Channel Level

Test Tone **Auto** < > Manual

Test Tone Start **Yes** <

Level Clear **Yes** <

3  Select the mode. Select "Auto" or "Manual".

(Remote control unit)

2.3

*Channel Level
T.Tone: Auto

2-3. Channel Level

Test Tone **Auto** < > Manual

Test Tone Start **Yes** <

Level Clear **Yes** <

Example: When the "Auto" mode is selected

- Auto: Adjust the level while listening to the test tones produced automatically from each speaker.
- Manual: Select the speaker from which you want to produce the test tone to adjust the level.

4  Select "Test Tone Start".

(Remote control unit)

2.3

*Channel Level
Tone Start: Yes

2-3. Channel Level

Test Tone **Auto** < > Manual

Test Tone Start **Yes** <

Level Clear **Yes** <

5  Select "Yes".

2-3. Channel Level

Test Tone **Auto** < > Manual

Test Tone Start **Yes** <

Level Clear **Yes** <

6  (Remote control unit)

- a. When the "Auto" mode is selected:
Test tones are automatically emitted from each speaker.
The test tones are emitted from each speaker in the following order, at 4-second intervals the first time and second time around, 2-second intervals the third time around and on:

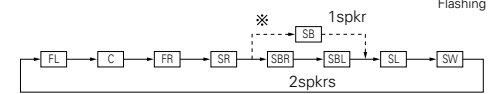

2-3. Test Tone [Auto]	
FL	← -11.5dB
C	0.0dB
FR	0.0dB
SR	0.0dB
SBR	0.0dB
SBL	0.0dB
SL	0.0dB
SW	0.0dB

Example: When the volume is set to -11.5 dB while the test tone is being produced from the Front Lch speaker

- ※ When the surround back speaker setting is set to "1spkr" for "Speaker Configuration", this is set to "SB".

Use the CURSOR left and right buttons to adjust all the speakers to the same volume.
The volume can be adjusted between -12 dB and +12 dB in units of 0.5 dB.

2.3 TestTone Auto	
FL	← -11.5dB

- b. When the "Manual" mode is selected :

- ① Select the speaker.
- ② Adjust all the speakers to the same volume.

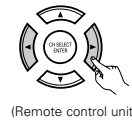
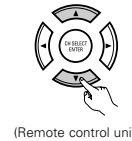

7  Enter the setting. The "Channel Level" screen reappears.

(Remote control unit)

- ※ To cancel the settings, press the CURSOR down to select "Level Clear" and "Yes" on the "Channel Level" screen, then make the settings again.

- ※ When you adjust the channel levels while in the SYSTEM SETUP CHANNEL LEVEL mode, the channel level adjustments made will affect all surround modes. Consider this mode a Master Channel Level adjustment mode.
- ※ After you have completed the SYSTEM SETUP CHANNEL LEVEL adjustments, you can then activate the individual surround modes and adjust channel levels that will be remembered for each of those modes. Then, whenever you activate a particular surround sound mode, your preferred channel level adjustments for just that mode will be recalled. Check the instructions for adjusting channel levels within each surround mode. (See page 39)
- ※ You can adjust the channel levels for each of the following surround modes: PURE DIRECT/DIRECT, STEREO, DOLBY/DTS SURROUND, 5/7 CH STEREO, WIDE SCREEN, SUPER STADIUM, ROCK ARENA, JAZZ CLUB, CLASSIC CONCERT, MONO MOVIE, VIDEO GAME, MATRIX and VIRTUAL.

2-4 Setting the crossover frequency

- Set the crossover frequency mode according to the speaker system being used.

1  Select the "Crossover Frequency" at the Speaker Setup Menu.

(Remote control unit)

*Speaker Setup
24
Crossover Freq.

2. Speaker Setup
1. Speaker Config.
2. Delay Time
3. Channel Level
4. Crossover Frequency
5. Subwoofer Mode Setup
Exit

2  Display the Crossover Frequency screen.

(Remote control unit)

3  Select the frequency.

(Remote control unit)

*Crossover Freq
24
80Hz

2-4 Crossover Frequency
80 Hz

- 40 / 60 / 80 / 100 / 120 / 150 / 200 / 250 Hz can be selected.

4  Enter the setting. The Speaker Setup Menu reappears.

(Remote control unit)

2-5 Setting the low frequency distribution

This screen is not displayed when not using a subwoofer and all speakers are set to small size.

- Set the subwoofer mode according to the speaker system being used.

1  Select the "Subwoofer Mode Setup" at the Speaker Setup Menu.

(Remote control unit)

*Speaker Setup
25
Subwoofer Mode

2. Speaker Setup
1. Speaker Config.
2. Delay Time
3. Channel Level
4. Crossover Frequency
5. Subwoofer Mode Setup
Exit

2  Display the Subwoofer Mode screen.

(Remote control unit)

3  Select the setting.

(Remote control unit)

*Subwoofer Mode
25
LFE

2-5. Subwoofer Mode
LFE < > LFE
+ Main

4  Enter the setting. The Speaker Setup Menu reappears.

(Remote control unit)

NOTES:

— Assignment of low frequency signal range (2-1) —

- The only signals produced from the subwoofer channel are LFE signals (during playback of Dolby Digital or DTS signals) and the low frequency signal range of channels set to "SMALL" in the setup menu. The low frequency signal range of channels set to "LARGE" are produced from those channels.

— Crossover Frequency (2-4) —

- When "Subwoofer" is set to "Yes" at the "Speaker Configuration Setting", set the frequency (Hz) below which the bass sound of the various speakers is to be output from the subwoofer (the crossover frequency).
- For speakers set to "Small", sound with a frequency below the crossover frequency is cut, and the cut bass sound is output from the subwoofer instead.
- (When the subwoofer set to "NO", the bass sound is output from the speaker set as "Large".)

NOTE: For ordinary speaker systems, we recommend setting the crossover frequency to 80 Hz. When using small speakers, however, setting the crossover frequency to a high frequency may improve frequency response for frequencies near the crossover frequency.

— Subwoofer mode (2-5) —

- The subwoofer mode setting is only valid when "LARGE" is set for the front speakers and "YES" is set for the subwoofer in the "Setting the type of speakers". (see page 18).
- When the "LFE+MAIN" playback mode is selected, the low frequency signal range of channels set to "LARGE" are produced simultaneously from those channels and the subwoofer channel. In this playback mode, the low frequency range expand more uniformly through the room, but depending on the size and shape of the room, interference may result in a decrease of the actual volume of the low frequency range.
- Selection of the "LFE" play mode will play the low frequency signal range of the channel selected with "LARGE" from that channel only. Therefore, the low frequency signal range that are played from the subwoofer channel are only the low frequency signal range of LFE (only during Dolby Digital or DTS signal playback) and the channel specified as "SMALL" in the setup menu.
- Select the play mode that provides bass reproduction with quantity.
- When the subwoofer is set to "Yes", bass sound is output from the subwoofer regardless of the subwoofer mode setting in surround modes other than Dolby/DTS.
- In surround modes other than Dolby Digital and DTS, if the subwoofer is set to "YES", the low frequency portion is always output to the subwoofer channel. For details, refer to "Surround Modes and Parameters". (See page 39)

3 Setting the Input Setup

1 At the System Setup Menu select "Input Setup".



(Remote control unit)

*System Setup 3
 Input Setup

System Setup Menu
 1. Auto Setup/Room EQ
 2. Speaker Setup
 3. Input Setup
 4. Advanced Playback
 5. Option Setup
 Exit

2 Display the Input Setup Menu screen.



(Remote control unit)

3-1 Setting the Digital In Assignment

• This setting assigns the digital input jacks of the AVR-2805 for the different input sources.

1 At the Input Setup Menu select "Digital In Assign".



(Remote control unit)

*Input Setup 3.1
 Digital In

3. Input Setup
 1. Digital In Assign
 2. Ext. In Subwoofer Level
 3. Component In Assign
 4. Video Input Mode
 5. Auto Tuner Presets
 Exit

2 Display the Digital Inputs screen.



(Remote control unit)

*Digital In 3.1
 CD : COAX1

3-1 Digital In Assign
 CD : COAX1 VCR2 : OFF
 DVD : COAX2 TAPE : OPT 4
 VDP : OPT1
 TV : OFF
 DBS : OPT2
 AUDIO : OPT5
 VCR3 : OPT3 Default Yes

3 Select the digital input jack to be assigned to the input source.

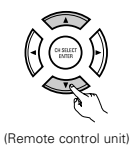

① Select the input source



② Select the digital input jack

Select "OFF" for input sources for which no digital input jacks are used.

※ If "Yes" is selected for "Default", the settings are automatically reset to the default values.

4 Enter the setting. The Input Setup Menu reappears.



NOTES:

- The OPTICAL 3, 4 jacks on the AVR-2805's rear panel are equipped with an optical digital output jack for recording digital signals on a CD recorder, MD recorder or other digital recorder. Use this for digital recording between a digital audio source (stereo - 2 channel) and a digital audio recorder.
- Do not connect the output of the component connected to the OPTICAL 3, 4 OUT jack on the AVR-2805's rear panel to any jack other than the OPTICAL 3, 4 IN jack.
- "PHONO" and "TUNER" cannot be selected on the Digital In Assignment.

3-2 Setting the Ext. In Subwoofer Level

• Set the method of playback of the analog input signal connected to the Ext. In Subwoofer.

1 Select "Ext. In Subwoofer Level" at the Input Setup Menu.



(Remote control unit)

*Input Setup 3.2
 Ext. In SW Lev.

3. Input Setup
 1. Digital In Assign
 2. Ext. In Subwoofer Level
 3. Component In Assign
 4. Video Input Mode
 5. Auto Tuner Presets
 Exit

2 Display to the Ext. In Subwoofer Level screen.



(Remote control unit)

*Ext. In SW Lev. 3.2
 SW Lev. : +15dB

3-2. Ext. In Subwoofer Level
 Subwoofer Level : +15dB

3 Select the desired setting.

Select according to the specifications of the player being used. Also refer to the player's operating instructions. +15 dB (default) recommended. (0, +5, +10 or +15 can be selected.)



(Remote control unit)

4 Enter the setting. The Input Setup Menu reappears.



3-3 Setting the Component In Assign

- This setting assigns the color difference (component) video input jacks of the AVR-2805 for the different input sources.

1 Select "Component In Assign" at the Input Setup Menu.



(Remote control unit)

*Input Setup
Component In

3. Input Setup
 1. Digital In Assign
 2. Ext. In Subwoofer Level
 3. Component In Assign
 4. Video Input Mode
 5. Auto Tuner Presets
 Exit

2 Display the Component In Assign screen.



(Remote control unit)

*Component In
DUD :# U1 ▶

3-3. Component In Assign
 DVD : VIDEO 1 ▶
 VDP : NONE
 TV : VIDEO 2
 OBS : VIDEO 3
 VCR1 : NONE
 VCR2 : NONE
 VCR3 : NONE
 VCR4 : NONE
 Default Yes ◀

3 Select the component (Y, Pb/Cb and Pr/Cr) video input terminal to be assigned to the input source.
 ① Select the source selection. ② Select the component video input terminal.



(Remote control unit)



(Remote control unit)

Select "NONE" for sources for which the component (Y, Pb/Cb and Pr/Cr) video input is not to be used.
 * When the default, "Yes", is selected, the settings are reset to the factory defaults.

4 Enter the setting.
 The Input Setup Menu reappears.



(Remote control unit)

- 3** ① Select the input source for which you want to set the Video Input Mode. ② Select the mode as below.
- ▶AUTO ◀◀COMPONENT▶▶Svideo▶▶Video▶▶
- The details in each mode are as follows.

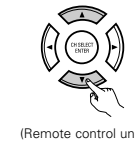

AUTO: When there are multiple input signals, the input signals are detected and the input signal to be output from the video monitor output terminal is selected automatically in the following order: component video, S-Video, composite video.

Component: The signal connected to the component video terminal is always played. Video conversion is not conducted, so no image is output from the monitor output terminal when there is no input signal to the component terminal.

S-Video: The signal connected to the S-Video terminal is always played. The S-Video input signal is converted and output from the composite and component monitor output terminal.

Video: The signal connected to the composite video terminal is always played. The composite video input signal is up-converted and output from the S-Video and component monitor output terminals.

NOTE: Down-converting from the component video signal to the S-Video and composite video signal is not possible, so when not using the component video monitor output terminal connect the player using the S-Video or composite video input terminal.

Cautions on the video conversion function: When the component video terminals are used to connect the AVR-2805 with a TV (or monitor, projector, etc.) and the video (yellow) or S video terminals are used to connect the AVR-2805 with a VTR, depending on the combination of the TV and VTR the picture may flicker in the horizontal direction, be distorted, be out of sync or not display at all when playing video tapes. If this happens, connect a commercially available video stabilizer, etc., with a TBC (time base corrector) function between the AVR-2805 and the VTR, or if your VTR has a TBC function, turn it on.

4 Enter the setting.
 The Input Setup Menu reappears.



(Remote control unit)

3-4 Setting the Video Input Mode

1 Select "Video Input Mode" at the Input Setup Menu.



(Remote control unit)

*Input Setup
Video In Mode

3. Input Setup
 1. Digital In Assign
 2. Ext. In Subwoofer Level
 3. Component In Assign
 4. Video Input Mode
 5. Auto Tuner Presets
 Exit

2 Display the Video Input Mode screen.



(Remote control unit)

*Video In Mode
DUD :# Auto ▶

3-4. Video Input Mode
 DVD : AUTO ▶
 VDP : AUTO
 TV : AUTO
 OBS : AUTO
 VCR1 : AUTO
 VCR2 : AUTO
 VCR3 : AUTO
 VCR4 : AUTO
 Default Yes ◀

3-5 Auto Tuner Presets

Use this to automatically search for FM broadcasts and store up to 56 stations at preset channels A1 to 8, B1 to 8, C1 to 8, D1 to 8, E1 to 8, F1 to 8 and G1 to 8.

NOTE:

- If an FM station cannot be preset automatically due to poor reception, use the "Manual tuning" operation to tune in the station, then preset it using the manual "Preset memory" operation.

1  Select "Auto Tuner Presets" at the Input Setup Menu.

*Input Setup
Auto Tuner

3. Input Setup
 1. Digital In Assign
 2. Ext. In Subwoofer Level
 3. Component In Assign
 4. Video Input Mode
 5. Auto Tuner Presets
 Exit

2  Display the Auto Preset Memory screen.

*Auto Tuner
Start : Yes4

3-5. Auto Preset Memory
 Auto Tuning &
 Preset Station Memory
 Storing Preset Memory
 Start Yes

3  Press the CURSOR left button to select "Yes". "Search" flashes on the screen and searching begins. "Completed" appears once searching is completed. The display automatically switches to screen.

4-1 Setting the Audio Delay

This function allows you to adjust the time delay of the video and audio signals and store these settings for the different input sources.

The setting is made while watching a DVD or other software, so it is not made here.

By default, this is not displayed when no digital signals are being input.

For instructions on making the setting, refer to page 44.

NOTE:

The audio delay setting does not apply when it plays in the EXT. IN mode or in the analog input direct mode or stereo mode (TONE DEFEAT "ON").

4-2 Setting the Dolby Digital Setup

Sets the down-mixing method when not using a center speaker or surround speakers.

OFF: The dynamic range is not compressed.

ON: The dynamic range is compressed automatically according to the combination of speakers being used.

1  Select "Dolby Digital Setup" at the Advanced Playback Menu.

*Advanced Play
Dolby D Setup

4. Advanced Playback
 1. Audio Delay
 2. Dolby Digital Setup
 3. Auto Surround Mode
 Exit

2  Press the ENTER button. Display the Dolby Digital Setup screen.

3  Select "ON" if you want to use the Compression, "OFF" if you do not want to use it.

*Dolby D Setup
Comp. : 4 OFF

4-2. Dolby Digital
Downmix Option Setup
 Compression
 ON OFF

NOTE:

When a center speaker or surround speakers, are not used the sound is played from the front speakers. Set "Compression" to "ON" if it seems that sound is distorted because the input level exceeds the allowable input for the front speakers.

4  Enter the setting. The Advanced Playback Menu reappears.

4 Setting the Advanced Playback

1  Select "Advanced Playback" at the System Setup Menu.

*System Setup
Advanced Play

System Setup Menu
 1. Auto Setup/Room EQ
 2. Speaker Setup
 3. Input Setup
 4. Advanced Playback
 5. Option Setup
 Exit

2  Display the Advanced Playback Menu screen.

4-3 Setting the Auto Surround Mode

The surround mode used at last for the three types of input signals shown below is stored in the memory, and the signal is automatically played with that surround mode the next time it is input.

Note that the surround mode setting is also stored separately for the different input sources.

- ① Analog and PCM 2-channel signals (STEREO)
- ② 2-channel signals of Dolby Digital, DTS or other multi-channel format (DOLBY PL IIx cinema)
- ③ Multi-channel signals of Dolby Digital, DTS or other multi-channel format (DOLBY/DTS SURROUND)

- ※ Default settings are indicated in ().
- ※ During playback in the PURE DIRECT mode, the surround mode does not change even if the input signal is changed.

1 Select "Auto Surround Mode" at the Advanced Playback Menu.



(Remote control unit)

*Advanced Play 43
 Auto Surround

4. Advanced Playback
 1. Audio Delay
 2. Dolby Digital Setup
 3. Auto Surround Mode
 Exit

2 Press the ENTER button. Display the Auto Surround Mode screen.



(Remote control unit)

3 Select "ON" if you want to use the auto surround mode, "OFF" if you do not want to use it.



(Remote control unit)

*Auto Surround 43
 ON/OFF: ON

4-3. Auto Surround Mode
 ON ← OFF

4 Enter the setting. The Advanced Playback Menu reappears.



(Remote control unit)

※ Contents stored in the auto surround mode can be checked with the on-screen display.



(Remote control unit)

Auto Surround Mode DVD
 ANALOG PCM
 2ch: STEREO
 DIGITAL
 2ch: DOLBY PL IIx cine
 5. 1ch: DOLBY/DTS SURROUND
 OSD-3

5 Setting the Option Setup

1 Select "Option Setup" at the System Setup Menu.



(Remote control unit)

*System Setup 5
 Option Setup

System Setup Menu
 1. Auto Setup/Room EQ
 2. Speaker Setup
 3. Input Setup
 4. Advanced Playback
 5. Option Setup
 Exit

2 Display the Option Setup Menu Screen.



(Remote control unit)

5-1 Setting the Power Amplifier Assignment

Make this setting to switch the power amplifier for the surround back channel to ZONE2. If ZONE2 is selected, the signal that selected at ZONE2 is output at "SURR. BACK ZONE2 PREOUT" terminals.

1 Select "Power Amp Assign" at the Option Setup Menu.



(Remote control unit)

*Option Setup 51
 P.AMP Assign

5. Option Setup
 1. Power Amp Assign
 2. Zone2 Vol. Level
 3. Trigger Out 1 Setup
 4. Trigger Out 2 Setup
 5. Muting Level
 6. On Screen Display
 7. Setup Lock
 Exit

2 Press the ENTER button. Display the Power Amp Assign screen.



(Remote control unit)

3 Select "Surround Back" to use as the surround back channel, "Zone2" to use as Zone2 out.



(Remote control unit)

*P.AMP Assign 51
 S.Back

5-1. Power Amp Assign
 Surroundback ← Zone2

When "Surround Back" is selected

5-1. Power Amp Assign
 Surroundback ← Zone2

When "Zone2" is selected

4 Enter the setting. The Option Setup Menu reappears.



(Remote control unit)

5-2 Setting the Zone2 Vol. Level

Set the Zone2 pre-out output level adjustment.

1  At the Option Setup Menu select "Zone2 Vol. Level".

*Option Setup
Zone2 Vol. Lev.

5. Option Setup
1. Power Amp Assign
2. Zone2 Vol. Level
3. Trigger Out 1 Setup
4. Trigger Out 2 Setup
5. Muting Level
6. On Screen Display
7. Setup Lock
Exit

2  Display the Zone2 Vol. Level screen.

3  Select the desired setting.

Variable:
The level can be adjusted freely using the buttons on the remote control unit.
0 dB, -40 dB:
The output level is fixed at the set level and the volume can no longer be adjusted.

NOTE:

- When "ZONE2" is selected at System Setup Menu "5-1. Power Amp Assign", the Zone2 vol. Level is all set to "Variable" including preout level and this menu is not displayed.

5-2. Zone2 Vol. Level
Variable ▶ -40dB 0dB

*Zone2 Vol. Lev.
Variable▶

4  Enter the setting.
The Option Setup Menu reappears.

5-3, 5-4 Setting the Trigger Out Setup

- There are two 12V DC Trigger Out outputs on the rear panel that can be used to control other devices with compatible trigger inputs.
- Set the Trigger Out output 1 for the different input sources.

1  Select "Trigger Out 1 Setup" at the Option Setup Menu.

*Option Setup
Trigger Out 1



5. Option Setup
1. Power Amp Assign
2. Zone2 Vol. Level
3. Trigger Out 1 Setup
4. Trigger Out 2 Setup
5. Muting Level
6. On Screen Display
7. Setup Lock
Exit

2  Display to the Trigger Out 1 Setup screen.

*Trigger Out 1
ZONE : 4 MAIN ▶

5-3. Trigger Out 1 Setup
ZONE : ◀MAIN▶
PHONO : OFF TV : ON
CD : OFF DBS : ON
TUNES : OFF VCR1 : ON
TAPES : OFF VCR2 : ON
DVD : ON WAUX : ON
VDP : ON Default ▶ Yes ◀

3  Select the Zone (MAIN or Zone2).

4 ①  Select the input source. ②  Select "ON" or "OFF".

5  Enter the setting.
The Option Setup Menu reappears.

※ Set the Trigger out 2 Setup in the same way.

5-5 Setting the Muting Level

- This sets the amount of attenuation at audio output muting.

1  Select "Muting Level" at the Option Setup Menu.

*Option Setup
Muting Level

5.5

5. Option Setup
 1. Power Amp Assign
 2. Zone2 Vol. Level
 3. Trigger Out 1 Setup
 4. Trigger Out 2 Setup
 5. Muting Level
 6. On Screen Display
 7. Setup Lock
 Exit

2  Display the Muting Level screen.

*Muting Level 5.5
 ---dB

3  Select the desired setting.

- 20 dB: It is turned down the volume to -20 dB from the present level.
- 40 dB: It is turned down the volume to -40 dB from the present level.
- dB: It is turned off the volume.

*Muting Level 5.5
 ---dB

5-5. Muting Level
 ---dB - 40dB - 20dB

4  Enter the setting. The Option Setup Menu reappears.

*Option Setup
Muting Level

5-6 Setting the On Screen Display (OSD)

- Use this to turn the on-screen display (messages other than the menu screens) on or off.
- Sets the on-screen display's display mode.
 - Mode 1: Prevents flickering of the on-screen display when there is no video signal.
 - Mode 2: Flickering is not prevented.
 Use this mode if the on-screen display does not appear in the mode 1, as may happen according to the TV being used.

1  Select "On Screen Display" at the Option Setup Menu.

*Option Setup
On Screen

5.6

5. Option Setup
 1. Power Amp Assign
 2. Zone2 Vol. Level
 3. Trigger Out 1 Setup
 4. Trigger Out 2 Setup
 5. Muting Level
 6. On Screen Display
 7. Setup Lock
 Exit

2  Display the On screen display setup screen.

*On Screen
ON/OFF: ON

5-6. On Screen Display
 ON/OFF

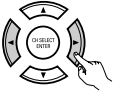
3  Select "ON" or "OFF".

*On Screen
ON/OFF: ON

5.6

5-6. On Screen Display
 Mode 1/Mode 2

4 ① Select the On Screen Display mode. ② Select "Mode1" or "Mode2".

 (Remote control unit)

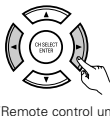
 (Remote control unit)

5-6. On Screen Display
 Mode 1/Mode 2

*On Screen
Mode: Mode1

5  Enter the setting. The Option Setup Menu reappears.

*Option Setup
On Screen

5-7 Protecting the setting

The system setup settings can be locked so that they cannot be changed easily.

1  Select "Setup Lock" at the Option Setup Menu.

*Option Setup 5?

Setup Lock

5. Option Setup

1. Power Amp Assign

2. Zone2 Vol. Level

3. Trigger Out 1 Setup

4. Trigger Out 2 Setup

5. Muting Level

6. On Screen Display

7. Setup Lock

Exit

(Remote control unit)

2  Display the Setup Lock screen.

(Remote control unit)

3  Select "ON", to lock the system setup settings.

*Setup Lock 5?

ON/OFF: 4 OFF

5-7. Setup Lock

ON 4:1 **OFF**

(Remote control unit)

4  Press the "ENTER" button to finalize the setting and exit the Option setup mode. When the setup lock function is activated, the settings listed below cannot be changed, and "SETUP LOCKED" is displayed when related buttons are operated.

- System setup settings
- Surround parameter settings
- Tone control settings
- Channel level settings (including test tones)

To unlock, press the System Setup button again and display the Setup Lock screen, then select "OFF" and press "ENTER".

※ **System setup is complete. Once these settings are made, there is no need to change them unless different AV components are connected or the speakers are repositioned.**

After completing system setup

This button can be pressed at any time during the system setup process to complete the process.

1  Press the SYSTEM SETUP button at the System Setup Menu.

※ The changed settings are entered and the on-screen display turns off.

(Remote control unit)

• **On-screen display signals**

	Signals input to the AVR-2805		On-screen display signal output		
	VIDEO signal input jack (yellow)	S-video signal input jack	Video signal output to VIDEO MONITOR OUT jack (yellow)	Video signal output to S-Video MONITOR OUT jack	Video signal output to Color Difference (Component) Video MONITOR OUT jack
1	×	×	○	○	○
2	○	×	○	○	○
3	×	○	○	○	○
4	○	○	×	○	○

(○: Signal ×: No signal) (○: On-screen signals output ×: On-screen signals not output)

NOTE:

- When a component video signal is input and when the "Video Input Mode" is set to the component fixed mode at Input setup, the on-screen display is only displayed when the System Setup, Surround Parameters and On Screen buttons are operated.

8 REMOTE CONTROL UNIT

- The included remote control unit (RC-975) can be used to operate not only the AVR-2805 but other remote control compatible DENON components as well. In addition, the memory contains the control signals for other remote control units, so it can be used to operate non-DENON remote control compatible products.

Inserting the batteries

- Remove the remote control unit's rear cover.

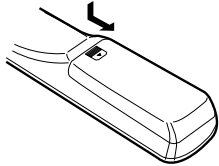

- Set three R6P/AA batteries in the battery compartment in the indicated direction.

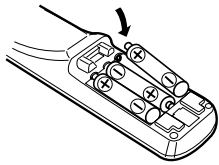

- Put the rear cover back on.

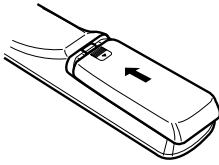

Notes on Batteries

- Use R6P/AA batteries in the remote control unit.
- The batteries should be replaced with new ones approximately once a year, though this depends on the frequency of usage.
- Even if less than a year has passed, replace the batteries with new ones if the set does not operate even when the remote control unit is operated nearby by the set. (The included battery is only for verifying operation. Replace it with a new battery as soon as possible.)
- When inserting the batteries, be sure to do so in the proper direction, following the “⊕” and “⊖” marks in the battery compartment.
- To prevent damage or leakage of battery fluid:
 - Do not use a new battery together with an old one.
 - Do not use two different types of batteries.
 - Do not short-circuit, disassemble, heat or dispose of batteries in flames.
- Remove the batteries from the remote control unit when you do not plan to use it for an extended period of time.
- If the battery fluid should leak, carefully wipe the fluid off the inside of the battery compartment and insert new batteries.
- When replacing the batteries, have the new batteries ready and insert them as quickly as possible.

Using the remote control unit

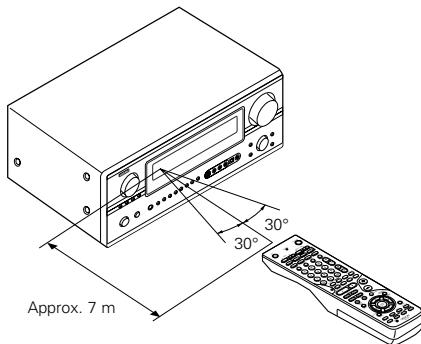

- Point the remote control unit at the remote sensor on the main unit as shown on the diagram.
- The remote control unit can be used from a straight distance of approximately 7 meters from the main unit, but this distance will be shorter if there are obstacles in the way or if the remote control unit is not pointed directly at the remote sensor.
- The remote control unit can be operated at a horizontal angle of up to 30 degrees with respect to the remote sensor.

NOTES:

- It may be difficult to operate the remote control unit if the remote sensor is exposed to direct sunlight or strong artificial light.
- Do not press buttons on the main unit and remote control unit simultaneously. Doing so may result in malfunction.
- Neon signs or other devices emitting pulse-type noise nearby may result in malfunction, so keep the set as far away from such devices as possible.

Operating DENON audio components

- Use the mode selector buttons to select the component you want to operate.
 - The function will change one step in the sequence described below each time the MODE SELECT button is pressed.

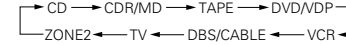

- Operate the audio component.
 - For details, refer to the component's operating instructions.
 - It may not be possible to operate some models.

1. CD player (CD) system buttons

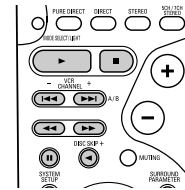

- ▶ : Play
- : Stop
- ◀▶▶▶▶ : Auto search (to beginning of track)
- ◀▶▶▶▶ : Manual search (forward and reverse)
- || : Pause
- DISC SKIP + : (for CD changers only)

2. Tape deck (TAPE) system buttons

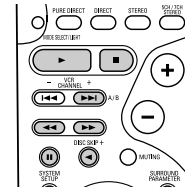

- ▶ : Forward play
- : Stop
- A/B : Switch between sides A and B
- ◀▶▶▶▶ : Rewind
- ▶▶▶▶▶ : Fast forward
- || : Pause
- ◀▶▶▶▶ : Reverse play

3. MD recorder (MD), CD recorder (CDR) system buttons

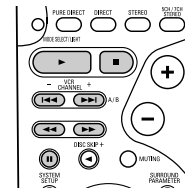

- ▶ : Play
- : Stop
- ◀▶▶▶▶ : Auto search (to beginning of track)
- ◀▶▶▶▶ : Manual search (forward and reverse)
- || : Pause

※ Default setting : CDR

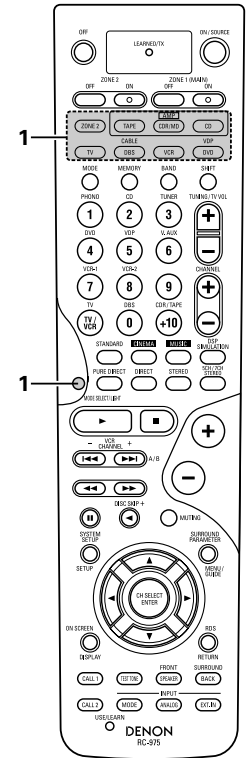

4. Tuner system buttons

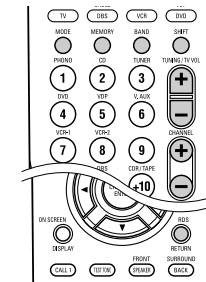

- MODE : Switch between AUTO and MANUAL
- MEMORY : Preset memory
- BAND : Switch between AM and FM bands
- SHIFT : Switch preset channel range
- TUNING +, - : Tuning up/down
- CHANNEL +, - : Preset channel up/down
- RDS : RDS search

※ The tuner can be operated in the amplifier (CD, CDR/MD, or TAPE) mode.

Preset memory

The included remote control unit can be used to operate devices of different brands by registering the preset number corresponding to the brand of your device. For some models the remote control unit or the device may not operate properly. In this case, use the learning function (page 31) to store your device's remote control signals in the included remote control unit.

- 1 Press the power ON/SOURCE button and the OFF button at the same time.
 - The LEARNED/TX indicator flashes.



- 2 Press the mode button of the equipment that is to be entered to a preset memory.
 - The mode button flashes.

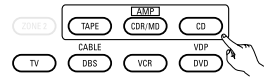

- 3 Referring to the included List of Preset Codes, use the number buttons to input the preset code (a 4-digit number) for the manufacturer of the component whose signals you want to store in the memory.

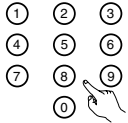

- 4 When stored correctly, the mode button and the LEARNED/TX indicator will light.

- 5 To store the codes of another component in the memory, repeat steps 1 to 4.

NOTES:

- Depending on the model and year of manufacture, this function cannot be used for some models, even if they are of makes listed on the included list of preset codes.
- Some manufacturers use more than one type of remote control code. Refer to the included list of preset codes to change the number and check it out.
- **The preset memory can be set for one component only among the following: CDR/MD, DVD/VDP and DBS/CABLE.**

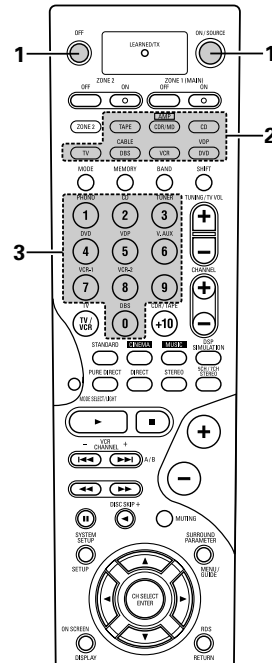

The preset codes are as follows upon shipment from the factory and after resetting:

- TV, VCRHITACHI
- CD, TAPEDENON
- CDR/MDDENON (CDR)
- DVD/VDPDENON (DVD)
- DBS/CABLEABC (CABLE)

DVD preset codes	0000	0001
DENON Model No.	DVD-700	
	DVD-900	
	DVD-1000	
	DVD-1400	DVD-800
	DVD-1500	DVD-1600
	DVD-2200	DVD-2000
	DVD-2800	DVD-2500
	DVD-2800II	DVD-3000
	DVD-2900	DVD-3300
	DVD-3800	
	DVD-A11	
	DVD-A1	

Operating a component stored in the preset memory

- 1 Press the mode selector button for the component you want to operate.

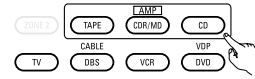

NOTE:

- For the DVD player remote control buttons, function names may differ according to manufacturer. Compare with the remote control operation of the various components.

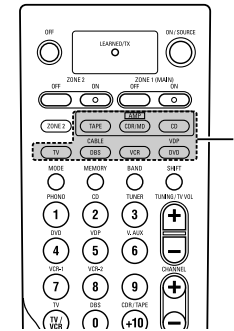

- 2 Operate the component.
 - For details, refer to the component's operating instructions.
 - * Some models cannot be operated with this remote control unit.

1. Digital video disc player (DVD, DVD SETUP) system buttons

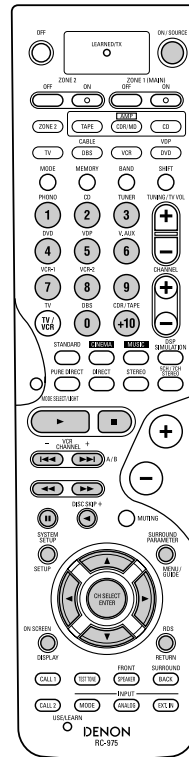

- POWER : Power on/standby (ON/SOURCE)
- 0-9, +10 : 10 key
- ▶ : Play
- : Stop
- ◀▶▶▶ : Auto search (to beginning of track)
- ◀◀◀▶ : Manual search (forward and reverse)
- || : Pause
- DISC SKIP + : Disc skip (for DVD changer only)
- SETUP : Setup
- MENU : Menu
- DISPLAY : Display
- RETURN : Return
- ▲, ▼, ◀, ▶ : Cursor up, down, left and right
- ENTER : Enter

2. Video disc player (VDP) system buttons

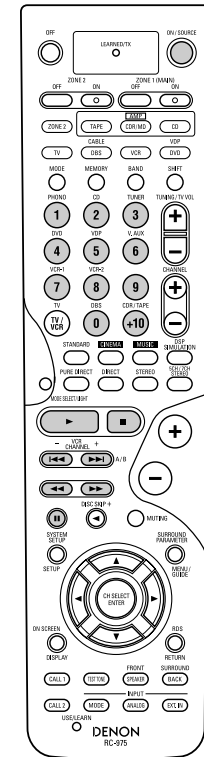

- POWER : Power on/standby (ON/SOURCE)
- 0-9, +10 : 10 key
- ▶ : Play
- : Stop
- ◀▶▶▶ : Auto search (cue)
- ◀◀◀▶ : Manual search (forward and reverse)
- || : Pause

3. Video deck (VCR) system buttons

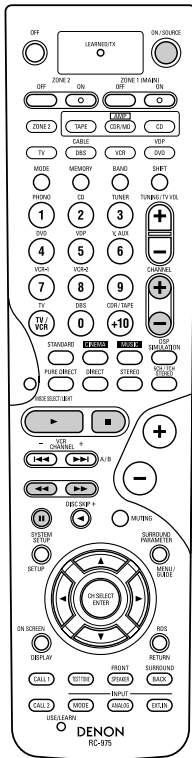

- POWER : Power on/standby (ON/SOURCE)
- Channel +, - : Channels
- ▶ : Play
- : Stop
- ◀▶▶▶ : Manual search (forward and reverse)
- ⏸ : Pause

4. Monitor TV (TV), digital broadcast satellite (DBS) tuner and cable (CABLE) system buttons

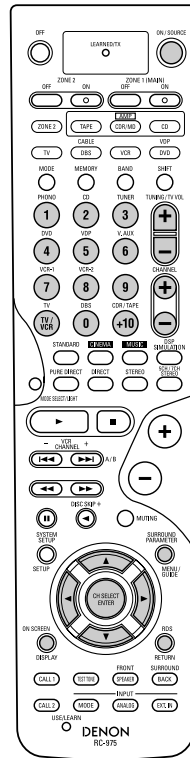

- POWER : Power on/standby (ON/SOURCE)
- 0~9, +10 : Channels
- TV/VCR : Switch between TV and video player
- TV VOL +, - : Volume up/down
- CHANNEL : Switch channels +, -
- MENU : Menu
- DISPLAY : Switch display
- RETURN : Return
- ▲, ▼, ◀, ▶ : Cursor up, down, left and right
- ENTER : Enter

NOTES:

- For this CD, CDR, MD and TAPE components, buttons can be operated in the same way as for Denon audio components.
- The television can be operated in the DVD/VDP, VCR and TV modes.

Learning function

If your AV component is not a DENON product or if it cannot be operated using the preset memory, it can be controlled with the included remote control unit by storing its remote control signals in the remote control unit. For some remote control signals it is not possible to "learn" the signals or the device will not operate properly. In such cases use the remote control unit included with the device to operate it.

- 1 Press the USE/LEARN button with the tip of a pen etc., to set the learn mode.
 - Both the mode selector buttons and LEARNED/TX indicator flash.

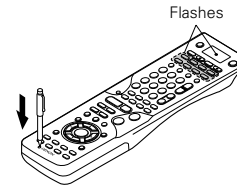

- 2 Press the mode button of the equipment for which learning is desired.
 - Mode button and LEARNED/TX indicator flash.

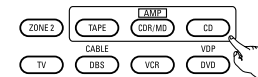

- 3 Press the button that is to be learned. The LEARNED/TX indicator stops flashing and the mode button lights.
 - Mode button and LEARNED/TX indicator flashed if a button that cannot be "learned" is pressed.
 - To cancel, press the USE/LEARN button.

- 4 Point the remote control units directly at each other and press and hold in the button on the other remote control unit which you want to "learn".

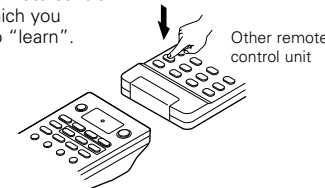

- 5 The mode button and the LEARNED/TX indicator lights, release the button on the other remote control unit.
 - The mode button and the LEARNED/TX indicator start flashing again.

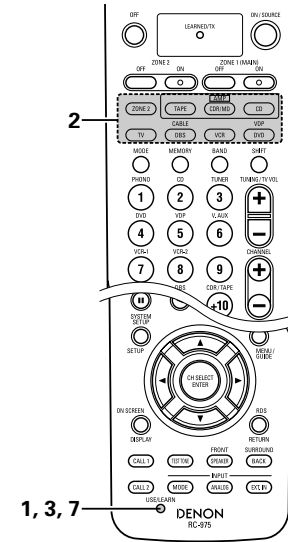
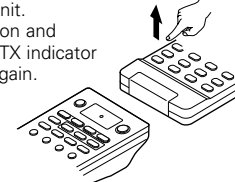

- 6 To "learn" other buttons, repeat steps 2 to 5.
- 7 Once the learning operation is completed, press the USE/LEARN button again. The mode button and the LEARNED/TX indicator stop flashing and the learning mode is cancelled.

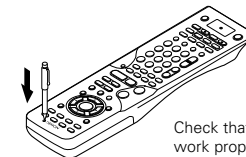

Check that the stored codes work properly.

NOTES:

- If the codes could not be stored, the LEARNED/TX indicator start flashing rapidly. For limited number of models, codes cannot be stored in RC-975.
- If the mode button and LEARNED/TX indicator start flashing rapidly, this means that the memory is already full, and the code you have just attempted to store was not stored. To "learn" that code, first perform the resetting operation. (See page 33.)

System call

The accessories remote control unit is equipped with "system call" function allowing a series of remote control signals to be transmitted by pressing a single button. This function can be used for example to turn on the amplifier's power, select the input source, turn on the monitor TV's power, turn on the source component's power and set the source to the play mode, all at the touch of a button.

(1) System call buttons

Up to 10 signals each can be stored at the "CALL1" and "CALL2" buttons.

(2) Storing system call signals

- 1 Press the power ON/SOURCE button and the OFF button at the same time.
 - The LEARNED/TX indicator flashes.



- 2 Press the CALL 1 button.
 - The mode selector buttons and LEARNED/TX indicator flash.



- 3 Press the mode buttons of the equipment that is to be registered to System Call.

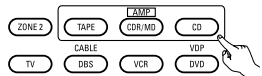

- 4 Press the buttons whose remote control signals you want to store one by one.

- 5 Repeat steps 3 and 4 to register the desired buttons.

- 6 Press the CALL1 or CALL2 button and register System Call.



(3) Using the system call function

- 1 Press the button at which the system call signals have been stored.
 - The stored signals are transmitted successively.

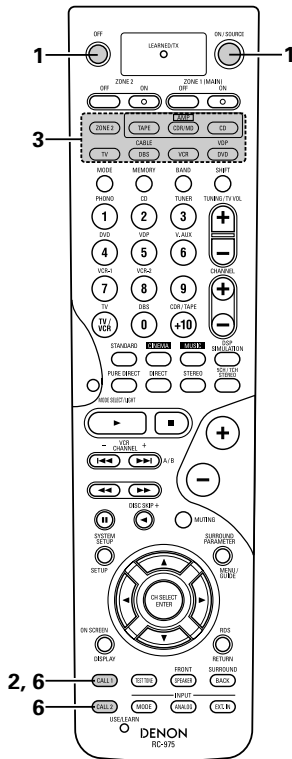
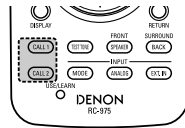

NOTES:

- The remote control signals for the buttons pressed while storing the system call signals are transmitted when the buttons are pressed, so cover the remote sensor or take other measures so that the components do not operate while the signals are being stored.
- The mode button and LEARNED/TX indicator flashing rapidly if you have already stored the maximum number of signals.

Punch Through

(1) Punch through button

Buttons used in the CD, CDR/MD, TAPE, DVD/VDP, and VCR modes can be assigned to the buttons shown on the diagram at the right which are not normally used in the TV and DBS/CABLE modes.

For example, when the CD mode is set to the punch through mode in the TV mode, the CD mode's PLAY, STOP, MANUAL SEARCH, AUTO SEARCH, PAUSE and DISC SKIP buttons' signals are sent in the TV mode.

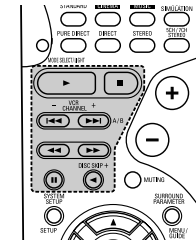

(2) Making the punch through setting

- 1 Press the power ON/SOURCE button and the OFF button at the same time.
 - The LEARNED/TX indicator flashes.



- 2 Press the play button.
 - TV and DBS/CABLE mode buttons and LEARNED/TX indicator flash.



- 3 Press the mode button of the equipment for which Punch Through is to be set.
 - The CD, CDR/MD, TAPE, DVD/VDP, and VCR mode buttons and LEARNED/TX indicator will flash.

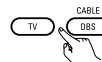

- 4 Press the mode button of the equipment that is to be punched through.
 - The mode button that was set will light.

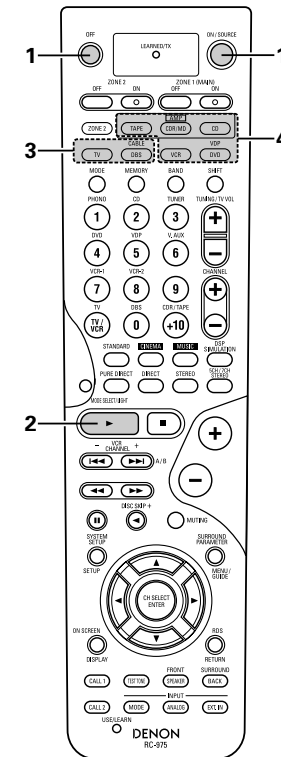
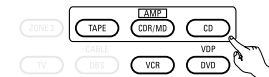

Resetting

(1) Resetting "learned" buttons

- 1 Press the USE/LEARN button with the tip of a pen, etc., to set the learn mode.
 - The mode selector buttons and LEARNED/TX indicator flash.

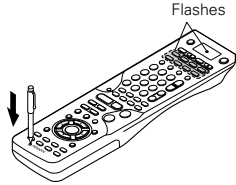

- 2 Press the mode button of the equipment that is to be reset.
 - Mode button and LEARNED/TX indicator flash.

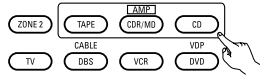

- 3 Hold for 4 seconds or longer the mode button of the equipment that is to be reset and the ON/SOURCE button.
 - The mode button and the LEARNED/TX indicator will again flash, and the learned remote control signal of the selected equipment will be deleted.

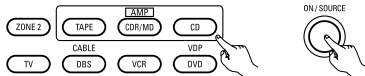

- 4 Press the USE/LEARN button.

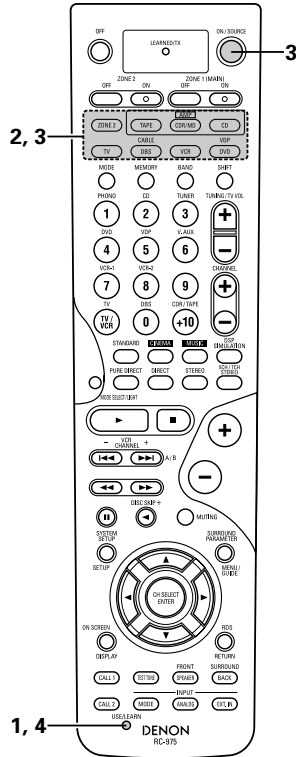
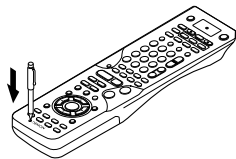

(2) Resetting the punch through setting

- 1 Press the power ON/SOURCE button and the OFF button at the same time.
 - The LEARNED/TX indicator flashes.



- 2 Press the play (▶) button.
 - TV and DBS/CABLE mode buttons and LEARNED/TX indicator flash.



- 3 Press the mode button of the equipment (TV or DBS/CABLE) that is to be reset.
 - The CD, CDR/MD, TAPE, DVD/VDP, and VCR mode buttons and LEARNED/TX indicator will flash.

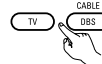

- 4 Press the mode button of the equipment that is to be reset again.
 - During the resetting operation, the selected mode button and the LEARNED/TX indicator will light; they will return to steady state upon completion.

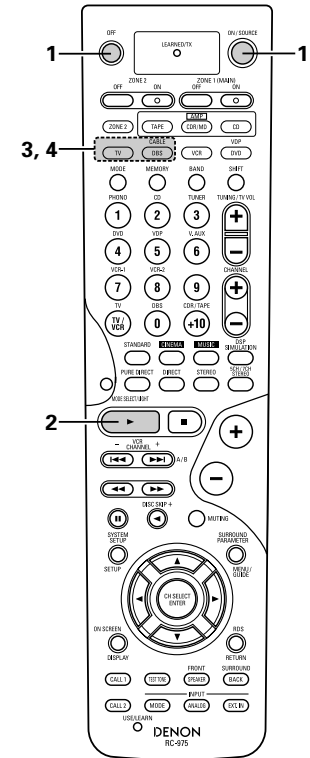
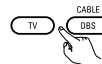

9 OPERATION

Before operating

1 Refer to "CONNECTIONS" (pages 5 to 9) and check that all connections are correct.

2 Select "AMP" using the AMP button. (only when operating with the remote control unit)

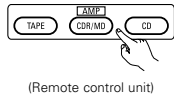

3 Press the POWER switch (button).



- ON**
 The power turns on and indicator is light. Set the power switch to this position to turn the power on and off from the included remote control unit.
- OFF**
 The power turns off and indicator is off. In this position, the power cannot be turned on and off from the remote control unit.

4 Turn on the power Press the POWER ON/STANDBY switch (button).



When pressed, the power turns on and the display lights. The sound is muted for several seconds, after which the unit operates normally. When pressed again, the power turns off, the standby mode is set and the display turns off.

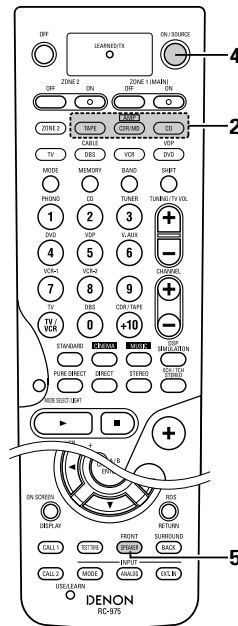
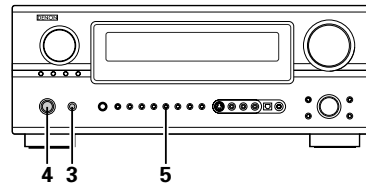

5 The front speakers switch as shown below each time the FRONT SPEAKER button is pressed.

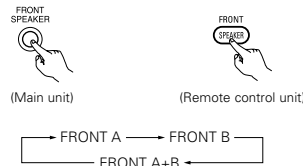

Playing the input source

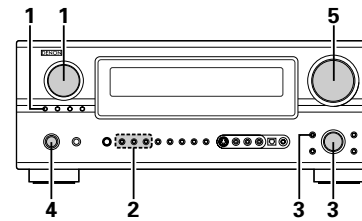

1 Select the input source to be played.

Example: CD



* To select the input source when ZONE 2 / REC OUT, TUNING PRESET or VIDEO SELECT is selected, press the SOURCE button then operate the input function selector.



2 Select the input mode.

- Selecting the analog mode**
 Press the ANALOG button to switch to the analog input.



- Selecting the external input (EXT. IN) mode**
 Press the EXT. IN (on the EXT. IN button on the remote control unit) to switch the external input.



- Selecting the AUTO, PCM and DTS modes**
 The mode switches as shown below each time the INPUT MODE button is pressed.

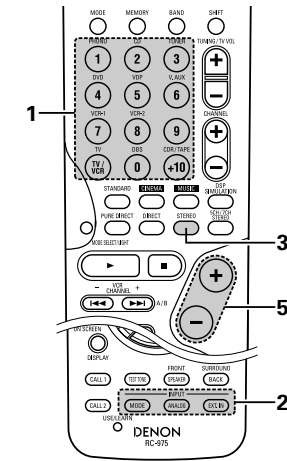
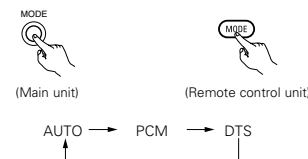

Input mode selection function

Different input modes can be selected for the different input sources. The selected input modes for the separate input sources are stored in the memory.

① AUTO (auto mode)

In this mode, the types of signals being input to the digital and analog input jacks for the selected input source are detected and the program in the AVR-2805's surround decoder is selected automatically upon playback. This mode can be selected for all input sources other than PHONO and TUNER.

The presence or absence of digital signals is detected, the signals input to the digital input jacks are identified and decoding and playback are performed automatically in DTS, Dolby Digital or PCM (2 channel stereo) format. If no digital signal is being input, the analog input jacks are selected. Use this mode to play Dolby Digital signals.

② PCM (exclusive PCM signal playback mode)

Decoding and playback are only performed when PCM signals are being input.

Note that noise may be generated when using this mode to play signals other than PCM signals.

③ DTS (exclusive DTS signal playback mode)

Decoding and playback are only performed when DTS signals are being input.

④ ANALOG (exclusive analog audio signal playback mode)

The signals input to the analog input jacks are played.

⑤ EXT. IN (external decoder input jack selection mode)

The signals being input to the external decoder input jacks are played without passing through the surround circuitry.

NOTE:

- Note that noise will be output when CDs or LDs recorded in DTS format are played in the "PCM" (exclusive PCM signal playback) or "ANALOG" (exclusive PCM signal playback) mode. Select the AUTO or DTS mode when playing signals recorded in DTS from a laser disc player or CD player.

3 Select the play mode.

Example: Stereo

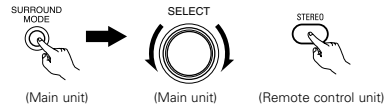

※ To select the surround mode while adjusting the surround parameters, channel volume or tone control, press the surround mode button then operate the selector.

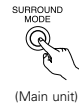

4 Start playback on the selected component.

- For operating instructions, refer to the component's manual.

5 Adjust the volume.

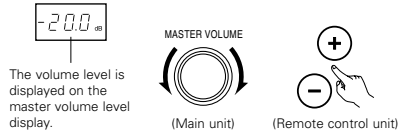

※ The volume can be adjusted within the range of -80 to 0 to 18 dB, in steps of 0.5 dB. However, when the channel level is set as described on page 20 or pages 39, if the volume for any channel is set at +0.5 dB or greater, the volume cannot be adjusted up to 18 dB. (In this case the maximum volume adjustment range is "18 dB — (Maximum value of channel level)".)

Input mode when playing DTS sources

- Noise will be output if DTS-compatible CDs or LDs are played in the "ANALOG" or "PCM" mode. When playing DTS-compatible sources, be sure to connect the source component to the digital input jacks (OPTICAL/COAXIAL) and set the input mode to "DTS".

Note on playing a source encoded with DTS

- Noise may be generated at the beginning of playback and while searching during DTS playback in the AUTO mode. If so, play in the DTS mode.

Input mode display

- In the AUTO mode



Depending on the input signal.
AL24

- In the DIGITAL PCM mode



AL24

- In the DIGITAL DTS mode



- In the ANALOG mode



- In the EXT.IN mode



Input signal display

- DOLBY DIGITAL



- DTS



- PCM



※ The **DIG.** indicator lights when digital signals are being input properly. If the **DIG.** indicator does not light, check whether the digital input component setup (page 22) and connections are correct and whether the component's power is turned on.

※ AL24 processing is activated when PCM signals are played while the surround mode is set to PURE DIRECT, DIRECT or STEREO.

NOTE:

- The **DIG.** indicator will light when playing CD-ROMs containing data other than audio signals, but no sound will be heard.

Playback using the external input (EXT. IN) jacks

1 Set the external input (EXT. IN) mode. Press the EXT. IN to switch the external input.



Once this is selected, the input signals connected to the FL (front left), FR (front right), C (center), SL (surround left), SR (surround right), SBL (surround back left) and SBR (surround back right) channels of the EXT. IN jacks are output directly to the front (left and right), center, surround (left and right) and surround back (left and right) speaker systems as well as the pre-out jacks without passing through the surround circuitry.

In addition, the signal input to the SW (subwoofer) jack is output to the PRE OUT SUBWOOFER jack.

2 Cancelling the external input mode
To cancel the external input (EXT. IN) setting, press the input mode (AUTO, PCM, DTS) or ANALOG button to switch to the desired input mode. (See page 34)

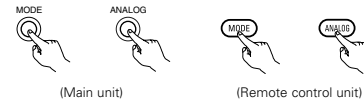

- When the input mode is set to the external input (EXT. IN), the surround mode (DIRECT, STEREO, STANDARD, 5/7CH STEREO, WIDE SCREEN or DSP SIMULATION) cannot be set.

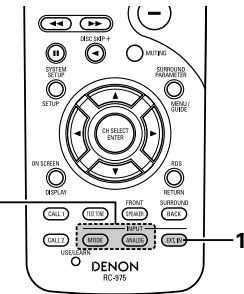
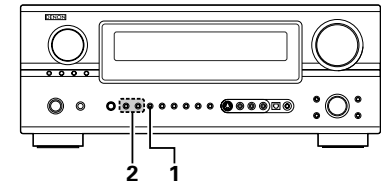

NOTES:

- In play modes other than the external input mode, the signals connected to these jacks cannot be played. In addition, signals cannot be output from channels not connected to the input jacks.
- The external input mode can be set for any input source. To watch video while listening to sound, select the input source to which the video signal is connected, then set this mode.
- If the subwoofer output level seems to high, set the "SW ATT" surround parameter to "ON".

Playing audio sources (CDs and DVDs)

The AVR-2805 is equipped with three 2-channel playback modes exclusively for music. Select the mode to suit your tastes.

1 PURE DIRECT mode

In this mode, the music is played with an extremely high level of sound quality. When this mode is set, all the video-related circuits are turned off so that music signals can be reproduced with high quality. When an analog mode is selected, the digital processing circuitry is also turned off to achieve analog sound with even higher purity. (See NOTES)

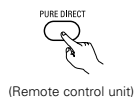

2 DIRECT mode

Use this mode to achieve good quality 2-channel sound while watching images. In this mode, the audio signals bypass such circuits as the tone circuit and are transmitted directly, resulting in good quality sound.



3 STEREO mode

Use this mode to adjust the tone and achieve the desired sound while watching images.

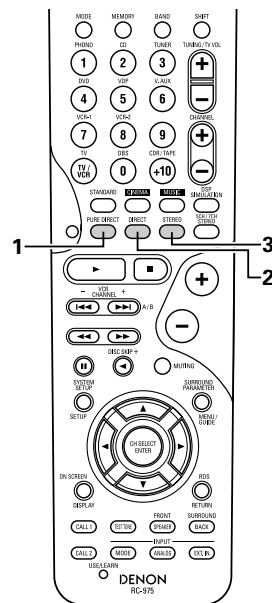
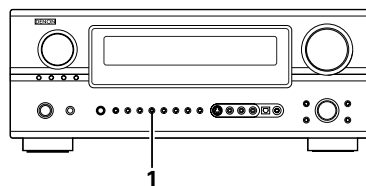

NOTES:

- The system setup function cannot be used when the PURE DIRECT mode is set. To use the system setup function, cancel the PURE DIRECT mode.
- The ZONE2 video output is not output in the PURE DIRECT mode.
- The channel level and surround parameters in the PURE DIRECT mode are the same as in the DIRECT mode.
- When the PURE DIRECT button is pressed while in the PURE DIRECT mode, the PURE DIRECT mode is cancelled.
- The subwoofer's channel level must be set to "OFF" in order to turn off the digital circuit in the PURE DIRECT mode.

After starting playback

[1] Adjusting the sound quality (TONE)

The tone control function will not work in the PURE DIRECT and the DIRECT mode.

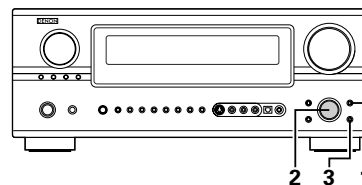

1 The tone switches as follows each time the TONE CONTROL button is pressed.



BASS ← TREBLE

2



With the name of the volume to be adjusted selected, turn the SELECT knob to adjust the level.

- To increase the bass or treble: Turn the control clockwise. (The bass or treble sound can be increased to up to +6 dB in steps of 1 dB.)
- To decrease the bass or treble: Turn the control counterclockwise. (The bass or treble sound can be decreased to up to -6 dB in steps of 1 dB.)

3

If you do not want the bass and treble to be adjusted, turn on the tone defeat mode.



※ The signals do not pass through the bass and treble adjustment circuits, providing higher quality sound.

[2] Listening over headphone

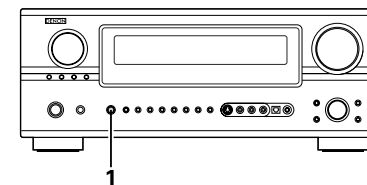

1



Plug the headphone' plug into the jack.

※ Connect the headphone to the PHONES jack. The pre-out output (including the speaker output) is automatically turned off when headphone are connected.

NOTE:

To prevent hearing loss, do not raise the volume level excessively when using headphone.

[3] Turning the sound off temporarily (MUTING)

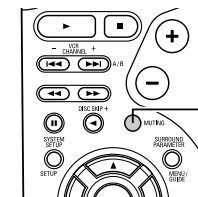

1



Use this to mute the audio output temporarily. Press the MUTING button.

(Remote control unit)

※ The Muting level is the same level as set with "5-5 Setting the Muting Level".

※ Cancelling MUTING mode. Press the MUTING button again.

[4] Combining the currently playing sound with the desired image

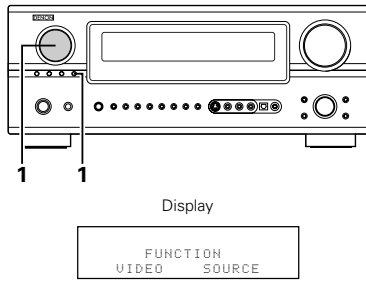

- 1** Simulcast playback
Use this switch to monitor a video source other than the audio source. Press the VIDEO SELECT button, turn the FUNCTION knob until the desired source appears on the display.

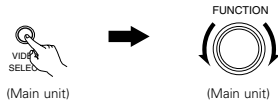

- ※ Cancelling simulcast playback.
- Select "SOURCE" using the VIDEO SELECT button and the FUNCTION button.
- Switch the program source to the component connected to the video input.
- Press the SOURCE button.

[5] Checking the currently playing program source, etc.

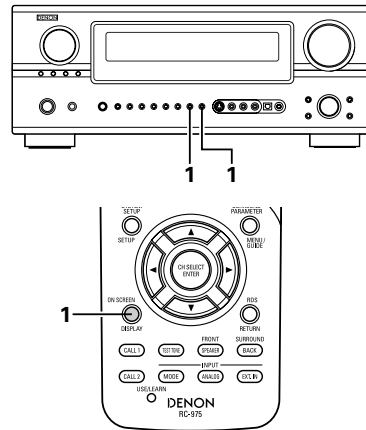

- 1** Front panel display
- Descriptions of the unit's operations are also displayed on the front panel display. In addition, the display can be switched to check the unit's operating status while playing a source by pressing the STATUS button.



- Using the dimmer function
- Use this to change the brightness of the display. The display brightness changes in four steps (bright, medium, dim and off) by pressing the main unit's DIMMER button repeatedly.



- On screen display
- Each time an operation is performed, a description of that operation appears on the display connected to the unit's VIDEO MONITOR OUT jack. Also, the unit's operating status can be checked during playback by pressing the remote control unit's ON SCREEN button. Such information as the position of the input selector and the surround parameter settings is output in sequence.

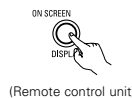

Multi-source recording/playback

Playing one source while recording another (REC OUT mode)

- 1** Press the ZONE2 / REC SELECT button.



- 2** With "REOUT SOURCE" displayed, turn the FUNCTION knob to select the source you wish to record.
- When the "REC" indicator and the indicator of the selected source light.

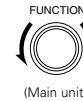

- 3** Set the recording mode.
- For operating instructions, refer to the manual of the component on which you want to record.

- 4** To cancel, turn the function knob and select "SOURCE".

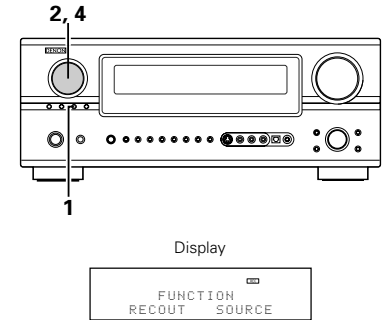

NOTES:

- Recording sources other than digital inputs selected in the REC OUT mode are also outputted from the Zone2 preout jacks.
- Digital signals are not outputted from the analog REC OUT jacks.

10 MULTI ZONE

Multi-zone playback with multi-source

MULTI ZONE MUSIC ENTERTAINMENT SYSTEM

- When the outputs of the "ZONE2" OUT terminals are wired and connected to integrated amplifiers installed in other rooms, different sources can be played in rooms other than the main zone in which this unit and the playback devices are installed. (Refer to ZONE2 on the diagram below.)
- ZONE2 SPEAKER OUT can be used when "ZONE2" is selected at System Setup Menu "Power Amp Assign". In this case, Surround Back Speaker OUT cannot be used for MAIN ZONE. (See page 25.)
- ※ To control playback devices other than the ones above, either use that device's remote control unit or preset a separately sold programmable remote control unit.

NOTES:

- For the AUDIO output, use high quality pin-plug cords and wire in such a way that there is no humming or noise.
- For instructions on installation and operation of separately sold devices, refer to the devices' operating instructions.
- When the PURE DIRECT mode is set for the main zone, no signals are output to the ZONE2 video terminals.
- Signals are output from the ZONE2 video terminals even when ZONE2 is set to "OFF".

MULTI ROOM MUSIC ENTERTAINMENT SYSTEM

[Multi-zone playback using the ZONE2 PRE OUT terminals]

■ When using the SURR. BACK amplifier as the SURROUND BACK.

The AVR-2805 is equipped with pre-out terminals for which the volume is adjustable (ZONE2) and composite video output terminals as the ZONE2 output terminals.

System configuration and connections example.

Using external amplifier

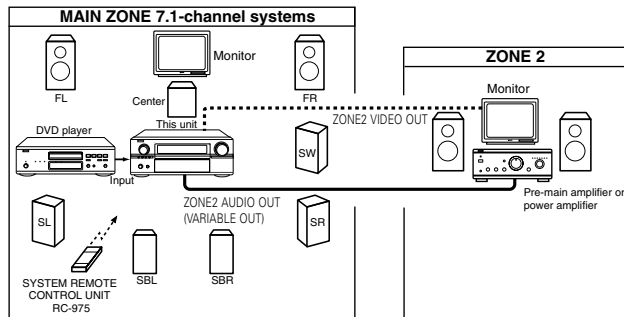

— MULTI SOURCE AUDIO signal cable
 ZONE2 VIDEO signal cable
 * Refer to CONNECTIONS on pages 5 to 9.

■ When using the SURR. BACK amplifier as the ZONE2.

- ZONE2 speaker out can be used when "ZONE2" is selected at System Setup Menu "Power Amp Assign". In this case, Surround Back PREOUT and speaker out cannot be used for MAIN ZONE.
- The AVR-2805 is equipped with preout terminals for which the volume is adjustable (ZONE2) and speaker out terminals for which the volume is adjustable (ZONE2) and composite video output terminals as the ZONE2 output terminals.

System configuration and connections example.
 Using this unit's internal amplifier as the ZONE2.

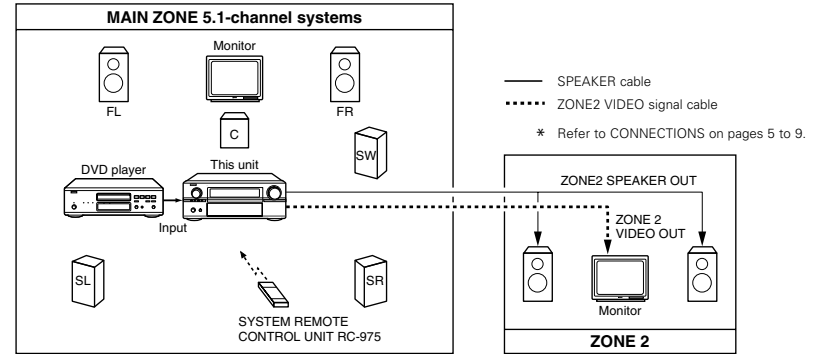

[1] Outputting a program source to an amplifier, etc., in a different room (ZONE2 mode)

- Press the POWER switch (button).

(Main unit)
- Press the ZONE2 / REC SELECT button.
 The display switches as follows each time the button is pressed.

ZONE2 ↔ RECOUT
- With "ZONE2 SOURCE" displayed, turn the FUNCTION knob and select the source you wish to output.

 - The display switches the selected source.
- Start playing the source to be output.

 - For operating instructions, refer to the manuals of the respective components.
- To cancel, turn the function knob and select "SOURCE".

(Main unit)

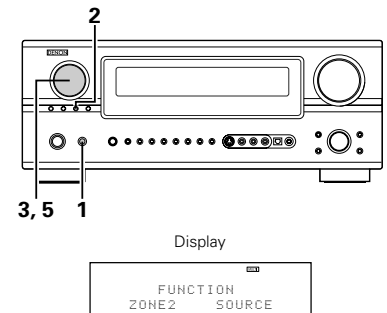

- #### NOTES:
- The signals of the source selected in the ZONE2 mode are also output from the VCR-1, VCR-2 and CDR/TAPE recording output jacks.
 - Digital signals are not output from the ZONE2 audio output jacks.
 - Refer to page 38 about the MULTI ZONE connections.

[2] Remote control unit operations during multi-source playback (selecting the input source)

This operation is not possible in the REC OUT mode.
This operation is possible when ZONE2 mode is selected.

1  Select "ZONE2" using the ZONE2 button.
(Remote control unit)

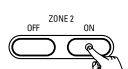
2  Press the ZONE2 "ON" button.
(Remote control unit)
* To turn off the ZONE2 mode. Press the ZONE2 "OFF" button.

3 Press the input source button
• The ZONE2 source switches directly.

4 The output level of the ZONE2 OUT terminals can be controlled using the VOLUME + and - buttons on the remote control unit.
The output level of ZONE2 OUT can be controlled only if ZONE2 vol. level is set "Variable" at Zone2 Control in System Setup Menu. (see page 26)

* DEFAULT SETTING (ZONE2 VOLUME LEVEL) :
--- dB (MINIMUM)

(Remote control unit)

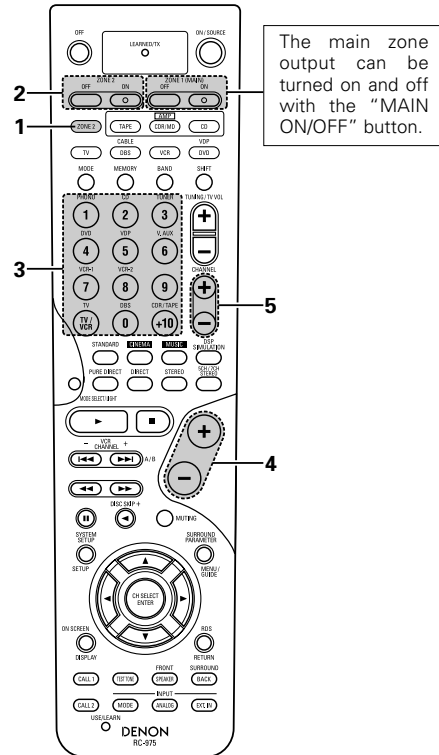
5  When the ZONE2 SOURCE function is set to TUNER, the preset channel can be selected using the CHANNEL + and - buttons on the remote control unit.
(Remote control unit)





The main zone output can be turned on and off with the "MAIN ON/OFF" button.

[1] SURROUND

Before playing with the surround function

- Before playing with the surround function, be sure to use the test tones to adjust the playback level from the different speakers. This adjustment can be performed with the system setup (see page 20) or from the remote control unit, as described below.
- Adjusting with the remote control unit using the test tones is only possible in the "Auto" mode and only effective in the STANDARD (DOLBY/DTS SURROUND) modes. The adjusted levels for the different modes are automatically stored in the memory.

1  Press the TEST TONE button.
(Remote control unit)

2  Test tones are output from the different speakers. Use the channel volume adjust buttons to adjust so that the volume of the test tones is the same for all the speakers.
(Remote control unit)

3  After completing the adjustment, press the TEST TONE button again.
(Remote control unit)

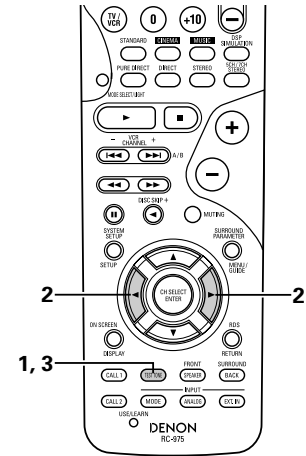

- After adjusting using the test tones, adjust the channel levels either according to the playback sources or to suit your tastes, as described below.

1  Select the speaker level you want to adjust.
(Remote control unit)

The channel switches as shown below each time the button is pressed.

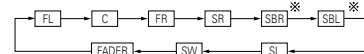

2  Adjust the level of the selected speaker.
(Remote control unit)

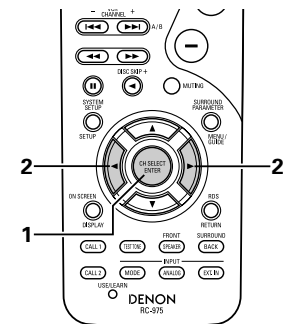

NOTES:

- The adjustment range for the different channels is +12 dB to -12 dB.
- The sound from the subwoofer can be cut by lowering the SW (subwoofer) setting one step from -12 dB (setting it to "OFF").

* When the surround back speaker setting is set to "1spkr" for "Speaker Configuration", this is set to "SB".

Fader function

- This function makes it possible to lower the volume of the front channels (FL, C and FR) or the rear channels (SL, SR, SBL and SBR) together. Use it for example to adjust the balance of the sound from each position when multi-channel music sources are played.

1 Select "FADER".

The channel switches in the order shown below each time this button is pressed.

(Remote control unit)

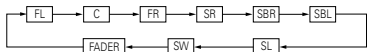

2 Press the CURSOR left button to reduce the volume of the front channels, the CURSOR right button to reduce the volume of the rear channels.

(Remote control unit)

※ The fader function does not affect the SW channel.

- ※ The channel whose channel level is adjusted lowest can be faded to -12 dB using the fader function.
- ※ If the channel levels are adjusted separately after adjusting the fader, the fader adjustment values are cleared, so adjust the fader again.

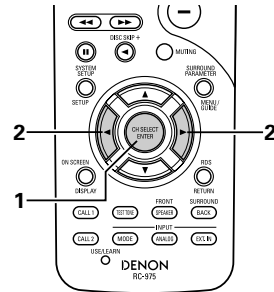

Fader	FRONT	REAR
FL	0.0dB	
C	0.0dB	
FR	0.0dB	
SR	0.0dB	
SBR	0.0dB	
SL	0.0dB	
SBL	0.0dB	

This is only displayed when setting the fader control.

*Fader Vol.	Front	Rear
-------------	-------	------

Dolby Pro Logic IIx (Pro Logic II) mode

To play in the PL IIx mode, set "Sp.Back" at the Speaker Configuration setting to "1Spkr" or "2Spkrs".
To play in the PL IIx mode, set "Surround Back" at the Power Amp Assign setting.

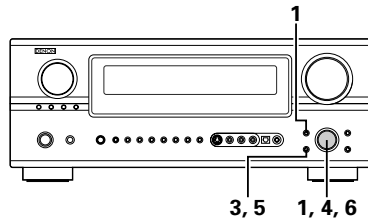

The Dolby Surround Pro Logic IIx Cinema or Music mode can be chosen directly by pressing the CINEMA or MUSIC button on the remote control unit during playback in the Dolby Pro Logic IIx mode.

1 Select the Dolby Pro Logic IIx mode.

(Main unit) (Main unit) (Remote control unit)

2 Play a program source with the **DS** [DOLBY SURROUND] mark.

- For operating instructions, refer to the manuals of the respective components.

3 Set the surround parameter mode.

(Main unit) (Remote control unit)

※ The on-screen display differs according to whether the operation is performed from the main unit or the remote control unit.

4 Select the play mode.

(Main unit) (Remote control unit)

NOTE:

- The PLIIx mode is set when the "SB CH OUT" surround parameter is set to "ON", and the PLII mode is set when this parameter is set to "OFF".

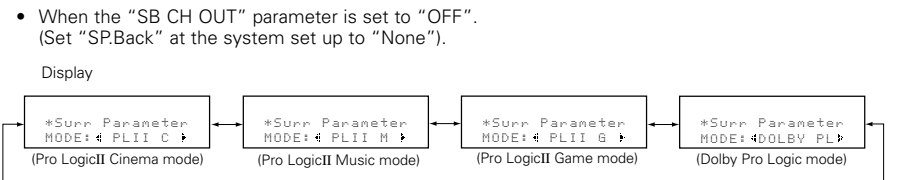
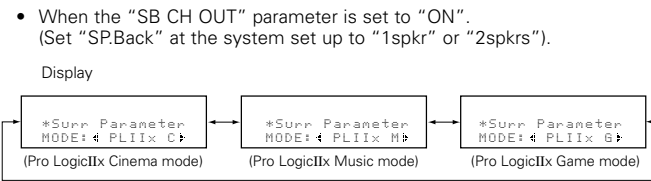

5 Select the parameter to change. (See "Surround parameters ①" for a description of each parameter.)

(Main unit) (Remote control unit)

Ex : DOLBY PLIIx music mode screen.

- ※ When set with the on-screen display using the remote control unit while in the MUSIC mode, set the "OPTION" mark to "OPTION" and down buttons, then press the CURSOR left button. Press the ENTER button to return to the previous screen.

6 Set the various surround parameters.

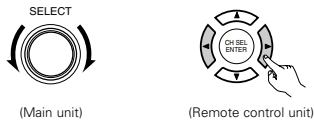

If the setting ends, press the "ENTER" or "SURROUND PARAMETER" button.

7 When the surround parameters are set using the buttons on the main unit, stop operating buttons after completing the settings. The settings are automatically finalized and the normal display reappears after several seconds.

When the settings are made using the buttons on the remote control unit, press the "ENTER" or "SURROUND PARAMETER" button to finish.

DTS NEO:6 mode

- Surround playback can be performed for the analog input and PCM digital input 2-channel signals.

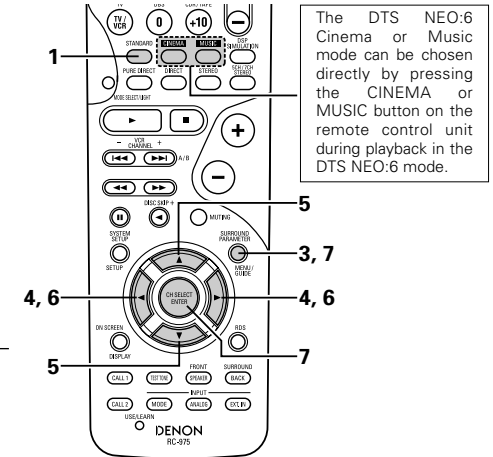
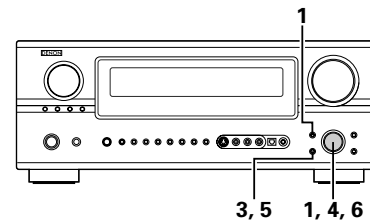

The DTS NEO:6 Cinema or Music mode can be chosen directly by pressing the CINEMA or MUSIC button on the remote control unit during playback in the DTS NEO:6 mode.

NOTE:

- There are four Dolby Surround Pro Logic modes (NORMAL, PHANTOM, WIDE and 3 STEREO). The AVR-2805 sets the mode automatically according to the types of speakers set during the system setup process (page 18).

Surround parameters ①

Pro Logic Ix and Pro Logic II Mode:

Select one of the modes ("Cinema", "Music", "Pro Logic" or "Game").

• Cinema

This mode is for use with stereo television shows and all programs encoded in Dolby Surround.

• Music

This mode is recommended as the standard mode for auto sound music systems (no video), and is optional for A/V systems.

Panorama Control:

This mode extends the front stereo image to include the surround speakers for an exciting "wraparound" effect with side wall imaging.

Select "OFF" or "ON".

Dimension Control:

This control gradually adjust the soundfield either towards the front or towards the rear. The control can be set in 7 steps from 0 to 6.

Center Width Control:

This control adjust the center image so it may be heard only from the center speaker; only from the left/right speakers as a phantom image; or from all three front speakers to varying degrees. The control can be set in 8 steps from 0 to 7.

• Pro Logic

This mode offers the same robust surround processing as original Pro Logic in case the source contents is not of optimum quality.

• Game

This mode for playing games. The game mode can only be used with 2-channel audio sources.

1 Select the DTS NEO:6 mode.



(Main unit) (Main unit) (Remote control unit)

- The mode switches as shown below each time the button is pressed.

DOLBY PLIIX ↔ DTS NEO:6

2 Play a program source.

3 Set the surround parameter mode.

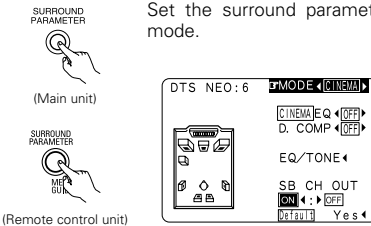

(Main unit)
(Remote control unit)

4 Select the play mode.

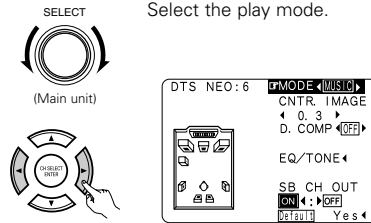

(Main unit)
(Remote control unit)

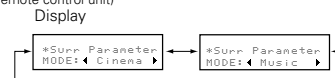

5 Select the various parameters.

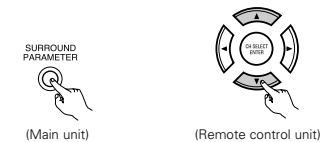

(Main unit) (Remote control unit)

6 Adjust the parameter settings.

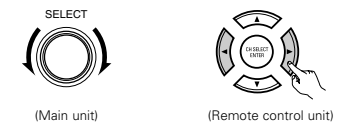

(Main unit) (Remote control unit)

7 When the surround parameters are set using the buttons on the main unit, stop operating buttons after completing the settings. The settings are automatically finalized and the normal display reappears after several seconds.

When the settings are made using the buttons on the remote control unit, press the "ENTER" or "SURROUND PARAMETER" button to finish.

Surround parameters ②

DTS NEO:6 Mode:

• Cinema

This mode is optimum for playing movies. Decoding is performed with emphasis on separation performance to achieve the same atmosphere with 2-channel sources as with 6.1-channel sources.

This mode is effective for playing sources recorded in conventional surround formats as well, because the in-phase component is assigned mainly to the center channel (C) and the reversed phase component to the surround (SL, SR and SB channels).

• Music

This mode is suited mainly for playing music. The front channel (FL and FR) signals bypass the decoder and are played directly so there is no loss of sound quality, and the effect of the surround signals output from the center (C) and surround (SL, SR and SB) channels add a natural sense of expansion to the sound field.

CENTER IMAGE (0.0 to 1.0: default 0.3):

The center image parameter for adjusting the expansion of the center channel in the DTS NEO:6 MUSIC mode has been added.

Dolby Digital mode (only with digital input) and DTS Surround mode (only with digital input)

1 Select the input source.

Playback with a digital input

① Select an input source set to digital (COAXIAL/OPTICAL) (see page 22).



(Main unit)



(Remote control unit)

② Set the input mode to "AUTO" or "DTS".



(Main unit)



(Remote control unit)

2 Select the STANDARD (Dolby/DTS Surround) mode.



(Main unit)



(Main unit)



(Remote control unit)

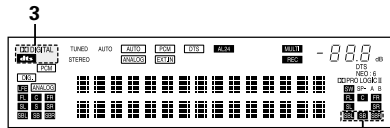

3

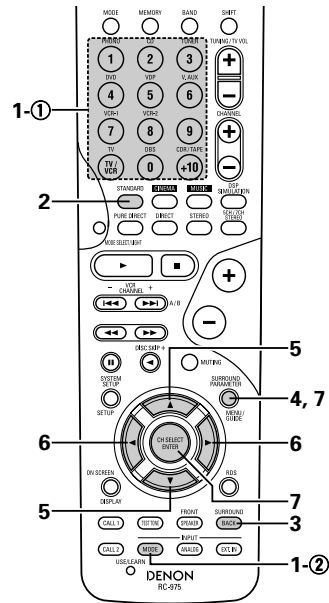
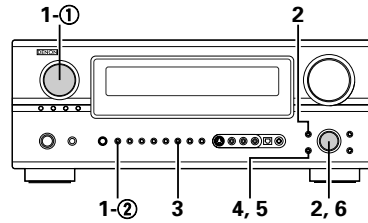

3 Play a program source with the **DOLBY DIGITAL**, **dts** mark.

Light • The Dolby Digital indicator lights when playing Dolby Digital sources.

Light • The DTS indicator lights when playing DTS sources.

Light • Press the SURROUND BACK button. Lights when the Surround Back CH is on.



Light



(Main unit)



(Remote control unit)

4 Display the surround parameter menu.



(Main unit)



(Remote control unit)

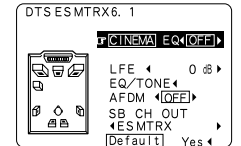
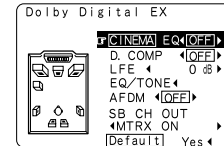

NOTE: The display on the screen differs depending on whether you are performing the operation from the main unit or the remote control unit.

5 Select the various parameters.



(Main unit)



(Remote control unit)

6 Adjust the parameter settings.



(Main unit)



(Remote control unit)

Dialogue Normalization

The dialogue normalization function is activated automatically when playing Dolby Digital program sources.

Dialogue normalization is a basic function of Dolby Digital which automatically normalizes the dialog level (standard level) of the signals which are recorded at different levels for different program sources, such as DVD, DTV and other future formats that will use Dolby Digital.

These contents can be verified with the STATUS and ON SCREEN button.

Display

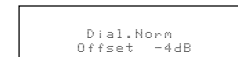

The number indicates the normalization level when the currently playing program is normalized to the standard level.

NOTE:

- When "Default" is selected and the CURSOR left button is pressed, "CINEMA EQ." and "D.COMP." are automatically turned off, "LFE" is reset, and the tone is set to the default value.

Checking the input signal

The input signal can be checked by pressing the remote control unit's ON SCREEN button.

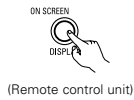

(Remote control unit)

- SIGNAL:** Displays the type of signal (DTS, DOLBY DIGITAL, PCM, etc.).
- fs:** Displays the input signal's sampling frequency.
- FORMAT:** Displays the input signal's number of channels. "Number of front channels/Number of surround channels/LFE on/off"
"SURROUND" is displayed for 2-channel signal sources recorded in Dolby Surround.
- OFFSET:** Displays the dialog normalization offset value.
- FLAG:** Displays the special identification signal recorded in the input signal. "MATRIX" is displayed when matrix processing is conducted on the surround back channel, "DISCRETE" is displayed when discrete processing is conducted. Not displayed when no identification signal is recorded.

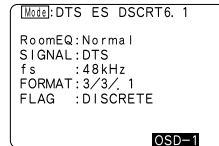
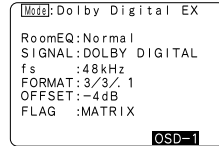

In addition, screen information is displayed in the following order when the ON SCREEN button is pressed repeatedly:

- OSD-1 Input signal
- OSD-2 Input/output
- OSD-3 Auto surround mode
- OSD-3 ~ 9 Tuner preset stations

NOTE:

- OSD-3: This is displayed when the auto surround mode is set to "ON" and the input mode is set to "Auto". It is not displayed when the input mode is set to "Analog" or "EXT. IN".

Surround parameters ③

CINEMA EQ. (Cinema Equalizer):

The Cinema EQ function gently decreases the level of the extreme high frequencies, compensating for overly-bright sounding motion picture soundtracks. Select this function if the sound from the front speakers is too bright.

This function only works in the Dolby Pro Logic IIx, Dolby Digital, DTS Surround, DTS NEO:6 and WIDE SCREEN modes. (The same contents are set for all operating modes.)

D.COMP. (Dynamic Range Compression):

Motion picture soundtracks have tremendous dynamic range (the contrast between very soft and very loud sounds). For listening late at night, or whenever the maximum sound level is lower than usual, the Dynamic Range Compression allows you to hear all of the sounds in the soundtrack (but with reduced dynamic range). (This only works when playing program sources recorded in Dolby Digital or DTS.) Select one of the four parameters ("OFF", "LOW", "MID" (middle) or "HI" (high)). Set to OFF for normal listening.

LFE (Low Frequency Effect):

This sets the level of the LFE (Low Frequency Effect) sounds included in the source when playing program sources recorded in Dolby Digital or DTS.

If the sound produced from the subwoofer sounds distorted due to the LFE signals when playing Dolby Digital or DTS sources when the peak limiter is turned off with the subwoofer peak limit level setting (system setup menu), adjust the level as necessary.

Program source and adjustment range:

- 1. Dolby Digital: -10 dB to 0 dB
- 2. DTS Surround: -10 dB to 0 dB

※ **When DTS encoded movie software is played, it is recommended that the LFE LEVEL be set to 0 dB for correct DTS playback.**

※ **When DTS encoded music software is played, it is recommended that the LFE LEVEL be set to -10 dB for correct DTS playback.**

STONE:

This adjusts the tone control. This can be set individually for the separate shroud mode other than Pure direct and direct mode.

AFDM (Auto Flag Detect Mode):

ONThis function only works with software on which a special identification signal is recorded. This software is scheduled to go on sale in the future.

This is a function for automatically playing in the 6.1-channel mode using the surround back speakers if the software is recorded in DTS-ES or in the normal 5.1-channel mode without using the surround back speakers when the software is not recorded in DTS-ES.

OFFSet the "OFF" mode to perform 6.1-channel playback with conventional 5.1-channel sources or sources on which the identification signal described below is not recorded.

SB CH OUT:

(1) (Multi channel source)

"OFF"Playback is conducted without using the surround back speaker.

"NON MTRX"The same signals those of the surround channels are output from the surround back channels.

"MTRX ON"Surround back channel is reproduced using digital matrix processing.

"ES MTRX"When playing DTS signals, the surround back signals undergo digital matrix processing for playback.

"ES DSCRT"When a signal identifying the source as a discrete 6.1-channel source is included in the DTS signals, the surround back signals included in the source are played.

"PL IIx Cinema"Processing is performed with the Cinema mode of the PL IIx decoder and the Surround Back channel is reproduced.

"PL IIx Music"Processing is performed with the Music mode of the PL IIx decoder and the Surround Back channel is reproduced.

(2) (2ch source)

"OFF"Playback is conducted without using the surround back speaker.

"ON"Playback is conducted using the surround back speaker.

NOTE: This operation can be performed directly using the "SURROUND BACK" button on the main unit's panel.

Adjusting the Audio Delay

When watching a DVD or other video source, the picture on the monitor may seem delayed with respect to the sound. In this case, adjust the audio delay to delay the sound and synchronize it with the picture. The audio delay setting is stored separately for each input source.

1 ① Select the input source.

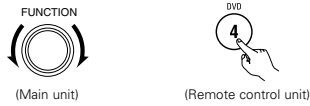

② Set the input mode to "AUTO".

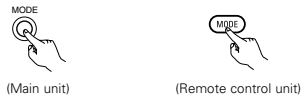

③ Select the Dolby/DTS Surround.

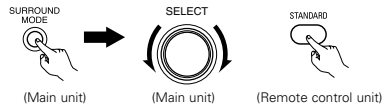

④ Play a program source (DVD, etc.).

2 Press the SYSTEM SETUP button and display the System Setup Menu.

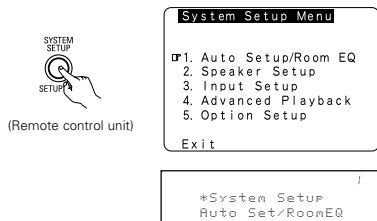

3 Select "Advanced Playback" at the System Setup Menu.

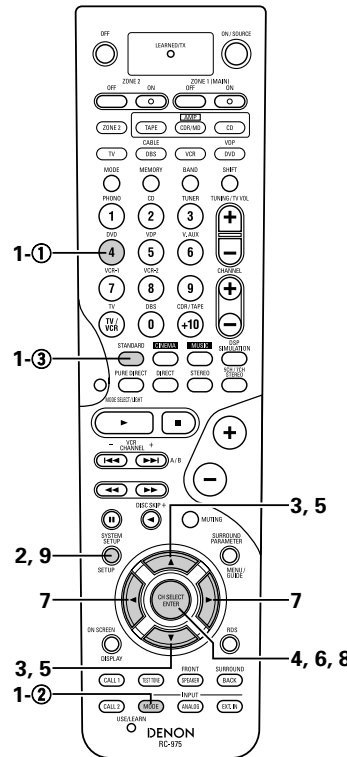
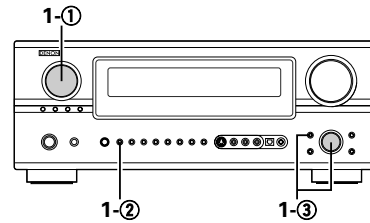

4 Press the ENTER button and display the Advanced Playback Menu.

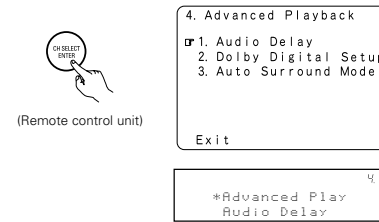

5 Select "Audio Delay" at the Advanced Playback Menu.

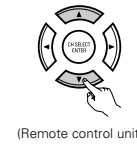

6 Switch to the Audio Delay adjustment screen.

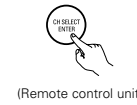

7 Set the delay time. (0 ms ~ 200 ms)

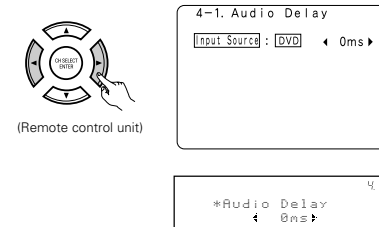

With a movie source, for example, adjust so that the movement of the actors' lips is synchronized with the sound.

8 Enter the setting. The Advanced Playback Menu reappears.

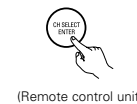

9 Press the SYSTEM SETUP button to complete the setting.

NOTE:
The audio delay setting does not apply when playing in the EXT. IN mode or in the analog input direct mode or stereo mode (TONE DEFEAT "ON").

12 DSP SURROUND SIMULATION

- The AVR-2805 is equipped with a high performance DSP (Digital Signal Processor) which uses digital signal processing to synthetically recreate the sound field. One of ten preset surround modes can be selected according to the program source and the parameters can be adjusted according to the conditions in the listening room to achieve a more realistic, powerful sound. These surround modes can also be used for program sources not recorded in Dolby Surround Pro Logic, Dolby Digital or DTS.

Surround modes and their features

1	WIDE SCREEN	Select this to achieve an atmosphere like that of a movie theater with a large screen. In this mode, all signal sources are played in the 7.1-channel mode, including Dolby Pro Logic and Dolby Digital 5.1-channel sources. Effects simulating the multi surround speakers of movie theaters are added to the surround channels.
2	SUPER STADIUM	Select this when watching baseball or soccer programs to achieve a sound as if you were actually at the stadium. This mode provides the longest reverberation signals.
3	ROCK ARENA	Use this mode to achieve the feeling of a live concert in an arena with reflected sounds coming from all directions.
4	JAZZ CLUB	This mode creates the sound field of a live house with a low ceiling and hard walls. This mode gives jazz a very vivid realism.
5	CLASSIC CONCERT	Select this for the sound of a concert hall rich in reverberations.
6	MONO MOVIE (NOTE 1)	Select this when watching monaural movies for a greater sense of expansion.
7	VIDEO GAME	Use this to enjoy video game sources.
8	MATRIX	Select this to emphasize the sense of expansion for music sources recorded in stereo. Signals consisting of the difference component of the input signals (the component that provides the sense of expansion) processed for delay are output from the surround channel.
9	VIRTUAL	Select this mode to enjoy a virtual sound field, produced from the front 2-channel speakers.
10	5CH/7CH STEREO	The front left channel signals are output to the surround and surround back signal left channels, the front right channel signals are output to the surround and surround back signal right channels, and the in-phase component of the left and right channels is output to the center channel. Use this mode to enjoy stereo sound.

- ※ Depending on the program source being played, the effect may not be very noticeable. In this case, try other surround modes, without worrying about their names, to create a sound field suited to your tastes.

NOTE 1: When playing sources recorded in monaural, the sound will be one-sided if signals are only input to one channel (left or right), so input signals to both channels. If you have a source component with only one audio output (monophonic camcorder, etc.) obtain a "Y" adaptor cable to split the mono output to two outputs, and connect to the L and R inputs.

DSP surround simulation

- To operate the surround mode and surround parameters from the remote control unit.

1 Select the surround mode for each input channel.



(Remote control unit)

The surround mode switches in the following order each time the DSP SIMULATION button is pressed:

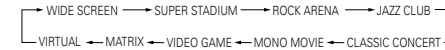

2 Press the surround parameter button. Display the surround parameter screen.
 ※ The screen for the selected surround mode appears.



(Remote control unit)

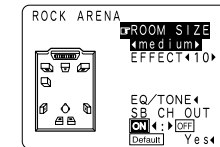

*Surround Parameter
ROOM: ← Medium →

3 Set the parameters.



(Remote control unit)

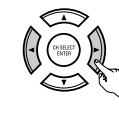

(Remote control unit)

4 When the surround parameters are set using the buttons on the main unit, stop operating buttons after completing the settings. The settings are automatically finalized and the normal display reappears after several seconds.

When the settings are made using the buttons on the remote control unit, press the "ENTER" or "SURROUND PARAMETER" button to finish.

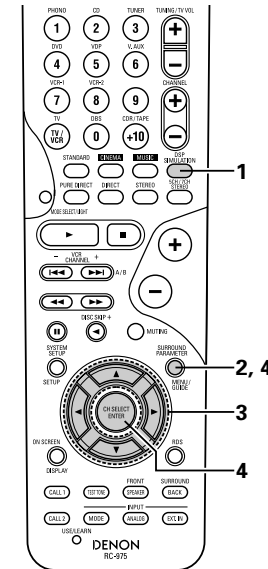

NOTES:

- The surround speaker setting can also be changed with the SPEAKER button on the remote control unit.
- When "Default" is selected and the CURSOR left button is pressed, "CINEMA EQ." and "D.COMP." are automatically turned off, "ROOM SIZE" is set to "medium", "EFFECT LEVEL" to "10", "DELAY TIME" to "30ms" and "LFE" to "0dB".
- The "ROOM SIZE" expresses the expansion effect for the different surround modes in terms of the size of the sound field, not the actual size of the listening room.
- When playing PCM digital signals or analog signals in the DOLBY PRO LOGIC II, DOLBY PRO LOGIC IIx, DTS NEO:6 modes and the input signal switches to a digital signal encoded in Dolby Digital, the Dolby surround mode switches automatically. When the input signal switches to a DTS signal, the mode automatically switches to DTS surround.

Personal Memory Plus

This set is equipped with a personal memorize function that automatically memorizes the surround modes and input modes selected for the input different sources. When the input source is switched, the modes set for that source last time it was used are automatically recalled.

- ※ The surround parameters, tone control settings and playback level balance for the different output channels are memorized for each surround mode.

- Operating the surround mode and surround parameters from the main unit's panel.

1 Turn the SELECT knob to select the surround mode.

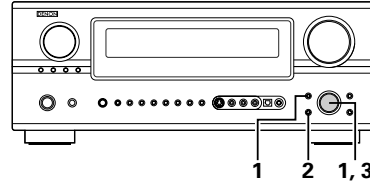

- When turned clockwise

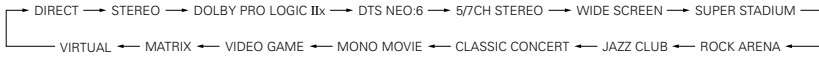

- When turned counterclockwise

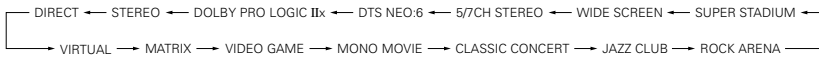

※ To select the surround mode while adjusting the surround parameters or tone control, press the surround mode button then operate the selector.

2 Press the SURROUND PARAMETER button. Press and hold in the surround parameter button to select the parameter you want to set.

- The parameters which can be set differ for the different surround modes. (Refer to "Surround Modes and Parameters" on page 47.



3 Display the parameter you want to adjust, then turn the SELECT knob to set it.

NOTE:

- When playing PCM digital signals or analog signals in the DOLBY PRO LOGIC II, DTS NEO:6 modes and the input signal switches to a digital signal encoded in Dolby Digital, the Dolby surround mode switches automatically. When the input signal switches to a DTS signal, the mode automatically switches to DTS surround.

Room EQ / Tone control setting

- Use the Room EQ setting and the tone control setting to adjust the bass and treble as desired.
- Operate the Room EQ and the tone control from the remote control unit.

1 Press the surround parameter button. Display the surround parameter screen.

- The screen selected surround mode appears.
- "TONE" cannot be selected in the Direct mode.

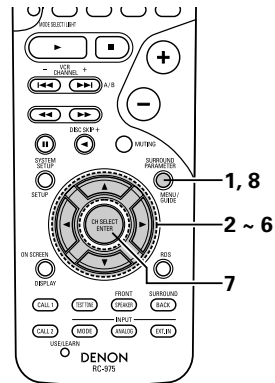
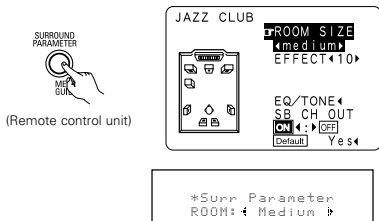

2 Select "EQ/TONE".

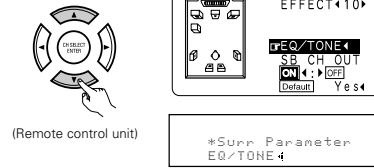

3 Display the Room EQ / Tone Control screen.

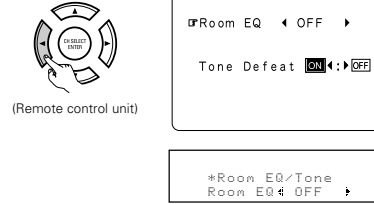

4 Select the Equalizer setting.

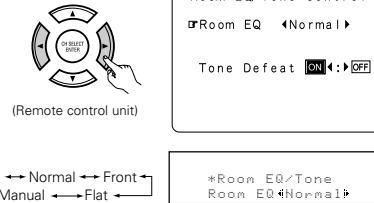

NOTES:

- The equalizer setting of Normal, Flat, and Front can be selected after performing the Auto Setup.
- When headphone is connected, the Room EQ cannot be used.

• Operate the Room EQ from the main unit.

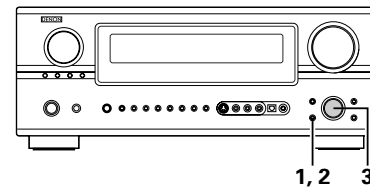

1 Press the SURROUND PARAMETER button.

- Display the surround parameter screen.



5 Select Tone Defeat OFF.

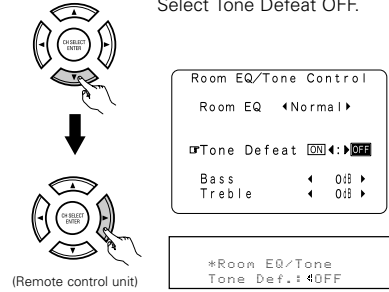

6 Select Bass or Treble. Set the level.

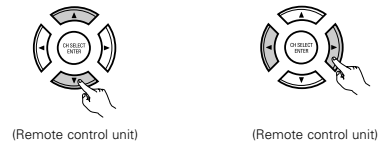

7 Enter the setting. The surround parameter menu screen reappears.

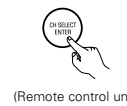

8 If the setting ends, press the "ENTER" or "SURROUND PARAMETER" button again.

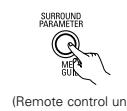

2 Select "EQ".

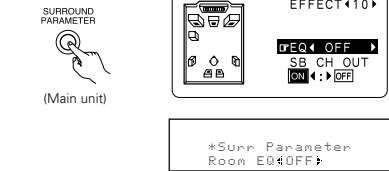

3 Select the Equalizer setting.

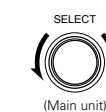

- Operate the tone control from the main unit.

1 The tone switches as follows each time the TONE CONTROL button is pressed.

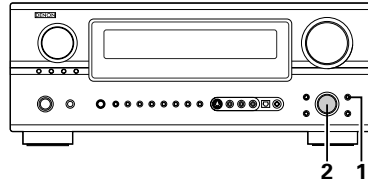
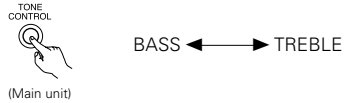

2 Select with the name of the volume to be adjusted and adjust the level.

- To increase the bass or treble: Turn the control clockwise. (The bass or treble sound can be increased to up to +6 dB in steps of 1 dB.)
- To decrease the bass or treble: Turn the control clockwise. (The bass or treble sound can be decreased up to -6 dB in steps of 1 dB.)

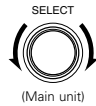

Surround parameters ④

ROOM SIZE:

This sets the size of the sound field. There are five settings: "small", "med.s" (medium-small), "medium", "med.l" (medium-large) and "large". "small" recreates a small sound field, "large" a large sound field.

EFFECT LEVEL:

This sets the strength of the surround effect. The level can be set in 15 steps from 1 to 15. Lower the level if the sound seems distorted.

DELAY TIME:

The delay time can be set within the range of 0 to 300 ms only in matrix mode.

TONE CONTROL:

This can be set individually for each surround mode except Pure Direct and Direct.

ROOM EQ:

This sets the frequency response of each speaker.
 "OFF"The Equalizer is not used.
 "Normal"Adjusts the frequency response of all speakers suitable for general surround system.
 "Front"Adjusts the characteristics of each speaker to the characteristics of the front speakers.
 "Flat"Adjusts the frequency response of all speakers flat.
 This is suitable for music reproduction like ITU-R speaker setting.
 "Manual"Selects the setting value that was set in the Manual EQ setup.

Surround modes and parameters

Mode	Signals and adjustability in the different modes								
	Channel output					When playing Dolby Digital signals	When playing DTS signals	When playing PCM signals	When playing ANALOG signals
	FRONT L/R	CENTER	SURROUND L/R	SURROUND BACK L/R	SUB-WOOFER				
DIRECT / PURE DIRECT	○	×	×	×	⊗	○	○	○	○
STEREO	○	×	×	×	⊗	○	○	○	○
EXTERNAL INPUT	○	⊗	⊗	⊗	⊗	×	×	×	○
DOLBY PRO LOGIC II	○	⊗	⊗	⊗	⊗	○*	○*	○	○
DOLBY PRO LOGIC II x	○	⊗	⊗	⊗	⊗	○*	○*	○	○
DTS NEO.6	○	⊗	⊗	⊗	⊗	○*	○*	○	○
DOLBY DIGITAL SURROUND	○	⊗	⊗	⊗	⊗	○	×	×	×
DTS SURROUND	○	⊗	⊗	⊗	⊗	×	○	×	×
5/7CH STEREO	○	⊗	⊗	⊗	⊗	○	○	○	○
WIDE SCREEN	○	⊗	⊗	⊗	⊗	○	○	○	○
SUPER STADIUM	○	⊗	⊗	⊗	⊗	○	○	○	○
ROCK ARENA	○	⊗	⊗	⊗	⊗	○	○	○	○
JAZZ CLUB	○	⊗	⊗	⊗	⊗	○	○	○	○
CLASSIC CONCERT	○	⊗	⊗	⊗	⊗	○	○	○	○
MONO MOVIE	○	⊗	⊗	⊗	⊗	○	○	○	○
VIDEO GAME	○	⊗	⊗	⊗	⊗	○	○	○	○
MATRIX	○	⊗	⊗	⊗	⊗	○	○	○	○
VIRTUAL	○	×	×	×	⊗	○	○	○	○

○ : Signal / Adjustable
 × : No signal
 ⊗ : Turned on or off by speaker configuration setting

○ : Able
 × : Unable
 * : Only for 2 ch contents

Mode	Signals and adjustability in the different modes							
	Parameter (default values are shown in parentheses)							
	When playing Dolby Digital and DTS signals			SB CH OUT (MODE)	ROOM EQ	TONE CONTROL	CINEMA EQ.	MODE
D. COMP	LFE	AFDM						
DIRECT / PURE DIRECT	○ (OFF)	○ (0dB)	×	×	○ (OFF)	×	×	×
STEREO	○ (OFF)	○ (0dB)	×	×	○ (OFF)	○ (0dB)	×	×
EXTERNAL INPUT	×	×	×	×	×	×	×	×
DOLBY PRO LOGIC II	○ (OFF)	×	×	○	○ (OFF)	○ (0dB)	○ (OFF)	○
DOLBY PRO LOGIC II x	○ (OFF)	×	×	○	○ (OFF)	○ (0dB)	○ (OFF)	○
DTS NEO.6	○ (OFF)	×	×	○	○ (OFF)	○ (0dB)	○ (OFF)	○
DOLBY DIGITAL SURROUND	○ (OFF)	○ (0dB)	○	○	○ (OFF)	○ (0dB)	○ (OFF)	×
DTS SURROUND	○ (OFF)	○ (0dB)	○	○	○ (OFF)	○ (0dB)	○ (OFF)	×
5/7CH STEREO	○ (OFF)	○ (0dB)	×	○	○ (OFF)	○ (0dB)	×	×
WIDE SCREEN	○ (OFF)	○ (0dB)	×	○	○ (OFF)	○ (0dB)	○ (OFF)	×
SUPER STADIUM	○ (OFF)	○ (0dB)	×	○	○ (OFF)	○ (Note1)	×	×
ROCK ARENA	○ (OFF)	○ (0dB)	×	○	○ (OFF)	○ (Note2)	×	×
JAZZ CLUB	○ (OFF)	○ (0dB)	×	○	○ (OFF)	○ (0dB)	×	×
CLASSIC CONCERT	○ (OFF)	○ (0dB)	×	○	○ (OFF)	○ (0dB)	×	×
MONO MOVIE	○ (OFF)	○ (0dB)	×	○	○ (OFF)	○ (0dB)	×	×
VIDEO GAME	○ (OFF)	○ (0dB)	×	○	○ (OFF)	○ (0dB)	×	×
MATRIX	○ (OFF)	○ (0dB)	×	○	○ (OFF)	○ (0dB)	×	×
VIRTUAL	○ (OFF)	○ (0dB)	×	×	○ (OFF)	○ (0dB)	×	×

○ : Able
 × : Unable

○ : Adjustable
 × : Not adjustable
 Note1 : BASS +6 dB, TREBLE 0 dB
 Note2 : BASS +6 dB, TREBLE +4 dB

Mode	Signals and adjustability in the different modes									
	SURROUND PARAMETER									
	ROOM SIZE	EFFECT ON/OFF	EFFECT LEVEL	DELAY TIME	SUBWOOFER ON/OFF	PRO LOGIC II / II x ONLY			NEO:6 MUSIC	EXT.IN
						PANORAMA	DIMENSION	CENTER WIDTH	CENTER IMAGE	SW ATT
DIRECT / PURE DIRECT	×	×	×	×	○ (OFF)	×	×	×	×	×
STEREO	×	×	×	×	×	×	×	×	×	×
EXTERNAL INPUT	×	×	×	×	×	×	×	×	×	○
DOLBY PRO LOGIC II	×	×	×	×	×	○ (OFF)	○ (3)	○ (3)	×	×
DOLBY PRO LOGIC II x	×	×	×	×	×	○ (OFF)	○ (3)	○ (3)	×	×
DTS NEO:6	×	×	×	×	×	×	×	×	×	○ (0.3)
DOLBY DIGITAL SURROUND	×	×	×	×	×	×	×	×	×	×
DTS SURROUND	×	×	×	×	×	×	×	×	×	×
5/7CH STEREO	×	×	×	×	×	×	×	×	×	×
WIDE SCREEN	×	○ (ON)	○ (10)	×	×	×	×	×	×	×
SUPER STADIUM	○ (Medium)	×	○ (10)	×	×	×	×	×	×	×
ROCK ARENA	○ (Medium)	×	○ (10)	×	×	×	×	×	×	×
JAZZ CLUB	○ (Medium)	×	○ (10)	×	×	×	×	×	×	×
CLASSIC CONCERT	○ (Medium)	×	○ (10)	×	×	×	×	×	×	×
MONO MOVIE	○ (Medium)	×	○ (10)	×	×	×	×	×	×	×
VIDEO GAME	○ (Medium)	×	○ (10)	×	×	×	×	×	×	×
MATRIX	×	×	×	○ (30ms)	×	×	×	×	×	×
VIRTUAL	×	×	×	×	×	×	×	×	×	×

○ : Adjustable
 × : Not adjustable

13 LISTENING TO THE RADIO

- Check that the remote control unit is set to AMP or TUNER.

Auto tuning

- 1** Set the input function to "TUNER".



(Main unit)



(Remote control unit)

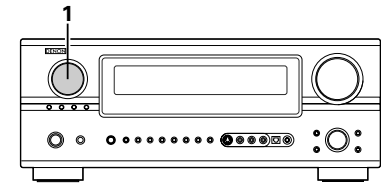

- 2**



(Remote control unit)

Watching the display, press the BAND button to select the desired band (AM or FM).

- 3**



(Remote control unit)

Press the MODE button to set the auto tuning mode.

"Auto" appears on the display.

- 4**



(Remote control unit)

Press the TUNING + or - button.

Automatic searching begins, then stops when a station is tuned in.

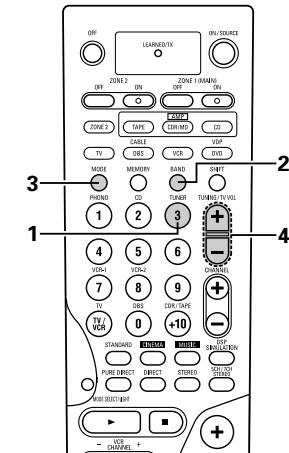

If tuning does not stop at the desired station, use the "Manual tuning" operation.

Manual tuning

- 1** Set the input function to "TUNER".



(Main unit)



(Remote control unit)

- 2**



(Remote control unit)

Watching the display, press the BAND button to select the desired band (AM or FM).

- 3**



(Remote control unit)

Press the MODE button to set the manual tuning mode. Check that the display's "AUTO" indicator turns off.

- 4**







(Remote control unit)

Press the TUNING + or - button to tune in the desired station. The frequency changes continuously when the button is held in.

NOTES:

- When in the auto tuning mode on the FM band, the "STEREO" indicator lights on the display when a stereo broadcast is tuned in. At open frequencies, the noise is muted and the "TUNED" and "STEREO" indicators turn off.
- When the manual tuning mode is set, FM stereo broadcasts are received in monaural and the "STEREO" indicator turns off.

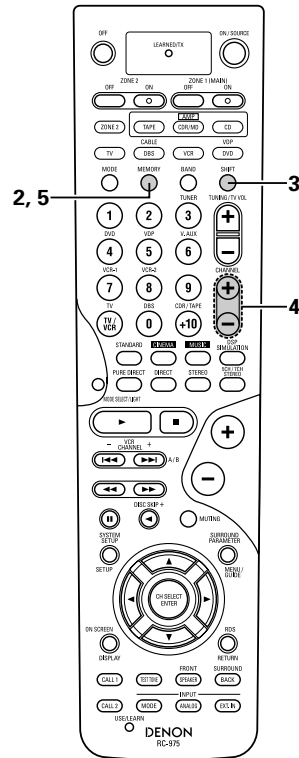

Preset memory

- 1 Use the "Auto tuning" or "Manual tuning" operation to tune in the station to be preset in the memory.
 - 2  Press the MEMORY button.
(Remote control unit)
 - 3  Press the SHIFT button and select the desired memory block (A to G).
(Remote control unit)
 - 4  Press the CHANNEL + (UP) or - (DOWN) button to select the desired preset channel (1 to 8).
(Remote control unit)
 - 5  Press the MEMORY button again to store the station in the preset memory.
(Remote control unit)
- To preset other channels, repeat steps 2 to 5. A total of 56 broadcast stations can be preset — 8 stations (channels 1 to 8) in each of blocks A to G.





Recalling preset stations

- Recalling preset stations from the remote control unit.

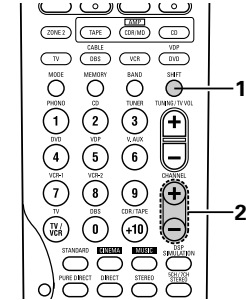
- 1  Watching the display, press the SHIFT button to select the preset memory block.
(Remote control unit)
- 2  Watching the display, press the CHANNEL + (UP) or - (DOWN) button to select the desired preset channel.
(Remote control unit)

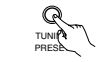

- Recalling preset stations from the main unit's panel.

- 1  Press the TUNING PRESET button.
(Main unit)
- 2  Turn the FUNCTION knob and select the desired preset channel.
(Main unit)

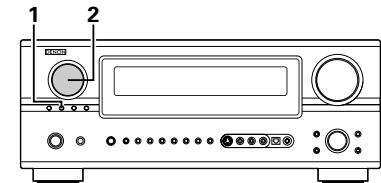

Checking the preset stations

- The preset (broadcast) stations can be checked on the on screen display.

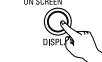
- 1 Press the ON SCREEN button repeatedly until the "Tuner Preset Stations" screen appears on the OSD.
 (Remote control unit)

Tuner Preset Stations	
A 1F	87.50MHz
A 2F	89.10MHz
A 3F	98.10MHz
A 4F	108.00MHz
A 5F	90.10MHz
A 6F	90.10MHz
A 7F	90.10MHz
A 8F	90.10MHz

OSD-3

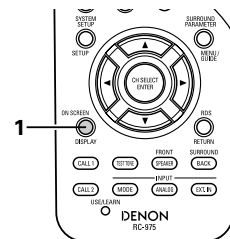

RDS (Radio Data System)

RDS (works only on the FM band) is a broadcasting service which allows station to send additional information along with the regular radio program signal.

The following three types of RDS information can be received on this unit:

■ Program Type (PTY)

PTY identifies the type of RDS program.

The program types and their displays are as follows:

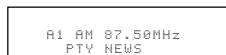

NEWS	News	ROCK M	Rock Music	PHONE IN	Phone In
AFFAIRS	Current Affairs	EASY M	Easy Listening Music	TRAVEL	Travel
INFO	Information	LIGHT M	Light Classical	LEISURE	Leisure
SPORT	Sports	CLASSICS	Serious Classical	JAZZ	Jazz Music
EDUCATE	Education	OTHER M	Other Music	COUNTRY	Country Music
DRAMA	Drama	WEATHER	Weather	NATION M	National Music
CULTURE	Culture	FINANCE	Finance	OLDIES	Oldies Music
SCIENCE	Science	CHILDREN	Children's programmes	FOLK M	Folk Music
VARIED	Varied	SOCIAL	Social Affairs	DOCUMENT	Documentary
POP M	Pop Music	RELIGION	Religion		

■ Traffic Program (TP)

TP identifies programs that carry traffic announcements.

This allows you to easily find out the latest traffic conditions in your area before you leaving home.

■ Radio Text (RT)

RT allows the RDS station to send text messages that appear on the display.

NOTE: The operations described below using the RDS, PTY and RT buttons will not function in areas in which there are no RDS broadcasts.

RDS search

Use this function to automatically tune to FM stations that provide RDS service.

- 1 Set the input function to "TUNER".



(Remote control unit)

- 2 Press the RDS button until "RDS SEARCH" appears on the display.



(Remote control unit)

※ The main unit's display switches as follows each time the RDS buttons are pressed.

Display

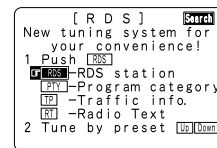
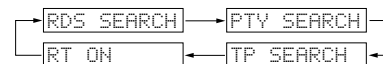

This is the screen when operated.

- 3 Press the CHANNEL + (UP) or - (DOWN) button to automatically begin the RDS search operation.



(Remote control unit)

If no RDS stations is found with above operation, all the reception band are searched.

- 4 When a broadcast station is found, that station's name appears on the display.

- 5 To continue searching, repeat step 3. If no other RDS station is found when all the frequencies are searched, "NO RDS" is displayed.

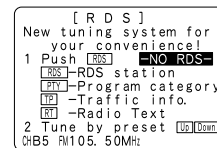

This is the screen when operated.

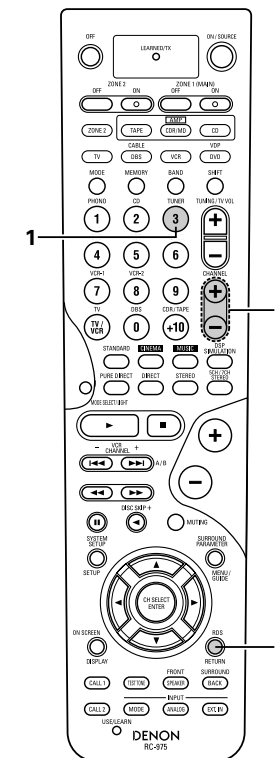

PTY search

Use this function to find RDS stations broadcasting a designated program type (PTY).
For a description of each program type, refer to "Program Type (PTY)".

- 1 Set the input function to "TUNER".

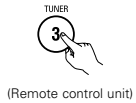

- 2 Press the RDS button until "PTY SEARCH" appears on the display.

(Remote control unit)

※ The main unit's display switches as follows each time the RDS buttons are pressed.

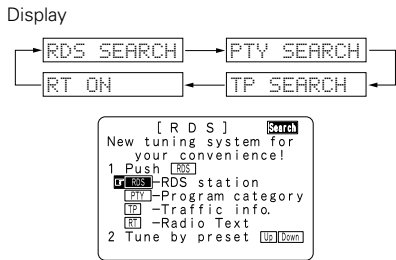

This is the screen when operated.

- 3 Watching the display, press the CURSOR left and right buttons to call out the desired program type.

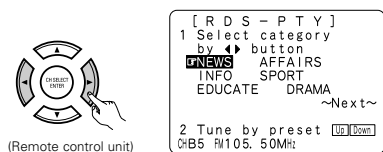

This is the screen when operated.

- 4 Press the CHANNEL + (UP) or - (DOWN) button to automatically begin the PTY search operation.

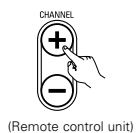

If there is no station broadcasting the designated program type with above operation, all the reception bands are searched.

- 5 The station name is displayed on the display after searching stops.

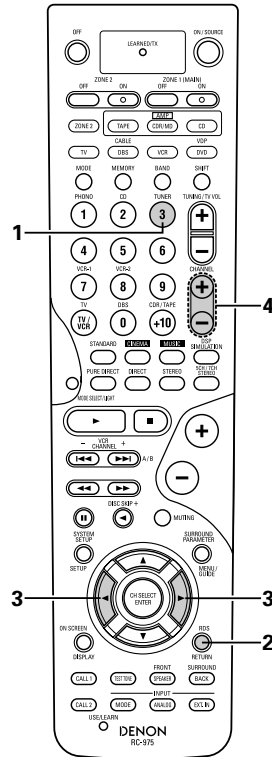

TP search

Use this function to find RDS stations broadcasting traffic program (TP stations).

- 1 Set the input function to "TUNER".

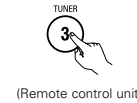

- 2 Press the RDS button until "TP SEARCH" appears on the display.

(Remote control unit)

※ The main unit's display switches as follows each time the RDS buttons are pressed.

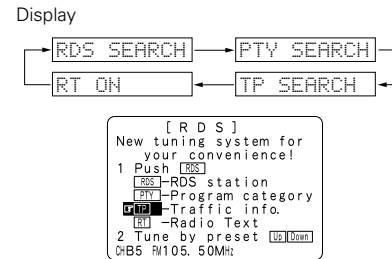

This is the screen when operated.

- 3 Press the CHANNEL + (UP) or - (DOWN) button TP search begins.

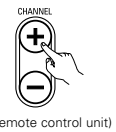

If no TP station is found with above operation, all the reception bands are searched.

- 4 The station name is displayed on the display after searching stops.

- 5 To continue searching, repeat step 3. If no other TP station is found when all the frequencies are searched, "NO PROGRAMME" is displayed.

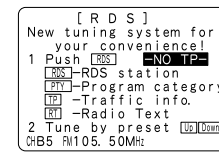

This is the screen when operated.

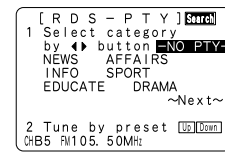
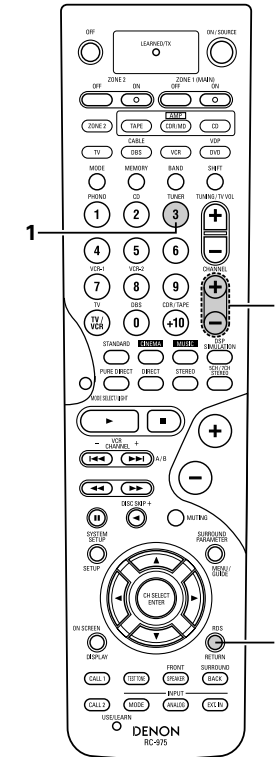

This is the screen when operated.

RT (Radio Text)

“RT” appears on the display when radio text data is received.

When the RDS button is pressed until “RT” appears on the display while receiving an RDS broadcast station, the text data broadcast from the station is displayed. To turn the display off, use the left and right cursor buttons on the remote control unit. If no text data is being broadcast, “NO TEXT DATA” is displayed.

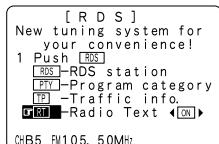

This is the screen when operated.

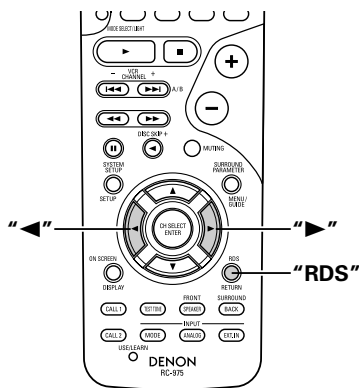

14 LAST FUNCTION MEMORY

- This unit is equipped with a last function memory which stores the input and output setting conditions as they were immediately before the power is switched off. This function eliminates the need to perform complicated resetting when the power is switched on.
- The unit is also equipped with a back-up memory. This function provides approximately one week of memory storage from when the main unit's power switch is off and with the power cord disconnected.

15 INITIALIZATION OF THE MICROPROCESSOR

When the indication of the display is not normal or when the operation of the unit does not shows the reasonable result, the initialization of the microprocessor is required by the following procedure.

- 1 Switch off the unit using the main unit's power operation switch.
- 2 Hold the following INPUT MODE button and ANALOG button, and turn the main unit's power operation switch on.
- 3 Check that the entire display is flashing with an interval of about 1 second, and release your fingers from the 2 buttons and the microprocessor will be initialized.

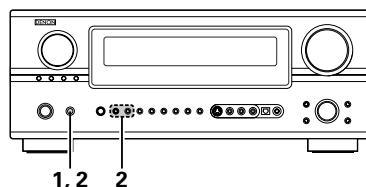

NOTES:

- If step 3 does not work, start over from step 1.
- If the microprocessor has been reset, all the settings are reset to the default values (the values set upon shipment from the factory).

16 TROUBLESHOOTING

If a problem should arise, first check the following table.

1. Are the connections correct ?
2. Have you operated the receiver according to the Operating Instructions ?
3. Are the speakers, turntable and other components operating properly ?

If this unit is not operating properly, check the items listed in the table below. Should the problem persist, there may be a malfunction.

Disconnect the power immediately and contact your store of purchase.

	Symptom	Cause	Measures	Page
Common problems when listening to the CD's, Records, Tapes and FM broadcasts, etc.	DISPLAY not lit and sound not produced when power switch set to on.	<ul style="list-style-type: none"> • Power cord not plugged in securely. 	<ul style="list-style-type: none"> • Check the insertion of the power cord plug. • Turn the power on with the remote control unit after turning the POWER switch on. 	5 34
	DISPLAY lit but sound not produced.	<ul style="list-style-type: none"> • Speaker cords not securely connected. • Improper position of the audio function button. • Volume control set to minimum. • MUTING is on. • Digital signals not input Digital input selected. 	<ul style="list-style-type: none"> • Connect securely. • Set to a suitable position. • Turn volume up to suitable level. • Switch off MUTING. • Input digital signals or select input jacks to which digital signals are being input. 	9 34 35 36 34
	DISPLAY not lit and power indicator is flashing rapidly.	<ul style="list-style-type: none"> • Speaker terminals are short-circuited. • Block the ventilation holes of the set. • The unit is operating at continuous high power conditions and/or inadequate ventilation. 	<ul style="list-style-type: none"> • Switch power off, connect speakers properly, then switch power back on. • Turn off the set's power, then ventilate it well to cool it down. Once the set is cooled down, turn the power back on. • Turn off the set's power, then ventilate it well to cool it down. Once the set is cooled down, turn the power back on. 	9 3, 8 3, 8
	Sound produced only from one channel.	<ul style="list-style-type: none"> • Incomplete connection of speaker cords. • Incomplete connection of input/output cords. 	<ul style="list-style-type: none"> • Connect securely. • Connect securely. 	9 5 ~ 9
	Positions of instruments reversed during stereo playback.	<ul style="list-style-type: none"> • Reverse connections of left and right speakers or left and right input/output cords. 	<ul style="list-style-type: none"> • Check left and right connections. 	9
	The on screen display is not displayed.	<ul style="list-style-type: none"> • "On screen display" is set to off on the system setup menu screen. 	<ul style="list-style-type: none"> • Set "on screen display" on the system setup menu screen to on. 	27
When playing records	Humming noise produced when Record is playing.	<ul style="list-style-type: none"> • Ground wire of turntable not connected properly. • Incomplete PHONO jack connection. • TV or radio transmission antenna nearby. 	<ul style="list-style-type: none"> • Connect securely. • Connect securely. • Contact your store of purchase. 	5 5 —
	Howling noise produced when volume is high.	<ul style="list-style-type: none"> • Turntable and speaker systems too close together. • Floor is unstable and vibrates easily. 	<ul style="list-style-type: none"> • Separate as much as possible. • Use cushions to absorb speaker vibrations transmitted by floor. If turntable is not equipped with insulators, use audio insulators (commonly available). 	— —
	Sound is distorted.	<ul style="list-style-type: none"> • Stylus pressure too weak. • Dust or dirt on stylus. • Cartridge defective. 	<ul style="list-style-type: none"> • Apply proper stylus pressure. • Check stylus. • Replace cartridge. 	— — —
	Volume is weak.	<ul style="list-style-type: none"> • MC cartridge being used. 	<ul style="list-style-type: none"> • Replace with MM cartridge or use a head amplifier or step-up transformer. 	5

	Symptom	Cause	Measures	Page
Remote control unit	This unit does not operate properly when remote control unit is used.	<ul style="list-style-type: none"> Batteries dead. Remote control unit too far from this unit. Obstacle between this unit and remote control unit. Different button is being pressed. ⊕ and ⊖ ends of battery inserted in reverse. 	<ul style="list-style-type: none"> Replace with new batteries. Move closer. Remove obstacle. Press the proper button. Insert batteries properly. 	29 29 — 29

17 ADDITIONAL INFORMATION

Optimum surround sound for different sources

There are currently various types of multi-channel signals (signals or formats with more than two channels).

Types of multi-channel signals

Dolby Digital, Dolby Pro Logic, DTS, high definition 3-1 signals (Japan MUSE Hi-Vision audio), DVD-Audio, SACD (Super Audio CD), MPEG multi-channel audio, etc.

“Source” here does not refer to the type of signal (format) but the recorded content. Sources can be divided into two major categories.

Types of sources

- Movie audio** Signals created to be played in movie theaters. In general sound is recorded to be played in movie theaters equipped with multiple surround speakers, regardless of the format (Dolby Digital, DTS, etc.).

Movie theater sound field

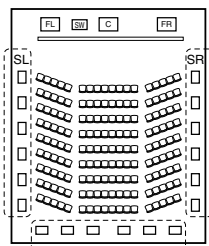

Multiple surround speakers
(For 6.1-channel system)

Listening room sound field

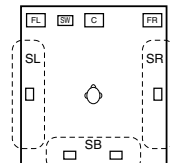

In this case it is important to achieve the same sense of expansion as in a movie theater with the surround channels. To do so, in some cases the number of surround speakers is increased (to four or eight) or speakers with bipolar or dipolar properties are used.

(SL: Surround L channel
SR: Surround R channel
SB: Surround back channel

- Other types of audio** These signals are designed to recreate a 360° sound field using three to five speakers.

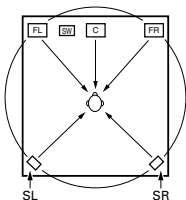

In this case the speakers should surround the listener from all sides to create a uniform sound field from 360°. Ideally the surround speakers should function as “point” sound sources in the same way as the front speakers.

These two types of sources thus have different properties, and different speaker settings, particularly for the surround speakers, are required in order to achieve the ideal sound.

Surround back speakers

A 6.1-channel system is a conventional 5.1-channel system to which the “surround back” (SB) channel has been added. This makes it easy to achieve sound positioned directly behind the listener, something that was previously difficult with sources designed for conventional multi surround speakers. In addition, the acoustic image extending between the sides and the rear is narrowed, thus greatly improving the expression of the surround signals for sounds moving from the sides to the back and from the front to the point directly behind the listening position.

Change of positioning and acoustic image with 5.1-channel systems

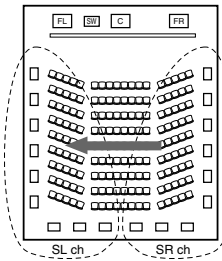

Movement of acoustic image from SR to SL

Change of positioning and acoustic image with 6.1-channel systems

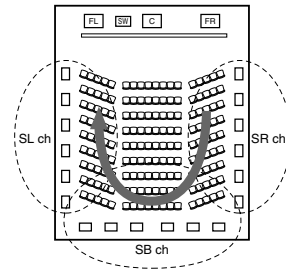

Movement of acoustic image from SR to SB to SL

With this set, speaker(s) for 1 or 2 channels are required to achieve a 6.1-channel system (DTS-ES, etc.). Adding these speakers, however, increases the surround effect not only with sources recorded in 6.1 channels but also with conventional 2- to 5.1-channel sources. The WIDE SCREEN mode is a mode for achieving surround sound with up to 7.1 channels using surround back speakers, for sources recorded in conventional Dolby Surround as well as Dolby Digital 5.1-channel and DTS Surround 5.1-channel sources. Furthermore, all the DENON original surround modes (see page 45) are compatible with 7.1-channel playback, so you can enjoy 7.1-channel sound with any signal source.

Number of surround back speakers

Though the surround back channel only consists of 1 channel of playback signals for 6.1-channel sources (DTS-ES, etc.), we recommend using two speakers. When using speakers with dipolar characteristics in particular, it is essential to use two speakers. Using two speakers results in a smoother blend with the sound of the surround channels and better sound positioning of the surround back channel when listening from a position other than the center.

Placement of the surround left and right channels when using surround back speakers

Using surround back speakers greatly improves the positioning of the sound at the rear. Because of this, the surround left and right channels play an important role in achieving a smooth transition of the acoustic image from the front to the back. As shown on the diagram above, in a movie theater the surround signals are also produced from diagonally in front of the listeners, creating an acoustic image as if the sound were floating in space. To achieve these effects, we recommend placing the speakers for the surround left and right channels slightly more towards the front than with conventional surround systems. Doing so sometimes increases the surround effect when playing conventional 5.1-channel sources in the 6.1 surround or DTS-ES Matrix 6.1 mode. Check the surround effects of the various modes before selecting the surround mode.

Speaker setting examples

Here we describe a number of speaker settings for different purposes. Use these examples as guides to set up your system according to the type of speakers used and the main usage purpose.

1. DTS-ES compatible system (using surround back speakers)

(1) Basic setting for primarily watching movies

This is recommended when mainly playing movies and using regular single way or 2-way speakers for the surround speakers.

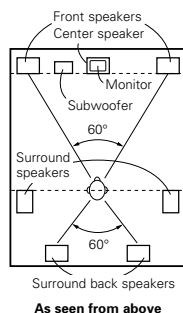

- Set the front speakers with their front surfaces as flush with the TV or monitor screen as possible. Set the center speaker between the front left and right speakers and no further from the listening position than the front speakers.
- Consult the owner's manual for your subwoofer for advice on placing the subwoofer within the listening room.
- If the surround speakers are direct-radiating (monopolar) then place them slightly behind and at an angle to the listening position and parallel to the walls at a position 60 to 90 centimeters (2 to 3 feet) above ear level at the prime listening position.
- When using two surround back speakers, place them at the back facing the front at a narrower distance than the front left and right speakers. When using one surround back speaker, place it at the rear center facing the front at a slightly higher position (0 to 20 cm) than the surround speakers.
- We recommend installing the surround back speaker(s) at a slightly downward facing angle. This effectively prevents the surround back channel signals from reflecting off the monitor or screen at the front center, resulting in interference and making the sense of movement from the front to the back less sharp.

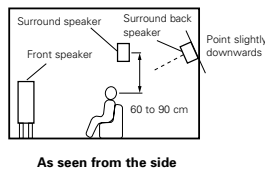

2. When not using surround back speakers

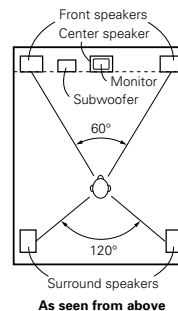

- Set the front speakers with their front surfaces as flush with the TV or monitor screen as possible. Set the center speaker between the front left and right speakers and no further from the listening position than the front speakers.
- Consult the owner's manual for your subwoofer for advice on placing the subwoofer within the listening room.
- If the surround speakers are direct-radiating (monopolar) then place them slightly behind and at an angle to the listening position and parallel to the walls at a position 60 to 90 centimeters (2 to 3 feet) above ear level at the prime listening position.

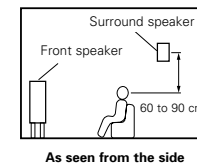

(2) Setting for primarily watching movies using diffusion type speakers for the surround speakers

For the greatest sense of surround sound envelopment, diffuse radiation speakers such as bipolar types, or dipolar types, provide a wider dispersion than is possible to obtain from a direct radiating speaker (monopolar). Place these speakers at either side of the prime listening position, mounted above ear level.

Path of the surround sound from the speakers to the listening position

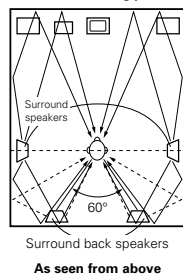

- Set the front speakers, center speaker and subwoofer in the same positions as in example (1).
- It is best to place the surround speakers directly at the side or slightly to the front of the viewing position, and 60 to 90 cm above the ears.
- Same as surround back speaker installation method (1). Using dipolar speakers for the surround back speakers as well is more effective.
- The signals from the surround channels reflect off the walls as shown on the diagram at the left, creating an enveloping and realistic surround sound presentation.

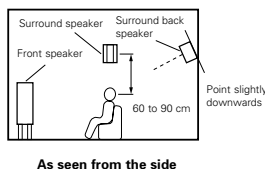

Surround

The AVR-2805 is equipped with a digital signal processing circuit that lets you play program sources in the surround mode to achieve the same sense of presence as in a movie theater.

Dolby Surround

(1) Dolby Digital

Dolby Digital is the multi-channel digital signal format developed by Dolby Laboratories. Dolby Digital consists of up to "5.1" channels - front left, front right, center, surround left, surround right, and an additional channel exclusively reserved for additional deep bass sound effects (the Low Frequency Effects – LFE – channel, also called the ".1" channel, containing bass frequencies of up to 120 Hz). Unlike the analog Dolby Pro Logic format, Dolby Digital's main channels can all contain full range sound information, from the lowest bass, up to the highest frequencies – 22 kHz. The signals within each channel are distinct from the others, allowing pinpoint sound imaging, and Dolby Digital offers tremendous dynamic range from the most powerful sound effects to the quietest, softest sounds, free from noise and distortion.

■ Dolby Digital and Dolby Pro Logic

Comparison of home surround systems	Dolby Digital	Dolby Pro Logic
No. recorded channels (elements)	5.1 ch	2 ch
No. playback channels	5.1 ch	4 ch
Playback channels (max.)	L, R, C, SL, SR, SW	L, R, C, S (SW - recommended)
Audio processing	Digital discrete processing Dolby Digital encoding/decoding	Analog matrix processing Dolby Surround
High frequency playback limit of surround channel	20 kHz	7 kHz

■ Dolby Digital compatible media and playback methods

Marks indicating Dolby Digital compatibility:  .

The following are general examples. Also refer to the player's operating instructions.

Media	Dolby Digital output jacks	Playback method (reference page)
LD (VDP)	Coaxial Dolby Digital RF output jack ※ 1	Set the input mode to "AUTO". (Page 34)
DVD	Optical or coaxial digital output (same as for PCM) ※ 2	Set the input mode to "AUTO". (Page 34)
Others (satellite broadcasts, CATV, etc.)	Optical or coaxial digital output (same as for PCM)	Set the input mode to "AUTO". (Page 34)

- ※ 1 Please use a commercially available adapter when connecting the Dolby Digital RF output jack of the LD player to the digital input jack.
Please refer to the instruction manual of the adapter when making connection.
- ※ 2 Some DVD digital outputs have the function of switching the Dolby Digital signal output method between "bit stream" and "(convert to) PCM". When playing in Dolby Digital surround on the AVR-2805, switch the DVD player's output mode to "bit stream". In some cases players are equipped with both "bit stream + PCM" and "PCM only" digital outputs. In this case connect the "bit stream + PCM" jacks to the AVR-2805.

(2) Dolby Pro Logic IIx

- Dolby Pro Logic IIx furthers the matrix decoding technology of Dolby Pro Logic II to decode audio signals recorded on two channels into up to 7.1 playback channels, including the surround back channel. Dolby Pro Logic IIx also allows 5.1-channel sources to be played in up to 7.1 channels.

The mode can be selected according to the source. The Music mode is best suited for playing music, the Cinema mode for playing movies, and the Game mode for playing games. The Game mode can only be used with 2-channel audio sources.

(3) Dolby Pro Logic II

- Dolby Pro Logic II is a new multi-channel playback format developed by Dolby Laboratories using feedback logic steering technology and offering improvements over conventional Dolby Pro Logic circuits.
- Dolby Pro Logic II can be used to decode not only sources recorded in Dolby Surround (※) but also regular stereo sources into five channels (front left, front right, center, surround left and surround right) to achieve surround sound.
- Whereas with conventional Dolby Pro Logic the surround channel playback frequency band was limited, Dolby Pro Logic II offers a wider band range (20 Hz to 20 kHz or greater). In addition, the surround channels were monaural (the surround left and right channels were the same) with previous Dolby Pro Logic, but Dolby Pro Logic II they are played as stereo signals.
- Various parameters can be set according to the type of source and the contents, so it is possible to achieve optimum decoding (see page 41).

※ Sources recorded in Dolby Surround
These are sources in which three or more channels of surround have been recorded as two channels of signals using Dolby Surround encoding technology. Dolby Surround is used for the sound tracks of movies recorded on DVDs, LDs and Video cassettes to be played on stereo VCRs, as well as for the stereo broadcast signals of FM radio, TV, satellite broadcasts and cable TV. Decoding these signals with Dolby Pro Logic II makes it possible to achieve multi-channel surround playback. The signals can also be played on ordinary stereo equipment, in which case they provide normal stereo sound.

There are two types of DVD Dolby surround recording signals.

- ① 2-channel PCM stereo signals
- ② 2-channel Dolby Digital signals

When either of these signals is input to the AVR-2805, the surround mode is automatically set to Dolby Pro Logic II when the "DOLBY/DTS SURROUND" mode is selected.

■ Sources recorded in Dolby Surround are indicated with the logo mark shown below.

Dolby Surround support mark: 

Manufactured under license from Dolby Laboratories. "Dolby", "Pro Logic" and the double-D symbol are trademarks of Dolby Laboratories.

DTS Digital Surround

Digital Theater Surround (also called simply DTS) is a multi-channel digital signal format developed by Digital Theater Systems.

DTS offers the same "5.1" playback channels as Dolby Digital (front left, front right and center, surround left and surround right) as well as the stereo 2-channel mode. The signals for the different channels are fully independent, eliminating the risk of deterioration of sound quality due to interference between signals, crosstalk, etc. DTS features a relatively higher bit rate as compared to Dolby Digital (1234 kbps for CDs and LDs, 1536 kbps for DVDs) so it operates with a relatively low compression rate. Because of this the amount of data is great, and when DTS playback is used in movie theaters, a separate CD-ROM synchronized with the film is played. With LDs and DVDs, there is of course no need for an extra disc; the pictures and sound can be recorded simultaneously on the same disc, so the discs can be handled in the same way as discs with other formats. There are also music CDs recorded in DTS. These CDs include 5.1-channel surround signals (compared to two channels on current CDs). They do not include picture data, but they offer surround playback on CD players that are equipped with digital outputs (PCM type digital output required).

DTS surround track playback offers the same intricate, grand sound as in a movie theater, right in your own listening room.

■ **DTS compatible media and playback methods**

Marks indicating DTS compatibility:  and .

The following are general examples. Also refer to the player's operating instructions.

Media	Dolby Digital output jacks	Playback method (reference page)
CD	Optical or coaxial digital output (same as for PCM) ※ 2	Set the input mode to "AUTO" or "DTS" (page 34). Never set the mode to "ANALOG" or "PCM". ※ 1
LD (VDP)	Optical or coaxial digital output (same as for PCM) ※ 2	Set the input mode to "AUTO" or "DTS" (page 34). Never set the mode to "ANALOG" or "PCM". ※ 1
DVD	Optical or coaxial digital output (same as for PCM) ※ 3	Set the input mode to "AUTO" or "DTS" (page 34).

- ※ 1 DTS signals are recorded in the same way on CDs and LDs as PCM signals. Because of this, the undecoded DTS signals are output as random "hissy" noise from the CD or LD player's analog outputs. If this noise is played with the amplifier set at a very high volume, it may possibly cause damage to the speakers. To avoid this, be sure to switch the input mode to "AUTO" or "DTS" before playing CDs or LDs recorded in DTS. Also, never switch the input mode to "ANALOG" or "PCM" during playback. The same holds true when playing CDs or LDs on a DVD player or LD/DVD compatible player. For DVDs, the DTS signals are recorded in a special way so this problem does not occur.
- ※ 2 The signals provided at the digital outputs of a CD or LD player may undergo some sort of internal signal processing (output level adjustment, sampling frequency conversion, etc.). In this case the DTS-encoded signals may be processed erroneously, in which case they cannot be decoded by the AVR-2805, or may only produce noise. Before playing DTS signals for the first time, turn down the master volume to a low level, start playing the DTS disc, then check whether the DTS indicator on the AVR-2805 (see page 35) lights before turning up the master volume.
- ※ 3 A DVD player with DTS-compatible digital output is required to play DTS DVDs. A DTS Digital Output logo is featured on the front panel of compatible DVD players. Recent DENON DVD player models feature DTS-compatible digital output – consult the player's owner's manual for information on configuring the digital output for DTS playback of DTS-encoded DVDs.

MANUFACTURED UNDER LICENSE FROM DIGITAL THEATER SYSTEMS, INC.
 U.S. PAT. NO'S. 5,451,942; 5,956,674; 5,974,380; 5,978,762; 6,226,616; 6,487,535 AND OTHER U.S. AND
 WORLD-WIDE PATENTS ISSUED AND PENDING.
 "DTS", "DTS-ES", "Neo:6", AND "DTS 96/24" ARE TRADEMARKS OF DIGITAL THEATER SYSTEMS, INC.
 © 1996, 2003 DIGITAL THEATER SYSTEMS, INC. ALL RIGHTS RESERVED.

DTS-ES Extended Surround™

DTS-ES Extended Surround is a new multi-channel digital signal format developed by Digital Theater Systems Inc. While offering high compatibility with the conventional DTS Digital Surround format, DTS-ES Extended Surround greatly improves the 360-degree surround impression and space expression thanks to further expanded surround signals. This format has been used professionally in movie theaters since 1999.

In addition to the 5.1 surround channels (FL, FR, C, SL, SR and LFE), DTS-ES Extended Surround also offers the SB (Surround Back, sometimes also referred to as "surround center") channel for surround playback with a total of 6.1 channels. DTS-ES Extended Surround includes two signal formats with different surround signal recording methods, as described below.

■ **DTS-ES™ Discrete 6.1**

DTS-ES Discrete 6.1 is the newest recording format. With it, all 6.1 channels (including the SB channel) are recorded independently using a digital discrete system. The main feature of this format is that because the SL, SR and SB channels are fully independent, the sound can be designed with total freedom and it is possible to achieve a sense that the acoustic images are moving about freely among the background sounds surrounding the listener from 360 degrees.

Though maximum performance is achieved when sound tracks recorded with this system are played using a DTS-ES decoder, when played with a conventional DTS decoder the SB channel signals are automatically down-mixed to the SL and SR channels, so none of the signal components are lost.

■ **DTS-ES™ Matrix 6.1**

With this format, the additional SB channel signals undergo matrix encoding and are input to the SL and SR channels beforehand. Upon playback they are decoded to the SL, SR and SB channels. The performance of the encoder used at the time of recording can be fully matched using a high precision digital matrix decoder developed by DTS, thereby achieving surround sound more faithful to the producer's sound design aims than with conventional 5.1- or 6.1-channel systems.

In addition, the bit stream format is 100% compatible with conventional DTS signals, so the effect of the Matrix 6.1 format can be achieved even with 5.1-channel signal sources. Of course it is also possible to play DTS-ES Matrix 6.1 encoded sources with a DTS 5.1-channel decoder.

When DTS-ES Discrete 6.1 or Matrix 6.1 encoded sources are decoded with a DTS-ES decoder, the format is automatically detected upon decoding and the optimum playing mode is selected. However, some Matrix 6.1 sources may be detected as having a 5.1-channel format, so the DTS-ES Matrix 6.1 mode must be set manually to play these sources.

(For instructions on selecting the surround mode, see page 43.)

The DTS-ES decoder includes another function, the DTS Neo:6 surround mode for 6.1-channel playback of digital PCM and analog signal sources.

■ **DTS Neo:6™ surround**

This mode applies conventional 2-channel signals to the high precision digital matrix decoder used for DTS-ES Matrix 6.1 to achieve 6.1-channel surround playback. High precision input signal detection and matrix processing enable full band reproduction (frequency response of 20 Hz to 20 kHz or greater) for all 6.1 channels, and separation between the different channels is improved to the same level as that of a digital discrete system.

DTS Neo:6 surround includes two modes for selecting the optimum decoding for the signal source.

• **DTS Neo:6 Cinema**

This mode is optimum for playing movies. Decoding is performed with emphasis on separation performance to achieve the same atmosphere with 2-channel sources as with 6.1-channel sources.

This mode is effective for playing sources recorded in conventional surround formats as well, because the in-phase component is assigned mainly to the center channel (C) and the reversed phase component to the surround (SL, SR and SB channels).

• **DTS Neo:6 Music**

This mode is suited mainly for playing music. Changes in the sound quality are reduced by decoding with emphasis on the front channel signals (FL and FR), and a natural sense of expansion is given to the sound field by the effect of the surround signals output from the center (C) and surround (SL, SR and SB) channels.

DTS 96/24

The sampling frequency, number of bits and number of channels used for recording of music, etc., in studios has been increasing in recent years, and there are a growing number of high quality signal sources, including 96 kHz/24 bit 5.1-channel sources.

For example, there are high picture/sound quality DVD video sources with 96 kHz/24 bit stereo PCM audio tracks. However, because the data rate for these audio tracks is extremely high, there are limits to recording them on two channels only, and since the quality of the pictures must be restricted it is common to only include still pictures.

In addition, 96 kHz/24 bit 5.1-channel surround is possible with DVD audio sources, but DVD audio players are required to play them with this high quality.

DTS 96/24 is a multi-channel digital signal format developed by Digital Theater Systems Inc. in order to deal with this situation.

Conventional surround formats used sampling frequencies of 48 or 44.1 kHz, so 20 kHz was about the maximum playback signal frequency. With DTS 96/24, the sampling frequency is increased to 96 or 88.2 kHz to achieve a wide frequency range of over 40 kHz.

In addition, DTS 96/24 has a resolution of 24 bits, resulting in the same frequency band and dynamic range as 96 kHz/24 bit PCM.

As with conventional DTS Surround, DTS 96/24 is compatible with a maximum of 5.1 channels, so sources recorded using DTS 96/24 can be played in high sampling frequency, multiple channel audio with such normal media as DVD videos and CDs.

Thus, with DTS 96/24, the same 96 kHz/24 bit multi-channel surround sound as with DVD-Audio can be achieved while viewing DVD-Video images on a conventional DVD-Video player (*1). Furthermore, with DTS 96/24 compatible CDs, 88.2 kHz/24 bit multi-channel surround can be achieved using normal CD/LD players (*1).

Even with the high quality multi-channel signals, the recording time is the same as with conventional DTS surround sources.

What's more, DTS 96/24 is fully compatible with the conventional DTS surround format, so DTS 96/24 signal sources can be played with a sampling frequency of 48 kHz or 44.1 kHz on conventional DTS or DTS-ES surround decoders (*2).

- * 1 A DVD player with DTS digital output capabilities (for CD/LD players, a player with digital outputs for conventional DTS CDs/LDs) and a disc recorded in DTS 96/24 are required.
- * 2 The resolution is 24 or 20 bits, depending on the decoder.

AL24 Processing

Pure Direct Mode/AL24 Processing

The AVR-2805 is equipped with a pure direct mode allowing the effects of the video and digital circuitry to be shut down when playing CDs or records to achieve the ideal environment for analog playback, resulting in extremely high quality music playback. It is also equipped with AL24 processing which compensates the input digital data to produce the near analog waveforms which would be in a nature with 24 bits quality. AL24 processing operates when PCM data such as CD is inputted.

System setup items and default values (set upon shipment from the factory)

1. Auto Setup/Room EQ

Auto Setup/Room EQ			Default settings
1	Auto Setup	Power Amp Assignment Set this to switch the surround back channel's power amplifier for use for zone2.	SURROUND BACK
2	Manual EQ Setup	This parameter is for optimizing the Room EQ with which the audio signals are produced from the speakers.	All Channel and Frequency=0 dB
3	Room EQ Setup	Set the Room EQ setting with All or Assign for each surround mode.	All
4	Direct Mode Setup	Set the ON/OFF setting of Room EQ, in the case of the surround mode is in Direct or Pure Direct.	OFF
5	Mic Input Select	Set this to switch the Mic Input jack for use for Mic or V.Aux L-channel input jack.	Mic

2. Speaker Setup

Speaker Setup			Default settings							
1	Speaker Configuration	Input the combination of speakers in your system and their corresponding sizes (SMALL for regular speakers, LARGE for full-size, full-range) to automatically set the composition of the signals output from the speakers and the frequency response.	Front Sp.	Center Sp.	Subwoofer	Surround Sp.	Surround Back Sp.			
			Large	Small	Yes	Small	Small / 2spkrs			
2	Delay Time	This parameter is for optimizing the timing with which the audio signals are produced from the speakers and subwoofer according to the listening position.	Front L & R	Center	Subwoofer	Surround L & R	SBL & SBR			
			3.6 m (12 ft)	3.6 m (12 ft)	3.6 m (12 ft)	3.0 m (10 ft)	3.0 m (10 ft)			
3	Channel Level	This adjusts the volume of the signals output from the speakers and subwoofer for the different channels in order to obtain optimum effects.	Front L	Front R	Center	Surround L	Surround R	Surround Back L	Surround Back R	Subwoofer
			0 dB	0 dB	0 dB	0 dB	0 dB	0 dB	0 dB	0 dB
4	Crossover Frequency	Set the frequency (Hz) below which the bass so of the various speaker is to be output from the subwoofer.	80Hz							
5	Subwoofer Mode	This selects the subwoofer speaker for playing deep bass signals.	LFE							

3. Input Setup

Input Setup			Default settings									
1	Digital In Assignment	This assigns the digital input jacks for the different input sources.	Input source	CD	DVD	VDP	TV	DBS	V. AUX	VCR-1	VCR-2	CDR/TAPE
			Digital Inputs	COAX1	COAX2	OPT1	OFF	OPT2	OPT5	OPT3	OFF	OPT4
2	Ext. In Subwoofer Level	Set the Ext. In Subwoofer terminal playback level.	Subwoofer = +15 dB									
3	Component In Assign	This assigns the color difference (component) video input jacks for the different input sources.	DVD	VDP	TV	DBS	VCR-1	VCR-2	V. AUX	—	—	
			VIDEO 1	NONE	VIDEO 2	VIDEO 3	NONE	NONE	NONE	—	—	
4	Video Input Mode	Set the input signal to be output from the monitor output terminal.	AUTO									
5	Auto Tuner Presets	FM stations are received automatically and stored in the memory.	A1 ~ A8	87.5/89.1/98.1/108.0/90.1/90.1/90.1/90.1 MHz								
			B1 ~ B8	522/603/999/1404/1611 kHz, 90.1/90.1/90.1 MHz								
			C1 ~ C8	90.1 MHz								
			D1 ~ D8	90.1 MHz								
			E1 ~ E8	90.1 MHz								
			F1 ~ F8	90.1 MHz								
			G1 ~ G8	90.1 MHz								

4. Advanced Playback

Advanced Playback			Default settings									
1	Audio Delay	Set the audio delay to delay time the sound and synchronize it with the picture.	0 ms									
2	Dolby Digital Setup	Turn the audio compression on or off when down-mixing Dolby Digital signals.	OFF									
3	Auto Surround Mode	Set the Auto surround mode function.	Auto Surround Mode = ON									

5. Option Setup

Option Setup			Default settings										
1	Power AMP Assignment	Set this to switch the surround back channel's power amplifier for use for zone2.	Surround Back										
2	Zone2 vol. Level	This sets the output level the zone2 output jacks. This menu is not displayed, when "ZONE2" is selected at Option Setup "Power Amp Assign".	Variable										
3	Trigger Out1 Setup	Set the Trigger Out1 output for the each input sources.	ZONE=MAIN										
			PHONO	CD	TUNER	CDR/TAPE	DVD	VDP	TV	DBS	VCR-1	VCR-2	V. AUX
			OFF	OFF	OFF	OFF	ON	ON	ON	ON	ON	ON	ON
4	Trigger Out2 Setup	Set the Trigger Out2 output for the each input sources.	ZONE=2										
			PHONO	CD	TUNER	CDR/TAPE	DVD	VDP	TV	DBS	VCR-1	VCR-2	V. AUX
			ON	ON	ON	ON	ON	ON	ON	ON	ON	ON	ON
5	Muting Level	This sets the amount of attenuation at audio output muting.	—dB (minimum)										
6	On Screen Display	This sets whether or not to display the on-screen display that appears on the monitor screen when the controls on the remote control unit or main unit are operated. A setting to prevent flickering.	On Screen Display = ON / Mode 1										
7	Setup Lock	Set whether or not to lock the system setup settings so that they cannot be changed.	Setup Lock = OFF										

Surround modes and parameters

■ Surround modes and parameters

Mode	Signals and adjustability in the different modes								
	Channel output					When playing Dolby Digital signals	When playing DTS signals	When playing PCM signals	When playing ANALOG signals
	FRONT L/R	CENTER	SURROUND L/R	SURROUND BACK L/R	SUB-WOOFER				
DIRECT / PURE DIRECT	○	×	×	×	⊗	○	○	○	○
STEREO	○	×	×	×	⊗	○	○	○	○
EXTERNAL INPUT	○	⊗	⊗	⊗	⊗	×	×	×	○
DOLBY PRO LOGIC II	○	⊗	⊗	⊗	⊗	○*	○*	○	○
DOLBY PRO LOGIC II x	○	⊗	⊗	⊗	⊗	○*	○*	○	○
DTS NEO:6	○	⊗	⊗	⊗	⊗	○*	○*	○	○
DOLBY DIGITAL SURROUND	○	⊗	⊗	⊗	⊗	○	×	×	×
DTS SURROUND	○	⊗	⊗	⊗	⊗	×	○	×	×
5/7CH STEREO	○	⊗	⊗	⊗	⊗	○	○	○	○
WIDE SCREEN	○	⊗	⊗	⊗	⊗	○	○	○	○
SUPER STADIUM	○	⊗	⊗	⊗	⊗	○	○	○	○
ROCK ARENA	○	⊗	⊗	⊗	⊗	○	○	○	○
JAZZ CLUB	○	⊗	⊗	⊗	⊗	○	○	○	○
CLASSIC CONCERT	○	⊗	⊗	⊗	⊗	○	○	○	○
MONO MOVIE	○	⊗	⊗	⊗	⊗	○	○	○	○
VIDEO GAME	○	⊗	⊗	⊗	⊗	○	○	○	○
MATRIX	○	⊗	⊗	⊗	⊗	○	○	○	○
VIRTUAL	○	×	×	×	⊗	○	○	○	○

○ : Signal / Adjustable
 × : No signal
 ⊗ : Turned on or off by speaker configuration setting

○ : Able
 × : Unable
 * : Only for 2 ch contents

Mode	Signals and adjustability in the different modes							
	Parameter (default values are shown in parentheses)							
	When playing Dolby Digital and DTS signals			SB CH OUT (MODE)	ROOM EQ	TONE CONTROL	CINEMA EQ.	MODE
	D. COMP	LFE	AFDM					
DIRECT / PURE DIRECT	○ (OFF)	○ (0dB)	×	×	○ (OFF)	×	×	×
STEREO	○ (OFF)	○ (0dB)	×	×	○ (OFF)	○ (0dB)	×	×
EXTERNAL INPUT	×	×	×	×	×	×	×	×
DOLBY PRO LOGIC II	○ (OFF)	×	×	○	○ (OFF)	○ (0dB)	○ (OFF)	○
DOLBY PRO LOGIC II x	○ (OFF)	×	×	○	○ (OFF)	○ (0dB)	○ (OFF)	○
DTS NEO:6	○ (OFF)	×	×	○	○ (OFF)	○ (0dB)	○ (OFF)	○
DOLBY DIGITAL SURROUND	○ (OFF)	○ (0dB)	○	○	○ (OFF)	○ (0dB)	○ (OFF)	×
DTS SURROUND	○ (OFF)	○ (0dB)	○	○	○ (OFF)	○ (0dB)	○ (OFF)	×
5/7CH STEREO	○ (OFF)	○ (0dB)	×	○	○ (OFF)	○ (0dB)	×	×
WIDE SCREEN	○ (OFF)	○ (0dB)	×	○	○ (OFF)	○ (0dB)	○ (OFF)	×
SUPER STADIUM	○ (OFF)	○ (0dB)	×	○	○ (OFF)	○ (Note1)	×	×
ROCK ARENA	○ (OFF)	○ (0dB)	×	○	○ (OFF)	○ (Note2)	×	×
JAZZ CLUB	○ (OFF)	○ (0dB)	×	○	○ (OFF)	○ (0dB)	×	×
CLASSIC CONCERT	○ (OFF)	○ (0dB)	×	○	○ (OFF)	○ (0dB)	×	×
MONO MOVIE	○ (OFF)	○ (0dB)	×	○	○ (OFF)	○ (0dB)	×	×
VIDEO GAME	○ (OFF)	○ (0dB)	×	○	○ (OFF)	○ (0dB)	×	×
MATRIX	○ (OFF)	○ (0dB)	×	○	○ (OFF)	○ (0dB)	×	×
VIRTUAL	○ (OFF)	○ (0dB)	×	×	○ (OFF)	○ (0dB)	×	×

○ : Able
 × : Unable

○ : Adjustable
 × : Not adjustable
 Note1 : BASS +6 dB, TREBLE 0 dB
 Note2 : BASS +6 dB, TREBLE +4 dB

Mode	Signals and adjustability in the different modes									
	SURROUND PARAMETER									
	ROOM SIZE	EFFECT ON/OFF	EFFECT LEVEL	DELAY TIME	SUBWOOFER ON/OFF	PRO LOGIC II / II x ONLY			NEO:6 MUSIC	EXT.IN
PANORAMA						DIMENSION	CENTER WIDTH			
DIRECT / PURE DIRECT	×	×	×	×	○ (OFF)	×	×	×	×	×
STEREO	×	×	×	×	×	×	×	×	×	×
EXTERNAL INPUT	×	×	×	×	×	×	×	×	×	○
DOLBY PRO LOGIC II	×	×	×	×	×	○ (OFF)	○ (3)	○ (3)	×	×
DOLBY PRO LOGIC II x	×	×	×	×	×	○ (OFF)	○ (3)	○ (3)	×	×
DTS NEO:6	×	×	×	×	×	×	×	×	○ (0,3)	×
DOLBY DIGITAL SURROUND	×	×	×	×	×	×	×	×	×	×
DTS SURROUND	×	×	×	×	×	×	×	×	×	×
5/7CH STEREO	×	×	×	×	×	×	×	×	×	×
WIDE SCREEN	×	○ (ON)	○ (10)	×	×	×	×	×	×	×
SUPER STADIUM	○ (Medium)	×	○ (10)	×	×	×	×	×	×	×
ROCK ARENA	○ (Medium)	×	○ (10)	×	×	×	×	×	×	×
JAZZ CLUB	○ (Medium)	×	○ (10)	×	×	×	×	×	×	×
CLASSIC CONCERT	○ (Medium)	×	○ (10)	×	×	×	×	×	×	×
MONO MOVIE	○ (Medium)	×	○ (10)	×	×	×	×	×	×	×
VIDEO GAME	○ (Medium)	×	○ (10)	×	×	×	×	×	×	×
MATRIX	×	×	×	○ (30ms)	×	×	×	×	×	×
VIRTUAL	×	×	×	×	×	×	×	×	×	×

○ : Adjustable
 × : Not adjustable

■ Differences in surround mode names depending on the input signals

Surround Mode	Input signals						
	ANALOG	LINEAR PCM	DTS			DOLBY DIGITAL	
			DTS (5.1 ch)	DTS 96/24(5.1 ch)	DTS (6.1 ch)	D. D. (2 ch)	D. D. (5.1 ch)
PURE DIRECT, DIRECT	○	○	○	○	○	○	○
STEREO	○	○	○	○	○	○	○
DTS SURROUND	DTS NEO:6	DTS NEO:6	*DTS ES MTRX DTS SURROUND DTS+PLIix (Cinema,Music)	*DTS ES MTRX DTS 96/24 DTS+PLIix (Cinema,Music)	© ES DSCRT6.1 ES MTRX6.1 *DTS SURROUND DTS+PLIix (Cinema,Music)	DTS NEO:6	×
DOLBY DIGITAL	*DOLBY PRO LOGIC II DOLBY PRO LOGIC IIx (Cinema,Music, Game)	*DOLBY PRO LOGIC II DOLBY PRO LOGIC IIx (Cinema,Music, Game)	×	×	×	*DOLBY PRO LOGIC II DOLBY PRO LOGIC IIx (Cinema,Music, Game)	*DOLBY DIGITAL EX DOLBY DIGITAL DOLBY DIGITAL +PL Iix (Cinema,Music)
DSP SIMULATION	○	○	○	○	○	○	○

○ : Selectable
 * : The surround mode name differs depending on the "SB CH OUT" surround parameter setting.
 © : The surround mode name differs depending on the input signal.
 × : Not selectable

Relationship between the video input signal and monitor output according to the VIDEO INPUT MODE settings

VIDEO INPUT Mode	Input signals			MONITOR OUT		
	COMPONENT	S-VIDEO	VIDEO	COMPONENT	S-VIDEO	VIDEO
AUTO	×	×	○	VIDEO	VIDEO	VIDEO
	×	○	×	S-VIDEO	S-VIDEO	S-VIDEO
	×	○	○	S-VIDEO	S-VIDEO	VIDEO *3
	○	×	×	COMPONENT	×	×
	○	×	○	COMPONENT #1	VIDEO	VIDEO
	○	○	×	COMPONENT #2	S-VIDEO	S-VIDEO
	○	○	○	COMPONENT #2	S-VIDEO	VIDEO *3

VIDEO INPUT Mode	Input signals			MONITOR OUT		
	COMPONENT	S-VIDEO	VIDEO	COMPONENT	S-VIDEO	VIDEO
COMPONENT	×	×	○	×	×	×
	×	○	×	×	×	×
	×	○	○	×	×	×
	○	×	×	COMPONENT	×	×
	○	×	○	COMPONENT	×	×
	○	○	×	COMPONENT	×	×
	○	○	○	COMPONENT	×	×

VIDEO INPUT Mode	Input signals			MONITOR OUT		
	COMPONENT	S-VIDEO	VIDEO	COMPONENT	S-VIDEO	VIDEO
S-VIDEO	×	×	○	×	×	×
	×	○	×	S-VIDEO	S-VIDEO	S-VIDEO
	×	○	○	S-VIDEO	S-VIDEO	S-VIDEO
	○	×	×	×	×	×
	○	×	○	×	×	×
	○	○	×	S-VIDEO	S-VIDEO	S-VIDEO
	○	○	○	S-VIDEO	S-VIDEO	S-VIDEO

VIDEO INPUT Mode	Input signals			MONITOR OUT		
	COMPONENT	S-VIDEO	VIDEO	COMPONENT	S-VIDEO	VIDEO
VIDEO	×	×	○	VIDEO	VIDEO	VIDEO
	×	○	×	×	×	×
	×	○	○	VIDEO	VIDEO	VIDEO
	○	×	×	×	×	×
	○	×	○	VIDEO	VIDEO	VIDEO
	○	○	×	×	×	×
	○	○	○	VIDEO	VIDEO	VIDEO

○ : Signal input
 × : No signal
 × : Not output
 COMPONENT : On-screen display only displayed for SYSTEM SETUP, SURR.PARA and ON SCREEN buttons
 #1 : On-screen display superimposed on video signal and output
 #2 : On-screen display superimposed on S-video signal and output
 #3 : The on-screen display is not displayed when a cable is connected to the S-VIDEO monitor output terminal.

18 SPECIFICATIONS

- Audio section**
 - Power amplifier**
 - Rated output:**

Front:	100 W + 100 W	(8 Ω/ohms, 20 Hz ~ 20 kHz with 0.05% T.H.D.)
	135 W + 135 W	(6 Ω/ohms, 1 kHz with 0.7% T.H.D.)
Center:	100 W	(8 Ω/ohms, 20 Hz ~ 20 kHz with 0.05% T.H.D.)
	135 W	(6 Ω/ohms, 1 kHz with 0.7% T.H.D.)
Surround:	100 W + 100 W	(8 Ω/ohms, 20 Hz ~ 20 kHz with 0.05% T.H.D.)
	135 W + 135 W	(6 Ω/ohms, 1 kHz with 0.7% T.H.D.)
Surround back:	100 W + 100 W	(8 Ω/ohms, 20 Hz ~ 20 kHz with 0.05% T.H.D.)
	135 W + 135 W	(6 Ω/ohms, 1 kHz with 0.7% T.H.D.)
 - Dynamic power:**

120 W x 2 ch	(8 Ω/ohms)
170 W x 2 ch	(4 Ω/ohms)
200 W x 2 ch	(2 Ω/ohms)
 - Output terminals:**

Front	A or B: 6 ~ 16 Ω/ohms
	A + B: 8 ~ 16 Ω/ohms
Center, Surround, Surr. Back / Zone2:	6 ~ 16 Ω/ohms
 - Analog**
 - Input sensitivity / input impedance:** 200 mV / 47 kΩ/kohms
 - Frequency response:** 10 Hz ~ 100 kHz: +0, -3 dB (DIRECT mode)
 - S/N:** 102 dB (DIRECT mode)
 - Distortion:** 0.005% (20 Hz ~ 20 kHz) (DIRECT mode)
 - Rated output:** 1.2 V
 - Digital**
 - D/A output:**

Rated output	— 2 V (at 0 dB playback)
Total harmonic distortion	— 0.008% (1 kHz, at 0 dB)
S/N ratio	— 102 dB
Dynamic range	— 96 dB
Format	— Digital audio interface
 - Digital input:**
 - Phono equalizer (PHONO input — REC OUT)**
 - Input sensitivity:** 2.5 mV
 - RIAA deviation:** ±1 dB (20 Hz to 20 kHz)
 - Signal-to-noise ratio:** 74 dB (A weighting, with 5 mV input)
 - Rated output / Maximum output:** 150 mV / 8 V
 - Distortion factor:** 0.03% (1 kHz, 3 V)
- Video section**
 - Standard video jacks**
 - Input / output level and impedance:** 1 Vp-p, 75 Ω/ohms
 - Frequency response:** 5 Hz ~ 10 MHz — +0, -3 dB
 - S-video jacks**
 - Input / output level and impedance:**

Y (brightness) signal	— 1 Vp-p, 75 Ω/ohms
C (color) signal	— 0.286 Vp-p, 75 Ω/ohms
 - Frequency response:** 5 Hz ~ 10 MHz — +0, -3 dB
 - Color component video terminal**
 - Input / output level and impedance:**

Y (brightness) signal	— 1 Vp-p, 75 Ω/ohms
Pb/Cb signal	— 0.7 Vp-p, 75 Ω/ohms
Pr/Cr signal	— 0.7 Vp-p, 75 Ω/ohms
 - Frequency response:** DC ~ 100 MHz — +0, -3 dB
- Tuner section**

	[FM] (note: μV at 75 Ω/ohms, 0 dBf=1 x 10 ⁻¹⁵ W)	[AM]
Receiving Range:	87.50 MHz ~ 108.0 MHz	522 kHz ~ 1611 kHz
Usable Sensitivity:	1.0 μV (11.2 dBf)	18 μV
50 dB Quieting Sensitivity:	MONO 1.6 μV (15.3 dBf)	
	STEREO 23 μV (38.5 dBf)	
S/N (IHF-A):	MONO 77 dB	
	STEREO 72 dB	
Total Harmonic Distortion (at 1 kHz):	MONO 0.15%	
	STEREO 0.3%	
- General**
 - Power supply:** AC 230 V, 50 Hz
 - Power consumption:** 290 W
1 W Max (Standby)
 - Maximum external dimensions:** 434 (W) x 171 (H) x 429 (D) mm
 - Mass:** 13.5 kg
- Remote control unit (RC-975)**
 - Batteries:** R6P/AA Type (three batteries)
 - External dimensions:** 58 (W) x 230 (H) x 37 (D) mm
 - Mass:** 230 g (including batteries)

* For purposes of improvement, specifications and design are subject to change without notice.

DENON, Ltd.

16-11, YUSHIMA 3-CHOME, BUNKYO-KU, TOKYO 113-0034, JAPAN
Telephone: (03) 3837-5321

Printed in Japan 511 4212 006

Free Manuals Download Website

<http://myh66.com>

<http://usermanuals.us>

<http://www.somanuals.com>

<http://www.4manuals.cc>

<http://www.manual-lib.com>

<http://www.404manual.com>

<http://www.luxmanual.com>

<http://aubethermostatmanual.com>

Golf course search by state

<http://golfingnear.com>

Email search by domain

<http://emailbydomain.com>

Auto manuals search

<http://auto.somanuals.com>

TV manuals search

<http://tv.somanuals.com>