

DENON *PROFESSIONAL*

DVD VIDEO PLAYER

DN-V210/DN-V310

USER GUIDE

MODE D'EMPLOI

GUÍA DEL USUARIO

IMPORTANT TO SAFETY

WARNING:

To reduce the risk of fire and electric shock, this apparatus should not be exposed to rain or moisture and objects filled with liquids, such as vases, should not be placed on this apparatus

CAUTION

1. Handle the power supply cord carefully

Do not damage or deform the power supply cord. If it is damaged or deformed, it may cause electric shock or malfunction when used. When removing from wall outlet, be sure to remove by holding the plug attachment and not by pulling the cord.

2. Do not open the rear cover

In order to prevent electric shock, do not open the top cover.

If problems occur, contact your DENON DEALER.

3. Do not place anything inside

Do not place metal objects or spill liquid inside the system.

Electric shock or malfunction may result.

Please, record and retain the Model name and serial number of your set shown on the rating label.

Model No. DN-V210/DN-V310

Serial No. _____



CAUTION
RISK OF ELECTRIC SHOCK
DO NOT OPEN



CAUTION:

TO REDUCE THE RISK OF ELECTRIC SHOCK, DO NOT REMOVE COVER (OR BACK). NO USER-SERVICEABLE PARTS INSIDE. REFER SERVICING TO QUALIFIED SERVICE PERSONNEL.



The lightning flash with arrowhead symbol, within an equilateral triangle, is intended to alert the user to the presence of uninsulated "dangerous voltage" within the product's enclosure that may be of sufficient magnitude to constitute a risk of electric shock to persons.



The exclamation point within an equilateral triangle is intended to alert the user to the presence of important operating and maintenance (servicing) instructions in the literature accompanying the appliance.

NOTE:

This DVD Video Player uses the semiconductor laser. To allow you to enjoy music at a stable operation, it is recommended to use this in a room of 5°C (41°F) ~ 35°C (95°F).

LABELS (for U.S.A. model only)

CERTIFICATION

THIS PRODUCT COMPLIES WITH DHHS RULES 21 CFR SUBCHAPTER J APPLICABLE AT DATE OF MANUFACTURE.

CAUTION:

USE OF CONTROLS OR ADJUSTMENTS OR REFORMATION OF PROCEDURES OTHER THAN THOSE SPECIFIED HEREIN MAY RESULT IN HAZARDOUS RADIATION EXPOSURE.

THE COMPACT DISC PLAYER SHOULD NOT BE ADJUSTED OR REPAIRED BY ANYONE EXCEPT PROPERLY QUALIFIED SERVICE PERSONNEL.

FCC INFORMATION (For US customers)

1. PRODUCT

This product complies with Part 15 of the FCC Rules. Operation is subject to the following two conditions: (1) this product may not cause harmful interference, and (2) this product must accept any interference received, including interference that may cause undesired operation.

2. IMPORTANT NOTICE:

DO NOT MODIFY THIS PRODUCT

This product, when installed as indicated in the instructions contained in this manual, meets FCC requirements. Modification not expressly approved by DENON may void your authority, granted by the FCC, to use the product.

3. NOTE

This product has been tested and found to comply with the limits for a Class B digital device, pursuant to Part 15 of the FCC Rules. These limits are designed to provide reasonable protection against harmful interference in a residential installation.

This product generates, uses and can radiate radio frequency energy and, if not installed and used in accordance with the instructions, may cause harmful interference to radio communications. However, there is no guarantee that interference will not occur in a particular installation. If this product does cause harmful interference to radio or television reception, which can be determined by turning the product OFF and ON, the user is encouraged to try to correct the interference by one or more of the following measures:

- Reorient or relocate the receiving antenna.
- Increase the separation between the equipment and receiver.
- Connect the product into an outlet on a circuit different from that to which the receiver is connected.
- Consult the local retailer authorized to distribute this type of product or an experienced radio/TV technician for help.

This Class B apparatus complies with Canadian ICES-003. Cet appareil numérique de la classe B est conforme à la norme NMB-003 du Canada.

SAFETY INSTRUCTIONS

1. Read Instructions – All the safety and operating instructions should be read before the product is operated.
2. Retain Instructions – The safety and operating instructions should be retained for future reference.
3. Heed Warnings – All warnings on the product and in the operating instructions should be adhered to.
4. Follow Instructions – All operating and use instructions should be followed.
5. Cleaning – Unplug this product from the wall outlet before cleaning. Do not use liquid cleaners or aerosol cleaners.
6. Attachments – Do not use attachments not recommended by the product manufacturer as they may cause hazards.
7. Water and Moisture – Do not use this product near water – for example, near a bath tub, wash bowl, kitchen sink, or laundry tub; in a wet basement; or near a swimming pool; and the like.
8. Accessories – Do not place this product on an unstable cart, stand, tripod, bracket, or table. The product may fall, causing serious injury to a child or adult, and serious damage to the product. Use only with a cart, stand, tripod, bracket, or table recommended by the manufacturer, or sold with the product. Any mounting of the product should follow the manufacturer's instructions, and should use a mounting accessory recommended by the manufacturer.
9. A product and cart combination should be moved with care. Quick stops, excessive force, and uneven surfaces may cause the product and cart combination to overturn.
10. Ventilation – Slots and openings in the cabinet are provided for ventilation and to ensure reliable operation of the product and to protect it from overheating, and these openings must not be blocked or covered. The openings should never be blocked by placing the product on a bed, sofa, rug, or other similar surface. This product should not be placed in a built-in installation such as a bookcase or rack unless proper ventilation is provided or the manufacturer's instructions have been adhered to.
11. Power Sources – This product should be operated only from the type of power source indicated on the marking label. If you are not sure of the type of power supply to your home, consult your product dealer or local power company. For products intended to operate from battery power, or other sources, refer to the operating instructions.
12. Grounding or Polarization – This product may be equipped with a polarized alternating-current line plug (a plug having one blade wider than the other). This plug will fit into the power outlet only one way. This is a safety feature. If you are unable to insert the plug fully into the outlet, try reversing the plug. If the plug should still fail to fit, contact your electrician to replace your obsolete outlet. Do not defeat the safety purpose of the polarized plug.

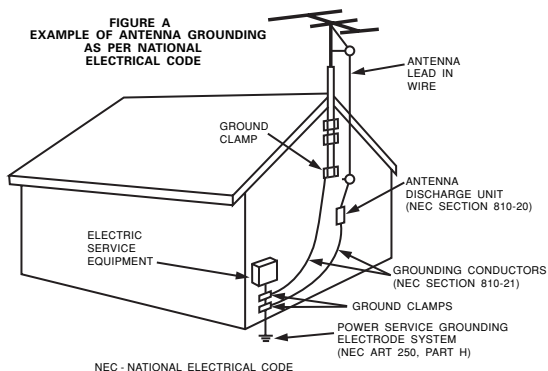

13. Power-Cord Protection – Power-supply cords should be routed so that they are not likely to be walked on or pinched by items placed upon or against them, paying particular attention to cords at plugs, convenience receptacles, and the point where they exit from the product.
15. Outdoor Antenna Grounding – If an outside antenna or cable system is connected to the product, be sure the antenna or cable system is grounded so as to provide some protection against voltage surges and built-up static charges. Article 810 of the National Electrical Code, ANSI/NFPA 70, provides information with regard to proper grounding of the mast and supporting structure, grounding of the lead-in wire to an antenna discharge unit, size of grounding conductors, location of antenna-discharge unit, connection to grounding electrodes, and requirements for the grounding electrode. See Figure A.
16. Lightning – For added protection for this product during a lightning storm, or when it is left unattended and unused for long periods of time, unplug it from the wall outlet and disconnect the antenna or cable system. This will prevent damage to the product due to lightning and power-line surges.
17. Power Lines – An outside antenna system should not be located in the vicinity of overhead power lines or other electric light or power circuits, or where it can fall into such power lines or circuits. When installing an outside antenna system, extreme care should be taken to keep from touching such power lines or circuits as contact with them might be fatal.
18. Overloading – Do not overload wall outlets, extension cords, or integral convenience receptacles as this can result in a risk of fire or electric shock.
19. Object and Liquid Entry – Never push objects of any kind into this product through openings as they may touch dangerous voltage points or short-out parts that could result in a fire or electric shock. Never spill liquid of any kind on the product.
20. Servicing – Do not attempt to service this product yourself as opening or removing covers may expose you to dangerous voltage or other hazards. Refer all servicing to qualified service personnel.
21. Damage Requiring Service – Unplug this product from the wall outlet and refer servicing to qualified service personnel under the following conditions:
 - a) When the power-supply cord or plug is damaged,
 - b) If liquid has been spilled, or objects have fallen into the product,
 - c) If the product has been exposed to rain or water,
 - d) If the product does not operate normally by following the operating instructions. Adjust only those controls that are covered by the operating instructions as an improper adjustment of other controls may result in damage and will often require extensive work by a qualified technician to restore the product to its normal operation,
 - e) If the product has been dropped or damaged in any way, and
 - f) When the product exhibits a distinct change in performance – this indicates a need for service.
22. Replacement Parts – When replacement parts are required, be sure the service technician has used replacement parts specified by the manufacturer or have the same characteristics as the original part. Unauthorized substitutions may result in fire, electric shock, or other hazards.
23. Safety Check – Upon completion of any service or repairs to this product, ask the service technician to perform safety checks to determine that the product is in proper operating condition.
24. Wall or Ceiling Mounting – The product should be mounted to a wall or ceiling only as recommended by the manufacturer.
25. Heat – The product should be situated away from heat sources such as radiators, heat registers, stoves, or other products (including amplifiers) that produce heat.

CAUTION: (English)
To completely disconnect this product from the mains, disconnect the plug from the wall socket outlet. The mains plug is used to completely interrupt the power supply to the unit and must be within easy access by the user.

VORSICHT: (Deutsch)
Um dieses Gerät vollständig von der Stromversorgung abzutrennen, trennen Sie bitte den Netzstecker von der Wandsteckdose ab. Die Hauptstecker werden verwendet, um die Stromversorgung zum Gerät völlig zu unterbrechen; er muss für den Benutzer gut und einfach zu erreichen sein.

PRECAUTION: (Français)
Pour déconnecter complètement ce produit du courant secteur, débranchez la prise de la prise murale. La prise secteur est utilisée pour couper complètement l'alimentation de l'appareil et l'utilisateur doit pouvoir y accéder facilement.

ATTENZIONE: (Italiano)
Per scollegare definitivamente questo prodotto dalla rete di alimentazione elettrica, togliere la spina dalla relativa presa. La spina di rete viene utilizzata per interrompere completamente l'alimentazione all'unità e deve essere facilmente accessibile all'utente.

PRECAUCIÓN: (Español)
Para desconectar completamente este producto de la alimentación eléctrica, desconecte el enchufe del enchufe de la pared. El enchufe de la alimentación se utiliza para interrumpir por completo el suministro de alimentación a la unidad y debe de encontrarse en un lugar al que el usuario tenga fácil acceso.

VOORZICHTIGHEID: (Nederlands)
Om de voeding van dit product volledig te onderbreken moet de stekker uit het stopcontact worden getrokken. De netstekker wordt gebruikt om de stroomtoevoer naar het toestel volledig te onderbreken en moet voor de gebruiker gemakkelijk bereikbaar zijn.

FÖRSIKTIHETSMÅTT: (Svenska)
Koppla loss stickproppen från eluttaget för att helt skilja produkten från nätet. Stickproppen används för att helt bryta strömförsörjningen till apparaten, och den måste vara lättillgänglig för användaren.

Copyrights (English)
2 It is prohibited by law to reproduce, broadcast, rent or play discs in public without the consent of the copyright holder.

Urheberrechte (Deutsch)
2 Die Reproduktion, Ausstrahlung, der Verleih sowie die öffentliche Wiedergabe von Discs erfordern die Zustimmung des Urheberrechtinhabers.

Droits d'auteur (Français)
2 La reproduction, la diffusion, la location, le prêt ou la lecture publique de ces disques sont interdits sans le consentement du détenteur des droits d'auteur.

Copyright (Italiano)
2 La duplicazione, la trasmissione, il noleggio e la riproduzione dei dischi in pubblico senza l'autorizzazione scritta del titolare dei diritti di copyright sono vietati dalla legge.

Derechos de Autor (Español)
2 De acuerdo con las leyes está prohibido reproducir, emitir, alquilar o interpretar discos en público sin la autorización del propietario de los derechos de autor.

Auteursrechten (Nederlands)
2 Het zonder toestemming van de auteursrechthebbenden reproduceren, uitzenden, verhuren of in het openbaar afspelen van discs is wettelijk verboden.

Upphovsrätt (Svenska)
2 Enligt lagen är det förbjudet att återge, utsända, hyra ut eller spela skivor för allmän publik med mindre tillstånd från ägaren till upphovsrätten först har inhämtats.

NOTE ON USE / HINWEISE ZUM GEBRAUCH / OBSERVATIONS RELATIVES A L'UTILISATION / NOTE SULL'USO / NOTAS SOBRE EL USO / ALVORENS TE GEBRUIKEN / OBSERVERA

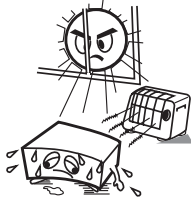

- Avoid high temperatures.
Allow for sufficient heat dispersion when installed on a rack.
- Vermeiden Sie hohe Temperaturen.
Beachten Sie, daß eine ausreichend Luftzirkulation gewährleistet wird, wenn das Gerät auf ein Regal gestellt wird.
- Eviter des températures élevées
Tenir compte d'une dispersion de chaleur suffisante lors de l'installation sur une étagère.
- Evitate di esporre l'unità a temperature alte.
Assicuratevi che ci sia un'adeguata dispersione del calore quando installate l'unità in un mobile per componenti audio.
- Evite altas temperaturas
Permite la suficiente dispersión del calor cuando está instalado en la consola.
- Vermijd hoge temperaturen.
Zorg voor een degelijk hitteafvoer indien het apparaat op een rek wordt geplaatst.
- Undvik höga temperaturer.
Se till att det finns möjlighet till god värmeavledning vid montering i ett rack.

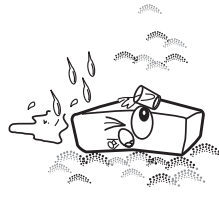

- Keep the set free from moisture, water, and dust.
- Halten Sie das Gerät von Feuchtigkeit, Wasser und Staub fern.
- Protéger l'appareil contre l'humidité, l'eau et la poussière.
- Tenete l'unità lontana dall'umidità, dall'acqua e dalla polvere.
- Mantenga el equipo libre de humedad, agua y polvo.
- Laat geen vochtigheid, water of stof in het apparaat binnendringen.
- Utsätt inte apparaten för fukt, vatten och damm.



- Do not let foreign objects in the set.
- Keine fremden Gegenstände in das Gerät kommen lassen.
- Ne pas laisser des objets étrangers dans l'appareil.
- E' importante che nessun oggetto è inserito all'interno dell'unità.
- No deje objetos extraños dentro del equipo.
- Laat geen vreemde voorwerpen in dit apparaat vallen.
- Se till att främmande föremål inte tränger in i apparaten.



- Unplug the power cord when not using the set for long periods of time.
- Wenn das Gerät eine längere Zeit nicht verwendet werden soll, trennen Sie das Netzkabel vom Netzstecker.
- Débrancher le cordon d'alimentation lorsque l'appareil n'est pas utilisé pendant de longues périodes.
- Disinnestate il filo di alimentazione quando avete l'intenzione di non usare il filo di alimentazione per un lungo periodo di tempo.
- Desconecte el cordón de energía cuando no utilice el equipo por mucho tiempo.
- Neem altijd het netsnoer uit het stopcontact wanneer het apparaat gedurende een lange periode niet wordt gebruikt.
- Koppla ur nätkabeln om apparaten inte kommer att användas i lång tid.



- Do not let insecticides, benzene, and thinner come in contact with the set.
- Lassen Sie das Gerät nicht mit Insektiziden, Benzin oder Verdünnungsmitteln in Berührung kommen.
- Ne pas mettre en contact des insecticides, du benzène et un diluant avec l'appareil.
- Assicuratevi che l'unità non venga in contatto con insetticidi, benzolo o solventi.
- No permita el contacto de insecticidas, gasolina y diluyentes con el equipo.
- Laat geen insektenverdelgende middelen, benzine of verververdunner met dit apparaat in contact komen.
- Se till att inte insektsmedel på spraybruk, bensen och thinner kommer i kontakt med apparatens hölje.



- Handle the power cord carefully.
Hold the plug when unplugging the cord.
- Gehen Sie vorsichtig mit dem Netzkabel um.
Halten Sie das Kabel am Stecker, wenn Sie den Stecker herausziehen.
- Manipuler le cordon d'alimentation avec précaution.
Tenir la prise lors du débranchement du cordon.
- Maneggiare il filo di alimentazione con cura.
Agite per la spina quando scollegate il cavo dalla presa.
- Maneje el cordón de energía con cuidado.
Sostenga el enchufe cuando desconecte el cordón de energía.
- Hanteer het netsnoer voorzichtig.
Houd het snoer bij de stekker vast wanneer deze moet worden aan- of losgekoppeld.
- Hantera nätkabeln varsamt.
Håll i kabeln när den kopplas från el-uttaget.



* (For sets with ventilation holes)

- Do not obstruct the ventilation holes.
- Die Belüftungsöffnungen dürfen nicht verdeckt werden.
- Ne pas obstruer les trous d'aération.
- Non coprite i fori di ventilazione.
- No obstruya los orificios de ventilación.
- De ventilatieopeningen mogen niet worden beblokkeerd.
- Täpp inte till ventilationsöppningarna.



- Never disassemble or modify the set in any way.
- Versuchen Sie niemals das Gerät auseinander zu nehmen oder auf jegliche Art zu verändern.
- Ne jamais démonter ou modifier l'appareil d'une manière ou d'une autre.
- Non smontate mai, nè modificate l'unità in nessun modo.
- Nunca desarme o modifique el equipo de ninguna manera.
- Nooit dit apparaat demonteren of op andere wijze modificieren.
- Ta inte isär apparaten och försök inte bygga om den.

CAUTION

- The ventilation should not be impeded by covering the ventilation openings with items, such as newspapers, tablecloths, curtains, etc.
- No naked flame sources, such as lighted candles, should be placed on the apparatus.
- Attention should be drawn to the environmental aspects of battery disposal.
- The apparatus shall not be exposed to dripping or splashing for use.
- No objects filled with liquids, such as vases, shall be placed on the apparatus.
- The socket-outlet shall be installed near the equipment and shall be easily accessible.

•DECLARATION OF CONFORMITY

We declare under our sole responsibility that this product, to which this declaration relates, is in conformity with the following standards:

EN60065, EN55013, EN55020, EN61000-3-2 and EN61000-3-3.

Following the provisions of 73/23/EEC, 2004/108/EC and 93/68/EEC Directive.

•ÜBEREINSTIMMUNGSERKLÄRUNG

Wir erklären unter unserer Verantwortung, daß dieses Produkt, auf das sich diese Erklärung bezieht, den folgenden Standards entspricht:

EN60065, EN55013, EN55020, EN61000-3-2 und EN61000-3-3.

Entspricht den Verordnungen der Direktive 73/23/EEC, 2004/108/EC und 93/68/EEC.

•DECLARATION DE CONFORMITE

Nous déclarons sous notre seule responsabilité que l' appareil, auquel se réfère cette déclaration, est conforme aux standards suivants:

EN60065, EN55013, EN55020, EN61000-3-2 et EN61000-3-3.

D'après les dispositions de la Directive 73/23/EEC, 2004/108/EC et 93/68/EEC.

•DICHIAZIONE DI CONFORMITÀ

Dichiariamo con piena responsabilità che questo prodotto, al quale la nostra dichiarazione si riferisce, è conforme alle seguenti normative:

EN60065, EN55013, EN55020, EN61000-3-2 e EN61000-3-3.

In conformità con le condizioni delle direttive 73/23/EEC, 2004/108/EC e 93/68/EEC.

QUESTO PRODOTTO E' CONFORME

AL D.M. 28/08/95 N. 548

•DECLARACIÓN DE CONFORMIDAD

Declaramos bajo nuestra exclusiva responsabilidad que este producto al que hace referencia esta declaración, está conforme con los siguientes estándares:

EN60065, EN55013, EN55020, EN61000-3-2 y EN61000-3-3.

Siguiendo las provisiones de las Directivas 73/23/EEC, 2004/108/EC y 93/68/EEC.

•EENVORMIGHEIDSVERKLARING

Wij verklaren uitsluitend op onze verantwoordelijkheid dat dit product, waarop deze verklaring betrekking heeft, in overeenstemming is met de volgende normen:

EN60065, EN55013, EN55020, EN61000-3-2 en EN61000-3-3.

Volgens de bepalingen van de Richtlijnen 73/23/EEC, 2004/108/EC en 93/68/EEC.

•ÖVERENSSTÄMMELSESINTYG

Härmed intygas helt på eget ansvar att denna produkt, vilken detta intyg avser, uppfyller följande standarder:

EN60065, EN55013, EN55020, EN61000-3-2 och EN61000-3-3.

Enligt stadgarna i direktiv 73/23/EEC, 2004/108/EC och 93/68/EEC.

CLASS 1 LASER PRODUCT
LUOKAN 1 LASERLAITE
KLASS 1 LASERAPPARAT

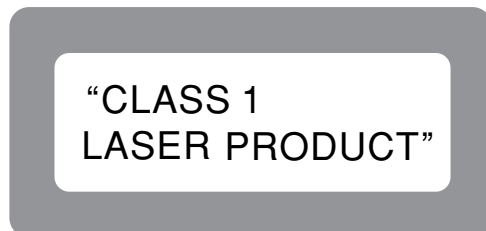

ATTENZIONE: QUESTO APPARECCHIO E' DOTATO DI DISPOSITIVO OTTICO CON RAGGIO LASER.

L'USO IMPROPRIO DELL'APPARECCHIO PUO' CAUSARE PERICOLOSE ESPOSIZIONI A RADIAZIONI!!

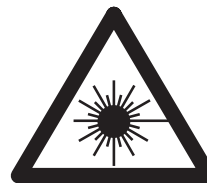

ADVARSEL: USYNLIG LASERSTRÅLING VED ÅBNING, NÅR SIKKERHEDSAFBRYDERE ER UDE AF FUNKTION. UNDGÅ UDSAETTELSE FOR STRÅLING.

VAROITUS! LAITTEEN KÄYTTÄMINEN MUULLA KUIN TÄSSÄ KÄYTTÖOHJEESSA MAINITULLA TAVALLA SAATTAA ALTISTAA KÄYTTÄJÄN TURVALLISUUSLUOKAN 1 YLITTÄVÄLLE NÄKYMÄMTTÖMÄLLE LASERSÄTEILYLLE.

VARNING-- OM APPARATEN ANVÄNDS PÅ ANNAT SÄTT ÄN I DENNA BRUKSANVISNING SPECIFICERATS, KAN ANVÄNDAREN UTSÄTTAS FÖR OSYNLIG LASERSTRÅLNING SOM ÖVERSKRIDER GRÄNSEN FÖR LASERKLASS 1.

CAUTION:

USE OF CONTROLS OR ADJUSTMENTS OR PERFORMANCE OF PROCEDURES OTHER THAN THOSE SPECIFIED HEREIN MAY RESULT IN HAZARDOUS RADIATION EXPOSURE.

THIS PRODUCT SHOULD NOT BE ADJUSTED OR REPAIRED BY ANYONE EXCEPT PROPERLY QUALIFIED SERVICE PERSONNEL.

A NOTE ABOUT RECYCLING:

(English)

This product's packaging materials are recyclable and can be reused. Please dispose of any materials in accordance with the local recycling regulations.

When discarding the unit, comply with local rules or regulations.

Batteries should never be thrown away or incinerated but disposed of in accordance with the local regulations concerning chemical waste.

This product and the accessories packed together constitute the applicable product according to the WEEE directive except batteries.

**HINWEIS ZUM RECYCLING:**

(Deutsch)

Das Verpackungsmaterial dieses Produktes ist zum Recyceln geeignet und kann wiederverwendet werden. Bitte entsorgen Sie alle Materialien entsprechend der örtlichen Recycling-Vorschriften.

Beachten Sie bei der Entsorgung des Gerätes die örtlichen Vorschriften und Bestimmungen.

Die Batterien dürfen nicht in den Hausmüll geworfen oder verbrannt werden; bitte geben Sie die Batterien gemäß den örtlichen Bestimmungen an den Sammelstellen oder Sondermüllplätzen ab.

Dieses Produkt zusammen mit den Zubehörteilen ist das geltende Produkt der WEEE-Direktive, davon ausgenommen sind die Batterien.

**REMARQUE CONCERNANT LE RECYCLAGE :**

(Français)

Le matériel d'emballage de cet appareil est recyclable et réutilisable. Veuillez disposer de tout matériau conformément à la réglementation de recyclage en vigueur dans votre pays.

Lorsque vous mettez cet appareil au rebut, respectez les lois ou réglementations locales.

Les piles ne doivent jamais être jetées à la poubelle ou incinérées, mais mises au rebut conformément aux réglementations locales concernant les déchets chimiques.

Ce produit et les accessoires emballés ensemble sont des produits conformes à la directive DEEE sauf pour les piles.

**NOTA RELATIVA AL RICICLAGGIO :**

(Italiano)

I materiali di imballaggio di questo prodotto sono riutilizzabili e riciclabili. Smaltire i materiali conformemente alle normative nazionali sul riciclaggio.

Per smaltire l'unità, osservare la normativa in vigore nel luogo di utilizzo.

Non gettare le pile, né bruciarle, ma smaltirle conformemente alla normativa locale sui rifiuti chimici.

Il prodotto e gli accessori inclusi nell'imballaggio rientrano nella direttiva WEEE, ad eccezione delle pile.

**ACERCA DEL RECICLAJE:**

(Español)

Los materiales de embalaje de este producto son reciclables y se pueden volver a utilizar. Elimine estos materiales de acuerdo con la normativa de reciclaje local.

Cuando se deshaga de la unidad, cumpla con la reglamentación y la normativa locales.

No tire ni arroje las pilas al fuego. Elimínelas siguiendo la normativa local relacionada con los desperdicios químicos.

Este producto y los accesorios que lo acompañan constituyen el producto aplicable de la directiva RAEE a excepción de las pilas.

**EEN OPMERKING OVER RECYCLING:**

(Nederlands)

Het verpakkingsmateriaal van dit product is recyclebaar en kan opnieuw worden gebruikt. Gelieve het materiaal weg te gooien in overeenstemming met wettelijke recyclingvoorschriften.

Als u het apparaat weggooit, houdt u dan aan de plaatselijke wetten en regels.

Batterijen mogen nooit worden weggegooid of verbrand, maar moeten worden weggegooid in overeenstemming met de lokale wetgeving betreffende chemisch afval.

Dit product en de bijgeleverde accessoires vertegenwoordigen het toepasbare product volgens de WEEE-richtlijn behalve de batterijen.

**ANGÅENDE ÅTERVINNING:**

(Svenska)

Produktens emballage är återvinningsbart. Kassera det enligt lokala återvinningsbestämmelser.

Kassera enheten i överensstämmelse med lokala regler och föreskrifter.

Batterier får aldrig kastas i soporna eller brännas, utan ska kasseras enligt lokala bestämmelser för kemiskt avfall.

Denna produkt och de medföljande tillbehören förutom batterierna, uppfyller gällande WEEE-direktiv.



— TABLE OF CONTENTS —

1 FEATURES.....	2	13 USING THE ON-SCREEN DISPLAY	50
2 DISCS	3	14 USING THE MULTIPLE AUDIO, SUBTITLE AND	
3 CAUTIONS ON HANDLING DISCS	5	ANGLE FUNCTIONS	51
4 CONNECTIONS.....	6	15 USING THE MENUS.....	54
5 PART NAMES AND FUNCTIONS	14	16 PLAYING IN THE ZOOM MODE	56
6 REMOTE CONTROL UNIT	16	17 MP3/WMA FILE PLAYBACK	57
7 LOADING DISCS	19	18 PLAYING STILL PICTURE FILES (JPEG format)	59
8 CHANGING THE DEFAULT SETTINGS.....	20	19 DivX FILE PLAYBACK.....	62
9 PLAYBACK	38	20 ADVANCED FUNCTION	66
10 PLAYING REPEATEDLY	42	21 TROUBLESHOOTING	74
11 PLAYING TRACKS IN THE DESIRED ORDER	45	22 MAIN SPECIFICATIONS	75
12 PLAYING TRACKS IN THE RANDOM ORDER	49		

ACCESSORIES

Please check to make sure the following items are included with the main unit in the carton:

① Audio cord.....	1	⑥ Power supply cord	1
② Video cord	1	⑦ User guide.....	1
③ Video cord (COMPONENT)	1	⑧ Service station list.....	1
④ Remote control unit (RC-963)	1	⑨ Rackmount kit.....	1
⑤ R03/AAA batteries	2		

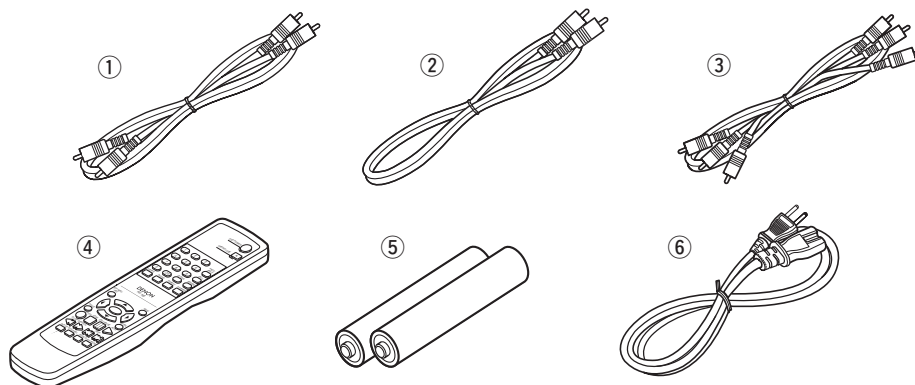

1 FEATURES

1. High precision 96 kHz 24-bit D/A converter

The DN-V210/DN-V310 is equipped with a 24-bit D/A converter for faithful D/A conversion of the high quality 24-bit data. This further enhances such aspects of audio performance as the S/N ratio, dynamic range and distortion and makes full use of the possibilities for high quality sound provided by a high number of bits and high sampling rates.

2. Progressive Scan function

The DN-V210/DN-V310 is equipped with a progressive scan function achieving playback with high picture quality. Movies and other DVD software can be recreated with a picture quality near that of the original.

3. Advanced function

- (1) KEY LOCK
Operation of the buttons on the front panel (aside from the POWER button) is disabled to prevent accidental operation.
- (2) IR REMOTE LOCK
Operation of the buttons on the remote controller is disabled to prevent accidental operation.
- (3) HIDE OSD
Switch the OSD and the display of the icons that appear on the screen on and off.
- (4) AUTO PLAY
By this function the player can start playback automatically after power on.

4. Serial remote control (DN-V310 only)

Commands can be sent to the DVD player and the status requested and sent to the host via RS-232C.

5. Change the image on the DVD Player wallpaper

The image on the DVD player wallpaper can be changed at the user's discretion.

2 DISCS

- The types of discs listed on the table below can be used on the DN-V210/DN-V310.
The marks are indicated on the disc labels or jackets.

Usable discs	Mark (logo)	Recorded signals	Disc size
DVD video DVD audio (NOTE 1)		Digital audio + Digital video (MPEG2)	12 cm
DVD-R DVD-RW (NOTE 2)			8 cm
Video CD		Digital audio + Digital video (MPEG1)	12 cm
			8 cm
CD CD-R CD-RW (NOTE 3) DTS-CD		Digital audio MP3	12 cm
		Digital picture (JPEG)	8 cm
Picture CD		Digital picture (JPEG)	12 cm
WMA		Digital audio	12 cm
DivX®		Digital audio + Digital video (MPEG4)	12 cm
WMA Windows Media Audio		Digital audio	12 cm

■ The following types of discs cannot be played on the DN-V210/DN-V310:

- For USA model:
DVDs with region numbers other than "1" or "ALL"
- For Europe model:
DVDs with region numbers other than "2" or "ALL"
- DVD-ROM/RAMs (For DVD-ROM discs, data files in DivX® 3.11, 4.12 and 5.1 format can be played)
- SACD (only CD layered can be played)
- CD-ROMs (Data files in MP3, JPEG, WMA, and DivX® 3.11, 4.12 and 5.1 can be played)
- CDVs (Only the audio part can be played.)
- Photo CDs

NOTE 1: Video part which based on DVD-video specification only can be played.

NOTE 2: Playing DVD-R and DVD-RW discs
DVD-R and DVD-RW discs recorded in video format on a DVD recorder can be played on the DN-V210/DN-V310.

Discs that have not be finalized cannot be played.
Depending on the disc's recording status, the disc may not be accepted or may not be played normally (the picture or sound may be not be smooth, etc.).

NOTE 3: According to recording quality, some CD-R/RW cannot be played.

NOTE 4: "Windows Media™", "Windows®" are a trademarks of Microsoft Corporation, Inc.

■ Disc terminology

• Titles and chapters (DVD-videos)

DVD-videos are divided into several large sections called "titles" and smaller sections called "chapters". Numbers are allotted to these sections. These numbers are called "title numbers" and "chapter numbers".

For example:

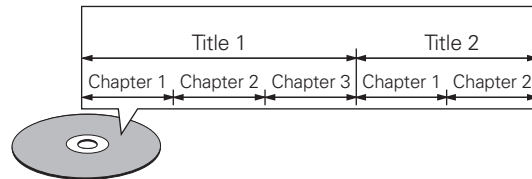

• Tracks (video and music CDs)

Video and music CDs are divided into sections called "tracks". Numbers are allotted to these sections. These numbers are called "track numbers".

For example:

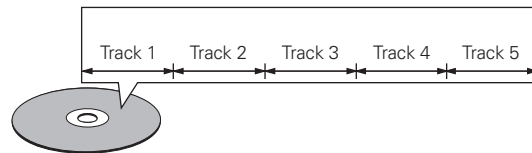

• Playback control (PBC) (video CDs)

Video CDs including the words "playback control" on the disc or jacket are equipped with a function for displaying menus on the TV screen for selecting the desired position, displaying information, etc., in dialog fashion.

In this manual, playing video CDs using such menu is referred to "menu playback".

Video CDs with playback control can be used on the DN-V210/DN-V310.

■ Patent information



Manufactured under license from Dolby Laboratories. "Dolby" and the double-D symbol are trademarks of Dolby Laboratories.



Manufactured under license under U.S. Patent #:5,451,942 & other U.S. and worldwide patents issued & pending. DTS and DTS Digital Out are registered trademarks and the DTS logos and Symbol are trademarks of DTS, Inc. © 1996-2007 DTS, Inc. All Rights Reserved.



DivX, DivX Certified, and associated logos are trademarks of DivX, Inc. and are used under license.



"HDMI", the "HDMI" logo and "High Definition Multimedia Interface" are trademarks or registered trademark of HDMI Licensing LLC.

NOTE:

- This DVD player is designed and manufactured to respond to the Region Management Information that is recorded on a DVD disc. If the Region number described on the DVD disc does not correspond to the Region number of this DVD player, this DVD player cannot play this disc.

For USA model:

The Region number for this DVD player is 1.



For Europe model:

The Region number for this DVD player is 2.



CAUTIONS ON INSTALLATION

For heat dispersal, leave at least 0.2 m/8 inch of space between the top, back and sides of this unit and the wall or other components.

- Do not obstruct the ventilation holes.

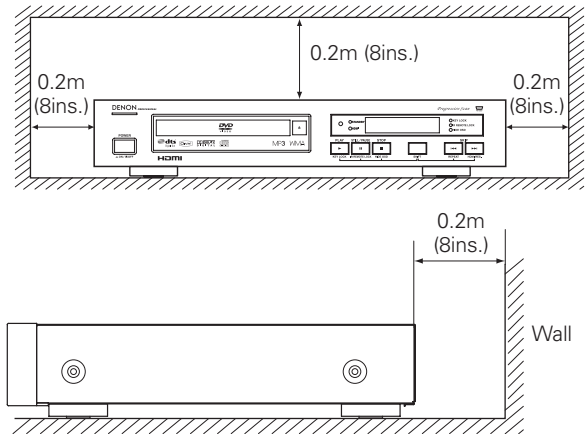

3 CAUTIONS ON HANDLING DISCS

Discs

Only the discs including the marks shown on page 5 can be played on the DN-V210/DN-V310.

Note, however, that discs with special shapes (heart-shaped discs, hexagonal discs, etc.) cannot be played on the DN-V210/DN-V310. Do not attempt to play such discs, as they may damage the player.



Holding Discs

Avoid touching the surface of discs when loading and unloading them.

Be careful not to get fingerprints on the signal surface (the side which shines in rainbow colors).



Cleaning Discs

- Fingerprints or dirt on the disc may lower sound and picture quality or cause breaks in playback. Wipe off fingerprints or dirt.
- Use a commercially available disc cleaning set or a soft cloth to wipe off fingerprints or dirt.

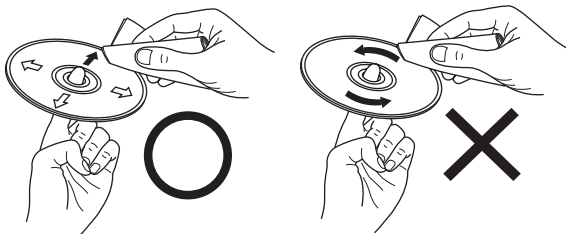

Wipe gently from the middle outwards.

Do not wipe with a circular motion.

NOTE:

- Do not use record spray or antistatic. Also do not use volatile chemicals such as benzene or thinner.



Record spray Thinner Benzene

Cautions on Handling Discs

- Do not get fingerprints, grease or dirt on discs.
- Be especially careful not to scratch discs when removing them from their cases.
- Do not bend discs.
- Do not heat discs.
- Do not enlarge the center hole.
- Do not write on the labeled (printed) side with a ball-point pen or a pencil.
- Water droplets may form on the surface if the disc is moved suddenly from a cold place to a warm one. Do not use a hairdryer, etc., to dry the disc.

Cautions on Storing Discs

- Always eject discs after playing them.
- Keep discs in their cases to protect them from dust, scratches and warping.
- Do not put discs in the following places:
 1. Places exposed to direct sunlight for long periods of time
 2. Humid or dusty places
 3. Places exposed to heat from heaters, etc.

Cautions on Loading Discs

- Only load one disc at a time. Loading one disc on top of another may result in damage or scratch the discs.
- Load 8 cm discs securely in the disc guide, without using an adapter. If the disc is not properly loaded, it may slip out of the guide and block the disc tray.
- Be careful not to let your fingers get caught when the disc tray is closing.
- Do not place anything but discs in the disc tray.
- Do not load cracked or warped discs or discs that have been fixed with adhesive, etc.
- Do not use discs on which the adhesive part of cellophane tape or glue used to attach the label is exposed, or discs with traces of tape or labels that have been peeled off. Such discs may get stuck inside the player, resulting in damage.

4 CONNECTIONS

NOTES:

- Read the manuals of all the components when making connections.
- Keep the power cord unplugged until all connections have been completed.
- If the power is on when connections are made, noise may be generated and damage the speakers.
- Be sure to connect the left and right channels properly, L (left) to L, R (right) to R.
- Plug the power cord securely into the power outlet. Incomplete connection may result in noise.
- Binding the power cord together with connection cords may result in humming or noise.

(1) Connecting a TV

- Use the included audio video cord to connect the TV's video input connector and audio input connectors to the DN-V210/DN-V310's VIDEO OUT or S-VIDEO OUT and AUDIO OUT.

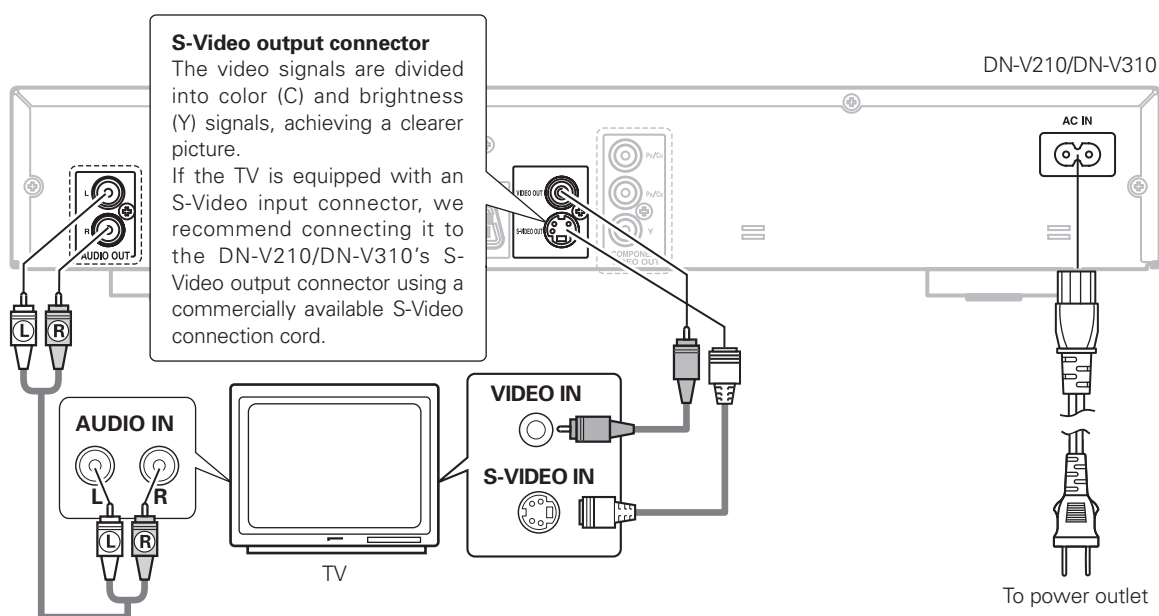

NOTES:

- Connect the DN-V210/DN-V310's video outputs to the TV either directly or through an AV amplifier. Do not connect it via a VCR (video cassette recorder). Some discs contain copy prohibit signals. If such discs are played via a VCR, the copy prohibit system may cause disturbance in the picture.
- Set the "TV TYPE" in "VIDEO SETUP" in "SETUP" to comply with your TV's video format. When the TV is NTSC formatted, set to NTSC. When the TV is PAL formatted, set to PAL.
(See page 24.)
- Set the "TV ASPECT" in "VIDEO SETUP" in "SETUP" to comply with your TV's aspect. (See page 24.)
- No audio signals are output from the DN-V210/DN-V310's "AUDIO OUT" connector when discs recorded in DTS are played.

(2) Connecting to a TV or Monitor Equipped with Color Component Input Connectors

Color component output connectors (PR/CR, PB/CB and Y)

The red (PR/CR), blue (PB/CB) and brightness (Y) signals are output independently, achieving more faithful reproduction of the colors.

- The color component input connectors may be marked differently on some TVs or monitors (PR, PB and Y/R-Y, B-Y and Y/CR, CB and Y, etc.). For details, refer to the TV's operating instructions.
- If your TV is compatible with progressive scan, press the "SHIFT" and "HDMI RES." button on the front panel so that "P.SCAN" lights on the display. This results in a high quality picture with little flickering.

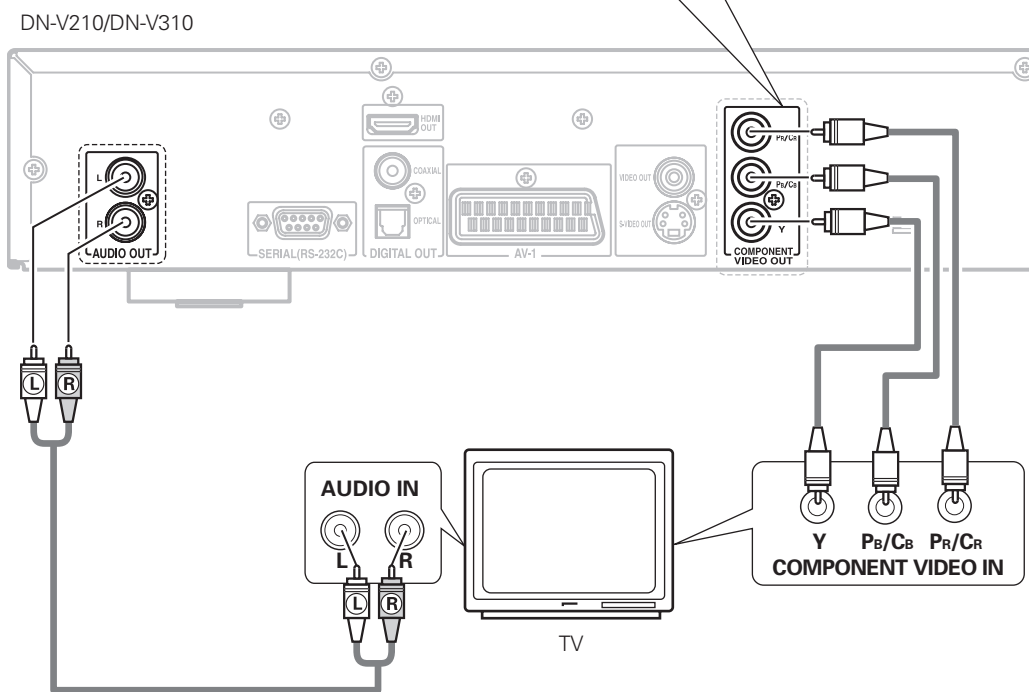

NOTES:

- Use the three commercially available video cords to connect the DN-V210/DN-V310's color component output connectors to the TV or monitor.
- Set the "TV TYPE" in "VIDEO SETUP" in "SETUP" to comply with your TV's video format. When the TV is NTSC formatted, set to NTSC. When the TV is PAL formatted, set to PAL. (See page 24.)
- Set the "480p/576p" in "HDMI RES." in "VIDEO SETUP" in "SETUP" to comply with Progressive TV.
- Set the "TV ASPECT" in "VIDEO SETUP" in "SETUP" to comply with your TV's aspect. (See page 24)
- No audio signals are output from the DN-V210/DN-V310's "AUDIO OUT" connector when discs recorded in DTS are played.
- When VIDEO OUT in the VIDEO SETUP menu is set to "RGB," component video is not output. (Europe model only)

(3) Connecting to a TV with 21-pin SCART Terminal (For only Europe model)

- Use the commercially 21-pin SCART cable to connect the TV's 21-pin SCART terminal to the DN-V210/DN-V310's 21-pin SCART terminal (AV1).
- Select "RGB" for the video output setting at the setup screen video setup.
- CVBS and RGB signal are output from the SCART terminal (AV1).

When "RGB" is selected, no video signals are output from the component output.

When "RGB" is selected, CVBS and RGB are output.

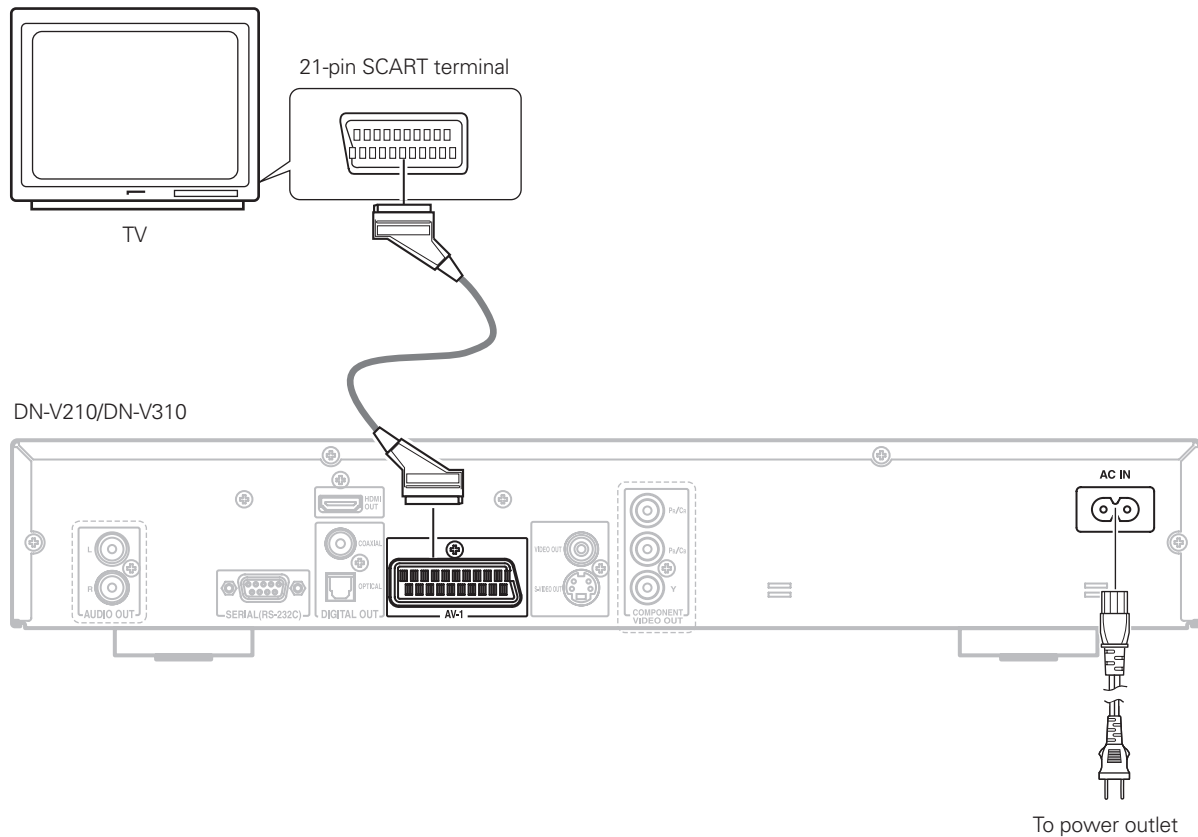

NOTES:

- Some discs contain copy prohibit signals. If such discs are played via a VCR, the copy prohibit system may cause disturbance in the picture.
- Set the "TV TYPE" in "VIDEO SETUP" in "SETUP" to comply with your TV's video format. When the TV is NTSC formatted, set to NTSC. When the TV is PAL formatted, set to PAL. (See page 24.)

(4) Connecting to a AV amplifier with a Built-in decoder

When DVDs recorded in Dolby Digital or DTS are played, Dolby Digital or DTS bitstream signals are output from the DVD player's digital audio output connectors. If a Dolby Digital or DTS decoder is connected, you can achieve sound with the power and sense of presence of a movie theater or concert hall.

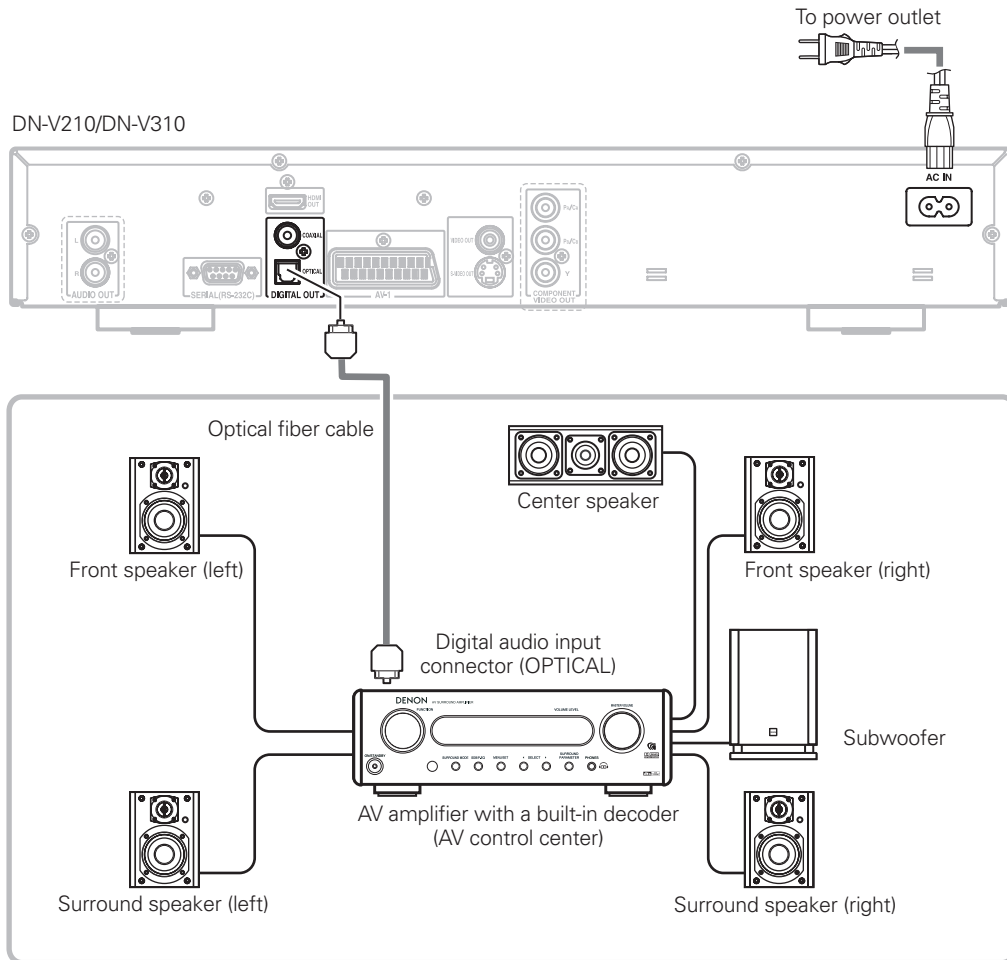

NOTE:

- Harsh noise that could harm your ears or damage the speakers is generated when a DVD recorded in DTS is played while using a decoder, etc., that is not DTS-compatible.

■ Connecting an optical fiber cable to the digital audio input connector (OPTICAL)

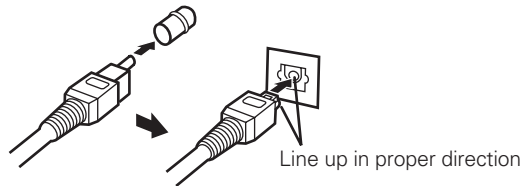

Remove the dust cap, line up the cable in the proper directly, then insert it securely as far as it goes.

■ Sound output from the DN-V210/DN-V310's digital audio output connectors

In the case of bit stream output

		Settings	
		DIGITAL OUTPUT	
		Audio recording format	NORMAL
DVD video	Dolby Digital	Dolby Digital bitstream	2 channels PCM (48 kHz / 16 bit)
	DTS	DTS bitstream	—
	MPEG Audio	2 channels PCM (48 kHz / 16 bit)	2 channels PCM (48 kHz / 16 bit)

In the case of PCM output

			Settings			
			96 k LPCM OUT			
			Audio recording format	96 kHz		96 k > 48 k
				Copy protection ON	Copy protection OFF	
DVD video	Linear PCM	48 kHz / 16 ~ 24 bit	No output data (*1)	48 kHz / 16 ~ 24 bit PCM	48 kHz / 16 bit PCM	
		96 kHz / 16 ~ 24 bit	No output data (*2)	96 kHz / 16 ~ 24 bit PCM	48 kHz / 16 bit PCM	
Video CD	MPEG 1		44.1 kHz / 16 bit PCM		44.1 kHz / 16 bit PCM	
Music CD	44.1 kHz / 16 bit Linear PCM		44.1 kHz / 16 bit PCM		44.1 kHz / 16 bit PCM	
MP3 CD	MP 3 (MPEG-1 Audio Layer 3)		32 ~ 48 kHz / 16 bit PCM		32 ~ 48 kHz / 16 bit PCM	

*1 Only 48 kHz/16 bit sources are output.

*2 When playing copyright-protected linear PCM DVDs, in consideration of copyrights, no digital signals are output for sources exceeding 48 kHz/16 bits. When playing such sources, either set to "96k>48k" or make analog connections.

- Linear PCM audio is a signal recording format used for music CDs. While signals are recorded at 44.1 kHz/16 bit for music CDs, for DVDs they are recorded at 48 kHz/16 bit to 96kHz/24 bit, providing higher sound quality than music CDs.
- When you want to listen to output in DTS, set DIGITAL OUTPUT to NORMAL (bit stream). (See page 26.)

(5) Connecting to a Digital Recorder (MD Recorder, DAT Deck, etc.)

* Set the "AUDIO SETUP" default setting as shown below. (See page 26.)

- "DIGITAL OUTPUT" → "PCM"
- "96k LPCM OUT" → "96k>48k"

Playing DVDs with incorrect settings may result noise that could damage your ears or the speakers.

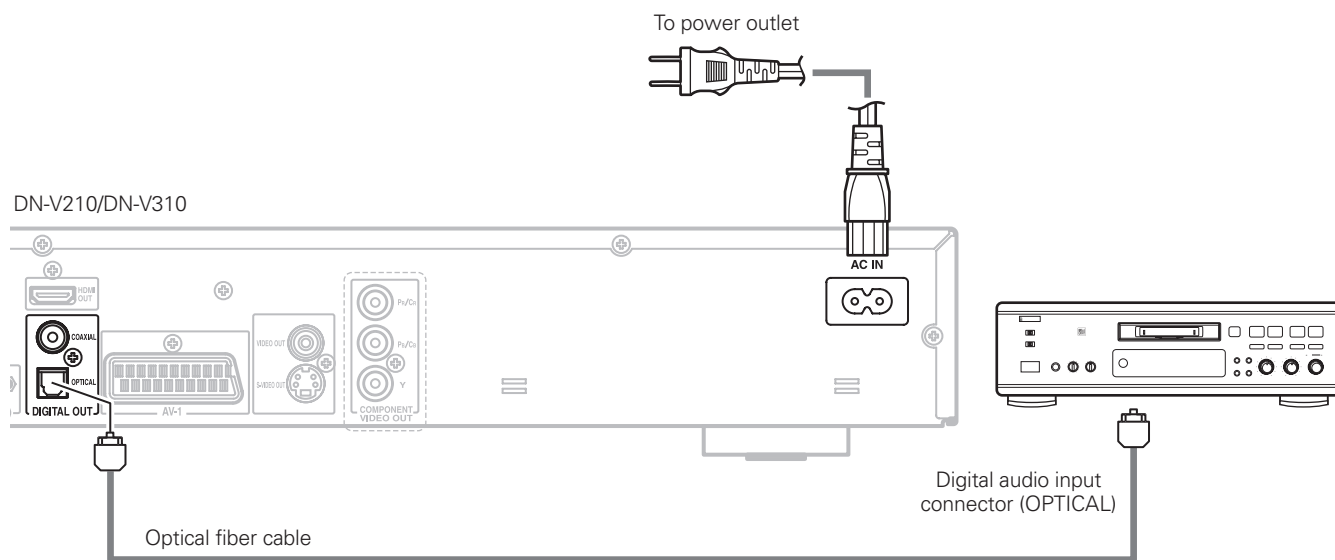

(6) Connecting to a Stereo Component

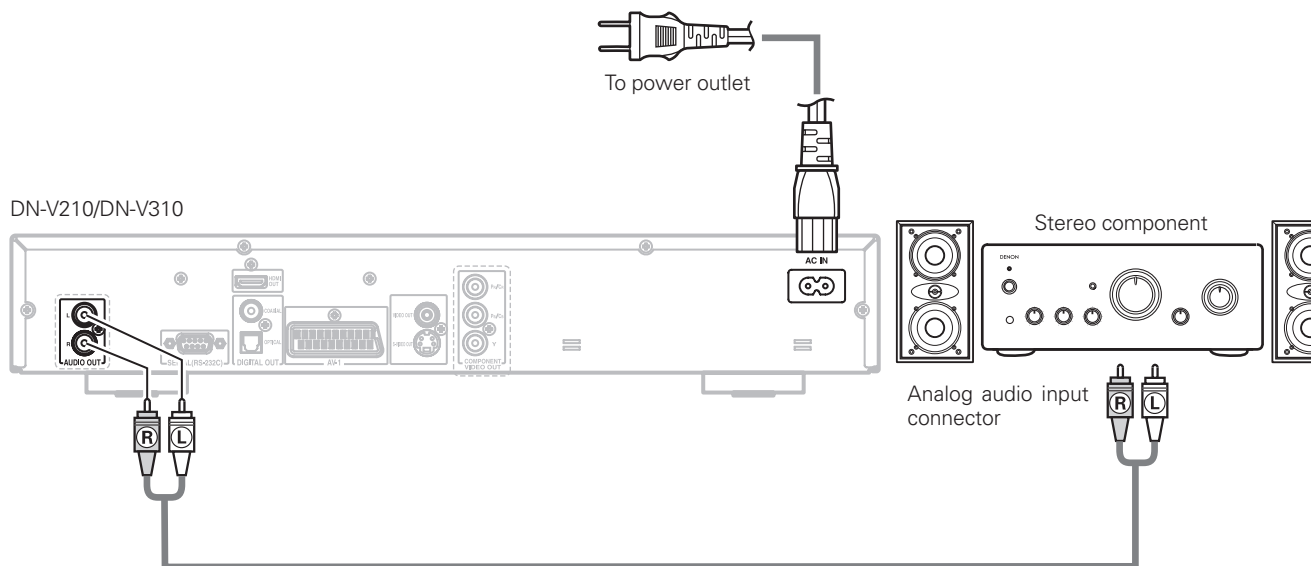

NOTES:

- When connecting to a stereo device with 2 audio channels
 - ① For sources recorded in multiple channels, analog signals downmixed into two channels are output. (For sources for which downmixing is prohibited, only the FL and FR channels are output.)
 - ② Set "96kLPCM OUT" at "AUDIO SETUP" under "SETUP" to "96k>48k" (See page 26). (When set to "96k>48k", analog audio signals converted to 48 kHz or less are output for linear PCM sources.)

(7) Connecting to a HDMI device

HDMI Terminal

This unit has one HDMI output. It can send digital video and analog signals from DVDs. It minimizes signal degradation caused by analog conversion so that high quality images can be enjoyed.

Select an HDMI output mode from the SETUP MENU. (See page 23.)

NOTES:

- When the HDMI output is connected to a display monitor that does not support HDCP, signals are not output. To view images in HDMI, it is necessary to connect to a display that supports HDCP.
- There may be no image output if connected to a TV or display that is not compatible with the above format.
- Refer to the instruction manual of the TV or display to be connected to the DN-V210/DN-V310 for detailed information regarding the HDMI terminal.

* **HDCP: High-bandwidth Digital Content Protection**

CONNECTING HDMI DEVICES

An HDMI cable (sold separately) is used to connect the HDMI output on the DN-V210/DN-V310 with the HDMI Terminal on a DVD player, TV, projector or other component. To transmit multichannel audio via HDMI, the connected player must support multichannel audio transmission through its HDMI output.

HDMI video streaming is compatible with DVI in principle. Therefore, it is possible to connect to a TV or monitor that has a DVI terminal using an HDMI-DVI conversion cable or plug. When connecting to a DVI terminal, connect the audio signal separately. Note that HDCP may not work with some DVI components.

HDMI SPECIFICATIONS

The HDMI output supports the High-Definition Multimedia Interface specification Information version 1.0.

The video resolutions are as follows.

- 480 p : 720 × 480
- 720 p : 1280 × 720
- 1080 i : 1920 × 1080

If the connected HDTV or projector doesn't support a resolution, HDMI output resolution may not work.

The audio formats are as follows.

- PCM (41.1 kHz, 48 kHz, 96 kHz)
- Dolby Digital
- DTS

If your TV only supports HDMI digital audio up to 48 kHz, change the Linear PCM out setting to down sample on. (See page 27.)

If your TV doesn't support Dolby Digital, set the digital out setting to PCM. (See page 26.)

If your TV doesn't support DTS, the DN-V210/DN-V310 will not be able to play DTS format audio sound tracks. In this case, on your DVD-video discs audio set up menu, select an audio format other than DTS.

NOTES:

- When connected to a monitor (i.e., TV, projector, etc.) that does not support HDCP, video and audio are not output.
- Disconnecting or connecting cables with the power on can damage the equipment. Turn the power off before disconnecting or connecting cables.
- Depending on the quality of the cable used, the HDMI signal may be affected by noise.

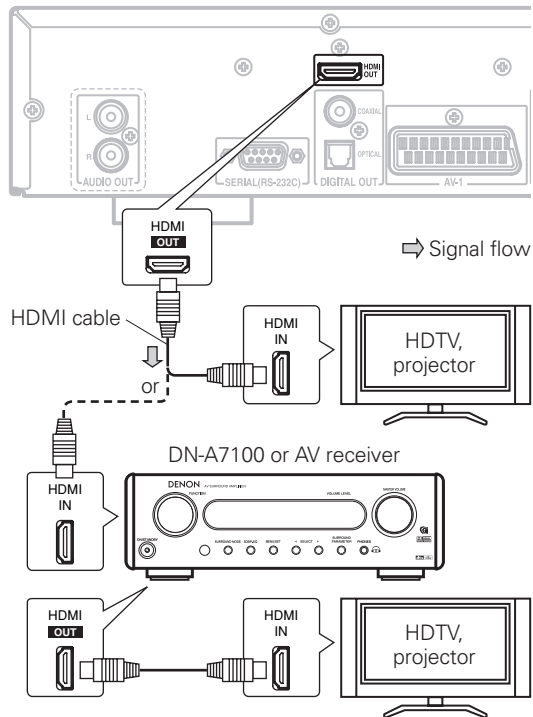

5 PART NAMES AND FUNCTIONS

(1) Front Panel

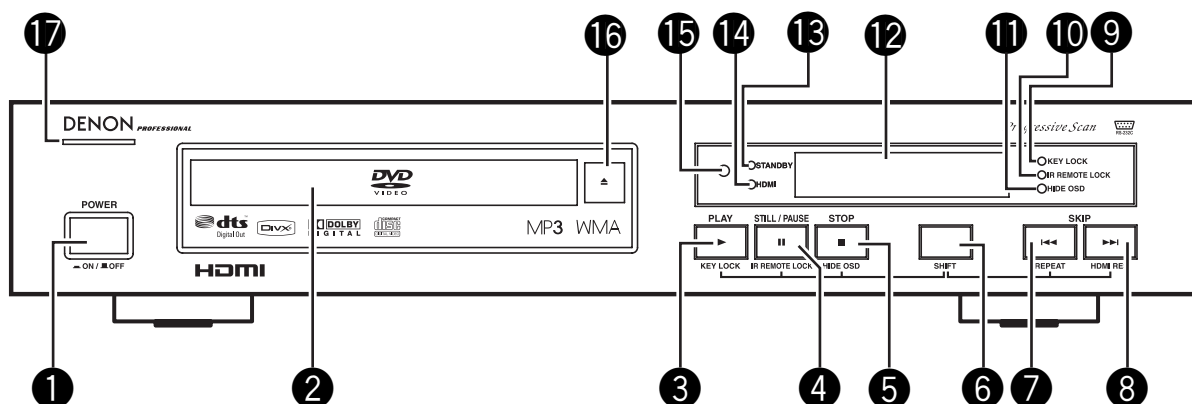

1 POWER button

- Press once to turn the power on.
- Press again to set to the "OFF" position and turn the power off.
- Set the power to the standby mode by pressing the POWER button on the remote control unit while the power is on.
- Turn the power on from the standby mode by pressing the POWER button on the remote control unit.

2 Disc tray

- Load discs here. (See page 19.)
- Press the OPEN/CLOSE button to open and close the disc tray.
- The disc tray is also closed when the PLAY button is pressed.

3 PLAY/KEY LOCK button (▶)

- Press this button to play the disc (See page 38.)
- Used in combination with the SHIFT button to turn the KEY LOCK mode on and off. (See page 66.)

4 STILL/PAUSE/IR REMOTE LOCK button (||)

- Press this button to pause images or music or to play images frame by frame. (See page 41.)
- Used in combination with the SHIFT button to turn the IR REMOTE LOCK mode on and off. (See page 66.)

5 STOP/HIDE OSD button (■)

- Press this to stop the disc. (See page 40.)
- Used in combination with the SHIFT button to turn the HIDE OSD mode on and off. (See page 67.)

6 SHIFT button

- Used in combination with other buttons to perform advanced functions. (See pages 24, 66, 67, 68.)

7 SKIP/REPEAT button (◀◀)

- Press this to move back to the beginning of the current track (or chapter).
- Press again to move back to the beginning of the previous track (or chapter). (See page 41.)
- Used in combination with the SHIFT button to switch the repeat mode. (See page 42.)

8 SKIP/HDMI RES. button (▶▶)

- Press this to move ahead to the beginning of the next track (or chapter). (See page 41.)
- Used in combination with the SHIFT button to switch the HDMI Resolution. (See page 24.)

9 KEY LOCK indicator

- Lights when the KEY LOCK mode is on.

10 IR REMOTE LOCK indicator

- Lights when the IR REMOTE LOCK mode is on.

11 HIDE OSD indicator

- Lights when the HIDE OSD mode is on.

12 Display

- Information on the disc that is currently playing is shown on the display. (See page 15.)

13 STANDBY indicator

- This lights when the power is in the standby mode.

14 HDMI indicator

- Lights when HDMI output is selected as AUTO, 480p, 720p, or 1080i. However, it only lights when AUTO is selected if the HDMI signal is output to TV.

15 Remote control sensor

16 OPEN/CLOSE button (▲)

- Press this button to open and close the disc tray. (See page 19.)

17 Power indicator

- This indicator lights when the power is on.

(2) Rear Panel

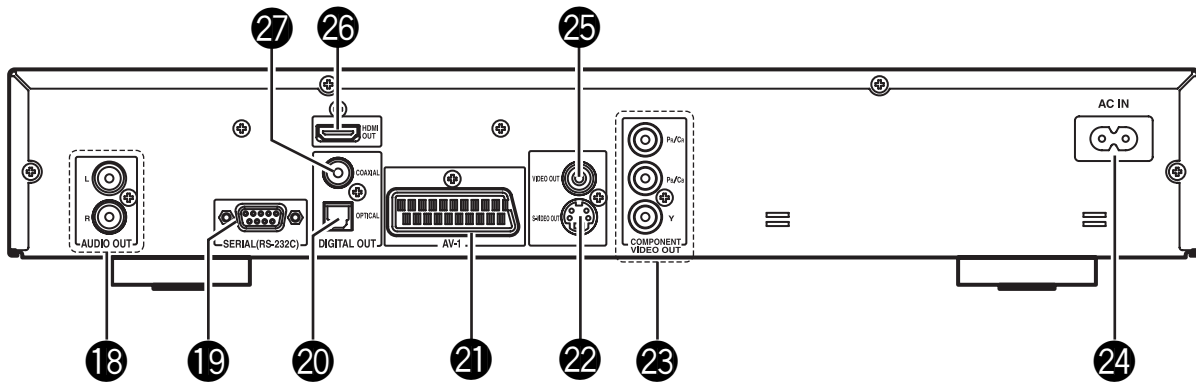

18 Audio output connectors (AUDIO OUT)

- Connect using the included audio cord.

19 SERIAL REMOTE terminal (DN-V310 only)

- This is the terminal for serial control from an external device.

20 Digital audio output connector (OPTICAL)

- Connect using an optical fiber cable (available in stores).
- Digital data is output from this connector.

21 21-pin SCART terminal (AV1) (Europe model only)

- Connect using a 21-pin SCART cable (available in stores).

22 S-Video output connector (S-VIDEO OUT)

- Connect using an S-Video connection cord (available in stores).

23 Component video output connectors (COMPONENT VIDEO OUT)

- Connect using the included video cords.

24 Power input (AC IN)

- Connect to AC power supply using the included power supply cord.
- The shape of AC INLET changes depending on the region of use. The figure above shows the Europe view. The USA view is a poled-type INLET.

25 Video output connector (VIDEO OUT)

- Connect using the included video cord.

26 HDMI output connector

- Connect using an HDMI cable (available in stores).
- HDMI output mode can be selected from the SETUP MENU or front keys. (See pages 23, 24.)

27 Digital audio output connector (COAXIAL)

- Connect using an digital audio cord. Connect a commercially available 75 Ω/ohms pin-plug cord.
- Digital data is output from this connector.

(3) Display

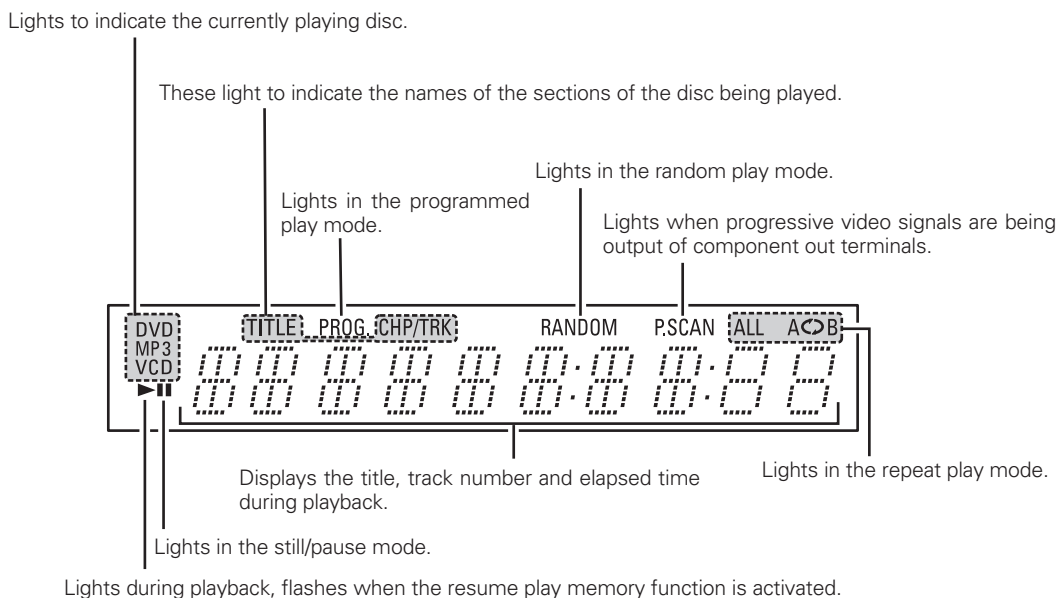

6 REMOTE CONTROL UNIT

■ The DN-V210/DN-V310 can be controlled from a distance using the included remote control unit (RC-963).

(1) Inserting Batteries

① Remove the remote control unit's rear cover.

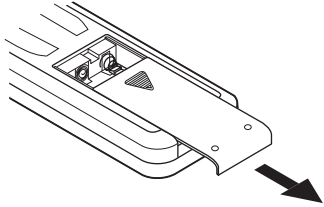

② Place two R03/AAA batteries in the battery compartment in the direction indicated by the marks.

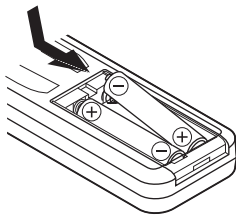

③ Close the rear cover.

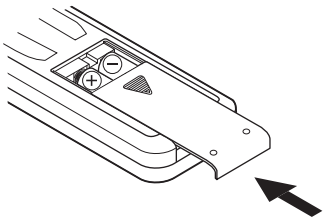

Cautions On Batteries

- Use R03/AAA batteries in this remote control unit.
- Replace the batteries with new ones approximately once a year, though this depends on the frequency with which the remote control unit is used.
- If the remote control unit does not operate from close to the main unit, replace the batteries with new ones, even if less than a year has passed.
- The included battery is only for verifying operation. Replace it with a new battery as soon as possible.
- When inserting the batteries, be careful to do so in the proper direction, following the < and > marks in the remote control unit's battery compartment.
- To prevent damage or battery fluid leakage:
 - Do not use a new battery with an old one.
 - Do not use two different types of batteries.
 - Do not short-circuit, disassemble, heat or dispose of batteries in flames.
- Remove the batteries when not planning to use the remote control unit for a long period of time.
- If the batteries should leak, carefully wipe off the fluid from the inside of the battery compartment, then insert new batteries.

(2) Using the Remote Control Unit

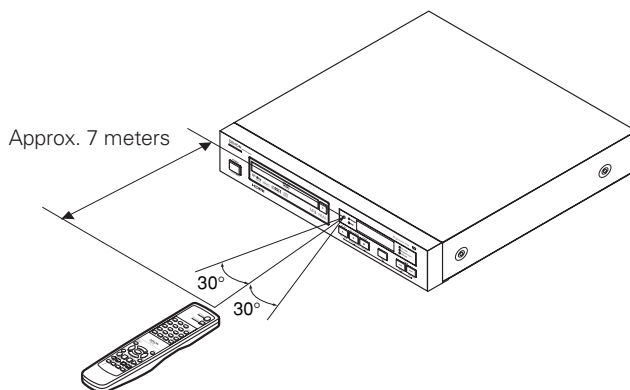

- When operating the remote control unit, point it at the remote control sensor as shown on the diagram.
- The remote control unit can be used from a direct distance of approximately 7 meters. This distance will be shorter, however, if there are obstacles in the way or if the remote control unit is not pointed directly at the remote control sensor.
- The remote control unit can be operated at a horizontal angle of up to 30° with respect to the remote control sensor.

NOTES:

- It may be difficult to operate the remote control unit if the remote control sensor is exposed to direct sunlight or strong artificial light.
- Do not press buttons on the main unit and on the remote control unit at the same time. Doing so will result in malfunction.

(3) Names and Functions of Remote Control Unit Buttons

■ Button not explained here function in the same way as the corresponding buttons on the main unit.

1 DVD POWER button

Press this to switch the power between on and standby.

2 Number buttons

Use these to input numbers.

Use the +10 button to input numbers of 10 or over.

Example: To input 25

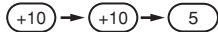

3 SUBTITLE button

Press this to switch the DVD's subtitle language.

4 AUDIO button

For DVDs, press this to switch the audio language. For video CDs, press this to switch the channel between "Left", "Right", "Mix" and "STEREO".

5 TOP MENU/PBC button

The top menu stored on the disc is displayed.

For video CDs, press this to switch the PBC function between "ON" and "OFF".

6 Cursor buttons/ENTER button

Use the ▲ and ▼ buttons to select in the vertical direction.

Use the ◀ and ▶ buttons to select in the horizontal direction.

Press the ENTER button to select the item selected with the cursor buttons.

7 ANGLE button

Press this to switch the angle.

8 DISPLAY button

Press this to display the ON-SCREEN.

9 STOP button (■)

10 SLOW/SEARCH buttons

11 SETUP button

Press this to display the default setting screen.

12 NTSC/PAL button

Use this to switch the set's video output format (NTSC/PAL/MULTI).

13 OPEN/CLOSE button

14 PROGRAM/DIRECT button (PROG/DIRECT)

For DVDs and Video CDs, press this to switch between the normal play, programmed play.

15 CALL button

Does not function on this model.

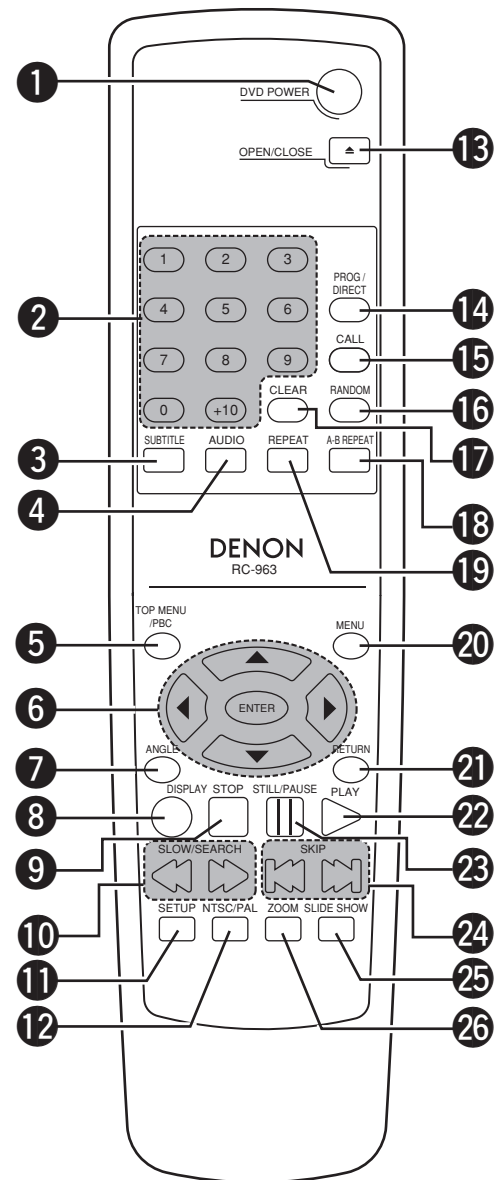

- 16 RANDOM button**
Press this to play the tracks on the video or music CD in random order.
- 17 CLEAR button**
Press this to clear numbers that you have input.
- 18 A-B REPEAT button (A-B)**
Use this to repeat sections between two specific points.
- 19 REPEAT button**
Press this to play tracks repeatedly.
- 20 MENU button**
The DVD menu stored on the disc is displayed.
- 21 RETURN button**
Press this to return to the no on screen display.
Press this to return from the menu screen to the previous screen when playing Video CDs in PBC playback.
- 22 PLAY button (▶)**
- 23 STILL/PAUSE button (II)**
- 24 SKIP buttons**
- 25 SLIDE SHOW button**
The way of switching to the next image during continuous JPEG image playback (SLIDE SHOW) can be selected.
- 26 ZOOM button**
Press this to enlarge the image.

7 LOADING DISCS

- Set discs in the disc tray with the labeled (printed) side facing up.

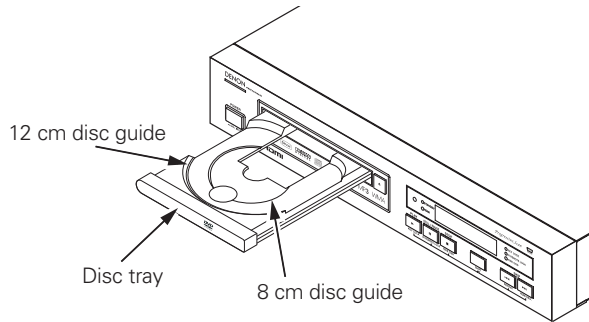

NOTE:

- Do not move the DN-V210/DN-V310 while a disc is playing. Doing so may scratch the disc.

(1) Opening and Closing the Disc Tray

- Turn on the power.
- Press the OPEN/CLOSE button.

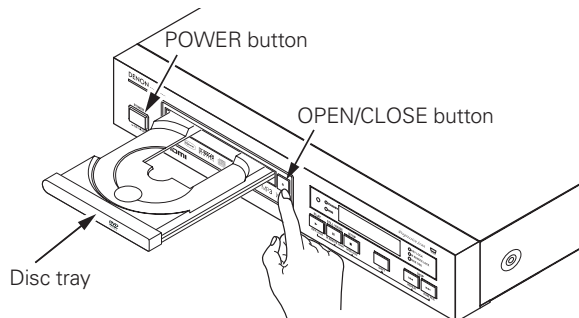

NOTES:

- Be sure to turn on the power before opening and closing the disc tray.
- Do not strike on the button with a pencil, etc.

(2) Loading Discs

- Pick up the disc carefully so as not to touch the signal surface and hold it with the labeled side facing up.
- With the disc tray fully open, set the disc in the disc tray.
- Set 12 cm discs in the outer tray guide (Figure 1), 8 cm discs in the inner tray guide (Figure 2).
- Press the OPEN/CLOSE button. The disc is automatically loaded.
- The disc tray can also be closed automatically to load the disc by pressing the PLAY button.

Figure 1

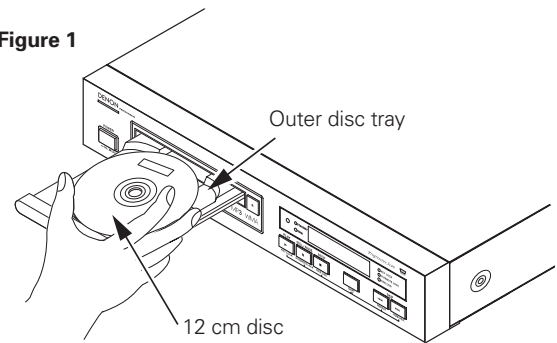
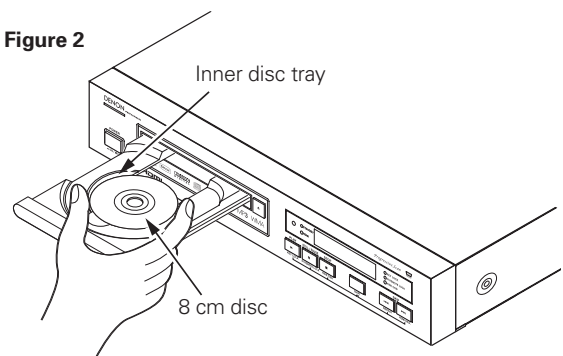

Figure 2







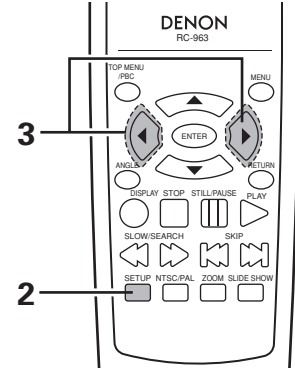
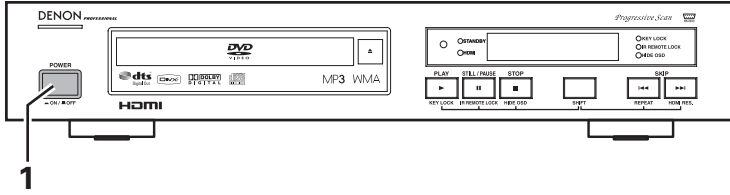

NOTES:

- If your foreign object is caught in the disc tray during closing, simply press the OPEN/CLOSE button again and the tray will open.
- Do not press the disc tray in by hand when the power is off. Doing so will damage it.
- Do not place foreign objects in the disc tray. Doing so will damage it.

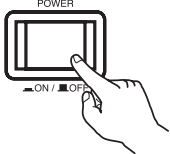
8 CHANGING THE DEFAULT SETTINGS

- Make the initial settings to suit your usage conditions before starting playback.
The initial settings are retained until they are next changed, even if the power is turned off.

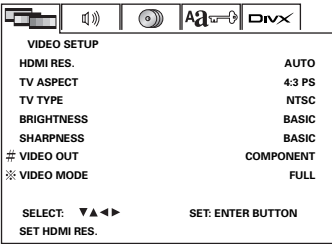
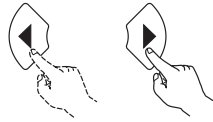

<p>1</p>	<p>Turn on the power.</p> <ul style="list-style-type: none"> Press the power button, the power indicator lights and the power turns on. 	 <p>Main unit</p>
<p>2</p>	<p>In the stop mode, press the SETUP button.</p> <ul style="list-style-type: none"> The setup (default settings) screen appears. <p>NOTE:</p> <ul style="list-style-type: none"> For some menus, the initial values can be changed during playback. <p>VIDEO SETUP </p> <p>Use this to set the DN-V210/DN-V310's screen mode. (HDMI RES., TV aspect, TV type, Brightness, Sharpness and Video output (Europe model only).)</p> <p>AUDIO SETUP </p> <p>Use this to set the DN-V210/DN-V310's audio output mode. (Digital and LPCM output settings.)</p> <p>DISC SETUP </p> <p>Use this to set the language to be used when playing the disc. If the set language is not offered on that disc, the discs default language is set.</p> <p>SYSTEM SETUP </p> <p>On-screen display language setting: The initial settings screen's language setting, etc., the viewing restriction level and playback of adult DVDs you do not want children, etc., to see can be restricted. The number of initial setting items can be increased.</p> <p>DivX SETUP </p> <p>You can check the initial DivX language setting and DivX video on demand.</p>	 <p>Remote control unit</p>  <p># : This item is displayed for Europe model only. * : This item is displayed for EXPERT mode. (See page 35.)</p>
<p>3</p>	<p>Use the ◀ and ▶ cursor buttons to select the desired setting item. Select "VIDEO SETUP". (See page 22.) Select "AUDIO SETUP". (See page 26.) Select "DISC SETUP". (See page 28.) Select "SYSTEM SETUP". (See page 33.) Select "DivX SETUP". (See page 36.)</p>	 <p>Remote control unit</p>
<p>* To exit the setup mode Press the SETUP button.</p>		

Setup items for use

Bold characters indicate factory defaults.

The mark of ✱ is indicated when SETUP MENU MODE is set up by an EXPERT.

VIDEO SETUP

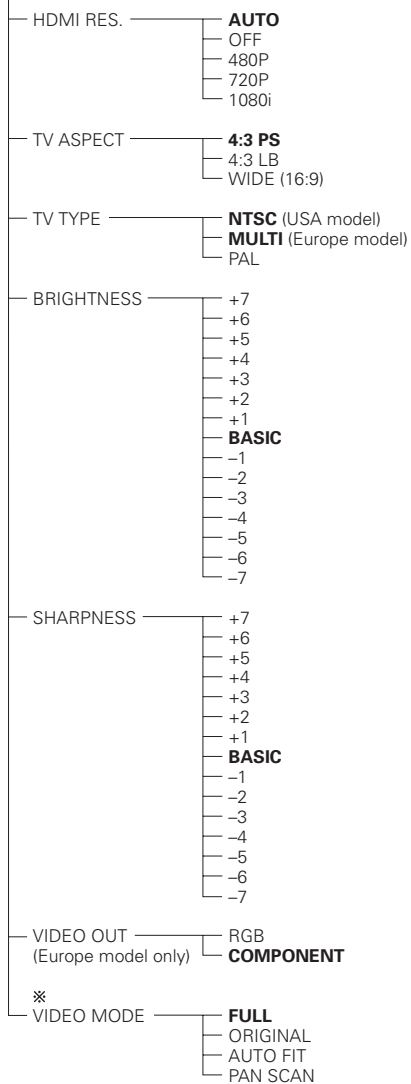

AUDIO SETUP

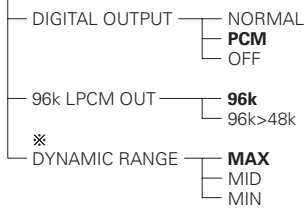

DISC SETUP

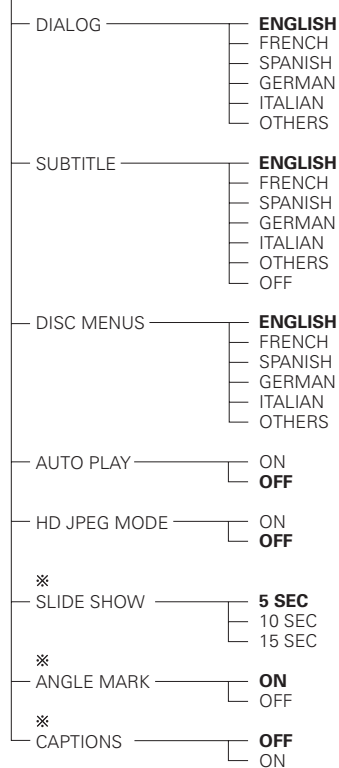

SYSTEM SETUP

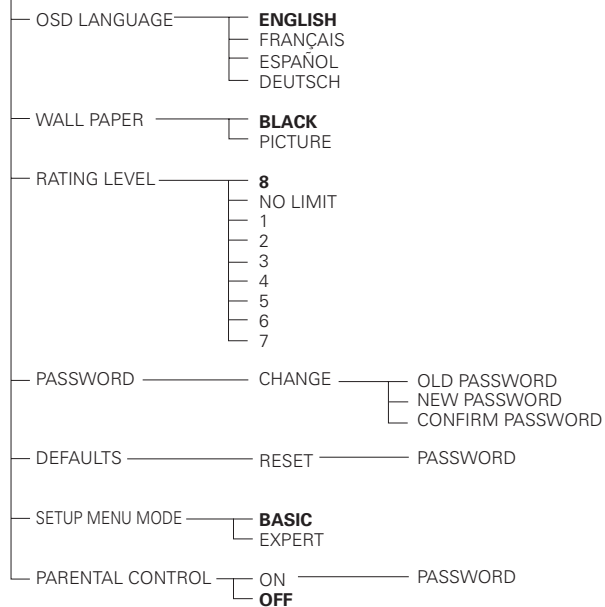

DivX SETUP

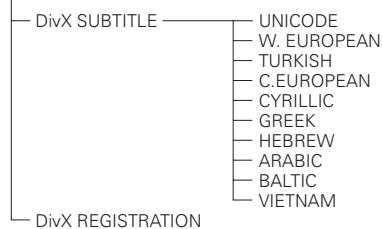

When "VIDEO SETUP" is selected

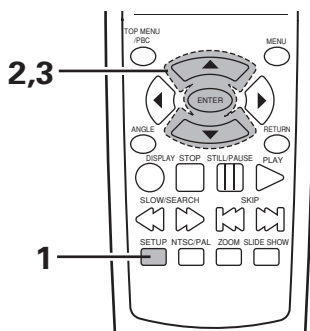

<p>1</p>	<p>Set the "VIDEO SETUP" in SETUP mode. (See page 20.)</p>																					
<p>2</p>	<p>Use the ▲ and ▼ cursor buttons to select the desired setting.</p> <p>HDMI RES. Use this to select whether HDMI output is ON/OFF, and the resolution. Interlace or Progressive can be selected for Component output.</p> <p>TV ASPECT Use this to set the shape of your TV's screen.</p> <p>TV TYPE Use this to set your TV's video format (NTSC, PAL or MULTI).</p> <p>BRIGHTNESS Use this to adjust the screen brightness.</p> <p>SHARPNESS Use this to adjust the screen sharpness.</p> <p>VIDEO OUT (Europe model only) Set the connector from which interlaced signals are to be output (RGB or COMPONENT).</p> <p>VIDEO MODE The play DVD video, select the desired video mode (AUTO FIT, FULL, ORIGINAL, PAN SCAN).</p> <p>NOTES:</p> <ul style="list-style-type: none"> The video mode is displayed when the "SETUP MENU MODE" at "SYSTEM SETUP" is set to "EXPERT". 	<div data-bbox="1149 720 1307 892" data-label="Image"> </div> <p>Remote control unit</p> <div data-bbox="1062 1096 1393 1339" data-label="Image"> <table border="1"> <tr> <td colspan="2">VIDEO SETUP</td> </tr> <tr> <td>HDMI RES.</td> <td>AUTO</td> </tr> <tr> <td>TV ASPECT</td> <td>4:3 PS</td> </tr> <tr> <td>TV TYPE</td> <td>NTSC</td> </tr> <tr> <td>BRIGHTNESS</td> <td>BASIC</td> </tr> <tr> <td>SHARPNESS</td> <td>BASIC</td> </tr> <tr> <td># VIDEO OUT</td> <td>COMPONENT</td> </tr> <tr> <td>※ VIDEO MODE</td> <td>FULL</td> </tr> <tr> <td>SELECT: ▼▲▶◀</td> <td>SET: ENTER BUTTON</td> </tr> <tr> <td>SET HDMI RES.</td> <td></td> </tr> </table> </div> <p># : VIDEO OUT is Europe model only.</p>	VIDEO SETUP		HDMI RES.	AUTO	TV ASPECT	4:3 PS	TV TYPE	NTSC	BRIGHTNESS	BASIC	SHARPNESS	BASIC	# VIDEO OUT	COMPONENT	※ VIDEO MODE	FULL	SELECT: ▼▲▶◀	SET: ENTER BUTTON	SET HDMI RES.	
VIDEO SETUP																						
HDMI RES.	AUTO																					
TV ASPECT	4:3 PS																					
TV TYPE	NTSC																					
BRIGHTNESS	BASIC																					
SHARPNESS	BASIC																					
# VIDEO OUT	COMPONENT																					
※ VIDEO MODE	FULL																					
SELECT: ▼▲▶◀	SET: ENTER BUTTON																					
SET HDMI RES.																						

Press the ENTER button to decide the menu item.

① When "HDMI RES." (HDMI Resolution) is selected:
Use the ▲ and ▼ cursor buttons to select the HDMI out, press the ENTER button to decide.

- **AUTO**: When HDTV and HDMI are connected, some TVs may automatically decide the appropriate HDMI RES.
- **OFF**: HDMI is turned OFF. When this is set, Component Video output switches to Interlace.
- **480p/576p**: HDMI switches ON, and the output resolution is 480p/576p. When this is set, Component Video output switches to Progressive. P.SCAN lights on the display.
- **720p**: HDMI switches ON, and the output resolution is 720p. No output signals are output from Video out, S-Video out, or Component out.
- **1080i**: HDMI switches ON, and the output resolution is 1080i. No output signals are output from Video out, S-Video out, or Component out.

The relationships between the HDMI RES. settings, the output signals from each of the video output connectors, and the display in each of the conditions are shown below.

Video Output Connector	HDMI RES. setting				
	AUTO	OFF	480p	720p	1080i
VIDEO	480i/-	480i	480i	—	—
S-VIDEO	480i/-	480i	480i	—	—
COMPONENT	480i/-	480i	480p	—	—
RGB (SCART) (Europe model only)	480i/-	480i	480i	—	—
HDMI	480p 720p 1080i	—	480p	720p	1080i
Display					
HDMI LED	-/Lights	—	Lights	Lights	Lights
P.SCAN (Display for Component)	—	—	Lights	—	—

- **AUTO** is output when the HDMI connector is connected to a HDTV and the TV power is ON. The TV automatically selects one of 480p/576p/720p/1080i. If 720p or 1080i is selected, no video signals are output from any of the video connectors other than HDMI. Occasionally the TV may not automatically select the appropriate output or other trouble. If this occurs select a different setting to AUTO.
- When set to **OFF**, the **COMPONENT** output switches to interlaced output.
- When set to **480p/576p**, the **COMPONENT** output switches to progressive output.
- **480i/480p** is for NTSC. **576i/576p** is for PAL.

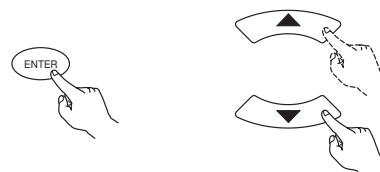

Remote control unit

Remote control unit

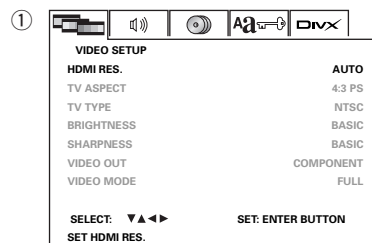

CONSUMERS SHOULD NOTE THAT NOT ALL HIGH DEFINITION TELEVISION SETS ARE FULLY COMPATIBLE WITH THIS PRODUCT AND MAY CAUSE ARTIFACTS TO BE DISPLAYED IN THE PICTURE. IN CASE OF 525 OR 625 PROGRESSIVE SCAN PICTURE PROBLEMS, IT IS RECOMMENDED THAT THE USER SWITCH THE CONNECTION TO THE "STANDARD DEFINITION" OUTPUT.

3

3

Switching HDMI RES. on the main unit:

Press and hold the SHIFT and ►► buttons for 3 seconds.
The current status is shown in the display for 2 seconds.
Continue holding down the SHIFT button and press the HDMI RES. button to switch the status.

The status display is shown for 2 seconds in the display.

- When RGB (SCART) is selected, switching is not possible. RGB appears on the display if you press the button. (See page 25.) (Europe model only)

② When "TV ASPECT" is selected:

Use the ▲ and ▼ cursor buttons to select the aspect, press the ENTER button to decide.

4:3 PS (Factory default)

Select this to play wide DVDs in the pan & scan mode (with the sides of the picture cut off). Discs for which pan & scan is not specified are played in the letter box mode.

4:3 LB

Select this to play wide DVDs in the letter box mode (with black strips at the top and bottom).

WIDE (16:9)

Select this to play wide DVDs in the full-screen mode.

③ When "TV TYPE" is selected:

Use the ▲ and ▼ cursor buttons to select the TV type, press the ENTER button to decide.

NTSC (Factory default : USA model)

Select this when your TV's video format is NTSC.
If NTSC is selected, output format is fixed to NTSC.

MULTI (Factory default : Europe model)

Select this when your TV is compatible with both the NTSC and PAL formats.

If you play the disc recorded NTSC format, signal from video output terminal will be switched to NTSC is selected, output format is fixed to NTSC.

PAL

Select this when your TV's video format is PAL.
If PAL is selected, output format is fixed to PAL.

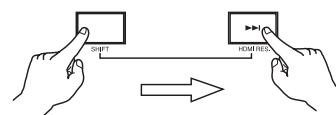

Main unit

Main unit display

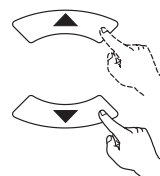
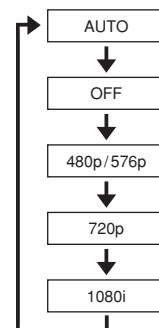

Remote control unit



Remote control unit

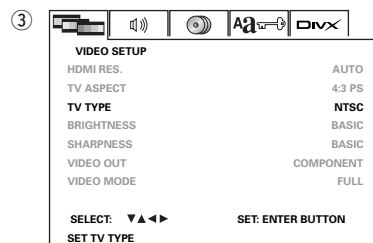
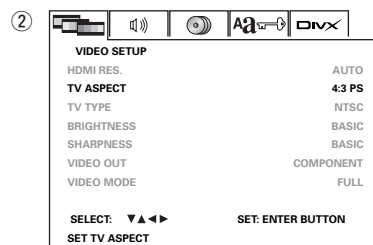

3

- ④ When "BRIGHTNESS" is selected:
 Use the ▲ and ▼ cursor buttons to select the level, press the ENTER button to decide.
 The factory default setting is BASIC. The screen brightness can be adjusted in steps from +7 to -7. The brightness settings will differ depending on the model of your TV. Set to suit your TV.
- ⑤ When "SHARPNESS" is selected:
 Use the ▲ and ▼ cursor buttons to select the level, press the ENTER button to decide.
 The factory default setting is BASIC. The screen sharpness can be adjusted in steps from +7 to -7. The sharpness settings will differ depending on the model of your TV. Set to suit your TV.
- ⑥ When "VIDEO OUT" is selected: (Europe model only)
 Use the ▲ and ▼ cursor buttons to select the video out, press the ENTER button several times and select the video out.
RGB
 Video signals are output from the SCART (AV-1) terminal by RGB.
COMPONENT (Factory default)
 Video signals are output from the color component output connectors.
- ⑦ When "VIDEO MODE" is selected:
 Use the ▲ and ▼ cursor buttons to select the video mode, press the ENTER button to decide.
FULL
 The video is displayed with the size adjusted to full screen.
ORIGINAL
 The video is displayed in its original size.
AUTO FIT (Factory default)
 The video is displayed with the size automatically adjusted so there is no distortion. A black band may appear at the right and left sides or the at top and bottom.
PANSCAN
 Select when you connect a 4:3 television to this device. A section of the video on one or both sides of the screen is cut.

NOTE:

- If stripes of noise appear on the picture or the picture is unclear when playing a specific DVD video disc, try changing the video mode.

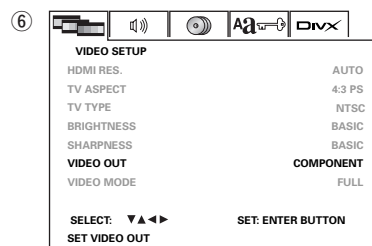
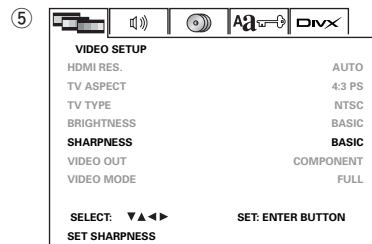

*** To exit the setup mode**

Press the SETUP button.

When "AUDIO SETUP" is selected

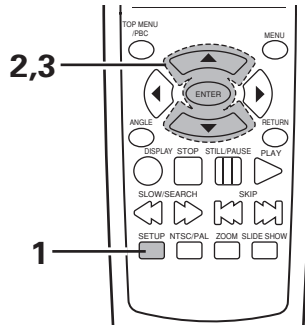

<p>1</p>	<p>Set the "AUDIO SETUP" in SETUP mode. (See page 20.)</p>	
<p>2</p>	<p>Use the ▲ and ▼ cursor buttons to select the desired setting.</p> <p>DIGITAL OUTPUT Use this to select the digital output's signal format.</p> <p>96k LPCM OUT Use this to set the digital audio output when playing DVDs recorded in linear PCM audio.</p> <p>DYNAMIC RANGE This has the effect of reducing the size difference between audio outputs. Even if the audio output is set to MIN, you can still hear audio or conversations.</p> <p>NOTE:</p> <ul style="list-style-type: none"> Dynamic range is displayed when the "SETUP MENU MODE" at "SYSTEM SETUP" is set to "EXPERT". 	<p>Remote control unit</p>
<p>3</p>	<p>Press the ENTER button to decide the menu item.</p> <p>① When "DIGITAL OUTPUT" is selected: Use the ▲ and ▼ cursor buttons to select the output format, press the ENTER button to decide.</p> <p>NORMAL When playing DVDs recorded in Dolby Digital or DTS, bitstream signals are output from the digital audio output terminals. When playing DVDs recorded in linear PCM, linear PCM signals are output.</p> <p>Select "NORMAL" when making digital connections to an AV amplifier with built-in Dolby Digital and DTS decoder.</p> <p>PCM (Factory default) When playing Dolby Digital bitstream signals or DVDs recorded in linear PCM, the signals are converted into 48 kHz/16-bit PCM (2-channel) signals and output from the digital outputs. When playing DVDs recorded in PCM, linear PCM signals are output.</p> <p>OFF Digital audio is not output.</p>	<p>Remote control unit</p> <p>Remote control unit</p> <p>①</p>

3

② When "96k LPCM OUT" is selected:
Use the ▲ and ▼ cursor buttons to select the conversion mode, press the ENTER button to decide.

96k (Factory default)

When playing linear PCM DVDs that are not copyright-protected, for 2-channel PCM audio signals up to 96 kHz, linear PCM signals are output as such without being converted from the digital outputs.

PCM signals of 48 kHz/16 bits and lower are output, regardless of whether they are copyright-protected or not.

For DVDs containing multi-channel PCM signals, the digital signals are down-mixed for output into two channels, front left and right. (Only the front left and right channels are output for sources for which down-mixing is prohibited.)

When playing copyright-protected linear PCM DVDs, in consideration of copyrights, no digital signals are output for sources exceeding 48 kHz/16 bits. When playing such sources, either set to "96k>48k" or make analog connections. (See page 10.)

96k>48k

Linear PCM and packed PCM signals are converted to 44.1 kHz or 48 kHz and output. (The PCM digital audio output signals are converted to 48 kHz or less in consideration of copyrights.) When making digital connections to an AV amplifier that is not compatible with 96 kHz/88.2 kHz signals, set to "96k>48k".

When playing DVDs recorded in linear PCM or packed PCM and the unit is set to output digital and analog audio signals simultaneously, the analog audio output signals are also converted to 48 kHz or below, so we recommend setting to "96k" and also making analog connections.

③ When "DYNAMIC RANGE" is selected:
Use the ▲ and ▼ cursor buttons to select the "ON" or "OFF", press the ENTER button to decide.

MAX (Factory default)

Dynamic range control is not operating. You can hear the original audio.

MID

Dynamic range control operates at the mid-level. The size difference between sounds becomes a little smaller.

MIN

Dynamic range control operates at the maximum level. The size difference between sounds is reduced to the smallest level.

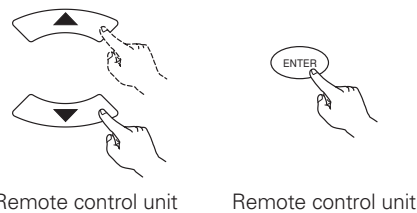

Remote control unit

Remote control unit

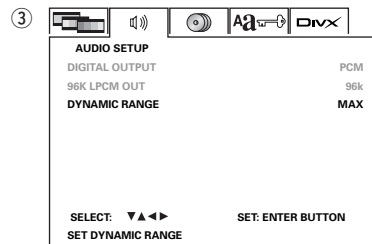
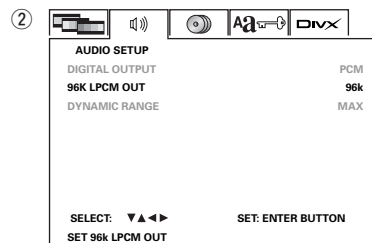

*** To exit the setup mode**

Press the SETUP button.

When "DISC SETUP" is selected

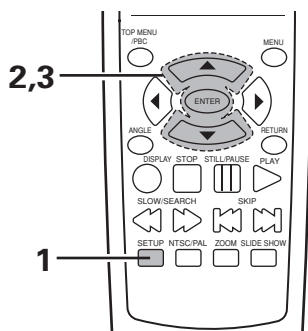

<p>1</p>	<p>Set the "DISC SETUP" in SETUP mode. (See page 20.)</p>																							
<p>2</p>	<p>Use the ▲ and ▼ cursor buttons to select the desired setting.</p> <p>DIALOG Use this to set the language of the sound output from the speakers.</p> <p>SUBTITLE Use this to set the language of the subtitles displayed on the TV.</p> <p>DISC MENUS Use this to set the language of the menus recorded on the disc (top menu, etc.).</p> <p>AUTO PLAY It is possible to start playback automatically after the power is turned on.</p> <p>HD JPEG MODE Use this to change the resolution of JPEG images.</p> <p>SLIDE SHOW The time interval for switching to the next still picture when playing slide shows of still pictures (in JPEG format) can be set.</p> <p>ANGLE MARK Angle marks are displayed/not displayed on the screen.</p> <p>CAPTIONS Use this to set whether or not to display the closed captions recorded on DVDs.</p> <p>NOTE:</p> <ul style="list-style-type: none"> • Angle marks and captions are displayed when "SET UP MENU MODE" at "SYSTEM SETUP" is set to "EXPERT". 	<div data-bbox="1136 819 1315 1008" data-label="Image"> </div> <p data-bbox="1136 1018 1315 1050">Remote control unit</p> <div data-bbox="1055 1092 1396 1344" data-label="Image"> <table border="1"> <tr> <td colspan="2">DISK SETUP</td> </tr> <tr> <td>DIALOG</td> <td>ENGLISH</td> </tr> <tr> <td>SUBTITLE</td> <td>ENGLISH</td> </tr> <tr> <td>DISC MENUS</td> <td>ENGLISH</td> </tr> <tr> <td>AUTO PLAY</td> <td>ON</td> </tr> <tr> <td>HD JPEG MODE</td> <td>OFF</td> </tr> <tr> <td>※ SLIDE SHOW</td> <td>5SEC</td> </tr> <tr> <td>※ ANGLE MARK</td> <td>ON</td> </tr> <tr> <td>※ CAPTIONS</td> <td>OFF</td> </tr> <tr> <td>SELECT: ▼▲◀▶</td> <td>SET: ENTER BUTTON</td> </tr> <tr> <td>SET DIALOG</td> <td></td> </tr> </table> </div>	DISK SETUP		DIALOG	ENGLISH	SUBTITLE	ENGLISH	DISC MENUS	ENGLISH	AUTO PLAY	ON	HD JPEG MODE	OFF	※ SLIDE SHOW	5SEC	※ ANGLE MARK	ON	※ CAPTIONS	OFF	SELECT: ▼▲◀▶	SET: ENTER BUTTON	SET DIALOG	
DISK SETUP																								
DIALOG	ENGLISH																							
SUBTITLE	ENGLISH																							
DISC MENUS	ENGLISH																							
AUTO PLAY	ON																							
HD JPEG MODE	OFF																							
※ SLIDE SHOW	5SEC																							
※ ANGLE MARK	ON																							
※ CAPTIONS	OFF																							
SELECT: ▼▲◀▶	SET: ENTER BUTTON																							
SET DIALOG																								

Press the ENTER button to decide the menu item.

① When "DIALOG" is selected:

Use the ▲ and ▼ cursor buttons to select the language, press the ENTER button to decide.

ENGLISH (Factory default)

Select this when you want to play the DVD with the sound in English.

FRENCH

Select this when you want to play the DVD with the sound in French.

SPANISH

Select this when you want to play the DVD with the sound in Spanish.

GERMAN

Select this when you want to play the DVD with the sound in German.

ITALIAN

Select this when you want to play the DVD with the sound in Italian.

OTHERS

Use the number buttons to input the language number.

(See "Language code list" on page 32.)

3

② When "SUBTITLE" is selected:

Use the ▲ and ▼ cursor buttons to select the language, press the ENTER button to decide.

ENGLISH (Factory default)

Select this when you want to play the DVD with the subtitles in English.

FRENCH

Select this when you want to play the DVD with the subtitles in French.

SPANISH

Select this when you want to play the DVD with the subtitles in Spanish.

GERMAN

Select this when you want to play the DVD with the subtitles in German.

ITALIAN

Select this when you want to play the DVD with the subtitles in Italian.

OTHERS

Use the number buttons to input the language number.

(See "Language code list" on page 32.)

OFF

Select this if you do not want to display the subtitles. (For some discs it is not possible to turn off the subtitle display.)

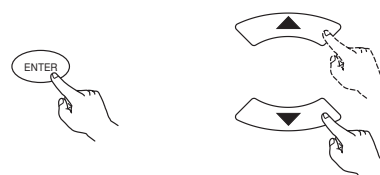

Remote control unit

Remote control unit

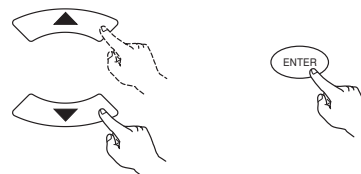
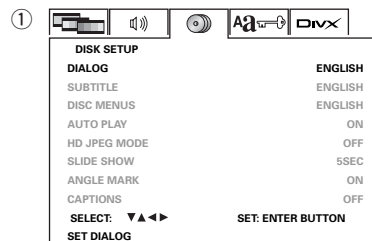

Remote control unit

Remote control unit

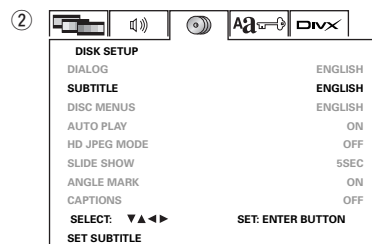

- ③ When "DISC MENUS" is selected:
Use the ▲ and ▼ cursor buttons to select the language, press the ENTER button to decide.
- ENGLISH (Factory default)**
Select this when you want to display the menus in English.
- FRENCH**
Select this when you want to display the menus in French.
- SPANISH**
Select this when you want to display the menus in Spanish.
- GERMAN**
Select this when you want to display the menus in German.
- ITALIAN**
Select this when you want to display the menus in Italian.
- OTHERS**
Use the number buttons to input the language number.
(See "Language code list" on page 32.)
- ④ When "AUTO PLAY" is selected:
OFF (Factory default)
After turning on the power, press the PLAY button to start playing the disc.
- ON**
After the power turns on, disc playback starts automatically.
- A playable disc must be loaded for this function to work.
 - Playback of the main program begins. The menu screen is not displayed.
 - The resume play function is disabled.
 - If the repeat play mode, random play mode, etc., was set when the power was last turned off, playback starts with those settings.
 - If the KEY LOCK mode, IR REMOTE LOCK mode, HIDE OSD mode, etc., were turned on when the power was last turned off, playback starts with those settings.
- ⑤ When "HD JPEG MODE" is selected.
OFF (Factory default)
The JPEG image resolution is fixed at 480p.
- ON**
JPEG images are displayed in the most suitable resolution.
- Connect a HDTV to the HDMI connector, and select the HDMI resolution to 720p/1080i.
 - The size of the image changes depending on the size of the JPEG file.
- ⑥ When "SLIDE SHOW" is selected:
Use the ▲ and ▼ cursor buttons to select the slide switching interval, press the ENTER button to decide.
The time interval can be set within 5, 10 and 15 seconds. (The factory default setting is 5 seconds.)

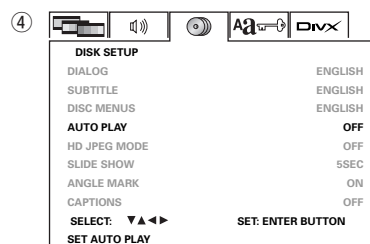
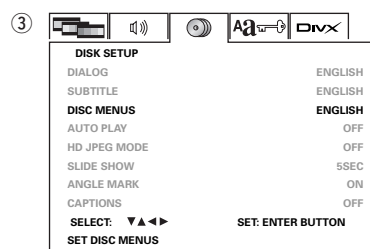

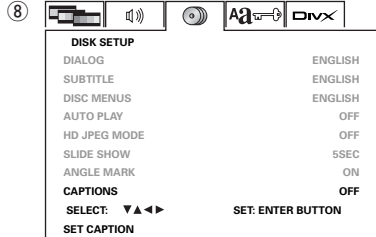
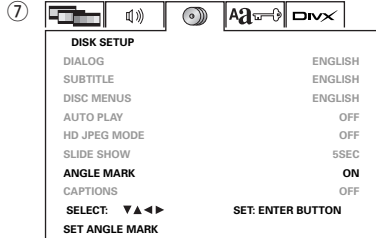

3

- ⑦ When "ANGLE MARK" is selected:
Use the ▲ and ▼ cursor buttons to select "ON" or "OFF", press the ENTER button to decide.
ON (factory default)
The angle mark is displayed when scenes at which angles are recorded are played.
OFF
The angle mark is not displayed, even when scenes at which angles are recorded are played.
- ⑧ When "CAPTIONS" is selected:
Use the ▲ and ▼ cursor buttons to select "ON" or "OFF", press the ENTER button to decide.
OFF (Factory default)
Select this when you do not want to display the captions on the screen when playing DVDs containing English captions
ON
Select this to display the captions on the screen when playing DVDs containing English captions.



*** To exit the setup mode**
Press the SETUP button.

NOTES:

- An English caption decoder is required to display English captions.
- DVDs with caption signals are indicated by the , ,  mark.
English captions cannot be displayed when playing DVDs which do not contain caption signals.
- The characters in which the captions are displayed (capital letters, small letters, italics, etc.) depend on the DVD and cannot be selected with the DN-V210/DN-V310.

Language code list

Code	Language	Code	Language	Code	Language	Code	Language
6565	Afar	7079	Faroese	7678	Lingala	8375	Slovak
6566	Abkhazian	7082	French	7679	Laothian	8376	Slovenian
6570	Afrikaans	7089	Frisian	7684	Lithuanian	8377	Samoaan
6577	Ameharic	7165	Irish	7686	Latvian, Lettish	8378	Shona
6582	Arabic	7168	Scots Gaelic	7771	Malagasy	8379	Somali
6583	Assamese	7176	Galician	7773	Maori	8381	Albanian
6588	Aymara	7178	Guarani	7775	Macedonish	8382	Serbian
6590	Azerbaijani	7185	Gujarati	7776	Malayalam	8385	Sundanese
6665	Bashkir	7265	Hausa	7778	Mongolian	8386	Swedish
6669	Byelorussian	7273	Hindi	7779	Moldavian	8387	Swahili
6671	Bulgarian	7282	Croatian	7782	Marathi	8465	Tamil
6672	Bihari	7285	Hungarian	7783	Malay	8469	Telugu
6678	Bengali; Bangla	7289	Armenian	7784	Maltese	8471	Tajik
6679	Tibetan	7365	Interlingua	7789	Burmese	8472	Thai
6682	Breton	7378	Indonesian	7865	Nauru	8473	Tigrinya
6765	Catalan	7383	Icelandic	7869	Nepali	8475	Turkmen
6779	Corsican	7384	Italian	7876	Dutch	8476	Tagalog
6783	Czech	7387	Hebrew	7879	Norwegian	8479	Tonga
6789	Welsh	7465	Japanese	7982	Oriya	8482	Turkish
6865	Danish	7473	Yiddish	8065	Panjabi	8484	Tatar
6869	German	7487	Javanese	8076	Polish	8487	Twi
6890	Bhutani	7565	Georgian	8083	Pashto, Pushto	8575	Ukrainian
6976	Greek	7575	Kazakh	8084	Portuguese	8582	Urdu
6978	English	7576	Greenlandic	8185	Quechua	8590	Uzbek
6979	Esperanto	7577	Cambodian	8277	Rhaeto-Romance	8673	Vietnamese
6983	Spanish	7578	Kannada	8279	Romanian	8679	Volapük
6984	Estonian	7579	Korean	8285	Russian	8779	Wolof
6985	Basque	7583	Kashmiri	8365	Sanskrit	8872	Xhosa
7065	Persian	7585	Kurdish	8368	Sindhi	8979	Yoruba
7073	Finnish	7589	Kirghiz	8372	Serbo-Croatian	9072	Chinese
7074	Fiji	7665	Latin	8373	Singhalese	9085	Zulu

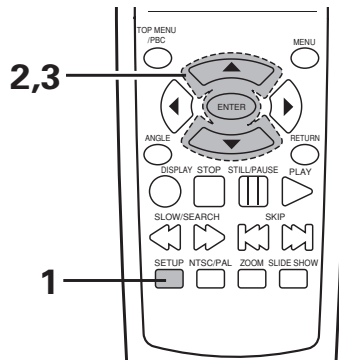

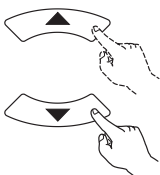
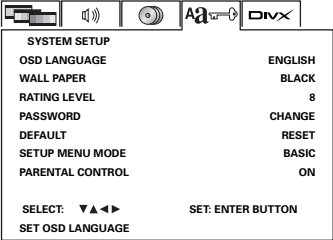
<p>1</p>	<p>Set the "SYSTEM SETUP" in SETUP mode. (See page 20.)</p>	
<p>2</p>	<p>Use the ▲ and ▼ cursor buttons to select the desired setting.</p> <p>OSD LANGUAGE Use this to set the language for the default setting screen and messages displayed on the TV screen ("PLAY", etc.)</p> <p>WALL PAPER Use this to select the image to be shown on the screen in the stop mode.</p> <p>RATING LEVEL Use this to restrict playback of adult DVDs you do not want children to view. Note that even with adult DVDs, viewing cannot be restricted unless the restriction level is recorded on the disc. It is however possible to disable playback of all DVDs.</p> <p>PASSWORD Use this to change the password. The set's password is set to "5555" by default.</p> <p>DEFAULT Use this to restore settings changed at "INITIAL SETTINGS" to their original (default) values.</p> <p>SETUP MENU MODE The number of initial setting items can be increased.</p> <p>PARENTAL CONTROL Use this to set PARENTAL CONTROL to ON or OFF.</p>	 <p>Remote control unit</p> 

Press the ENTER button to decide the menu item.

- ① When "OSD LANGUAGE" is selected:

Use the ▲ and ▼ cursor buttons to select the language, press the ENTER button to decide.

ENGLISH (Factory default)

Select this to set the OSD language to English.

FRANÇAIS

Select this to set the OSD language to French.

ESPAÑOL

Select this to set the OSD language to Spanish.

DEUTSCH

Select this to set the OSD language to German.

- ② When "WALL PAPER" is selected:

Use the ▲ and ▼ cursor buttons to select the background mode, press the ENTER button to decide.

BLACK (Factory default)

Select this to display a black background on the TV display.

PICTURE

Select this to display the wallpaper on the TV display.

This wallpaper can be changed at the user's discretion.

(See page 68.)

- ③ When "RATING LEVEL" is selected:

1. Press the ENTER button.

2. Use the number buttons to input the password (a 4-digit number), then press the ENTER button.

- The password is initially set to "5555".
- The password can be changed by changing it to a new password at "PASSWORD". (See below.)

3. Use the ▲ and ▼ cursor buttons to select "LEVEL", press the ENTER button to decide.

LEVEL 8 (factory default)

LEVEL 1 to 7

The lower the level, the stricter the restrictions.

NO LIMIT

Select this when you want to play all DVDs (for adults, general audiences and children).

- ④ When "PASSWORD" is selected:

1. Press the ENTER button.

2. Use the number buttons to input the previously set password (a 4-digit number), next input the new password, then input the new password again, and finally press the ENTER button.

- The password is initially set to "5555".
- Be careful not to forget the password.
- The settings cannot be changed until the proper password is input.

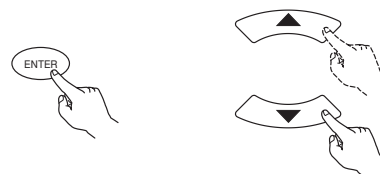

Remote control unit

Remote control unit

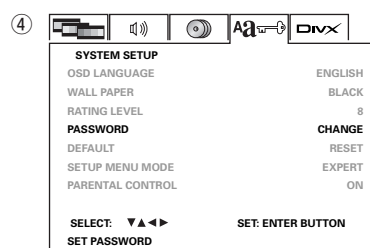
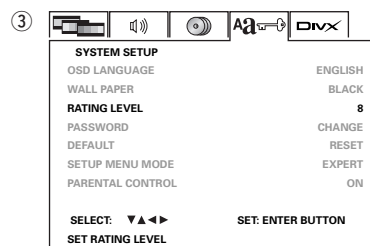
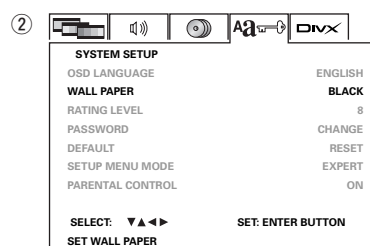
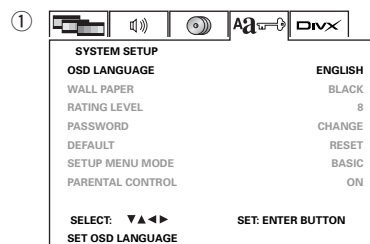

3

- ⑤ When "DEFAULTS" is selected:
1. Press the ENTER button.
 2. Use the number buttons to input the "8888", then press the ENTER button. The settings that have been changed at "INITIAL SETTINGS" are restored to their initial (default) values.

- ⑥ When "SETUP MENU MODE" is selected:
- Use the ▲ and ▼ cursor buttons to select the setup mode, press the ENTER button to decide.

**BASIC (Factory default)
EXPERT**

The number of setting items for the various settings can be increased.

3

- ⑦ When "PARENTAL CONTROL" is selected:
1. Press the ENTER button.
 2. Use the number buttons to input the password (a 4-digit number), then press the ENTER button.
 - The password is initially set to "5555".
 3. Use the ▲ and ▼ cursor buttons to select parental control "ON or OFF", press the ENTER button to decide.

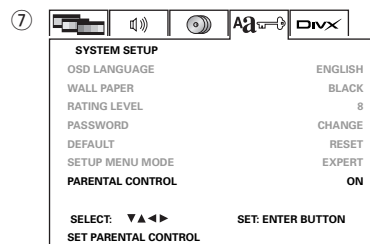
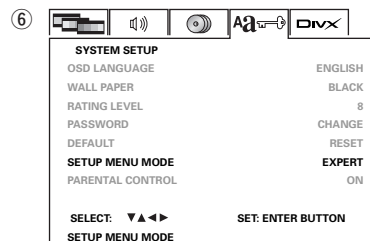
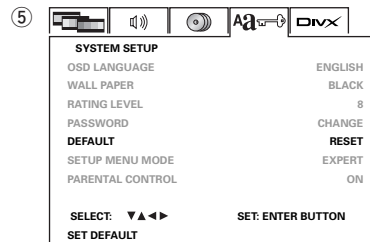

*** To exit the setup mode**

Press the SETUP button.

When "DivX SETUP" is selected

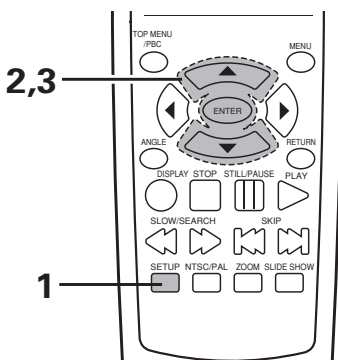

<p>1</p>	<p>Set the "DivX SETUP" in SETUP mode. (See page 20.)</p>	
<p>2</p>	<p>Use the ▲ and ▼ cursor buttons to select the desired setting.</p> <p>DivX SUBTITLE Set which language to be initially displayed when playing back a DivX® video disc.</p> <p>DivX REGISTRATION Acquires the DivX registration card of the DVD video player that you purchased.</p>	<p>Remote control unit</p>
<p>3</p>	<p>Press the ENTER button to decide the menu item.</p> <p>① When "DivX SUBTITLE" is selected: Use the ▲ and ▼ cursor buttons to select the language, press the ENTER button to decide.</p> <p>UNICODE Standard character code able to process multiple languages, and includes most characters for all of the major languages.</p> <p>W. EUROPEAN Albanian, Breton, Catalanian, Danish, Dutch, English, Faroese, Finnish, French, Gaelic, German, Icelandic, Irish, Italian, Norwegian, Portuguese, Spanish, Swedish</p> <p>TURKISH Albanian, Danish, Dutch, English, Finnish, French, Gaelic, German, Italian, Celtic (Latin), Norwegian, Portuguese, Spanish, Swedish, Turkish</p>	<p>①</p>

3

C. EUROPEAN

Albanian, Croatian, Czech, Dutch, English, German, Hungarian, Irish, Polish, Rumanian, Slovenian, Serbian

CYRILLIC

Bulgarian, Belarusian, English, Macedonian, Moldavian, Russian, Serbian, Ukrainian

GREEK

English, modern Greek

HEBREW

English, modern Hebrew

ARABIC

Arabic

BALTIC

Baltic

VIETNAM

Vietnamese

- These cannot be set if there are no subtitles recorded on the DivX® disc.
- Subtitle files with the following extensions can be set.
sut, sub, txt, smd, ssa, ass, psp

② When "DivX REGISTRATION" is selected:

1. Press the ENTER button.
 2. The registration code is displayed.
 - The acquired code is for on demand DivX® video only.
- Do not use the same code for a different application or website.

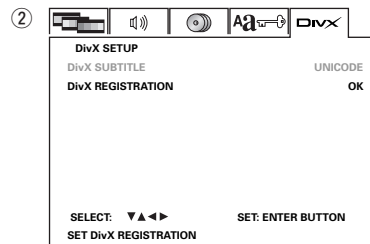

*** To exit the setup mode**



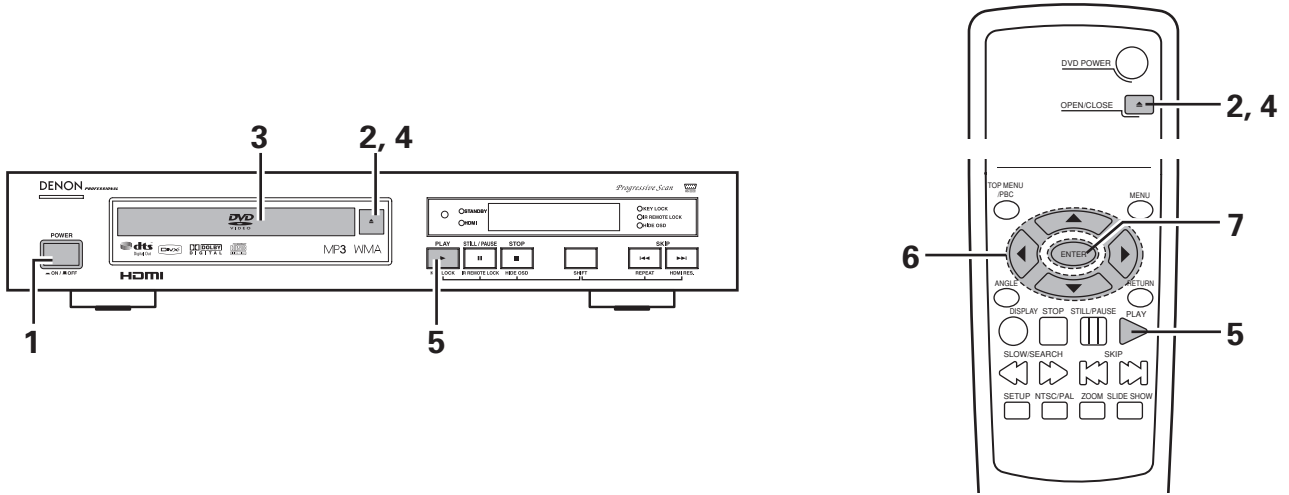

Press the SETUP button.

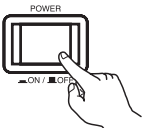
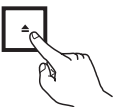
9 PLAYBACK

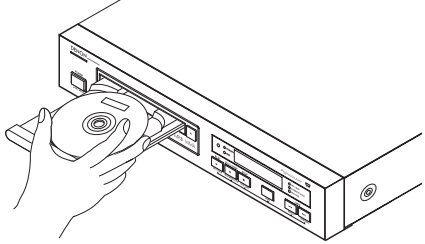
(1) Playback

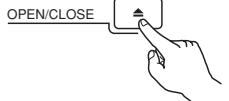
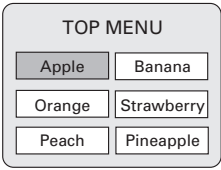
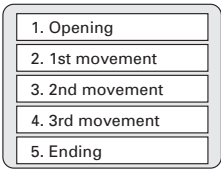
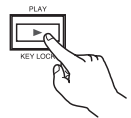

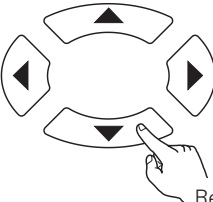
<p>1</p>	<p>Turn on the power.</p> <ul style="list-style-type: none"> • Press the power button, the power indicator lights and the power turn on. • When standby mode, press the DVD POWER button of remote control unit. 	 <p>POWER ON/OFF</p> <p>Main unit</p>
<p>2</p>	<p>Press the OPEN/CLOSE button to open the disc tray.</p>	 <p>Main unit</p>  <p>OPEN/CLOSE</p> <p>Remote control unit</p>
<p>3</p>	<p>Set the disc in the disc tray.</p>	

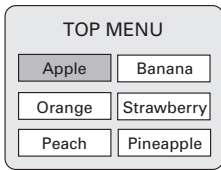
<p>4</p>	<p>Press the OPEN/CLOSE button.</p> <ul style="list-style-type: none"> For many interactive DVDs and video CDs with playback control, a menu screen appears. In this case use the procedure in step 6 to select the desired item. * Interactive DVDs are DVDs including multiple angles, stories, etc. 	<div style="display: flex; justify-content: space-around;"> <div style="text-align: center;">  <p>Main unit</p> </div> <div style="text-align: center;">  <p>Remote control unit</p> </div> </div> <div style="display: flex; justify-content: space-around; margin-top: 10px;"> <div style="text-align: center;"> <p>Example: For DVDs with menu screens</p>  </div> <div style="text-align: center;"> <p>Example: For video CDs with playback control</p>  </div> </div>
<p>5</p>	<p>Press the PLAY button.</p>	<div style="display: flex; justify-content: space-around;"> <div style="text-align: center;">  <p>Main unit</p> </div> <div style="text-align: center;">  <p>Remote control unit</p> </div> </div>
<p>6</p>	<p>Use the cursor buttons (▲, ▼, ◀ and ▶) to select the desired item.</p> <ul style="list-style-type: none"> For some discs there is a second menu screen. If so, press the 9 button to display the next menu screen. (See the disc's jacket.) * The cursor buttons (▲, ▼, ◀ and ▶) do not work for video CDs. Use the number buttons to select the desired item. 	<div style="text-align: center;">  <p>Remote control unit</p> </div>
<p>7</p>	<p>Press the ENTER button.</p> <ul style="list-style-type: none"> The desired item is selected and playback starts. You can return to the menu screen by pressing the TOP MENU button while the DVD is playing, though this depends on the disc. Press the RETURN button during playback of a video CD to return to the menu screen. 	<div style="text-align: center; margin-bottom: 20px;">  <p>Remote control unit</p> </div> <div style="text-align: center;"> <p>Example: When "Apple" is selected</p> <div style="display: flex; align-items: center; justify-content: center;">  ➔ <div style="border: 1px solid black; padding: 10px; background-color: #e0e0e0; text-align: center; width: 100px;"> <p style="font-size: 1.5em;">Apple</p> </div> </div> </div>

NOTES:

- If "⊘ not allowed at the moment" appears on the TV screen while buttons are being operated, that operation is not possible on the DN-V210/DN-V310 or with that disc.
- Set the disc in the disc guide.
- Do not place more than one disc in the disc tray.
- The disc keeps turning while the menu screen is displayed on the TV screen.
- When the auto play mode is turned on, playback of the main program begins. The menu screen is not displayed.

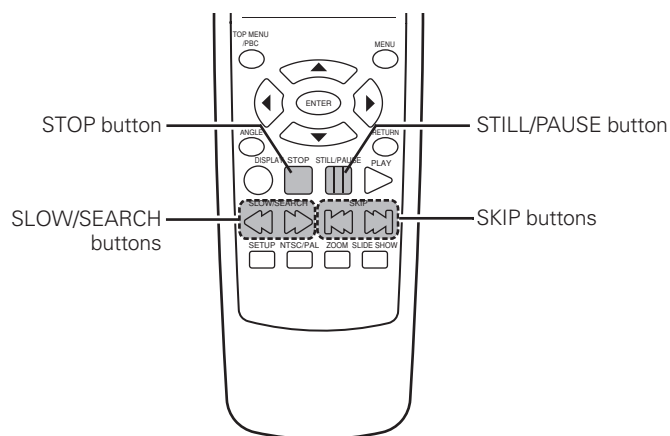
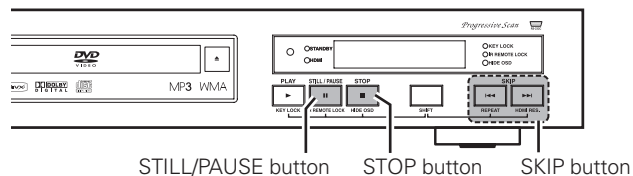

(2) Stopping Playback

During playback, press the STOP button on the main unit or the remote control unit, playback stops and wall paper is displayed.

Resume play memory function

- With the DN-V210/DN-V310, when the STOP button is pressed, that position is stored in the memory. At this time, "rESUME" is displayed on the display.
- When the PLAY button is pressed after pressing the STOP button, playback resumes from the position at which it was stopped.
- The resume play memory function is canceled if the disc tray is opened or the STOP button is pressed a second time.
- If you do not want to continue playing the disc, to save electricity either press the DVD POWER button on the remote control unit to set the power to the standby mode.

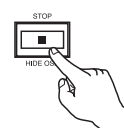

Main unit

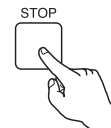

Remote control unit

- * The resume play memory function only works for discs for which the elapsed time is shown on the display during playback.
- * The resume play function is disabled when the AUTO PLAY mode is turned on.

(3) Playing Still Pictures (Pausing)

During playback, press the STILL/PAUSE button on the main unit or the remote control unit.

- Press the PLAY button to resume normal playback.

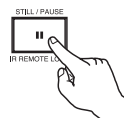

Main unit



Remote control unit

(4) Forward/Reverse Searching

During playback, press one of the SLOW/SEARCH buttons on the remote control unit.

◀◀ : Reverse direction

▶▶ : Forward direction

- When pressed again, the search speed increases (in four steps).
- Variable in 3 steps for CDs and video CD discs, 4 steps for DVD video.
- Press the PLAY button to resume normal playback.

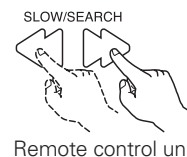

Remote control unit

(5) Skipping to the Beginning of Chapters or Tracks

During playback, press one of the skip buttons on the main unit or the remote control unit.

◀◀ : Reverse direction

▶▶ : Forward direction

- A number of chapters or tracks equal to the number of times the button is pressed is skipped.
- When the skip back button is pressed once, the pickup returns to the beginning of the currently playing chapter or track.

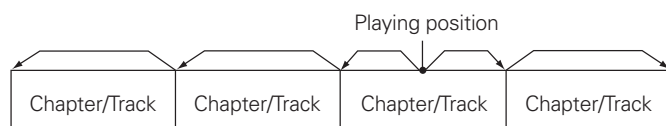

Reverse direction ← → Forward direction (direction of playback)

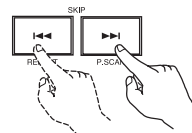

Main unit

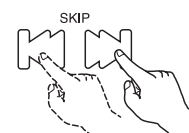

Remote control unit

NOTE:

- In some cases the menu screen may reappear when one of the SKIP buttons is pressed during menu playback on a video CD.

(6) Playing Frame by Frame (for DVDs only)

During playback, press the STILL/PAUSE button on the main unit or the remote control unit.

- The picture moves forward one frame each time the button is pressed.
- Press the PLAY button to resume normal playback.

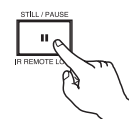

Main unit



Remote control unit

(7) Slow Playback (for DVDs only)

In the still mode, press one of the SLOW/SEARCH buttons on the remote control unit.

◀◀ : Reverse direction

▶▶ : Forward direction



Remote control unit

10 PLAYING REPEATEDLY

■ Use this function to play your favorite audio or video sections repeatedly.

Playing Repeatedly (Repeat Playback)

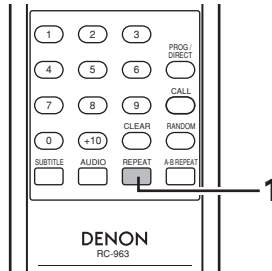

In the play mode,

- Main unit : Press the SHIFT and ◀◀ buttons simultaneously for 3 seconds.
- Remote control unit : Press the REPEAT button.
- The display on the TV screen switches each time the button is pressed, and the corresponding repeat play or stop mode is set.

1

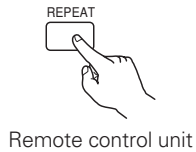
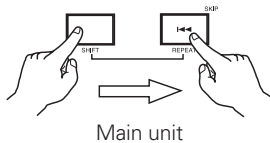

① For DVD video discs

- Normal playback

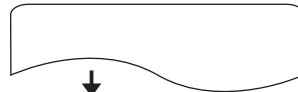

- Chapter repeated

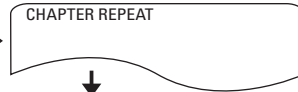

- Title repeated

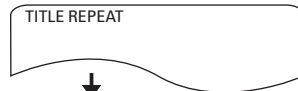

- Repeat playback cancelled

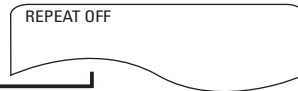

② For video CD

- Normal playback



- Track repeated



- Entire disc repeated

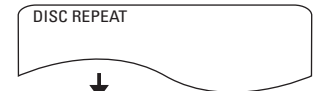

- Repeat playback cancelled

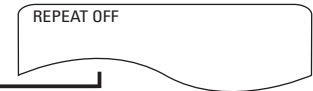

③ For CD

- Normal playback

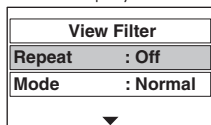

- Track repeated

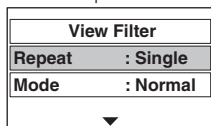

- Entire disc repeated

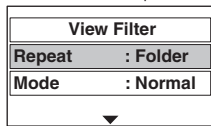

- Entire disc repeated

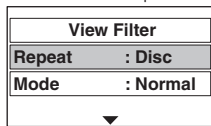

- Repeat playback cancelled

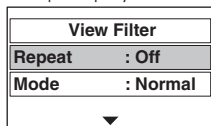

④ For MP3/WMA

- Normal playback

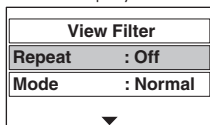

- File repeated

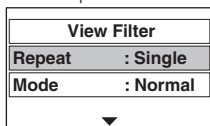

- Folder repeated

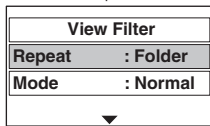

- Entire disc repeated

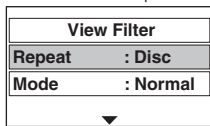

- Repeat playback cancelled

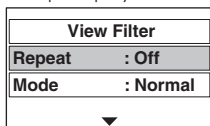

⑤ For JPEG/DivX

- Normal playback



- File repeated



- Folder repeated

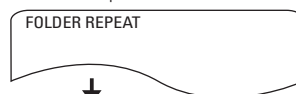

- Entire disc repeated

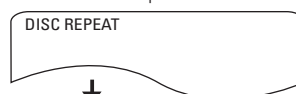

- Repeat playback cancelled

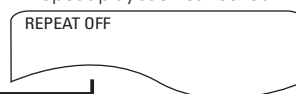

1

* To return to normal playback:

Return to normal playback by pressing the REPEAT button until "REPEAT OFF" appears on the TV screen.

Playing a Certain Section Repeatedly (A-B Repeat Playback)

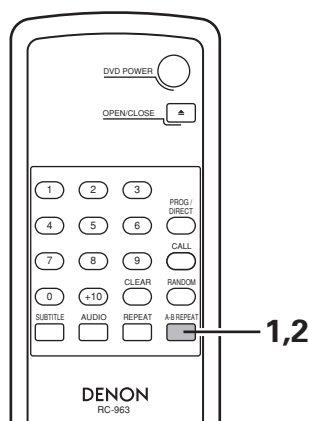

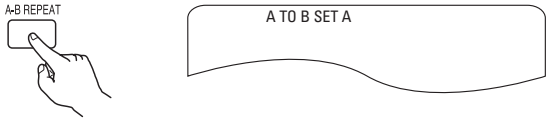
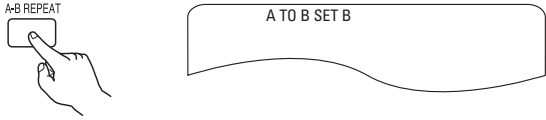
<p>1</p>	<p>During playback, press the A-B button.</p> <ul style="list-style-type: none"> This sets start point A. 	 <p>Remote control unit</p>
<p>2</p>	<p>Press the A-B button again.</p> <ul style="list-style-type: none"> This sets end point B, and repeat playback of the A-B section starts. 	 <p>Remote control unit</p>
<p>* To return to normal playback: Press the A-B button until "A TO B CANCELED" appears on the TV screen.</p>		





NOTES:

- Repeat playback may not work for some DVDs.
- The repeat playback and A-B repeat playback functions will not work for DVDs and video CDs for which the elapsed time is not shown on the display during playback.
- Repeat playback is not possible when PBC is turned on with video CDs. Press the TOP MENU button to turn PBC off.
- The Play button cannot be used during A-B Repeat.
- If you switch to the SETUP MENU screen during A-B Repeat, A-B Repeat is canceled.

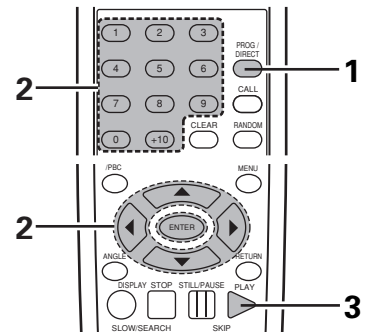
11 PLAYING TRACKS IN THE DESIRED ORDER

■ Use this function with DVD, Video CD, CD, MP3, WMA, DivX and JPEG to play the tracks in the desired order.

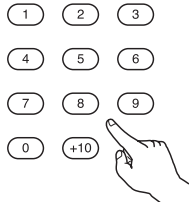
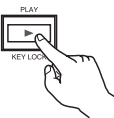



<p>1</p>	<p>For DVD: In the stop mode, press the PROG/DIRECT button once.</p> <ul style="list-style-type: none"> The program selection screen appears. 	 <p>Remote control unit</p> <table border="1" data-bbox="1117 569 1446 751"> <thead> <tr> <th>PROGRAM</th> <th>NO.</th> <th>TITLE</th> <th>CHAPTER</th> </tr> </thead> <tbody> <tr> <td>Mode :PROGRAM</td> <td>01</td> <td>...</td> <td>...</td> </tr> <tr> <td>PLAY</td> <td>02</td> <td>...</td> <td>...</td> </tr> <tr> <td>Clear Program</td> <td>03</td> <td>...</td> <td>...</td> </tr> <tr> <td></td> <td>04</td> <td>...</td> <td>...</td> </tr> <tr> <td></td> <td>05</td> <td>...</td> <td>...</td> </tr> </tbody> </table>	PROGRAM	NO.	TITLE	CHAPTER	Mode :PROGRAM	01	PLAY	02	Clear Program	03		04		05																																																
PROGRAM	NO.	TITLE	CHAPTER																																																																							
Mode :PROGRAM	01																																																																							
PLAY	02																																																																							
Clear Program	03																																																																							
	04																																																																							
	05																																																																							
<p>2</p>	<p>Press the ► cursor button to set the title number in the program mode. Use the number buttons to select the number of the title you want to program. Next, press the ► cursor, and enter the right side chapter. Press the ▼ cursor button. To program other titles and chapters, select one title and chapter number at a time and press the ▲ and ▼ cursor buttons after each number is selected.</p> <ul style="list-style-type: none"> Up to 99 tracks can be programmed. <p>EX: To program title 5, chapter 1 and title 12:</p>	 <p>Remote control unit</p>  <p>Remote control unit</p> <table border="1" data-bbox="305 1140 634 1323"> <thead> <tr> <th>PROGRAM</th> <th>NO.</th> <th>TITLE</th> <th>CHAPTER</th> </tr> </thead> <tbody> <tr> <td>Mode :PROGRAM</td> <td>01</td> <td>05</td> <td>01</td> </tr> <tr> <td>PLAY</td> <td>02</td> <td>...</td> <td>...</td> </tr> <tr> <td>Clear Program</td> <td>03</td> <td>...</td> <td>...</td> </tr> <tr> <td></td> <td>04</td> <td>...</td> <td>...</td> </tr> <tr> <td></td> <td>05</td> <td>...</td> <td>...</td> </tr> </tbody> </table> <table border="1" data-bbox="675 1140 1005 1323"> <thead> <tr> <th>PROGRAM</th> <th>NO.</th> <th>TITLE</th> <th>CHAPTER</th> </tr> </thead> <tbody> <tr> <td>Mode :PROGRAM</td> <td>01</td> <td>05</td> <td>01</td> </tr> <tr> <td>PLAY</td> <td>02</td> <td>1.</td> <td>...</td> </tr> <tr> <td>Clear Program</td> <td>03</td> <td>...</td> <td>...</td> </tr> <tr> <td></td> <td>04</td> <td>...</td> <td>...</td> </tr> <tr> <td></td> <td>05</td> <td>...</td> <td>...</td> </tr> </tbody> </table> <table border="1" data-bbox="1045 1140 1375 1323"> <thead> <tr> <th>PROGRAM</th> <th>NO.</th> <th>TITLE</th> <th>CHAPTER</th> </tr> </thead> <tbody> <tr> <td>Mode :PROGRAM</td> <td>01</td> <td>05</td> <td>01</td> </tr> <tr> <td>PLAY</td> <td>02</td> <td>12</td> <td>...</td> </tr> <tr> <td>Clear Program</td> <td>03</td> <td>...</td> <td>...</td> </tr> <tr> <td></td> <td>04</td> <td>...</td> <td>...</td> </tr> <tr> <td></td> <td>05</td> <td>...</td> <td>...</td> </tr> </tbody> </table>	PROGRAM	NO.	TITLE	CHAPTER	Mode :PROGRAM	01	05	01	PLAY	02	Clear Program	03		04		05	PROGRAM	NO.	TITLE	CHAPTER	Mode :PROGRAM	01	05	01	PLAY	02	1.	...	Clear Program	03		04		05	PROGRAM	NO.	TITLE	CHAPTER	Mode :PROGRAM	01	05	01	PLAY	02	12	...	Clear Program	03		04		05
PROGRAM	NO.	TITLE	CHAPTER																																																																							
Mode :PROGRAM	01	05	01																																																																							
PLAY	02																																																																							
Clear Program	03																																																																							
	04																																																																							
	05																																																																							
PROGRAM	NO.	TITLE	CHAPTER																																																																							
Mode :PROGRAM	01	05	01																																																																							
PLAY	02	1.	...																																																																							
Clear Program	03																																																																							
	04																																																																							
	05																																																																							
PROGRAM	NO.	TITLE	CHAPTER																																																																							
Mode :PROGRAM	01	05	01																																																																							
PLAY	02	12	...																																																																							
Clear Program	03																																																																							
	04																																																																							
	05																																																																							
<p>3</p>	<p>Press the PLAY button.</p> <ul style="list-style-type: none"> Playback of the tracks in the programmed order begins. 	 <p>Main unit</p>  <p>Remote control unit</p>																																																																								
<p>* To return to normal playback: Press the STOP button to stop programmed playback, then press the PROG/DIRECT button. Press the ENTER button to switch the mode from "PROGRAM" to "NORMAL". Press the PLAY button to start normal playback from the beginning of the disc.</p> <p>* To clear tracks from the program: Press the STOP button, then press the PROG/DIRECT button. Use the ►, ▲ and ▼ cursor buttons to select the title and chapter number you want to clear. Press the CLEAR button to clear the track.</p> <p>* To clear the entire program: The entire program is cleared when the power is turned off or the disc is ejected. Also, when the STOP button is pressed to stop programmed playback and the PROG/DIRECT button is pressed. Press the ▲ and ▼ cursor buttons to select "Clear Program", then press the ENTER button. At this time, the entire program is cleared.</p> <p>* Front panel display: Title and Chapter number of the track being played is displayed.</p>																																																																										

NOTE:

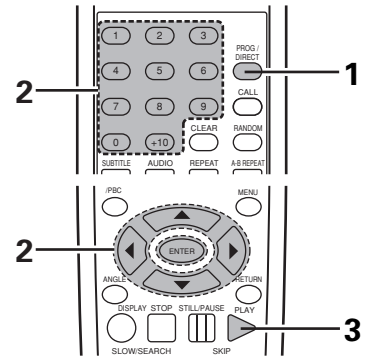

- Programmed playback is not possible when PBC is turned on with video CDs. Press the TOP MENU button to turn PBC off.

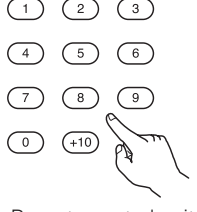
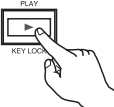
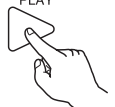

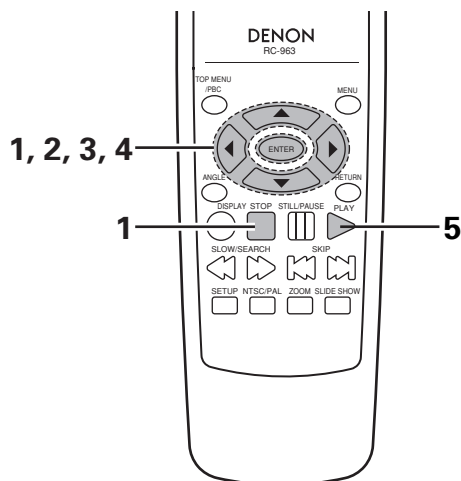
<p>1</p>	<p>For Video CD: In the stop mode, press the PROG/DIRECT button once.</p> <ul style="list-style-type: none"> The program selection screen appears. 	 <p>Remote control unit</p> <table border="1" data-bbox="1117 546 1448 730"> <thead> <tr> <th>PROGRAM</th> <th>NO.</th> <th>TRACK</th> </tr> </thead> <tbody> <tr> <td>Mode :PROGRAM</td> <td>01</td> <td>...</td> </tr> <tr> <td>PLAY</td> <td>02</td> <td>...</td> </tr> <tr> <td>Clear Program</td> <td>03</td> <td>...</td> </tr> <tr> <td></td> <td>04</td> <td>...</td> </tr> <tr> <td></td> <td>05</td> <td>...</td> </tr> </tbody> </table>	PROGRAM	NO.	TRACK	Mode :PROGRAM	01	...	PLAY	02	...	Clear Program	03	...		04	...		05	...																																				
PROGRAM	NO.	TRACK																																																						
Mode :PROGRAM	01	...																																																						
PLAY	02	...																																																						
Clear Program	03	...																																																						
	04	...																																																						
	05	...																																																						
<p>2</p>	<p>Press the ► cursor button to set the track number in the program mode. Use the number buttons to select the number of the track you want to program. Press the ▼ cursor button. To program other tracks, select one track number at a time and press the ▲ and ▼ cursor buttons after each number is selected.</p> <ul style="list-style-type: none"> Up to 99 tracks can be programmed. <p>EX: To program track 5 and track 12:</p>	 <p>Remote control unit</p>  <p>Remote control unit</p> <table border="1" data-bbox="305 1033 636 1213"> <thead> <tr> <th>PROGRAM</th> <th>NO.</th> <th>TRACK</th> </tr> </thead> <tbody> <tr> <td>Mode :PROGRAM</td> <td>01</td> <td>05</td> </tr> <tr> <td>PLAY</td> <td>02</td> <td>...</td> </tr> <tr> <td>Clear Program</td> <td>03</td> <td>...</td> </tr> <tr> <td></td> <td>04</td> <td>...</td> </tr> <tr> <td></td> <td>05</td> <td>...</td> </tr> </tbody> </table> <table border="1" data-bbox="673 1033 1005 1213"> <thead> <tr> <th>PROGRAM</th> <th>NO.</th> <th>TRACK</th> </tr> </thead> <tbody> <tr> <td>Mode :PROGRAM</td> <td>01</td> <td>05</td> </tr> <tr> <td>PLAY</td> <td>02</td> <td>1.</td> </tr> <tr> <td>Clear Program</td> <td>03</td> <td>...</td> </tr> <tr> <td></td> <td>04</td> <td>...</td> </tr> <tr> <td></td> <td>05</td> <td>...</td> </tr> </tbody> </table> <table border="1" data-bbox="1042 1033 1373 1213"> <thead> <tr> <th>PROGRAM</th> <th>NO.</th> <th>TRACK</th> </tr> </thead> <tbody> <tr> <td>Mode :PROGRAM</td> <td>01</td> <td>05</td> </tr> <tr> <td>PLAY</td> <td>02</td> <td>12</td> </tr> <tr> <td>Clear Program</td> <td>03</td> <td>...</td> </tr> <tr> <td></td> <td>04</td> <td>...</td> </tr> <tr> <td></td> <td>05</td> <td>...</td> </tr> </tbody> </table>	PROGRAM	NO.	TRACK	Mode :PROGRAM	01	05	PLAY	02	...	Clear Program	03	...		04	...		05	...	PROGRAM	NO.	TRACK	Mode :PROGRAM	01	05	PLAY	02	1.	Clear Program	03	...		04	...		05	...	PROGRAM	NO.	TRACK	Mode :PROGRAM	01	05	PLAY	02	12	Clear Program	03	...		04	...		05	...
PROGRAM	NO.	TRACK																																																						
Mode :PROGRAM	01	05																																																						
PLAY	02	...																																																						
Clear Program	03	...																																																						
	04	...																																																						
	05	...																																																						
PROGRAM	NO.	TRACK																																																						
Mode :PROGRAM	01	05																																																						
PLAY	02	1.																																																						
Clear Program	03	...																																																						
	04	...																																																						
	05	...																																																						
PROGRAM	NO.	TRACK																																																						
Mode :PROGRAM	01	05																																																						
PLAY	02	12																																																						
Clear Program	03	...																																																						
	04	...																																																						
	05	...																																																						
<p>3</p>	<p>Press the PLAY button.</p> <ul style="list-style-type: none"> Playback of the tracks in the programmed order begins. 	 <p>Main unit</p>  <p>Remote control unit</p>																																																						
<p>* To return to normal playback: Press the STOP button to stop programmed playback, then press the PROG/DIRECT button. Press the ENTER button to switch the mode from "PROGRAM" to "NORMAL". Press the PLAY button to start normal playback from the beginning of the disc.</p> <p>* To clear tracks from the program: Press the STOP button, then press the PROG/DIRECT button. Use the ►, ▲ and ▼ cursor buttons to select the title and chapter number you want to clear. Press the CLEAR button to clear the track.</p> <p>* To clear the entire program: The entire program is cleared when the power is turned off or the disc is ejected. Also, when the STOP button is pressed to stop programmed playback and the PROG/DIRECT button is pressed. Press the ▲ and ▼ cursor buttons to select "Clear Program", then press the ENTER button. At this time, the entire program is cleared.</p> <p>* Front panel display: Track number of the track being played back is displayed.</p>																																																								

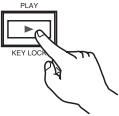

<p>1</p>	<p>For CD/MP3/WMA/DivX/JPEG: Use the ►, ▲ and ▼ cursor buttons to turn the Edit Mode at the top right of the file menu ON.</p> <ul style="list-style-type: none"> • When playing CD/MP3/WMA files, the file menu is always displayed on the screen. • When playing JPEG/DivX, press the MENU or STOP button to display the file menu. 	<p>File Menu</p>
<p>2</p>	<p>Use the ◀, ▲ and ▼ cursor buttons to select the tracks or files you want to program in the file menu. Press the ENTER button to decide.</p> <ul style="list-style-type: none"> • At this time, check mark is displayed on the track or file. <p>To program other tracks, select one track at a time and press the ENTER button after each track is selected.</p>	
<p>3</p>	<p>Use the ►, ▲ and ▼ cursor buttons to select "Add to Program" in the file menu. Press the ENTER button to set the program tracks or files.</p> <ul style="list-style-type: none"> • At this time, the displayed check marks disappear. 	
<p>4</p>	<p>Use the ▲ and ▼ cursor buttons to select "Program View" in the file menu. Press the ENTER button to display the program list.</p> <ul style="list-style-type: none"> • The selected tracks are displayed as a program list. 	

5	<p>Press the PLAY button.</p> <ul style="list-style-type: none"> • Playback of the tracks in the programmed order begins. 	<div style="display: flex; justify-content: space-around; align-items: center;"> <div style="text-align: center;">  <p>Main unit</p> </div> <div style="text-align: center;">  <p>Remote control unit</p> </div> </div>
<p>* When there are less than 2 folders for MP3/WMA/JPEG/DivX files: Repeat steps 2 and 3 above for each individual folder, and add files to be programmed. The added files can be verified in the Program View.</p> <p>* To return to normal playback: Use the ►, ▲ and ▼ cursor buttons to select "Browser View" in the file menu. Press the ENTER button to display the all tracks or files.</p> <p>* To clear tracks or files from the program. Press the STOP button to switch to the STOP status. When the Program list is displayed, use the ►, ▲ and ▼ cursor buttons to select the tracks or files that you want to clear. A check mark is added next to the track or file. Use the ►, ▲ and ▼ cursor buttons to select "Clear Program" in the file menu. Press the ENTER button to clear the all track or files from the program list. To clear all tracks or files, add a check mark next to all of the tracks or files in the program list.</p> <p>* To clear the entire program: The entire program is cleared when the power is turned off or the disc is ejected.</p> <p>* Front panel Display: Program number is displayed.</p>		

12 PLAYING TRACKS IN THE RANDOM ORDER

- Use this function with Video CD, CD, MP3, WMA, DivX and JPEG to play the tracks in random order.
This function does not affect with DVD.

NOTE:

- Random playback is not possible when PBC is turned on with video CDs. Press the TOP MENU button to turn PBC off.

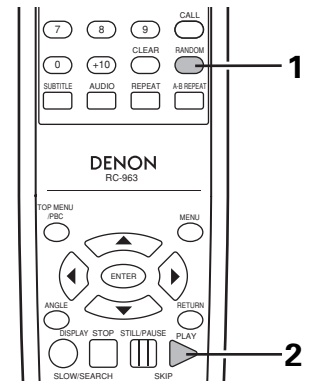

1	<p>For Video CD:</p> <p>In the stop mode, press the RANDOM button.</p> <ul style="list-style-type: none"> The random play screen appears. Random playback is not possible for some discs. 	<p>Remote control unit</p>
2	<p>Press the PLAY button.</p> <ul style="list-style-type: none"> The tracks start playing in random order. 	<p>Main unit Remote control unit</p>
<p>* To return to normal playback: Press the STOP button to stop random playback, then press the RANDOM button once.</p>		

1	<p>For CD, MP3, WMA, DivX and JPEG:</p> <p>In the stop mode, press the RANDOM button.</p> <ul style="list-style-type: none"> The Control Menu Mode changes from Normal to Random. <p>Use the ◀, ▶, ▲, and ▼ cursor buttons to select Mode, and press the ENTER button to set Random Mode.</p>	
2	<p>Press the PLAY button.</p> <ul style="list-style-type: none"> The tracks start playing in random order. 	<p>Main unit Remote control unit</p>
<p>* The Random button and cursor button can also be used during playback to switch to Random play. RANDOM ON is displayed on the screen during DivX/JPEG playback.</p> <p>* To return to normal playback: Press the RANDOM button during Random play. Use the cursor buttons to select Mode and press ENTER to return to Normal Play.</p>		

13 USING THE ON-SCREEN DISPLAY

- Use this function to display and change information on the disc (titles, chapters, time, etc.)

NOTE:

- The on-screen display function does not work when PBC is turned on with video CDs. Press the TOP MENU button to turn PBC off.

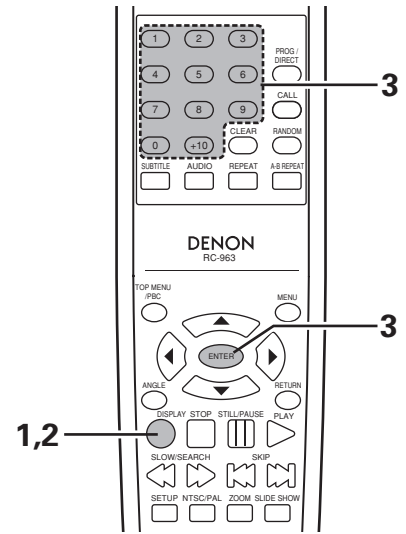

<p>1</p>	<p>In the play mode, press the DISPLAY button.</p> <ul style="list-style-type: none"> The On-Screen Display appears. The picture on the TV screen switches each time the button is pressed. The items displayed differ from disc to disc. 	<p>Remote control unit</p>
<p>2</p>	<p>Example: For DVD video discs</p> <p>Example: For video and music CDs</p>	
<p>3</p>	<p>Input using the number buttons, then press the ENTER button.</p> <p>① Changing the elapsed time Use the ◀ and ▶ cursor buttons to select the elapsed time. The selected item is displayed with a blue frame.</p> <ul style="list-style-type: none"> For DVDs Example : For 1 Hour 32 minute 47 seconds / "13247" : For 1 minute 26 seconds / "00126" For video and music CDs Example : For 1 minute 26 seconds / "0126" <p>② Changing the title, track or chapter For DVDs Use the ◀ and ▶ cursor buttons to select the track. Input using the number buttons, then press the ENTER button.</p> <ul style="list-style-type: none"> For video and music CDs Use the ▲ and ▼ cursor buttons to select the track. The selected item is displayed with a blue frame. Input using the number buttons. Playback starts from that track. 	<p>Remote control unit</p> <p>Remote control unit</p>

14 USING THE MULTIPLE AUDIO, SUBTITLE AND ANGLE FUNCTIONS

Switching the Audio Language (Multiple Audio Function)

■ With DVDs containing multiple audio language signals, the audio language can be switched during playback.

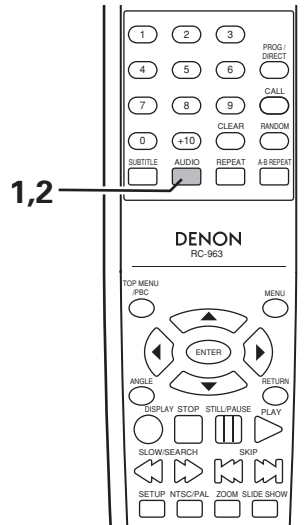

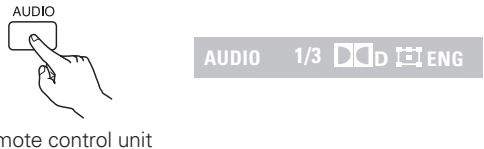
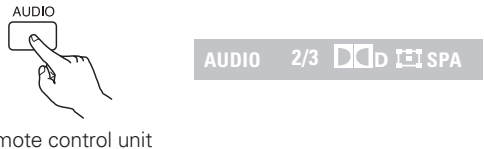
<p>1</p>	<p>During playback, press the AUDIO button.</p> <ul style="list-style-type: none"> The current audio language number is displayed. 	 <p>Remote control unit</p>
<p>2</p>	<p>Use the AUDIO buttons to select the desired language.</p>	 <p>Remote control unit</p>



NOTES:

- With some discs it is not possible to change the audio language during playback. In such cases, select from the DVD menu. (See page 29.)
- If the desired language is not set after pressing the AUDIO buttons several times, the disc does not include that language.
- The language selected in the default settings (See page 29.) is set when the power is turned on and when the disc is replaced.

Switching the Subtitle Language (Multiple Subtitle Function)

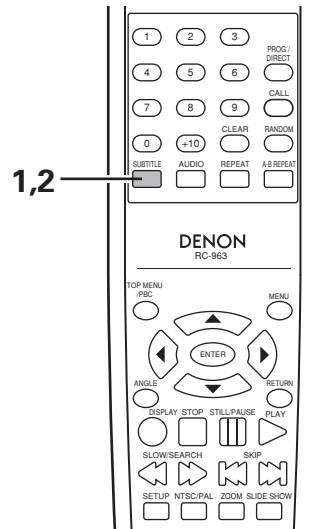
- With DVDs containing multiple subtitle language signals, the subtitle language can be switched during playback.



<p>1</p>	<p>During playback, press the SUBTITLE button.</p> <ul style="list-style-type: none"> The current subtitle language number is displayed. 	 <p>Remote control unit</p>
<p>2</p>	<p>Use the SUBTITLE button to select the desired language.</p>	 <p>Remote control unit</p>

NOTES:

- If the desired language is not set after pressing the SUBTITLE button several times, the disc does not include that language.
- The subtitle language set with the default settings (See page 29.) is set when the power is turned on and when the disc is replaced. If that language is not included on the disc, the disc's default language is set.
- When the subtitle language is changed, several seconds may be required for the new language to appear.
- When a disc supporting the closed caption is played, the subtitle and the closed caption may overlap each other on the TV monitor. In this case, turn the subtitle off.

Switching the Angle (Multiple Angle Function)

- With DVDs containing multiple angle signals, the angle can be switched during playback.

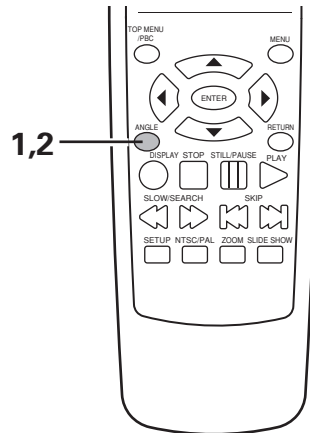

<p>1</p>	<p>During playback, press the ANGLE button.</p> <ul style="list-style-type: none"> The current angle number is displayed. 	<p>Remote control unit</p>
<p>2</p>	<p>Use the ANGLE button to select the desired angle.</p>	<p>Remote control unit</p>

NOTES:



- The multiple angle function only works with discs on which multiple angles are recorded.
- "ANGLE" lights on the main unit's display when playing a section recorded in the multi-angle mode.
- At scenes where multiple angles are recorded, the angle can be switched.

15 USING THE MENUS

Using the Top Menu

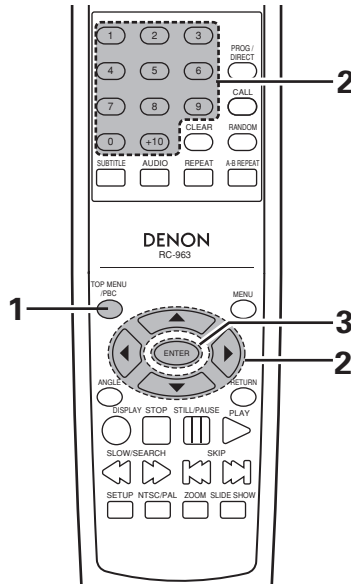
■ For DVDs containing multiple titles, the desired title can be selected and played from the top menu.

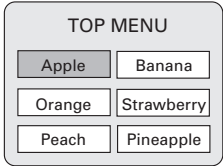
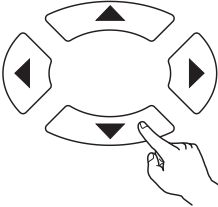
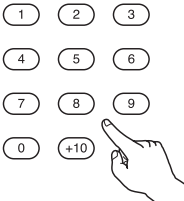
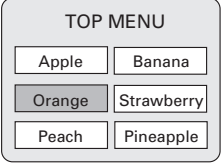



<p>1</p>	<p>During playback, press the TOP MENU button.</p> <ul style="list-style-type: none"> • The top menu appears. 	<p>Example:</p>  <p>Remote control unit</p> 
<p>2</p>	<p>Use the cursor or number buttons to select the desired title.</p>	 <p>Remote control unit</p>  <p>Remote control unit</p> <p>Example: When "Orange" is selected</p> 
<p>3</p>	<p>Press the ENTER button.</p> <ul style="list-style-type: none"> • Playback starts. • Playback also starts if the PLAY button is pressed. 	 <p>Remote control unit</p>

Using the DVD Menu

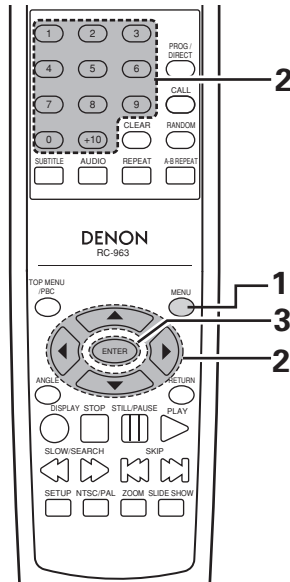
- Some DVDs include special menus called DVD menus. For example, DVDs with complex contents may contain guide menus, and DVDs with multiple languages may contain audio and subtitle language menus. These menus are called "DVD menus". Here we describe the general procedure for using DVD menus.

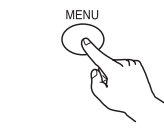
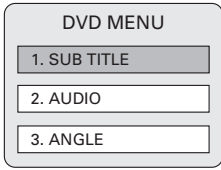
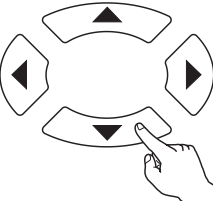
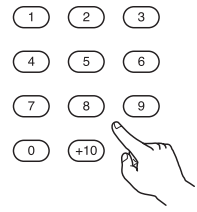

<p>1</p>	<p>During playback, press the MENU button.</p> <ul style="list-style-type: none"> The DVD menu appears. 	<p>Example:</p>  <p>Remote control unit</p> 
<p>2</p>	<p>Use the cursor or number buttons to select the desired item.</p> <ul style="list-style-type: none"> If you select the item using the number buttons, skip step 3 below. 	 <p>Remote control unit</p>  <p>Remote control unit</p> <p>Example: "AUDIO" is selected</p> 
<p>3</p>	<p>Press the ENTER button.</p> <ul style="list-style-type: none"> The selected item is set. If more menus appear, repeat steps 2 and 3. 	 <p>Remote control unit</p>

16 PLAYING IN THE ZOOM MODE

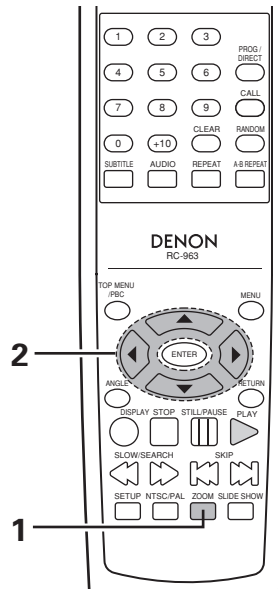

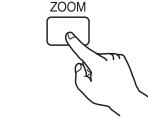
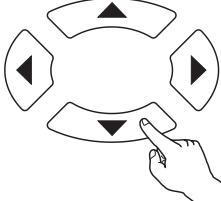
<p>1</p>	<p>In the play or pause mode, press the ZOOM button.</p> <ul style="list-style-type: none"> The zoom rate increases each time the ZOOM button is pressed. <p>For DVD Video CD, JPEG and DivX:</p> <p style="text-align: center;"> → ZOOM OFF → ZOOM 1 ZOOM 3 ← ZOOM 2 ← </p>	 <p>Remote control unit</p>
<p>2</p>	<p>Use the cursor buttons (▼, ▲, ◀ and ▶) to move the zoomed picture.</p>	 <p>Remote control unit</p>

NOTES:

- Zooming is not possible with some discs.
- The zoom function may not work properly at some scenes.
- Zooming is not possible at the top menu or the menu screen.
- Zooming is not possible during playback when "HD JPEG MODE" is set to ON.

17 MP3/WMA FILE PLAYBACK

Listening to MP3/WMA CD, CD-Rs and CD-RWs

- There are many music distribution sites on the internet from which music files in MP3/WMA format can be downloaded. Music downloaded as instructed on the site and written onto a CD-R/RW disc can be played on the DN-V210/DN-V310.

If music recorded on commercially available music CDs is converted on a computer into MP3/WMA files using an MP3/WMA encoder (conversion software), the data on a 12 cm CD is reduced into about 1/10 the amount of the original data. Thus, when written in MP3/WMA format, the data of about 10 music CDs can fit onto a single CD-R/RW disc. A single CD-R/RW disc can contain over 100 tracks.

- * Values when 5-minute tracks are converted with a standard bit rate of 128 kbps into MP3/WMA files and using a CD-R/RW disc with a capacity of 650 MB.
- * **Uses of recordings you have made other than for your personal enjoyment are not permitted under the copyright law without permission of the copyright holder.**

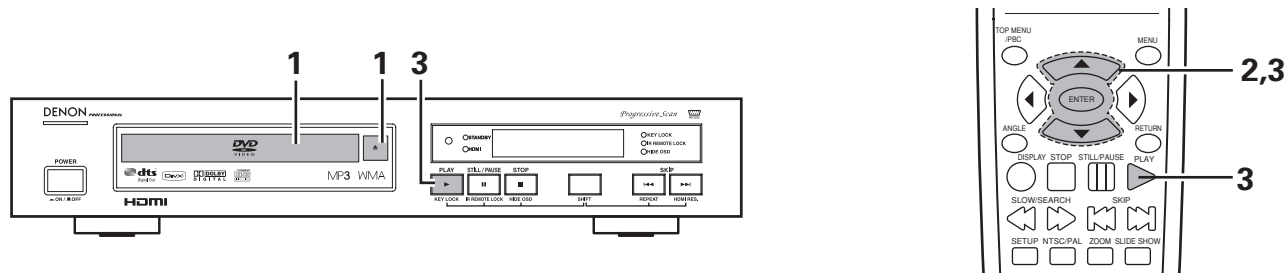

<p>1</p>	<p>Load the CD-R/RW disc on which the MP3/WMA format music files have been written into the DN-V210/DN-V310. (See page 19.)</p> <ul style="list-style-type: none"> When the disc is loaded in the DN-V210/DN-V310, the disc information screen appears. If there are multiple folders, proceed to step 2. If there are no folders on the disc, proceed to step 3. 	
<p>2</p>	<p>Use the ▲ and ▼ cursor buttons to select the folder containing the file(s) you want to play, then press the ENTER button.</p> <ul style="list-style-type: none"> If there are multiple folders furthermore, proceed to step 2. <p>* To change the folder Use the ▲ and ▼ cursor buttons to select "Up.." at the upper of the screen, then press the ENTER button. The another folders reappear in the disc information screen. Select the desired folder.</p>	<p>Remote control unit</p> <p>Remote control unit</p>

3

Use the ▲ and ▼ cursor buttons to select the MP3/WMA file you want to play, then press the PLAY button or ENTER button.

- Playback starts.

* The display can be switched between the single elapsed time and the single remaining time by pressing the DISPLAY button.

*** To change the MP3/WMA file**

Press the STOP button, then use the ▲ and ▼ cursor buttons to reselect the desired MP3/WMA file.

*** To return to the initial disc information screen**

Use the ▲ cursor button to select "Up.." at the upper left of the screen, then press the ENTER button. The screen in step 1 reappears.

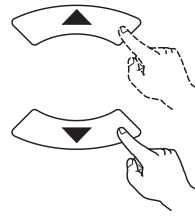

Remote control unit

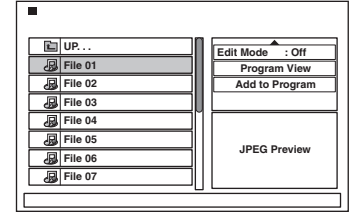

Remote control unit

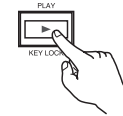

Main unit



Remote control unit

NOTES:

- The DN-V210/DN-V310 is compatible with the "MPEG-1 Audio Layer 3" standards (sampling frequency of 44.1 kHz) and WMA. It is not compatible with such other standards as "MPEG-2 Audio Layer 3", "MPEG-2.5 Audio Layer 3", MP1, MP2, etc.
- It may not be possible to play some CD-R/RW discs due to disc properties, dirt, warping, etc.
- The digital signals output when playing MP3/WMA files are MP3/WMA signals converted into PCM, regardless of whether the audio output presetting is set to "normal" or "PCM".
- In general, the higher an MP3 file's bit rate, the better the sound quality. On the DN-V210/DN-V310, we recommend using MP3 files recorded with bit rates of 128 kbps or greater. WMA files are 64kps or greater.
- MP3/WMA files may not be played in the expected order, since the writing software may change the position of the folders and the order of the files when writing them on the CD-R/RW.
- When writing MP3/WMA files on CD-R/RW discs, set the writing program to store the files in the "ISO9660 level 1, level 2 or Joliet" format. The physical format of the CD to Mode1, Mode2, or XA Form1.
- With the DN-V210/DN-V310 it is possible to display folder names and file names on the screen like titles. The DN-V210/DN-V310 can display up to 15 characters, consisting of numbers, capital letters, and the "_" (underscore) mark.
- Total number of folders is less than 256, and the total number of files is less than 1000.
- Be sure to add the extension ".MP3" to MP3 files, ".WMA" to WMA files. Files cannot be played if they have any extension other than ".MP3/WMA" or if they have no extension.
- Do not apply stickers, tape, etc., to either the label side or the signal side of CD-R/RW discs. If adhesive gets on the surface of a disc, the disc may get stuck inside the DN-V210/DN-V310 and be impossible to eject.
- The DN-V210/DN-V310 is not compatible with packet write software.

18 PLAYING STILL PICTURE FILES (JPEG format)

■ Uses of recordings you have made other than for your personal enjoyment are not permitted under the copyright law without permission of the copyright holder.

Playing still pictures stored on CD-Rs/RWs

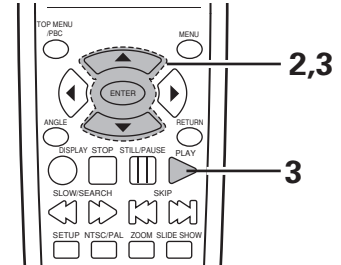
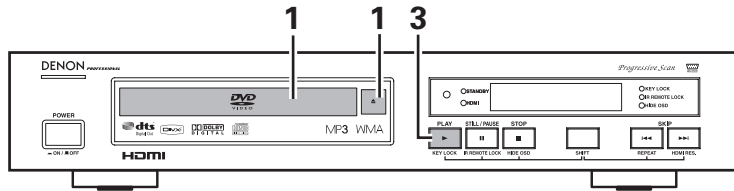

<p>1</p>	<p>Load the CD-R/RW on which the still pictures have been written into the DN-V210/DN-V310.</p> <ul style="list-style-type: none"> When the disc is loaded in the DN-V210/DN-V310, the disc information screen appears. If there are multiple folders proceed to step 2. If there are no folders on the disc, proceed to step 3. 	
<p>2</p>	<p>Use the ▲ and ▼ cursor buttons to select the folder containing the file(s) you want to play, then press the ENTER button.</p> <p>* To change the folder Use the ▲ and ▼ cursor buttons to select "Up.." at the upper of the screen, then press the ENTER button. The another folders reappear in the disc information screen. Select the desired folder.</p>	<p>Remote control unit</p> <p>Remote control unit</p>

3

Use the ▲ and ▼ cursor buttons on the remote control unit to select the still picture file from which you want to start the slide show, then press the PLAY button or ENTER button on the remote control unit.

- The slide show starts.
- Only the still picture files in the selected folder are played.

- * Once all the still picture files in the folder have been played, the disc information screen reappears.
- * The image size (W:xxx, H:xxx) is displayed below the JPEG Preview.
- * Press the TOP MENU button in the file menu display to switch to the thumbnail display. Press the STOP button during thumbnail display to return to the file menu.

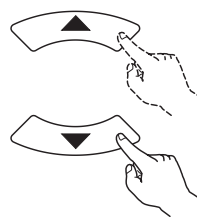

Remote control unit

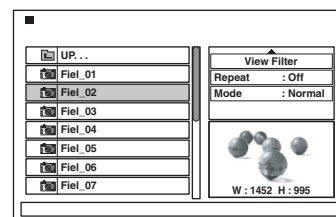

Remote control unit

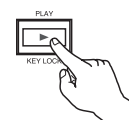

Main unit



Remote control unit

Thumbnail display

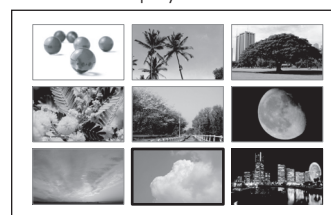

- * To display menu screen of the still pictures stored on the disc at once:
 - Press the MENU button to display up to menu screen at once.
 - To select and view a still picture (to start the slide show from a specific still picture), use the cursor buttons (▼, ▲, ◀ and ▶) to select the desired still picture, then press the ENTER button.
- * To temporarily stop the slide show:
 - Press the STILL/PAUSE button.
 - To resume the slide show, press the PLAY button.
- * To cue a still picture you want to view (from which you want to start the slide show):
 - During the slide show, press one of the SKIP (◀◀, ▶▶) buttons. Press the SKIP ◀◀ button to cue back to the previous still picture, the SKIP ▶▶ button to cue ahead to the next still picture.
- * Flipping and rotating still pictures:
 - Use the cursor buttons (▼, ▲, ◀ and ▶) to flip the still picture.
 - ▲ cursor button: The currently displayed still picture is flipped vertically.
 - ▼ cursor button: The currently displayed still picture is flipped horizontally.
 - ◀ cursor button: The currently displayed still picture is rotate 90° counterclockwise.
 - ▶ cursor button: The currently displayed still picture is rotate 90° clockwise.
- * Play the image in the zoom mode.
 - In the play or pause mode, press the ZOOM button to zoom. The zoom rate increases each time ZOOM button is pressed. (ZOOM OFF → ZOOM 1 → ZOOM 2 → ZOOM 3 → ZOOM OFF)
 - When the image is zoomed, use the cursor buttons (▼, ▲, ◀ and ▶) to move the zoomed picture.
 - Continuous playback (SLIDE SHOW) is possible in the zoom mode.
- * The way of switching to the next image during continuous JPEG image playback (SLIDE SHOW) can be selected.
 - Press the SLIDE SHOW button on the remote control unit.
 - Select from SLIDE SHOW MODE 1 to MODE 6, RAND and NONE.
- * Operating the SETUP menu is not possible during the playback of still pictures.

Special play modes for MP3/WMA and JPEG files

- FOLDER (the MP3/WMA and JPEG files in the folder are played in order starting from the selected file)
- FOLDER REPEAT (all the MP3/WMA and JPEG files in the folder are played repeatedly starting from the selected file)
- DISC (all the MP3/WMA and JPEG files on the disc are played in order starting from the selected file)
- DISC REPEAT (all the MP3/WMA and JPEG files on the disc are played repeatedly starting from the selected file)
- RANDOM ON (all the MP3/WMA and JPEG files in the folder are played in random order starting from the selected file)
- Music and Picture playback. (Select JPEG files during MP3/WMA playback to playback music and images at the same time.)
- During disc repeat playback of Music and Pictures, only the pictures within one folder are played repeatedly.
- When the Pause button is pressed during music and picture playback, only the playback of pictures is paused.
- When the play mode is HD JPEG ON, the playback of music and pictures is not possible.

NOTES:

- The DN-V210/DN-V310 is compatible with image data stored in JPEG format, but DN-V210/DN-V310 does not guarantee that all image data stored in JPEG format can be viewed.
- It may not be possible to play some CD-Rs/RWs due to disc properties, dirt, scratches, etc.
- When storing JPEG files on the CD-R/RW, set the writing program to store the files in the "ISO9660 level 1, level 2 or Joliet" format. The physical format of the CD to Mode1, Mode2, or XA Form1.
- With the DN-V210/DN-V310 it is possible to display folder names and file names on the screen like titles. The DN-V210/DN-V310 can display up to 15 characters, consisting of numbers, capital letters, and the "_" (underscore) mark.
- Total number of folders is less than 999, and the total number of files is less than 727.
- Be sure to give JPEG files the extension ".JPG". Files with other extensions or with no extensions cannot be viewed on the DN-V210/DN-V310.
- The maximum possible image size (in pixels) for displaying JPEG is as shown below.
2048 × 1536
If the maximum size is exceeded, the area that exceeds the maximum is cut.
- If the file size of a JPEG is large, reading the file may take a while.
- Picture sizes on the TV display differ depending on JPEG image sizes.
- Do not apply stickers, tape, etc., to either the label side or the signal side of CD-R/RW discs. If adhesive gets on the surface of a disc, the disc may get stuck inside the DN-V210/DN-V310 and be impossible to eject.
- JPEG files written using Macintosh computers cannot be played.

19 DivX FILE PLAYBACK

Playing Picture CDs (JPEG format)

■ Playing Picture CDs

The DN-V210/DN-V310 can play Kodak Picture CDs, so you can view the photographs stored on them on a TV screen. (Picture CDs is CDs containing photographs taken on conventional silver film cameras which have been converted into digital data. For details on Picture CDs, please contact a store providing Kodak development services.)

■ Uses of recordings you have made other than for your personal enjoyment are not permitted under the copyright law without permission of the copyright holder.

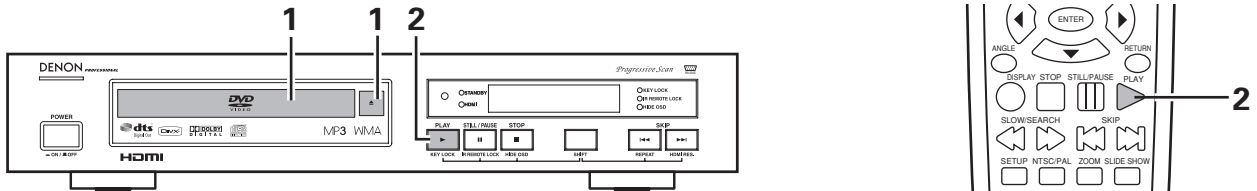

<p>1</p>	<p>Load the CD-R/RW disc on which the DivX files have been written into the DN-V210/DN-V310. (See page 19.)</p> <ul style="list-style-type: none"> When the disc is loaded in the DN-V210/DN-V310, the disc information screen appears. 	
<p>2</p>	<p>Press the Play button to start the Picture CD. Playback starts, and the images switch automatically.</p>	
<p>* Press the stop button to stop playback. * Once all the still picture files in the folder have been played, the disc information screen reappears. * The same operations as playing still picture files (JPEG format) can be used. (See pages 59, 60.)</p>		

Playing DivX movies stored on CD-Rs/RWs

- DivX files recorded onto CD-Rs or CD-ROMs can be played back.

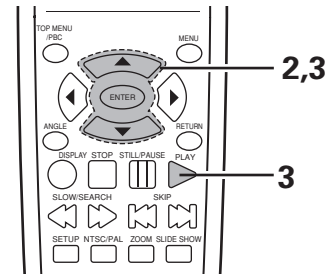
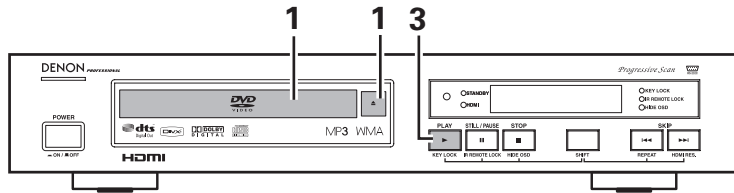

<p>1</p>	<p>Load the CD-R/RW disc on which the DivX files have been written into the DN-V210/DN-V310. (See page 19.)</p> <ul style="list-style-type: none"> When the disc is loaded in the DN-V210/DN-V310, the disc information screen appears. If there are multiple folders, proceed to step 2. If there are no folders on the disc, proceed to step 3. 	
<p>2</p>	<p>Use the ▲ and ▼ cursor buttons to select the folder containing the file(s) you want to play, then press the ENTER button.</p> <p>* To change the folder Use the ▲ and ▼ cursor buttons to select "Up.." at the upper of the screen, then press the ENTER button.</p>	<p>Remote control unit</p> <p>Remote control unit</p>

Use the ▲ and ▼ cursor buttons on the remote control unit to select the DivX file you want to start the DivX movies, then press the PLAY button or ENTER button on the remote control unit.

- Playback starts.

3

* The display can be switched between the single elapsed time and the single remaining time by pressing the DISPLAY button.

*** To change the DivX file**

Press the STOP button, then use the ▲ and ▼ cursor buttons to reselect the desired DivX file.

*** To return to the initial disc information screen**

Press the STOP button, use the ▲ cursor button to select "UP.." at the upper left of the screen, then press the ENTER button.

The screen in step 1 reappears.

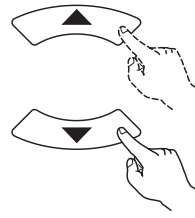

Remote control unit

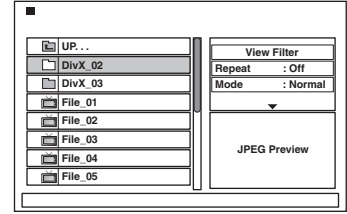

Remote control unit

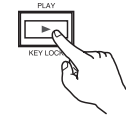

Main unit



Remote control unit

NOTES:

- DN-V210/DN-V310 are compatible with files recorded in the DivX format. However, DN-V210/DN-V310 are not guaranteed to playback all videos recorded in DivX format.
- It may not be possible to play some CD-Rs/RWs discs due to disc properties, dirt, warping, etc.
- When writing DivX files on CD-R/RW discs, set the writing program to store the files in the "ISO9660 level 1, level 2 or Joliet" format. The physical format of the CD to Mode1, Mode2, or XA Form1.
- With the DN-V210/DN-V310 it is possible to display folder names and file names on the screen like titles. The DN-V210/DN-V310 can display up to 15 characters, consisting of numbers, capital letters, and the "_" (underscore) mark.
- Total number of folders is less than 999, and the total number of files is less than 727.
- Be sure to give DivX files the extensions "AVI" and "DivX" files. Files with then extensions on with no extensions cannot be viewd on the DN-V210/DN-V310.
- Do not apply stickers, tape, etc., to either the label side or the signal side of CD-R/RW discs. If adhesive gets on the surface of a disc, the disc may get stuck inside the DN-V210/DN-V310 and be impossible to eject.
- Some DivX files protected by copyright require the DVD video player registration code to be played back. To find the registration code, select DivX in the setup menu. (See page 37.)

File Menu Functions

- **MP3/WMA/DivX files and JPEG files are displayed in the file menu. Both file menus are displayed if the CD contains a mix of MP3/WMA/DivX files and JPEG files.**

If you want to display only the MP3/WMA/DivX or JPEG files, select "View Filter" at the top right as shown below.

Audio : Display MP3 and WMA

Photo : Display JPEG

Video : Display MPEG/DivX

To perform filter settings, line up the cursor to "View Filter" and press ENTER. When the filter menu appears, select the required item from Audio/Photo/Video using the ▲ cursors and ▼ press ENTER.

After selecting, press the ◀ cursor to return to the file menu. When initializing the settings, select all of the items.

* For CDDA, the file menu is displayed. CDs that contain a mix of CDDA tracks, MP3/WMA/DivX and MPEG files cannot be used.

File Menu

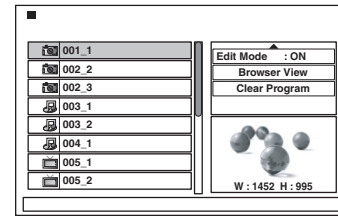

: MP3/WMA files are displayed.

: MPEG/DivX files are displayed.

: JPEG files are displayed.

Filter Menu

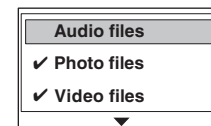
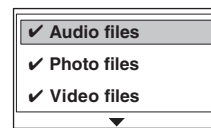

20 ADVANCED FUNCTION

KEY LOCK

■ Operation of the buttons on the front panel (aside from the POWER button) is disabled to prevent accidental operation.

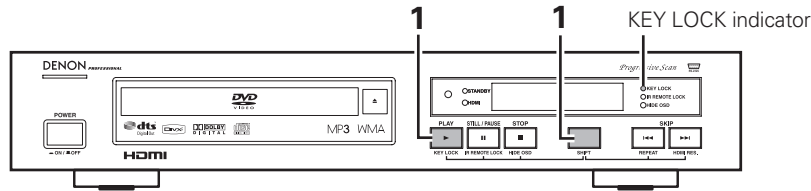

1	<p>Press the SHIFT and PLAY buttons simultaneously for 3 seconds. The KEY LOCK indicator lights (green) and the KEY LOCK mode is turned on.</p> <ul style="list-style-type: none"> • When the KEY LOCK mode is turned on, the KEY LOCK indicator flashes (green) if one of the buttons on the front panel (aside from the POWER button) is operated. • To turn the KEY LOCK mode off, press the SHIFT and PLAY buttons again simultaneously for 3 seconds. 	<p>Main unit</p>
----------	--	------------------

IR REMOTE LOCK

■ Operation of the buttons on the remote controller is disabled to prevent accidental operation.

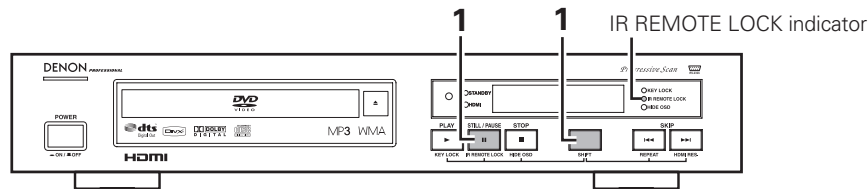

1	<p>Press the SHIFT and STILL/PAUSE buttons simultaneously for 3 seconds. The IR REMOTE LOCK indicator lights (green) and the IR REMOTE LOCK mode is turned on.</p> <ul style="list-style-type: none"> • When the IR REMOTE LOCK mode is turned on, the IR REMOTE LOCK indicator flashes (green) if one of the buttons on the remote controller is operated. • To turn the IR REMOTE LOCK mode off, press the SHIFT and STILL/PAUSE buttons again simultaneously for 3 seconds. 	<p>Main unit</p>
----------	--	------------------

HIDE OSD

- Switch the OSD and the display of the icons that appear on the screen on and off.

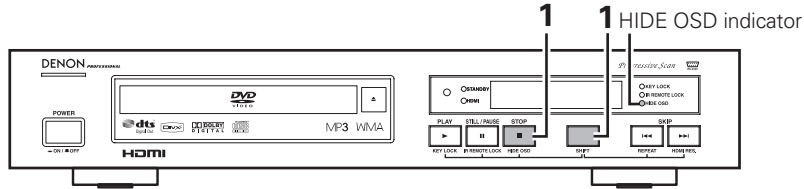

1

Press the SHIFT and STOP buttons simultaneously for 3 seconds.

The HIDE OSD indicator lights (green), the HIDE OSD mode is turned on, and the OSD as well as the letters and icons displayed when buttons are operated are not displayed.

- To turn the HIDE OSD mode off, press the SHIFT and STOP buttons again simultaneously for 3 seconds.
- * Operating the SETUP menu is not possible when HIDE OSD is set to ON.

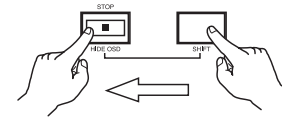

Main unit

Change the Image on the DVD Player Wallpaper

■ The image on the DVD player wallpaper can be changed at the user's discretion.

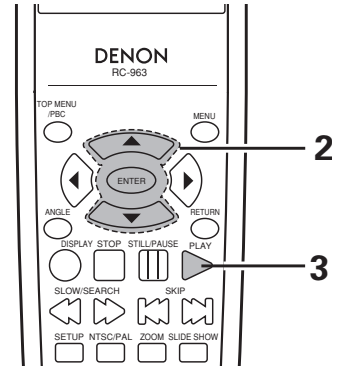
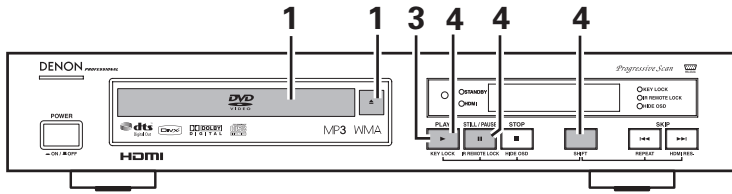

<p>1</p>	<p>Load the CD-R/RW on which the JPEG file for wallpaper have been written into the DN-V210/DN-V310.</p> <ul style="list-style-type: none"> When the disc is loaded in the DN-V210/DN-V310, the disc information screen appears. If there are multiple folders proceed to step 2. If there are no folders on the disc, proceed to step 3. 	
<p>2</p>	<p>Use the ▲ and ▼ cursor buttons to select the folder containing the file(s) you want to play, then press the ENTER button.</p> <p>* To change the folder Use the ▲ and ▼ cursor buttons to select "Up.." at the upper of the screen, then press the ENTER button. The another folders reappear in the disc information screen. Select the desired folder.</p>	<p>Remote control unit</p> <p>Remote control unit</p>

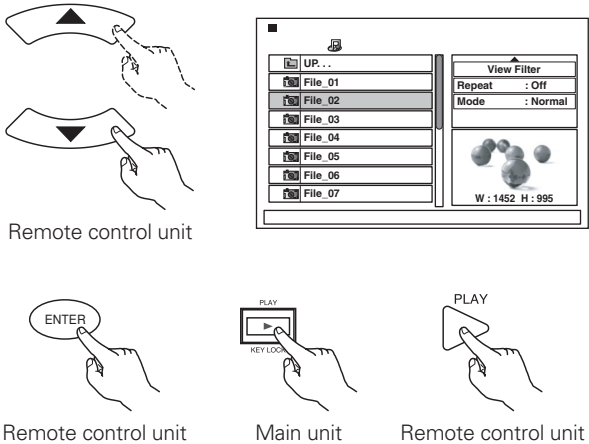
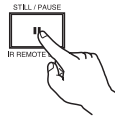
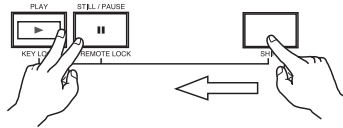
<p>3</p>	<p>Select the JPEG file to be set as the wallpaper and play it. Use the ▲ and ▼ cursor buttons on the remote control unit to select the still picture file from which you want to start the slide show, then press the PLAY button or ENTER button on the remote control unit.</p> <ul style="list-style-type: none"> • The slide show starts. • Only the still picture files in the selected folder are played. <p>* Once all the still picture files in the folder have been played, the disc information screen reappears.</p>	 <p>Remote control unit</p> <p>Remote control unit Main unit Remote control unit</p>
<p>4</p>	<p>When the JPEG file which you want to change is displayed, press the STILL/PAUSE button. The slide show temporarily stops.</p>	 <p>Main unit</p>
<p>5</p>	<p>Press the SHIFT, STILL/PAUSE and PLAY buttons simultaneously for 3 seconds. The DVD's wallpaper switches to the selected JPEG file.</p> <ul style="list-style-type: none"> * The data for the previously set wallpaper is deleted from the DVD player's memory. * Please contact a dealer if you wish to set the wallpaper back to a DENON Professional original wallpaper. * Do not switch the main unit power Off while switching the Wallpaper. 	 <p>Main unit</p>

Serial Remote Control (DN-V310 only)

■ Commands can be sent to the DVD player and the status requested and sent to the host via RS-232C.

This DVD player can be controlled by a PC. Connect the player and a serial port on the PC with a 9-pin RS-232C straight cable. To control this DVD player by a PC, set the RS-232C switch on the rear panel to RS-232C.

■ RS-232C Pin assignments (DVD player)

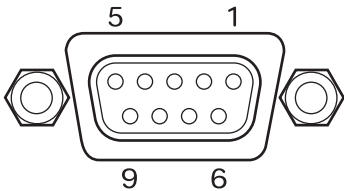

Pin no.	Signal
1	-
2	TXD
3	RXD
4	-
5	GND
6	-
7	CTS
8	RTS
9	-

■ Communication conditions

Configure the serial port of the PC as shown below.

Bit Rate	9,600 bps
Data length	8 bits
Parity	none
Stop bit	1 bit
Flow control	None

■ Basic format

- Command format
[group, command, parameter list]\r
- Response code format
0: No error
x: Error code x

Example 1:

Player receives : [PC, RC, 66]\r

Player sends : [PC, RC, 0]\r

When the external controller receives the response this implies that the player has verified the received message (syntax), and the command will be executed.

Example 2:

Player receives : [PC, PlayT, 16]\r

Player sends : [PC, PlayT, 2]\r

If an internal error occurs and the command cannot be executed, an error message (Error code 2 : Invalid parameter) will be send.

- Interval time
When transmitting commands consecutively, put more than 300 ms blank between commands.

■ System commands

Communication between a DVD controller and the DVD player consist of 3 different types of information:

- External control commands
- External control status
- Asynchronous responses

The messages between the DVD and the DVD controller look like:

“[group, command, parameter list]\r”

A group, command and parameter-list between square-brackets, followed by a carriage return character (\r).

The parameter-list exists of comma separated parameters, and are case sensitive.

When the player receives a message from the external controller, it will be acknowledged. This acknowledgment will be done in 2 different ways.

For external control commands, the acknowledgment will look like:

- Group : group specified in the received message (PC)
- Command : command specified in the received message
- Parameter-list : ReturnValue

ReturnValue can have one of the following values

- 0 : No error
- x : Error code x

■ Hand shake flow chart

- Control command and Status command
- Response command

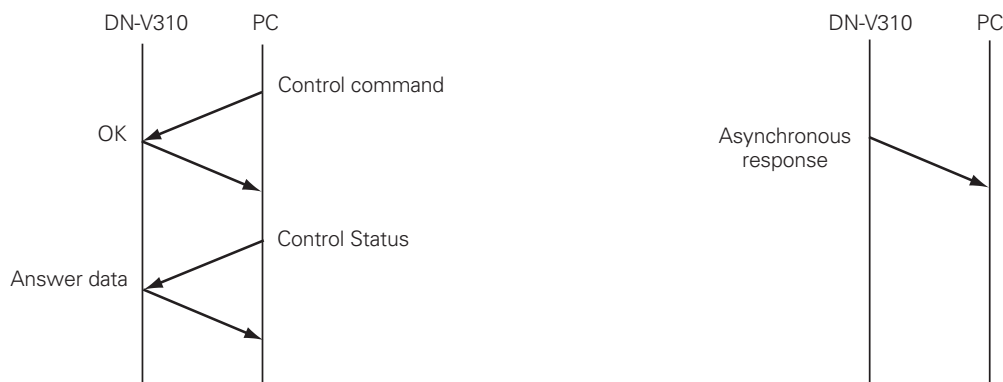

■ Error Codes

Name	Code	Description
ecEXT_ERR_OK	0	No error
ecEXT_ERR_UNKNOWN	1	Cause of error not known
ecEXT_ERR_INVALID_PARA	2	Invalid parameter
ecEXT_ERR_INV_CMD	5	Command not valid
ecEXT_ERR_INVALID_NA_DISC_ERROR	10	Command not valid for current disc

■ Command list

- External control commands

Group	Command	Parameter
PC	RC	Remote control command
	PlayT	Play title
	PlayC	Play Chapter
	Time	Time Search
	SetAST	Set audio stream
	SetSPST	Set sub-picture stream
	OSD	ON/OFF control for OSD
	LKC	ON/OFF control for KEY LOCK mode
	RCC	ON/OFF control for IR REMOTE LOCK mode

For TITLE, CHAPTER, TRACK and COUNTER, number data follows the command.

Example:

- [PC, PlayC, 1, 3] PLAY TITLE 1, CHAPTER 3
- [PC, Time, 0, 3, 15] PLAY 0h3min15sec

External control status

Group	Command	Parameter	
PC	GetStatus	Player status	ReturnValue, Status see Status codes
	GetDiscType	Disc type	ReturnValue, Disc Type see DiscType codes
	GetAST	Current audio stream	ReturnValue, AudioStreamNumber 1~8
	GetSPST	Current sub-picture stream	ReturnValue, SubPictureStreamNumber 0~32
	GetT	Current title	ReturnValue, Title/Track Number 0~99
	GetC	Current chapter	ReturnValue, Title Number, Chapter Number title : 1~99 chp : 1~999

Status codes 0:Error, 1:Opened, 2:No Disc, 3:Stopped, 4:Playing, 5:Paused

Disc Type codes 0:No Disc, 1:DVD, 2:VCD, 3:CD-DA, 4:MP3, 5:WMA, 6:DivX, 7:JPEG

Asynchronous responses

Group	Command	Parameter	
PC	EOT	End of title	ReturnValue, Title/Track Number 0~99
	SOC	Start of a Chapter	ReturnValue, Title Number, Chapter Number title : 1~99 chp : 1~999
	EOC	End of a chapter	ReturnValue, Title Number, Chapter Number title : 1~99 chp : 1~999
	Status Change	Execution of a command	Return Value, Return Status see Status codes
	Error	Error notification	Return Value, Error code see Error codes
	Set REZ	Set resolution	Return Value, HDMI Resolution 0~4

Set REZ codes 0:OFF, 1:480 p/576 p, 2:720 p, 3:1080 i, 4:AUTO

■ RC (Remote control) codes

Keys/Functions	RC codes (decimal)
Digit 0	0
Digit 1	1
Digit 2	2
Digit 3	3
Digit 4	4
Digit 5	5
Digit 6	6
Digit 7	7
Digit 8	8
Digit 9	9
DVD POWER	12
RANDOM	28
REPEAT	29
SLOW/SEARCH (+)	40
SLOW/SEARCH (-)	41
PLAY	44
PAUSE	48
STOP	49
A-B REPEAT	59
OPEN/CLOSE	66
SUBTITLE	75
AUDIO	78
TOP MENU/PBC	84

Keys/Functions	RC codes (decimal)
CURSOR UP	88
CURSOR DOWN	89
CURSOR LEFT	90
CURSOR RIGHT	91
ENTER	92
MENU	113
SETUP	130
RETURN	131
ANGLE	133
+10	180
CLEAR	181
CALL	182
NTSC/PAL	183
SLIDE SHOW	184
DISPLAY	200
ZOOM	247

21 TROUBLESHOOTING

Check again before assuming the player is malfunctioning.

- Are all the connections correct?
- Are you following the instructions in the manual?
- Are the amplifier and speakers operating properly?

If the DN-V210/DN-V310 does not seem to be functioning properly, check the table below. If this does not solve the problem, the DN-V210/DN-V310 may be damaged. Turn off the power, unplug the power cord from the power outlet, and contact your store of purchase or nearest sales office.

Symptom	Check	Page
Power does not turn on.	<ul style="list-style-type: none"> • Plug the power cord securely into the power outlet. 	6~11
Playback does not start when PLAY button is pressed. Playback stops immediately.	<ul style="list-style-type: none"> • Is there condensation on the disc or player? (Let stand for 1 or 2 hours.) • Discs other than DVDs, video CDs and music CDs and Digital picture (JPEG) cannot be played. • Disc is dirty. Wipe off the dirt. 	— 3, 4 5
Picture does not appear.	<ul style="list-style-type: none"> • Check the connections. • Set the TV's input to "video". 	6~11 —
Sound is not produced or sound quality is poor.	<ul style="list-style-type: none"> • Check the connections. • Properly set the input of the TV, stereo, etc. • Check the "DIGITAL OUT" and "COMPRESSION" settings. 	6~11 — 9, 10, 26, 27
Menu playback is not possible.	<ul style="list-style-type: none"> • Check the "AUTO PLAY" setting. • Menu playback is not possible with anything but video CDs with playback control. 	30 39
Picture is disturbed during the search operation.	<ul style="list-style-type: none"> • Some disturbance is normal. 	—
Buttons do not operate.	<ul style="list-style-type: none"> • Some operations are disabled for some discs. • Check the "KEY LOCK" mode. 	39 66
No subtitles are displayed.	<ul style="list-style-type: none"> • Subtitles are not displayed for DVDs not containing subtitles. • Subtitles are turned off. Turn the subtitles setting on. 	— 29
Audio (or subtitle) language does not switch.	<ul style="list-style-type: none"> • The audio (or subtitle) language does not switch for discs which do not include multiple audio (or subtitle) languages. • For some discs the audio (or subtitle) language cannot be switched when the operation to switch it is performed, but can be switched on the menu screens. 	— 54
Angle does not switch.	<ul style="list-style-type: none"> • The angle cannot be switched for DVDs which do not contain multiple angles. In some cases multiple angles are only recorded for specific scenes. 	53
Playback does not start when the title is selected.	<ul style="list-style-type: none"> • Check the "RATING" setting. 	34
The password for rating level has been forgotten.	<ul style="list-style-type: none"> • Use the procedure described below to set the initial settings back to the values set when the unit was shipped from the factory. Input "8888" at 5 under step 3 on page 34. 	—
The disc is not played with the audio or subtitle language set as the default setting.	<ul style="list-style-type: none"> • The disc does not play with the selected audio or subtitle language if that audio or subtitle language is not included on that DVD. 	29
Picture is not displayed in 4:3 (or 16:9).	<ul style="list-style-type: none"> • Set the "TV ASPECT" default setting to the proper setting for the connected TV. 	24
Menu screen messages for the desired language do not display.	<ul style="list-style-type: none"> • Check the default setting for the disc language's menu language. 	30
HDMI does not output.	<ul style="list-style-type: none"> • Check whether the Video output is set to HDMI. • Check that the DVD and TV HDMI connectors are connected. • Check that the TV supports 480p/576p/720p/1080i. 	23 13 23

22 MAIN SPECIFICATIONS

Signal system:	NTSC/PAL
Applicable discs:	(1) DVD discs 1-layer 12 cm single-sided discs, 2-layer 12 cm single-sided discs, 2-layer 12 cm double-sided discs (1 layer per side) 1-layer 8 cm single-sided discs, 2-layer 8 cm single-sided discs, 2-layer 8 cm double-sided discs (1 layer per side) (2) Compact discs (CD-DA, Video CD) 12 cm discs, 8 cm discs
S-Video output:	Y output level: 1 Vp-p (75 Ω /ohms) C output level: 0.3 Vp-p Output connector: S connector, 1 set
Video output:	Output level: 1 Vp-p (75 Ω /ohms) Output connectors: Pin-plug jack, 1 set / AV 1, 1 set (Europe model only)
Component output:	Y output level: 1 Vp-p (75 Ω /ohms) PB/CB output level: 0.7 Vp-p (75 Ω /ohms) PR/CR output level: 0.7 Vp-p (75 Ω /ohms) Output connector: Pin jack, 1 set
RGB output:	Output level: 0.7 Vp-p (75 Ω /ohms) Output connector: AV 1, 1 set (Europe model only)
HDMI output:	480 p / 576 p, 720 p, 1080 i
Audio output:	Output level: 2 Vrms 2 channel (FL, FR) output connector: Pin jacks, 1 set / AV 1, 1 set (Europe model only)
Audio output properties:	(1) Frequency response ① DVDs (linear PCM) : 4 Hz to 22 kHz (48 kHz sampling) : 4 Hz to 44 kHz (96 kHz sampling) ② CDs : 4 Hz to 20 kHz (2) S/N ratio ① DVDs : 110 dB ② CDs : 110 dB (3) Total harmonic distortion ① DVDs : 0.006% ② CDs : 0.004% (4) Dynamic range ① DVDs : 100 dB ② CDs : 95 dB
Digital audio output:	Optical digital output : Optical connector, 1 set Coaxial digital output : Pin Jack, 1 set
Power supply:	AC 230 V, 50 Hz (Europe) / AC 120 V, 60 Hz (USA)
Power consumption:	15 W
Maximum external dimensions:	434 (width) \times 80 (height) \times 360 (depth) mm (17-3/32" \times 3-5/32" \times 14-11/64") (including protruding parts)
Mass:	3.9 kg (9 lbs)
Remote control unit:	RC-963
Type:	Infrared pulse
Power supply:	DC 3 V, 2 R03/AAA batteries

This product incorporates copyright protection technology that is protected by method claims of certain U.S. patents and other intellectual property rights owned by Macrovision Corporation and other rights owners. Use of this copyright protection technology must be authorized by Macrovision Corporation, and is intended for home and other limited viewing uses only unless otherwise authorized by Macrovision Corporation. Reverse engineering or disassembly is prohibited.

* Design and specifications are subject to change without notice in the course of product improvement.

D&M Holdings Inc.

PROFESSIONAL BUSINESS COMPANY

TOKYO, JAPAN
<http://www.dm-pro.jp>



Printed in China
05/2007 00M47AZ851020 ecmf-d

Free Manuals Download Website

<http://myh66.com>

<http://usermanuals.us>

<http://www.somanuals.com>

<http://www.4manuals.cc>

<http://www.manual-lib.com>

<http://www.404manual.com>

<http://www.luxmanual.com>

<http://aubethermostatmanual.com>

Golf course search by state

<http://golfingnear.com>

Email search by domain

<http://emailbydomain.com>

Auto manuals search

<http://auto.somanuals.com>

TV manuals search

<http://tv.somanuals.com>