

# DENON

NETWORK CD RECEIVER

# RCD-N7

---

**Owner's Manual**

**Manuel de l'Utilisateur**

**Manual del usuario**



**SAFETY PRECAUTIONS**



**CAUTION:**  
**TO REDUCE THE RISK OF ELECTRIC SHOCK, DO NOT REMOVE COVER (OR BACK). NO USER-SERVICEABLE PARTS INSIDE. REFER SERVICING TO QUALIFIED SERVICE PERSONNEL.**

The lightning flash with arrowhead symbol, within an equilateral triangle, is intended to alert the user to the presence of uninsulated "dangerous voltage" within the product's enclosure that may be of sufficient magnitude to constitute a risk of electric shock to persons.

The exclamation point within an equilateral triangle is intended to alert the user to the presence of important operating and maintenance (servicing) instructions in the literature accompanying the appliance.

**WARNING:**  
**TO REDUCE THE RISK OF FIRE OR ELECTRIC SHOCK, DO NOT EXPOSE THIS APPLIANCE TO RAIN OR MOISTURE.**

**CAUTION:**  
**USE OF CONTROLS OR ADJUSTMENTS OR PERFORMANCE OF PROCEDURES OTHER THAN THOSE SPECIFIED HEREIN MAY RESULT IN HAZARDOUS RADIATION EXPOSURE.**  
**THIS PRODUCT SHOULD NOT BE ADJUSTED OR REPAIRED BY ANYONE EXCEPT PROPERLY QUALIFIED SERVICE PERSONNEL.**

**Laser Class (IEC 60825-1:2001)**

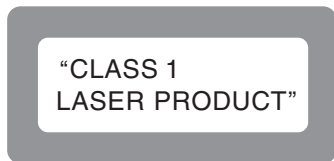

**IMPORTANT SAFETY INSTRUCTIONS**

1. Read these instructions.
2. Keep these instructions.
3. Heed all warnings.
4. Follow all instructions.
5. Do not use this apparatus near water.
6. Clean only with dry cloth.
7. Do not block any ventilation openings. Install in accordance with the manufacturer's instructions.
8. Do not install near any heat sources such as radiators, heat registers, stoves, or other apparatus (including amplifiers) that produce heat.
9. Do not defeat the safety purpose of the polarized or grounding-type plug. A polarized plug has two blades with one wider than the other. A grounding type plug has two blades and a third grounding prong. The wide blade or the third prong are provided for your safety. If the provided plug does not fit into your outlet, consult an electrician for replacement of the obsolete outlet.
10. Protect the power cord from being walked on or pinched particularly at plugs, convenience receptacles, and the point where they exit from the apparatus.
11. Only use attachments/accessories specified by the manufacturer.
12. Use only with the cart, stand, tripod, bracket, or table specified by the manufacturer, or sold with the apparatus. When a cart is used, use caution when moving the cart/apparatus combination to avoid injury from tip-over.
13. Unplug this apparatus during lightning storms or when unused for long periods of time.
14. Refer all servicing to qualified service personnel. Servicing is required when the apparatus has been damaged in any way, such as power-supply cord or plug is damaged, liquid has been spilled or objects have fallen into the apparatus, the apparatus has been exposed to rain or moisture, does not operate normally, or has been dropped.
15. Batteries shall not be exposed to excessive heat such as sunshine, fire or the like.



**FCC Information (For US customers)**

**1. COMPLIANCE INFORMATION**  
**Product Name: Network CD Receiver**  
**Model Number: RCD-N7**  
**This product contains FCC ID: PPO-CR8702G.**  
 This product complies with Part 15 of the FCC Rules. Operation is subject to the following two conditions: (1) this product may not cause harmful interference, and (2) this product must accept any interference received, including interference that may cause undesired operation.  
 Denon Electronics (USA), LLC  
 (a D & M Holdings Company)  
 100 Corporate Drive  
 Mahwah, NJ 07430-2041  
 Tel. (800) 497-8921

**2. IMPORTANT NOTICE: DO NOT MODIFY THIS PRODUCT**

This product, when installed as indicated in the instructions contained in this manual, meets FCC requirements. Modification not expressly approved by DENON may void your authority, granted by the FCC, to use the product.

**3. CAUTION**

- To comply with FCC RF exposure compliance requirement, separation distance of at least 20 cm must be maintained between the antenna of this product and all persons.
- This product and its antenna must not be co-located or operating in conjunction with any other antenna or transmitter.

**4. NOTE**

This product has been tested and found to comply with the limits for a Class B digital device, pursuant to Part 15 of the FCC Rules. These limits are designed to provide reasonable protection against harmful interference in a residential installation. This product generates, uses and can radiate radio frequency energy and, if not installed and used in accordance with the instructions, may cause harmful interference to radio communications. However, there is no guarantee that interference will not occur in a particular installation. If this product does cause harmful interference to radio or television reception, which can be determined by turning the product OFF and ON, the user is encouraged to try to correct the interference by one or more of the following measures:

- Reorient or relocate the receiving antenna.
- Increase the separation between the equipment and receiver.
- Connect the product into an outlet on a circuit different from that to which the receiver is connected.
- Consult the local retailer authorized to distribute this type of product or an experienced radio/TV technician for help.

**For Canadian customers:**

This Class B digital apparatus complies with Canadian ICES-003.  
 Cet appareil numérique de la classe B est conforme à la norme NMB-003 du Canada.

**IC Information (For Canadian customers)**

**1. PRODUCT**  
**This product contains IC 4491A-CR8702G.**  
 This product complies with RSS-210 of Industry Canada. Operation is subject to the following two conditions: (1) this product may not cause harmful interference, and (2) this product must accept any interference received, including interference that may cause undesired operation.  
 This Class B digital apparatus complies with Canadian ICES-003.

**APPAREIL**  
**Cet appareil contient IC 4491A-CR8702G.**  
 Cet appareil est conforme à la norme CNR-210 du Canada. L'utilisation de ce dispositif est autorisée seulement aux deux conditions suivantes : (1) il ne doit pas produire de brouillage, et (2) l'utilisateur du dispositif doit être prêt à accepter tout brouillage radioélectrique reçu, même si ce brouillage est susceptible de compromettre le fonctionnement du dispositif.  
 Cet appareil numérique de la classe B est conforme à la norme NMB-003 du Canada.

**2. CAUTION**

To reduce potential radio interference to other users, the antenna type and its gain should be so chosen that the equivalent isotropically radiated power (e.i.r.p.) is not more than that permitted for successful communication.

**ATTENTION**

Afin de réduire le risque d'interférence aux autres utilisateurs, il faut choisir le type d'antenne et son gain de façon à ce que la puissance isotrope rayonnée équivalente (p.i.r.e.) ne soit pas supérieure au niveau requis pour l'obtention d'une communication satisfaisante.

**CAUTION:**

To completely disconnect this product from the mains, disconnect the plug from the wall socket outlet.

The mains plug is used to completely interrupt the power supply to the unit and must be within easy access by the user.

**VORSICHT:**

Um dieses Gerät vollständig von der Stromversorgung abzutrennen, ziehen Sie bitte den Stecker aus der Wandsteckdose.

Der Netzstecker wird verwendet, um die Stromversorgung zum Gerät völlig zu unterbrechen; er muss für den Benutzer gut und einfach zu erreichen sein.

**PRECAUTION:**

Pour déconnecter complètement ce produit du courant secteur, débranchez la prise de la prise murale.

La prise secteur est utilisée pour couper complètement l'alimentation de l'appareil et l'utilisateur doit pouvoir y accéder facilement.

**ATTENZIONE:**

Per scollegare completamente questo prodotto dalla rete di alimentazione elettrica, scollegare la spina dalla relativa presa a muro.

La spina di rete viene utilizzata per interrompere completamente l'alimentazione all'unità e deve essere facilmente accessibile all'utente.

**PRECAUCIÓN:**

Para desconectar completamente este producto de la alimentación eléctrica, desconecte el enchufe del enchufe de la pared.

El enchufe de la alimentación eléctrica se utiliza para interrumpir por completo el suministro de alimentación eléctrica a la unidad y debe de encontrarse en un lugar al que el usuario tenga fácil acceso.

**WAARSCHUWING:**

Om de voeding van dit product volledig te onderbreken moet de stekker uit het stopcontact worden getrokken.

De netstekker wordt gebruikt om de stroomtoevoer naar het toestel volledig te onderbreken en moet voor de gebruiker gemakkelijk bereikbaar zijn.

**FÖRSIKTIHETSMÅTT:**

Koppla loss stickproppen från eluttaget för att helt skilja produkten från nätet.

Stickproppen används för att helt bryta strömförsörjningen till apparaten, och den måste vara lättillgänglig för användaren.

**NOTE ON USE / OBSERVATIONS RELATIVES A L'UTILISATION / NOTAS SOBRE EL USO**

WARNINGS	AVERTISSEMENTS	ADVERTENCIAS
<ul style="list-style-type: none"> <li>• Avoid high temperatures. Allow for sufficient heat dispersion when installed in a rack.</li> <li>• Handle the power cord carefully. Hold the plug when unplugging the cord.</li> <li>• Keep the unit free from moisture, water, and dust.</li> <li>• Unplug the power cord when not using the unit for long periods of time.</li> <li>• Do not obstruct the ventilation holes.</li> <li>• Do not let foreign objects into the unit.</li> <li>• Do not let insecticides, benzene, water, and thinner come in contact with the unit.</li> <li>• Never disassemble or modify the unit in any way.</li> <li>• Ventilation should not be impeded by covering the ventilation openings with items, such as newspapers, tablecloths or curtains.</li> <li>• Naked flame sources such as lighted candles should not be placed on the unit.</li> <li>• Observe and follow local regulations regarding battery disposal.</li> <li>• Do not expose the unit to dripping or splashing fluids.</li> <li>• Do not place objects filled with liquids, such as vases, on the unit.</li> <li>• Do not handle the mains cord with wet hands.</li> <li>• When the switch is in the OFF position, the equipment is not completely switched off from MAINS.</li> <li>• The equipment shall be installed near the power supply so that the power supply is easily accessible.</li> </ul>	<ul style="list-style-type: none"> <li>• Eviter des températures élevées. Tenir compte d'une dispersion de chaleur suffisante lors de l'installation sur une étagère.</li> <li>• Manipuler le cordon d'alimentation avec précaution. Tenir la prise lors du débranchement du cordon.</li> <li>• Protéger l'appareil contre l'humidité, l'eau et la poussière.</li> <li>• Débrancher le cordon d'alimentation lorsque l'appareil n'est pas utilisé pendant de longues périodes.</li> <li>• Ne pas obstruer les trous d'aération.</li> <li>• Ne pas laisser des objets étrangers dans l'appareil.</li> <li>• Ne pas mettre en contact des insecticides, du benzène et un diluant avec l'appareil.</li> <li>• Ne jamais démonter ou modifier l'appareil d'une manière ou d'une autre.</li> <li>• Ne pas recouvrir les orifices de ventilation avec des objets tels que des journaux, nappes ou rideaux. Cela entraverait la ventilation.</li> <li>• Ne jamais placer de flamme nue sur l'appareil, notamment des bougies allumées.</li> <li>• Veillez à respecter les lois en vigueur lorsque vous jetez les piles usagées.</li> <li>• L'appareil ne doit pas être exposé à l'eau ou à l'humidité.</li> <li>• Ne pas poser d'objet contenant du liquide, par exemple un vase, sur l'appareil.</li> <li>• Ne pas manipuler le cordon d'alimentation avec les mains mouillées.</li> <li>• Lorsque l'interrupteur est sur la position OFF, l'appareil n'est pas complètement déconnecté du SECTEUR (MAINS).</li> <li>• L'appareil sera installé près de la source d'alimentation, de sorte que cette dernière soit facilement accessible.</li> </ul>	<ul style="list-style-type: none"> <li>• Evite altas temperaturas. Permite la suficiente dispersión del calor cuando está instalado en la consola.</li> <li>• Maneje el cordón de energía con cuidado. Sostenga el enchufe cuando desconecte el cordón de energía.</li> <li>• Mantenga el equipo libre de humedad, agua y polvo.</li> <li>• Desconecte el cordón de energía cuando no utilice el equipo por mucho tiempo.</li> <li>• No obstruya los orificios de ventilación.</li> <li>• No deje objetos extraños dentro del equipo.</li> <li>• No permita el contacto de insecticidas, gasolina y diluyentes con el equipo.</li> <li>• Nunca desarme o modifique el equipo de ninguna manera.</li> <li>• La ventilación no debe quedar obstruida por haberse cubierto las aperturas con objetos como periódicos, manteles o cortinas.</li> <li>• No deberán colocarse sobre el aparato fuentes inflamables sin protección, como velas encendidas.</li> <li>• A la hora de deshacerse de las pilas, respete la normativa para el cuidado del medio ambiente.</li> <li>• No exponer el aparato al goteo o salpicaduras cuando se utilice.</li> <li>• No colocar sobre el aparato objetos llenos de líquido, como jarros.</li> <li>• No maneje el cable de alimentación con las manos mojadas.</li> <li>• Cuando el interruptor está en la posición OFF, el equipo no está completamente desconectado de la alimentación MAINS.</li> <li>• El equipo se instalará cerca de la fuente de alimentación de manera que resulte fácil acceder a ella.</li> </ul>

**CAUTIONS ON INSTALLATION / PRÉCAUTIONS D'INSTALLATION / EMPLAZAMIENTO DE LA INSTALACIÓN**

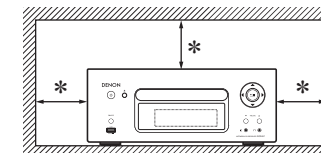

- \* For proper heat dispersal, do not install this unit in a confined space, such as a bookcase or similar enclosure.
  - More than 0.3 m (12 in.) is recommended.
  - Do not place any other equipment on this unit.
- \* Pour permettre la dissipation de chaleur requise, n'installez pas cette unité dans un espace confiné tel qu'une bibliothèque ou un endroit similaire.
  - Une distance de plus de 0,3 m (12 po.) est recommandée.
  - Ne placez aucun matériel sur cet appareil.
- \* Para la dispersión del calor adecuadamente, no instale este equipo en un lugar confinado tal como una librería o unidad similar.
  - Se recomienda dejar más de 0,3 m (12 pulg.) alrededor.
  - No coloque ningún otro equipo sobre la unidad.

## Contents

<b>Getting started</b> .....	2
<b>Accessories</b> .....	2
<b>Main features</b> .....	2
<b>Cautions on handling</b> .....	2
<b>About this manual</b> .....	2
<b>Discs</b> .....	3
Discs playable on this unit .....	3
Holding discs .....	3
Loading discs .....	3
Cautions on loading discs .....	3
Cautions on handling .....	3
Cautions on storing discs .....	3
Cleaning discs .....	3
<b>About the remote control</b> .....	4
Inserting the batteries .....	4
Operating range of the remote control .....	4
<b>Connections</b> .....	5
<b>Speaker connections</b> .....	5
Connecting the speaker cables .....	5
<b>Connecting recording components</b> .....	6
CD recorder / MD recorder .....	6
<b>Connecting a TV</b> .....	6
<b>Connecting an antenna</b> .....	7
FM/AM .....	7
<b>Connecting to a home network (LAN)</b> .....	8
Wired LAN .....	8
Wireless LAN .....	8
Required system .....	8
<b>Connecting an iPod</b> .....	9
iPod Dock .....	9
USB port .....	9
<b>Connecting a USB memory device</b> .....	9
<b>Connecting a portable player</b> .....	10
<b>Connecting the power cord</b> .....	10
<b>Basic operations</b> .....	11
<b>Preparations</b> .....	11
Turning the power on .....	11
Turning the power off .....	11
Setting the current time (Auto Adjust) (12-Hour Display) .....	11
<b>Operations possible during playback</b> .....	12
Input source switching .....	12
Adjusting the master volume .....	12
Muting the sound .....	12
Adjusting the tone .....	12
Setting the sleep timer .....	13

Switching the display's brightness .....	13
Listening with headphones .....	13
<b>CD playback</b> .....	13
Before playing a disc .....	13
Playing CDs .....	13
Switching the display .....	13
Playing repeatedly (Repeat playback) .....	14
Playing random order (Random playback) .....	14
Playing tracks in the desired order (Program playback) .....	14
<b>MP3 and WMA files playback</b> .....	15
Playing files .....	15
<b>Tuner playback</b> .....	16
Tuning in Broadcast Stations .....	16
Automatically presetting FM stations (Auto preset) .....	16
Presetting FM/AM stations manually .....	17
Listening to preset stations .....	17
Calling stations registered in Preset List .....	17
Deleting stations registered in Preset List .....	17
<b>iPod® playback</b> .....	17
Before playing an iPod .....	17
Playing an iPod .....	17
Disconnecting the iPod .....	18
<b>USB memory device playback</b> .....	18
Before playing a USB memory device or an iPod .....	18
Playing files stored on USB memory devices .....	18
<b>Network audio playback</b> .....	19
Listening to internet radio .....	19
Playing files stored on a music server .....	20
Listening to Napster .....	21
Listening to Pandora .....	22
Listening to Rhapsody .....	24
<b>Portable audio player playback</b> .....	25
Playing portable audio player .....	25
<b>Listening to AUX</b> .....	25
<b>Favorite function</b> .....	26
Registering Internet radio stations, music servers and tuners in Favorite List .....	26
Calling Internet radio stations, files registered or tuners in Favorite List .....	26
Deleting Internet radio stations, files registered or tuners in Favorite List .....	26

<b>Advanced operations</b> .....	27
<b>Menu map</b> .....	27
<b>Setting the timer [Timer]</b> .....	28
Setting the everyday timer and once timer .....	28
<b>Adjusting the clock automatically [Clock]</b> .....	29
Setting the Time Zone .....	29
Setting the Summer Time .....	29
Auto Adjust .....	29
Setting the current time (Manual Adjust) (12-Hour Display) .....	29

<b>Setting the network [Network]</b> .....	30
Connecting Wired LAN .....	30
Connecting Wireless LAN .....	31
Party Mode Function .....	33
Other Network .....	34
<b>Setting the others [Other]</b> .....	35
Auto Standby .....	35
Screen Saver .....	35
Using an optimizing filter .....	35
Firmware Update .....	35
<b>Other functions</b> .....	36
Inputting characters .....	36
Auto power on .....	37
Last function memory .....	37
Resetting the microprocessor .....	37

<b>Information</b> .....	38
<b>Part names and functions</b> .....	38
Front panel .....	38
Top panel .....	39
Rear panel .....	39
Remote control .....	40
<b>MP3 and WMA</b> .....	43
MP3 and WMA formats .....	43
<b>iPod®</b> .....	43
<b>USB memory device</b> .....	44
Important information .....	44
<b>Network audio</b> .....	45
Important information .....	45

<b>Explanation terms</b> .....	46
--------------------------------	----

<b>Troubleshooting</b> .....	47
------------------------------	----

<b>Specifications</b> .....	51
-----------------------------	----

<b>Index</b> .....	52
--------------------	----

# Getting started

Thank you for purchasing this DENON product. To ensure proper operation, please read these owner's manual carefully before using the product.

After reading them, be sure to keep them for future reference.

## Accessories

Check that the following parts are supplied with the product.

① Remote control.....	1
② R03/AAA batteries.....	2
③ AC Power cord (Cord length: Approx. 6 ft/2 m).....	1
④ AM loop antenna .....	1
⑤ FM indoor antenna .....	1
⑥ Rod antenna for wireless LAN .....	1
⑦ Owner's manual (with Quick setup sheet).....	1
⑧ Service station list .....	1
⑨ Warranty (for North America model only).....	1

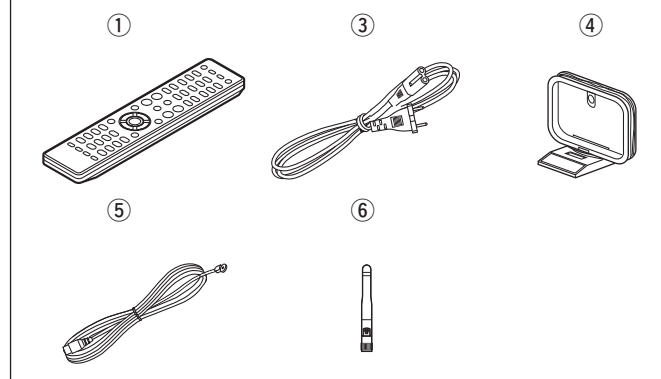

## Main features

High quality & high power digital amplifier

DLNA ver. 1.5 supported for Audio Network

Internet radio by vTuner

Equipped with a dock connector that directly connects an iPod or iPhone to this unit

Equipped with Wi-Fi capabilities including Wi-Fi Protected Setup (WPS)

Equipped with a filter for optimizing the response of the speakers (sold separately)

3Lines OELD  
(Organic Electroluminescence Display)

Stylish & compact cabinet

## Cautions on handling

### • Before turning the power switch on

Check once again that all connections are correct and that there are no problems with the connection cables.

• Power is supplied to some of the circuitry even when the unit is set to the standby mode. When going on vacation or leaving home for long periods of time, be sure to unplug the power cord from the power outlet.

### • Proper ventilation

If the unit is left in a room full of smoke from cigarettes, etc., for long periods of time, the surface of the optical pickup may get dirty, preventing it from receiving signals properly.

### • About condensation

If there is a major difference in temperature between the inside of the unit and its surroundings, condensation may form on parts inside the unit, causing it to fail to operate properly.

If this happens, let the unit sit for an hour or two with the power turned off and wait until there is little difference in temperature before using the unit.

### • Cautions on using mobile phones

Using a mobile phone near this unit may result in noise. If that occurs, move the mobile phone away from the unit when it is in use.

### • Moving the unit

Turn off the power and unplug the power cord from the power outlet. Next, disconnect the cables connected to other system units before moving the unit.

## About this manual

### ❑ Operation buttons

The operations described in this manual are based mainly on remote control operation.

### ❑ Symbols



This symbol indicates a reference page on which related information is described.



This symbol indicates a supplementary information and tips for operations.

**NOTE**

This symbol indicates points to remember operations or function limitations.

### ❑ Illustrations

Note that the illustrations in these instructions may differ from the actual unit for explanation purposes.

## Discs

### Discs playable on this unit

#### 1 Music CDs

Discs marked with the logo below can be played in this unit.



#### 2 CD-R/CD-RW

##### NOTE

- Discs in special shapes (heart-shaped discs, octagonal discs, etc.) cannot be played. Do not attempt to play them, as doing so can damage the unit.
- Some discs and some recording formats cannot be played.
- Non-finalized discs cannot be played.
- What is finalization?  
Finalization is the process that makes recorded CD-R/CD-RW discs playable on compatible players.



### Holding discs



Do not touch the signal surface.

### Loading discs

- Place the disc in the tray, label side up.
- Make sure the disc tray is fully open when inserting the disc.
- Place the discs flat, 12 cm discs in the outer tray guide (Figure 1), 8 cm discs in the inner tray guide (Figure 2).

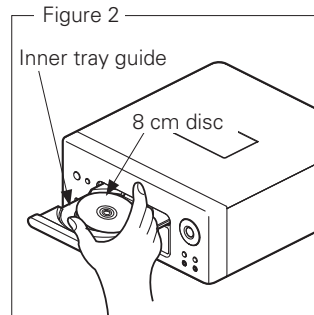
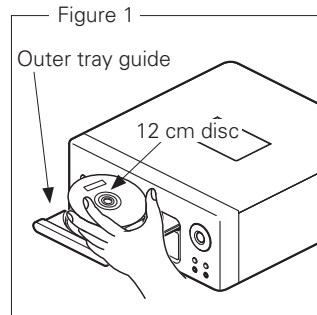

- Place 8 cm discs in the inner tray guide without using an adapter.



- "Unsupported" is displayed if a disc that cannot be played is loaded.
- "No Disc" is displayed if the disc is loaded upside-down or if no disc is loaded.

##### NOTE

Do not push the disc tray in by hand when the power is turned off. Doing so could damage the set.

### Cautions on loading discs

- Only load one disc at a time. Loading two or more discs can damage the unit or scratch the discs.
- Do not use cracked or warped discs or discs that have been repaired with adhesive, etc.
- Do not use discs on which the sticky part of cellophane tape or labels is exposed or on which there are traces of where labels have been removed. Such discs can get caught inside the player and damage it.

### Cautions on handling

- Do not get fingerprints, oil or dirt on discs.
- Take special care not to scratch discs when removing them from their cases.
- Do not bend or heat discs.
- Do not enlarge the hole in the center.
- Do not write on the labeled (printed) surface with ball-point pens, pencils, etc., or stick new labels on discs.
- Water droplets may form on discs if they are moved suddenly from a cold place (outdoors for example) to a warm place, but do not try to dry them off using a hairdryer, etc.

### Cautions on storing discs

- Be sure to remove discs after using them.
- Be sure to store discs in their cases to protect them from dust, scratches, warping, etc.
- Do not store discs in the following places:
  - Places exposed to direct sunlight for long periods of time
  - Dusty or humid places
  - Places exposed to heat from heaters, etc.

### Cleaning discs

- If there are fingerprints or dirt on a disc, wipe them off before using the disc. Fingerprints and dirt can impair sound quality and cause interruptions in playback.
- Use a commercially available disc cleaning set or a soft cloth to clean discs.

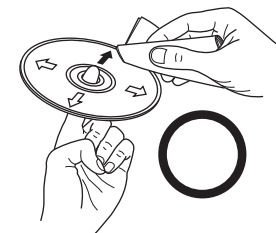

Gently wipe the disc from the inside towards the outside.

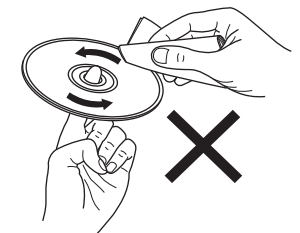

Do not wipe in a circular motion.

##### NOTE

Do not use record spray, antistatic agents, benzene, thinner or other solvents.

## About the remote control

### Inserting the batteries

- ① Remove the rear cover of the remote control.
- ② Set two R03/AAA batteries in the battery compartment in the indicated direction.

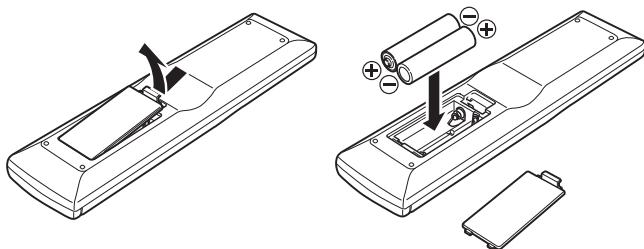

- ③ Put the rear cover back on.

#### NOTE

- Insert the specified batteries in the remote control unit.
- Replace the batteries with new ones if the set does not operate even when the remote control unit is operated close to the unit. (The supplied batteries are only for verifying operation.)
- When inserting the batteries, be sure to do so in the proper direction, following the ⊕ and ⊖ marks in the battery compartment.
- To prevent damage or leakage of battery fluid:
  - Do not use a new battery together with an old one.
  - Do not use two different types of batteries.
  - Do not attempt to charge dry batteries.
  - Do not short-circuit, disassemble, heat or dispose of batteries in flames.
  - Do not keep the battery in a place exposed to direct sunlight or in places with extremely high temperatures, such as near a heater.
- If the battery fluid should leak, carefully wipe the fluid off the inside of the battery compartment and insert new batteries.
- Remove the batteries from the remote control unit if it will not be in use for long periods.
- Used batteries should be disposed of in accordance with the local regulations regarding battery disposal.

### Operating range of the remote control

Operate the remote control while pointing it at the remote sensor.

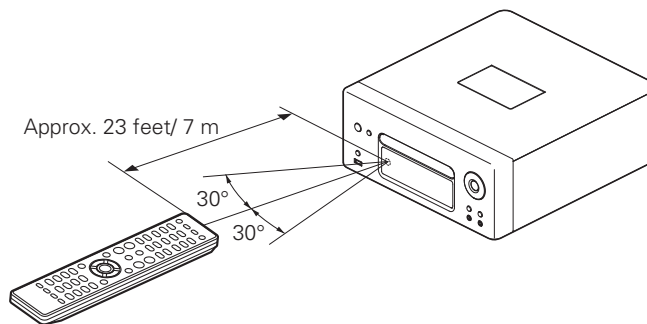

#### NOTE

The set may function improperly or the remote control may not operate if the remote control sensor is exposed in direct sunlight or strong artificial light such as a fluorescent or infrared light.



# Connections

This section explains how to connect speakers, recording equipment, antennas and network.

For other connections, see the sections below.

## NOTE

- Do not plug in the power cord until all connections have been completed.
- When making connections, also refer to the owner's manual of the other components.
- Be sure to connect the left and right channels properly (left with left, right with right).
- Do not bundle power supply cords together with connection cables. Doing so can result in humming or noise.

## Speaker connections

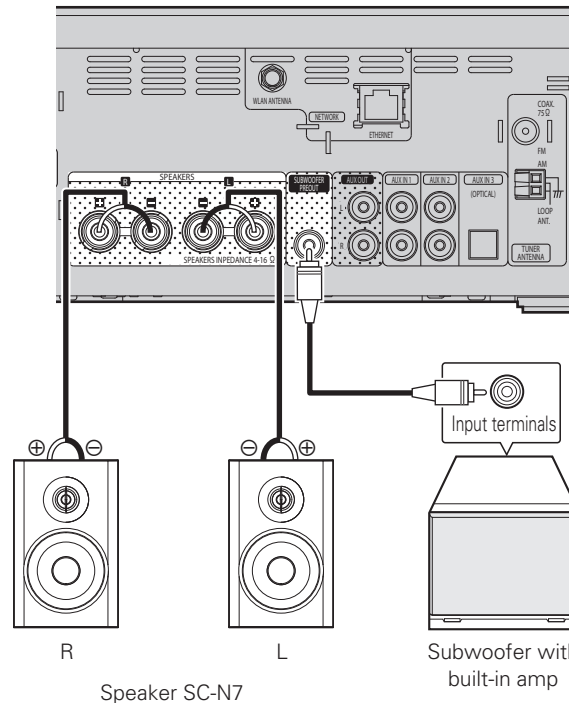
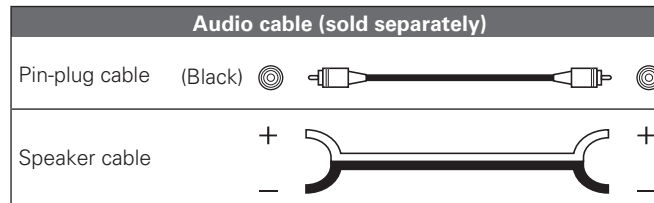

## NOTE

Be sure to lower the audio volume before making speaker settings.

## Connecting the speaker cables

Carefully check the left (L) and right (R) channels and + (red) and - (black) polarities on the speakers being connected to the unit, and be sure to connect the channels and polarities correctly.

**1** Peel off about 10 mm of sheathing from the tip of the speaker cable, then either twist the core wire tightly or apply solder to it.



**2** Turn the speaker terminal counterclockwise to loosen it.



**3** Insert the speaker cable's core wire to all the way into the speaker terminal.



**4** Turn the speaker terminal clockwise to tighten it.



## NOTE

- Use speakers with an impedance of 4 to 16  $\Omega$ . The protection circuit may be activated if speakers with an impedance other than specified are used.
- Connect the speaker cables so they do not stick out of the speaker terminals. The protection circuit may be activated if the wires touch the rear panel or if the + and - sides touch each other (see page 6 "Protection circuit").
- Never touch the speaker terminals while the power supply is connected. Doing so could result in electric shock.
- When you connect optional speakers (SC-N7) to this unit, you can perform the filter setting for optimal sound quality output (see page 35 "Using an optimizing filter").

Speaker connections

Protection circuit

The protection circuit is activated in the following situations:

- If the speaker cable wire touches the rear panel or screws or if the speaker cable wire touches the speaker cable's + and - sides are touching
- If the surrounding temperature is extremely high
- If the inside of the amplifier gets hot to extended use at a high output

If this happens, unplug the power cord, then check the connections of the speaker cables and input cables. If the unit becomes very hot, wait for it to cool off and improve the ventilation around it. After doing this, plug the power cord back in.

If the protection circuit is activated even though there are no problems with the ventilation around the unit or in connections, the unit may be damaged. Turn off the power and then contact a DENON service center.

Connecting recording components

CD recorder / MD recorder

Cables used for connections

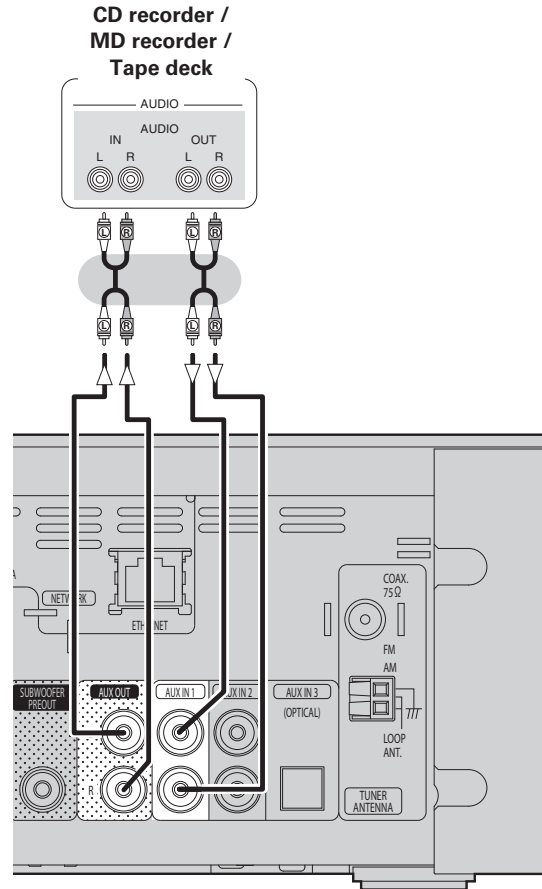
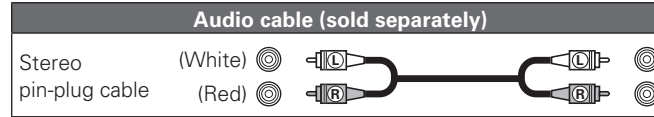

Connecting a TV

- Select the connector to use and connect the device.
- To listen to TV audio through this device, use the optical digital connection.

Cables used for connections

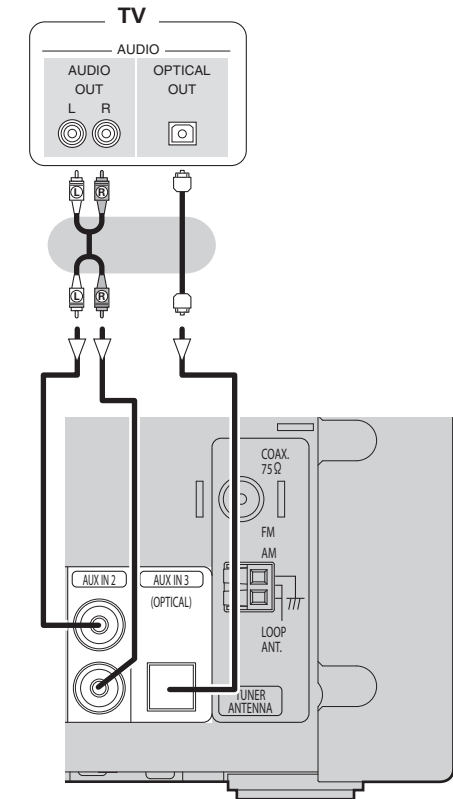
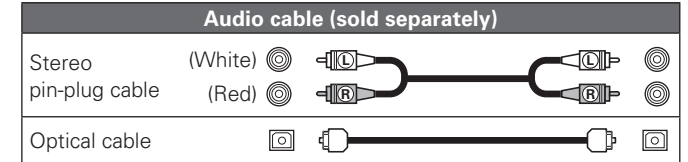

NOTE

Other digital audio signals than 2 channel linear PCM cannot be input through AUX IN 3 (OPTICAL) terminal of this unit. When you try to input digital audio signals other than 2 channel linear PCM to this unit, set the digital audio output setting of the TV to 2 channel PCM. For details, see the operating instructions of the TV.

# Connecting an antenna

## FM/AM

- Connect the FM antenna or AM loop antenna supplied with the unit to enjoy listening to radio broadcasts.
- After connecting the antenna and receiving a broadcast signal (see page 16 "Tuning in Broadcast Stations"), fix the antenna with tape in a position where the noise level becomes minimal.

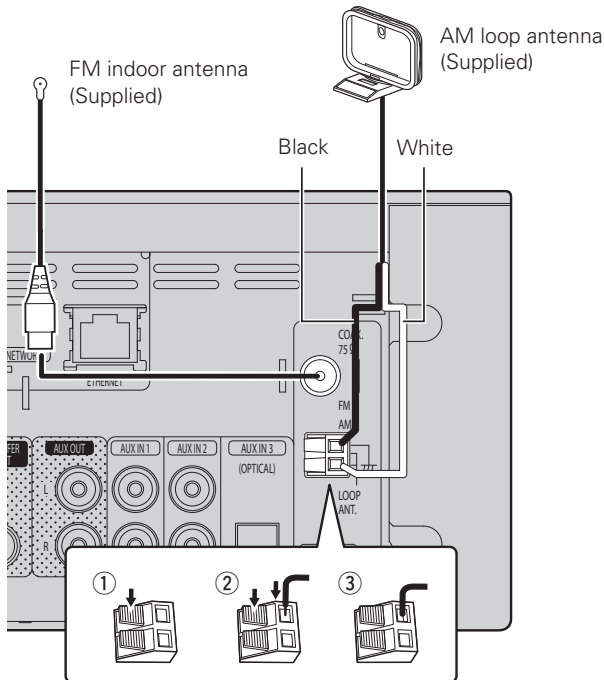

### NOTE

- Do not connect two FM antennas simultaneously.
- Even if an external AM antenna is used, do not disconnect the AM loop antenna.
- Make sure the AM loop antenna lead terminals do not touch metal parts of the panel.
- If the signal has noise interference, connect the ground terminal (GND) to reduce noise.
- If you are unable to receive a good broadcast signal, we recommend installing an outdoor antenna. For details, inquire at the retail store where you purchased the unit.

### AM loop antenna assembly

- 1 Put the stand section through the bottom of the loop antenna from the rear and bend it forward.

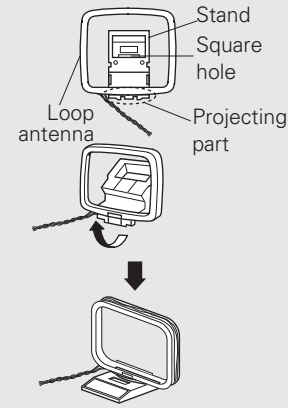

- 2 Insert the projecting part into the square hole in the stand.

### Using the AM loop antenna

#### Suspending on a wall

Suspend directly on a wall without assembling.

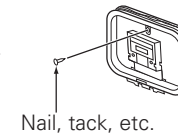

#### Standing alone

Use the procedure shown upper to assemble.

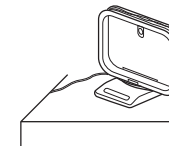

## Connecting to a home network (LAN)

- This unit lets you play via your home network (LAN) music files stored on a computer and music content such as that from Internet radio.
- You can update by downloading the latest firmware from the DENON website.
- See "Setting the network [Network]" (page 30) on the menu for more information on network setting.

### Wired LAN

#### Cables used for connections

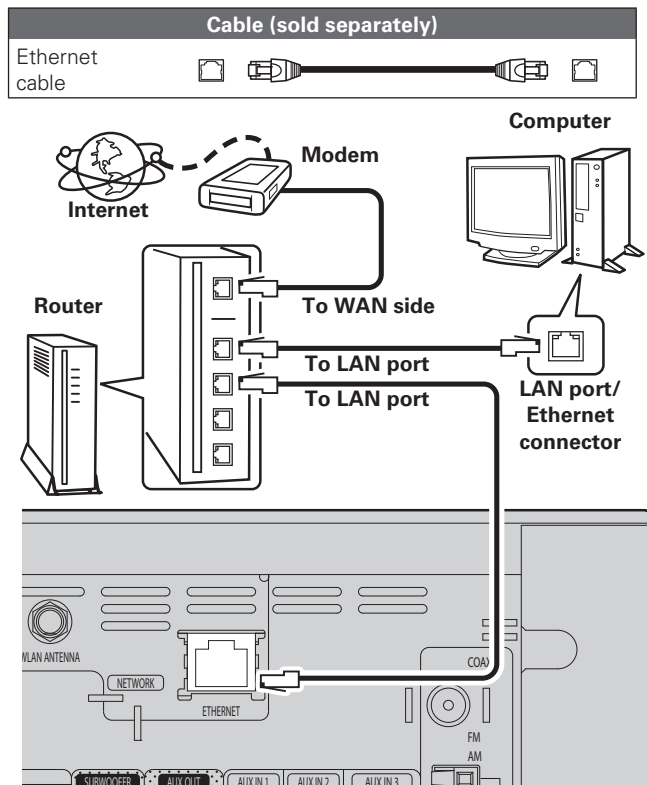

**For connections to the Internet, contact an ISP (Internet Service Provider) or a computer shop.**

### Wireless LAN

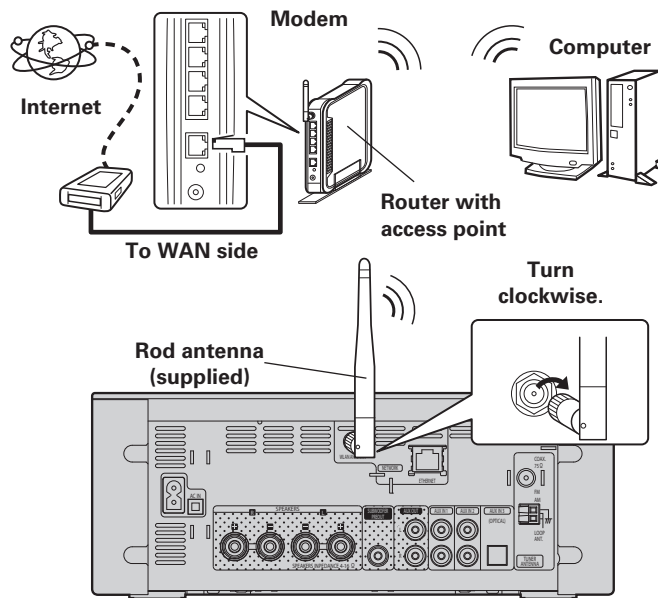

### Required system

#### ❑ Broadband internet connection

#### ❑ Modem

Device that connects to the broadband circuit and conducts communications on the Internet.

A type that is integrated with a router is also available.

#### ❑ Router

When using this unit, we recommend you use a router equipped with the following functions:

- Built-in DHCP server  
This function automatically assigns IP addresses on the LAN.
- Built-in 100BASE-TX switch  
When connecting multiple devices, we recommend a switching hub with a speed of 100 Mbps or greater.
- When using with a wireless LAN, prepare a broadband router with built-in access point.

#### ❑ Ethernet cable (CAT-5 or greater recommended)

- Use only shielded STP or ScTP LAN cable which is available at retailer.
- Some flat type Ethernet cables are easily affected by noise. We recommend using a normal type cable.



- If you have an Internet provider contract for a line on which network settings are made manually, make the settings at "Network connecting (DHCP=Off)" (page 30).
- With this unit, it is possible to use the DHCP and Auto IP functions to make the network settings automatically.
- When using this unit with the broadband router's DHCP function enabled, this unit automatically performs the IP address setting and other settings. When using this unit connected to a network with no DHCP function, make the settings for the IP address, etc., at "Network connecting (DHCP=Off)" (page 30).
- When setting manually, check the setting contents with the network administrator.

#### NOTE

- A contract with an ISP is required to connect to the Internet. No additional contract is needed if you already have a broadband connection to the Internet.
- The types of routers that can be used depend on the ISP. Contact an ISP or a computer shop for details.
- DENON assumes no responsibility whatsoever for any communication errors or troubles resulting from customer's network environment or connected devices.
- This unit is not compatible with PPPoE. A PPPoE-compatible router is required if you have a contract for a type of line set by PPPoE.
- Do not connect an ETHERNET connector directly to the LAN port/Ethernet connector on your computer.

# Connecting an iPod

## iPod Dock

Open the lid and mount the adapter suited for your iPod onto the dock adapter included with your iPod.

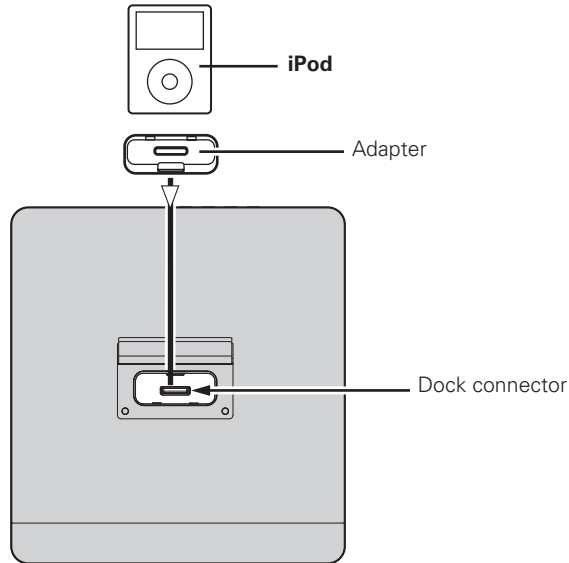

**NOTE**

- Please make sure to fit adaptor to connector part for use with your iPod.
- When plugging in or unplugging the iPod, please proceed carefully, adjusting the inclination of the connector so as not to place a burden upon the connector.

### Loading

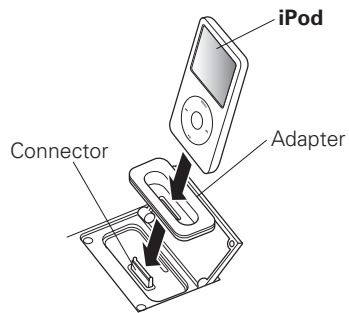

### Dismantling

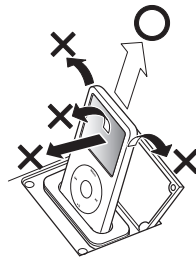

- Keep the dock for iPod's lid closed when your iPod is not connected to prevent any foreign objects from getting inside.
- You can use this unit to perform playback via an iPod (5th generation or later), iPhone (3GS or earlier), iPod touch, iPod classic, or iPod nano. For details, check the Web ([www.denson.com](http://www.denon.com)).

## USB port

### Cables used for connections

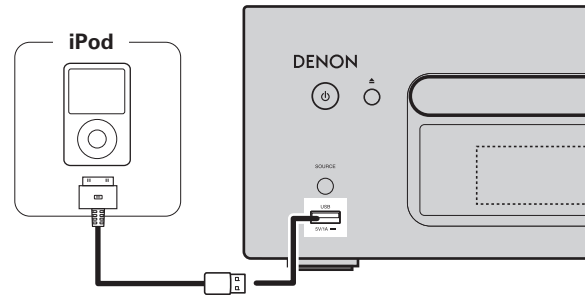
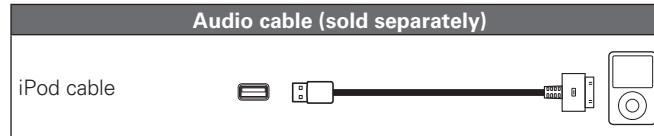

To connect an iPod to this unit, use the iPod cable supplied with the iPod.

# Connecting a USB memory device

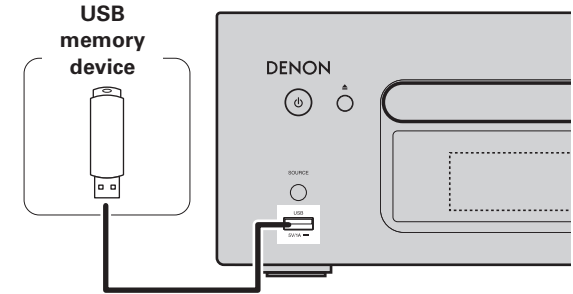

**NOTE**

- A computer can not be connected to and operate the unit via its USB port.
- Do not use an extension cable when connecting a USB memory device.
- For details about USB memory devices, see "USB memory device" (page 44).

## Connecting a portable player

### Cables used for connections

#### Audio cable (sold separately)

Stereo  
mini-plug  
cable

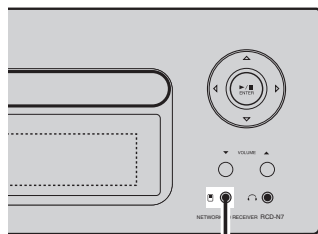

Connect this unit and portable audio player using a separately sold mini-stereo audio cable.

#### NOTE

After you connect a portable audio player, the input source automatically switches to "Portable In".

## Connecting the power cord

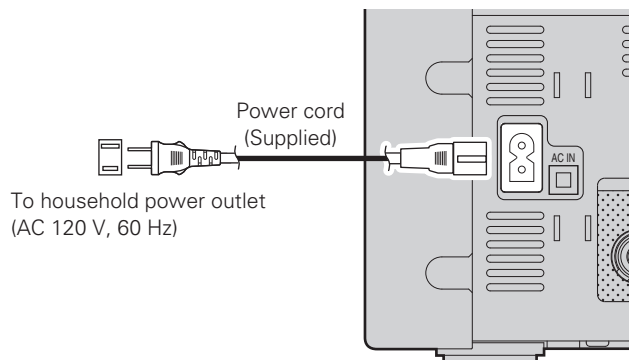

#### NOTE

- Only use the supplied power cord.
- Be sure the power cord is unplugged from the power outlet before connecting or disconnecting it to the AC IN.

# Basic operations

**Symbols used to indicate buttons in this manual**

- Button located on both the main unit and the remote control → **BUTTON**
- Button only on the main unit → **<BUTTON>**
- Button only on the remote control → **[BUTTON]**

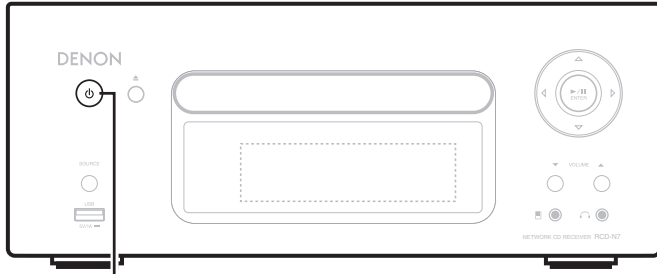

ON/STANDBY

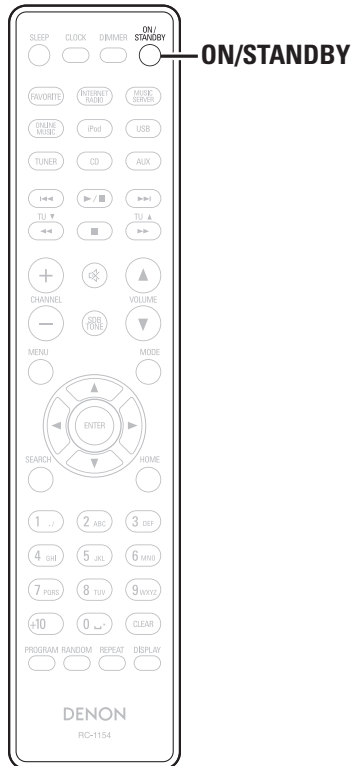

This section provides information on basic operations such as settings and playback procedures. For other operations, see the sections below.

- ❑ **Setting the timer [Timer]** (👉 page 28)
- ❑ **Setting the others [Other]** (👉 page 35)

## Preparations

### Turning the power on

Press **ON/STANDBY**.

- The power turns on. Press again to set the power to standby.
- Power indicator
  - Standby .....Off
  - Power on.....Green
  - When the timer is set .....Orange

#### NOTE

- When you turn on the power of this unit for the first time after purchasing it, the Network First Setup menu starts up.
- If you cancelled "Network First Setup" or changed the network environment, perform "Menu" - "Network" - "Network First Setup".
- Power continues to be supplied to some of the circuitry even when the power is in the standby mode. When leaving home for long periods of time, either press **ON/STANDBY** to turn off the power, or unplug the power cord from the power outlet.
- Be sure to stop playback before turning the power off.

#### ❑ Completely turning off the power

Unplug the power cord from the wall outlet.

- Note that the time setting is cleared when the power cord is unplugged from the outlet.
- The settings made for the various functions may be cleared if the power cord is left unplugged from a power outlet for an extended period of time.

### Turning the power off

Press **ON/STANDBY**.

The power indicator turns off, and so does the power.

#### NOTE

Be sure to stop playback before turning the power off.

### Setting the current time (Auto Adjust) (12-Hour Display)

- When the unit is connected to the Internet, the current time is set automatically.
- The default Time Zone setting of this unit is the Eastern Standard Time zone. To change the Time Zone and Summer Time, see "Adjusting the clock automatically [Clock]" (👉 page 29).
- When the unit is not connected to the Internet, set the current time manually. See "Setting the current time (Manual Adjust) (12-Hour Display)" (👉 page 29).

**Symbols used to indicate buttons in this manual**

- Button located on both the main unit and the remote control → **BUTTON**
- Button only on the main unit → **<BUTTON>**
- Button only on the remote control → **[BUTTON]**

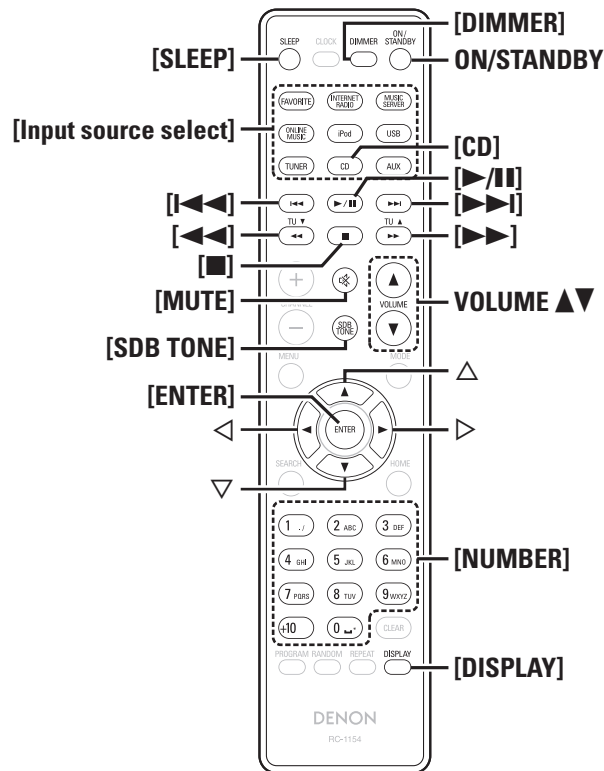
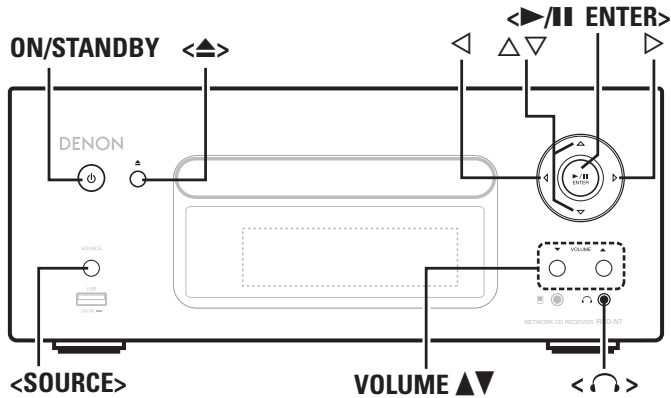

## Operations possible during playback

### Input source switching

Press **<SOURCE>** and  $\Delta$ / $\nabla$  to select the input source, then press **[ENTER]**, **<▶/|| ENTER>** or **▶**.

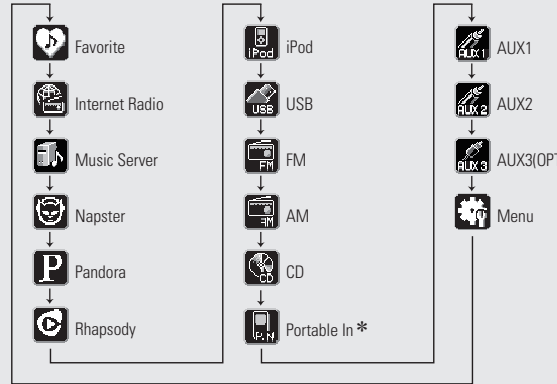

\* "Portable In" appears only when the portable audio player is connected to portable in jack.

Press **[Input source select]** (**[FAVORITE]**, **[INTERNET RADIO]**, **[MUSIC SERVER]**, **[ONLINE MUSIC]**, **[iPod]**, **[USB]**, **[TUNER]**, **[CD]** or **[AUX]**).

### Adjusting the master volume

Press **VOLUME  $\Delta$ / $\nabla$** .  
The volume level is displayed.

**[Adjustable range]**

**VOLUME 0 - 60** Default is "3".

### Muting the sound

Press **[MUTE]**.  
"MUTING" is displayed.

To cancel, press **[MUTE]** again.  
(The mute mode is also canceled when **VOLUME  $\Delta$ / $\nabla$**  is pressed.)

### Adjusting the tone

**1** Use **[SDB TONE]** to select the tone parameter to be adjusted.

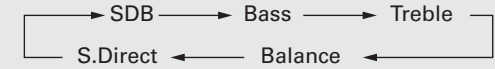

**2** Adjust the volume with **<▶>**.

- To make other tone adjustments at this time, press **[SDB TONE]**.
- If no operation is performed for 5 seconds, the adjustment is retained and the normal display reappears.

<b>SDB</b>	Emphasize the bass sound. (Super Dynamic Bass)
<b>[Selectable modes]</b>	<b>ON</b> - <b>OFF</b>
<b>BASS</b>	Adjusts the bass sound.
<b>[Variable range]</b>	<b>-10dB</b> - <b>+10dB</b>
<b>TREBLE</b>	Adjusts the treble sound.
<b>[Variable range]</b>	<b>-10dB</b> - <b>+10dB</b>
<b>BALANCE</b>	Adjusts the left/right volume balance.
<b>[Variable range]</b>	<b>L6</b> - <b>CENTER</b> - <b>R6</b>
<b>S.DIRECT</b>	The tone is not adjusted. This can also be set using (SOURCE DIRECT).

- Settings made upon purchase:
- SDB.....OFF
  - BASS.....0dB
  - TREBLE.....0dB
  - BALANCE.....CENTER

SDB, BASS and TREBLE can be set simultaneously.



## Setting the sleep timer

Use this function to automatically switch the power to the standby mode after a specific amount of time (minutes).

The sleep timer can be set to up to 90 minutes, in steps of 10 minutes.

### Press [SLEEP] during playback and select the setting time.

- Press the button to select the setting time.
- After about 5 seconds, the setting is entered and the display returns to as it was before.

### ❑ Canceling the sleep timer

Either press [SLEEP] to select "Sleep▶OFF" or press ON/STANDBY.

### ❑ To check the time remaining until the sleep timer is activated

Press [SLEEP].

## Switching the display's brightness

Press [DIMMER].

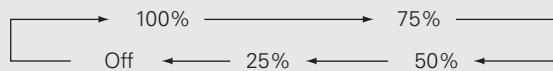

- The display's brightness switches each time the button is pressed.



If you operate the buttons when the display's brightness is set to "Off", the display temporarily lights at 25% brightness level.

## Listening with headphones

Plug the headphones (sold separately) into <img alt="headphone jack icon" data-bbox="265 725 285 745"/>.

- The sound from the speakers is automatically cut off.

### NOTE

To prevent hearing loss, do not raise the volume level excessively when using headphones.



## CD playback

This section explains how to playback CDs.

### Before playing a disc

#### 1 Press ON/STANDBY.

#### 2 Press <SOURCE> and to select to "

If no disc is loaded "No Disc" is displayed.

#### 3 Insert a disc ( page 3).

- Press <img alt="left/right arrow icon" data-bbox="375 285 395 305"/> to open/close the disc tray.
- The disc tray also closes when <img alt="left/right arrow icon" data-bbox="375 305 395 325"/> [ENTER] or <img alt="right arrow icon" data-bbox="415 305 435 325"/> is pressed.

### NOTE



- Do not place any foreign objects in the disc tray. Doing so could damage it.
- Do not push the disc tray in by hand when the power is turned off. Doing so could damage the set.

## Playing CDs

Press <img alt="left/right arrow icon" data-bbox="375 485 395 505"/> [ENTER] or <img alt="right arrow icon" data-bbox="415 485 435 505"/>.

The "



- If the input source is set to something other than "- The input source can also be switched to " page 12).

### ❑ Stopping playback

Press [■].

### ❑ Stopping playback temporarily

Press <img alt="left/right arrow icon" data-bbox="675 160 695 180"/> [ENTER] or <img alt="right arrow icon" data-bbox="735 160 755 180"/>.

|| is displayed.

- To resume playback, press <img alt="left/right arrow icon" data-bbox="675 205 695 225"/> [ENTER] or <img alt="right arrow icon" data-bbox="735 205 755 225"/>.

### ❑ Fast-forwarding and fast-reversing (searching)

During playback, press and hold in [

### ❑ Moving to the beginning of tracks (skipping)

During playback, press [

- The disc skips as many tracks as times the button is pressed.
- When you press reverse once, playback returns to the beginning of the current track.

### ❑ To play the desired track (remote control only)

Press [NUMBER] (0 – 9, +10) to select the track.

[Example] Track 4 : [4]

[Example] Track 12 : [+10], [2]

[Example] Track 20 : [+10], [+10], [0]

## Switching the display

Press [DISPLAY].

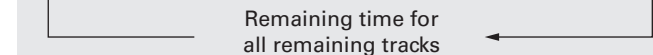

- The display switches each time the button is pressed.

**Symbols used to indicate buttons in this manual**

Button located on both the main unit and the remote control → **BUTTON**  
 Button only on the main unit → **<BUTTON>**  
 Button only on the remote control → **[BUTTON]**

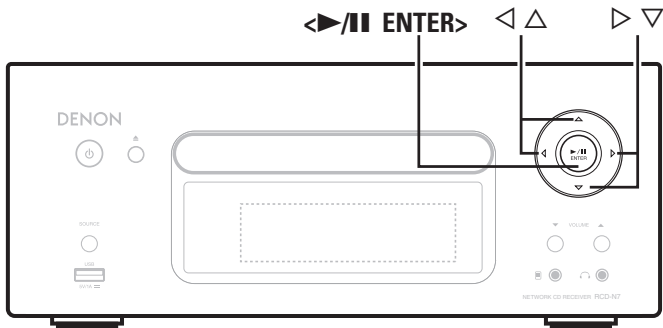

### Playing repeatedly (Repeat playback)

Press **[REPEAT]**.

Playback in the respective repeat mode starts.

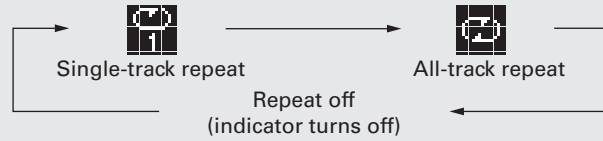

**[Selectable items]**

- 1 (Single-track repeat) Only 1 track plays repeatedly.
- ALL (All-track repeat) All tracks play repeatedly.
- Repeat off (indicator turns off) Normal playback resumes.

### Playing random order (Random playback)

**1** In the stop mode, press **[RANDOM]**.

The "∞" is displayed.

**2** Press **<ENTER>** or **[▶/||]**.  
 The tracks start playing in random order.



If **[REPEAT]** is pressed during random playback, after the current session of random playback is finished, another session in a different order of tracks starts.

**NOTE**

Random play cannot be set or canceled during playback.

**Canceling random playback**

While stopped, press **[RANDOM]**.  
 The "∞" turns off.

### Playing tracks in the desired order (Program playback)

Up to 25 tracks can be programmed.

- 1** In the stop mode, press **[PROGRAM]**.  
 "Program" is displayed.
- 2** Use **[NUMBER] (0 – 9, +10)** to select the tracks.  
**[Example]** To program tracks 3, 12, 7 to play in that order:  
 Press **[PROGRAM]**, **[3]**, **[+10]**, **[2]**, **[7]**.
- 3** Press **<ENTER>** or **[▶/||]**.  
 Playback starts in the programmed order.

**Checking the order of the programmed tracks**

In the stop mode, press **[▶▶]**.  
 The track numbers are displayed in the programmed order each time the button is pressed.

**To clear the last track programmed**

In the stop mode, press **[CLEAR]**.  
 The last track programmed is cleared each time the button is pressed.

**To clear one programmed track at a time**

In the stop mode, press **[▶▶|]** to select the track to be cleared, then press **[CLEAR]**.

**Clearing the all programmed track**

In the stop mode, press **[PROGRAM]**.



- If **[REPEAT]** is pressed during program playback, the tracks are played repeatedly in the programmed order.
- If **[RANDOM]** is pressed during program playback, the programmed tracks are played in random order.
- The program is cleared when the disc tray is opened or the power is turned off.

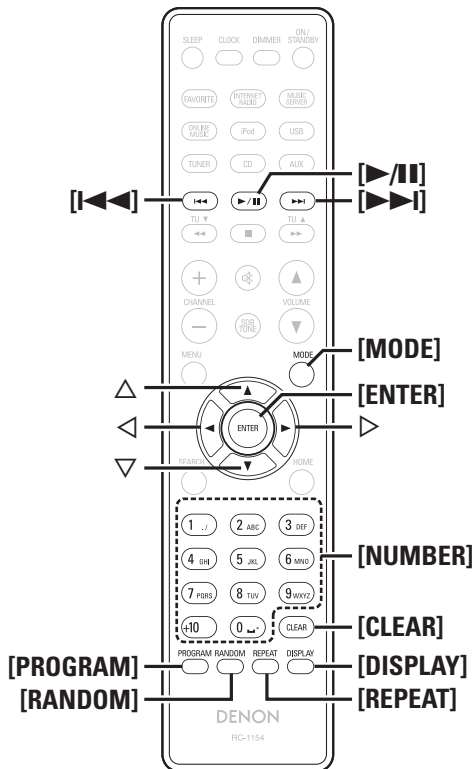

# MP3 and WMA files playback

This section explains how to playback MP3 and WMA files that are recorded onto a CD-R or CD-RW. For details on how to playback files recorded onto media other than CD-R or CD-RW, see the following sections.

- ❑ **Portable audio player playback** (👉 page 25)
- ❑ **USB memory device playback** (👉 page 18)
- ❑ **iPod® playback** (👉 page 17)
- ❑ **MP3 and WMA formats** (👉 page 43)



There are many music distribution sites on the Internet allowing you to download music files in MP3 or WMA (Windows Media® Audio) format. The music (files) downloaded from such sites can be stored on CD-R or CD-RW discs and played on this unit.

“Windows Media” and “Windows” are registered trademarks or trademarks in the United States and other countries of Microsoft Corporation of the United States.

## Playing files

- 1** Load a CD-R or CD-RW disc containing music files in the MP3 or WMA format into the disc tray (👉 page 3).
- 2** Press [MODE] and select “Folder” or “Disc”.
 

Folder ←→ Disc

**[About the display]**  
 When “Folder” is selected.....“” is displayed.  
 When “Disc” is selected.....“” turns off.

<b>Folder</b>	All the files in the selected folder are played.
<b>Disc</b>	After the selected folder and files are played, all the files in all the folders are played.
- 3** Use  $\Delta \nabla$  to select the folder to be played.
- 4** Use [◀▶], [⏪▶▶] or ◀ ▶ to select the file to be played.
- 5** Press [▶/||], [ENTER] or ◀▶/|| ENTER>.

### ❑ To switch the folder or file during playback

#### Folder

Use  $\Delta \nabla$  to select the folder, then press [ENTER] or ◀▶/|| ENTER>.

#### File

Use ◀ ▶ to select the file, then press [ENTER] or ◀▶/|| ENTER>. Also use [⏪▶▶] to select the file, or use [NUMBER] (0 – 9, +10) to select the file number.

- The folder and file numbers are set automatically when the disc is loaded.



- Copyright-protected files cannot be played.
- Depending on the application software used for writing, it may not be possible to write the data properly.
- Depending on the disc’s recording conditions, it may not be possible to play some discs properly.

### ❑ Switching the display

During playback, press [DISPLAY].

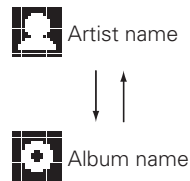

### ❑ To play repeatedly

Press [REPEAT].

Playback starts in the respective repeat mode.

- The selectable repeat modes differ in the “Folder” and the “Disc”.

#### When “Folder” is selected:

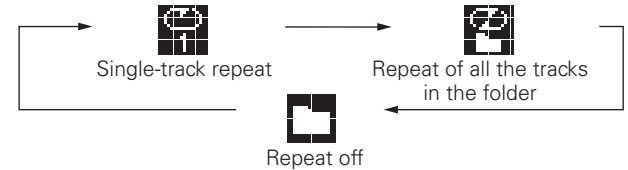

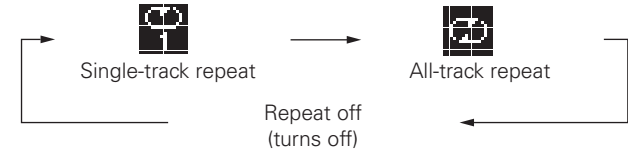

#### When “Disc” is selected:



#### [Selectable items]

##### When “Folder” is selected:

-  Only the selected track is played repeatedly.
-  All the files in the selected folder are played repeatedly.
-  Folder playback resumes.

##### When “Disc” is selected:

“Playing repeatedly (Repeat playback)” (👉 page 14)

### ❑ Setting random playback

“Playing random order (Random playback)” (👉 page 14)



Programmed playback is not possible with MP3/WMA discs.

**Symbols used to indicate buttons in this manual**

- Button located on both the main unit and the remote control → **BUTTON**
- Button only on the main unit → **<BUTTON>**
- Button only on the remote control → **[BUTTON]**

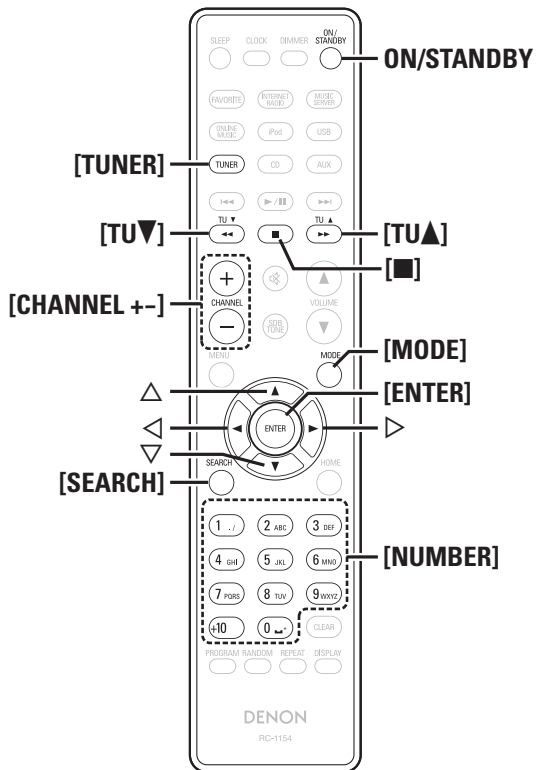
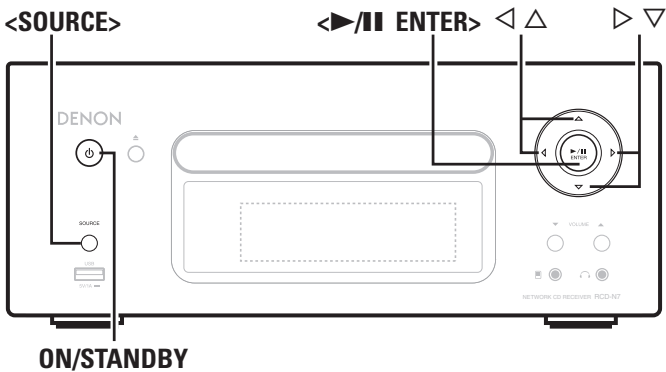

## Tuner playback

### Tuning in Broadcast Stations

Connect the antenna beforehand (page 7).

**1** Press **[TUNER]** to select the reception band.

AM ↔ FM

**2** Tune in the desired broadcast station. (FM/AM only)  
When a station is received, the "FM" will light.

**1** To tune in automatically (Auto tuning)

Press **[MODE]** to light the "AUTO" indicator on the display, then use **[TU ▲, TU ▼]** to select the station you want to hear.

**2** To tune in manually (Manual tuning)

Press **[MODE]** to turn off the display's "AUTO" indicator, then use **[TU ▲, TU ▼]** to select the station you want to hear.



- If the input source is set to something other than "TUNER", press **[TUNER]** to switch the input source to "TUNER".
- The input source can also be switched to "FM" or "AM" using **<SOURCE>** (page 12).
- If the desired station cannot be tuned in with auto tuning, tune it in manually.
- When tuning in stations manually, press and hold **[TU ▲, TU ▼]** to change frequencies continuously.
- A humming sound may be heard when using a TV nearby while receiving AM programs. If this happens, move the system as far from the TV as possible.

**To stop auto tuning**

Press **[TU ▲, TU ▼]**.

### Automatically presetting FM stations (Auto preset)

This unit can be preset with a total of 99, FM and AM broadcast stations.

**NOTE**

Auto preset is not possible with AM broadcast stations.

**Auto presetting with the remote control**

Perform this operation when tuned to an FM broadcast station.

**1** Press **[SEARCH]**.

"Search" menu appears.

**2** Use **▲ ▼** to select "Auto Preset" – "Start", then press **[ENTER]**, **<>/|| ENTER>** or **>**.

After "Searching" is displayed, "Complete" is displayed.

### Canceling auto presetting

Press **[■]**.



Broadcast stations whose antenna signal are weak cannot be preset automatically. If you wish to preset such stations, tune them in manually.

**NOTE**

When the auto presetting operation is performed, the new presettings overwrite the previous presettings.

**Giving station names to preset channels**

Names of up to 8 characters can be input.

**1** Tune in the preset channel you want to name.

**2** Press and hold **[ENTER]** or **<>/|| ENTER>**.  
The display switches to the station name input display.

**3** Input the station name.  
"Inputting characters" (page 36)

**4** Press **[ENTER]** or **<>/|| ENTER>**.  
The characters you have input are entered.  
• To give names to other stations, repeat steps 1 to 4.

## Presetting FM/AM stations manually

This unit can be preset with a total of 99 FM and AM broadcast stations.

- 1 Tune in the station you want to preset.**
- 2 Press [ENTER] or <▶/|| ENTER>.**  
"Preset" menu appears.
- 3 Use △▽ to select "Add to Preset", then press [ENTER], <▶/|| ENTER> or ▷.**
- 4 Use △▽ to select the number to be preset, then press [ENTER] or <▶/|| ENTER>.**  
The reception frequency and reception mode are preset and the display switches to the station name input display.
- 5 Input the station name.**  
"Inputting characters" (☞ page 36)
  - If you do not want to input a station name, press [ENTER] or <▶/|| ENTER> without inputting anything else.
  - If you make a mistake when inputting, perform the procedure again. Whatever was previously input is overwritten.
- 6 Press [ENTER] or <▶/|| ENTER>.**  
The characters you have input are entered.
  - To give names to other stations, repeat steps 1 to 5.

## Listening to preset stations

Use [NUMBER] (0 – 9, +10) or [CHANNEL + –] to select the preset number.

## Calling stations registered in Preset List

- 1 Press [ENTER/] or <▶/|| ENTER>.**  
"Preset" menu appears.
- 2 Use △▽ to select "Call Preset", then press [ENTER], <▶/|| ENTER> or ▷.**  
The Preset list appears.
- 3 Use △▽ to select Preset List, then press [ENTER], <▶/|| ENTER> or ▷.**

## Deleting stations registered in Preset List

- 1 Press [ENTER] or <▶/|| ENTER>.**  
"Preset" menu appears.
- 2 Use △▽ to select "Delete Preset", then press [ENTER], <▶/|| ENTER> or ▷.**  
The Preset list appears.
- 3 Use △▽ to select Preset List, then press [ENTER], <▶/|| ENTER> or ▷.**
- 4 When the prompt "Delete?" appears, press [ENTER] or <▶/|| ENTER>.**
  - To cancel the operation, press ◀.



## iPod® playback

With this unit, you can listen to music on an iPod. It is also possible to operate the iPod from the main unit or remote control. For the supported iPod models, see "Connecting an iPod" (☞ page 9).

☐ iPod® (☞ page 43)

## Before playing an iPod

- 1 Press ON/STANDBY.**
- 2 Load the iPod onto the iPod dock of this unit.**  
When the iPod is loaded to the iPod dock on this unit, the input source automatically switches to "iPod" and file playback begins.

### NOTE

This function is activated around 1 or 2 minutes after the power is turned on.

## Playing an iPod

- 1 Press [MODE] to select the display mode.**  
The mode switches each time the button is pressed.
  - There are two modes for displaying the contents recorded on the iPod.
    - Browse mode** Display iPod information on the display of this unit.
    - Remote mode** Display iPod information on the iPod screen.
  - "Remote iPod" is displayed on the display of this unit.

Display mode		Browse mode	Remote mode
Display location		Main unit display	iPod display
Playable files	Audio file	✓	✓
	Video file		✓
Active buttons	Remote control and main unit	✓	✓
	iPod®		✓

• The default display mode setting is "Browse mode".

- 2 Use △▽ to select the item, then press [ENTER] or <▶/|| ENTER> to select the music file to be played.**
- 3 Press [▶/||] or <▶/|| ENTER>.**  
Playback starts.

**Symbols used to indicate buttons in this manual**

- Button located on both the main unit and the remote control → **BUTTON**
- Button only on the main unit → **<BUTTON>**
- Button only on the remote control → **[BUTTON]**

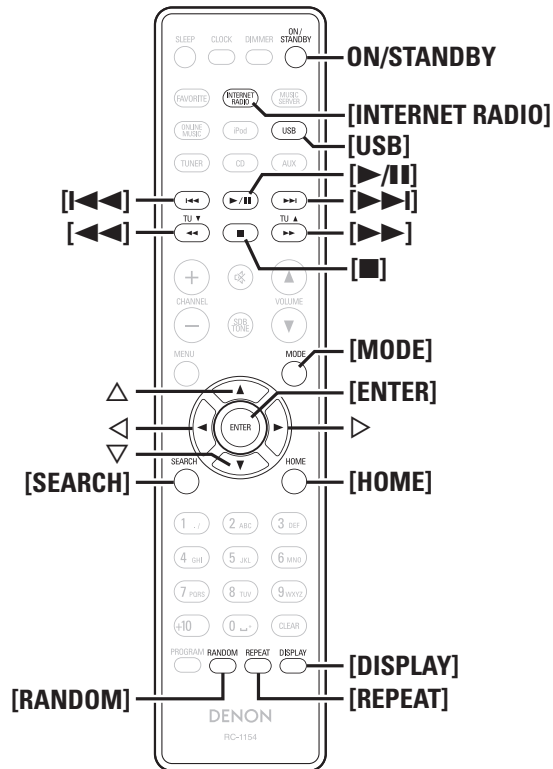
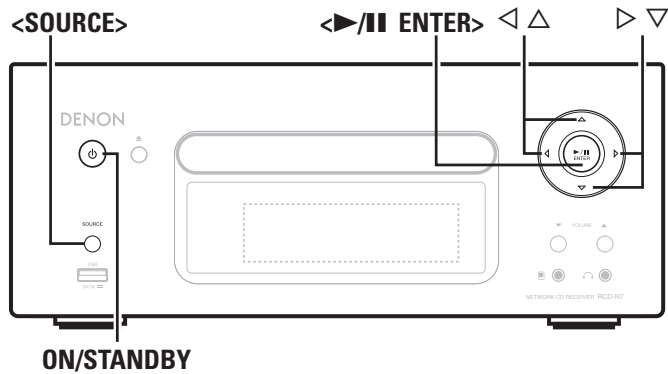

iPod® playback

**NOTE**

- iPod nano 1G and iPod video do not have remote mode support.
- DENON will accept no responsibility whatsoever for any loss of iPod data.
- Depending on the type of iPod and the software version, some functions may not operate.

**Remote control and iPod button relations**

Remote control buttons	iPod buttons	Operation on this unit
▶/	▶	Play the track / Pause the track.
◀◀, ▶▶	◀◀, ▶▶	Play the track from the beginning/Play the next track.
◀◀, ▶▶ Press and hold	◀◀, ▶▶ Press and hold	Fast-reverse the track/Fast-forward the track.
△, ▽	Click Wheel	Select an item.
ENTER or ▶	Select	Enter the selection or plays the track.
MODE	-	Switch between the browse mode and the remote mode.
REPEAT	-	Switch the repeat function
RANDOM	-	Switch the shuffle function
◀	MENU	Display the menu or return to the previous menu.
■	-	Stop the track.
HOME	-	Return to top menu (in Browse mode)

**To switch the display**

During playback, press [DISPLAY].  
The display switches each time the button is pressed.

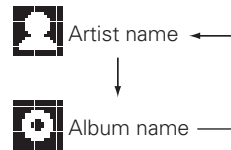

**Disconnecting the iPod**

- 1 Press **ON/STANDBY** to set the standby mode.
- 2 Remove the iPod from the iPod dock of this unit.

**USB memory device playback**

Playing back music or files recorded on a USB memory device or an iPod.

- ❑ **USB memory device** (page 44)
- ❑ **Playing an iPod** (page 17)

**Before playing a USB memory device or an iPod**

- 1 Press **ON/STANDBY**.
- 2 Connect **USB memory device or iPod connection cable**.
- 3 Press **<SOURCE>** and **△▽** to select to “**USB**”, then press **[ENTER]**, **<▶/|| ENTER>** or **▶**, or press **[USB]**.

**NOTE**

This function is activated around 1 or 2 minutes after the power is turned on.

**Playing files stored on USB memory devices**

- 1 Press **△▽** to select the search item or folder, then press **[ENTER]**, **<▶/|| ENTER>** or **▶**.
- 2 Press **△▽** to select the file, then press **[ENTER]**, **<▶/|| ENTER>**, **▶** or **[▶/||]**. Playback starts.

- If the USB memory device is divided into multiple partitions, only the top partition can be selected.
- This unit is compatible with MP3 files conforming to “MPEG-1 Audio Layer-3” standards.

USB memory device playback

**NOTE**

- Note that DENON will accept no responsibility whatsoever for any problems arising with the data on a USB memory device when using this unit in conjunction with the USB memory device.
- USB memory devices will not work via a USB hub.
- DENON does not guarantee that all USB memory devices will operate or be supplied power. When using a USB portable hard disk that can draw power from an AC adapter, we recommend using the AC adapter.
- It is not possible to connect and use a computer via the USB port of this unit using a USB cable.

**USB operation**

Operation buttons	Operation on this unit
	Play the track / Pause the track.
	Play the track from the beginning/Play the next track.
	Select an item.
<b>ENTER</b> or	Enter the selection or plays the track.
<b>REPEAT</b>	Switch the repeat function
	Display the menu or return to the previous menu.
	Stop the track.
<b>SEARCH</b>	Character search*
<b>HOME</b>	Return to top menu

- **Playing repeatedly (Repeat playback)** (🔧 page 14)

\* Press **[SEARCH]**, then press to select the first letter you want to search mode.

If the list is not in alphabetical order, you may not be able to perform a character search.

**To switch the display**

During playback, press **[DISPLAY]**.

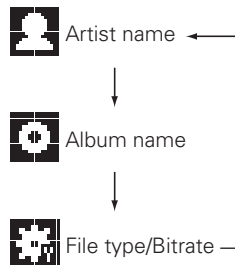

Network audio playback

Follow this procedure to play Internet radio stations or music files stored on a computer.

- ❑ **About the internet radio function** (🔧 page 45)
- ❑ **Music server** (🔧 page 45)
- ❑ **About Napster** (🔧 page 45)
- ❑ **About Pandora** (🔧 page 45)
- ❑ **About Rhapsody** (🔧 page 45)

**Listening to internet radio**

- 1 Prepare for playback.**
  - ① Check the network environment, then turn on this unit's power (🔧 page 11 "Turning the power on").
  - ② If settings are required, make the "Setting the network [Network]" (🔧 page 30).
- 2 Press [INTERNET RADIO].**
- 3 Press to select the item you want to play, then press [ENTER], [ENTER] or .**
- 4 Repeat step 3 until the station list is displayed.**  
The station list is displayed.
- 5 Press to select the station, then press [ENTER], [ENTER] or .**  
Playback starts once buffering reaches "100%".



- There are many Internet radio stations on the Internet, and the quality of the programs they broadcast as well as the bit rate of the tracks varies widely. Generally, the higher the bit rate, the higher the sound quality, but depending on the communication lines and server traffic, the music or audio signals being streamed may be interrupted. Inversely, lower bit rates mean a lower sound quality but less tendency for the sound to be interrupted.
- "Server Full" or "Connection Down" is displayed if the station is busy or not broadcasting.
- On this unit, folder and file names can be displayed as titles. Any characters that cannot be displayed are replaced with "." (period).
- When **[DISPLAY]** is pressed, the display can be switched between the file type/bitrate and radio station name.

**Switching the display**

- 1 Press [DISPLAY] during Internet radio reception.**
- 2 The broadcast station information and signal format bit rate are displayed.**

**Recently played internet radio stations**

Recently played internet radio stations can be selected from "Recently Played".  
Up to 20 stations stored in "Recently Played".

- 1 Press to select "Recently Played", then press [ENTER], [ENTER] or .**
- 2 Press to select the item you want to play, then press [ENTER], [ENTER] or .**

**Searching stations by keyword (Alphabetic strings)**

- 1 Press to select "Search by Keyword", then press [ENTER] or .**  
• For character input, see page 36.
- 2 Input the characters, then press [ENTER] or [ENTER].**

**Registering internet radio stations as your favorites**

You can register your favorite broadcast stations in Favorite List. (🔧 page 26)





❑ Music server operation

Operation buttons	Function
<b>MENU</b>	Menu
△▽◀▷	Cursor operation / Auto search (cue, △▽)
<b>ENTER</b>	Enter
<b>SEARCH</b>	Character search *
<b>HOME</b>	Return to top page
▶/	Playback / Pause
◀◀ ▶▶	Auto search (cue)
■	Stop
<b>FAVORITE</b>	Register or call your favorite file in Favorite List, and delete file from the list.

- **Playing repeatedly (Repeat playback)** (🔧 page 14)
- **Playing random order (Random playback)** (🔧 page 14)

\* Press **[SEARCH]**, then press ◀▷ to select the first letter you want to search mode.

 If the list is not in alphabetical order, you may not be able to perform a character search.

**Listening to Napster** 

Napster is not available in all countries.

- 1 Prepare for playback.**
  - ① Check the network environment, then turn on this unit's power (🔧 page 11 "Turning the power on").
  - ② If settings are required, make the "Setting the network [Network]" (🔧 page 30).
- 2 Press [ONLINE MUSIC] and select "Napster".**
- 3 Use △▽▷ to input "Username" and "Password".**
  - For character input, see page 36.
- 4 After inputting the "Username" and "Password", select "login", then press [ENTER] or ▶/|| ENTER>.** If the "Username" and "Password" match, the top menu for Napster is displayed.

**NOTE**

- The password should be no longer than 99 characters.
- Press **[HOME]** to cancel the input.

❑ Searching from Napster menu

- 1 Use △▽ to select search item or folder, then press [ENTER], ◀▶/|| ENTER> or ▷.**
- 2 Repeat step 1 until the track is displayed.**
- 3 Use △▽ to select the track item, then press [ENTER], ▶/|| ENTER> or ▷.**

❑ Entering a character search for the track you want to listen to

- 1 Press [SEARCH].**
  - You can search by artist name, album name or track name in menu list.
  - You cannot perform search on the playback screen.

- 2 Use △▽ to select the search item, then press [ENTER], ◀▶/|| ENTER>.** The search display appears.
  - For character input, see page 36.
- 3 Input the characters, then press [ENTER] or ◀▶/|| ENTER>.**

❑ Registering tracks in my Napster library

- 1 Press ▷ while the track you wish to register is playing.** "Add to my library?" appears.
- 2 Press [ENTER], ◀▶/|| ENTER> or ▷.** The track is entered in the Library. When you press ◀, the registration is cancelled and the display returns to the previous page.

**Listening to tracks registered in my Napster library.**

- 1 Use △▽ to select "My Napster Library", then press [ENTER], ◀▶/|| ENTER> or ▷.**
- 2 Use △▽ to select the information or track, then press [ENTER], ◀▶/|| ENTER>.**



Use **[DISPLAY]** to switch between displaying the artist name, file type/bitrate or album name.

❑ Napster operation

Operation buttons	Function
<b>MENU</b>	Menu
△▽◀▷	Cursor operation / Auto search (cue, △▽)
<b>ENTER</b>	Enter
<b>SEARCH</b>	Search menu
<b>HOME</b>	Return to top page
▶/	Playback
◀◀ ▶▶	Auto search (cue)
■	Stop

- **Playing repeatedly (Repeat playback)** (🔧 page 14)
- **Playing random order (Random playback)** (🔧 page 14)

**Symbols used to indicate buttons in this manual**

- Button located on both the main unit and the remote control → **BUTTON**
- Button only on the main unit → **<BUTTON>**
- Button only on the remote control → **[BUTTON]**

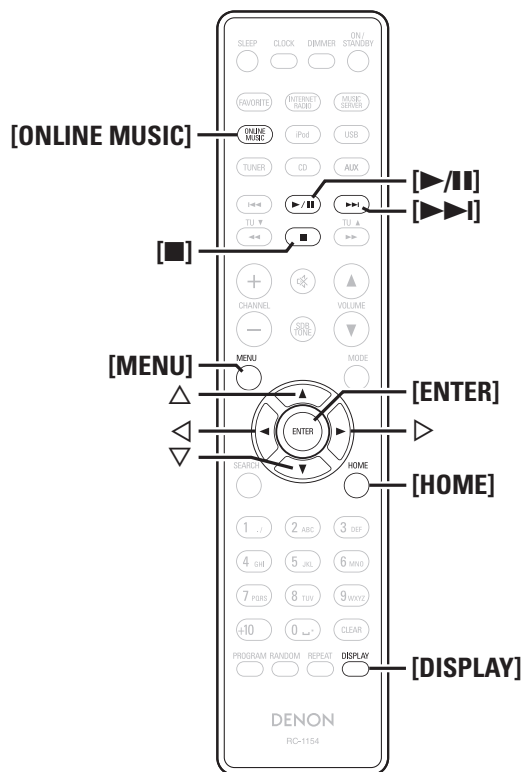
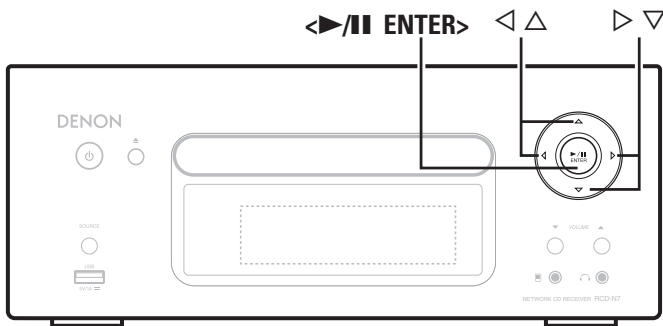

## Listening to Pandora **P**

Pandora is not available in all countries.

### 1 Prepare for playback.

- Check the network environment, then turn on this unit's power (page 11 "Turning the power on").
- If settings are required, make the "Setting the network [Network]" (page 30).

### 2 Press [ONLINE MUSIC], then select "Pandora".

If you do not have a Pandora account, press  $\nabla$  to select "I am new to Pandora", then press [ENTER],  $\leftarrow$  or  $\rightarrow$ . The URL needed to activate Pandora and the activation code will be displayed. Browse to the Pandora activation URL from your PC and follow the on-screen instructions for creating a new account.

### 3 If you have a Pandora account, press $\Delta$ to select "I have a Pandora account", then press [ENTER], $\leftarrow$ or $\rightarrow$ .

### 4 Input "Email address" and "Password".

For character input, see page 36.

### 5 After inputting the "Email address" and "Password", select "login", then press [ENTER], $\leftarrow$ or $\rightarrow$ .

If the "Email address" and "Password" match, the top menu for Pandora is displayed.

#### NOTE

- Press [HOME] to cancel the input.

## Creating a Personalized radio station

You can create up to 100 personalized radio stations.

### 1 Use $\Delta$ $\nabla$ to select "New Station", then press [ENTER], $\leftarrow$ or $\rightarrow$ .

### 2 Input a "Track Name" or "Artist Name", then press [ENTER], $\leftarrow$ or $\rightarrow$ .

For character input, see page 36.

### 3 Use $\Delta$ $\nabla$ to select "Search by artist" or "Search by track", then press [ENTER], $\leftarrow$ or $\rightarrow$ .

You can search and display a list by track or artist.

### 4 Press $\Delta$ $\nabla$ , select a file (e.g. D&M2) from the list, and press [ENTER], $\leftarrow$ or $\rightarrow$ .

Selected file is played back.

"Radio" is added to the end of a filename, and your original radio station is created (e.g. D&M2 Radio)

## Listening to a personalized radio station

### Listening to a personalized radio station (e.g. D&M2 Radio)

By specifying your favorite track or artist name, Pandora will create a radio station that plays similar music to your favorite.

- Use [DISPLAY] to switch between displaying the artist name, album name, station name or file type/bitrate.

### Listening to created radio stations at random

**1** Press  $\triangle \nabla$  and select the radio station (“D&M2 Radio”) that you want to listen to, and press [ENTER],  $\blacktriangle / \text{II}$  ENTER or  $\triangleright$ .

In Pandora, you can search for the track name or artist name using “D&M2” as a keyword. When the search is complete, tracks that have a similar rhythm or sound are streamed.

**2** Use to select “Quick Mix”, then press [ENTER],  $\blacktriangle / \text{II}$  ENTER or  $\triangleright$ .



Created radio stations are selected at random, and tracks are streamed.

### Providing feedback on tracks within radio stations

You can provide feedback on track tracks by opening the Pandora menu screen while a track is playing.

Press  $\triangleright$  while a track is playing.

The Pandora menu is displayed.

- I like this track**
  - Press when you like the track that is being played.
  - It will return to the Play Screen. And  (Thumbs up) icon is displayed.
- I don't like this track**
  - Press when you don't like the track that is being played.
  - It will return to the Play Screen,  (Thumbs down icon) is displayed and Pandora will skip to the next track.
- Create station**
  - Creates a Station for the Track or Artist being played.
- Bookmark this track**
  - Bookmarks the track currently being played.
  - You can check view your bookmarks at Pandora.com.
  - For details, see the Pandora FAQ at <http://blog.pandora.com/faq/>.
- Delete this station**
  - Press when you want to delete the station that is being played.

#### NOTE

- You can Skip up to 6 Tracks that are being played back within 1 hour.
- You can create up to 100 New Stations (radio stations).

### Sign out

Disassociate this unit from your Pandora account.

**1** While the Pandora top menu is displayed, press  $\triangleleft$ .

**2** When the popup menu appears, press  $\triangle \nabla$  to select “Yes”.

### Pandora operation

Operation buttons	Function
<b>MENU</b>	System menu
$\triangle \nabla \triangleleft \triangleright$	Auto search (cue, $\nabla$ )
<b>ENTER</b>	Enter
<b>HOME</b>	Return to Pandora's root
$\blacktriangleright \text{II}$	Play / Pause
$\blacktriangleright \triangleright$	Auto search (cue)
$\blacksquare$	Stop

**Symbols used to indicate buttons in this manual**

- Button located on both the main unit and the remote control → **BUTTON**
- Button only on the main unit → **<BUTTON>**
- Button only on the remote control → **[BUTTON]**

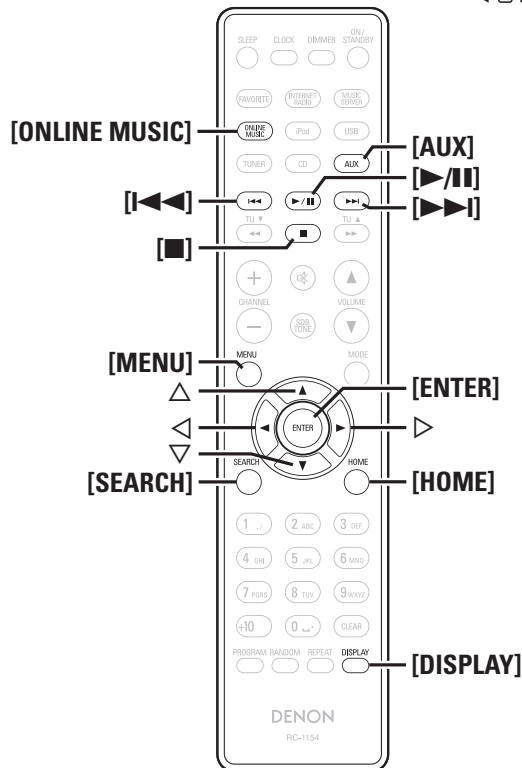
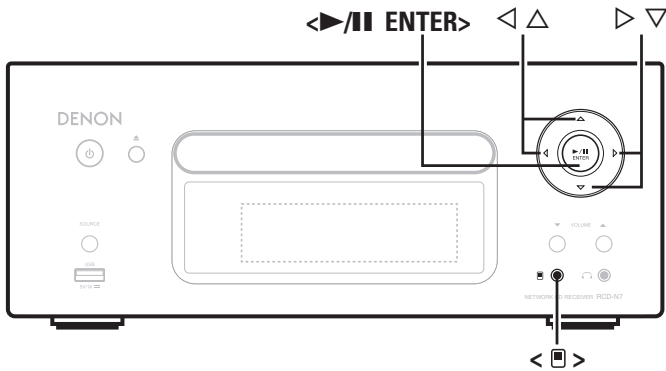

## Listening to Rhapsody

Rhapsody is not available in all countries.

### 1 Prepare for playback.

- Check the network environment, then turn on this unit's power (see page 11 "Turning the power on").
- If settings are required, make the "Setting the network [Network]" (see page 30).

### 2 Press [ONLINE MUSIC], then select "Rhapsody".

### 3 Use $\Delta$ / $\nabla$ to select "Sign in to your account", then press [ENTER], $\blacktriangleleft$ /[ENTER] or $\blacktriangleright$ .

### 4 Input Username and Password.

- For character input, see page 36.

### 5 After inputting the "Username" and "Password", select "OK", then press [ENTER] or $\blacktriangleleft$ /[ENTER]. If the "Username" and "Password" match, the top menu for Rhapsody is displayed.

#### NOTE

- The password should be no longer than 99 characters.
- Press [HOME] to cancel the input.

#### Select the search mode

##### ① Search from Rhapsody latest information

### 1 Use $\Delta$ / $\nabla$ to select "Rhapsody Music Guide", then press [ENTER], $\blacktriangleleft$ /[ENTER] or $\blacktriangleright$ .

### 2 Press $\Delta$ / $\nabla$ to select the information for track selection, then press [ENTER], $\blacktriangleleft$ /[ENTER] or $\blacktriangleright$ .

- For character input, see page 36.

### 3 Repeat step 2 until the track is displayed.

### 4 Use $\Delta$ / $\nabla$ to select the track, then press [ENTER], $\blacktriangleleft$ /[ENTER] or $\blacktriangleright$ .

##### ② Enter a character search for the track you want to listen to

### 1 Use $\Delta$ / $\nabla$ to select "Search", then press [ENTER], $\blacktriangleleft$ /[ENTER] or $\blacktriangleright$ .

### 2 Use $\Delta$ / $\nabla$ to select the search item, then press [ENTER], $\blacktriangleleft$ /[ENTER] or $\blacktriangleright$ . The search display appears.

- You can search by artist name, album name, track name or keyword.

### 3 Enter the characters, then press [ENTER] or $\blacktriangleleft$ /[ENTER].

##### ③ Search from the Rhapsody internet radio station

### 1 Use $\Delta$ / $\nabla$ to select "Rhapsody Channels", then press [ENTER], $\blacktriangleleft$ /[ENTER] or $\blacktriangleright$ .

### 2 Repeat step 1 until the radio station is displayed.

### 3 Use $\Delta$ / $\nabla$ to select radio station, then press [ENTER], $\blacktriangleleft$ /[ENTER] or $\blacktriangleright$ . The search display appears.

##### ④ Listening to tracks registered in my library

### 1 Use $\Delta$ / $\nabla$ to select "My Library", then press [ENTER], $\blacktriangleleft$ /[ENTER] or $\blacktriangleright$ .

### 2 Repeat step 1 until the track is displayed.

### 3 Use $\Delta$ / $\nabla$ to select the information or track, then press [ENTER], $\blacktriangleleft$ /[ENTER] or $\blacktriangleright$ . After selecting, the information is displayed

## Playing a network audio

## □ Track menu

Press **▷** during playback to display the track menu.

## ① Search from the similar music

Use **△▽** to select the search item, then press **[ENTER]**, **<▷/|| ENTER>** or **▷**.

## ② Registering tracks in my library

Use **△▽** to select “Add Track to my library”, then press **[ENTER]**, **<▷/|| ENTER>** or **▷**.  
The track is entered in the library.

## ③ Rating function

**1** Use **△▽** to select “Rating”, then press **[ENTER]**, **<▷/|| ENTER>** or **▷**.

**2** Use **<▷** to select the rating, then press **[ENTER]** or **<▷/|| ENTER>**.



- Use **[DISPLAY]** to switch between displaying the artist name, file type/bitrate or album name.

## □ Rhapsody operation

Operation buttons	Function
<b>MENU</b>	Menu
<b>△▽&lt;▷</b>	Cursor operation / Auto search (cue, △▽)
<b>ENTER</b>	Enter
<b>SEARCH</b>	Character search*
<b>HOME</b>	Return to top page
<b>▷/  </b>	Playback / Pause
<b>◀◀ ▶▶</b>	Auto search (cue)
<b>■</b>	Stop

- **Playing repeatedly (Repeat playback)** (🔍 page 14)
- **Playing random order (Random playback)** (🔍 page 14)

- \* Press **[SEARCH]**, then press **<▷** to select the first letter you want to search mode.
  - If it is not possible to search the list, “unsorted list.” is displayed. To cancel, press **△▽** or **[SEARCH]**.



If the list is not in alphabetical order, you may not be able to perform a character search.



## Portable audio player playback

Your portable audio player can be connected to this unit's portable jack to play tracks on the portable audio player.

## Playing portable audio player

**1** Connect the portable audio player to **<▷/|| ENTER>** (🔍 page 10 “Connecting a portable player”).  
The input source automatically switches to “Portable In”.

**2** Play the portable audio player.  
The player's audio is output.  
• Also read the portable audio player's operating instructions.

## NOTE

When using the portable player's headphone jack, set the volume on the portable player to an appropriate level.



## Listening to AUX

**1** Prepare for playback.  
Check the connection, then turn on this units.

**2** Press **[AUX]** to select “Portable In”, “AUX1”, “AUX2” or “AUX3”.

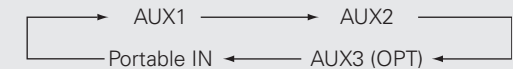

- When there is no portable audio player connected to the portable in jack, “Portable In” is not displayed when you press **[AUX]**.

**3** Play the component connected to this unit.

**Symbols used to indicate buttons in this manual**

Button located on both the main unit and the remote control → **BUTTON**

Button only on the main unit → **<BUTTON>**

Button only on the remote control → **[BUTTON]**

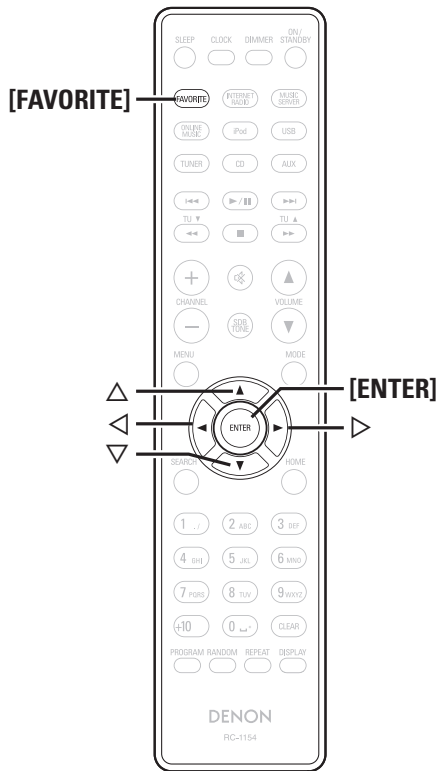
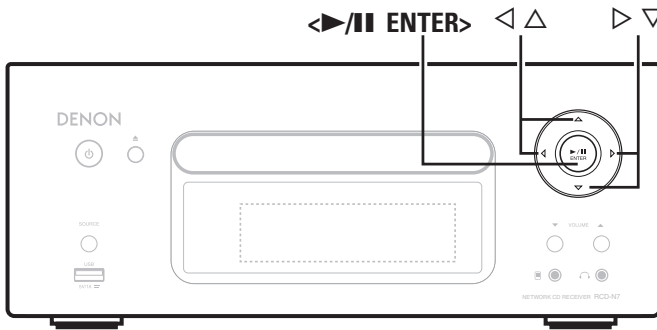

## **Favorite function**

This section provides information on the Favorite function.

- The Favorite function allows you to register your favorite broadcast stations and files in Favorite List in advance so that you can call and listen to the stations or files right away, whenever you want.
- The contents that you can register and call are Internet radio station, music server, and tuner.
- You can register up to 50 items in Favorite List.
- When you attempt to register the 51st station in Favorite List, the last station (station that is accessed least frequently) is automatically deleted.
- When you select a station from Favorite List, the top of the list is displayed.

### **Registering Internet radio stations, music servers and tuners in Favorite List**

- 1 Press [FAVORITE] while the Internet radio station, tuners or file to register is played back.**  
"Favorite" menu appears.
- 2 Use  $\Delta$ / $\nabla$  to select "Add to Favorite", then press [ENTER],  $\blacktriangleleft$ / $\blacktriangleright$  ENTER or  $\blacktriangleright$ .**  
When the station, server, or tuner is registered, "Add to Favorite" appears.

### **Calling Internet radio stations, files registered or tuners in Favorite List**





- 1 Press [FAVORITE].**  
"Favorite" menu appears.
- 2 Use  $\Delta$ / $\nabla$  to select "Call Favorite", then press [ENTER],  $\blacktriangleleft$ / $\blacktriangleright$  ENTER or  $\blacktriangleright$ .**  
The Favorite list appears.
- 3 Use  $\Delta$ / $\nabla$  to select Favorite List, then press [ENTER],  $\blacktriangleleft$ / $\blacktriangleright$  ENTER or  $\blacktriangleright$ .**  
The respective function starts up and playback starts.

### **Deleting Internet radio stations, files registered or tuners in Favorite List**

- 1 Press [FAVORITE].**  
"Favorite" menu appears.
- 2 Use  $\Delta$ / $\nabla$  to select "Delete Favorite", then press [ENTER],  $\blacktriangleleft$ / $\blacktriangleright$  ENTER or  $\blacktriangleright$ .**  
The Favorite list appears.
- 3 Use  $\Delta$ / $\nabla$  to select Favorite List, then press [ENTER],  $\blacktriangleleft$ / $\blacktriangleright$  ENTER or  $\blacktriangleright$ .**
- 4 When the prompt "Delete?" appears, press [ENTER] or  $\blacktriangleleft$ / $\blacktriangleright$  ENTER.**  
• To cancel the operation, press  $\blacktriangleleft$ .

# Advanced operations

## Menu map

Setting items	Detailed items		Description	Page	
 [Timer] 1/3 <b>Once</b> <Off> Everyday <Off>	<b>Once</b>	<b>Set Time (hh:mm)</b>	Performs the time setting of Once Timer that is activated at a specified time.	28	
		<b>Source (xxx)</b>	Performs the playback Source (input source) setting of Once Timer to be activated at a specified time.	28	
		<b>Volume (xx)</b>	Performs the playback Volume setting of Once Timer to be activated at a specified time.	28	
	<b>Everyday</b>	<b>Set Time (hh:mm)</b>	Performs the time setting of Everyday Timer that is activated everyday.	28	
		<b>Source (xxx)</b>	Performs the playback Source (input source) setting of Everyday Timer to be activated everyday.	28	
		<b>Volume (xx)</b>	Performs the playback Volume setting of Everyday Timer to be activated everyday.	28	
 [Clock] 1/3 <b>Auto Adjust</b> Manual Adjust	<b>Auto Adjust</b>	<b>Time Zone</b>	Sets your local time zone (for Auto Adjust).	29	
		<b>Summer Time</b>	Sets the Summer Time information (for Auto Adjust).	29	
		<b>Adjust Now</b>	Obtains the current time.	29	
	<b>Manual Adjust</b>	Adjusts the clock manually.		29	
	 [Network] 1/9 <b>Network First Setup</b> Connection	<b>Network First Setup</b>		Performs the network settings using a Wizard style window.	-
		<b>Connection</b>	<b>Wired</b>	<b>DHCP</b>	Performs the wired connection settings.
<b>IP Address</b>				Performs the DHCP setting.	30
<b>Subnet Mask</b>				Performs the IP address setting.	30
<b>Gateway</b>				Performs the subnet mask setting.	30
<b>Primary DNS</b>				Performs the gateway setting.	30
<b>Secondary DNS</b>				Performs the primary DNS setting.	30
<b>Proxy</b>				Performs the secondary DNS setting.	30
<b>Connection</b>				Performs the proxy setting.	31
<b>Wireless</b>			<b>Search Access Point</b>	Performs the connection test.	30
			<b>WPS</b>	Selects and sets the wireless connections from the access point list.	31
		<b>Manual Setting</b>	Sets the wireless connection using WPS.	31	
			Sets the wireless connection manually.	32	
<b>Napster Account</b>		Performs the Napster account setting again.	21		
<b>Pandora Account</b>		Performs the Pandora account setting again.	22		
<b>Rhapsody Account</b>		Performs the Rhapsody account setting again.	24		
<b>Party Mode</b>		Starts or stops the party mode.		33	
	<b>Party Mode Function</b>	Enable/disable the party mode.	33		
	<b>Party Start Level</b>	Sets the volume used for the party mode.	33		
<b>Other Network</b>	Performs other network settings.		-		
	<b>Network Standby</b>	Sets the network function on during standby.	34		
	<b>PC Language</b>	Selects the language to be used for displaying the Internet sites.	34		
	<b>Friendly Name Edit</b>	Edits a name displayed on the Internet.	34		
	<b>Network Status</b>	Displays the statuses of up to 10 DENON products connected to the same network.	34		
<b>Network Info.</b>		Displays various setting values of the network.	-		
 [Other] 1/5 <b>Auto Standby</b> Screen Saver	<b>Auto Standby</b>		Sets the Auto Standby mode to automatically enter standby when no operation is performed.	35	
	<b>Screen Saver</b>		Activates the screen saver.	35	
	<b>Speaker Optimize</b>		Performs the filter setting for optimizing the response of optional speakers if they are connected.	35	
	<b>Firmware Update</b>		Starts the firmware update.	35	

**Symbols used to indicate buttons in this manual**

- Button located on both the main unit and the remote control → **BUTTON**
- Button only on the main unit → **<BUTTON>**
- Button only on the remote control → **[BUTTON]**

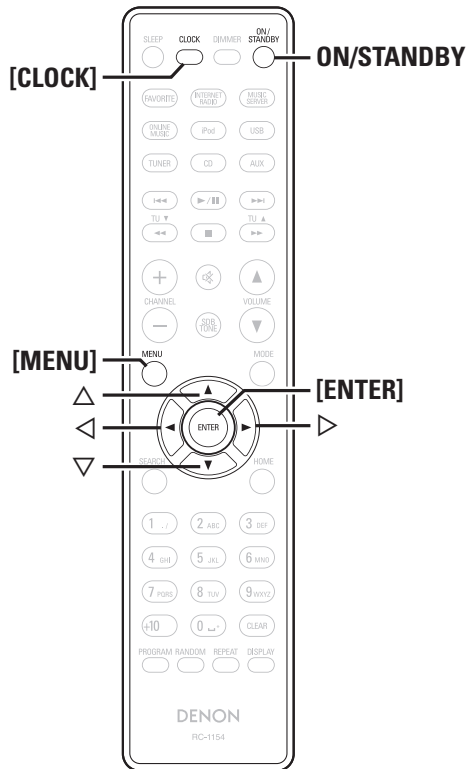
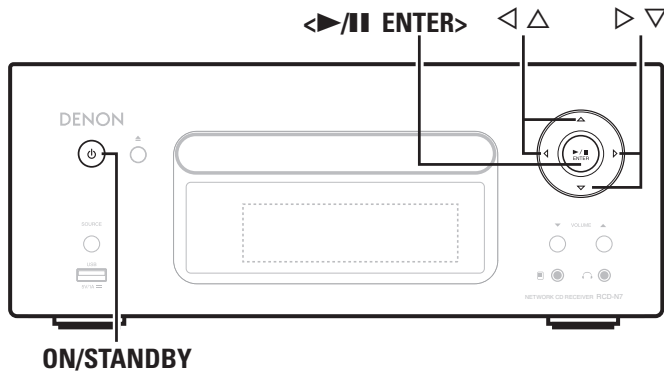

**Setting the timer [Timer]**

This device can playback using the timer playback (everyday timer, once timer).  
 • This unit's timer does not support exit time settings for timer playback.

**Timer operation when the time settings for timers overlap**

**When the once timer and everyday timer are both set (sleep timer is not set)**

- Automatically starts playback at the earlier timer start time set for either of the timers.



If the current time is not set, enter timer setting mode to get time setting mode.

**Setting the everyday timer and once timer**

- **Everyday timer ("Everyday")**  
Playback starts at the set times each day.
- **Once timer ("Once")**  
Playback starts once only at the set times.

**1 Press [MENU].**  
Turns on the Menu settings mode and the Menu appears on the display. (☞ page 27 "Menu map")

**2 Use  $\Delta$ / $\nabla$  to select "Timer", then press [ENTER],  $\leftarrow$ / $\rightarrow$ /|| ENTER or  $\triangleright$ .**

**3 Use  $\Delta$ / $\nabla$  to select the timer mode, and use  $\leftarrow$ / $\rightarrow$  to select "On" or "Off" then press [ENTER], or  $\leftarrow$ / $\rightarrow$ /|| ENTER.**

**4 Use  $\Delta$ / $\nabla$  to select "Set Time", then press [ENTER],  $\leftarrow$ / $\rightarrow$ /|| ENTER or  $\triangleright$ .**

**5 Use  $\Delta$ / $\nabla$  to select "hours" – "minutes" for the timer start time, then press [ENTER],  $\leftarrow$ / $\rightarrow$ /|| ENTER or  $\triangleright$ .**

**6 Use  $\Delta$ / $\nabla$  to select "Source", then press [ENTER],  $\leftarrow$ / $\rightarrow$ /|| ENTER or  $\triangleright$ .**

**7 Use  $\Delta$ / $\nabla$  to select the input source, then press [ENTER],  $\leftarrow$ / $\rightarrow$ /|| ENTER or  $\triangleright$ .**

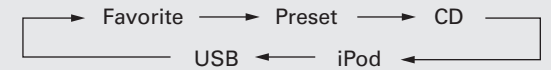

**8 Use  $\Delta$ / $\nabla$  to select the "Volume", then press [ENTER],  $\leftarrow$ / $\rightarrow$ /|| ENTER or  $\triangleright$ .**

**9 Use  $\Delta$ / $\nabla$  to select the volume "0 – 60", then press [ENTER],  $\leftarrow$ / $\rightarrow$ /|| ENTER or  $\triangleright$ .**

**10 Press ON/STANDBY to set the power to standby.**  
Timer standby mode is set, and the power indicator lights orange.

**NOTE**

- If the unit or remote control is not operated for 90 minutes or more when the timer is set to on, the standby mode is activated.
- When using timer playback on an iPod Touch or iPhone, set the iPod Touch or iPhone to "Sleep" mode. If the power is switched off using the power off operation, timer playback cannot be used. For details on the "Sleep" mode of the iPod Touch or iPhone, see the instruction manuals of the products or related web pages.

**Setting the timer to on or off**

- Perform the operations at "Setting the timer [Timer]" (☞ page 28).
- When set to "OFF", time operation is disabled, but the timer settings remain unchanged.

**To check the timer settings**

Perform the operations at "Setting the timer [Timer]" (☞ page 28).

**To change the timer settings**

Perform the operations at "Setting the timer [Timer]" (☞ page 28).

**To change the setting while setting the timer**

- Press  $\leftarrow$ .
- The setting returns to the previous step. Display the setting you want to change, then make the desired setting.





## Adjusting the clock automatically [Clock]

You can automatically adjust the clock of this unit using the Internet.



To use this function, the unit must be connected to the Internet.

### Setting the Time Zone

Use the following procedure to select your local standard time (time zone).

- 1 Press [MENU].**  
Turns on the Menu settings mode and the Menu appears on the display. (☞ page 27 "Menu map")
- 2 Use  $\Delta$ / $\nabla$  to select "Clock" – "Auto Adjust" – "Time Zone", then press [ENTER],  $\blacktriangleleft$ /|| ENTER> or  $\blacktriangleright$ .**  
"Time Zone" menu appears.
- 3 Use  $\Delta$ / $\nabla$  to select your time zone, then press [ENTER],  $\blacktriangleleft$ /|| ENTER> or  $\blacktriangleright$ .**  
The setting is entered.

### Setting the Summer Time

Use the following procedure to set Summer time if the Summer time system is used in your country.

- 1 Press [MENU].**  
Turns on the Menu settings mode and the Menu appears on the display. (☞ page 27 "Menu map")
- 2 Use  $\Delta$ / $\nabla$  to select "Clock" – "Auto Adjust" – "Summer Time", then press [ENTER],  $\blacktriangleleft$ /|| ENTER> or  $\blacktriangleright$ .**  
"Summer Time" menu appears.
- 3 Use  $\Delta$ / $\nabla$  to select "Off (0H)" or "On (+1H)", then press [ENTER],  $\blacktriangleleft$ /|| ENTER> or  $\blacktriangleright$ .**  
The setting is entered.

### Auto Adjust

Use the following procedure to automatically adjust the clock.

- 1 Press [MENU].**  
Turns on the Menu settings mode and the Menu appears on the display. (☞ page 27 "Menu map")
- 2 Use  $\Delta$ / $\nabla$  to select "Clock" – "Auto Adjust" – "Adjust Now", then press [ENTER],  $\blacktriangleleft$ /|| ENTER> or  $\blacktriangleright$ .**  
The operation to receive the current time starts.
  - The current time is displayed for several seconds when it is received successfully.
  - If the current time is not received successfully, "Connection Failed" appears.

### Setting the current time (Manual Adjust) (12-Hour Display)

- 1 Press [MENU].**  
Turns on the Menu settings mode and the Menu appears on the display. (☞ page 27 "Menu map")
- 2 Use  $\Delta$ / $\nabla$  to select "Clock" – "Manual Adjust", then press [ENTER],  $\blacktriangleleft$ /|| ENTER> or  $\blacktriangleright$ .**
- 3 Use  $\Delta$ / $\nabla$  to set the "hours".**
- 4 Press [ENTER],  $\blacktriangleleft$ /|| ENTER> or  $\blacktriangleright$ .**
- 5 Use  $\Delta$ / $\nabla$  to set the "minutes".**
- 6 Press [ENTER],  $\blacktriangleleft$ /|| ENTER> or  $\blacktriangleright$ .**  
The current time is set.

- Checking the current time when the power is on**  
Press [CLOCK].  
Press once more and the display returns to its original condition.
- Checking the current time when the power is set to standby**  
Press [CLOCK].  
The current time is displayed for 30 seconds.

#### NOTE

The time cannot be set when in the standby mode. Turn on the power first.

**Symbols used to indicate buttons in this manual**

Button located on both the main unit and the remote control → **BUTTON**  
 Button only on the main unit → **<BUTTON>**  
 Button only on the remote control → **[BUTTON]**

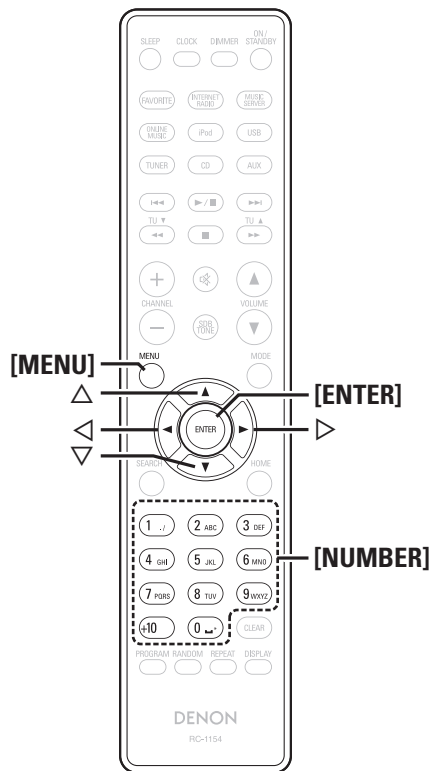
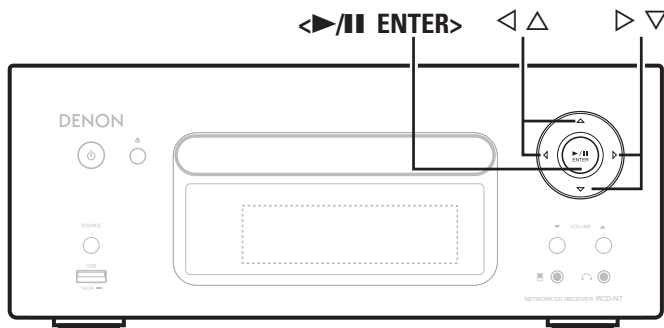

## Setting the network [Network]

### Connecting Wired LAN

When using this unit with the broadband router's DHCP function enabled, this unit automatically performs the IP address setting and other settings.

When using this unit connected to a network with no DHCP function, make the settings for the IP address, etc., at "Network connecting (DHCP=Off)" (☞ page 30).

**NOTE**

When setting manually, check the setting contents with the network administrator.

### Network connecting

**1** Connect the LAN cable.  
 (☞ page 8 "Connecting to a home network (LAN)")

**2** Turn on this unit.  
 (☞ page 11 "Turning the power on")

**3** Press [MENU].  
 Turns on the Menu settings mode and the Menu appears on the display. (☞ page 27 "Menu map")

**4** Use Δ ∇ to select "Network" – "Connection" – "DHCP (Off)", then press [ENTER], <Left>/|| ENTER> or Δ.  
 "DHCP" menu appears.

• When the network connection is set to "DHCP (On)", go to step 6.

**5** Use Δ ∇ to select "On", then press [ENTER], <Left>/|| ENTER> or Δ.  
 "Connection" menu appears.

**6** Use Δ ∇ to select "Connection", then press [ENTER], <Left>/|| ENTER> or Δ.  
 The connection starts.

• When the connection is made successfully, "Succeeded" appears. If the connection fails, "Failed" appears.

**NOTE**

You may need to set the network connection manually, depending on the provider you use. To set the connection manually, use the setting procedure of "Network connecting (DHCP=Off)".

### Network connecting (DHCP=Off)

**1** Perform steps 1 to 4 of the "Network connecting" procedure and select "Off" in step 5.  
 "Connection" menu appears.

**2** Use Δ ∇ to select "IP Address", then press [ENTER], <Left>/|| ENTER> or Δ.  
 "IP Address" input menu appears.

**3** Use Δ ∇ Δ or [NUMBER] (0–9) to input the address and press [ENTER] or <Left>/|| ENTER>.

**4** Use Δ ∇ Δ or [NUMBER] (0 – 9) to input the address for Subnet Mask, Gateway, Primary DNS, and Secondary DNS.

**5** After you input all required addresses, perform step 6 of "Network connecting" to connect to the Internet.

## Proxy Settings

Make this setting when connecting to the Internet via proxy server.

- 1 Press [MENU].**  
Turns on the Menu settings mode and the Menu appears on the display. (☞ page 27 "Menu map")
- 2 Use  $\Delta \nabla$  to select "Network" – "Connection" – "Proxy", then press [ENTER],  $\blacktriangleleft$ /|| ENTER or  $\blacktriangleright$ .**  
"Proxy" setting menu appears.
- 3 If "Proxy(On)" appears, go to step 5. If "Proxy(Off)" appears, press [ENTER],  $\blacktriangleleft$ /|| ENTER, or  $\blacktriangleright$ .**  
"Proxy" (On/Off) setting menu appears.
- 4 Use  $\Delta \nabla$  to select "On", then press [ENTER],  $\blacktriangleleft$ /|| ENTER or  $\blacktriangleright$ .**  
"Proxy" setting menu appears.
- 5 Use  $\Delta \nabla$  to select "Proxy (Address)" or "Proxy (Name)", then press [ENTER],  $\blacktriangleleft$ /|| ENTER or  $\blacktriangleright$ .**  
"Select Type" setting menu appears.
  - Seleccione si Proxy es una dirección de servidor o un nombre de dominio.
- 6 Use  $\Delta \nabla$  to select "Address" or "Name", then press [ENTER],  $\blacktriangleleft$ /|| ENTER or  $\blacktriangleright$ .**  
"Proxy" setting menu appears.
- 7 Use  $\Delta \nabla$  to select "Address" or "Name", then press [ENTER],  $\blacktriangleleft$ /|| ENTER or  $\blacktriangleright$ .**  
"Address" or "Name" input menu appears.
  - Input a server address or domain name.
- 8 Use  $\Delta \nabla \triangleright$  or [NUMBER] (0 – 9) to input the address or name, then press [ENTER] or  $\blacktriangleleft$ /|| ENTER.**  
"Proxy" setting menu appears.
- 9 Use  $\Delta \nabla$  to select "Port", then press [ENTER],  $\blacktriangleleft$ /|| ENTER or  $\blacktriangleright$ .**  
"Port" input menu appears.
- 10 Use  $\Delta \nabla \triangleright$  or [NUMBER] (0 – 9) to input the port, then press [ENTER] or  $\blacktriangleleft$ /|| ENTER.**  
The Proxy settings are completed.

## Connecting Wireless LAN

If you cancelled "Network First Setup" or changed the network environment, perform "Menu" – "Network" – "Network First Setup".

### Search Access Point (Wireless LAN)

- 1 Fitting a rod antenna.**  
If a LAN cable is connected, remove it.
- 2 Turn on this unit.**  
(☞ page 11 "Turning the power on")
- 3 Press [MENU].**  
Turns on the menu settings mode and the menu appears on the display. (☞ page 27 "Menu map")
- 4 Use  $\Delta \nabla$  to select "Network" – "Connection" – "Search Access Point", then press [ENTER],  $\blacktriangleleft$ /|| ENTER or  $\blacktriangleright$ .**  
The access point you have set is displayed.
- 5 Use  $\Delta \nabla$  to select the access point, and then press [ENTER],  $\blacktriangleleft$ /|| ENTER or  $\blacktriangleright$ .**  
If the access point is not detected automatically, use the "Manual Settings" (☞ page 32) procedure.
- 6 If there is an encryption setting for the access point you selected in step 5, enter same encryption key as used for the access point. (If there is no encryption setting, proceed to step 7.)**  
Use  $\Delta \nabla \triangleleft \triangleright$  to input the "Key" (encryption key) and press [ENTER],  $\blacktriangleleft$ /|| ENTER or  $\blacktriangleright$ . Enter the same encryption key as used for the access point.
  - The types of characters that can be input are as shown below.

[Upper case characters]  
ABCDEFGHIJKLMNOPQRSTUVWXYZ

[Lower case characters]  
abcdefghijklmnopqrstuvwxyz

[Symbols] ! " # \$ % & ' ( ) \* + , - . / : ; < = > ? @ [ \ ] ^ \_ ` { | } ~

[Numbers] 0123456789 (Space)

  - When no security settings have been used in the Internet connection settings, this step is not necessary.

- 7 Use  $\nabla$  to select "Connection", then press [ENTER],  $\blacktriangleleft$ /|| ENTER or  $\blacktriangleright$ .**  
Network connection starts.

- This unit performs automatic network setup due to the DHCP function.
- When connecting to a network that has no DHCP function, perform the setting in Network connecting (DHCP=Off) (☞ page 30).

### WPS Settings (Push-button method)

- 1 Press [MENU].**  
Turns on the Menu settings mode and the Menu appears on the display. (☞ page 27 "Menu map")
- 2 Use  $\Delta \nabla$  to select "Network" – "Connection" – "WPS" – "Push Button", then press [ENTER],  $\blacktriangleleft$ /|| ENTER or  $\blacktriangleright$ .**
- 3 Use  $\Delta \nabla$  to select "Enter", then press [ENTER],  $\blacktriangleleft$ /|| ENTER or  $\blacktriangleright$ .**  
Please push the WPS button of the router, and push the Enter button of the machine.
- 4 When connection is established with access point, "Succeeded" is displayed.**

### WPS Settings (PIN code method)

- 1 Press [MENU].**  
Turns on the Menu settings mode and the Menu appears on the display. (☞ page 27 "Menu map")
- 2 Use  $\Delta \nabla$  to select "Network" – "Connection" – "WPS" – "PIN code", then press [ENTER],  $\blacktriangleleft$ /|| ENTER or  $\blacktriangleright$ .**  
The access point you have set is displayed.
- 3 Use  $\Delta \nabla$  to select the access point, then press [ENTER],  $\blacktriangleleft$ /|| ENTER, or  $\blacktriangleright$ .**  
PIN code number is displayed.
- 4 Set this PIN code to the register.**  
When connection is established with access point, "Succeeded" is displayed.

**Hand icon** Symbols used to indicate buttons in this manual

- Button located on both the main unit and the remote control → **BUTTON**
- Button only on the main unit → **<BUTTON>**
- Button only on the remote control → **[BUTTON]**

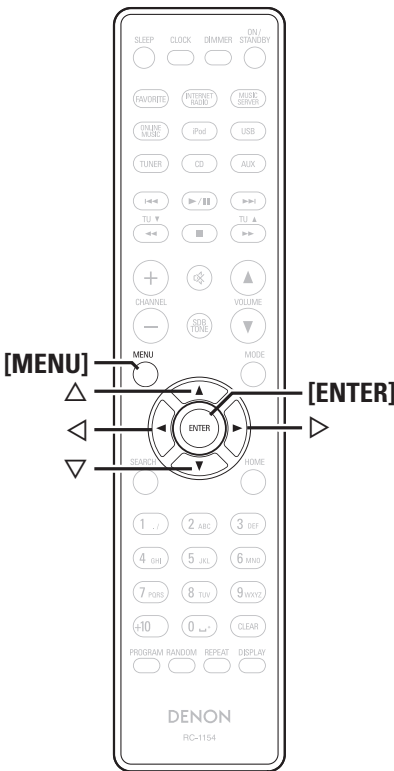
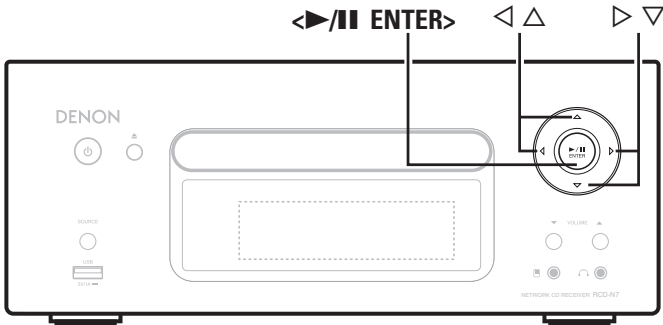

**Manual Settings**

- 1 Press [MENU].**  
Turns on the Menu settings mode and the Menu appears on the display. (See page 27 "Menu map")
- 2 Use  $\Delta$ / $\nabla$  to select "Network" – "Connection" – "Manual setting", then press [ENTER],  $\leftarrow$ / $\rightarrow$  or  $\triangleright$ .**
- 3 Use  $\Delta$ / $\nabla$  to select "SSID", then press [ENTER],  $\leftarrow$ / $\rightarrow$  or  $\triangleright$ .**
- 4 Use  $\Delta$ / $\nabla$ / $\leftarrow$ / $\triangleright$  to input the name of the wireless network (SSID), then press [ENTER] or  $\leftarrow$ / $\rightarrow$  or  $\triangleright$ .**

• The types of characters that can be input are as shown below.

**[Upper case characters]**  
 ABCDEFGHIJKLMNOPQRSTUVWXYZ  
**[Lower case characters]**  
 abcdefghijklmnopqrstuvwxyz  
**[Symbols]** ! " # \$ % & ' ( ) \* + , - . / : ; < = > ? @ [ \ ] ^ \_ ` { | } ~  
**[Numbers]** 0123456789 (Space)

- 5 Use  $\Delta$ / $\nabla$  to select "Security", then press [ENTER],  $\leftarrow$ / $\rightarrow$  or  $\triangleright$ .**
- 6 Use  $\Delta$ / $\nabla$  to select following items, then press [ENTER],  $\leftarrow$ / $\rightarrow$  or  $\triangleright$ .**
  - **None** : Select if not encrypted. Can also be used even without encryption, through we recommend encryption for improved security.
  - **WEP / WPA(TKIP) / WPA(AES) / WPA2(TKIP) / WPA2(AES)** : Select the encryption method according to the encryption setting of the access point you are using.

- 7 Use  $\Delta$ / $\nabla$  to input the "Key" (encryption key), then press [ENTER] or  $\leftarrow$ / $\rightarrow$  or  $\triangleright$ .**  
 Enter the same encryption key as used for the access point.
  - When no security settings have been used in the Internet connection settings, this step is not necessary.
  - When connecting to a "WEP" encrypted network, set the access point "Default Key" to "1".
- 8 Use  $\nabla$  to select "Connection" and press [ENTER],  $\leftarrow$ / $\rightarrow$  or  $\triangleright$ .**  
 Network connection starts.
  - This unit performs automatic network setup due to the DHCP function.

## Party Mode Function

The same network audio (Internet radio, music server or iPod DIRECT) can be played on multiple DENON products equipped with the Party Mode function and connected in a network.

The party mode consists of one organizer and up to four attendees.

When one unit starts the party mode as the organizer, up to four devices on which the party mode function is activated automatically participate in the party as attendees. "Party Mode Function" must be set to "ON" ahead of time in order to use the party mode function.

### □ Setting the Party Mode Function

**1 Press [MENU].**  
Turns on the Menu settings mode and the Menu appears on the display. (☞ page 27 "Menu map")

**2 Use  $\Delta$ / $\nabla$  to select "Network" – "Party Mode" – "Party Mode Function", then press [ENTER],  $\blacktriangleleft$ / $\blacktriangleright$  or  $\blacktriangledown$ .**  
"P-Mode Function" menu appears.

**3 Use  $\Delta$ / $\nabla$  to select "On" or "Off", then press [ENTER],  $\blacktriangleleft$ / $\blacktriangleright$  or  $\blacktriangledown$ .**

**On** : Enable party mode function.

**Off** : Disable party mode function.

### □ Starting the party mode as the organizer

**1 Press [MENU].**  
Turns on the Menu settings mode and the Menu appears on the display. (☞ page 27 "Menu map")

**2 Use  $\Delta$ / $\nabla$  to select "Network" – "Party Mode" – "Start Party", then press [ENTER],  $\blacktriangleleft$ / $\blacktriangleright$  or  $\blacktriangledown$ .**

- An error message is displayed when you are not connected to a network.
- The input source automatically switches to "Internet Radio" and the attendees are automatically selected.

**3 Play the desired station.**

### Canceling the party mode

**1 Press [MENU].**  
Turns on the Menu settings mode and the Menu appears on the display. (☞ page 27 "Menu map")

**2 Use  $\Delta$ / $\nabla$  to select "Network" – "Party Mode" – "Stop Party", then press [ENTER],  $\blacktriangleleft$ / $\blacktriangleright$  or  $\blacktriangledown$ .**  
"Exit Party Mode?" is displayed on the menu screen.

**3 Use  $\Delta$ / $\nabla$  to select "Yes", then press [ENTER],  $\blacktriangleleft$ / $\blacktriangleright$  or  $\blacktriangledown$ .**  
"Attendee P.Off?" is displayed.

**4 Use  $\Delta$ / $\nabla$  to select "Yes" or "No", then press [ENTER],  $\blacktriangleleft$ / $\blacktriangleright$  or  $\blacktriangledown$ .**

**Yes** : The power of the attendees is turned off and the party mode is canceled.

**No** : The party mode is canceled without turning off the power of the attendees.

### □ Participating in the party mode as an attendee

- When the organizer starts the party mode, up to four attendees are selected automatically. No operation is required.
- When a device becomes an attendee, **Party Mode Attendee** appears on the display. The input source automatically switches to "Internet Radio" and the same network audio as on the organizer is played.
- If there are fewer than four attendees, a device can join the party mode after it has started. To participate in the party mode, perform the operation described below.

**1 Press [MENU].**  
Turns on the Menu settings mode and the Menu appears on the display. (☞ page 27 "Menu map")

**2 Use  $\Delta$ / $\nabla$  to select "Network" – "Party Mode" – "Start Party", then press [ENTER],  $\blacktriangleleft$ / $\blacktriangleright$  or  $\blacktriangledown$ .**

- An error message is displayed when you are not connected to a network.

### Canceling the party mode

**1 Press [MENU].**  
Turns on the Menu settings mode and the Menu appears on the display. (☞ page 27 "Menu map")

**2 Use  $\Delta$ / $\nabla$  to select "Network" – "Party Mode" – "Stop Party", then press [ENTER],  $\blacktriangleleft$ / $\blacktriangleright$  or  $\blacktriangledown$ .**  
"Exit Party Mode?" is displayed on the menu screen.

**3 Use  $\Delta$ / $\nabla$  to select "Yes", then press [ENTER],  $\blacktriangleleft$ / $\blacktriangleright$  or  $\blacktriangledown$ .**  
In this case, the other devices remain in the party mode.



"Napster", "Pandora", "Rhapsody" and "USB" are not available in the Party Mode.

There can only be one organizer in the network. To form a new party mode, first cancel the current party mode.

### □ Setting the Party Start Level

Make settings for volume level when the party mode is started.

**1 Press [MENU].**  
Turns on the Menu settings mode and the Menu appears on the display. (☞ page 27 "Menu map")

**2 Use  $\Delta$ / $\nabla$  to select "Network" – "Party Mode" – "Party Start Level", then press [ENTER],  $\blacktriangleleft$ / $\blacktriangleright$  or  $\blacktriangledown$ .**

- **Last** : The same volume as set before the party mode was started.
- **00** : Always use the muting on condition when the party mode is started.
- **01 – 60dB** : Start party mode with your preferred volume.



This can be set when "Party Mode Function" is set to "ON".

**Symbols used to indicate buttons in this manual**

Button located on both the main unit and the remote control → **BUTTON**

Button only on the main unit → **<BUTTON>**

Button only on the remote control → **[BUTTON]**

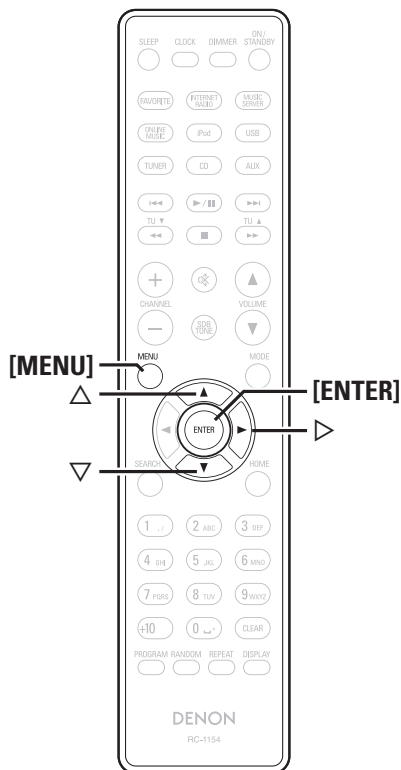
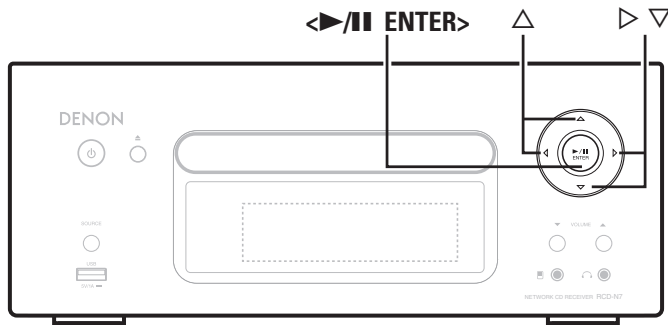

## Other Network

### Network Standby

Set the network function On/Off during standby.

- 1 Press [MENU].**  
Turns on the Menu settings mode and the Menu appears on the display. (☞ page 27 "Menu map")
- 2 Use  $\Delta$ / $\nabla$  to select "Network" – "Other Network" – "Network Standby", then press [ENTER],  $\langle \blacktriangleright / \blacksquare \rangle$  or  $\blacktriangleright$ .**  
"Network Standby" menu appears.
- 3 Use  $\Delta$ / $\nabla$  to "On", then press [ENTER],  $\langle \blacktriangleright / \blacksquare \rangle$  or  $\blacktriangleright$ .**

**On** : Shortens the time before the network connection is completed.

- Power consumption during the standby mode will be higher. (Power consumption: 3 W)
- Network standby mode is set and the power indicator lights red.

**Off** : Power consumption during the standby mode will be minimized. (Power consumption: 0.3 W)

- It will take slightly longer till the network connection is completed.
- This is the default setting.

### PC Language

Select computer environment language.

- 1 Press [MENU].**  
Turns on the Menu settings mode and the Menu appears on the display. (☞ page 27 "Menu map")
- 2 Use  $\Delta$ / $\nabla$  to select "Network" – "Other Network" – "PC Language", then press [ENTER],  $\langle \blacktriangleright / \blacksquare \rangle$  or  $\blacktriangleright$ .**  
"PC Language" setting menu appears.
- 3 Use  $\Delta$ / $\nabla$  to select your computer environment language, then press [ENTER],  $\langle \blacktriangleright / \blacksquare \rangle$  or  $\blacktriangleright$ .**

### Friendly Name Edit

The Friendly Name is the name of this unit displayed on the network.

- 1 Press [MENU].**  
Turns on the Menu settings mode and the Menu appears on the display. (☞ page 27 "Menu map")
- 2 Use  $\Delta$ / $\nabla$  to select "Network" – "Other Network" – "Friendly Name Edit", then press [ENTER],  $\langle \blacktriangleright / \blacksquare \rangle$  or  $\blacktriangleright$ .**  
"Friendly Name Edit" menu appears.
- 3 Edit a friendly name.**  
For the character input method, see "Inputting characters" (☞ page 36)

### Network Status

Displays up to a maximum of 10 DENON products connected on the same network.

- **Friendly Name / Party Mode Status / Model Name / Power ON / Standby / Select Source / Volume Level**

# Setting the others [Other]

## Auto Standby

With the Auto standby ON, this unit will automatically enter the standby mode after about 30 continuous minutes of stop mode with no operation.

- The default setting is "OFF".

- 1 Press [MENU].**  
Turns on the Menu settings mode and the Menu appears on the display. (☞ page 27 "Menu map")
- 2 Use  $\Delta$ / $\nabla$  to select "Other" – "Auto Standby", then press [ENTER],  $\blacktriangleleft$ /|| ENTER or  $\blacktriangleright$ .**
- 3 Use  $\Delta$ / $\nabla$  to select "On", then press [ENTER],  $\blacktriangleleft$ /|| ENTER or  $\blacktriangleright$ .**  
The setting is entered.

### NOTE

In the following situations, the Auto standby function does not operate.

- During CD playback or pause.
- When an iPod or USB memory device is connected to the USB port on the unit. When an iPod is connected to the iPod dock on the unit.
- When the input source is "TUNER", "AUX1", "AUX2" or "AUX3".
- When the input source is "Portable In" and a device connected to the Portable In jack.
- When the input source is "AUX3" and a signal is input.
- When the input source is "INTERNET RADIO", "MUSIC SERVER" or "ONLINE MUSIC", and a ethernet cable is connected to NETWORK connector.

## Screen Saver

Use the following procedure to set the screen saver.

- 1 Press [MENU].**  
Turns on the Menu settings mode and the Menu appears on the display. (☞ page 27 "Menu map")
- 2 Use  $\Delta$ / $\nabla$  to select "Other" – "Screen Saver", then press [ENTER],  $\blacktriangleleft$ /|| ENTER or  $\blacktriangleright$ .**  
"Screen Saver" menu appears.
- 3 Use  $\Delta$ / $\nabla$  to select "ON", then press [ENTER],  $\blacktriangleleft$ /|| ENTER or  $\blacktriangleright$ .**

## Using an optimizing filter

An optimizing filter suited for the properties of the speakers (SC-N7, sold separately) can be used.

- 1 Press [MENU].**  
Turns on the Menu settings mode and the Menu appears on the display. (☞ page 27 "Menu map")
- 2 Use  $\Delta$ / $\nabla$  to select "Other" – "Speaker Optimize", then press [ENTER],  $\blacktriangleleft$ /|| ENTER or  $\blacktriangleright$ .**  
"Speaker Optimize" menu appears.
- 3 Use  $\Delta$ / $\nabla$  to select "ON", then press [ENTER],  $\blacktriangleleft$ /|| ENTER or  $\blacktriangleright$ .**

**ON** : The response is optimized for the speakers (SC-N7, sold separately).

**OFF** : The response is flat.

## Firmware Update

- In order to use these functions, you must have the correct system requirements and settings for a broadband Internet connection (☞ page 8).
- Perform the firmware update operation after at least 2 minutes has elapsed since turning this unit's power ON.

- 1 Press [MENU].**  
Turns on the Menu settings mode and the Menu appears on the display. (☞ page 27 "Menu map")
- 2 Use  $\Delta$ / $\nabla$  to select "Other" – "Firmware Update", then press [ENTER],  $\blacktriangleleft$ /|| ENTER or  $\blacktriangleright$ .**

### [Selectable items]

**Check for Update** : Check for firmware updates. You can also check approximately how long it will take to complete an update.

**Start** : Execute the update process.

- If updating fails, the set automatically retries, but if updating is still not possible, one of the messages shown below is displayed. If the display reads as shown below, check the settings and network environment, then update again.

Display	Description
<b>Updating fail</b>	Updating failed.
<b>Login failed</b>	Failure to log into server.
<b>Server is busy</b>	Server is busy. Wait a while then try again.
<b>Connection fail</b>	Failure in connecting to server.
<b>Download fail</b>	Downloading of the firmware has failed.

### [Notes concerning use of "Firmware Update"]

- Do not turn off the power until updating is completed.
- Even with a broadband connection to the Internet, approximately 20 minutes is required for the updating procedure to be completed.
- Once updating starts, normal operations on this unit cannot be performed until updating is completed.
- Furthermore, updating the firmware may reset the backup data for the parameters, etc. set for this unit.
- If the update fails, remove and re-insert the power cord. "Update retry" appears on the display and update restarts from the point at which update failed. If the error continues despite this, check the network environment.

**Symbols used to indicate buttons in this manual**

- Button located on both the main unit and the remote control → **BUTTON**
- Button only on the main unit → **<BUTTON>**
- Button only on the remote control → **[BUTTON]**

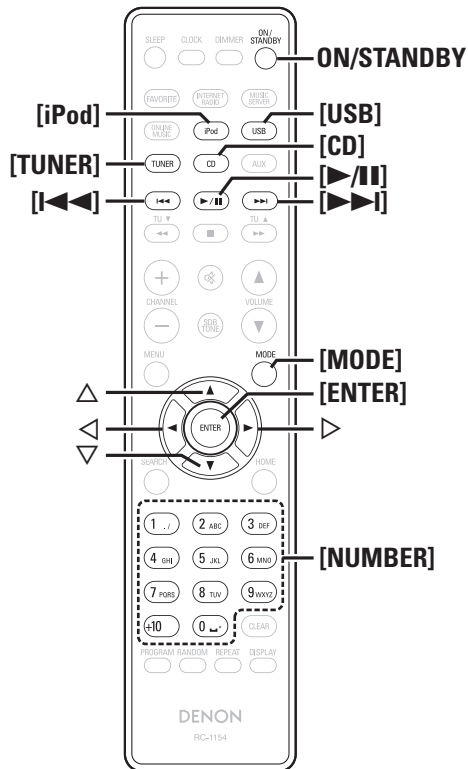
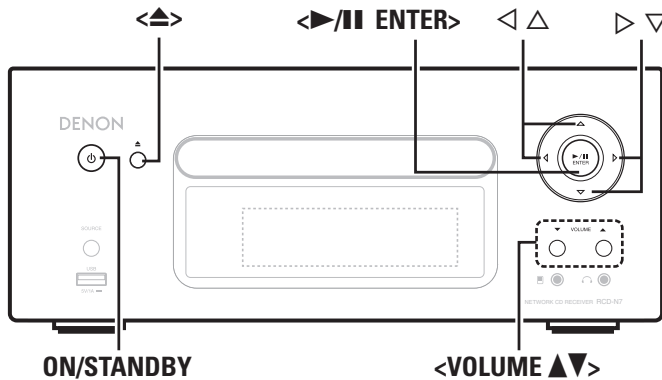

## Other functions

### Inputting characters

You can change the names as desired using the "Preset Name" (page 16), "Napster Account" (page 21), "Pandora account" (page 22), "Rhapsody account" (page 24), and character input for the network functions.

For inputting characters, there are two methods, as shown below.

Method	Operations
<b>Using the number buttons</b>	<ul style="list-style-type: none"> <li>Operating with the remote control unit.</li> <li>Multiple characters are assigned to a button, and each time the button is pressed, a character is switched.</li> </ul>
<b>Using the cursor buttons</b>	<ul style="list-style-type: none"> <li>Operating with the remote control unit or the main unit.</li> <li>Use <math>\Delta</math> <math>\nabla</math> <math>\triangleleft</math> <math>\triangleright</math> and <b>[ENTER]</b> or <b>&lt;▶/   ENTER&gt;</b> to input characters.</li> </ul>

#### Display of an input screen

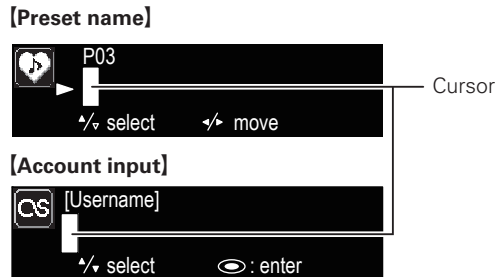

### Using the number buttons

**1** Display the screen for inputting characters.

**2** Place the cursor at the character to be changed with  $\triangleleft$   $\triangleright$  and press **[NUMBER] (0 – 9)** until the desired character is displayed.

The types of characters that can be input are as shown below.

<b>1</b> . / 1 . @ - _ / : ~	<b>6</b> MNO m n o M N O 6
<b>2</b> ABC abc ABC 2	<b>7</b> PQRS p q r s P Q R S 7
<b>3</b> DEF def DEF 3	<b>8</b> TUV t u v T U V 8
<b>4</b> GHI ghi G H I 4	<b>9</b> WXYZ w x y z W X Y Z 9
<b>5</b> JKL j k l J K L 5	<b>0</b> 0 (Space) ! " # \$ % & ' ( ) * + , ; < = > ? [ \ ] ^ ` {   }

- The input character type can be switched by pressing **[MODE]** while the display name is being changed.
- For entering the characters assigned to one number button continuously, press  $\triangleright$  to move the cursor to the right after entering a character then enter the next character.
- For entering characters assigned to separate buttons, press the number button continuously. The cursor automatically moves to the next position, and the entered character is registered.

**3** Repeat step 2 to change the name then press **[ENTER]** or **<▶/|| ENTER>** to register it.

**Example:** For changing characters from "POPS" to "ROCK"

- Place the cursor at "P". ▶ POPS
- Press **[7]** seven times. ▶ ROPS  
"P" changes to "R".
- Press  $\triangleright$  twice. ▶ RO P S  
"R" is automatically registered, and the cursor placed "P".
- Press **[2]** six times. ▶ ROC S  
"P" changes to "C".
- Press  $\triangleright$ . ▶ ROC S  
"C" is registered and the cursor placed "S".
- Press **[5]** five times. ▶ ROCK  
"S" changes to "K".
- Press **[ENTER]** or **<▶/|| ENTER>** to register the input name.



## Using the cursor buttons

**1** Display the screen for inputting characters.

**2** Use ◀ ▶ to set the cursor to the character you want to change.

**3** Use △ ▽ to change the character.

- The types of characters that can be input are as shown below.

<b>[Upper case characters]</b> ABCDEFGHIJKLMNOPQRSTUVWXYZ
<b>[Lower case characters]</b> abcdefghijklmnopqrstuvwxyz
<b>[Symbols]</b> ! " # \$ % & ' ( ) * + , - . / : ; < = > ? @ [ \ ] ^ _ ` {   } ~
<b>[Numbers]</b> 0123456789 (Space)

- The input character type can be switched by pressing [MODE] while the display name is being changed.

### Other buttons

- Press [◀◀] to delete the character.
- Press [▶▶] to insert a space.

**4** Repeat steps 2 and 3 to change the name then press [ENTER] or ▶/|| ENTER to register it.

## Auto power on

When the power is in standby, the power turns on when any of the buttons below other than **ON/STANDBY** is operated, and the respective operation is performed.

- ◀▶..... The disc tray opens.
- ▶/||..... Playback of the "CD", "iPod" or "USB" starts.
- [TUNER]..... Playback of the tuner starts.
- [CD]..... The input source switches to "CD" and the disc starts playing.
- [iPod]..... The input source switches to "iPod" and the iPod starts playing.
- [USB]..... The input source switches to "USB" and the USB starts playing.

## Last function memory

This stores the settings as they were immediately before going into the standby mode.

When the power is turned back on, the settings are restored to as they were immediately before going into the standby mode.

## Resetting the microprocessor

Perform this procedure if the display is abnormal or if operations cannot be performed.

When the microprocessor is reset, all the settings are reset to their default values.

**1** Unplug the power cord.

**2** Plug the power cord into a power outlet while pressing <VOLUME ▲> and <VOLUME ▼> simultaneously.  
"Initialized" is displayed.



If "Initialized" does not display in step 2, start over from step 1.

# Information

## Part names and functions

For buttons not explained here, see the page indicated in parentheses ( ).

### Front panel

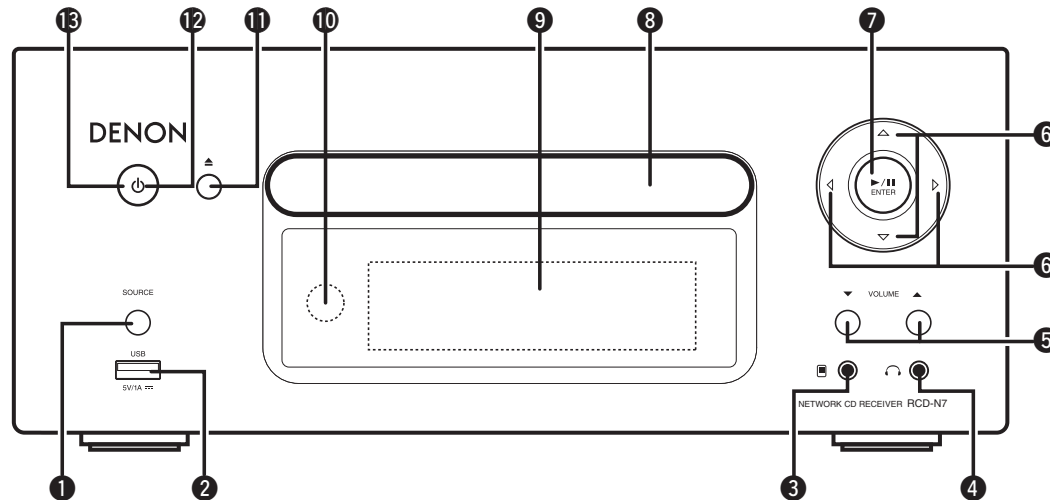

- |   |  |
|---|--|
| <b>1 SOURCE button</b> ..... (12)                     | <b>7 Play/Pause/ENTER button (▶/⏸/ENTER)</b> ..... (13)  |
| Selects the input source.                             |  |
| <b>2 USB port</b> ..... (9)                           | <b>8 Disc tray</b> ..... (3)                             |
| Used to connect iPod or USB memory devices.           | Tray used to insert a compact disc.                      |
| <b>3 Portable in jack (📻)</b> ..... (25)              | <b>9 Display</b>   |
| Used to connect portable audio devices.               | Displays play status, settings, etc.                     |
| <b>4 Headphones jack (🎧)</b> ..... (13)               | <b>10 Remote control sensor</b> ..... (4)                |
| Used to connect headphones.                           |  |
| <b>5 Volume up/down button (VOLUME ▲▼)</b> ..... (12) | <b>11 Disc tray open/close button (⏏)</b> ..... (13)     |
| Adjusts the audio volume.                             | Used to open/close the disc tray.                        |
| <b>6 Cursor button (⏪ ⏩)</b> ..... (12)               | <b>12 Power indicator</b> ..... (11)                     |
|   |  |
|   | <b>13 Power operation button (ON/STANDBY)</b> ..... (11) |

### Top panel

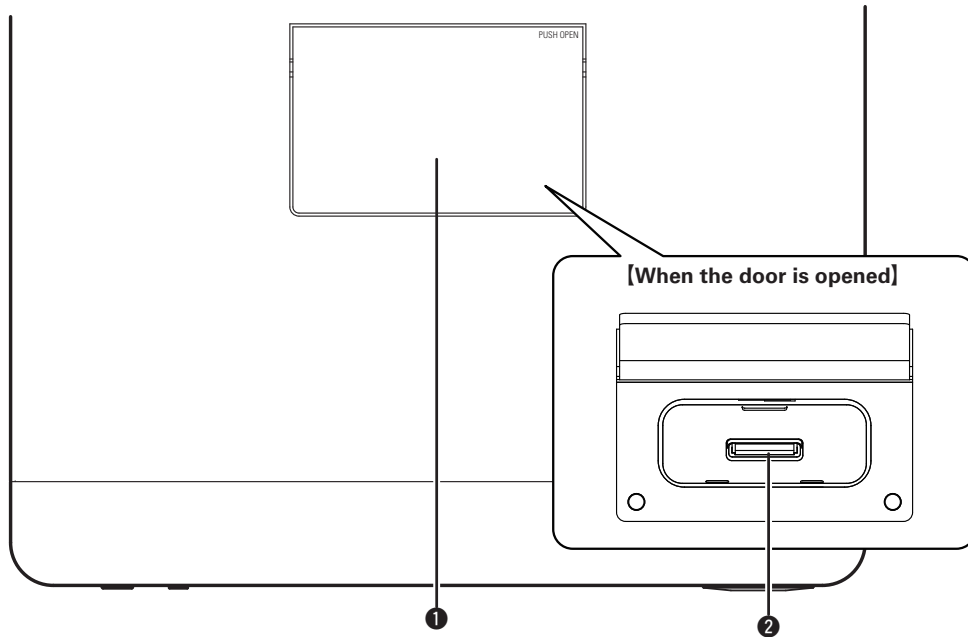

- 1 Dock for iPod ..... (9)
- 2 Dock connector..... (9)

### Rear panel

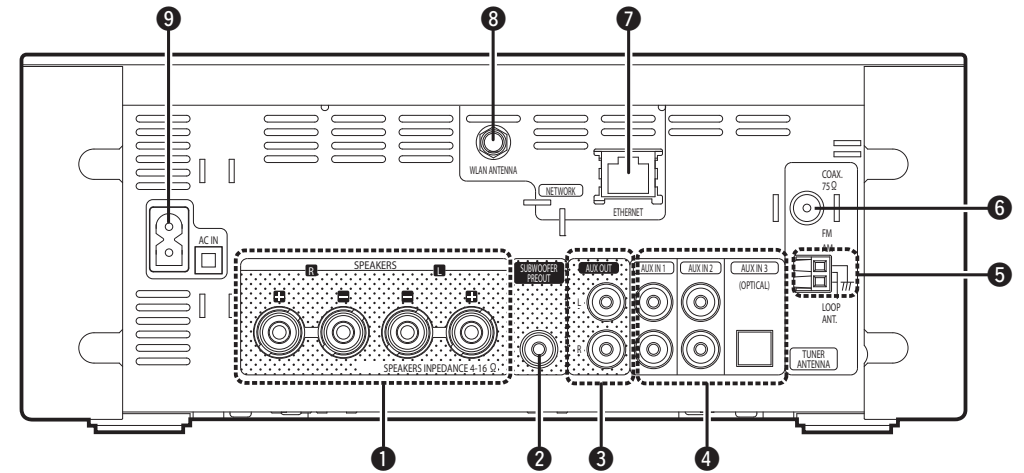

- 1 Speaker output terminals..... (5)  
Connect to the speakers.
- 2 SUBWOOFER PRE OUT terminal..... (5)  
Connect to the input terminal of a powered subwoofer.
- 3 AUX OUT terminals ..... (6)  
Connect to an external pre-main amplifier.
- 4 AUX IN terminals ..... (6)  
Connect to analog/digital audio.
- 5 AM antenna terminal ..... (7)  
Connect to the supplied AM antenna.
- 6 FM antenna terminal..... (7)  
Connect the supplied FM antenna. Connect to an external antenna if reception is poor.
- 7 ETHERNET connector ..... (8)
- 8 WLAN ANTENNA terminal ..... (8)
- 9 AC inlet (AC IN)..... (10)  
Connect the supplied AC power cord.

Getting Started

Connections

Basic Operations

Advanced Operations

Information

Explanation terms

Troubleshooting

Specifications

Index

## Remote control

This section explains the buttons used to playback each input source.

### Buttons that work with all input sources (CD, TUNER, iPod, USB and NETWORK)

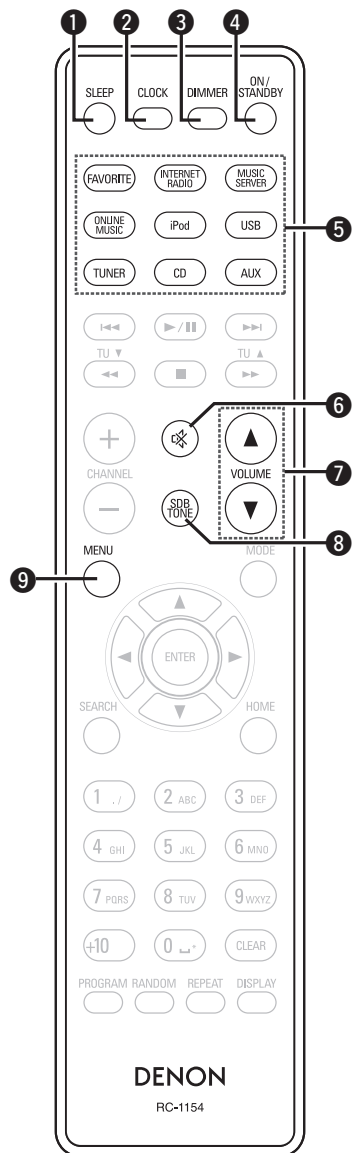

- 1 SLEEP button ..... (13)
- 2 CLOCK button ..... (29)
- 3 DIMMER button ..... (13)
- 4 ON/STANDBY button ..... (11)
- 5 Input source select button ..... (12)
- 6 MUTE button ..... (12)
- 7 Master volume control buttons (VOLUME) ..... (12)
- 8 SDB/TONE button ..... (12)
- 9 MENU button ..... (28 – 35)

### Buttons that work with CDs

The buttons listed at “Buttons that work with all input sources” can also be used.

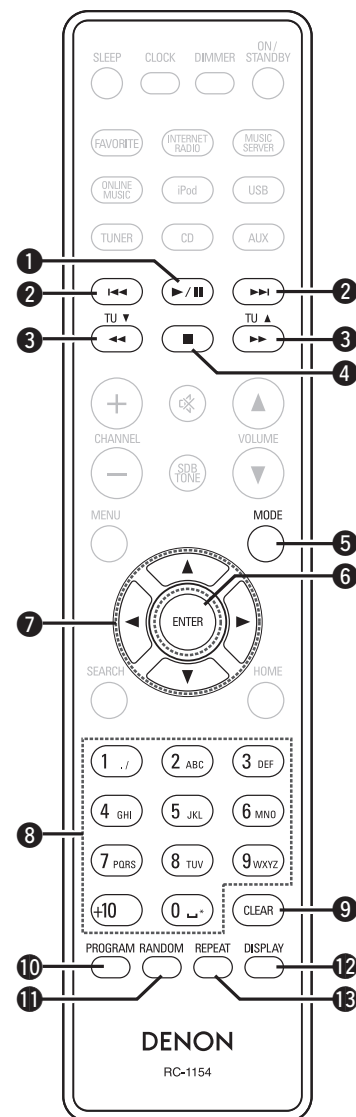

- 1 Play/Pause button (▶/||) ..... (13)
- 2 Reverse-skip/Forward-skip buttons (◀◀, ▶▶) ..... (13)
- 3 Fast-reverse/Fast-forward buttons (◀◀, ▶▶) ..... (13)
- 4 Stop button (■) ..... (13)
- 5 MODE button ..... (15)
- 6 ENTER button ..... (13)
- 7 Cursor buttons (▲, ▼, ◀, ▶) ..... (13)
- 8 Number buttons ..... (13)
- 9 CLEAR button ..... (14)
- 10 PROGRAM button ..... (14)
- 11 RANDOM button ..... (14)
- 12 DISPLAY button ..... (13)
- 13 REPEAT button ..... (14)

**Buttons that work with the tuner**

The buttons listed at "Buttons that work with all input sources" can also be used.

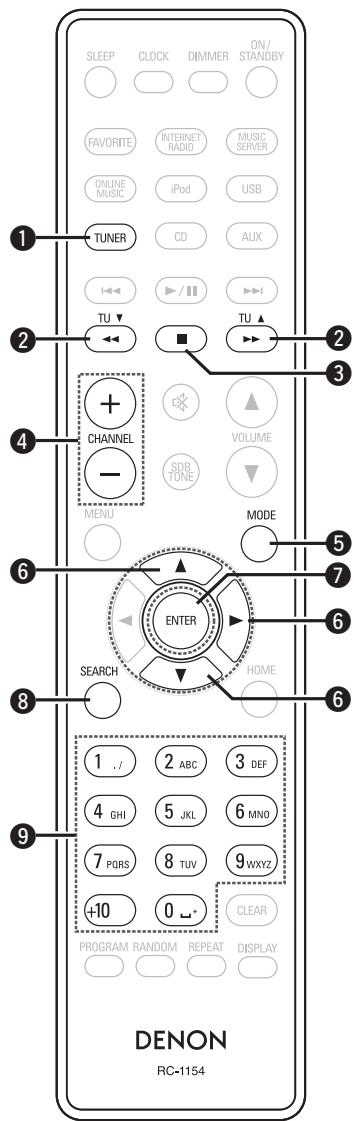

- 1 **TUNER button** ..... (16)
- 2 **TUNING buttons (TU ▲, TU ▼)** ..... (16)
- 3 **Stop button (■)** ..... (16)
- 4 **Channel buttons (+, -)** ..... (17)
- 5 **MODE button** ..... (16)
- 6 **Cursor buttons (▲▼▷)** ..... (16)
- 7 **ENTER button** ..... (16)
- 8 **SEARCH button** ..... (16)
- 9 **Number buttons** ..... (17)

**Buttons that work with iPods or USBs**

The buttons listed at "Buttons that work with all input sources" can also be used.

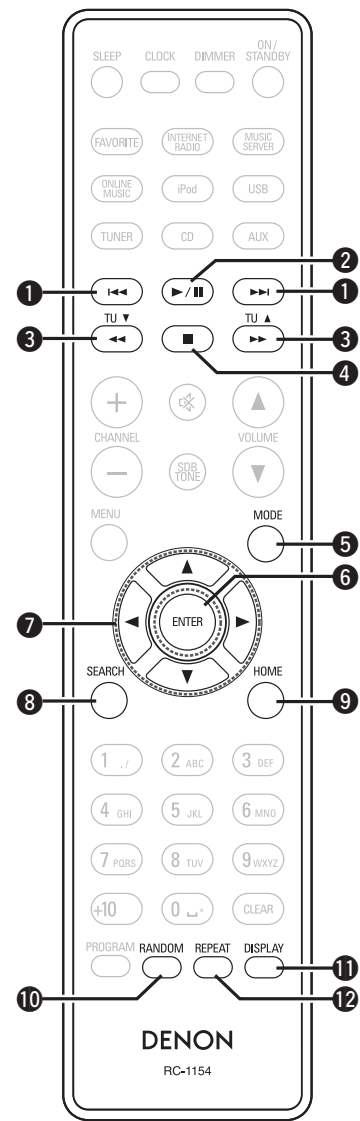

- 1 **Reverse-skip/Forward-skip buttons (◀◀, ▶▶)** ..... (18)
- 2 **Play/Pause button (▶/||)** ..... (17)
- 3 **Fast-reverse/Fast-forward buttons (◀◀, ▶▶)** ..... (18)
- 4 **Stop button (■)** ..... (18)
- 5 **MODE button** ..... (17)
- 6 **ENTER button** ..... (17)
- 7 **Cursor buttons (▲▼◀▷)** ..... (17)
- 8 **SEARCH button** ..... (19)
- 9 **HOME button** ..... (18)
- 10 **RANDOM button** ..... (18)
- 11 **DISPLAY button** ..... (18)
- 12 **REPEAT button** ..... (18)

**Buttons that work with Network**

The buttons listed at "Buttons that work with all input sources" can also be used.

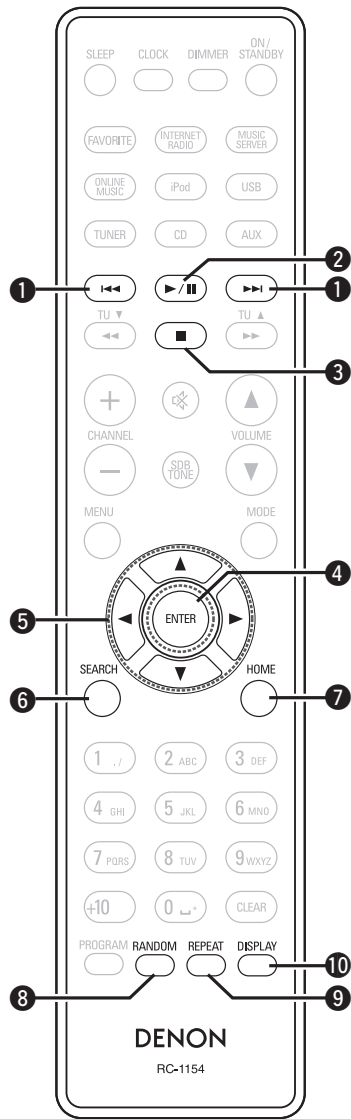

- 1 Reverse-skip/Forward-skip buttons**  
(|◀◀, ▶▶|) ..... (21)
- 2 Play/Pause button (▶/||)** ..... (21)
- 3 Stop button (■)** ..... (20)
- 4 ENTER button** ..... (19)
- 5 Cursor buttons (△▽◀▶)** ..... (19)
- 6 SEARCH button** ..... (20)
- 7 HOME button** ..... (20)
- 8 RANDOM button** ..... (21)
- 9 REPEAT button** ..... (21)
- 10 DISPLAY button** ..... (19)

## MP3 and WMA

### MP3 and WMA formats

CD-R and CD-RW discs created in the format described below can be played.

#### ❑ Writing software format

ISO9660 level 1

When written in other formats, it may not be possible to play the disc properly.

#### ❑ Maximum number of playable files and folders

Total number of folders and files : 512

Number of folders : 256

#### ❑ File format

MPEG-1 Audio Layer-3

WMA (Windows Media Audio)

#### ❑ Tag data

ID3-Tag (Ver. 1.x and 2.x)

META-Tag

(Compatible with title, artist and album names)

Playable MP3/WMA file			
File format	Sampling frequency	Bit rate	Extension
MP3	32, 44.1, 48 kHz	32 ~ 320 kbps	.mp3
WMA	32, 44.1, 48 kHz	64 ~ 192 kbps	.wma



- Be sure to give files the extension “.MP3” or “.WMA”. Files with any other extensions or with no extensions cannot be played.
- Mac OS X files assigned with filenames that begin with “.” are not music data and cannot be played back.
- In accordance with copyright laws, recordings you have made should only be used for your personal enjoyment and may not be used in other ways without permission of the copyright holder.

## iPod®



“Made for iPod” and “Made for iPhone” mean that an electronic accessory has been designed to connect specifically to iPod, or iPhone, respectively, and has been certified by the developer to meet Apple performance standards.

Apple is not responsible for the operation of this device or its compliance with safety and regulatory standards.

Please note that the use of this accessory with iPod or iPhone may affect wireless performance.

iPhone, iPod, iPod classic, iPod nano, iPod shuffle, and iPod touch are trademarks of Apple Inc., registered in the U.S. and other countries.

- Individual users are permitted to use iPhone, iPod, iPod classic, iPod nano, iPod shuffle, and iPod touch for private copy and playback of non-copyrighted contents and contents whose copy and playback is permitted by law. Copyright infringement is prohibited by law.

#### NOTE

- DENON will accept no responsibility whatsoever for any loss of iPod data.
- Depending on the type of iPod and the software version, some functions may not operate.
- When connecting an iPhone to the USB port of this unit, keep the iPhone at least 20cm away from this unit. If the iPhone is kept closer to this unit and a telephone call is received by the iPhone, noise may be output from this device.

## USB memory device

### Important information

A USB memory device can be connected to the USB port of this unit to play music files stored on the USB memory device.

Also, files stored on an iPod can be played when the iPod is connected directly to the USB port of this unit. See "Connecting an iPod" (page 9).

- Only USB memory devices conforming to mass storage class and MTP (Media Transfer Protocol) standards can be played on this unit.
- This unit is compatible with USB memory devices in "FAT16" or "FAT32" format.



If the number of files stored in a USB memory device exceeds 1,000, the access speed may become slower.

#### [Compatible formats]

	USB memory devices *1
<b>WMA</b> (Windows Media Audio)	✓ *2
<b>MP3</b> (MPEG-1 Audio Layer-3)	✓
<b>WAV</b>	✓
<b>MPEG-4 AAC</b>	✓ *3
<b>FLAC</b> (Free Lossless Audio Codec)	✓

\*1 USB

- This unit is compatible with MP3 ID3-Tag (Ver. 2) standard.
- This unit is compatible with WMA META tags.
- WAV format Quantization bit rate: 16 bits.

\*2 Copyright-protected files can be played on certain portable players compatible with MTP.

\*3 Only files that are not protected by copyright can be played on this unit.

Content downloaded from pay sites on the Internet are copyright protected. Also, files encoded in WMA format when ripped from a CD, etc. on a computer may be copyright protected, depending on the computer's settings.

#### [Compatible formats]

	Sampling frequency	Bit rate	Extension
<b>WMA</b> (Windows Media Audio)	32/44.1/48 kHz	48 – 192 kbps	.wma
<b>MP3</b> (MPEG-1 Audio Layer-3)	32/44.1/48 kHz	32 – 320 kbps	.mp3
<b>WAV</b>	32/44.1/48 kHz	–	.wav
<b>MPEG-4 AAC</b>	32/44.1/48 kHz	16 – 320 kbps	.aac/ .m4a/ .mp4
<b>FLAC</b> (Free Lossless Audio Codec)	32/44.1/48/96 kHz	–	.flac



## Network audio

### Important information

#### ❑ About the internet radio function

- Internet radio refers to radio broadcasts distributed over the Internet. Internet radio stations from around the world can be received.
- This unit is equipped with the following Internet radio functions:
  - Stations can be selected by genre and region.
  - Up to 56 Internet radio stations can be preset.
  - Internet radio stations in MP3 and WMA (Windows Media Audio) format can be listened to.
  - Your favorite radio stations can be registered by accessing an exclusive DENON Internet radio URL from a Web browser on a computer.
- The function is managed for individual users, so you must provide your MAC or e-mail address.  
Exclusive URL: <http://www.radiodenon.com>
- The radio station database service may be suspended without notice.
- This unit's Internet radio station list is created using a radio station database service (vTuner). This database service provides a list edited and created for this unit.

#### ❑ Music server

This function lets you play music files and playlists (m3u, wpl) stored on a computer (music server) connected to this unit via a network.

With this unit's network audio playback function, connection to the server is possible using one of the technologies below.

- Windows Media Player Network Sharing Service
- Windows Media DRM10

#### [Compatible formats]

	Internet radio	Music server *1
<b>WMA</b> (Windows Media Audio)	✓	✓
<b>MP3</b> (MPEG-1 Audio Layer-3)	✓	✓
<b>WAV</b>		✓
<b>MPEG-4 AAC</b>		✓*2
<b>FLAC</b> (Free Lossless Audio Codec)		✓

A server or server software compatible with distribution in the corresponding formats is required to play music files via a network.

\*1 Music server

- This unit is compatible with MP3 ID3-Tag (Ver. 2) standard.
- This unit is compatible with WMA META tags.
- WAV format Quantization bit rate: 16 bits.

\*2 Only files that are not protected by copyright can be played on this unit.

Content downloaded from pay sites on the Internet are copyright protected. Also, files encoded in WMA format when ripped from a CD, etc. on a computer may be copyright protected, depending on the computer's settings.

#### [Compatible formats]

	Sampling frequency	Bit rate	Extension
<b>WMA</b> (Windows Media Audio)	32/44.1/48 kHz	48 – 192 kbps	.wma
<b>MP3</b> (MPEG-1 Audio Layer-3)	32/44.1/48 kHz	32 – 320 kbps	.mp3
<b>WAV</b>	32/44.1/48 kHz	–	.wav
<b>MPEG-4 AAC</b>	32/44.1/48 kHz	16 – 320 kbps	.aac/ .m4a/ .mp4
<b>FLAC</b> (Free Lossless Audio Codec)	32/44.1/48/96 kHz	–	.flac

#### ❑ About Napster

Napster is a monthly subscription music distribution service provided by Napster LLC. This service allows users to download and play pieces of music they want to hear on this unit. Before you can use Napster, you will need to visit the Napster website on your PC to create an account and register as a member. For details, access the following site:

[http://www.napster.com/choose/index\\_default.html](http://www.napster.com/choose/index_default.html)

#### ❑ About Pandora

Pandora is a free, personalized radio service. Simply enter in the name of your favorite song, artist or classical composer and Pandora will create a radio station that plays music you love. Before you first listen to Pandora on your DENON device, you will either need to associate your device with an existing Pandora account or create a new Pandora account for use on the device. Please launch the Pandora service on your DENON device for more information about how to complete the device association process. For more general information about Pandora please visit the Pandora FAQ at <http://blog.pandora.com/faq/>

#### ❑ About Rhapsody

Rhapsody is a paid music broadcast service of RealNetworks. When you first listen to Rhapsody, it is necessary to subscribe to a Rhapsody account at the Rhapsody homepage by your PC and register this machine. See the Rhapsody homepage for details. <http://www.rhapsody.com/denon>

# Explanation terms

## A

### AES (Advanced Encryption Standard)

This is a next generation standard encryption method replacing the current DES and 3DES, and because of its high security it is expected to be applied widely to wireless LANs in the future. It uses the "Rijndael" algorithm developed by two Belgian cryptographers to divide the data into blocks of fixed lengths and encrypt each block. It supports data lengths of 128, 192 and 256 bits and key lengths of 128, 192 and 256 bits as well, offering extremely high encryption security.

## B

### Bit rate

This expresses the read amount per 1 second of video/audio data recorded in a disc.

## D

### DLNA

DLNA and DLNA CERTIFIED are trademarks and/or service marks of Digital Living Network Alliance. Some contents may not be compatible with other DLNA CERTIFIED™ products.

## F

### Finalize

This is processing that enables playing back of disc of CD, which was recorded using a recorder, by other players.

## I

### IEEE 802.11b

This is one wireless LAN standard set by the 802 working group that establishes LAN technology standards at the IEEE (Institute of Electrical and Electronics Engineers) of the United States. It uses the 2.4 GHz band usable freely without a radio frequency license (ISM band), enabling communications at a maximum speed of 11 Mbps.

- The value indicated above is the maximum theoretical value for the wireless LAN standard, and does not indicate the actual data transfer rate.

### IEEE 802.11g

This is another wireless LAN standard set by the 802 working group that establishes LAN technology standards at the IEEE (Institute of Electrical and Electronics Engineers) of the United States, and is compatible with IEEE 802.11b. It also uses the 2.4 GHz band, but enables communications at a maximum speed of 54 Mbps.

- The value indicated above is the maximum theoretical value for the wireless LAN standard, and does not indicate the actual data transfer rate.

## M

### MP3 (MPEG Audio Layer-3)

This is an internationally standardized audio data compression scheme, using the "MPEG-1" video compression standard. It compresses the data volume to about one eleventh its original size while maintaining sound quality equivalent to a music CD.

### MPEG (Moving Picture Experts Group), MPEG-2, MPEG-4

These are the names for digital compression format standards used for the encoding of video and audio. Video standards include "MPEG-1 Video", "MPEG-2 Video", "MPEG-4 Visual", "MPEG-4 AVC". Audio standards include "MPEG-1 Audio", "MPEG-2 Audio", "MPEG-4 AAC".

## N

### Network Names

#### (SSID: Security Set Identifier)

When forming wireless LAN networks, groups are formed to prevent interference, data theft, etc. This grouping is done by "SSID" or "Security Set Identifiers". For further security, a WEP key is set and signal transfer is not possible unless the SSID and WEP key match.

## P

### Protection circuit

This is a function to prevent damage to components within the power supply when an abnormality such as an overload, excess voltage occurs or temperature for any reason.

In this unit, the power turns off suddenly.

## S

### Sampling frequency

Sampling involves taking a reading of a sound wave (analog signal) at regular intervals and expressing the height of the wave at each reading in digitized format (producing a digital signal).

The number of readings taken in one second is called the "sampling frequency". The larger the value, the closer the reproduced sound is to the original.

### Speaker impedance

This is an AC resistance value, indicated in  $\Omega$  (ohms). Greater power can be obtained with this value smaller.

## T

### TKIP (Temporal Key Integrity Protocol)

This is a network key used for WPA. The encryption algorithm is RC4, the same as for WEP, but the security level is increased by changing the network key used for encryption for each packet.

## V

### vTuner

This is a free online content server for Internet radio. Note that usage fees are included in upgrade costs.

For inquiries about this service, visit the vTuner site below.

vTuner website: <http://www.radiodemon.com>

This product is protected by certain intellectual property rights of Nothing Else Matters Software and BridgeCo. Use or distribution of such technology outside of this product is prohibited without a license from Nothing Else Matters Software and BridgeCo or an authorized subsidiary.

## W

### WEP Key (Network Key)

This is key information used for encrypting data when conducting data transfer. On this unit, the same WEP key is used for data encryption and decryption, so the same WEP key must be set on both devices in order for communications to be established between them.

### Wi-Fi®

Wi-Fi Certification assures tested and proven interoperability by the Wi-Fi Alliance, a group certifying interoperability among wireless LAN devices.

### Windows Media DRM

This is a copyright protection technology developed by Microsoft.

Content providers are using the digital rights management technology for Windows Media contained in this device (WM-DRM) to protect the integrity of their content (Secure Content) so that their intellectual property, including copyright, in such content is not misappropriated. This device uses WM-DRM software to play Secure Content (WM-DRM Software). If the security of the WM-DRM Software in this device has been compromised, owners of Secure Content (Secure Content Owners) may request that Microsoft revoke the WM-DRM Software's right to acquire new licenses to copy, display and/or play Secure Content. Revocation does not alter the WM-DRM Software's ability to play unprotected content.

A list of revoked WM-DRM Software is sent to your device whenever you download a license for Secure Content from the Internet or from a PC.

Microsoft may, in conjunction with such license, also download revocation list onto your device on behalf of Secure Content Owners.

### Windows Media Player Ver. 11

This is a media player distributed free of charge by Microsoft Corporation.

It can be used to play playlists created with Windows Media Player Ver. 11 as well as files in such formats as WMA, DRM WMA, MP3 and WAV.

### WMA (Windows Media Audio)

This is audio compression technology developed by Microsoft Corporation.

WMA data can be encoded using Windows Media® Player Ver.7, 7.1, Windows Media® Player for Windows® XP and Windows Media® Player 9 Series.

To encode WMA files, only use applications authorized by Microsoft Corporation. If you use an unauthorized application, the file may not work properly.

**WPA (Wi-Fi Protected Access)**

This is a security standard established by the Wi-Fi Alliance. In addition to the conventional SSID (network name) and WEP key (network key), it also uses a user identification function and encrypting protocol for stronger security.

**WPA2 (Wi-Fi Protected Access 2)**

This is a new version of the WPA established by the Wi-Fi Alliance, compatible with more secure AES encryption.

**WPA-PSK/WPA2-PSK (Pre-shared Key)**

This is a simple authentication system for mutual authentication when a preset character string matches on the wireless LAN access point and client.

**WPS (Wi-Fi Protected Setup)**

This is a standard drawn up by the Wi-Fi Alliance to ease the task of setting up wireless LAN connections and configuring security.

There are two methods: push-button and PIN (Personal Identification Number) code.

# Troubleshooting

If a problem occurs first check the following:

1. Are the connections correct?
2. Is the set being operated as described in the owner's manual?
3. Are the other components operating properly?

If this unit does not operate properly, check the items listed in the table below. If the problem persists, there may be a malfunction.

In this case, disconnect the power immediately and contact your retail outlet.

**[General]**

Symptom	Cause	Countermeasure	Page
Set does not operate properly.	<ul style="list-style-type: none"> <li>• External noise or interference is causing the set to malfunction.</li> </ul>	<ul style="list-style-type: none"> <li>• Reset the microprocessor.</li> </ul>	37
Display not lit and sound not produced when power switched to on.	<ul style="list-style-type: none"> <li>• Power cord not plugged in securely.</li> </ul>	<ul style="list-style-type: none"> <li>• Check the connections on the set's rear panel and the connection of the power plug to the power outlet.</li> </ul>	10
Display lit but sound not produced.	<ul style="list-style-type: none"> <li>• Wrong input source selected.</li> <li>• Volume control set to minimum.</li> <li>• MUTING is on.</li> </ul>	<ul style="list-style-type: none"> <li>• Select the appropriate input source.</li> <li>• Turn volume up to suitable level.</li> <li>• Switch off MUTING.</li> </ul>	12 12 12
Display is off.	<ul style="list-style-type: none"> <li>• The Dimmer setting is set to "OFF".</li> </ul>	<ul style="list-style-type: none"> <li>• Set to something other than "OFF".</li> </ul>	13
Power turns off suddenly and POWER indicator flashes red. (Flashes at 0.5 second intervals)	<ul style="list-style-type: none"> <li>• Core wires of two speakers are touching each other or a core wire is sticking out of the terminal and touching the set's rear panel, activating the protection circuit.</li> </ul>	<ul style="list-style-type: none"> <li>• First unplug the power cord, then twist the core wires tightly or terminate the speaker cables, then reconnect.</li> </ul>	5
Power turns off suddenly and POWER indicator flashes red. (Flashes at 0.25 second intervals)	<ul style="list-style-type: none"> <li>• Set is damaged.</li> </ul>	<ul style="list-style-type: none"> <li>• Turn off the power and contact a DENON service center.</li> </ul>	–
Power turns off suddenly and POWER indicator flashes red. (Flashes at 2 second intervals)	<ul style="list-style-type: none"> <li>• Protection circuit activated due to a rise in internal temperature.</li> </ul>	<ul style="list-style-type: none"> <li>• Turn off the power, wait for the set to fully cool down, then turn the power back on.</li> <li>• Place the set in a well-ventilated location.</li> </ul>	6 II

Symptom	Cause	Countermeasure	Page
The TV sound is not output.	<ul style="list-style-type: none"> <li>Other digital audio signals than 2 channel linear PCM cannot be input through AUX IN 3 (OPTICAL) terminal of this unit.</li> </ul>	<ul style="list-style-type: none"> <li>When you try to input digital audio signals other than 2 channel linear PCM to this unit, set the digital audio output setting of the TV to 2 channel PCM.</li> <li>For details, see the operating instructions of the TV.</li> </ul>	–
“No Network Connection” is displayed.	<ul style="list-style-type: none"> <li>The network is not properly set up.</li> </ul>	<ul style="list-style-type: none"> <li>Perform “Network First Setup.”</li> <li>Select a source other than the network function.</li> </ul>	27 12

**[Remote control]**

Symptom	Cause	Countermeasure	Page
Set does not work properly when remote control operated.	<ul style="list-style-type: none"> <li>Batteries are worn.</li> </ul>	<ul style="list-style-type: none"> <li>Replace with new batteries.</li> </ul>	4
	<ul style="list-style-type: none"> <li>You are operating outside of the specified range.</li> </ul>	<ul style="list-style-type: none"> <li>Operate within the specified range.</li> </ul>	4
	<ul style="list-style-type: none"> <li>Obstacle between main unit and remote control.</li> </ul>	<ul style="list-style-type: none"> <li>Remove the obstacle.</li> </ul>	–
	<ul style="list-style-type: none"> <li>The batteries are not inserted in the proper direction, as indicated by the polarity marks in the battery compartment.</li> </ul>	<ul style="list-style-type: none"> <li>Insert the batteries in the proper direction, following the polarity marks in the battery compartment.</li> </ul>	4
	<ul style="list-style-type: none"> <li>The set’s remote control sensor is exposed to strong light (direct sunlight, fluorescent light, etc.).</li> </ul>	<ul style="list-style-type: none"> <li>Move the set to a place in which the remote control sensor will not be exposed to strong light.</li> </ul>	4

**[CD]**

Symptom	Cause	Countermeasure	Page
“Unsupported” is shown on the display even though a CD is loaded.	<ul style="list-style-type: none"> <li>The disc is not properly loaded.</li> </ul>	<ul style="list-style-type: none"> <li>Reload the disc.</li> </ul>	3
Disc does not play when ►/   button is pressed.	<ul style="list-style-type: none"> <li>The disc is dirty or scratched.</li> </ul>	<ul style="list-style-type: none"> <li>Wipe the disc clean or replace the disc.</li> </ul>	3
A specific part of a disc is not played.	<ul style="list-style-type: none"> <li>The disc is dirty or scratched.</li> </ul>	<ul style="list-style-type: none"> <li>Wipe the disc clean or replace the disc.</li> </ul>	3
A CD-R or CD-RW disc cannot be played.	<ul style="list-style-type: none"> <li>The disc has not been finalized.</li> <li>The recording conditions are bad or the quality of the disc itself is poor.</li> </ul>	<ul style="list-style-type: none"> <li>Finalize the disc then play it.</li> </ul>	3
		<ul style="list-style-type: none"> <li>Use a properly recorded disc.</li> </ul>	–
MP3 and WMA files cannot be played.	<ul style="list-style-type: none"> <li>The file formats, extensions or settings made when the disc was created are not compatible with this unit.</li> </ul>	<ul style="list-style-type: none"> <li>Create discs with file formats, extensions or settings compatible with this unit.</li> </ul>	43

**[Tuner]**

Symptom	Cause	Countermeasure	Page
Continuous noise is heard when receiving FM programs.	<ul style="list-style-type: none"> <li>Antenna cable is not properly connected.</li> </ul>	<ul style="list-style-type: none"> <li>Connect the antenna cable properly.</li> <li>Connect an outdoor antenna.</li> </ul>	7 –
Hissing or continuous noise is heard when receiving AM programs.	<ul style="list-style-type: none"> <li>This may be noise from a TV or interference from a broadcast station.</li> </ul>	<ul style="list-style-type: none"> <li>Turn off the TV.</li> <li>Change the position and direction of the AM loop antenna.</li> </ul>	– 7

**[Internet radio/Music server/iPod/USB/memory device]**

Symptom	Cause	Countermeasure	Page
When a USB memory device is connected, "USB" is not displayed.	<ul style="list-style-type: none"> <li>The set cannot recognize a USB memory device.</li> <li>A USB memory device not conforming to mass storage class or MTP standards is connected.</li> <li>A USB memory device that the set cannot recognize is connected.</li> <li>USB memory device is connected via USB hub.</li> </ul>	<ul style="list-style-type: none"> <li>Check the connection.</li> </ul>	9
		<ul style="list-style-type: none"> <li>Connect a USB memory device conforming to mass storage class or MTP standards.</li> </ul>	-
		<ul style="list-style-type: none"> <li>This is not a malfunction. DENON does not guarantee that all USB memory devices will operate or receive power.</li> </ul>	-
		<ul style="list-style-type: none"> <li>Connect the USB memory device directly to the USB port.</li> </ul>	-
iPod cannot be played.	<ul style="list-style-type: none"> <li>Input source other than "iPod" or "USB" is selected.</li> <li>Cable is not properly connected.</li> </ul>	<ul style="list-style-type: none"> <li>Switch the INPUT to "iPod" or "USB".</li> </ul>	17
		<ul style="list-style-type: none"> <li>Reconnect.</li> </ul>	9
Files on a USB memory device cannot be played.	<ul style="list-style-type: none"> <li>USB memory device is in a format other than FAT16 or FAT32.</li> <li>USB memory device is divided into multiple partitions.</li> <li>Files are stored in a non-compatible format.</li> <li>You are attempting to play a file that is copyright protected.</li> </ul>	<ul style="list-style-type: none"> <li>Set the format to FAT16 or FAT32. For details, refer to the USB memory device's operating instructions.</li> </ul>	-
		<ul style="list-style-type: none"> <li>When divided into multiple partitions, only files stored in the top partition can be played.</li> </ul>	-
		<ul style="list-style-type: none"> <li>Record the files in a compatible format.</li> </ul>	44
		<ul style="list-style-type: none"> <li>Files that are copyright protected cannot be played on this set.</li> </ul>	44
Internet radio cannot be played.	<ul style="list-style-type: none"> <li>Ethernet cable is not properly connected or network is disconnected.</li> <li>Program is being broadcast in non-compatible format.</li> <li>The computer's or router's firewall is activated.</li> <li>Radio station is not currently broadcasting.</li> <li>IP address is wrong.</li> </ul>	<ul style="list-style-type: none"> <li>Check the connection status.</li> </ul>	8
		<ul style="list-style-type: none"> <li>Only Internet radio programs in MP3 and WMA can be played on this set.</li> </ul>	45
		<ul style="list-style-type: none"> <li>Check the computer's or router's firewall settings.</li> </ul>	-
		<ul style="list-style-type: none"> <li>Choose a radio station that is currently broadcasting.</li> </ul>	19
		<ul style="list-style-type: none"> <li>Check the set's IP address.</li> </ul>	27
Files stored on a computer cannot be played.	<ul style="list-style-type: none"> <li>Files are stored in a non-compatible format.</li> <li>You are attempting to play a file that is copyright protected.</li> <li>Set and computer are connected by USB cable.</li> </ul>	<ul style="list-style-type: none"> <li>Record in a compatible format.</li> </ul>	45
		<ul style="list-style-type: none"> <li>Files that are copyright protected cannot be played on this set.</li> </ul>	45
		<ul style="list-style-type: none"> <li>The set's USB port cannot be used for connection to a computer.</li> </ul>	-

Symptom	Cause	Countermeasure	Page
Server is not found, or it is not possible to connect to the server.	<ul style="list-style-type: none"> <li>The computer's or router's firewall is activated.</li> <li>Computer's power is not turned on.</li> <li>Server is not running.</li> <li>Set's IP address is wrong.</li> </ul>	<ul style="list-style-type: none"> <li>Check the computer's or router's firewall settings.</li> </ul>	-
		<ul style="list-style-type: none"> <li>Turn on the power.</li> </ul>	-
		<ul style="list-style-type: none"> <li>Launch the server.</li> <li>Check the set's IP address.</li> </ul>	27
Cannot connect to preset or favorite radio stations.	<ul style="list-style-type: none"> <li>Radio station is not currently broadcasting.</li> <li>Radio station is not currently in service.</li> </ul>	<ul style="list-style-type: none"> <li>Wait a while before trying again.</li> <li>It is not possible to connect to radio stations that are no longer in service.</li> </ul>	-
For some radio stations, "Server Full" or "Connection Down" is displayed and station cannot be connected to.	<ul style="list-style-type: none"> <li>Station is congested or not currently broadcasting.</li> </ul>	<ul style="list-style-type: none"> <li>Wait a while before trying again.</li> </ul>	-
Sound is broken during playback.	<ul style="list-style-type: none"> <li>Network's signal transfer speed is slow or communications lines or radio station is congested.</li> </ul>	<ul style="list-style-type: none"> <li>This is not a malfunction. When playing broadcast data with a high bit rate, the sound may be broken, depending on the communications conditions.</li> </ul>	-
Sound quality is poor or played sound is noisy.	<ul style="list-style-type: none"> <li>File being played has a low bit rate.</li> </ul>	<ul style="list-style-type: none"> <li>This is not a malfunction.</li> </ul>	-

**[Pandora]**

Symptom	Cause	Countermeasure	Page
Cannot login to Pandora. ("Email address" or "Password" is displayed.)	<ul style="list-style-type: none"> <li>Login information is incorrect.</li> </ul>	<ul style="list-style-type: none"> <li>Check if the "Email address" for Pandora has been properly entered. Re-enter the "Password". (Password is not displayed.)</li> </ul>	22
"Account is no longer active" is displayed.	<ul style="list-style-type: none"> <li>Your account is expired.</li> </ul>	<ul style="list-style-type: none"> <li>Obtain a new account.</li> <li>Contact Pandora Listener Support at <a href="mailto:pandora-support@pandora.com">pandora-support@pandora.com</a>.</li> </ul>	-
"Pandora is only available for use in United States" is displayed.	<ul style="list-style-type: none"> <li>You are trying to access from a country where Pandora is not available.</li> </ul>	<ul style="list-style-type: none"> <li>Pandora is not available in all countries. Please check <a href="http://blog.pandora.com/faq/">http://blog.pandora.com/faq/</a></li> </ul>	-
"Incorrect Email or Password" is displayed.	<ul style="list-style-type: none"> <li>You entered an incorrect account or password for the login authentication.</li> </ul>	<ul style="list-style-type: none"> <li>Enter them again.</li> </ul>	22
"No skips remaining" is displayed.	<ul style="list-style-type: none"> <li>You repeatedly performed the forward skip operation for tracks within the same station. No more forward skip operation is available.</li> </ul>	<ul style="list-style-type: none"> <li>Unfortunately, our music licenses force us to limit the amount of tracks you can skip in an hour.</li> </ul>	-
"100 Station Limit" is displayed.	<ul style="list-style-type: none"> <li>You have already registered 100 stations. You can not register a new station.</li> </ul>	<ul style="list-style-type: none"> <li>Reduce the number of stations to less than 100.</li> </ul>	-
"Please Try Again Later" is displayed.	<ul style="list-style-type: none"> <li>Pandora is performing system maintenance.</li> </ul>	<ul style="list-style-type: none"> <li>Please try again later.</li> </ul>	-

**[Rhapsody]**

Symptom	Cause	Countermeasure	Page
Cannot login to Rhapsody. ("Incorrect Username or Password" is displayed.)	<ul style="list-style-type: none"> <li>Login information is incorrect.</li> </ul>	<ul style="list-style-type: none"> <li>Check if the Username for Rhapsody has been properly entered. Re-enter the Password. (Password is not displayed.) <a href="http://www.rhapsody.com/denon">www.rhapsody.com/denon</a></li> </ul>	24

**[Napster]**

Symptom	Cause	Countermeasure	Page
Cannot login to Napster. ("Subscription required" is displayed.)	<ul style="list-style-type: none"> <li>Login authentication error.</li> <li>If a nonsubscriber user accesses it. Or when the listening limitation exceeds it.</li> </ul>	<ul style="list-style-type: none"> <li>Enter the correct username and password and retry login.</li> </ul>	-
Cannot login to Napster. ("Incorrect Username or Password" is displayed.)	<ul style="list-style-type: none"> <li>Incorrect username or password entered for login authentication.</li> </ul>	<ul style="list-style-type: none"> <li>Enter the correct username and password and retry login.</li> <li>Check if the Username for Napster has been properly entered. Re-enter the Password. (Password is not displayed.) <a href="http://www.napster.com/choose/index_default.html">http://www.napster.com/choose/index_default.html</a></li> </ul>	-

**[Wireless LAN]**

Symptom	Cause	Countermeasure	Page
Cannot connect to network.	<ul style="list-style-type: none"> <li>The settings of the SSID and network key (WEP) are incorrect.</li> <li>The reception is poor and the signals cannot be received.</li> </ul>	<ul style="list-style-type: none"> <li>Match the network settings with this unit settings.</li> <li>Shorten the distance from the wireless LAN's access point, remove any obstacles and otherwise improve visibility, then try reconnecting. Also install away from microwave ovens and the access points of other networks.</li> </ul>	31, 32
	<ul style="list-style-type: none"> <li>There are multiple networks and the usable channels overlap.</li> </ul>	<ul style="list-style-type: none"> <li>Set the access point's channel settings away from the channels used for other networks. Alternatively, connect using a network cable.</li> </ul>	-
Played sound is interrupted or sound cannot be played.	<ul style="list-style-type: none"> <li>The router power is off.</li> </ul>	<ul style="list-style-type: none"> <li>Turn on the router power.</li> </ul>	-
	<ul style="list-style-type: none"> <li>There are multiple networks and the usable channels overlap.</li> </ul>	<ul style="list-style-type: none"> <li>Set the access point's channel settings away from the channels used for other networks. Alternatively, connect using a network cable.</li> </ul>	-

# Specifications

## ❑ CD player

• <b>Audio performance</b>	
S/N ratio (1 kHz)	100 dB
Dynamic range (1 kHz)	100 dB
Total harmonic distortion (1 kHz)	0.01 %

## ❑ Audio AMP

<b>Rated output</b>	2-channel driving 65 W + 65 W (4 Ω/ohms, 1 kHz, T.H.D. 0.7 %) 80 W + 80 W (4 Ω/ohms)
<b>Dynamic power</b>	80 W + 80 W (4 Ω/ohms)
<b>High frequency distortion</b>	0.1 % (Rated output: -3 dB), 4 Ω/ohms, 1 kHz
<b>Input sensitivity/impedance</b>	
AUX1, AUX2	200 mV/32 kΩ
<b>Portable in</b>	110 mV/24 kΩ
<b>Frequency response (5 W, 8 Ω)</b>	
AUX input	5 Hz to 20 kHz (±3 dB)
<b>Total harmonic distortion (1 kHz, 5 W, 8 Ω)</b>	
AUX input	0.05 %
<b>S/N ratio (10 W, 8 Ω, IHF-A)</b>	
AUX input	86 dB

## ❑ Tuner

• <b>FM tuner</b>	
Range of receivable frequencies	87.5 to 107.9 MHz
S/N ratio (mono)	65 dB
Sensitivity (S/N 30 dB)	9 dBμV (IHF)
• <b>AM tuner</b>	
Range of receivable frequencies	530 to 1710 kHz
S/N ratio	40 dB
Sensitivity (S/N 20 dB)	55 dBμV/m

## ❑ Clock

<b>Clock method</b>	Within 1 – 2 minutes per month
---------------------	--------------------------------

## ❑ Wireless LAN

<b>Network type (wireless LAN standards)</b>	Conforming to IEEE 802.11b Conforming to IEEE 802.11g (Conforming to Wi-Fi®)*
<b>Transfer rate</b>	DS-SS: 11 / 5.5 / 2 / 1 Mbps (Automatic switching) OFDM: 54 / 48 / 36 / 24 / 18 / 12 / 9 / 6 Mbps (Automatic switching)
<b>Security</b>	SSID (Network name) WEP key (network key) (64/128 bits) WPA-PSK (TKIP/AES) WPA2-PSK (TKIP/AES)
<b>Used frequency range</b>	2,412 MHz – 2,462 MHz
<b>No. of channels</b>	Conforming to IEEE 802.11b : 11ch (DS-SS) (Of which 1 channel used) Conforming to IEEE 802.11g : 11ch (OFDM) (Of which 1 channel used)
❑ <b>Power supply</b>	
<b>Power supply voltage/frequency</b>	AC 120 V, 60 Hz
<b>Power consumption</b>	65 W
<b>Power consumption in standby mode</b>	0.3 W
❑ <b>Miscellaneous</b>	
<b>External dimensions</b>	280 (W) x 112 (H) x 299 (D) mm (11-1/32" x 4-13/32" x 11-49/64")
<b>Weight</b>	4.3 kg (9 lbs 7.7 oz)

- \* Wi-Fi® conformity indicates tested and proven interoperability by the "Wi-Fi Alliance", a group certifying interoperability among wireless LAN devices.
- For purposes of improvement, specifications and design are subject to change without notice.

# Index

## A

Accessories .....	2
AES .....	32, 46
AM loop antenna .....	7
Auto preset .....	16
Auto Standby .....	35

## B

BASS .....	12
Bit rate .....	43, 44, 45, 46
Browse mode .....	17

## C

Cable	
Audio cable .....	5, 6, 9, 10
Ethernet cable .....	8
Optical cable .....	6
Pin-plug cable .....	5
Speaker cable .....	5
Stereo pin-plug cable .....	6
Characters .....	31, 32, 36, 37
Connection	
Antenna .....	7
iPod .....	9
Network .....	8
Portable audio player .....	10
Power cord .....	10
Recording components .....	6
Speaker .....	5
TV .....	6
USB memory device .....	9
Current time .....	11, 29

## D

Display's brightness .....	13
DLNA .....	46

## F

Favorite list .....	26
Finalize .....	3, 46
Firmware update .....	35
FM indoor antenna .....	7
Friendly Name Edit .....	34
Front panel .....	38

## H

Headphones .....	13
------------------	----

## I

IEEE 802.11b .....	46
IEEE 802.11g .....	46
Input source .....	12
Inputting characters .....	36
Internet radio .....	19

## M

Menu map .....	27
MP3 .....	15, 44, 45, 46
MPEG .....	46
MPEG-4 AAC .....	44
Music server .....	20
Mute .....	12

## N

Napster .....	21
Network Names (SSID) .....	46
Network Standby .....	34

## P

Pandora .....	22
Party mode .....	33
PC Language .....	34
Playback	
AUX .....	25
CD .....	13
Files .....	15
FM/AM broadcasts .....	16
Internet radio .....	19
iPod .....	17
Napster .....	21
Network audio .....	19, 45
Portable audio player .....	25
Program .....	14
Random .....	14
Repeat .....	14
USB memory device .....	18, 44
Protection circuit .....	6, 46

## R

Rear panel .....	39
Remote control .....	4, 40, 41, 42
Batteries .....	4
Remote mode .....	17
Resetting the microprocessor .....	37
Rhapsody .....	24, 45

## S

Sampling frequency .....	43, 44, 45, 46
Screen saver .....	35
SDB .....	12
Setting	
Clock .....	29
Network .....	30, 31, 32
Other .....	35
Timer .....	28
Sleep timer .....	13
Speaker impedance .....	5, 46
Speaker optimize .....	35
Subwoofer .....	5

## T

Timer .....	28
TKIP .....	46
Tone .....	12
Top panel .....	39
TREBLE .....	12

## V

Volume .....	12
vTuner .....	45, 46

## W

WEP Key .....	32, 46
Wi-Fi .....	46
Windows Media DRM .....	45, 46
Windows Media Player Ver. 11 .....	20, 46
WMA .....	15, 44, 45, 46
WPA .....	32, 47
WPA2 .....	32, 47
WPA-PSK/WPA2-PSK .....	32, 47
WPS .....	31, 47





**DENON**

[www.denon.com](http://www.denon.com)

D&M Holdings Inc.  
Printed in China 5411 10541 008D

## Free Manuals Download Website

<http://myh66.com>

<http://usermanuals.us>

<http://www.somanuals.com>

<http://www.4manuals.cc>

<http://www.manual-lib.com>

<http://www.404manual.com>

<http://www.luxmanual.com>

<http://aubethermostatmanual.com>

Golf course search by state

<http://golfingnear.com>

Email search by domain

<http://emailbydomain.com>

Auto manuals search

<http://auto.somanuals.com>

TV manuals search

<http://tv.somanuals.com>