

16" Variable Speed Scroll Saw with Quickset II[®] Blade Changing Feature (Model 40-540)



PART NO. 900087-0010
Copyright © 2000 Delta Machinery



To learn more about DELTA MACHINERY
visit our website at: www.deltamachinery.com.

For Parts, Service, Warranty or other Assistance,

please call **1-888-848-5175** (In Canada call **1-800-463-3582**).

Download from www.Somanuals.com. All Manuals Search And Download.

ESPAÑOL: PÁGINA 17

SAFETY RULES

Woodworking can be dangerous if safe and proper operating procedures are not followed. As with all machinery, there are certain hazards involved with the operation of the product. Using the machine with respect and caution will considerably lessen the possibility of personal injury. However, if normal safety precautions are overlooked or ignored, personal injury to the operator may result. Safety equipment such as guards, push sticks, hold-downs, featherboards, goggles, dust masks and hearing protection can reduce your potential for injury. But even the best guard won't make up for poor judgment, carelessness or inattention. Always use common sense and exercise caution in the workshop. If a procedure feels dangerous, don't try it. Figure out an alternative procedure that feels safer. **REMEMBER:** Your personal safety is your responsibility.

This machine was designed for certain applications only. Delta Machinery strongly recommends that this machine not be modified and/or used for any application other than that for which it was designed. If you have any questions relative to a particular application, **DO NOT** use the machine until you have first contacted Delta to determine if it can or should be performed on the product.

TECHNICAL SERVICE MANAGER
DELTA MACHINERY
4825 HIGHWAY 45 NORTH
JACKSON, TN 38305
(IN CANADA: 505 SOUTHGATE DRIVE, GUELPH, ONTARIO N1H 6M7)

⚠ WARNING: FAILURE TO FOLLOW THESE RULES MAY RESULT IN SERIOUS PERSONAL INJURY

- 1. FOR YOUR OWN SAFETY, READ INSTRUCTION MANUAL BEFORE OPERATING THE TOOL.** Learn the tool's application and limitations as well as the specific hazards peculiar to it.
- 2. KEEP GUARDS IN PLACE** and in working order.
- 3. ALWAYS WEAR EYE PROTECTION.**
- 4. GROUND ALL TOOLS.** If tool is equipped with three-prong plug, it should be plugged into a three-hole electrical receptacle. If an adapter is used to accommodate a two-prong receptacle, the adapter lug must be attached to a known ground. Never remove the third prong.
- 5. REMOVE ADJUSTING KEYS AND WRENCHES.** Form habit of checking to see that keys and adjusting wrenches are removed from tool before turning it "on."
- 6. KEEP WORK AREA CLEAN.** Cluttered areas and benches invite accidents.
- 7. DON'T USE IN DANGEROUS ENVIRONMENT.** Don't use power tools in damp or wet locations, or expose them to rain. Keep work area well-lighted.
- 8. KEEP CHILDREN AND VISITORS AWAY.** All children and visitors should be kept a safe distance from work area.
- 9. MAKE WORKSHOP CHILDPROOF** - with padlocks, master switches, or by removing starter keys.
- 10. DON'T FORCE TOOL.** It will do the job better and be safer at the rate for which it was designed.
- 11. USE RIGHT TOOL.** Don't force tool or attachment to do a job for which it was not designed.
- 12. WEAR PROPER APPAREL.** No loose clothing, gloves, neckties, rings, bracelets, or other jewelry to get caught in moving parts. Nonslip footwear is recommended. Wear protective hair covering to contain long hair.
- 13. ALWAYS USE SAFETY GLASSES.** Wear safety glasses (must comply with ANSI Z87.1). Everyday eyeglasses only have impact resistant lenses; they are not safety glasses. Also use face or dust mask if cutting operation is dusty.
- 14. SECURE WORK.** Use clamps or a vise to hold work when practical. It's safer than using your hand and frees both hands to operate tool.
- 15. DON'T OVERREACH.** Keep proper footing and balance at all times.
- 16. MAINTAIN TOOLS IN TOP CONDITION.** Keep tools sharp and clean for best and safest performance. Follow instructions for lubricating and changing accessories.
- 17. DISCONNECT TOOLS** before servicing and when changing accessories such as blades, bits, cutters, etc.
- 18. USE RECOMMENDED ACCESSORIES.** The use of improper accessories may cause hazards or risk of injury to persons.
- 19. REDUCE THE RISK OF UNINTENTIONAL STARTING.** Make sure switch is in "OFF" position before plugging in power cord.
- 20. NEVER STAND ON TOOL.** Serious injury could occur if the tool is tipped or if the cutting tool is accidentally contacted.
- 21. CHECK DAMAGED PARTS.** Before further use of the tool, a guard or other part that is damaged should be carefully checked to ensure that it will operate properly and perform its intended function - check for alignment of moving parts, binding of moving parts, breakage of parts, mounting, and any other conditions that may affect its operation. A guard or other part that is damaged should be properly repaired or replaced.
- 22. DIRECTION OF FEED.** Feed work into a blade or cutter against the direction of rotation of the blade or cutter only.
- 23. NEVER LEAVE TOOL RUNNING UNATTENDED. TURN POWER OFF.** Don't leave tool until it comes to a complete stop.
- 24. DRUGS, ALCOHOL, MEDICATION.** Do not operate tool while under the influence of drugs, alcohol or any medication.
- 25. MAKE SURE TOOL IS DISCONNECTED FROM POWER SUPPLY** while motor is being mounted, connected or reconnected.
- 26. WARNING:** The dust generated by certain woods and wood products can be injurious to your health. Always operate machinery in well ventilated areas and provide for proper dust removal. Use wood dust collection systems whenever possible.
- 26. WARNING: SOME DUST CREATED BY POWER SANDING, SAWING, GRINDING, DRILLING, AND OTHER CONSTRUCTION ACTIVITIES** contains chemicals known to cause cancer, birth defects or other

reproductive harm. Some examples of these chemicals are:

- lead from lead-based paints,
- crystalline silica from bricks and cement and other masonry products, and
- arsenic and chromium from chemically-treated lumber.

Your risk from these exposures varies, depending on how often you do this type of work. To reduce your exposure to these chemicals: work in a well ventilated area, and work with approved safety equipment, such as those dust masks that are specially designed to filter out microscopic particles.

ADDITIONAL SAFETY RULES FOR SCROLL SAWS

1. **DO NOT OPERATE** your scroll saw until it is completely assembled and installed according to the instructions.
2. **IF YOU ARE NOT** thoroughly familiar with the operation of Scroll Saws, obtain advice from your supervisor, instructor or other qualified person.
3. **YOUR SCROLL SAW MUST** be securely fastened to a stand or workbench. If there is any tendency for the stand or workbench to move during operation, the stand or workbench **MUST** be fastened to the floor.
4. **THIS SCROLL SAW** is intended for indoor use only.
5. **MAKE SURE** blade is properly tensioned before operating saw.
6. **TO AVOID** blade breakage **ALWAYS** adjust blade tension correctly.
7. **MAKE SURE** the blade teeth point downward toward the table.
8. **NEVER** turn the saw "ON" before clearing the table of all objects (tools, scraps of wood, etc.).
9. **DO NOT** cut material that is too small to be safely supported.
10. **AVOID** awkward hand positions where a sudden slip could cause a hand to move into the blade.
11. **ALWAYS** keep hands and fingers away from blade.
12. **ALWAYS** adjust holddown foot for each new operation.
13. **DO NOT USE** dull or bent blades.
14. **DO NOT** attempt to saw material that does not have a flat surface, unless a suitable support is used.
15. **MAKE** "relief" cuts before cutting long curves
16. **NEVER** attempt to cut a curve that is too tight for the blade being used.
17. **WHEN** backing a blade out of a workpiece, the blade may bind in the saw kerf. This is usually caused by sawdust in the kerf. If this happens, turn "OFF" the switch and remove plug from power source outlet. Wedge open the kerf and back blade out of the workpiece.
18. **THE USE** of attachments and accessories not recommended by Delta may result in the risk of injuries.
19. **ALWAYS** hold the work firmly against the table.
20. **DO NOT** feed the material too fast while cutting. Only feed the material fast enough so that the blade will cut.
21. **NEVER** start the Scroll Saw with the stock pressed against the blade.
22. **WHEN** cutting a large workpiece **MAKE SURE** the material is supported at table height.
23. **USE CAUTION** when cutting material which is irregular in cross section which could pinch the blade before the cut is completed. A piece of moulding for example must lay flat on the table and not be permitted to rock while being cut.
24. **USE CAUTION** when cutting round material such as dowel rods or tubing. They have a tendency to roll while being cut causing the blade to "bite." Use a V-block to control the piece.
25. **ALWAYS** release blade tension before removing the blade from the upper or lower blade holders.
26. **MAKE CERTAIN** table tilting lock is tightened before starting the machine.
27. **NEVER** reach under the table while the machine is running.
28. **NEVER** perform layout, assembly or set-up work on the table while the saw is operating.
29. **ALWAYS STOP** the saw before removing scrap pieces from the table.
30. **WHEN THE TOOL IS NOT IN USE**, the switch should be locked in the "OFF" position to prevent unauthorized use.
31. **SHOULD** any part of your Scroll Saw be missing, damaged or fail in any way, or any electrical component fail to perform properly, shut off switch and remove plug from power supply outlet. Replace missing, damaged or failed parts before resuming operation.
32. **ADDITIONAL INFORMATION** regarding the safe and proper operation of this product is available from the National Safety Council, 1121 Spring Lake Drive, Itasca, IL 60143-3201, in the Accident Prevention Manual for Industrial Operations and also in the Safety Data Sheets provided by the NSC. Please also refer to the American National Standards Institute ANSI 01.1 Safety Requirements for Woodworking Machinery and the U.S. Department of Labor OSHA 1910.213 Regulations.
33. **SAVE THESE INSTRUCTIONS.** Refer to them often and use them to instruct others.

UNPACKING AND CLEANING

Your new scroll saw is shipped complete in one carton; carefully unpack the saw and all loose items. Remove the protective coating from the saw table surface. This coating may be removed with a soft cloth moistened with kerosene (do not use acetone, gasoline or lacquer thinner for this purpose). After cleaning, cover the table surface with a good quality paste wax. Buff out the wax thoroughly to prevent it from rubbing into your workpieces.

ASSEMBLY INSTRUCTIONS

The table and table locking handle are furnished disassembled from the scroll saw to prevent damage during shipment.

1. To assemble the table (A) Fig. 2, to the machine, find the two special screws (B) and two locknuts (C).

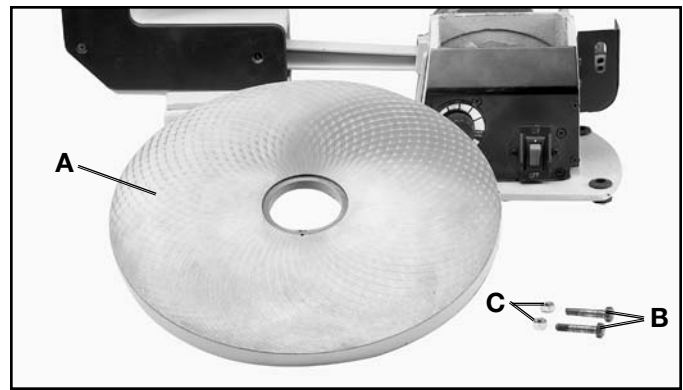

Fig. 2

2. Position table (A) Fig. 3, on the machine as shown. Align the two holes in the table trunnions (O) with the two holes in the base (P) of the machine and fasten the table (A) to the base (P) using the two special screws (B) and locknuts (C) as shown. NOTE: Before tightening the special screws (B) and nuts (C) make sure the angle of tilt scale (D) Fig. 4, is positioned inside pointer (E) as shown. Also, do not completely tighten the special screws (B) and nuts (C) Fig. 3. Table must be able to tilt freely.

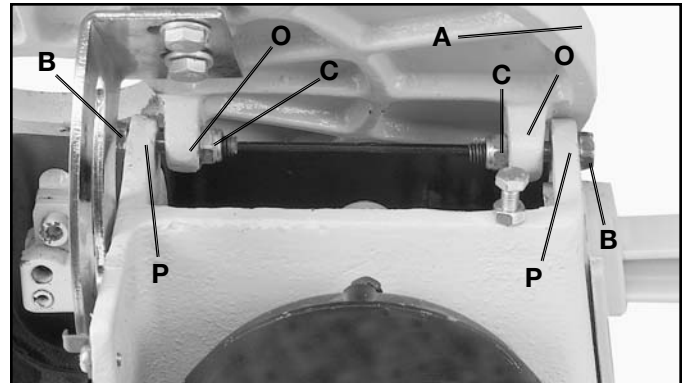

Fig. 3

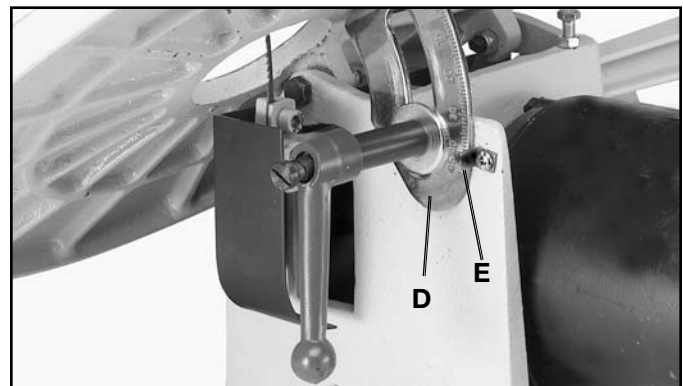

Fig. 4

3. To facilitate assembly of table lock knob assembly, remove screw and spring (F) Fig. 5, and handle (G) from stud (H). Place washer (J) on threaded end of stud (H).

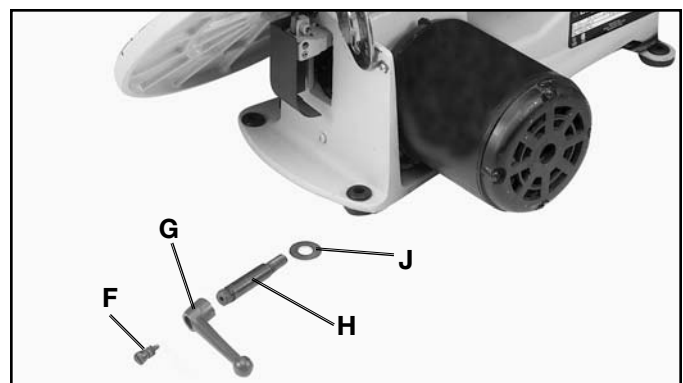

Fig. 5

4. Screw threaded end of stud (H) Fig. 6, with flat washer (J) through slot in angle of tilt scale (D) and into tapped hole (K).

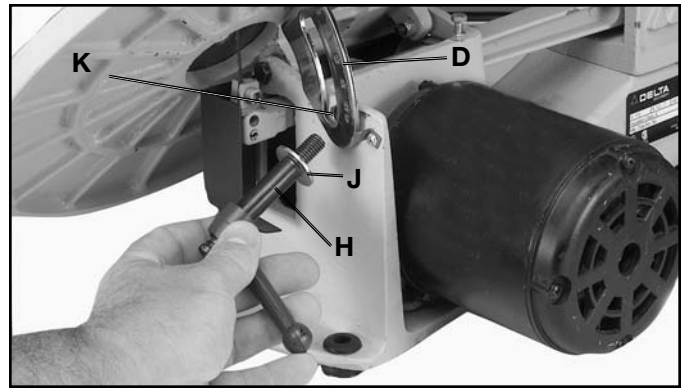

Fig. 6

5. Reassemble handle (G) Fig. 7, and screw and spring (F) which were removed in STEP 3, onto stud (H). Move table (A) to the horizontal position and lock table (A), by turning handle (G) clockwise.

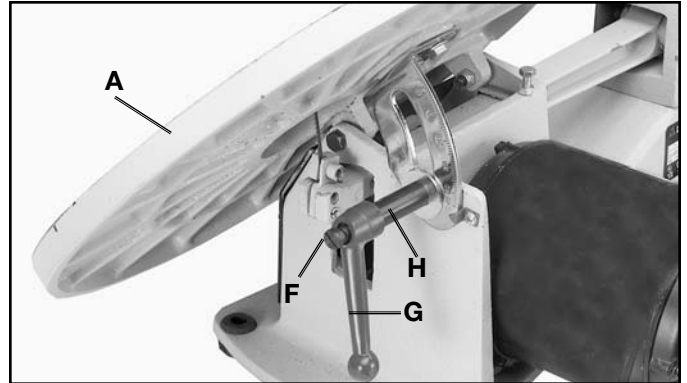

Fig. 7

6. Using the wrench (L) Fig. 8, supplied, loosen the two screws on bottom of bracket (M) that fasten bracket to rod (N).

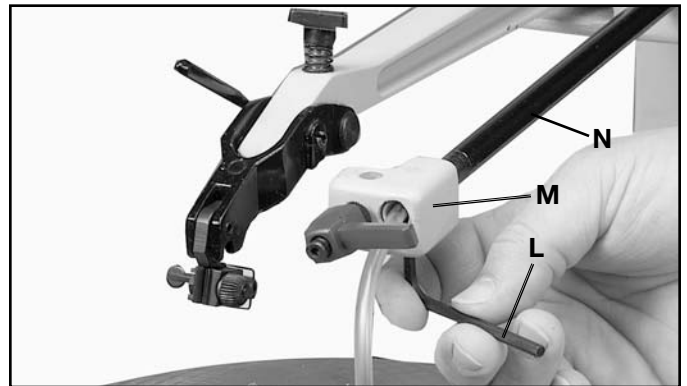

Fig. 8

7. Rotate bracket (M), to the position shown in Fig. 9. Loosen lock handle (R) and insert holddown rod (S) into hole in bracket (M), as shown.

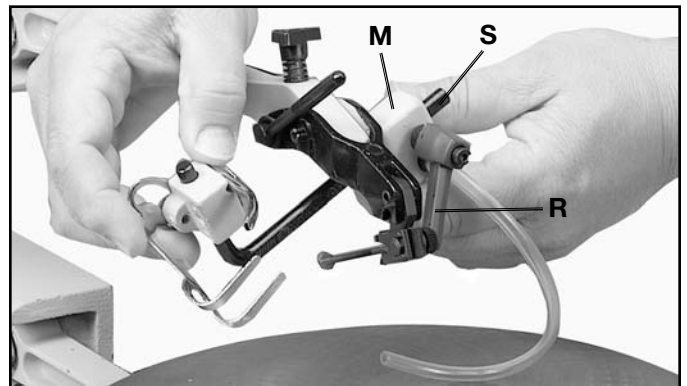

Fig. 9

8. Rotate bracket (M) Fig. 10, back to its original position as shown, and tighten the two screws that fasten bracket (M) to rod (N). These screws were loosened in **STEP 6**. Then tighten lockhandle (R) to hold rod (S) in position.

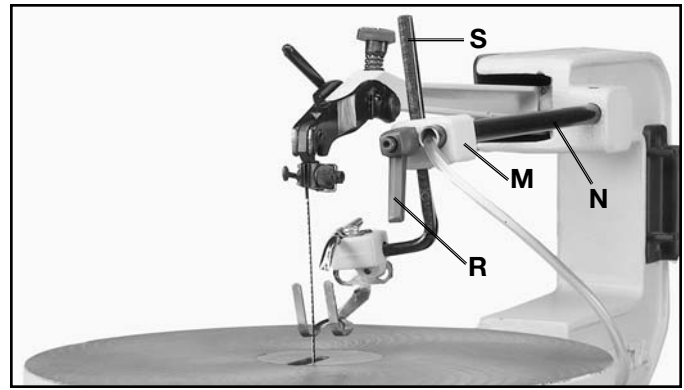

Fig. 10

9. Slide end of chip blower tube (T) Fig. 11, onto end of air nozzle (V), as shown.

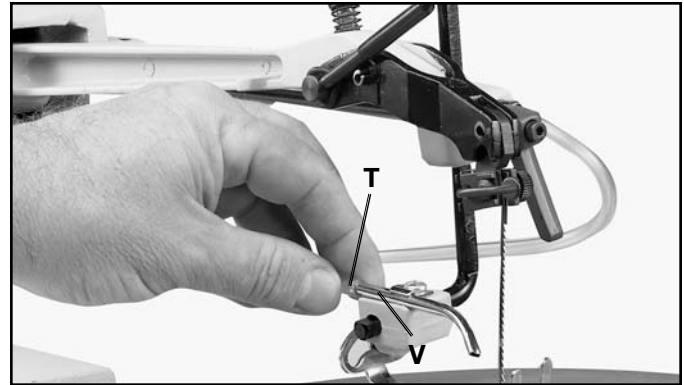

Fig. 11

10. Assemble tool holder (X) Fig. 12, to the right side of the scroll saw using two screws (W).



Fig. 12

11. The tool holder(X) Fig. 13, is used to hold the quick-set blade changing wrench (Y), (for removing blade from lower blade holder), allen wrench and extra blades.

12. Refer to sections "**CHANGING BLADES**" and "**ADJUSTING BLADE TENSION**" for assembling blade and applying correct tension on the saw blade.

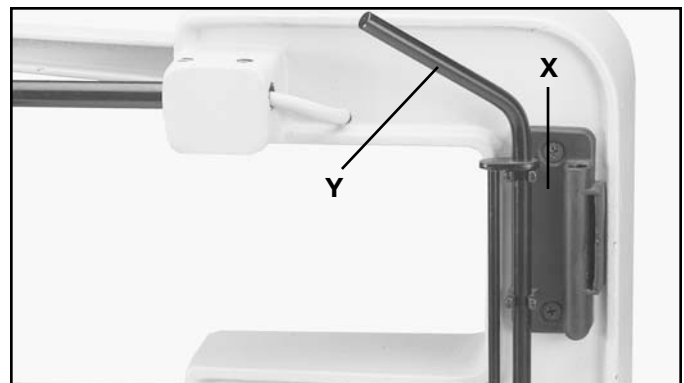

Fig. 13

CONNECTING SCROLL SAW TO POWER SOURCE

POWER CONNECTIONS

A separate electrical circuit should be used for your tools. This circuit should not be less than #12 wire and should be protected with a 20 Amp fuse. Have a certified electrician replace or repair a worn cord immediately. Before connecting the motor to a power line, make sure the switch is in the "OFF" position and be sure that the electric current is of the same characteristics as stamped on the motor name-plate. Running on low voltage will damage the motor.

⚠️WARNING: DO NOT EXPOSE THE TOOL TO RAIN OR OPERATE THE TOOL IN DAMP LOCATIONS.

MOTOR SPECIFICATIONS

Your scroll saw is wired for 110-120 volt, 60 HZ current. Before connecting the saw to the power source, make sure the switch is in the "OFF" position.

EXTENSION CORDS

Use proper extension cords. Make sure your extension cord is in good condition and is a 3-wire extension cord which has a 3-prong grounding type plug and a 3-pole receptacle which will accept the tools plug. When using an extension cord, be sure to use one heavy enough to carry the current of the scroll saw. An undersized cord will cause a drop in line voltage, resulting in loss and overheating. Fig. 14 shows the correct gage to use depending on the cord length. If in doubt, use the next heavier gage. The smaller the gage number, the heavier the cord.

GROUNDING INSTRUCTIONS

⚠️WARNING: THIS TOOL MUST BE GROUNDED WHILE IN USE TO PROTECT THE OPERATOR FROM ELECTRIC SHOCK.

In the event of a malfunction or breakdown, grounding provides a path of least resistance for electric current to reduce the risk of electric shock. This tool is equipped with an electric cord having an equipment-grounding conductor and a grounding plug. The plug must be plugged into a matching outlet that is properly installed and grounded in accordance with all local codes and ordinances.

Do not modify the plug provided - if it will not fit the outlet, have the proper outlet installed by a qualified electrician.

Improper connection of the equipment-grounding conductor can result in risk of electric shock. The conductor with insulation having an outer surface that is green with or without yellow stripes is the equipment-grounding conductor. If repair or replacement of the electric cord or plug is necessary, do not connect the equipment grounding conductor to a live terminal.

Check with a qualified electrician or service personnel if the grounding instructions are not completely understood, or if in doubt as to whether the tool is properly grounded. Use only 3-wire extension cords that have 3-prong grounding type plugs and 3-hole receptacles that accept the tool's plug, as shown in Fig. 15.

Repair or replace damaged or worn cord immediately.

MINIMUM GAUGE EXTENSION CORD			
Ampere Rating	Volts	Total Length of Cord in Feet	Gage of Extension Cord
0-6	120	up to 25	18 AWG
0-6	120	25-50	16 AWG
0-6	120	50-100	16 AWG
0-6	120	100-150	14 AWG
6-10	120	up to 25	18 AWG
6-10	120	25-50	16 AWG
6-10	120	50-100	14 AWG
6-10	120	100-150	12 AWG
10-12	120	up to 25	16 AWG
10-12	120	25-50	16 AWG
10-12	120	50-100	14 AWG
10-12	120	100-150	12 AWG
12-16	120	up to 25	14 AWG
12-16	120	25-50	12 AWG
12-16	120	GREATER THAN 50' NOT RECOMMENDED	
0-6	240	up to 50	18 AWG
0-6	240	50-100	16 AWG
0-6	240	100-200	16 AWG
0-6	240	200-300	14 AWG
6-10	240	up to 50	18 AWG
6-10	240	50-100	16 AWG
6-10	240	100-200	14 AWG
6-10	240	200-300	12 AWG
10-12	240	up to 50	16 AWG
10-12	240	50-100	16 AWG
10-12	240	100-200	14 AWG
10-12	240	200-300	12 AWG
12-16	240	up to 50	14 AWG
12-16	240	50-100	12 AWG
12-16	240	GREATER THAN 100' NOT RECOMMENDED	

Fig. 14

This tool is intended for use on a circuit that has an outlet and a plug that looks like the one shown in Fig. 15. A temporary adapter, which looks like the adapter illustrated in Fig. 16, may be used to connect this plug to a 2-pole receptacle, as shown in Fig. 16, if a properly grounded outlet is not available. The temporary adapter should be used only until a properly grounded outlet can be installed by a qualified electrician. **THIS ADAPTER IS NOT APPLICABLE IN CANADA.** The green-colored rigid ear, lug, and the like, extending from the adapter must be connected to a permanent ground, such as a properly grounded outlet box, as shown in Fig. 16.

⚠ WARNING: IN ALL CASES, MAKE CERTAIN THE RECEPTACLE IN QUESTION IS PROPERLY GROUNDED. IF YOU ARE NOT SURE, HAVE A CERTIFIED ELECTRICIAN CHECK THE RECEPTACLE.

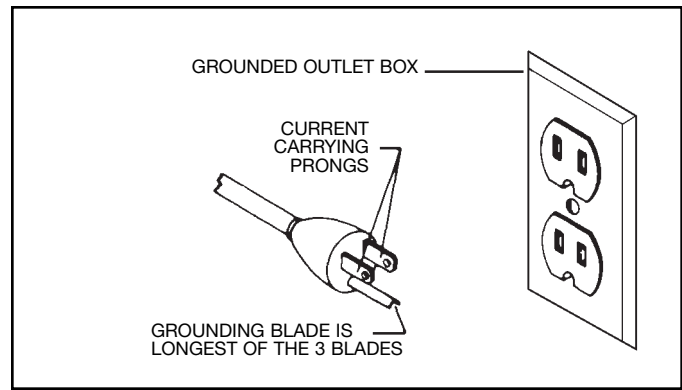

Fig. 15

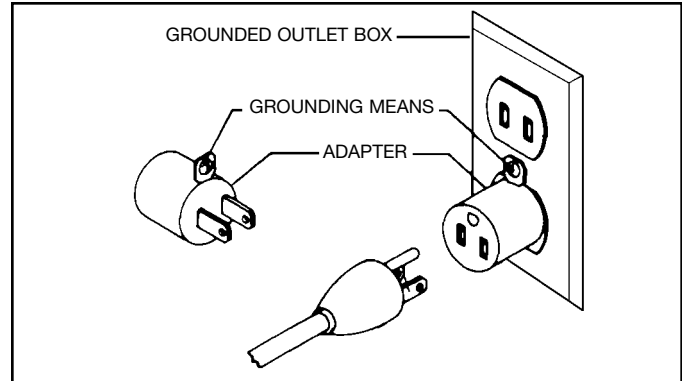

Fig. 16

FASTENING SCROLL SAW TO SUPPORTING SURFACE

Your scroll saw **MUST** be securely fastened to a stand or workbench using the holes in the four rubber feet, three of which are shown at (A) Fig. 17. **IMPORTANT:** When mounting the saw to a stand or workbench **DO NOT** over-tighten mounting bolts. Leave some cushion in the four rubber feet (A) for absorbing noise and vibration.

An alternate method of securing the scroll saw to a supporting surface is to C-clamp the front and side ledge of the saw base to a workbench.

IMPORTANT: If there is any tendency for the stand or workbench to move during operation, the stand or workbench must be fastened to the floor.



Fig. 17

ON-OFF AND VARIABLE SPEED SWITCHES

The on-off switch (A) Fig. 18, and variable speed switch (B) is located on the left side of the scroll saw base, as shown. To turn the saw "ON," push the top portion of switch (A) and to turn the saw "OFF", push the bottom portion of the switch (A).

This scroll saw is supplied with variable speeds of 400 to 1800 strokes per minute. When the variable speed switch (B) Fig. 18, is rotated all the way to the left (counterclock-wise) the speed will be 400 strokes per minute. To increase the strokes per minute, rotate switch (B) to the right (clock-wise) until the desired speed is obtained. When the switch (B) is rotated all the way to the right (clockwise) the speed will be 1800 strokes per minute.

LOCKING ON-OFF SWITCH IN THE "OFF" POSITION

IMPORTANT: When the tool is not in use, the switch should be locked in the off position using a padlock (C), as shown in Fig. 19. This padlock is available as an an accessory, Model 50-325 padlock.

TABLE INSERT

The table insert (A) can be assembled to the saw table with the opening in the insert pointing to the front of the table, as shown in Fig. 20, or to the right as shown in Fig. 21.

With the table in the level position, 90 degrees to the blade, the insert (A) should be positioned, as shown in Fig. 20. This allows for the blade to be pivoted forward after it is unclamped from the top blade holder, enabling you to quickly insert the blade into the next hole in a pattern when doing inside-cutting, as you will see later in this manual.

When tilting the table for bevel cutting operations the insert (A) should be positioned as shown in Fig. 21. This allows for clearance of the blade when tilting the table.

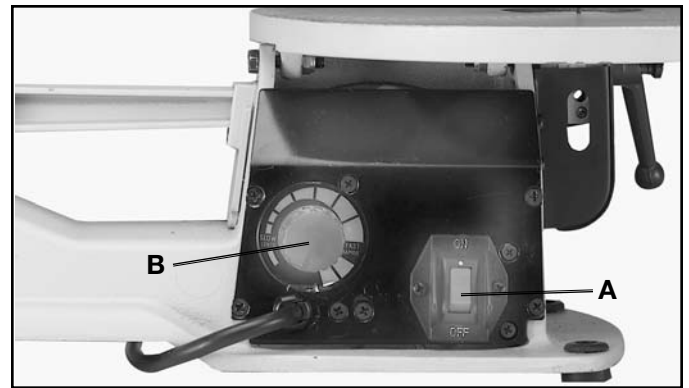

Fig. 18

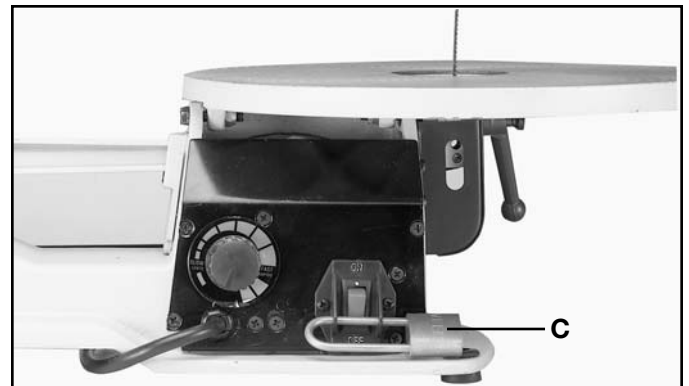

Fig. 19

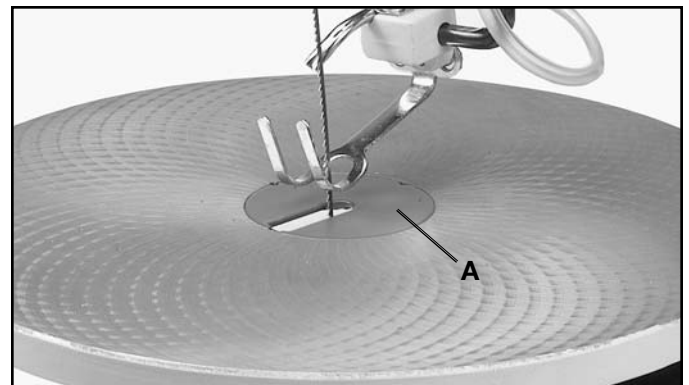

Fig. 20

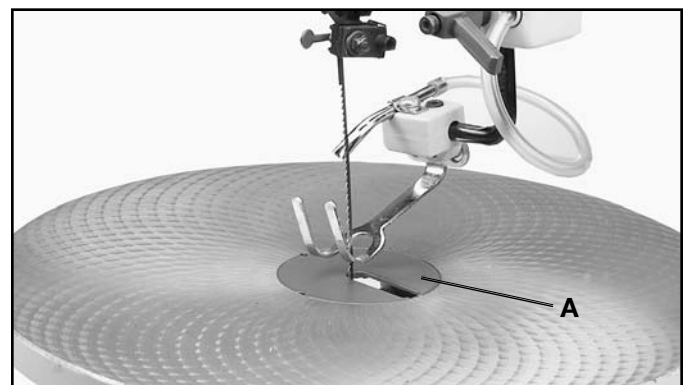

Fig. 21

A table insert blank (B) Fig. 22, is supplied as standard equipment with your scroll saw and can be used when cutting very small workpieces to give added support to the bottom of the workpiece. Simply cut a slot into the blank and replace the standard insert (A) with the blank (B). The slot cut into the blank (B) will only be as wide as the blade giving maximum support to the bottom of the workpiece.

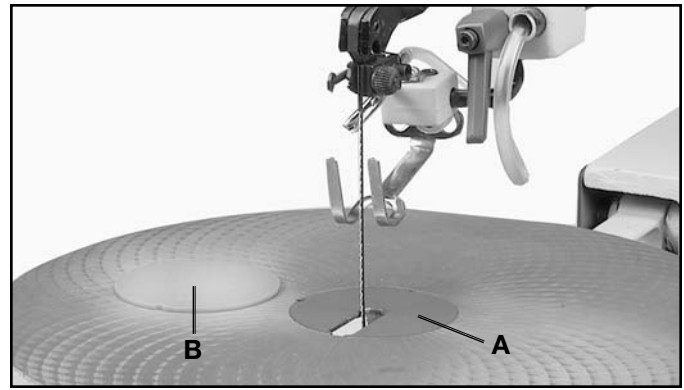

Fig. 22

CHANGING BLADES

1. **⚠️ WARNING: TO AVOID INJURY FROM ACCIDENTAL STARTING ALWAYS TURN SWITCH "OFF" AND REMOVE POWER CORD PLUG FROM ELECTRICAL OUTLET BEFORE REMOVING OR REPLACING BLADE.**

2. Remove table insert (A) Fig. 23, and release blade tension by pulling tension lever (B) forward, as shown.

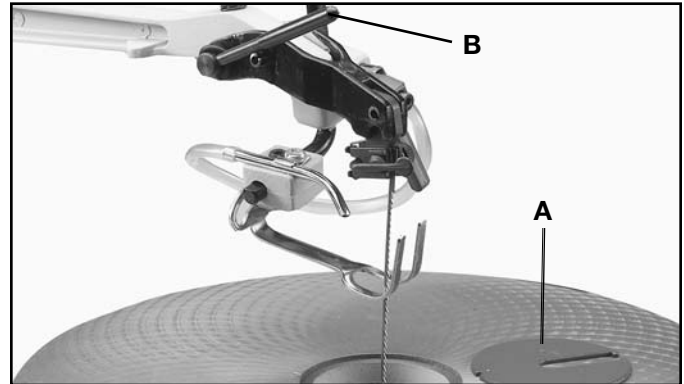

Fig. 23

3. Push chuck locking lever (C) Fig. 24, to the rear as shown. This will automatically release the blade (D) from the upper chuck (E).

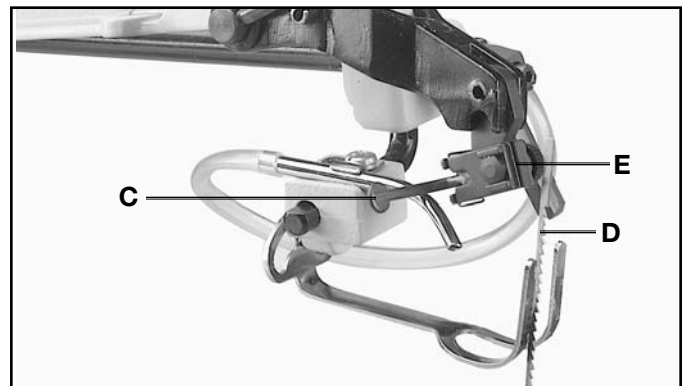

Fig. 24

4. Insert long end (F) Fig. 25, of quickset blade changing wrench into hole (G) in lower blade holder. This will auto-matically align wrench (H) with blade holder screw (J).

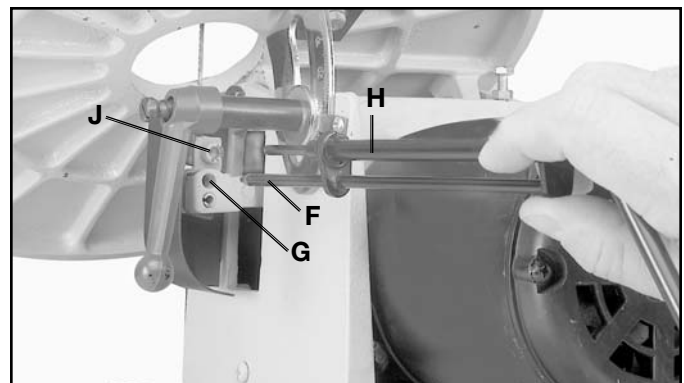

Fig. 25

5. Fig. 26 illustrates the quickset blade changing wrench (K) engaged with the lower blade holder assembly. Turn wrench counterclockwise to loosen screw (J) Figs. 26 and 27, and remove blade from lower chuck, as shown in Fig. 27.

6. Insert new blade into the lower and upper blade holders in the same manner, making certain the blade teeth are pointing down toward the table.

7. Apply blade tension by referring to the following section "**ADJUSTING BLADE TENSION.**"

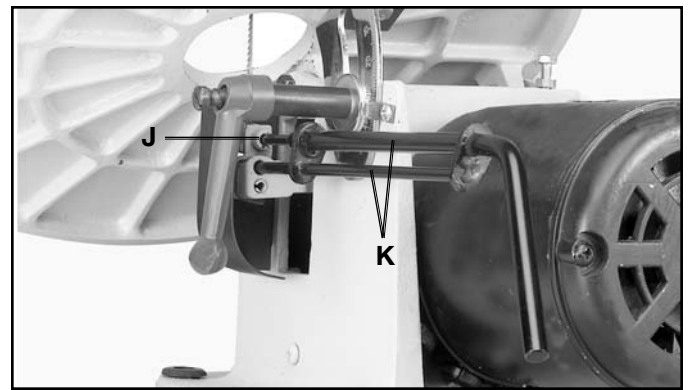

Fig. 26

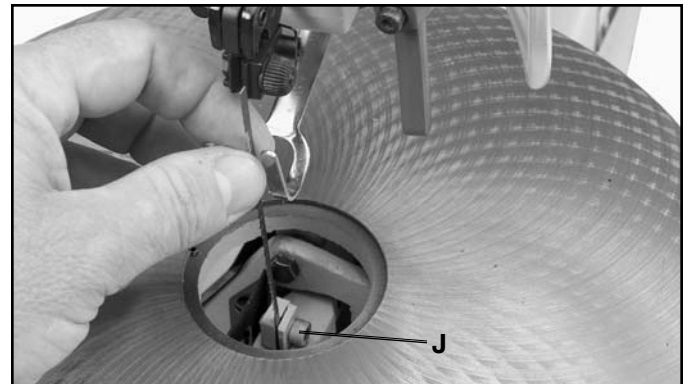

Fig. 27

ADJUSTING BLADE TENSION

Tension is applied to the blade when the blade tension lever (A) Fig. 28, is in the rear position, as shown. When the lever (A) is moved forward, as shown in Fig. 29, blade tension is released.

To increase blade tension, turn knob (B) Fig. 29, clockwise and to decrease blade tension, turn knob (B) counter-clockwise. When adjusting blade tension, lever (A) should be in the forward position, as shown in Fig. 29. **NOTE:** It is necessary to adjust the blade tension knob (B) only when the blade is removed from both upper and lower blade holders and a new or different type of blade is assembled to the holders. It is not necessary to adjust blade tension when the blade is removed and replaced in only the upper blade holder as in performing inside cutting operations.

Adjusting the blade for proper tension is usually accomplished by trial and error; however, a good method to use is to pluck the rear of the blade, like a guitar string, after the tension lever (A) Fig. 29, is moved to the rear. A high-pitched tone of the blade should be heard and this usually indicates proper tension. Finer blades require more tensioning (a higher pitched sound) while thicker blades require less tension.



Fig. 28

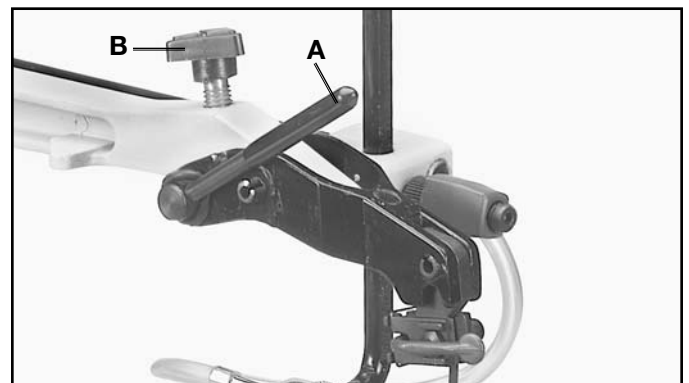

Fig. 29

ADJUSTING CLAMPING ACTION OF UPPER BLADE HOLDER

Different widths of scroll saw blades will make it necessary to adjust the clamping action of the upper blade holder. It should be noted, however, that very little adjustment is necessary and very little clamping force is required to hold the blade satisfactorily.

1. Move the chuck locking lever (A) Fig. 30, to the rear (open) position, as shown.
2. Turn locknut (C) Fig. 30, clockwise to tighten and counterclockwise to loosen the clamping action of the blade holder. Very little movement of locknut (C) will be necessary.

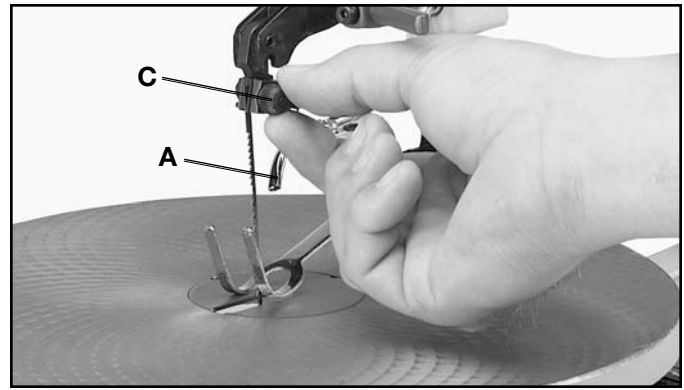

Fig. 30

TILTING THE TABLE

The table on your scroll saw can be tilted 45 degrees to the left for bevel cutting operations by loosening table lock handle (A) Fig. 31, tilt the table to the desired angle and tighten lock handle (A).

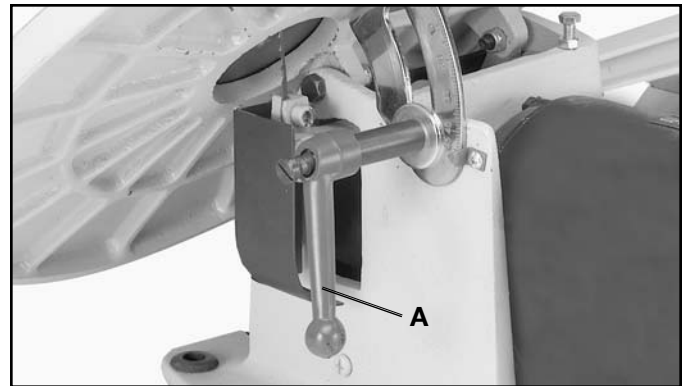

Fig. 31

When bevel cutting, the holddown (B) Fig. 32, can be adjusted to lay flat on the stock by loosening screw (C) and tilting the holddown (B) accordingly. Then tighten screw (C).

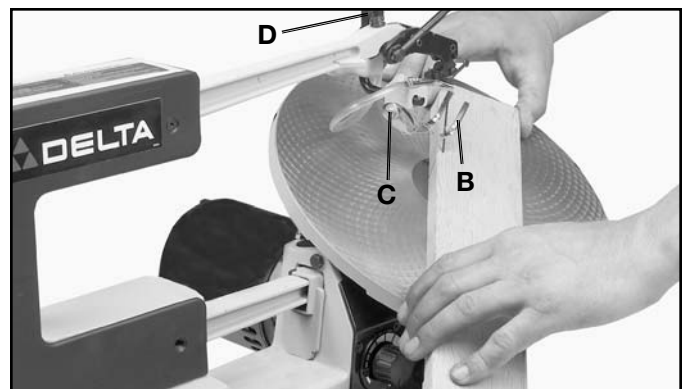

Fig. 32

LEVELING THE TABLE

1. Loosen table lock handle way to the right and move the table all the way to the right.
2. Using a square (A) Fig. 33, check to see if the table is 90 degrees to the saw blade, as shown.

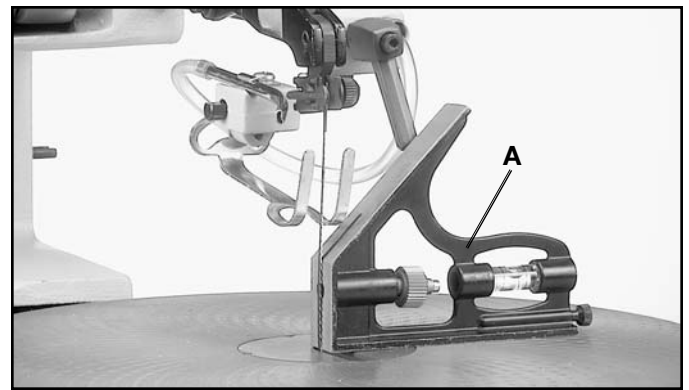

Fig. 33

3. If the table is not at 90 degrees to the blade, adjust the table accordingly making certain screw (B) Fig. 34, contacts bottom of table surface when table is 90 degrees to the blade. Screw (B) can be adjusted by loosening nut (C), thread screw (B) in or out the desired distance and tighten nut (C).

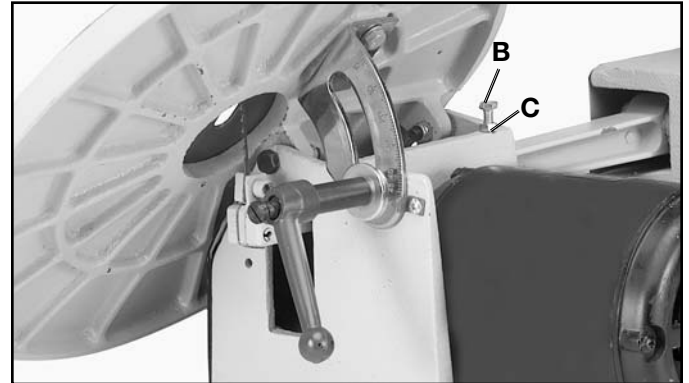

Fig. 34

ADJUSTING HOLDDOWN

The holddown (A) Fig. 35, should be adjusted so it contacts the top surface of the work being cut by loosening lock handle (B) and moving holddown rod (C) up or down. Then tighten lock handle (B).

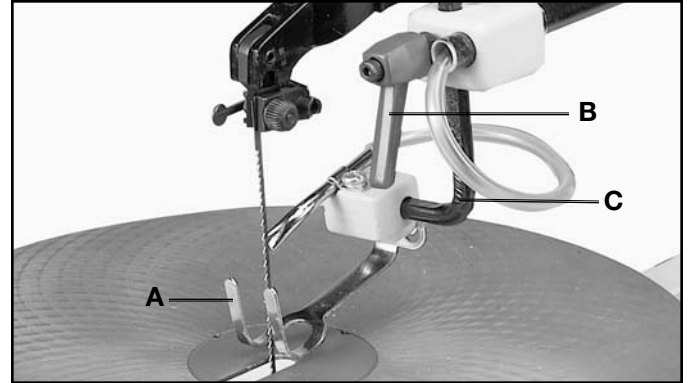

Fig. 35

ADJUSTING DUST BLOWER

The dust blower (A) Fig. 36, may be moved to direct air to the most effective point on the cutting line by loosening screw (B), adjust nozzle (A) accordingly and tighten screw (B).

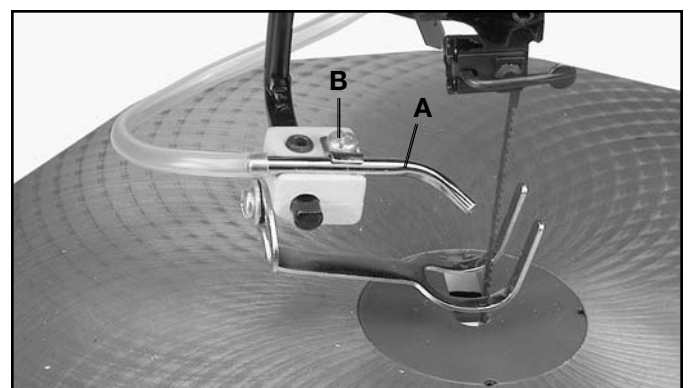

Fig. 36

FOLLOWING A LINE

With your scroll saw you should be able to cut a straight or curved line with ease. Most beginners will experience blade wandering; however, they eventually learn to control it as they become more familiar with the machine. Use scrap material to practice cuts before starting a project. This enables you to develop your own way of cutting and you will find out what you can and cannot do with your saw.

Always hold the work firmly against the table and do not feed the workpiece too fast while cutting. Feed the workpiece only fast enough so that the blade will cut. Scroll saws cut faster across the grain than they do with the grain. Allow for this tendency when cutting patterns that shift rather quickly from with-the-grain cuts to cross-grain cuts.

Make "relief" cuts before cutting long curves and never attempt to cut a curve that is too tight for the blade being used.

INSIDE CUTTING

Inside cutting is where the blade must be threaded through a hole in the workpiece. The Delta 16" Scroll Saw has the capability of performing this operation quickly and easily as follows:

Let's assume you are performing an inside cutting operation on a project, similar to the one shown in Fig. 37, that has numerous inside cuts to be made. This can be accomplished quickly with the Delta saw. In Fig. 37, the operator has just completed one of the inside cuts and must move to the next hole.

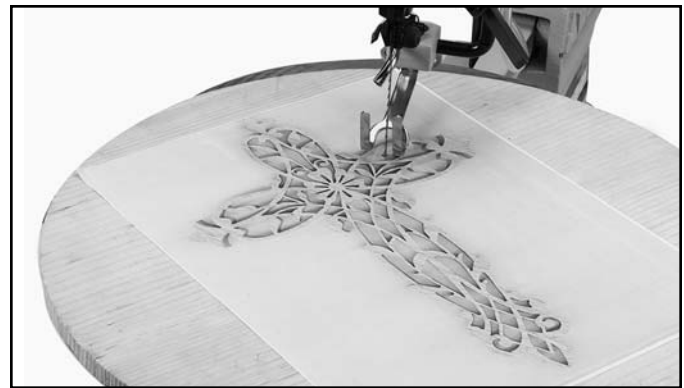

Fig. 37

Loosen lock handle (A) Fig. 38, and raise the spring holddown (B). Release blade tension by moving tension lever (C) forward and loosen upper blade holder by moving lever (D) to the rear as shown. This will release the blade (E). Insert the blade (E) into the next hole in the pattern, as shown.

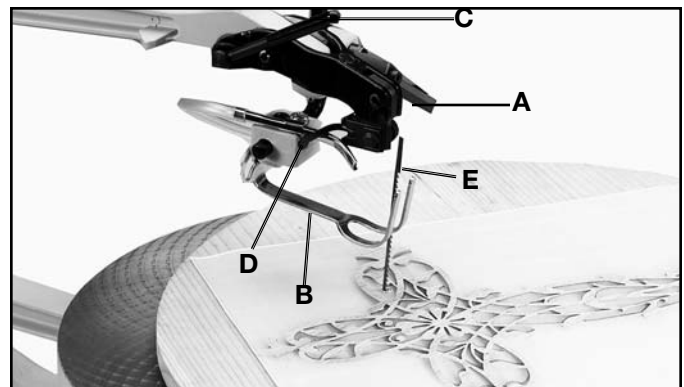

Fig. 38

Reassemble blade (E) Fig. 39, back into the upper blade holder and tighten blade by moving lever (D) forward. Move tension lever (C) to the rear and lower spring holddown (B). You are ready to make the next inside cut.

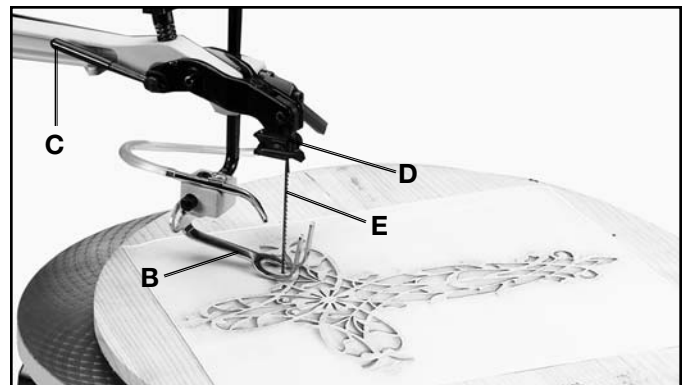

Fig. 39

LUBRICATION

To keep the scroll saw operating at peak efficiency, we recommend that a simple maintenance procedure be performed after approximately each 20 hours of use. Proceed as follows:

1. MAKE CERTAIN THE MACHINE IS DISCONNECTED FROM THE POWER SOURCE.

2. Remove four screws (A) Fig. 40, and remove side panel (B) from the scroll saw.
3. Release blade tension by pulling tension lever (C) Fig. 41, forward as shown.
4. Lubricate the shafts of two special screws (D) Fig. 42, with a few drops of light machine oil in the areas where they pass through the connecting link (E). **NOTE: DO NOT REMOVE SPECIAL SCREWS TO LUBRICATE.**
5. Remove two pivot bolts (F) Fig. 43.
6. Thoroughly clean grease from shafts (G) Fig. 43, of both pivot bolts (F) and lubricate shafts (G) with a few drops of light machine oil.
7. Reassemble two pivot bolts (F) Fig. 43, to machine.
8. Replace side panel removed in STEP 2 and reapply tension to the blade.

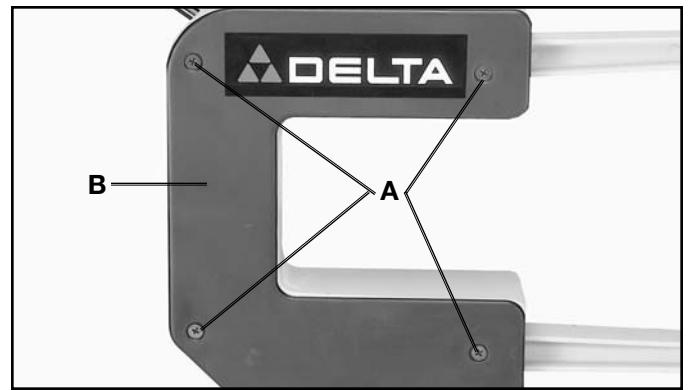

Fig. 40

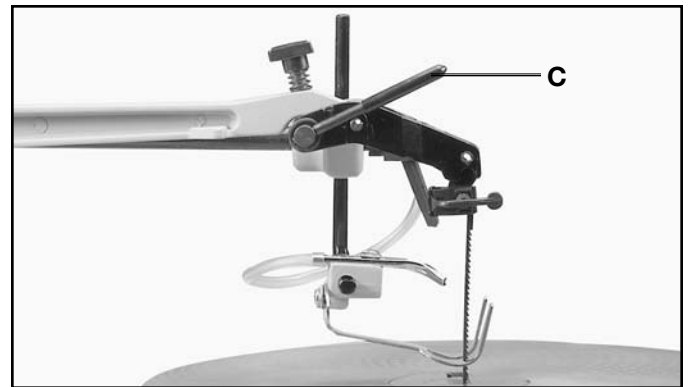

Fig. 41

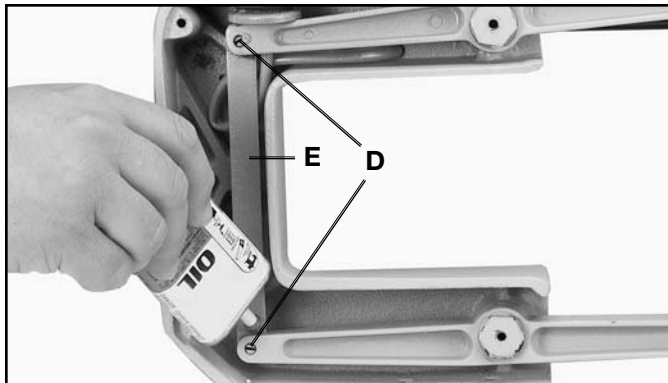

Fig. 42

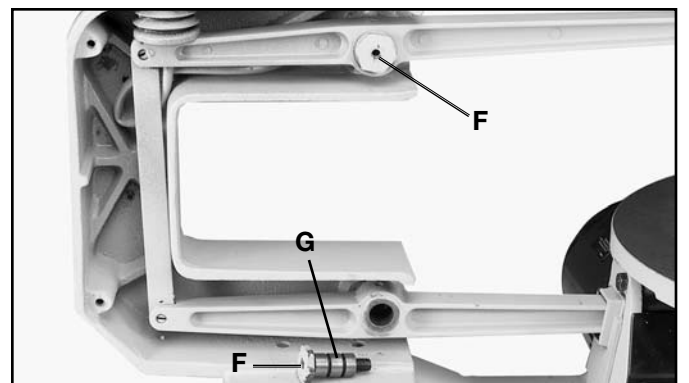

Fig. 43

CHOICE OF BLADE AND SPEED

Your scroll saw will accept a wide variety of 5" flat end blades and can be operated at any speed from 400 to 1800 cutting strokes per minute. Consider the following as a general guideline for selecting a blade and operating speed.

1. Use a finer blade for cutting thin workpieces, for hard materials, or when a smoother cut is required.
2. Use a coarser blade for cutting thick workpieces, when making straight cuts or for medium to soft materials.
3. Use a blade that will have 2 teeth in the workpiece at all times.
4. Most blade packaging is marked with the size of the wood the blade is intended to cut and the minimum radius which can be cut with that blade.
5. Slower speeds are generally more effective than faster speeds when using thin blades and making intricate cuts.
6. Always start at a slow speed and gradually increase the speed until the optimum cutting speed is obtained.

BLADE BREAKAGE

Blade breakage is usually caused by one or more of the following:

1. Bending the blade during installation.
2. Improper blade tension.
3. Improper blade selection for the work being cut.
4. Forcing the work into the blade too rapidly.
5. Cutting too sharp a turn for the blade being used.
6. Improper blade speed.



All Delta Machines and accessories are manufactured to high quality standards and are serviced by a network of Porter-Cable•Delta Factory Service Centers and Delta Authorized Service Stations. To obtain additional information regarding your Delta quality product or to obtain parts, service, warranty assistance, or the location of the nearest service outlet, please call 1-888-848-5175, (In Canada call 1-800-463-3582).



Delta Building Trades and Home Shop Machinery Two Year Limited Warranty

Delta will repair or replace, at its expense and at its option, any Delta machine, machine part, or machine accessory which in normal use has proven to be defective in workmanship or material, provided that the customer returns the product prepaid to a Delta factory service center or authorized service station with proof of purchase of the product within two years and provides Delta with reasonable opportunity to verify the alleged defect by inspection. Delta may require that electric motors be returned prepaid to a motor manufacturer's authorized station for inspection and repair or replacement. Delta will not be responsible for any asserted defect which has resulted from normal wear, misuse, abuse or repair or alteration made or specifically authorized by anyone other than an authorized Delta Service facility or representative. Under no circumstances will Delta be liable for incidental or consequential damages resulting from defective products. This warranty is Delta's sole warranty and sets forth the customer's exclusive remedy, with respect to defective products; all other warranties, express or implied, whether of merchantability, fitness for purpose, or otherwise, are expressly disclaimed by Delta.

Free Manuals Download Website

<http://myh66.com>

<http://usermanuals.us>

<http://www.somanuals.com>

<http://www.4manuals.cc>

<http://www.manual-lib.com>

<http://www.404manual.com>

<http://www.luxmanual.com>

<http://aubethermostatmanual.com>

Golf course search by state

<http://golfingnear.com>

Email search by domain

<http://emailbydomain.com>

Auto manuals search

<http://auto.somanuals.com>

TV manuals search

<http://tv.somanuals.com>