

VFDB Series Braking Modules Instruction Sheet

1 Preface

Thank you for choosing DELTA's braking module. VFDB braking units are applied to absorb the motor regeneration energy when the three-phase induction motor stops by deceleration. With VFDB braking unit, the regeneration energy will be dissipated in dedicated braking resistors. To prevent mechanical or human injury, please refer to this instruction sheet before wiring. VFDB braking units are suitable for DELTA AC Motor Drives VFD Series 230V/460V/575V. VFDB braking units need to be used in conjunction with BR series braking resistors to provide the optimum braking characteristics. VFDB braking units (2015, 2022, 4030, 4045 and 5055) are approved by Underwriters Laboratories, Inc. (UL) and Canadian Underwriters Laboratories (CUL). The content of this instruction sheet may be revised without prior notice. Please consult our distributors or download the most updated version at <http://www.delta.com.tw/industrialautomation>.

2 Specifications

VFDB Braking Units

Specification	230V Series		460V Series		575V Series	
	2015	2022	4030	4045	5055	
Model VFDB-	2015	2022	4030	4045	5055	
Max. Motor Capacity (KW)	15	22	30	45	55	
Output Rating	Max. Discharge Current (A) 10%ED	40	60	40	60	60
	Continuous Discharge Current (A)	15	20	15	18	20
	Braking Start-up Voltage (DC)	330/345/360/380/400/415±3V	660/690/720/760/800/830±6V	950±8V		
Input Rating	DC Voltage	200-400VDC	400-800VDC	607-1000VDC		
	Min. Equivalent Resistor for Each Braking Unit	10Ω	6.8Ω	20Ω	13.6Ω	15.8Ω
Protection	Heat Sink Overheat	Temperature over +95°C (203°F)				
	Alarm Output	Relay contact 5A120VAC/28VDC (RA, RB, RC)				
	Power Charge Display	Blackout until bus (→) voltage is below 50VDC				
Environment	Installation Location	Indoor (no corrosive gases, metallic dust)				
	Operating Temperature	-10°C ~ +50°C (-14°F to 122°F)				
	Storage Temperature	-20°C ~ +60°C (-4°F to 140°F)				
	Humidity	90% Non-condensing				
Mechanical Configuration	Vibration	9.8m/s ² (1G) under 20Hz 2m/s ² (0.2G) at 20-50Hz				
		Wall-mounted enclosed type IP50				

Braking Resistors

Model no.	Specification
BR1K5W005	1500W 5.0Ω
BR1K2W6P8	1200W 6.8Ω
BR1K2W008	1200W 8.0Ω
BR1K5W040	1500W 40Ω
BR1K0W050	1000W 50Ω
BR1K0W075	1000W 75Ω

3 Dimensions

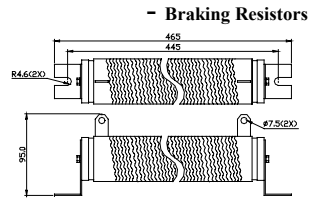

3 Dimensions - VFDB Braking Units

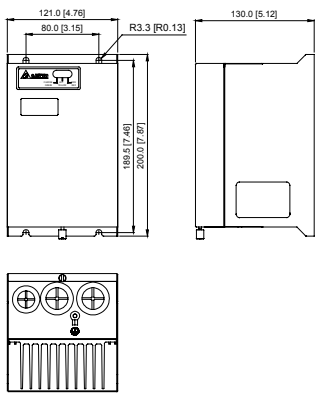

Terminal Wire Gauge

Circuit	Terminal Mark	Wire Gauge AWG (mm ²)	Screw	Torque
Power Input Circuit	+(P), -(N)	10-12AWG (3.5-5.5mm ²)	M4	18 kgf-cm (15.6 in-lbf)
Braking Resistor	B1, B2	10-12AWG (3.5-5.5mm ²)	M4	18 kgf-cm (15.6 in-lbf)
SLAVE Circuit	Output M1, M2	20-18AWG (0.25-0.75mm ²) (with shielded wires)	M2	4 kgf-cm (3 in-lbf)
Fault Circuit	RA, RB, RC	20-18AWG (0.25-0.75mm ²)	M2	4 kgf-cm (3 in-lbf)

5 Basic Wiring Diagram

Operation Explanation:

- For safety consideration, install an overload relay between the braking unit and the braking resistor. In conjunction with the magnetic contactor (MC) prior to the drive, it can perform complete protection against abnormality.
- The purpose of installing the thermal overload relay is to protect the braking resistor from damage due to frequent braking, or due to braking unit keeping operating resulted from unusual high input voltage. Under such circumstance, just turn off the power to prevent damaging the braking resistor.
- Please refer to the specification of the thermal overload relay.
- The alarm output terminals (RC, RA, RB) of the braking unit will be activated when the temperature of the heat sink exceeds 95°C. It means that the temperature of the installation environment may exceed 50°C, or the braking %ED may exceed 10%ED. With this kind of alarm, please install a fan to force air-cooling or reduce the environment temperature. If the condition not due to the temperature, the control circuit or the temperature sensor may have been damaged. At this time, please send the braking unit back to the manufacturer or agency for repair.

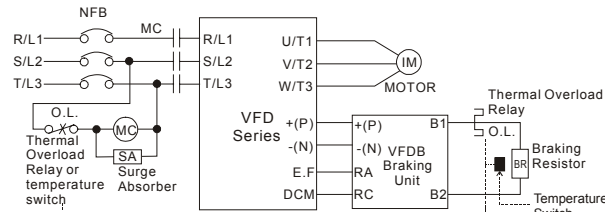

Note1: When using the AC drive with DC reactor, please refer to wiring diagram in the AC drive user manual for the wiring of terminal +(P) of Braking unit.
Note2: Do NOT wire terminal -(N) to the neutral point of power system.

6 Wiring Notice

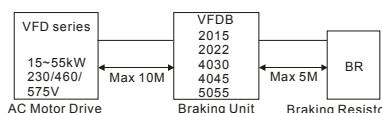
- Do not proceed with wiring while power is applied to the circuit.
 - The wiring gauge and distance must comply with the electrical code.
 - The +(P), -(N) terminals of the AC motor drive (VFD Series), connected to the braking unit (VFDB), must be confirmed for correct polarity lest the drive and the braking unit be damaged when power on.
 - When the braking unit performs braking, the wires connected to +(P), -(N), B1 and B2 would generate a powerful electromagnetic field for a moment due to high current passing through. These wires should be wired separately from other low voltage control circuits lest they make interference or mis-operation.
 - Inflammable solids, gases or liquids must be avoided at the location where the braking resistor is installed. The braking resistor had better be installed in individual metallic box with forced air-cooling.
 - Connect the ground terminal to the Earth Ground. The ground lead must be at least the same gauge wire as leads +(P), -(N).
 - Please install the braking resistor with forced air-cooling or the equivalent when frequent deceleration braking is performed (over 10%ED).
 - The ring terminals are suggested to be used for main circuit wiring. Make sure the terminals are fastened before power on.
- Wiring distance**
- 
- Wiring distance diagram showing VFD series connected to VFDB Braking Unit (2015, 2022, 4030, 4045, 5055) and Braking Resistor (BR). Max 10M distance between VFD and VFDB, and Max 5M distance between VFDB and BR.
- To prevent personal injury, do not connect/disconnect wires or regulate the setting of the braking unit while power on. Do not touch the terminals of related wiring and any component on PCB lest users be damaged by extreme dangerous DC high voltage.

7 Definition for Braking Usage ED%

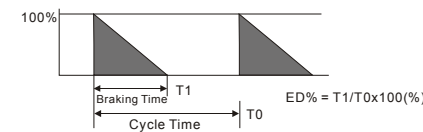

Explanation: The definition of the braking usage ED(%) is for assurance of enough time for the braking unit and braking resistor to dissipate away heat generated by braking. When the braking resistor heats up, the resistance would increase with temperature, and braking torque would decrease accordingly.

8 The Voltage Settings

1. Regulation of power voltage: the power source of the braking unit is DC voltage from +(P), -(N) terminals of the AC motor drive. It is very important to set the power voltage of the braking unit based on the input power of the AC motor drive before operation. The setting has a great influence on the potential of the operation voltage for the braking unit. Please refer to the table below.

Table 1: The Selection of Power Voltage and Operation Potential of PN DC Voltage

230V Model AC Power Voltage	Braking Start-up voltage DC Bus (+(P), -(N)) Voltage	460V Model AC Power Voltage	Braking Start-up voltage DC Bus (+(P), -(N)) Voltage	575V Model AC Power Voltage	Braking Start-up voltage DC Bus (+(P), -(N)) Voltage
190Vac	330Vdc	380Vac	660Vdc	575Vac	950Vdc
200Vac	345Vdc	400Vac	690Vdc	-	-
210Vac	360Vdc	415Vac	720Vdc	-	-
220Vac	380Vdc	440Vac	760Vdc	-	-
230Vac	400Vdc	460Vac	800Vdc	-	-
240Vac	415Vdc	480Vac	830Vdc	-	-

NOTE: Input Power With Tolerance ±10%

Input voltage setting for VFDB-2015/2022/4030/4045

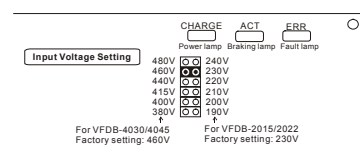

Input voltage setting for VFDB-5055

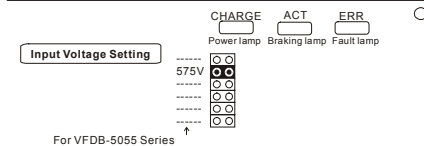

The SLAVE braking application of three braking units is shown as the above diagram. After wiring, the jumper of first unit shall be set as "MASTER" and that of others must be set as "SLAVE" to complete the system installation.

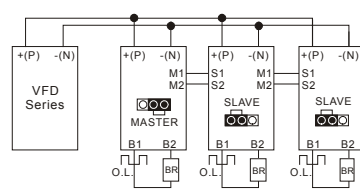

The position of the jumper

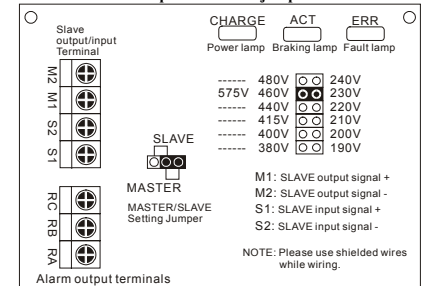

M1: SLAVE output signal +
M2: SLAVE output signal -
S1: SLAVE input signal +
S2: SLAVE input signal -
NOTE: Please use shielded wires while wiring.

Alarm output terminals

9 All Braking Resistors & Braking Units Use in the AC Drives

Voltage	Applicable Motor		Full-load Torque kg-M	Resistor Value Spec for Each AC Motor Drive	Braking Unit Model VFD No. of Units Used	Braking Resistors Model and No. of Units Used	Braking Torque 10%ED	Min. Equivalent Resistor Value for Each AC Motor Drive	Typical Thermal Overload Relay Value		
	HP	kW									
230V	20	15	8.248	3000W 10Ω	2015	1	BR1K5W005	2	125	10Ω	30
	25	18.5	10.281	4800W 8Ω	2022	1	BR1K2W008	4	125	8Ω	35
	30	22	12.338	4800W 6.8Ω	2022	1	BR1K2W6P8	4	125	6.8Ω	40
	40	30	16.497	6000W 5Ω	2015	2	BR1K5W005	4	125	5Ω	30
	50	37	20.6	9600W 4Ω	2015	2	BR1K2W008	8	125	4Ω	30
460V	20	15	8.248	1500W 40Ω	4030	1	BR1K5W040	1	125	40Ω	15
	25	18.5	10.281	4800W 32Ω	4030	1	BR1K2W008	4	125	32Ω	15
	30	22	12.338	4800W 27.2Ω	4030	1	BR1K2W6P8	4	125	27.2Ω	20
	40	30	16.497	6000W 20Ω	4030	1	BR1K5W005	4	125	20Ω	30
	50	37	20.6	9600W 16Ω	4045	1	BR1K2W008	8	125	16Ω	40
575V	60	45	24.745	9600W 13.6Ω	4045	1	BR1K2W6P8	8	125	13.6Ω	50
	75	55	31.11	12000W 10Ω	4030	2	BR1K5W005	8	125	10Ω	30
	100	75	42.7	19200W 6.8Ω	4045	2	BR1K2W6P8	16	125	6.8Ω	50
	20	15	8.248	3000W 60Ω	5055	1	BR1K0W020	3	125	60Ω	15
	25	18.5	10.281	4000W 50Ω	5055	1	BR1K0W050	4	125	50Ω	15
575V	30	22	12.338	6000W 40Ω	5055	1	BR1K2W008	5	125	40Ω	20
	40	30	16.497	6000W 34Ω	5055	1	BR1K2W6P8	5	125	34Ω	25
	50	37	20.6	7500W 25Ω	5055	1	BR1K5W005	5	125	25Ω	30
	60	45	24.745	12000W 20Ω	5055	1	BR1K2W008	10	125	20Ω	35
	75	55	31.11	12000W 17Ω	5055	1	BR1K2W6P8	10	125	17Ω	45
100	75	42.7	15000W 12.5Ω	5055	2	BR1K5W005	10	125	12.5Ω	45	

10 Wiring Examples of Braking Resistors

NOTE: Before wiring, please notice equivalent resistors value shown in the column "Equivalent resistors specification for each braking unit" in the above table to prevent damage.

230V 20HP

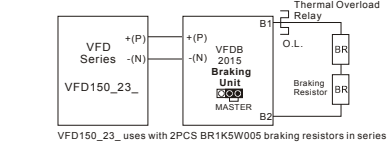

230V 25HP/30HP

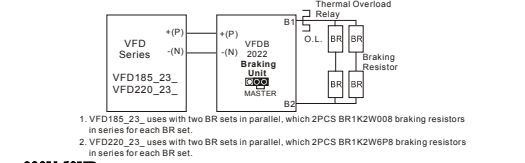

230V 40HP

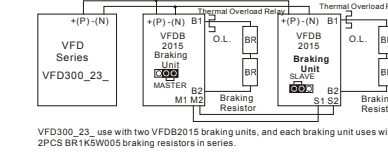

230V 50HP

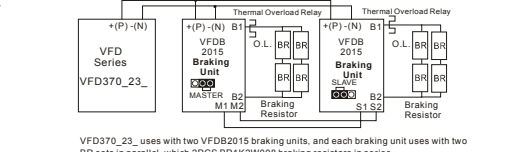

460V 20HP

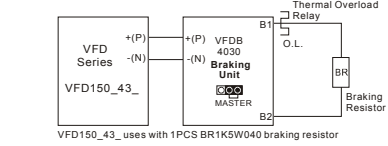

460V 25HP/30HP/40HP

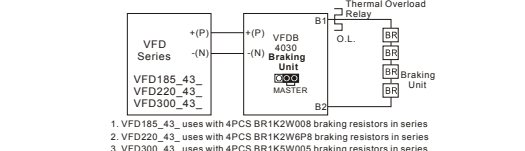

460V 50HP/60HP

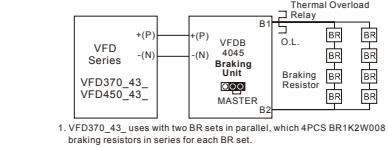

460V 75HP

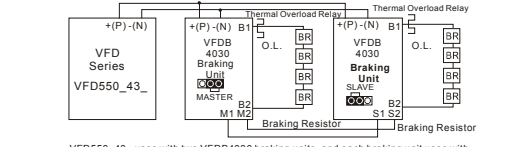

460V 100HP

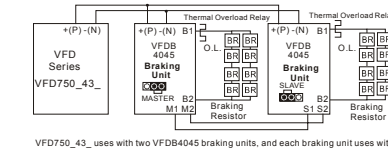

575V 20HP

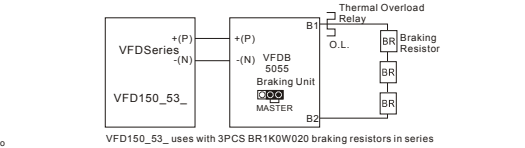

575V 25HP

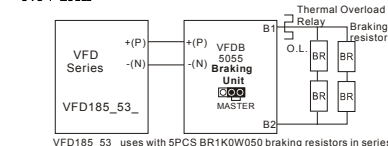

575V 30HP/40HP/50HP

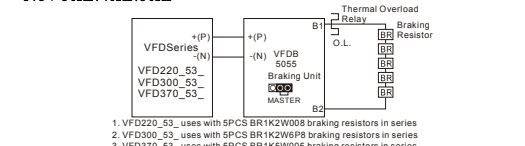

575V 60HP/75HP

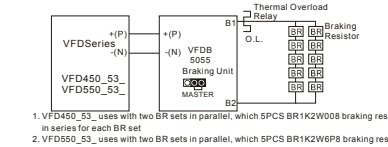

575V 100HP

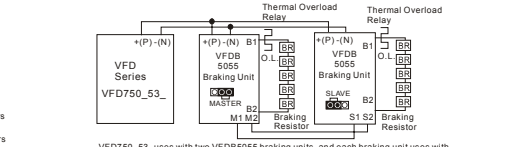

VFDB 系列煞車模組說明書

1 一般注意事項

感謝您選用台達 VFDB 動力制動煞車模組。本產品主要應用於當三相感應馬達由交流馬達驅動器所驅動，在減速停止時用以吸收由馬達側所回生的能量。藉由 VFDB 制動單元將此能量以熱能的方式消耗在煞車電阻上。本產品在安裝使用前，請詳細參閱本說明書再進行施工配線，以免造成機械或人員的傷害。VFDB 動力制動煞車模組適用於本公司 VFD 所有系列的交流馬達驅動器。VFDB 制動單元需搭配煞車電阻 BR 系列，才能發揮優良的制動特性。詳細的規格及使用方法請繼續參閱本說明書。由於產品精益求精，當內容規格有所修正時，請洽詢代理商或至台達網站 (<http://www.delta.com.tw/industrialautomation/>) 下載最新版本。

2 規格

VFDB 制動單元規格		230V 級		460V 級		575V 級	
使用電壓等級	型號	VFDB-□□□□	2015	2022	4030	4045	5055
最大適用馬達容量 (KW)		15	22	30	45	55	
輸出額定	最大放電電流 (A peak) 10%ED	40	60	40	60	60	
	連續放電電流 (A)	15	20	15	18	20	
	制動起始電壓 (DC)	330/345/360/380/400/415±3V	660/690/720/760/800/830±6V			950±8V	
電源	直流電壓	200—400VDC	400—800VDC	607-1000VDC			
	每台等效最小電阻	10Ω	6.8Ω	20Ω	13.6Ω	15.8Ω	
保護	散熱片過熱	溫度超過 +95°C (203°F)					
	故障輸出	RELAY 接點 5A120Vac/28Vdc(RA.RB.RC)					
	充電中顯示	主回路 (P-N) 電壓在 50VDC 以下熄滅					
使用環境	安裝場所	屋內 (無腐蝕性氣體、金屬粉塵)					
	環境溫度	-10°C ~ +50°C (14°F to 122°F)					
	儲存溫度	-20°C ~ +60°C (-4°F to 140°F)					
	濕度	90%RH 以下不結露					
機構構造	振動	20Hz 以下 9.8m/s ² (1G)、20~50Hz 2m/s ² (0.2G)					
		壁掛型 IP50					

3 尺寸- 制動單元

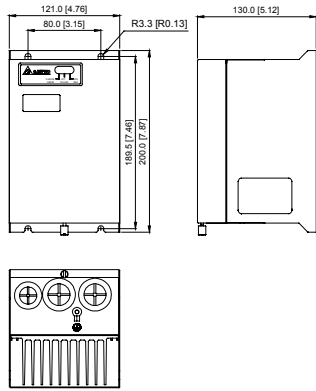

各端子使用線徑

回路名稱	端子記號	導線線徑 AWG (mm ²)	螺絲規格	扭力
電源輸入回路	+(P)、-(N)	10~12AWG (3.5~5.5mm ²)	M4	18 kgf-cm (15.6 in-lbf)
煞車電阻回路	B1、B2	10~12AWG (3.5~5.5mm ²)	M4	18 kgf-cm (15.6 in-lbf)
連動回路	輸入	M1、M2	M2	4 kgf-cm (3 in-lbf)
	輸出	S1、S2		
故障回路	RA、RB、RC	20~18AWG (0.25~0.75mm ²)	M2	4 kgf-cm (3 in-lbf)

5 基本配線圖

動作說明：

- 在安裝制動單元的應用中為了安全的考量，在制動單元與煞車電阻之間加裝一積熱電驛 (O.L.)；並與交流馬達驅動器前端的電磁接觸器 (MC) 作一連鎖的異常保護。
- 加裝積熱電驛的主要目的是為了保護煞車電阻不因煞車頻繁過熱而燒毀，或是因輸入電源電壓異常過高導致制動單元連續導通燒毀煞車電阻。此時只有將交流馬達驅動器的電源關閉才可避免煞車電阻燒毀。
- 積熱電驛規格的選用請參考制動單元與放電電阻選用一覽表。
- 制動單元中的故障輸出端子 (RC、RA、RB) 在散熱裝置溫度高於 95°C 時會動作，表示安裝環境溫度可能超過 50°C 以上，或是煞車制動 ED% 超過 10ED%；若是此類的故障請自行加裝風扇強制風冷或改善環境溫度。若非溫度原因，可能控制電路受損或溫度感測器故障，此時請送廠維修。

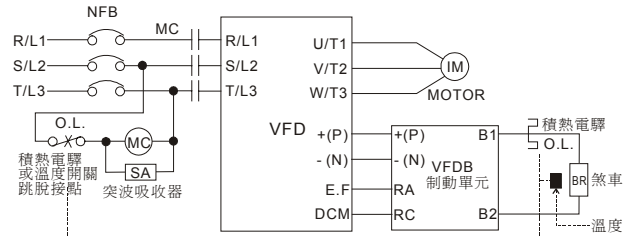

- 當交流馬達驅動器有加裝直流電抗器 (DC Reactor) 時，其煞車模組之電源輸入迴路 + (P) 端的配線方法，可參考交流馬達驅動器手冊。
- 請勿將電源輸入迴路 - (N) 端，接至電力系統之中性點。

6 配線注意事項



- 進行配線施工時務必確認相關回路電源均為關閉狀態；配線的線徑及距離亦務必按照規定選用及施工。
- 交流馬達驅動器 (VFD) 連接至制動單元 (VFDB) 的 + (P)、- (N) 端子有極性之分，千萬要確認再確認，否則電源一開啟制動單元立即炸毀，請務必注意。
- 制動單元在執行煞車時，+ (P)、- (N)、B1、B2 因有大電流通過所連接的導線間將產生能量很大的電磁場；故在初期配線施工規劃時，應與其它低電壓的控制線路分離配線，以免造成不必要的干擾或誤動作。
- 煞車電阻安裝的場所不能有易燃性的物體、氣體、液體，最好能安裝在獨立的金屬箱內並加以風扇散熱。
- 制動單元的接地工程 230V 級請依第三種接地施工，460V 級請依特別第三種接地施工。
- 在減速煞車頻繁的場合 (超過 10ED%) 煞車電阻請加裝風扇強制風冷或其它冷卻設備。
- 在通電中嚴禁修改任何配線及制動單元內部設定，更嚴禁在通電中碰觸相關配線的端子及 PCB 板中的任一元件，以免因通電中遭極度危險的直流高壓感電造成人員傷害。

7 煞車使用率 ED% 的定義

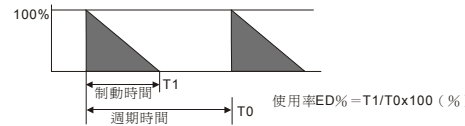

說明：制定煞車使用率 ED%，主要是為了能讓制動單元及煞車電阻有充份的時間來散除因制動而產生的熱量；當煞車電阻發熱時，電阻值將會隨溫度的上昇而變高，制動轉矩亦隨之減少。

8 設定與調整

- 電源電壓的調整：制動單元的電力來源是接受交流馬達驅動器 + (P)、- (N) 兩端供應的直流電源。因此，在配線完成準備運轉時，依交流馬達驅動器的輸入電源來設定制動單元的電源電壓是非常重要的步驟；此設定將會影響制動單元動作電壓的位準，下表為各個電壓動作單位。

表一：電源電壓的選擇與 PN 直流電壓的動作單位

230V 級 AC 電源電壓	制動開始電壓 + (P)、- (N) 母線 DC 電壓	460V 級 AC 電源電壓	制動開始電壓 + (P)、- (N) 母線 DC 電壓	575V 級 AC 電源電壓	制動開始電壓 + (P)、- (N) 母線 DC 電壓
190Vac	330Vdc	380Vac	660Vdc	575Vac	950Vdc
200Vac	345Vdc	400Vac	690Vdc	-	-
210Vac	360Vdc	415Vac	720Vdc	-	-
220Vac	380Vdc	440Vac	760Vdc	-	-
230Vac	400Vdc	460Vac	800Vdc	-	-
240Vac	415Vdc	480Vac	830Vdc	-	-

註：容許輸入電源有±10%的變動



- 主動/連動的設定：制動單元在出廠時均設定在 "MASTER" 主動煞車的位置。"SLAVE" 連動位置的功能主要是應用於兩台以上制動單元並連組合的應用，可使每一台制動單元同時動作同時停止，如此每一台的消耗功率均為相等充份發揮每台的制動功能。

如下圖所示為三台制動單元連動制動的應用；當配線完成後需將第一台設為 "MASTER" 主動的設定，其餘的一定要將插梢設定在 "SLAVE" 連動的位置上，如此即可完成動力制動系統的配線。

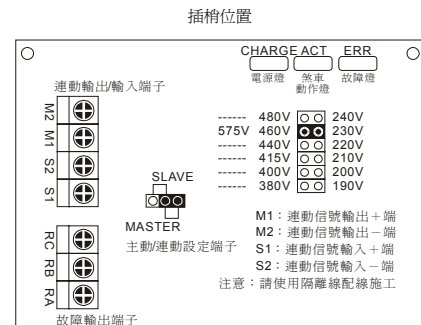
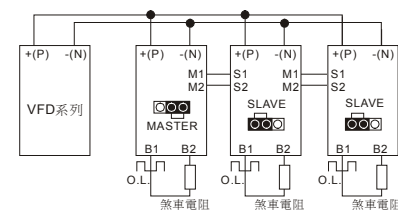

9 制動單元與放電電阻適用一覽表

電壓	適用馬達		全載輸出轉矩 kg-M	每台交流馬達驅動器等效煞車電阻規格	制動單元		制動電阻料號	用量	制動轉矩 10%ED	每台交流馬達驅動器等效最小電阻值	積熱電驛規格中心值
	HP	kW			型式 VFDB	用量					
230V 系列	20	15	8.248	3000W 10Ω	2015	1	BR1K5W005	2	125	10Ω	30
	25	18.5	10.281	4800W 8Ω	2022	1	BR1K2W008	4	125	8Ω	35
	30	22	12.338	4800W 6.8Ω	2022	1	BR1K2W6P8	4	125	6.8Ω	40
	40	30	16.497	6000W 5Ω	2015	2	BR1K5W005	4	125	5Ω	30
	50	37	20.6	9600W 4Ω	2015	2	BR1K2W008	8	125	4Ω	30
460V 系列	20	15	8.248	1500W 40Ω	4030	1	BR1K5W040	1	125	40Ω	15
	25	18.5	10.281	4800W 32Ω	4030	1	BR1K2W008	4	125	32Ω	15
	30	22	12.338	4800W 27.2Ω	4030	1	BR1K2W6P8	4	125	27.2Ω	20
	40	30	16.497	6000W 20Ω	4030	1	BR1K5W005	4	125	20Ω	30
	50	37	20.6	9600W 16Ω	4045	1	BR1K2W008	8	125	16Ω	40
575V 系列	60	45	24.745	9600W 13.6Ω	4045	1	BR1K2W6P8	8	125	13.6Ω	50
	75	55	31.11	12000W 10Ω	4030	2	BR1K5W005	8	125	10Ω	30
	100	75	42.7	19200W 6.8Ω	4045	2	BR1K2W6P8	16	125	6.8Ω	50
	20	15	8.248	3000W 60Ω	5055	1	BR1K0W020	3	125	60Ω	15
	25	18.5	10.281	4000W 50Ω	5055	1	BR1K0W050	4	125	50Ω	15
575V 系列	30	22	12.338	6000W 40Ω	5055	1	BR1K2W008	5	125	40Ω	20
	40	30	16.497	6000W 34Ω	5055	1	BR1K2W6P8	5	125	34Ω	25
	50	37	20.6	7500W 25Ω	5055	1	BR1K5W005	5	125	25Ω	30
	60	45	24.745	12000W 20Ω	5055	1	BR1K2W008	10	125	20Ω	35
	75	55	31.11	12000W 17Ω	5055	1	BR1K2W6P8	10	125	17Ω	45
100	75	42.7	15000W 12.5Ω	5055	2	BR1K5W005	10	125	12.5Ω	45	

10 制動電阻配線圖例

在配線前，注意：每台煞車模組之等效煞車電阻不能低於~每台制動單元最小等效電阻值~(參閱制動單元與放電電阻適用一覽表)。

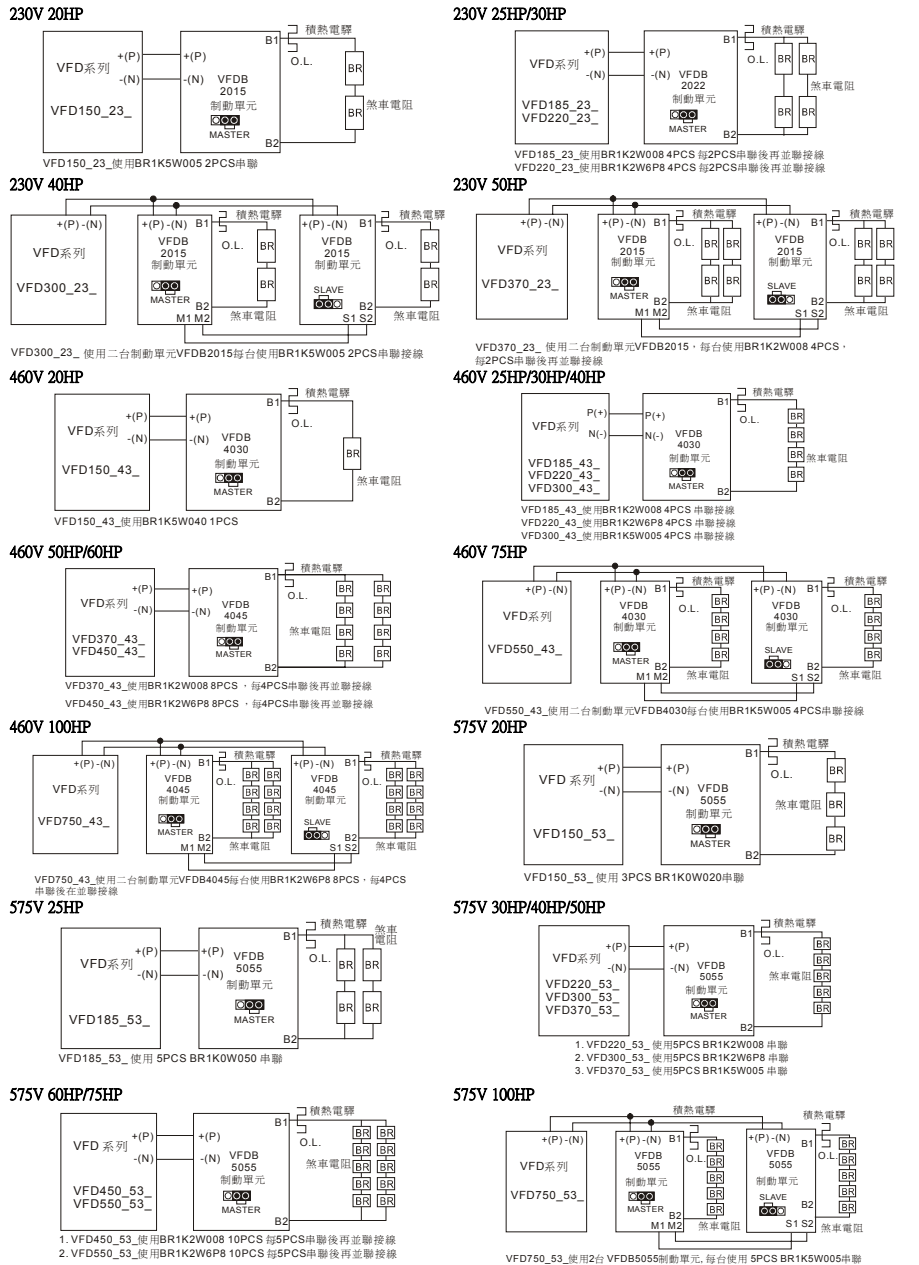

Free Manuals Download Website

<http://myh66.com>

<http://usermanuals.us>

<http://www.somanuals.com>

<http://www.4manuals.cc>

<http://www.manual-lib.com>

<http://www.404manual.com>

<http://www.luxmanual.com>

<http://aubethermostatmanual.com>

Golf course search by state

<http://golfingnear.com>

Email search by domain

<http://emailbydomain.com>

Auto manuals search

<http://auto.somanuals.com>

TV manuals search

<http://tv.somanuals.com>