

Preface

Thank you for choosing DELTA's high-performance VFD-E Series. The VFD-E Series is manufactured with high-quality components and materials and incorporate the latest microprocessor technology available.

Getting Started

This quick start will be helpful in the installation and parameter setting of the AC motor drives. To guarantee safe operation of the equipment, read the following safety guidelines before connecting power to the AC motor drives. For detail information, refer to the VFD-E User Manual on the CD supplied with the drive.

DANGER!

1. AC input power must be disconnected before any wiring to the AC motor drive is made.
2. A charge may still remain in the DC-link capacitors with hazardous voltages, even if the power has been turned off. To prevent personal injury, please ensure that power has turned off before opening the AC motor drive and wait ten minutes for the capacitors to discharge to safe voltage levels.
3. Never reassemble internal components or wiring.
4. The AC motor drive may be destroyed beyond repair if incorrect cables are connected to the input/output terminals. Never connect the AC motor drive output terminals U/T1, V/T2, and W/T3 directly to the AC mains circuit power supply.
5. Ground the VFD-E using the ground terminal. The grounding method must comply with the laws of the country where the AC motor drive is to be installed. Refer to the Basic Wiring Diagram.
6. VFD-E series is used only to control variable speed of 3-phase induction motors, NOT for 1-phase motors or other purpose.
7. VFD-E series is the specific drive for the elevator door and other automatic door control, NOT for those devices that may cause personal injury, such as life support equipment or any life safety situation.
8. To prevent drive damage, the RFI jumper connected to ground shall be cut off if the AC motor drive is installed on an ungrounded power system or a high resistance-grounded (over 30 ohms) power system or a corner grounded TN system.

WARNING!

1. DO NOT use Hi-pot test for internal components. The semi-conductor used in AC motor drive easily damage by high-pressure.
2. There are highly sensitive MOS components on the printed circuit boards. These components are especially sensitive to static electricity. To prevent damage to these components, do not touch these components or the circuit boards with metal objects or your bare hands.
3. Only quality person is allowed to install, wire and maintain AC motor drive.

CAUTION!

1. Some parameters settings can cause the motor to run immediately after applying power.
2. DO NOT install the AC motor drive in a place subjected to high temperature, direct sunlight, high humidity, excessive vibration, corrosive gases or liquids, or airborne dust or metallic particles. Only use AC motor drives within specification. Failure to comply may result in fire, explosion or electric shock. To prevent personal injury, please keep children and unqualified people away from the equipment.
3. When the motor cable between AC motor drive and motor is too long, the layer insulation of the motor may be damaged. Please use a frequency inverter duty motor or add an AC output reactor to prevent damage to the motor. Refer to appendix B Reactor for details.
4. The rated voltage for AC motor drive must be $\leq 240V$ and the mains supply current capacity must be $\leq 5000A$ RMS.



Specifications

Voltage Class		115V Class		
Model Number VFD-XXXE	002	004	007	007
Max. Applicable Motor Output (kW)	0.2	0.4	0.75	0.75
Max. Applicable Motor Output (hp)	0.25	0.5	1.0	1.0
Output Rating	Rated Output Capacity (kVA)	0.6	1.0	1.6
	Rated Output Current (A)	1.6	2.5	4.2
	Maximum Output Voltage (V)	3-Phase Proportional to Twice the Input Voltage		
	Output Frequency (Hz)	0.1~600 Hz		
Input Rating	Carrier Frequency (kHz)	1-15		
	Rated Input Current (A)	Single-phase		
		6	9	18
	Rated Voltage/Frequency	Single phase, 100-120V, 50/60Hz		
	Voltage Tolerance	± 10%(90~132 V)		
Frequency Tolerance	± 5%(47~63 Hz)			
Cooling Method	Natural Cooling		Fan Cooling	
Weight (kg)	1.2	1.2	1.2	

Voltage Class		230V Class							
Model Number VFD-XXXE	002	004	007	015	022	037	055	075	
Max. Applicable Motor Output (kW)	0.2	0.4	0.75	1.5	2.2	3.7	5.5	7.5	
Max. Applicable Motor Output (hp)	0.25	0.5	1.0	2.0	3.0	5.0	7.5	10	
Output Rating	Rated Output Capacity (kVA)	0.6	1.0	1.6	2.9	4.2	6.5	9.5	12.5
	Rated Output Current (A)	1.6	2.5	4.2	7.5	11.0	17	25	33
	Maximum Output Voltage (V)	3-Phase Proportional to Input Voltage							
	Output Frequency (Hz)	0.1~600 Hz							
Input Rating	Carrier Frequency (kHz)	1-15							
	Rated Input Current (A)	Single/3-phase				3-phase			
		4.9/1.9	6.5/2.7	9.5/5.1	15.7/9	24/15	20.6	26	34
	Rated Voltage/Frequency	Single/3-phase 200-240 V, 50/60Hz				3-phase 200-240V, 50/60Hz			
	Voltage Tolerance	± 10%(180~264 V)							
Frequency Tolerance	± 5%(47~63 Hz)								
Cooling Method	Natural Cooling			Fan Cooling					
Weight (kg)	1.1	1.1	1.1	*1.2/1.9	1.9	1.9	3.5	3.5	

*NOTE: the weight for VFD015E23P is 1.2kg.

Voltage Class		460V Class							
Model Number VFD-XXXE	004	007	015	022	037	055	075	110	
Max. Applicable Motor Output (kW)	0.4	0.75	1.5	2.2	3.7	5.5	7.5	11	
Max. Applicable Motor Output (hp)	0.5	1.0	2.0	3.0	5.0	7.5	10	15	
Output Rating	Rated Output Capacity (kVA)	1.2	2.0	3.3	4.4	6.8	9.9	13.7	18.3
	Rated Output Current (A)	1.5	2.5	4.2	5.5	8.2	13	18	24
	Maximum Output Voltage (V)	3-Phase Proportional to Input Voltage							
	Output Frequency (Hz)	0.1~600 Hz							
Input Rating	Carrier Frequency (kHz)	1-15							
	Rated Input Current (A)	3-phase							
		1.9	3.2	4.3	7.1	11.2	14	19	26
	Rated Voltage/Frequency	3-phase, 380-480V, 50/60Hz							
	Voltage Tolerance	± 10%(342~528V)							
Frequency Tolerance	± 5%(47~63Hz)								
Cooling Method	Natural Cooling			Fan Cooling					
Weight (kg)	1.2	1.2	1.2	1.9	1.9	4.2	4.2	4.2	

General Specifications			
Control Characteristics	Control System	SPWM(Sinusoidal Pulse Width Modulation) control (V/f or sensorless vector control)	
	Frequency Setting Resolution	0.01Hz	
	Output Frequency Resolution	0.01Hz	
	Torque Characteristics	Including the auto-torque/auto-slip compensation; starting torque can be 150% at 3.0Hz	
	Overload Endurance	150% of rated current for 1 minute	
	Skip Frequency	Three zones, setting range 0.1-600Hz	
	Accel/Decel Time	0.1 to 600 seconds (2 Independent settings for Accel/Decel time)	
	Stall Prevention Level	Setting 20 to 250% of rated current	
	DC Brake	Operation frequency 0.1-600.0Hz, output 0-100% rated current Start time 0-60 seconds, stop time 0-60 seconds	
	Regenerated Brake Torque	Approx. 20% (up to 125% possible with optional brake resistor or externally mounted brake unit, 1-15hp (0.75-11kW) models have brake chopper built-in)	
V/f Pattern	4-point adjustable V/f pattern		
Operating Characteristics	Frequency Setting	Keypad	Setting by  
		External Signal	Potentiometer-5kΩ/0.5W, 0 to +10VDC, 4 to 20mA, RS-485 interface; Multi-function Inputs 3 to 9 (15 steps, Jog, up/down)
	Operation Setting Signal	Keypad	Set by RUN and STOP
		External Signal	2 wires/3 wires ((MI1, MI2, MI3)), JOG operation, RS-485 serial interface (MODBUS), programmable logic controller
	Multi-function Input Signal	Multi-step selection 0 to 15, Jog, accel/decel inhibit, 2 accel/decel switches, counter, external Base Block, ACI/AVI selections, driver reset, UP/DOWN key settings, NPN/PNP input selection	
	Multi-function Output Indication	AC drive operating, frequency attained, zero speed, Base Block, fault indication, overheat alarm, emergency stop and status selections of input terminals	
	Analog Output Signal	Output frequency/current	
Alarm Output Contact	Contact will be On when drive malfunctions (1 Form C/change-over contact and 1 open collector output) for standard type)		
Operation Functions	Built-in PLC(NOT for CANopen models), AVR, accel/decel S-Curve, over-voltage/over-current stall prevention, 5 fault records, reverse inhibition, momentary power loss restart, DC brake, auto torque/slip compensation, auto tuning, adjustable carrier frequency, output frequency limits, parameter lock/reset, vector control, PID control, external counter, MODBUS communication, abnormal reset, abnormal re-start, power-saving, fan control, sleep/wake frequency, 1st/2nd frequency source selections, 1st/2nd frequency source combination, NPN/PNP selection, parameters for motor 0 to motor 3, DEB and OOB (Out Of Balance Detection)(for washing machine)		
Protection Functions	Over voltage, over current, under voltage, external fault, overload, ground fault, overheating, electronic thermal, IGBT short circuit, PTC		
Display Keypad (optional)	6-key, 7-segment LED with 4-digit, 5 status LEDs, master frequency, output frequency, output current, custom units, parameter values for setup and lock, faults, RUN, STOP, RESET, FWD/REV, PLC		
Built-in Brake Chopper	VFD002E11T/21T/23T, VFD004E11T/21T/23T/43T, VFD007E21T/23T/43T, VFD015E23T/43T, VFD007E11A, VFD015E21A, VFD022E21A/23A/43A, VFD037E23A/43A VFD007E11C, VFD015E21C, VFD022E21C/23C/43C, VFD037E23C/43C, VFD055E23A/43A, VFD075E23A/43A, VFD110E43A, VFD055E23C/43C, VFD075E23C/43C, VFD110E43C		
Built-in EMI Filter	For 230V 1-phase and 460V 3-phase models.		
Environmental Conditions	Enclosure Rating	IP20	
	Pollution Degree	2	
	Installation Location	Altitude 1,000 m or lower, keep from corrosive gasses, liquid and dust	
	Ambient Temperature	-10°C to 50°C (40°C for side-by-side mounting) Non-Condensing and not frozen	

Storage/ Transportation Temperature	-20 °C to 60 °C
Ambient Humidity	Below 90% RH (non-condensing)
Vibration	9.80665m/s ² (1G) less than 20Hz, 5.88m/s ² (0.6G) at 20 to 50Hz
Approvals	

Basic Wiring Diagram

Users must connect wiring according to the following circuit diagram shown below.

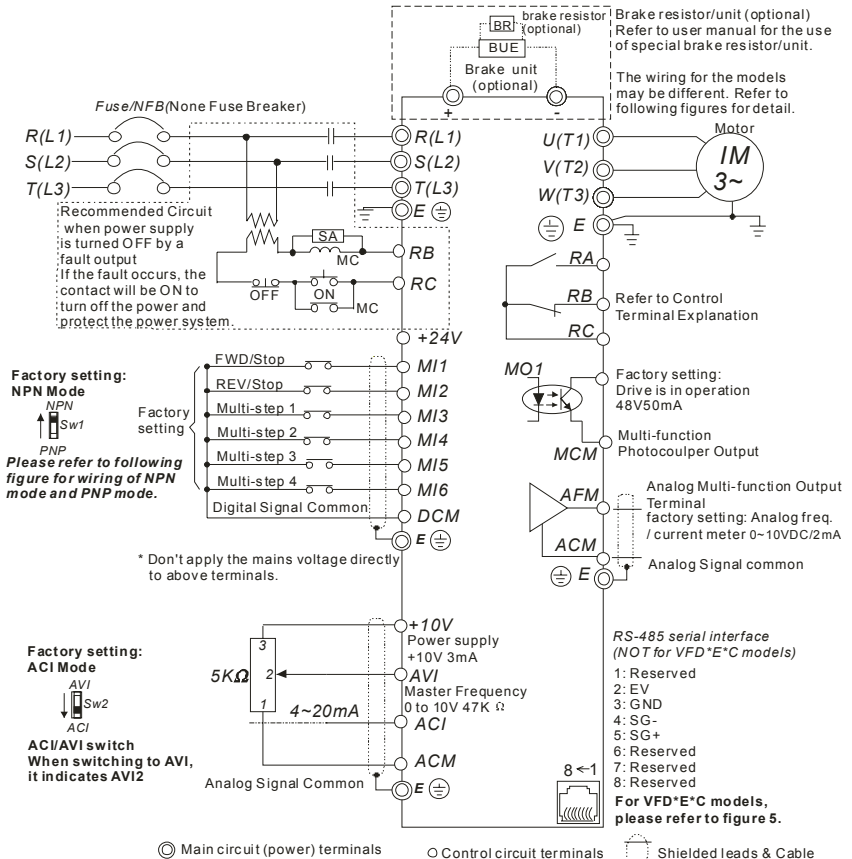

* Single-phase models can only use R(L1), S(L2) to be the power terminals.

* Single-phase power cannot be used for 3-phase models.

Figure 1 for models of VFD-E Series

VFD002E11A/21A/23A, VFD004E11A/21A/23A/43A, VFD007E21A/23A/43A, VFD015E23A/43A, VFD002E11C/21C/23C, VFD004E11C/21C/23C/43C, VFD007E21C/23C/43C, VFD015E23C/43C, VFD002E11P/21P/23P, VFD004E11P/21P/23P/43P, VFD007E21P/23P/43P, VFD015E23P/43P

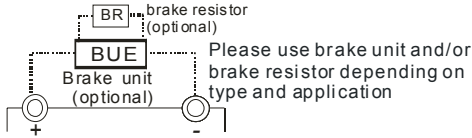

Figure 2 for models of VFD-E Series

VFD007E11A, VFD015E21A, VFD022E21A/23A/43A, VFD037E23A/43A, VFD055E23A/43A, VFD075E23A/43A, VFD110E43A, VFD007E11C, VFD015E21C, VFD022E21C/23C/43C, VFD037E23C/43C, VFD055E23C/43C, VFD075E23C/43C, VFD110E43C

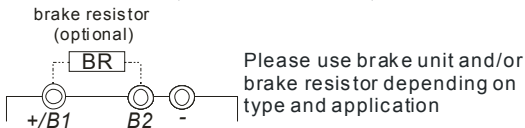

Figure 3 for models of VFD-E Series

VFD002E11T/21T/23T, VFD004E11A/21T/23T/43T, VFD007E21T/23T/43T, VFD015E23T/43T

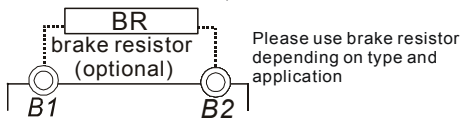
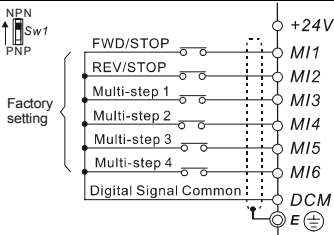
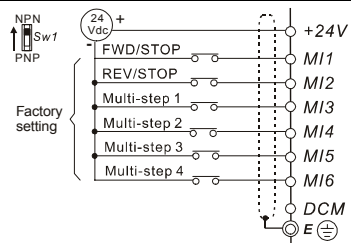

Figure 4 Wiring for NPN Mode and PNP Mode

A. NPN mode without external power



B. NPN mode with external power



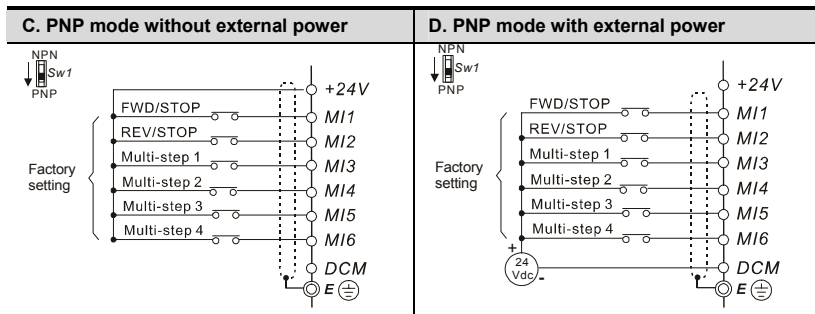

Figure 5 RJ-45 Pins Definition for VFD*E*C Models

PIN	Signal	Description
1	CAN_H	CAN_H bus line (dominant high)
2	CAN_L	CAN_L bus line (dominant low)
3	CAN_GND	Ground / 0V /V-
4	SG+	485 communication
5	SG-	485 communication
7	CAN_GND	Ground / 0V /V-

Description of the Digital Keypad KPE-LE02 (Optional)



- Status Display**
Display the driver's current status.
- LED Display**
Indicates frequency, voltage, current, user defined units and etc.
- Potentiometer**
For master Frequency setting.
- RUN Key**
Start AC drive operation.
- UP and DOWN Key**
Set the parameter number and changes the numerical data, such as Master Frequency.
- MODE**
Change between different display mode.
- STOP/RESET**
Stops AC drive operation and reset the drive after fault occurred.
- ENTER**
Used to enter/modify programming parameters

Operation Steps of the Digital Keypad

Setting Mode



NOTE: In the selection mode, press **ENTER** to set the parameters.

GO START

Setting parameters



NOTE: In the parameter setting mode, you can press **ENTER** to return the selecting mode.

To shift data



Setting direction (When operation source is digital keypad)



Setting PLC Mode

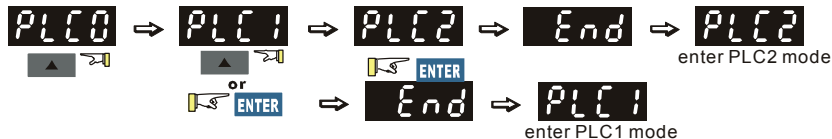

Power Terminals and Control Terminals

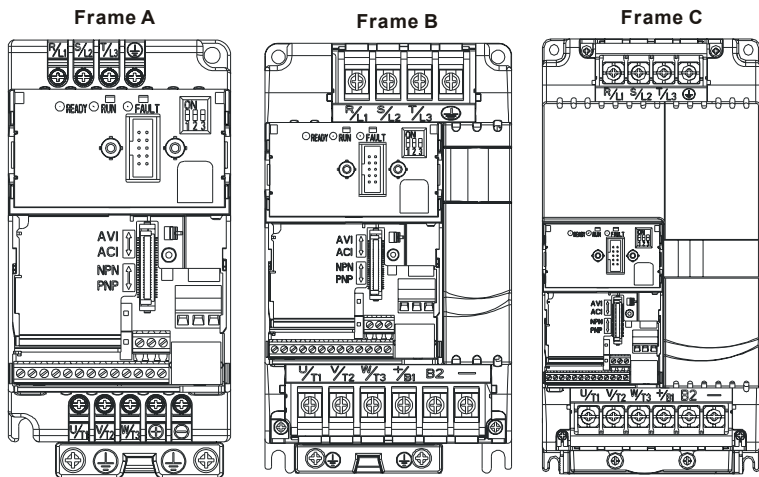

Frame	Power Terminals	Torque	Wire	Wire Type
A	R/L1, S/L2, T/L3	14kgf-cm (12in-lbf)	12-14 AWG. (3.3-2.1mm ²)	Copper only, 75°C
	U/T1, V/T2, W/T3, ⊕			
B	R/L1, S/L2, T/L3	18kgf-cm (15.6in-lbf)	8-18 AWG. (8.4-0.8mm ²)	Copper only, 75°C
	U/T1, V/T2, W/T3			
	+/B1, B2, -, ⊕			
C	R/L1, S/L2, T/L3	30kgf-cm (26in-lbf)	8-16 AWG. (8.4-1.3mm ²)	Copper only, 75°C
	U/T1, V/T2, W/T3			
	+/B1, B2, -, ⊕			

NOTE

For frame C: To connect 6 AWG (13.3 mm²) wires, use Recognized Ring Terminals

Terminal Explanations

Terminal Symbol	Explanation of Terminal Function
R/L1, S/L2, T/L3	AC line input terminals (1-phase/3-phase)
U/T1, V/T2, W/T3	AC drive output terminals for connecting 3-phase induction motor
+/B1~ B2	Connections for Brake resistor (optional)
+/B1, -	Connections for External Brake unit (BUE series)
⊕	Earth connection, please comply with local regulations.

The Specification for the Control Terminals

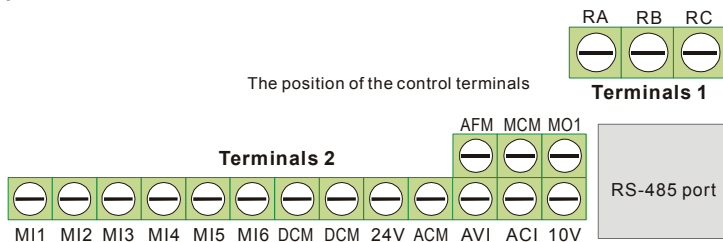

Frame	Control Terminals	Torque	Wire
A, B, C	Terminals 1	5 kgf-cm (4.4 in-lbf)	12-24 AWG (3.3-0.2mm ²)
	Terminals 2	2 kgf-cm (2 in-lbf)	16-24 AWG (1.3-0.2mm ²)

NOTE

Frame A: VFD002E11A/21A/23A, VFD004E11A/21A/23A/43A, VFD007E21A/23A/43A, VFD015E23A/43A, VFD002E11C/21C/23C, VFD004E11C/21C/23C/43C, VFD007E21C/23C/43C, VFD015E23C/43C, VFD002E11T/21T/23T, VFD004E11T/21T/23T/43T, VFD007E21T/23T/43T, VFD015E23T/43T, VFD002E11P/21P/23P, VFD004E11P/21P/23P/43P, VFD007E21P/23P/43P, VFD015E23P/43P

Frame B: VFD007E11A, VFD015E21A, VFD022E21A/23A/43A, VFD037E23A/43A

Frame C: VFD055E23A/43A, VFD075E23A/43A, VFD110E43A

Control Terminals Explanations

Terminal Symbol	Terminal Function	Factory Settings (NPN mode) ON: Connect to DCM
MI1	Forward-Stop command	ON: Run in MI1 direction OFF: Stop acc. to Stop Method
MI2	Reverse-Stop command	ON: Run in MI2 direction OFF: Stop acc. to Stop Method
MI3	Multi-function Input 3	Refer to Pr.04.05 to Pr.04.08 for programming the Multi-function Inputs. ON: the activation current is 5.5mA . OFF: leakage current tolerance is 10 μ A.
MI4	Multi-function Input 4	
MI5	Multi-function Input 5	
MI6	Multi-function Input 6	
+24V	DC Voltage Source	+24VDC, 20mA used for PNP mode.
RA	Multi-function Relay output (N.O.) a	Resistive Load: 5A(N.O.)/3A(N.C.) 240VAC 5A(N.O.)/3A(N.C.) 24VDC
RB	Multi-function Relay output (N.C.) b	Inductive Load: 1.5A(N.O.)/0.5A(N.C.) 240VAC 1.5A(N.O.)/0.5A(N.C.) 24VDC
RC	Multi-function Relay common	Refer to Pr.03.00 for programming
DCM	Digital Signal Common	Common for digital inputs and used for NPN mode.

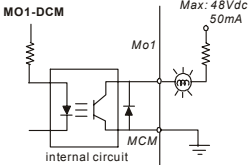
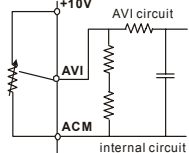
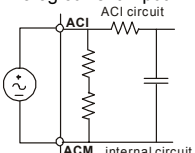
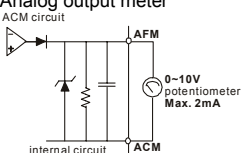
Terminal Symbol	Terminal Function	Factory Settings (NPN mode) ON: Connect to DCM
MO1	Multi-function Output 1 (Photocoupler)	Maximum 48VDC, 50mA Refer to Pr.03.01 for programming 
MCM	Multi-function output common	Common for Multi-function Outputs
+10V	Potentiometer power supply	+10VDC 3mA
AVI	Analog voltage Input 	Impedance: 47kΩ Resolution: 10 bits Range: 0 ~ 10VDC = 0 ~ Max. Output Frequency (Pr.01.00) Selection: Pr.02.00, Pr.02.09, Pr.10.00 Set-up: Pr.04.11 ~ Pr.04.14
ACM	Analog control signal (common)	Common for AVI, ACI, AFM
ACI	Analog current Input 	Impedance: 250Ω Resolution: 10 bits Range: 4 ~ 20mA = 0 ~ Max. Output Frequency (Pr.01.00) Selection: Pr.02.00, Pr.02.09, Pr.10.00 Set-up: Pr.04.15 ~ Pr.04.18, 04.19~04.23
AFM	Analog output meter 	0 to 10V, 2mA Impedance: 20kΩ Output current: 2mA max Resolution: 8 bits Range: 0 ~ 10VDC Function: Pr.03.03 to Pr.03.04

NOTE: Control signal wiring size: 18 AWG (0.75 mm²) with shielded wire.

Summary of Parameter Settings

⚡: The parameter can be set during operation.

Pr.	Explanation	Settings	Factory Setting	NOTE
Group 0 User Parameters				
00.00	Identity Code of the AC motor drive	Read-only	##	

Pr.	Explanation	Settings	Factory Setting	NOTE
00.01	Rated Current Display of the AC motor drive	Read-only	##	
00.02	Parameter Reset	0: Parameter can be read/written 1: All parameters are read only 6: Clear PLC program (NOT for VFD*E*C models) 9: All parameters are reset to factory settings (50Hz, 230V/400V or 220V/380V depends on Pr.00.12) 10: All parameters are reset to factory settings (60Hz, 220V/440V)	0	
↗00.03	Start-up Display Selection	0: Display the frequency command value (Fxxx) 1: Display the actual output frequency (Hxxx) 2: Display the content of user-defined unit (Uxxx) 3: Multifunction display, see Pr.00.04 4: FWD/REV command 5: PLCx (PLC selections: PLC0/PLC1/PLC2) (NOT for VFD*E*C models)	0	
↗00.04	Content of Multi-function Display	0: Display the content of user-defined unit (Uxxx) 1: Display the counter value (c) 2: Display PLC D1043 value (C) (NOT for VFD*E*C models) 3: Display DC-BUS voltage (u) 4: Display output voltage (E) 5: Display PID analog feedback signal value (b) (%) 6: Output power factor angle (n) 7: Display output power (P) 8: Display the estimated value of torque as it relates to current (t) 9: Display AVI (I) (V) 10: Display ACI / AVI2 (i) (mA/V) 11: Display the temperature of IGBT (h) (°C) 12: Display AVI3/ACI2 level (l.) 13: Display AVI4/ACI3 level (i.) 14: Display PG speed in RPM (G) 15: Display motor number (M)	0	
↗00.05	User-Defined Coefficient K	0. 1 to 160.0	1.0	
00.06	Power Board Software Version	Read-only	###	
00.07	Control Board Software Version	Read-only	###	
00.08	Password Input	0 to 9999	0	
00.09	Password Set	0 to 9999	0	
00.10	Control Method	0: V/f Control 1: Vector Control	0	
00.11	Reserved			

Pr.	Explanation	Settings	Factory Setting	NOTE
00.12	50Hz Base Voltage Selection	0: 230V/400V 1: 220V/380V	0	
Group 1 Basic Parameters				
01.00	Maximum Output Frequency (Fmax)	50.00 to 600.0 Hz	60.00	
01.01	Maximum Voltage Frequency (Fbase) (Motor 0)	0.10 to 600.0 Hz	60.00	
01.02	Maximum Output Voltage (Vmax) (Motor 0)	115V/230V series: 0.1V to 255.0V 460V series: 0.1V to 510.0V	220.0 440.0	
01.03	Mid-Point Frequency (Fmid) (Motor 0)	0.10 to 600.0 Hz	1.50	
01.04	Mid-Point Voltage (Vmid) (Motor 0)	115V/230V series: 0.1V to 255.0V 460V series: 0.1V to 510.0V	10.0 20.0	
01.05	Minimum Output Frequency (Fmin) (Motor 0)	0.10 to 600.0 Hz	1.50	
01.06	Minimum Output Voltage (Vmin) (Motor 0)	115V/230V series: 0.1V to 255.0V 460V series: 0.1V to 510.0V	10.0 20.0	
01.07	Output Frequency Upper Limit	0.1 to 120.0%	110.0	
01.08	Output Frequency Lower Limit	0.0 to 100.0 %	0.0	
↗01.09	Accel Time 1	0.1 to 600.0 / 0.01 to 600.0 sec	10.0	
↗01.10	Decel Time 1	0.1 to 600.0 / 0.01 to 600.0 sec	10.0	
↗01.11	Accel Time 2	0.1 to 600.0 / 0.01 to 600.0 sec	10.0	
		For VFD*E*C models, the factory setting is 1.0		
↗01.12	Decel Time 2	0.1 to 600.0 / 0.01 to 600.0 sec	10.0	
		For VFD*E*C models, the factory setting is 1.0		
↗01.13	Jog Acceleration Time	0.1 to 600.0 / 0.01 to 600.0 sec	1.0	
↗01.14	Jog Deceleration Time	0.1 to 600.0 / 0.01 to 600.0 sec	1.0	
↗01.15	Jog Frequency	0.10 Hz to Fmax (Pr.01.00) Hz	6.00	
01.16	Auto acceleration / deceleration (refer to Accel/Decel time setting)	0: Linear Accel/Decel 1: Auto Accel, Linear Decel 2: Linear Accel, Auto Decel 3: Auto Accel/Decel (Set by load) 4: Auto Accel/Decel (set by Accel/Decel Time setting)	0	
01.17	Acceleration S-Curve	0.0 to 10.0 / 0.00 to 10.00 sec	0.0	
01.18	Deceleration S-Curve	0.0 to 10.0 / 0.00 to 10.00 sec	0.0	
01.19	Accel/Decel Time Unit	0: Unit: 0.1 sec 1: Unit: 0.01 sec	0	
01.20	Delay Time at 0Hz for Simple Position	0.00 to 600.00 sec	0.00	

Pr.	Explanation	Settings	Factory Setting	NOTE
01.21	Delay Time at 10Hz for Simple Position	0.00 to 600.00 sec	0.00	
01.22	Delay Time at 20Hz for Simple Position	0.00 to 600.00 sec	0.00	
01.23	Delay Time at 30Hz for Simple Position	0.00 to 600.00 sec	0.00	
01.24	Delay Time at 40Hz for Simple Position	0.00 to 600.00 sec	0.00	
01.25	Delay Time at 50Hz for Simple Position	0.00 to 600.00 sec	0.00	
01.26	Maximum Voltage Frequency (Fbase) (Motor 1)	0.10 to 600.0 Hz	60.00	
01.27	Maximum Output Voltage (Vmax) (Motor 1)	115V/230V series: 0.1V to 255.0V 460V series: 0.1V to 510.0V	220.0 440.0	
01.28	Mid-Point Frequency (Fmid) (Motor 1)	0.10 to 600.0 Hz	1.50	
01.29	Mid-Point Voltage (Vmid) (Motor 1)	115V/230V series: 0.1V to 255.0V 460V series: 0.1V to 510.0V	10.0 20.0	
01.30	Minimum Output Frequency (Fmin) (Motor 1)	0.10 to 600.0 Hz	1.50	
01.31	Minimum Output Voltage (Vmin) (Motor 1)	115V/230V series: 0.1V to 255.0V 460V series: 0.1V to 510.0V	10.0 20.0	
01.32	Maximum Voltage Frequency (Fbase) (Motor 2)	0.10 to 600.0 Hz	60.00	
01.33	Maximum Output Voltage (Vmax) (Motor 2)	115V/230V series: 0.1V to 255.0V 460V series: 0.1V to 510.0V	220.0 440.0	
01.34	Mid-Point Frequency (Fmid) (Motor 2)	0.10 to 600.0 Hz	1.50	
01.35	Mid-Point Voltage (Vmid) (Motor 2)	115V/230V series: 0.1V to 255.0V 460V series: 0.1V to 510.0V	10.0 20.0	
01.36	Minimum Output Frequency (Fmin) (Motor 2)	0.10 to 600.0 Hz	1.50	
01.37	Minimum Output Voltage (Vmin) (Motor 2)	115V/230V series: 0.1V to 255.0V 460V series: 0.1V to 510.0V	10.0 20.0	
01.38	Maximum Voltage Frequency (Fbase) (Motor 3)	0.10 to 600.0 Hz	60.00	
01.39	Maximum Output Voltage (Vmax) (Motor 3)	115V/230V series: 0.1V to 255.0V 460V series: 0.1V to 510.0V	220.0 440.0	

Pr.	Explanation	Settings	Factory Setting	NOTE
01.40	Mid-Point Frequency (Fmid) (Motor 3)	0.10 to 600.0 Hz	1.50	
01.41	Mid-Point Voltage (Vmid) (Motor 3)	115V/230V series: 0.1V to 255.0V 460V series: 0.1V to 510.0V	10.0 20.0	
01.42	Minimum Output Frequency (Fmin) (Motor 3)	0.10 to 600.0 Hz	1.50	
01.43	Minimum Output Voltage (Vmin) (Motor 3)	115V/230V series: 0.1V to 255.0V 460V series: 0.1V to 510.0V	10.0 20.0	

Group 2 Operation Method Parameters

∞02.00	Source of First Master Frequency Command	0: Digital keypad UP/DOWN keys or Multi-function Inputs UP/DOWN. Last used frequency saved. 1: 0 to +10V from AVI 2: 4 to 20mA from ACI or 0 to +10V from AVI2 3: RS-485 (RJ-45)/USB communication 4: Digital keypad potentiometer 5: CANopen communication	1	
		For VFD*E*C models, the factory setting is 5		
∞02.01	Source of First Operation Command	0: Digital keypad 1: External terminals. Keypad STOP/RESET enabled. 2: External terminals. Keypad STOP/RESET disabled. 3: RS-485 (RJ-45)/USB communication. Keypad STOP/RESET enabled. 4: RS-485 (RJ-45)/USB communication. Keypad STOP/RESET disabled. 5: CANopen communication. Keypad STOP/RESET disabled.	1	
		For VFD*E*C models, the factory setting is 5		
02.02	Stop Method	0: STOP: ramp to stop; E.F.: coast to stop 1: STOP: coast to stop; E.F.: coast to stop 2: STOP: ramp to stop; E.F.: ramp to stop 3: STOP: coast to stop; E.F.: ramp to stop	0	
02.03	PWM Carrier Frequency Selections	1 to 15kHz	8	
02.04	Motor Direction Control	0: Enable forward/reverse operation 1: Disable reverse operation 2: Disabled forward operation	0	

Pr.	Explanation	Settings	Factory Setting	NOTE
02.05	Line Start Lockout	0: Disable. Operation status is not changed even if operation command source Pr.02.01 is changed. 1: Enable. Operation status is not changed even if operation command source Pr.02.01 is changed. 2: Disable. Operation status will change if operation command source Pr.02.01 is changed. 3: Enable. Operation status will change if operation command source Pr.02.01 is changed.	1	
02.06	Loss of ACI Signal (4-20mA)	0: Decelerate to 0 Hz 1: Coast to stop and display "AErr" 2: Continue operation by last frequency command	1	
02.07	Up/Down Mode	0: by UP/DOWN Key 1: Based on accel/decel time 2: Constant speed (Pr.02.08) 3: Pulse input unit (Pr.02.08)	0	
02.08	Accel/Decel Rate of Change of UP/DOWN Operation with Constant Speed	0.01~10.00 Hz	0.01	
↗02.09	Source of Second Frequency Command	0: Digital keypad UP/DOWN keys or Multi-function Inputs UP/DOWN. Last used frequency saved. 1: 0 to +10V from AVI 2: 4 to 20mA from ACI or 0 to +10V from AVI2 3: RS-485 (RJ-45)/USB communication 4: Digital keypad potentiometer 5: CANopen communication For VFD*E*C models, the factory setting is 5	0	
↗02.10	Combination of the First and Second Master Frequency Command	0: First Master Frequency Command 1: First Master Frequency Command+ Second Master Frequency Command 2: First Master Frequency Command - Second Master Frequency Command	0	
↗02.11	Keypad Frequency Command	0.00 to 600.0Hz	60.00	
↗02.12	Communication Frequency Command	0.00 to 600.0Hz	60.00	
02.13	The Selections for Saving Keypad or Communication Frequency Command	0: Save Keypad & Communication Frequency 1: Save Keypad Frequency only 2: Save Communication Frequency only	0	

Pr.	Explanation	Settings	Factory Setting	NOTE
02.14	Initial Frequency Selection (for keypad & RS485/USB)	0: by Current Freq Command 1: by Zero Freq Command 2: by Frequency Display at Stop	0	
02.15	Initial Frequency Setpoint (for keypad & RS485/USB)	0.00 ~ 600.0Hz	60.00	
02.16	Display the Master Freq Command Source	Read Only Bit0=1: by First Freq Source (Pr.02.00) Bit1=1: by Second Freq Source (Pr.02.09) Bit2=1: by Multi-input function Bit3=1: by PLC Freq command (NOT for VFD*E*C models)	##	
02.17	Display the Operation Command Source	Read Only Bit0=1: by Digital Keypad Bit1=1: by RS485 communication Bit2=1: by External Terminal 2/3 wire mode Bit3=1: by Multi-input function Bit4=1: by PLC Operation Command (NOT for VFD*E*C models) Bit5=1: by CANopen communication	##	
Group 3 Output Function Parameters				
03.00	Multi-function Output Relay (RA1, RB1, RC1)	0: No function 1: AC drive operational 2: Master frequency attained 3: Zero speed 4: Over torque detection	8	
03.01	Multi-function Output Terminal MO1	5: Base-Block (B.B.) indication 6: Low-voltage indication 7: Operation mode indication 8: Fault indication 9: Desired frequency 1 attained 10: Terminal count value attained 11: Preliminary count value attained 12: Over Voltage Stall supervision 13: Over Current Stall supervision 14: Heat sink overheat warning 15: Over Voltage supervision 16: PID supervision 17: Forward command 18: Reverse command 19: Zero speed output signal 20: Warning(FbE, Cexx, AoL2, AUE, SAvE) 21: Brake control (Desired frequency attained) 22: Drive ready 23: Desired frequency 2 attained	1	
03.02	Desired Frequency 1 Attained	0.00 to 600.0Hz	0.00	
↗03.03	Analog Output Signal Selection (AFM)	0: Analog frequency meter 1: Analog current meter	0	
↗03.04	Analog Output Gain	1 to 200%	100	

Pr.	Explanation	Settings	Factory Setting	NOTE
03.05	Terminal Count Value	0 to 9999	0	
03.06	Preliminary Count Value	0 to 9999	0	
03.07	EF Active When Terminal Count Value Attained	0: Terminal count value attained, no EF display 1: Terminal count value attained, EF active	0	
03.08	Fan Control	0: Fan always ON 1: 1 minute after AC motor drive stops, fan will be OFF 2: Fan ON when AC motor drive runs, fan OFF when AC motor drive stops 3: Fan ON when preliminary heatsink temperature attained	0	
03.09	The Digital Output Used by PLC (NOT for VFD*E*C models)	Read only Bit0=1:RLY used by PLC Bit1=1:MO1 used by PLC Bit2=1:MO2/RA2 used by PLC Bit3=1:MO3/RA3 used by PLC Bit4=1:MO4/RA4 used by PLC Bit5=1:MO5/RA5 used by PLC Bit6=1:MO6/RA6 used by PLC Bit7=1:MO7/RA7 used by PLC	##	
03.10	The Analog Output Used by PLC (NOT for VFD*E*C models)	Read only Bit0=1:AFM used by PLC Bit1=1: AO1 used by PLC Bit2=1: AO2 used by PLC	##	
03.11	Brake Release Frequency	0.00 to 20.00Hz	0.00	
03.12	Brake Engage Frequency	0.00 to 20.00Hz	0.00	
03.13	Display the Status of Multi-function Output Terminals	Read only Bit0: RLY Status Bit1: MO1 Status Bit2: MO2/RA2 Status Bit3: MO3/RA3 Status Bit4: MO4/RA4 Status Bit5: MO5/RA5 Status Bit6: MO6/RA6 Status Bit7: MO7/RA7 Status	##	
03.14	Desired Frequency 2 Attained	0.00 to 600.0Hz	0.00	
Group 4 Input Function Parameters				
↗04.00	Keypad Potentiometer Bias	0.0 to 100.0 %	0.0	
↗04.01	Keypad Potentiometer Bias Polarity	0: Positive bias 1: Negative bias	00	
↗04.02	Keypad Potentiometer Gain	0.1 to 200.0 %	100.0	

Pr.	Explanation	Settings	Factory Setting	NOTE
04.03	Keypad Potentiometer Negative Bias, Reverse Motion Enable/Disable	0: No negative bias command 1: Negative bias: REV motion enabled	0	
04.04	2-wire/3-wire Operation Control Modes	0: 2-wire: FWD/STOP, REV/STOP 1: 2-wire: FWD/REV, RUN/STOP 2: 3-wire operation	0	
04.05	Multi-function Input Terminal (MI3)	0: No function 1: Multi-Step speed command 1 2: Multi-Step speed command 2 3: Multi-Step speed command 3	1	
04.06	Multi-function Input Terminal (MI4)	4: Multi-Step speed command 4 5: External reset 6: Accel/Decel inhibit 7: Accel/Decel time selection command	2	
04.07	Multi-function Input Terminal (MI5)	8: Jog Operation 9: External base block 10: Up: Increment master frequency 11: Down: Decrement master frequency 12: Counter Trigger Signal 13: Counter reset 14: E.F. External Fault Input 15: PID function disabled 16: Output shutoff stop 17: Parameter lock enable 18: Operation command selection (external terminals) 19: Operation command selection(keypad)	3	
04.08	Multi-function Input Terminal (MI6) For VFD*E*C models, the factory setting is 23. The factory setting for the other models is 4.	20: Operation command selection(communication) 21: FWD/REV command 22: Source of second frequency command 23: Run/Stop PLC Program (PLC1) (NOT for VFD*E*C models) 23: Quick Stop (Only for VFD*E*C models) 24: Download/execute/monitor PLC Program (PLC2) (NOT for VFD*E*C models) 25: Simple position function 26: OOB (Out of Balance Detection) 27: Motor selection (bit 0) 28: Motor selection (bit 1)		
04.09	Multi-function Input Contact Selection	Bit0:MI1 Bit1:MI2 Bit2:MI3 Bit3:MI4 Bit4:MI5 Bit5:MI6 Bit6:MI7 Bit7:MI8 Bit8:MI9 Bit9:MI10 Bit10:MI11	0	

Pr.	Explanation	Settings	Factory Setting	NOTE
		Bit11:MI12 0:N.O., 1:N.C. P.S.:MI1 to MI3 will be invalid when it is 3-wire control.		
04.10	Digital Terminal Input Debouncing Time	1 to 20 (*2ms)	1	
04.11	Min AVI Voltage	0.0 to 10.0V	0.0	
04.12	Min AVI Frequency	0.0 to 100.0%	0.0	
04.13	Max AVI Voltage	0.0 to 10.0V	10.0	
04.14	Max AVI Frequency	0.0 to 100.0%	100.0	
04.15	Min ACI Current	0.0 to 20.0mA	4.0	
04.16	Min ACI Frequency	0.0 to 100.0%	0.0	
04.17	Max ACI Current	0.0 to 20.0mA	20.0	
04.18	Max ACI Frequency	0.0 to 100.0%	100.0	
04.19	ACI/AVI2 Selection	0: ACI 1: AVI2	0	
04.20	Min AVI2 Voltage	0.0 to 10.0V	0.0	
04.21	Min AVI2 Frequency	0.0 to 100.0%	0.0	
04.22	Max AVI2 Voltage	0.0 to 10.0V	10.0	
04.23	Max AVI2 Frequency	0.0 to 100.0%	100.0	
04.24	The Digital Input Used by PLC (NOT for VFD*E*C models)	Read only. Bit0=1:MI1 used by PLC Bit1=1:MI2 used by PLC Bit2=1:MI3 used by PLC Bit3=1:MI4 used by PLC Bit4=1:MI5 used by PLC Bit5=1:MI6 used by PLC Bit6=1: MI7 used by PLC Bit7=1: MI8 used by PLC Bit8=1: MI9 used by PLC Bit9=1: MI10 used by PLC Bit10=1: MI11 used by PLC Bit11=1: MI12 used by PLC	##	
04.25	The Analog Input Used by PLC (NOT for VFD*E*C models)	Read only. Bit0=1:AVI used by PLC Bit1=1:ACI/AVI2 used by PLC Bit2=1: AI1 used by PLC Bit3=1: AI2 used by PLC	##	
04.26	Display the Status of Multi-function Input Terminal	Read only. Bit0: MI1 Status Bit1: MI2 Status Bit2: MI3 Status Bit3: MI4 Status Bit4: MI5 Status Bit5: MI6 Status Bit6: MI7 Status Bit7: MI8 Status	##	

Pr.	Explanation	Settings	Factory Setting	NOTE
		Bit8: MI9 Status Bit9: MI10 Status Bit10: MI11 Status Bit11: MI12 Status		
04.27	Internal/External Multi-function Input Terminals Selection	0~4095	0	
↗04.28	Internal Terminal Status	0~4095	0	

Group 5 Multi-Step Speeds Parameters

↗05.00	1st Step Speed Frequency	0.00 to 600.0 Hz	0.00	
↗05.01	2nd Step Speed Frequency	0.00 to 600.0 Hz	0.00	
↗05.02	3rd Step Speed Frequency	0.00 to 600.0 Hz	0.00	
↗05.03	4th Step Speed Frequency	0.00 to 600.0 Hz	0.00	
↗05.04	5th Step Speed Frequency	0.00 to 600.0 Hz	0.00	
↗05.05	6th Step Speed Frequency	0.00 to 600.0 Hz	0.00	
↗05.06	7th Step Speed Frequency	0.00 to 600.0 Hz	0.00	
↗05.07	8th Step Speed Frequency	0.00 to 600.0 Hz	0.00	
↗05.08	9th Step Speed Frequency	0.00 to 600.0 Hz	0.00	
↗05.09	10th Step Speed Frequency	0.00 to 600.0 Hz	0.00	
↗05.10	11th Step Speed Frequency	0.00 to 600.0 Hz	0.00	
↗05.11	12th Step Speed Frequency	0.00 to 600.0 Hz	0.00	
↗05.12	13th Step Speed Frequency	0.00 to 600.0 Hz	0.00	
↗05.13	14th Step Speed Frequency	0.00 to 600.0 Hz	0.00	
↗05.14	15th Step Speed Frequency	0.00 to 600.0 Hz	0.00	

Group 6 Protection Parameters

06.00	Over-Voltage Stall Prevention	115/230V series: 330.0V to 410.0V 460V series: 660.0V to 820.0V 0.0: Disable over-voltage stall prevention	390.0V 780.0V	
06.01	Over-Current Stall Prevention during Accel	0:Disable 20 to 250%	170	
06.02	Over-Current Stall Prevention during Operation	0:Disable 20 to 250%	170	

Pr.	Explanation	Settings	Factory Setting	NOTE
06.03	Over-Torque Detection Mode (OL2)	0: Disabled 1: Enabled during constant speed operation. After the over-torque is detected, keep running until OL1 or OL occurs. 2: Enabled during constant speed operation. After the over-torque is detected, stop running. 3: Enabled during accel. After the over-torque is detected, keep running until OL1 or OL occurs. 4: Enabled during accel. After the over-torque is detected, stop running.	0	
✓06.04	Over-Torque Detection Level	10 to 200%	150	
06.05	Over-Torque Detection Time	0.1 to 60.0 sec	0.1	
06.06	Electronic Thermal Overload Relay Selection	0: Standard motor (self cooled by fan) 1: Special motor (forced external cooling) 2: Disabled	2	
06.07	Electronic Thermal Characteristic	30 to 600 sec	60	
06.08	Present Fault Record	0: No fault 1: Over current (oc) 2: Over voltage (ov) 3: IGBT Overheat (oH1) 4: Power Board Overheat (oH2) 5: Overload (oL) 6: Overload1 (oL1)	0	
06.09	Second Most Recent Fault Record	7: Motor over load (oL2) 8: External fault (EF) 9: Current exceeds 2 times rated current during accel.(ocA) 10: Current exceeds 2 times rated current during decel.(ocd) 11: Current exceeds 2 times rated current during steady state operation (ocn)		
06.10	Third Most Recent Fault Record	12: Ground fault (GFF) 13: Reserved 14: Phase-Loss (PHL) 15: Reserved 16: Auto Accel/Decel failure (CFA) 17: SW/Password protection (codE) 18: Power Board CPU WRITE failure (cF1.0) 19: Power Board CPU READ failure (cF2.0) 20: CC, OC Hardware protection failure (HPF1) 21: OV Hardware protection failure (HPF2) 22: GFF Hardware protection failure (HPF3) 23: OC Hardware protection failure (HPF4) 24: U-phase error (cF3.0) 25: V-phase error (cF3.1) 26: W-phase error (cF3.2)		

Pr.	Explanation	Settings	Factory Setting	NOTE
06.11	Fourth Most Recent Fault Record	27: DCBUS error (cF3.3) 28: IGBT Overheat (cF3.4) 29: Power Board Overheat (cF3.5) 30: Control Board CPU WRITE failure (cF1.1) 31: Control Board CPU WRITE failure (cF2.1)		
06.12	Fifth Most Recent Fault Record	32: ACI signal error (AErr) 33: Reserved 34: Motor PTC overheat protection (PtC1) 35-39: Reserved 40: Communication time-out error of control board and power board (CP10)		
Group 7 Motor Parameters				
07.00	Motor Rated Current (Motor 0)	30 %FLA to 120% FLA	FLA	
07.01	Motor No-Load Current (Motor 0)	0%FLA to 99% FLA	0.4*FLA	
↗07.02	Torque Compensation (Motor 0)	0.0 to 10.0	0.0	
↗07.03	Slip Compensation (Used without PG) (Motor 0)	0.00 to 10.00	0.00	
07.04	Motor Parameters Auto Tuning	0: Disable 1: Auto tuning R1 2: Auto tuning R1 + no-load test	0	
07.05	Motor Line-to-line Resistance R1 (Motor 0)	0~65535 mΩ	0	
07.06	Motor Rated Slip (Motor 0)	0.00 to 20.00 Hz	3.00	
07.07	Slip Compensation Limit	0 to 250%	200	
07.08	Torque Compensation Time Constant	0.01 ~10.00 Sec	0.30	
07.09	Slip Compensation Time Constant	0.05 ~10.00 sec	0.20	
07.10	Accumulative Motor Operation Time (Min.)	0 to 1439 Min.	0	
07.11	Accumulative Motor Operation Time (Day)	0 to 65535 Day	0	
07.12	Motor PTC Overheat Protection	0: Disable 1: Enable	0	
07.13	Input Debouncing Time of the PTC Protection	0~9999(*2ms)	100	
07.14	Motor PTC Overheat Protection Level	0.1~10.0V	2.4	

Pr.	Explanation	Settings	Factory Setting	NOTE
07.15	Motor PTC Overheat Warning Level	0.1~10.0V	1.2	
07.16	Motor PTC Overheat Reset Delta Level	0.1~5.0V	0.6	
07.17	Treatment of the Motor PTC Overheat	0: Warn and RAMP to stop 1: Warn and COAST to stop 2: Warn and keep running	0	
07.18	Motor Rated Current (Motor 1)	30 %FLA to 120% FLA	FLA	
07.19	Motor No-Load Current (Motor 1)	0%FLA to 99% FLA	0.4*FLA	
↗07.20	Torque Compensation (Motor 1)	0.0 to 10.0	0.0	
↗07.21	Slip Compensation (Used without PG) (Motor 1)	0.00 to 10.00	0.00	
07.22	Motor Line-to-line Resistance R1 (Motor 1)	0~65535 mΩ	0	
07.23	Motor Rated Slip (Motor 1)	0.00 to 20.00 Hz	3.00	
07.24	Motor Pole Number (Motor 1)	2 to 10	4	
07.25	Motor Rated Current (Motor 2)	30 %FLA to 120% FLA	FLA	
07.26	Motor No-Load Current (Motor 2)	0%FLA to 99% FLA	0.4*FLA	
↗07.27	Torque Compensation (Motor 2)	0.0 to 10.0	0.0	
↗07.28	Slip Compensation (Used without PG) (Motor 2)	0.00 to 10.00	0.00	
07.29	Motor Line-to-line Resistance R1 (Motor 2)	0~65535 mΩ	0	
07.30	Motor Rated Slip (Motor 2)	0.00 to 20.00 Hz	3.00	
07.31	Motor Pole Number (Motor 3)	2 to 10	4	
07.32	Motor Rated Current (Motor 3)	30 %FLA to 120% FLA	FLA	
07.33	Motor No-Load Current (Motor 3)	0%FLA to 99% FLA	0.4*FLA	
↗07.34	Torque Compensation (Motor 3)	0.0 to 10.0	0.0	
↗07.35	Slip Compensation (Used without PG) (Motor 3)	0.00 to 10.00	0.00	

Pr.	Explanation	Settings	Factory Setting	NOTE
07.36	Motor Line-to-line Resistance R1 (Motor 3)	0~65535 mΩ	0	
07.37	Motor Rated Slip (Motor 3)	0.00 to 20.00 Hz	3.00	
07.38	Motor Pole Number (Motor 3)	2 to 10	4	
Group 8 Special Parameters				
08.00	DC Brake Current Level	0 to 100%	0	
08.01	DC Brake Time during Start-Up	0.0 to 60.0 sec	0.0	
08.02	DC Brake Time during Stopping	0.0 to 60.0 sec	0.0	
08.03	Start-Point for DC Brake	0.00 to 600.0Hz	0.00	
08.04	Momentary Power Loss Operation Selection	0: Operation stops after momentary power loss 1: Operation continues after momentary power loss, speed search starts with the Master Frequency reference value 2: Operation continues after momentary power loss, speed search starts with the minimum frequency	0	
08.05	Maximum Allowable Power Loss Time	0.1 to 5.0 sec	2.0	
08.06	Base-block Speed Search	0: Disable speed search 1: Speed search starts with last frequency command 2: Starts with minimum output frequency	1	
08.07	B.B. Time for Speed Search	0.1 to 5.0 sec	0.5	
08.08	Current Limit for Speed Search	30 to 200%	150	
08.09	Skip Frequency 1 Upper Limit	0.00 to 600.0 Hz	0.00	
08.10	Skip Frequency 1 Lower Limit	0.00 to 600.0 Hz	0.00	
08.11	Skip Frequency 2 Upper Limit	0.00 to 600.0 Hz	0.00	
08.12	Skip Frequency 2 Lower Limit	0.00 to 600.0 Hz	0.00	
08.13	Skip Frequency 3 Upper Limit	0.00 to 600.0 Hz	0.00	
08.14	Skip Frequency 3 Lower Limit	0.00 to 600.0 Hz	0.00	
08.15	Auto Restart After Fault	0 to 10 (0=disable)	0	
08.16	Auto Reset Time at Restart after Fault	0.1 to 6000 sec	60.0	

Pr.	Explanation	Settings	Factory Setting	NOTE
08.17	Auto Energy Saving	0: Disable 1: Enable	0	
08.18	AVR Function	0: AVR function enable 1: AVR function disable 2: AVR function disable for decel. 3: AVR function disable for stop	0	
08.19	Software Brake Level	115V / 230V series: 370.0 to 430.0V 460V series: 740.0 to 860.0V	380.0 760.0	
↗08.20	Compensation Coefficient for Motor Instability	0.0~5.0	0.0	
08.21	OOB Sampling Time	0.1 to 120.0 sec	1.0	
08.22	Number of OOB Sampling Times	00 to 32	20	
08.23	OOB Average Sampling Angle	Read only	##	
08.24	DEB Function	0: Disable 1: Enable	0	
08.25	DEB Return Time	0 to 250 sec	0	

Group 9 Communication Parameters

↗09.00	Communication Address	1 to 254	1	
↗09.01	Transmission Speed	0: Baud rate 4800bps 1: Baud rate 9600bps 2: Baud rate 19200bps 3: Baud rate 38400bps	1	
↗09.02	Transmission Fault Treatment	0: Warn and keep operating 1: Warn and ramp to stop 2: Warn and coast to stop 3: No warning and keep operating	3	
↗09.03	Time-out Detection	0.1 ~ 120.0 seconds 0.0: Disable	0.0	
↗09.04	Communication Protocol	0: 7,N,2 (Modbus, ASCII) 1: 7,E,1 (Modbus, ASCII) 2: 7,O,1 (Modbus, ASCII) 3: 8,N,2 (Modbus, RTU) 4: 8,E,1 (Modbus, RTU) 5: 8,O,1 (Modbus, RTU) 6: 8,N,1 (Modbus, RTU) 7: 8,E,2 (Modbus, RTU) 8: 8,O,2 (Modbus, RTU) 9: 7,N,1 (Modbus, ASCII) 10: 7,E,2 (Modbus, ASCII) 11: 7,O,2 (Modbus, ASCII)	0	
09.05	Reserved			
09.06	Reserved			
↗09.07	Response Delay Time	0 ~ 200 (unit: 2ms)	1	

Pr.	Explanation	Settings	Factory Setting	NOTE
↗09.08	Transmission Speed for USB Card	0: Baud rate 4800 bps 1: Baud rate 9600 bps 2: Baud rate 19200 bps 3: Baud rate 38400 bps 4: Baud rate 57600 bps	2	
↗09.09	Communication Protocol for USB Card	0: 7,N,2 for ASCII 1: 7,E,1 for ASCII 2: 7,O,1 for ASCII 3: 8,N,2 for RTU 4: 8,E,1 for RTU 5: 8,O,1 for RTU 6: 8,N,1 (Modbus, RTU) 7: 8,E,2 (Modbus, RTU) 8: 8,O,2 (Modbus, RTU) 9: 7,N,1 (Modbus, ASCII) 10: 7,E,2 (Modbus, ASCII) 11: 7,O,2 (Modbus, ASCII)	1	
↗09.10	Transmission Fault Treatment for USB Card	0: Warn and keep operating 1: Warn and ramp to stop 2: Warn and coast to stop 3: No warning and keep operating	0	
↗09.11	Time-out Detection for USB Card	0.1 ~ 120.0 seconds 0.0: Disable	0.0	
09.12	COM port for PLC Communication (NOT for VFD*E*C models)	0: RS485 1: USB card	0	
09.13	CANopen Communication Address (ONLY for VFD*E*C models)	0: disable 1: 1 to 127	1	
09.14	CANbus Baud Rate (ONLY for VFD*E*C models)	0: 1M 1: 500K 2: 250K 3: 125K 4: 100K 5: 50K	5	
09.15	Gain of CANbus Frequency (ONLY for VFD*E*C models)	0.00~2.00	1.00	
09.16	CANbus Warning (ONLY for VFD*E*C models)	bit 0 : CANopen Guarding Time out bit 1 : CANopen Heartbeat Time out bit 2 : CANopen SYNC Time out bit 3 : CANopen SDO Time out bit 4 : CANopen SDO buffer overflow bit 5 : CAN Bus Off bit 6 : Error protocol of CANopen bit 7 : CANopen boot up fault	Read-only	

Group 10 PID Control Parameters

Pr.	Explanation	Settings	Factory Setting	NOTE
10.00	PID Set Point Selection	0: Disable PID operation 1: Keypad (based on Pr.02.00) 2: 0 to +10V from AVI 3: 4 to 20mA from ACI or 0 to +10V from AVI2 4: PID set point (Pr.10.11)	0	
10.01	Input Terminal for PID Feedback	0: Positive PID feedback from external terminal AVI (0 ~ +10VDC) 1: Negative PID feedback from external terminal AVI (0 ~ +10VDC) 2: Positive PID feedback from external terminal ACI (4 ~ 20mA)/ AVI2 (0 ~ +10VDC).	0	
10.01	Input Terminal for PID Feedback	3: Negative PID feedback from external terminal ACI (4 ~ 20mA)/ AVI2 (0 ~ +10VDC).	0	
↗10.02	Proportional Gain (P)	0.0 to 10.0	1.0	
↗10.03	Integral Time (I)	0.00 to 100.0 sec (0.00=disable)	1.00	
↗10.04	Derivative Control (D)	0.00 to 1.00 sec	0.00	
10.05	Upper Bound for Integral Control	0 to 100%	100	
10.06	Primary Delay Filter Time	0.0 to 2.5 sec	0.0	
10.07	PID Output Freq Limit	0 to 110%	100	
10.08	PID Feedback Signal Detection Time	0.0 to 3600 sec (0.0 disable)	60.0	
10.09	Treatment of the Erroneous PID Feedback Signals	0: Warn and RAMP to stop 1: Warn and COAST to stop 2: Warn and keep operation	0	
10.10	Gain Over the PID Detection Value	0.0 to 10.0	1.0	
↗10.11	Source of PID Set point	0.00 to 600.0Hz	0.00	
10.12	PID Offset Level	1.0 to 50.0%	10.0	
10.13	Detection Time of PID Offset	0.1 to 300.0 sec	5.0	
10.14	Sleep/Wake Up Detection Time	0.0 to 6550 sec	0.0	
10.15	Sleep Frequency	0.00 to 600.0 Hz	0.00	
10.16	Wakeup Frequency	0.00 to 600.0 Hz	0.00	
10.17	Minimum PID Output Frequency Selection	0: By PID control 1: By minimum output frequency (Pr.01.05)	0	

Group 11 Parameters for Extension Card

Pr.	Explanation	Settings	Factory Setting	NOTE
11.00	Multi-function Output Terminal MO2/RA2	0: No function 1: AC drive operational 2: Master frequency attained	0	
11.01	Multi-function Output Terminal MO3/RA3	3: Zero speed 4: Over torque detection 5: Base-Block (B.B.) indication 6: Low-voltage indication	0	
11.02	Multi-function Output Terminal MO4/RA4	7: Operation mode indication 8: Fault indication 9: Desired frequency 1 attained 10: Terminal count value attained 11: Preliminary count value attained 12: Over Voltage Stall supervision	0	
11.03	Multi-function Output Terminal MO5/RA5	13: Over Current Stall supervision 14: Heat sink overheat warning 15: Over Voltage supervision	0	
11.04	Multi-function Output Terminal MO6/RA6	16: PID supervision 17: Forward command 18: Reverse command	0	
11.05	Multi-function Output Terminal MO7/RA7	19: Zero speed output signal 20: Warning(FbE,Cexx, AoL2, AUE, SAVe) 21: Brake control (Desired frequency attained) 22: Drive ready 23: Desired frequency 2 attained	0	
11.06	Multi-function Input Terminal (MI7)	0: No function 1: Multi-Step speed command 1 2: Multi-Step speed command 2 3: Multi-Step speed command 3	0	
11.07	Multi-function Input Terminal (MI8)	4: Multi-Step speed command 4 5: External reset 6: Accel/Decel inhibit 7: Accel/Decel time selection command	0	
11.08	Multi-function Input Terminal (MI9)	8: Jog Operation 9: External base block 10: Up: Increment master frequency 11: Down: Decrement master frequency	0	
11.09	Multi-function Input Terminal (MI10)	12: Counter Trigger Signal 13: Counter reset 14: E.F. External Fault Input 15: PID function disabled 16: Output shutoff stop	0	
11.10	Multi-function Input Terminal (MI11)	17: Parameter lock enable 18: Operation command selection (external terminals) 19: Operation command selection (keypad) 20: Operation command selection	0	
11.11	Multi-function Input Terminal (MI12)	(communication) 21: FWD/REV command 22: Source of second frequency command 23: Run/Stop PLC Program (PLC1) (NOT for VFD*E*C models)	0	

Pr.	Explanation	Settings	Factory Setting	NOTE
		23: Quick Stop (Only for VFD*E*C models) 24: Download/execute/monitor PLC Program (PLC2) (NOT for VFD*E*C models) 25: Simple position function 26: OOB (Out of Balance Detection) 27: Motor selection (bit 0) 28: Motor selection (bit 1)		
Group 12: Analog Input/Output Parameters for Extension Card				
12.00	A11 Function Selection	0: Disabled 1: Source of the 1st frequency 2: Source of the 2nd frequency 3: PID Set Point (PID enable) 4: Positive PID feedback 5: Negative PID feedback	0	
12.01	A11 Analog Signal Mode	0: ACI2 analog current (0.0 ~ 20.0mA) 1: AVI3 analog voltage (0.0 ~ 10.0V)	1	
12.02	Min. AVI3 Input Voltage	0.0 to 10.0V	0.0	
12.03	Min. AVI3 Scale Percentage	0.0 to 100.0%	0.0	
12.04	Max. AVI3 Input Voltage	0.0 to 10.0V	10.0	
12.05	Max. AVI3 Scale Percentage	0.0 to 100.0%	100.0	
12.06	Min. ACI2 Input Current	0.0 to 20.0mA	4.0	
12.07	Min. ACI2 Scale Percentage	0.0 to 100.0%	0.0	
12.08	Max. ACI2 Input Current	0.0 to 20.0mA	20.0	
12.09	Max. ACI2 Scale Percentage	0.0 to 100.0%	100.0	
12.10	A12 Function Selection	0: Disabled 1: Source of the 1st frequency 2: Source of the 2nd frequency 3: PID Set Point (PID enable) 4: Positive PID feedback 5: Negative PID feedback	0	
12.11	A12 Analog Signal Mode	0: ACI3 analog current (0.0 ~ 20.0mA) 1: AVI4 analog voltage (0.0 ~ 10.0V)	1	
12.12	Min. AVI4 Input Voltage	0.0 to 10.0V	0.0	
12.13	Min. AVI4 Scale Percentage	0.0 to 100.0%	0.0	
12.14	Max. AVI4 Input Voltage	0.0 to 10.0V	10.0	
12.15	Max. AVI4 Scale Percentage	0.0 to 100.0%	100.0	
12.16	Min. ACI3 Input Current	0.0 to 20.0mA	4.0	
12.17	Min. ACI3 Scale Percentage	0.0 to 100.0%	0.0	

Pr.	Explanation	Settings	Factory Setting	NOTE
12.18	Max. ACI3 Input Current	0.0 to 20.0mA	20.0	
12.19	Max. ACI3 Scale Percentage	0.0 to 100.0%	100.0	
12.20	AO1 Terminal Analog Signal Mode	0: AVO1 1: ACO1 (analog current 0.0 to 20.0mA) 2: ACO1 (analog current 4.0 to 20.0mA)	0	
12.21	AO1 Analog Output Signal	0: Analog Frequency 1: Analog Current (0 to 250% rated current)	0	
12.22	AO1 Analog Output Gain	1 to 200%	100	
12.23	AO2 Terminal Analog Signal Mode	0: AVO2 1: ACO2 (analog current 0.0 to 20.0mA) 2: ACO2 (analog current 4.0 to 20.0mA)	0	
12.24	AO2 Analog Output Signal	0: Analog Frequency 1: Analog Current (0 to 250% rated current)	0	
12.25	AO2 Analog Output Gain	1 to 200%	100	

Group 13: PG function Parameters for Extension Card

13.00	PG Input	0: Disabled 1: Single phase 2: Forward/Counterclockwise rotation 3: Reverse/Clockwise rotation	0	
13.01	PG Pulse Range	1 to 20000	600	
13.02	Motor Pole Number (Motor 0)	2 to 10	4	
↗ 13.03	Proportional Gain (P)	0.0 to 10.0	1.0	
↗ 13.04	Integral Gain (I)	0.00 to 100.00 sec	1.00	
↗ 13.05	Speed Control Output Frequency Limit	0.00 to 100.00Hz	10.00	
↗ 13.06	Speed Feedback Display Filter	0 to 9999 (*2ms)	500	
↗ 13.07	Detection Time for Feedback Signal Fault	0.0: disabled 0.1 to 10.0 sec	1	
↗ 13.08	Treatment of the Feedback Signal Fault	0: Warn and RAMP to stop 1: Warn and COAST to stop 2: Warn and keep operation	1	
↗ 13.09	Speed Feedback Filter	0 to 9999 (*2ms)	16	
13.10	Source of the High-speed Counter	0: PG card 1: PLC (NOT for VFD*E*C models)	Read Only	

Fault Codes

Fault Name	Fault Descriptions	Corrective Actions
LU	Low voltage The AC motor drive detects that the DC bus voltage has fallen below its minimum value.	<ol style="list-style-type: none"> 1. Check whether the input voltage falls within the AC motor drive rated input voltage range. 2. Check whether the motor has sudden load. 3. Check for correct wiring of input power to R-S-T (for 3-phase models) without phase loss.
OC	Over current Abnormal increase in current.	<ol style="list-style-type: none"> 1. Check if motor power corresponds with the AC motor drive output power. 2. Check the wiring connections to U/T1, V/T2, W/T3 for possible short circuits. 3. Check the wiring connections between the AC motor drive and motor for possible short circuits, also to ground. 4. Check for loose contacts between AC motor drive and motor. 5. Increase the Acceleration Time. 6. Check for possible excessive loading conditions at the motor. 7. If there are still any abnormal conditions when operating the AC motor drive after a short-circuit is removed and the other points above are checked, it should be sent back to manufacturer.
OV	Over voltage The DC bus voltage has exceeded its maximum allowable value.	<ol style="list-style-type: none"> 1. Check if the input voltage falls within the rated AC motor drive input voltage range. 2. Check for possible voltage transients. 3. DC-bus over-voltage may also be caused by motor regeneration. Either increase the Decel. Time or add an optional brake resistor (and brake unit). 4. Check whether the required brake power is within the specified limits.
OH1 OH2	Overheating Heat sink temperature too high	<ol style="list-style-type: none"> 1. Ensure that the ambient temperature falls within the specified temperature range. 2. Make sure that the ventilation holes are not obstructed. 3. Remove any foreign objects from the heatsinks and check for possible dirty heat sink fins. 4. Check the fan and clean it. 5. Provide enough spacing for adequate ventilation.
OL	Overload The AC motor drive detects excessive drive output current. NOTE: The AC motor drive can withstand up to 150% of the rated current for a maximum of 60 seconds.	<ol style="list-style-type: none"> 1. Check whether the motor is overloaded. 2. Reduce torque compensation setting in Pr.07.02. 3. Take the next higher power AC motor drive model.
OL1	Overload 1 Internal electronic overload trip	<ol style="list-style-type: none"> 1. Check for possible motor overload. 2. Check electronic thermal overload setting. 3. Use a higher power motor. 4. Reduce the current level so that the drive output current does not exceed the value set by the Motor Rated Current Pr.07.00.

Fault Name	Fault Descriptions	Corrective Actions
<i>OL2</i>	Overload 2 Motor overload.	<ol style="list-style-type: none"> 1. Reduce the motor load. 2. Adjust the over-torque detection setting to an appropriate setting (Pr.06.03 to Pr.06.05).
<i>codE</i>	Software protection failure	Return to the factory.
<i>HPF1</i>	CC (current clamp)	Return to the factory.
<i>HPF2</i>	OV hardware error	
<i>HPF3</i>	GFF hardware error	
<i>HPF4</i>	OC hardware error	
<i>bb</i>	External Base Block. (Refer to Pr. 08.07)	<ol style="list-style-type: none"> 1. When the external input terminal (B.B) is active, the AC motor drive output will be turned off. 2. Deactivate the external input terminal (B.B) to operate the AC motor drive again.
<i>EF</i>	External Fault	<ol style="list-style-type: none"> 1. When multi-function input terminals (MI3-MI9) are set to external fault, the AC motor drive stops output U, V and W. 2. Give RESET command after fault has been cleared.
<i>ocA</i>	Over-current during acceleration	<ol style="list-style-type: none"> 1. Short-circuit at motor output: Check for possible poor insulation at the output lines. 2. Torque boost too high: Decrease the torque compensation setting in Pr.07.02. 3. Acceleration Time too short: Increase the Acceleration Time. 4. AC motor drive output power is too small: Replace the AC motor drive with the next higher power model.
<i>ocd</i>	Over-current during deceleration	<ol style="list-style-type: none"> 1. Short-circuit at motor output: Check for possible poor insulation at the output line. 2. Deceleration Time too short: Increase the Deceleration Time. 3. AC motor drive output power is too small: Replace the AC motor drive with the next higher power model.
<i>ocn</i>	Over-current during steady state operation	<ol style="list-style-type: none"> 1. Short-circuit at motor output: Check for possible poor insulation at the output line. 2. Sudden increase in motor loading: Check for possible motor stall. 3. AC motor drive output power is too small: Replace the AC motor drive with the next higher power model.
<i>cF10</i>	Internal EEPROM can not be programmed.	Return to the factory.
<i>cF11</i>	Internal EEPROM can not be programmed.	Return to the factory.
<i>cF20</i>	Internal EEPROM can not be read.	<ol style="list-style-type: none"> 1. Press RESET key to set all parameters to factory setting. 2. Return to the factory.
<i>cF21</i>	Internal EEPROM can not be read.	<ol style="list-style-type: none"> 1. Press RESET key to set all parameters to factory setting. 2. Return to the factory.

Fault Name	Fault Descriptions	Corrective Actions
<i>cFA</i>	Auto accel/decel failure	<ol style="list-style-type: none"> 1. Check if the motor is suitable for operation by AC motor drive. 2. Check if the regenerative energy is too large. 3. Load may have changed suddenly.
<i>cF30</i>	U-phase error	Return to the factory.
<i>cF31</i>	V-phase error	
<i>cF32</i>	W-phase error	
<i>cF33</i>	OV or LV	
<i>cF34</i> <i>cF35</i>	Temperature sensor error	
<i>FbE</i>	PID feedback signal error	<ol style="list-style-type: none"> 1. Check parameter settings (Pr.10.01) and AVI/ACI wiring. 2. Check for possible fault between system response time and the PID feedback signal detection time (Pr.10.08)
<i>RErr</i>	Analog signal error	Check the wiring of ACI
<i>PHL</i>	Phase Loss	Check Power Source Input if all 3 input phases are connected without loose contacts.
<i>OFF</i>	Ground fault	<p>When (one of) the output terminal(s) is grounded, short circuit current is more than 50% of AC motor drive rated current, the AC motor drive power module may be damaged.</p> <p>NOTE: The short circuit protection is provided for AC motor drive protection, not for protection of the user.</p> <ol style="list-style-type: none"> 1. Check whether the IGBT power module is damaged. 2. Check for possible poor insulation at the output line.
<i>CE--</i>	Communication Error	<ol style="list-style-type: none"> 1. Check the RS485 connection between the AC motor drive and RS485 master for loose wires and wiring to correct pins. 2. Check if the communication protocol, address, transmission speed, etc. are properly set. 3. Use the correct checksum calculation. 4. Please refer to group 9 in the chapter 5 for detail information.
<i>AUE</i>	Auto Tuning Error	<ol style="list-style-type: none"> 1. Check cabling between drive and motor 2. Retry again
<i>CP10</i>	Communication time-out error on the control board or power board	<ol style="list-style-type: none"> 1. Press RESET key to set all parameters to factory setting. 2. Return to the factory.
<i>PtC1</i> <i>PtC2</i>	Motor overheat protection	<ol style="list-style-type: none"> 1. Check if the motor is overheat 2. Check Pr.07.12 to Pr.07.17 settings
<i>PGEr</i>	PG signal error	<ol style="list-style-type: none"> 1. Check the wiring of PG card 2. Try another PG card
<i>COUd</i>	CANopen Guarding Time out (Only for VFDxxxExxC)	Connect to CAN bus again and reset CAN bus
<i>CHbt</i>	CANopen Heartbeat Time out (Only for VFDxxxExxC)	Connect to CAN bus again and reset CAN bus

Fault Name	Fault Descriptions	Corrective Actions
C54c	CANopen SYNC Time out (Only for VFDxxxExxC)	Check if CANopen synchronous message is abnormal
C5d0	CANopen SDO Time out (Only for VFDxxxExxC)	Check if command channels are full
C5bF	CANopen SDO buffer overflow (Only for VFDxxxExxC)	1. Too short time between commands, please check SDO message sent from the master Reset CAN bus 2.
C65F	CAN bus off (Only for VFDxxxExxC)	1. Check if it connects to terminal resistor 2. Check if the signal is abnormal 3. Check if the master is connected
CbtU	CAN Boot up fault (Only for VFDxxxExxC)	1. Check if the master is connected 2. Reset CAN bus
Cpt0	Error communication protocol of CANopen (Only for VFDxxxExxC)	Check if the communication protocol is correct

Dimensions are in mm [inch]

Frame A

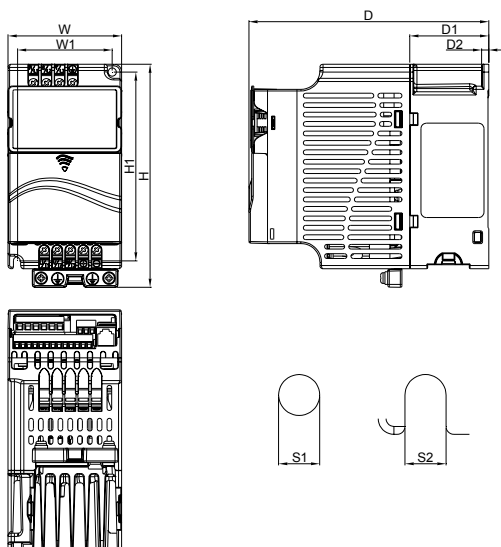

Unit: mm [inch]

Frame	W	W1	H	H1	D	D1	D2	S1	S2
A (A1)	72.0 [2.83]	60.0 [2.36]	142.0 [5.59]	120.0 [4.72]	152.0 [5.98]	50.0 [1.97]	4.5 [0.18]	5.2 [0.20]	5.2 [0.20]
A (A2)	72.0 [2.83]	56.0 [2.20]	155.0 [6.10]	143.0 [5.63]	111.5 [4.39]	9.5 [0.37]	-	5.3 [0.21]	-



Frame A (A1): VFD002E11A/21A/23A, VFD004E11A/21A/23A/43A, VFD007E21A/23A/43A, VFD015E23A/43A, VFD002E11C/21C/23C, VFD004E11C/21C/23C/43C, VFD007E21C/23C/43C, VFD015E23C/43C, VFD002E11T/21T/23T, VFD004E11T/21T/23T/43T, VFD007E21T/23T/43T, VFD015E23T/43T

Frame A (A2): VFD002E11P/21P/23P, VFD004E11P/21P/23P/43P, VFD007E21P/23P/43P, VFD015E23P/43P

Frame B

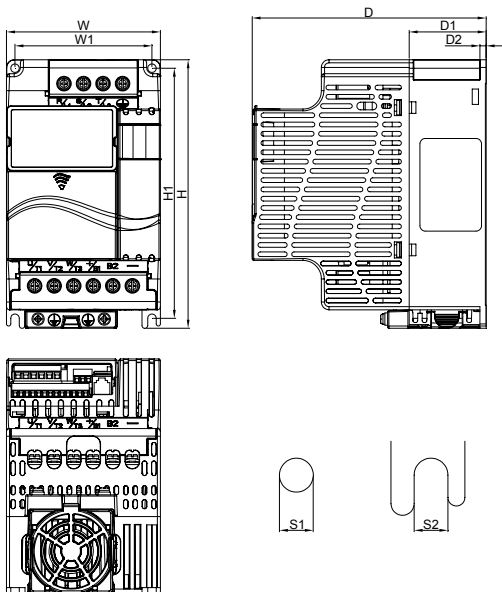

Unit: mm [inch]

Frame	W	W1	H	H1	D	D1	D2	S1	S2
B1	100.0 [3.94]	89.0 [3.50]	174.0 [6.86]	162.0 [6.38]	152.0 [5.98]	50.0 [1.97]	4.0 [0.16]	5.5 [0.22]	5.5 [0.22]



Frame B (B1): VFD007E11A, VFD015E21A, VFD022E21A/23A/43A, VFD037E23A/43A, VFD007E11C, VFD015E21C, VFD022E21C/23C/43C, VFD037E23C/43C

Frame C

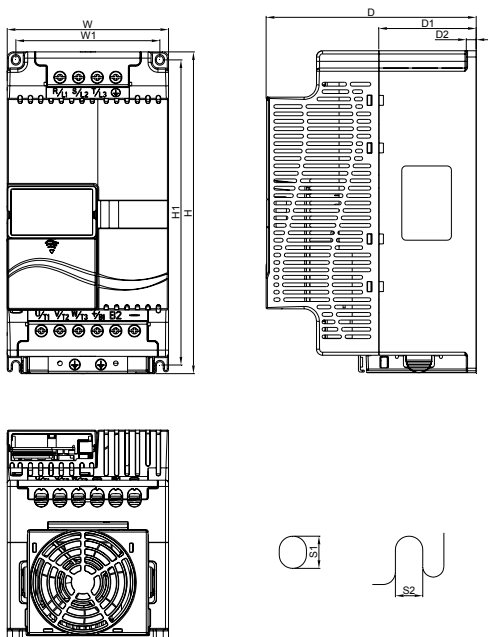

Unit: mm [inch]

Frame	W	W1	H	H1	D	D1	D2	S1	S2
C1	130.0 [5.12]	116.0 [4.57]	260.0 [10.24]	246.5 [9.70]	169.2 [6.66]	78.5 [3.09]	8.0 [0.31]	6.5 [0.26]	5.5 [0.22]



Frame C (C1): VFD055E23A/43A, VFD075E23A/43A, VFD110E43A/43C, VFD055E23C/43C,
VFD075E23C/43C

Free Manuals Download Website

<http://myh66.com>

<http://usermanuals.us>

<http://www.somanuals.com>

<http://www.4manuals.cc>

<http://www.manual-lib.com>

<http://www.404manual.com>

<http://www.luxmanual.com>

<http://aubethermostatmanual.com>

Golf course search by state

<http://golfingnear.com>

Email search by domain

<http://emailbydomain.com>

Auto manuals search

<http://auto.somanuals.com>

TV manuals search

<http://tv.somanuals.com>