

Dell PowerVault MD3860f Series Storage Arrays Deployment Guide



註、警示與警告



註: 「註」表示可以幫助您更有效地使用電腦的重要資訊。



警示: 「警示」表示有可能會損壞硬體或導致資料遺失, 並告訴您如何避免發生此類問題。



警告: 「警告」表示有可能會導致財物損失、人身傷害甚至死亡。

Copyright © 2015 Dell Inc. 著作權所有, 並保留一切權利。本品受美國與國際著作權及智慧財產法保護。Dell™ 與 Dell 徽標是 Dell Inc. 在美國和/或其他司法管轄區的商標。本文提及的所有其他標誌與名稱皆屬於其個別公司的商標。

2015 - 02

修正版 A01

Contents

1 Introduction.....	5
System Requirements.....	5
Management Station Requirements.....	5
Introduction To Storage Arrays.....	5
Related Documentation.....	6
Contacting Dell.....	7
Documentation feedback.....	7
2 Hardware Installation.....	8
Planning The Storage Configuration	8
Connecting The Storage Array	8
Configuring Fibre Channel With Dell MD Series Storage Arrays.....	9
Configuring Fibre Channel On SAN Attached Storage Arrays.....	9
Configuring Fibre Channel.....	9
Other Information You May Need.....	10
Installing Supported Fibre Channel HBAs.....	10
Installing Fibre Channel HBA On Your Host Server.....	10
Using Fibre Channel Switch Zoning.....	10
World Wide Name Zoning.....	11
Switch Zoning Guidelines.....	12
Setting Up Zoning On The Fibre Channel Switch Hardware.....	12
Cabling The Storage Array	12
Redundant And Non-Redundant Cabling.....	12
SAN-Attached Cabling.....	13
SAN-Attached Cabling Example.....	13
Remote Replication Cabling Example.....	15
Mixed Environment.....	17
Cabling PowerVault MD3060e Expansion Enclosures.....	18
MD3060e Expansion cabling diagrams.....	19
Expanding With New PowerVault MD3060e Expansion Enclosures.....	20
3 Installing MD Storage Manager.....	22
Installing Host Bus Adapters And Drivers.....	23
Graphical Installation (Recommended).....	23
Console Installation	24
Silent Installation	24
Silent Installation On Windows.....	24
Silent Installation On Linux.....	24

Enabling Premium Features (Optional).....	25
Upgrading PowerVault MD Storage Manager.....	25
4 Post Installation Tasks.....	26
Verifying Storage Array Discovery.....	26
Initial Setup Tasks.....	27
5 Uninstalling MD Storage Manager.....	28
Uninstalling MD Storage Manager From Windows.....	28
Uninstall MD Storage Manager From Windows Server GUI Version.....	28
Uninstall MD Storage Manager From Windows Server Core Versions.....	28
Uninstalling MD Storage Manager From Linux.....	29
6 Load Balancing.....	30
Load Balance Policy.....	30
Round Robin With Subset.....	30
Least Queue Depth.....	30
Least Path Weight.....	30
Setting Load Balance Policies in Linux.....	31
Setting Load Balance Policies in VMware.....	31
7 Appendix — Working With SFP Modules And Fiber Optic Cables.....	32
Guidelines For Using SFP Modules.....	32
Installing SFP Modules.....	32
Removing SFP Modules.....	33
Guidelines For Using Fibre Optic Cables.....	33
Installing Fibre Channel Cables.....	34
Removing Fibre Channel Cables.....	34
8 Appendix — Hardware Cabling Best Practices.....	35
Handling Static Sensitive Components.....	35
Host Cabling For Remote Replication.....	35
Cabling For Performance.....	35
Labeling Cables.....	36

Introduction

This guide provides information about deploying Dell PowerVault MD3860f storage arrays. The deployment process includes:

- Hardware installation
- Modular Disk Storage Manager (MD Storage Manager) installation
- Initial system configuration

Other information provided include system requirements, storage array organization, and utilities.

 **NOTE:** For more information on product documentation, see [Related Documentation](#).

MD Storage Manager enables an administrator to configure and monitor storage arrays for optimum usability. The version of MD Storage Manager included on the PowerVault MD Series resource media can be used to manage both the PowerVault MD3860f Series and other PowerVault MD Series storage arrays. MD Storage Manager is compatible with both Microsoft Windows and Linux operating systems.

System Requirements

Before installing and configuring the PowerVault MD3860f Series hardware and software, ensure that the supported operating system is installed and minimum system requirements are met. For more information, see the Support Matrix at dell.com/powervaultmanuals.

Management Station Requirements

A management station uses MD Storage Manager to configure and manage storage arrays across the network. For more information on management station requirements, see the Support Matrix at dell.com/powervaultmanuals.

Introduction To Storage Arrays

An enclosure containing physical disks accessed through RAID controller modules is called a storage array. A storage array includes various hardware components, such as physical disks, RAID controller modules, fans, and power supplies.

One or more host servers attached to the storage array can access the data on the storage array. You can also establish multiple physical paths between the host(s) and the storage array so that loss of any single path (for example, through failure of a host server port) does not result in loss of access to data on the storage array.

The storage array is managed by MD Storage Manager running on a:

- Host server — On a host server system, MD Storage Manager and the storage array communicate management requests and event information using in-band or out-of-band connections.
- Management station — On a management station, MD Storage Manager communicates with the storage array either through an Ethernet connection to the storage array management port or through an Ethernet connection to a host server. The Ethernet connection passes management information between the management station and the storage array using array connectivity.

Using MD Storage Manager, you can configure the physical disks in the storage array into logical components called disk groups and Dynamic Disk Pool (DDP), then divide the disk groups into virtual disks. Disk groups are created in the unconfigured capacity of a storage array. Virtual disks are created in the free capacity of a disk group.

Unconfigured capacity comprises physical disks not already assigned to a disk group or DDP. When a virtual disk is created using unconfigured capacity, a disk group is automatically created. If the only virtual disk in a disk group is deleted, the disk group is also deleted. Free capacity is space in a disk group that is not assigned to any virtual disk.

Data is written to the physical disks in the storage array using RAID technology. RAID levels define the way in which data is written to physical disks. Different RAID levels offer different levels of accessibility, redundancy, and capacity. You can set a specified RAID level for each disk group and virtual disk on your storage array. For more information about using RAID and managing data in your storage solution, see the *Dell PowerVault MD Series Storage Arrays Administrator's Guide* at dell.com/powervaultmanuals.

Related Documentation

 **NOTE:** For all PowerVault documentation, go to dell.com/powervaultmanuals and enter the system Service Tag to get your system documentation.

 **NOTE:** For all Dell OpenManage documents, go to dell.com/openmanagemanuals.

 **NOTE:** For all storage controller documents, go to dell.com/storagecontrollermanuals.

Your product documentation includes:

- *Dell PowerVault MD3460/MD3860i/MD3860f Storage Arrays Getting Started Guide* — Provides an overview of system features, setting up your system, and technical specifications. This document is also shipped with your system.
- *Dell PowerVault MD3860f Storage Arrays Owner's Manual* — Provides information about system features and describes how to troubleshoot the system and install or replace system components.
- Rack Installation Instructions — Describes how to install your system into a rack. This document is also shipped with your rack solution.
- *Dell PowerVault MD Series Storage Arrays Administrator's Guide* — Provides information about configuring and managing the system using the MDSM GUI.
- *Dell PowerVault Modular Disk Storage Arrays CLI Guide* — Provides information about configuring and managing the system using the MDSM CLI.
- *Dell PowerVault MD3860f Storage Arrays Deployment Guide* — Provides information about deploying the storage system in the SAN architecture.
- *Dell PowerVault MD Series Support Matrix* — Provides information about the software and hardware compatibility matrices for the storage array.

Contacting Dell

 **NOTE:** If you do not have an active Internet connection, you can find the contact information on your purchase invoice, packing slip, bill, or Dell product catalog.

Dell provides several online and telephone-based support and service options. Availability varies by country and product, and some services may not be available in your area. To contact Dell for sales, technical support, or customer service issues:

Go to dell.com/contactdell.

Documentation feedback

If you have feedback for this document, write to documentation_feedback@dell.com. Alternatively, you can click on the **Feedback** link in any of the Dell documentation pages, fill out the form, and click **Submit** to send your feedback.

Hardware Installation

Before using this guide, ensure that you review the instructions in the:

- *Dell PowerVault MD3460/MD3860i/MD3860f Storage Arrays Getting Started Guide* – The Getting Started Guide that is shipped with the storage array provides information to configure the initial setup of the system.
- *Dell PowerVault MD Series Storage Arrays Administrator's Guide* – The Administrator's Guide provides information about important concepts you must know before setting up your storage solution. For more information, see dell.com/powervaultmanuals.
- The Rack Installation instructions – Provides information on how to rack your system. This document is shipped with your system.

Planning The Storage Configuration

Consider the following before installing your storage array:

- Evaluate data storage needs and administrative requirements.
- Calculate availability requirements.
- Decide the frequency and level of backups, such as weekly full backups with daily partial backups.
- Consider storage array options, such as password protection and e-mail alert notifications for error conditions.
- Design the configuration of virtual disks, disk groups, and DDP according to a data organization plan. For example, use one virtual disk for inventory, a second for financial and tax information, and a third for customer information.
- Decide whether to allow space for hot spares, which automatically replace failed physical disks.

Connecting The Storage Array

The storage array is connected to a host using two hot-swappable RAID controller modules. The RAID controller modules are identified as RAID controller module 0 and RAID controller module 1. The ports on the RAID controller module and their functions are listed below:

- 16 Gbps Fibre channel Host Ports (4) – Provides FC connection to the host or node.
 - **NOTE:** When you connect a host server to a storage array FC IN port connector, any OUT port connector of the host bus adapter (HBA) of the server can be used.
- 1 Gbps Ethernet Management (MGMT) Port (1) – Management port allows for out-of-band management of storage array.
- Reserved Ethernet Port (1) – Reserved port.
- 12 Gbps SAS host Ports (2) – Additional SAS Host ports.

- SAS host Expansion Ports (2) – Allows you to connect the storage array to optional PowerVault MD3060e expansion enclosures for additional storage capacity. Only one SAS OUT expansion port can be used at a time and the recommended expansion port is 0.

Configuring Fibre Channel With Dell MD Series Storage Arrays

This section provides information about configuring Fibre Channel communication between the host server and the storage array. For basic setup information such as racking, power cabling, and recommended handling procedures, see the *Getting Started Guide* for your Storage Array at dell.com/powervaultmanuals.

Configuring Fibre Channel On SAN Attached Storage Arrays

You can only cable the host server to the storage array via storage area network (SAN) using supported Fibre Channel switch(es).

 **NOTE:** For detailed information on supported Fibre Channel hardware, see the Support Matrix at dell.com/powervaultmanuals.

The following steps show the configuration order for connecting to a SAN. These steps assume you are setting up Fibre Channel storage for the first time.

 **NOTE:** If you are adding an additional Fibre Channel storage array or if your host server is already configured to access Fibre Channel storage, some of the steps may not apply. Before proceeding, see the *Dell PowerVault MD Series Support Matrix* to confirm that your existing hardware components and host bus adapter (HBA) firmware and BIOS levels are supported.

Configuring Fibre Channel

To configure a Fibre Channel for connecting to a SAN:

1. Install the supported HBAs on your host server.
2. Cable the host server to the Fibre Channel switches.

For more information, see [SAN-Attached Cabling Example](#) and [Remote Replication Cabling Example](#).
3. Install the required HBA drivers and firmware versions listed in the *Dell PowerVault MD Series Support Matrix* available at dell.com/powervaultmanuals.
4. Install and configure the MD Storage Manager software (included with your storage array) on your host server.
5. Cable the storage array to the Fibre Channel switches.
6. Configure zoning on all Fibre Channel switches.

For more information, see [Switch Zoning Guidelines](#).
7. Using MDSM, configure the host servers, storage arrays, and virtual disks.
8. Activate and configure premium features (if applicable).

 **NOTE:** All equipment attached to the switch must be powered on before establishing zoning. For additional switch hardware requirements, see the manufacturer's documentation.

Other Information You May Need

In addition to this document, see the documentation provided with the HBA and Fibre Channel switch hardware for vendor-specific information required to complete Fibre-Channel setup on your storage array.

Installing Supported Fibre Channel HBAs

The storage array supports a specific set of Fibre Channel HBAs, each requiring a unique driver and firmware level. See the *Dell PowerVault MD Series Support Matrix* at dell.com/powervaultmanuals for a list of supported HBAs.

If an HBA is already installed on your host server, verify that it is supported in the *Dell PowerVault MD Series Support Matrix*. If the HBA is not listed, it should not be used to connect to the storage array.

 **CAUTION:** Connecting the storage array to a non-supported host server HBA or installing non-qualified HBA drivers or firmware can cause instability or loss of access to your data.

Installing Fibre Channel HBA On Your Host Server

For instructions about physically installing an HBA in your host server and loading supported drivers and firmware, see the documentation supplied with your HBA hardware.

 **NOTE:** During installation you must enter the manufacturer-specific timeout and/or node time values. See the *Dell PowerVault MD Series Support Matrix* at dell.com/powervaultmanuals for information related to your specific HBA.

Using Fibre Channel Switch Zoning

A Fibre Channel switch allows you to connect multiple devices to the SAN without compromising bandwidth or data throughput. Switch zoning implemented on each Fibre Channel switch hardware component using the manufacturer's embedded utility, allows you to divide port traffic between the host server and storage array to maintain the highest level of redundancy.

The following figure shows each connection to the host server(s) routed to an individual logical zone on the SAN. Two physical switches provide an alternate (redundant) data path to the storage array. If a single HBA, switch or RAID controller fails, the host server(s) can still access data on the storage array through one of the alternate paths provided by the switches.

 **NOTE:** For a list of supported Fibre Channel switches, see the *Dell PowerVault MD Series Support Matrix* at dell.com/powervaultmanuals.

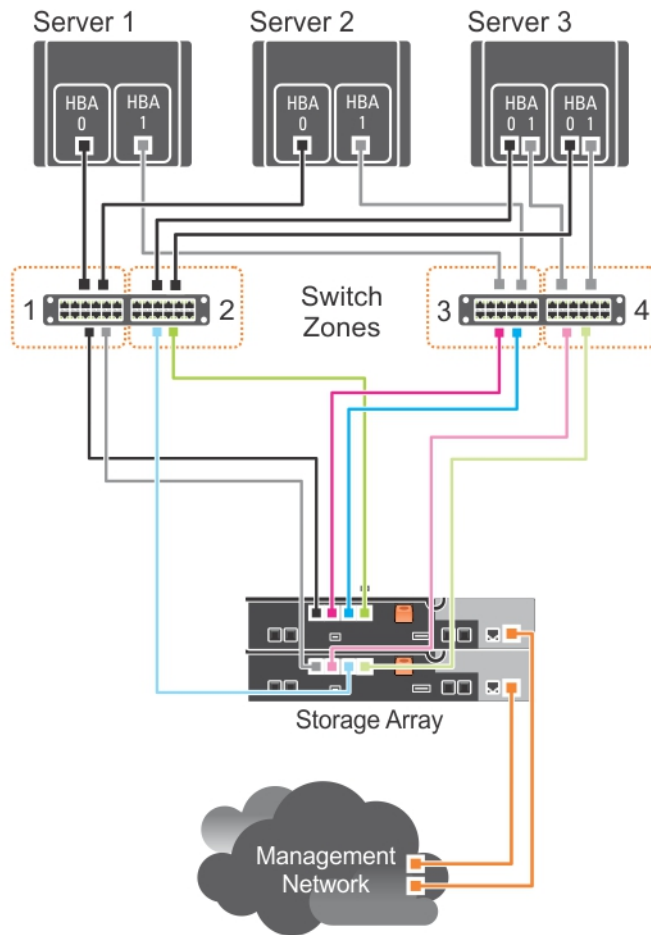

Figure 1. Example of Switch Zoning on SAN on an MD38xxf-series Fibre-Channel Storage Array

World Wide Name Zoning

There are several different switch zoning techniques used across various SANs. When configuring zoning with your storage array, using a 64 bit World Wide Name (WWN) to uniquely identify each component in your Fibre Channel switch fabric is recommended. An advantage of using WWN port zoning (also called *soft zoning*) is that it allows you to remove and/or replace cabling to and from the fabric without reconfiguring the existing zone logic.

When implemented on the Fibre Channel switch, port WWN zoning causes the host server to query the World Wide Identifier (WWID) name of all attached physical disks and/or expansion enclosures each time it accesses the switch fabric. By zoning specific ports on the host server(s), switch and storage array

together, the switch allows the host server to see only devices included in that zone, decreasing the amount of time it would otherwise take for the host server to query attached, but out-of-zone, devices.

Switch Zoning Guidelines

The storage array imposes specific requirements that must be followed when setting up Fibre Channel switch zoning:

- If a Fibre Channel switch is used to connect your host server and storage array, it must be zoned. Un-zoned or open switches cannot be used.
- WWN port zoning is recommended. While *hard zoning* (zoning by device ID) is supported, LUN masking uses the WWN identifier. You can mix WWN and hard-zoned ports in the same zone.
- Multi-port HBAs are supported. Each port in a multiple-port HBA represents one initiator. Each initiator must be connected to a single logical switch zone.
- No more than four paths (port-to-port segments) can be established from a single, physical host server(s) to a single RAID controller.
- A zone can contain multiple targets and span multiple storage arrays (single initiator can point to multiple targets).



NOTE: To simplify troubleshooting, you can assign a single initiator and single target to a zone.

- If the Remote Replication premium feature is activated, a separate zone for each replication port is required. Only data traffic related to Remote Replication can move through that zone. For more details and requirements regarding Remote Replication, see the *Dell PowerVault MD Series Storage Arrays Administrator's Guide* at dell.com/powervaultmanuals.

Setting Up Zoning On The Fibre Channel Switch Hardware

Setting up zoning on Fibre Channel switches varies greatly between manufacturers. For detailed information on how to set up zoning on your switch, see the manufacturer's product documentation or technical support website.

Cabling The Storage Array

Cabling the storage array depends on a number of factors such as:

- Required level of redundancy or throughput
- Number of host servers connected to the storage array
- Type of HBAs (dual- or single-port) used in the host server(s)
- Remote Replication premium feature (if applicable)

The cabling diagrams shown here do not represent every supported cabling scenario but the concepts of redundancy and switch logic can be used to build your own configuration.

Redundant And Non-Redundant Cabling

Non-redundant cabling configurations provide a single data path from host server(s) to the storage array. This type of configuration is only recommended for non-critical data storage. A path failure from a failed or removed cable, failed HBA, or failed or removed RAID controller module results in loss of host access to the storage array.

Redundant configurations establish separate data paths between the host server(s) and storage array. Each path is connected to separate RAID controller modules in the storage array. Redundancy protects

the host server(s) from losing access to data in the event of a path failure since both RAID controller modules can independently access all the physical disks in the storage array.

SAN-Attached Cabling

SAN-attached cabling configurations provide the highest level of redundancy and alternate-path connectivity between the host server and storage array. A SAN configuration using a Fibre Channel compatible switch fabric allows you to establish multiple redundant paths to data on the storage array.

 **NOTE:** A SAN configuration using a supported Fibre Channel switch hardware is required if the Remote Replication premium feature is activated on the storage array. For specific cabling requirements for Remote Replication, see Remote Replication Cabling Example.

SAN-Attached Cabling Example

The following figure shows a three-server, mixed HBA cabling configuration that uses two separate switch fabrics to establish multiple paths to the storage array. Port-to-port connections in each switch fabric/zone are detailed in the text boxes.

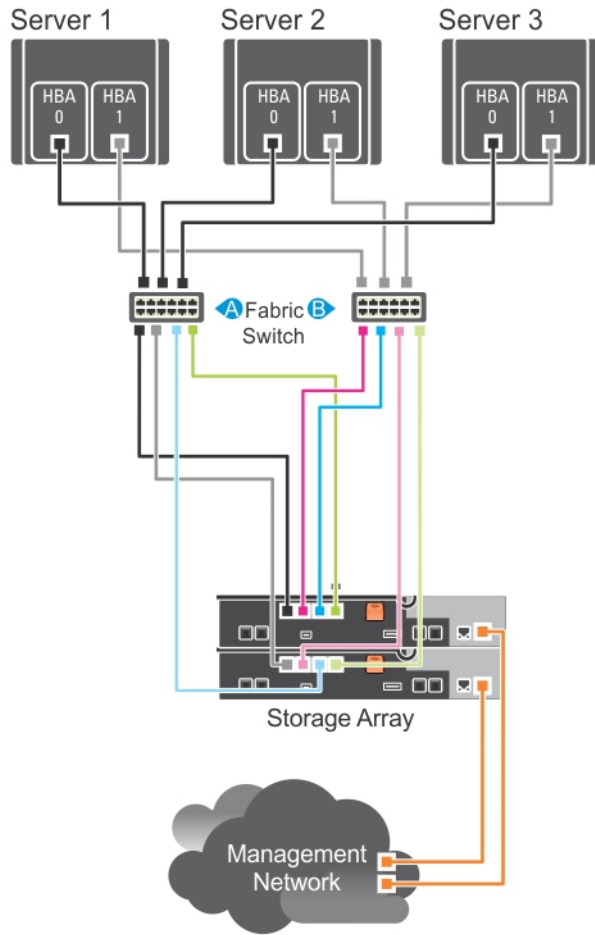

Figure 2. Three SAN-Attached Host Servers Connected to a Storage Array Using Multiple Paths

Switch Fabric A	Switch Fabric B
Zone1_Server1_HBA_0	Zone4_Server1_HBA_1
Server1_HBA_0	Server1_HBA_1
Array1_Ctrl-0-0	Array1_Ctrl-0-1
Array1_Ctrl-0-3	Array1_Ctrl-0-2
Array1_Ctrl-1-0	Array1_Ctrl-1-1
Array1_Ctrl-1-2	Array1_Ctrl-1-3
Zone2_Server2_HBA_0	Zone5_Server2_HBA_1

Switch Fabric A	Switch Fabric B
Server2_HBA_0	Server2_HBA_1
Array1_Ctrl-0-0	Array1_Ctrl-0-1
Array1_Ctrl-0-3	Array1_Ctrl-0-2
Array1_Ctrl-1-0	Array1_Ctrl-1-1
Array1_Ctrl-1-2	Array1_Ctrl-1-3
Zone3_Server3_HBA_0	Zone6_Server3_HBA_1
Server3_HBA_0	Server3_HBA_1
Array1_Ctrl-0-0	Array1_Ctrl-0-1
Array1_Ctrl-0-3	Array1_Ctrl-0-2
Array1_Ctrl-1-0	Array1_Ctrl-1-1
Array1_Ctrl-1-2	Array1_Ctrl-1-3

Remote Replication Cabling Example

Remote Replication is a storage array premium feature that provides online, real-time replication of data between storage arrays. When this feature is activated, a dedicated port (port 3) on each RAID controller is reserved exclusively for Remote Replication traffic. No other data traffic is allowed on that port until the Remote Replication feature is deactivated. A dedicated zone on each Fibre Channel switch is also required.

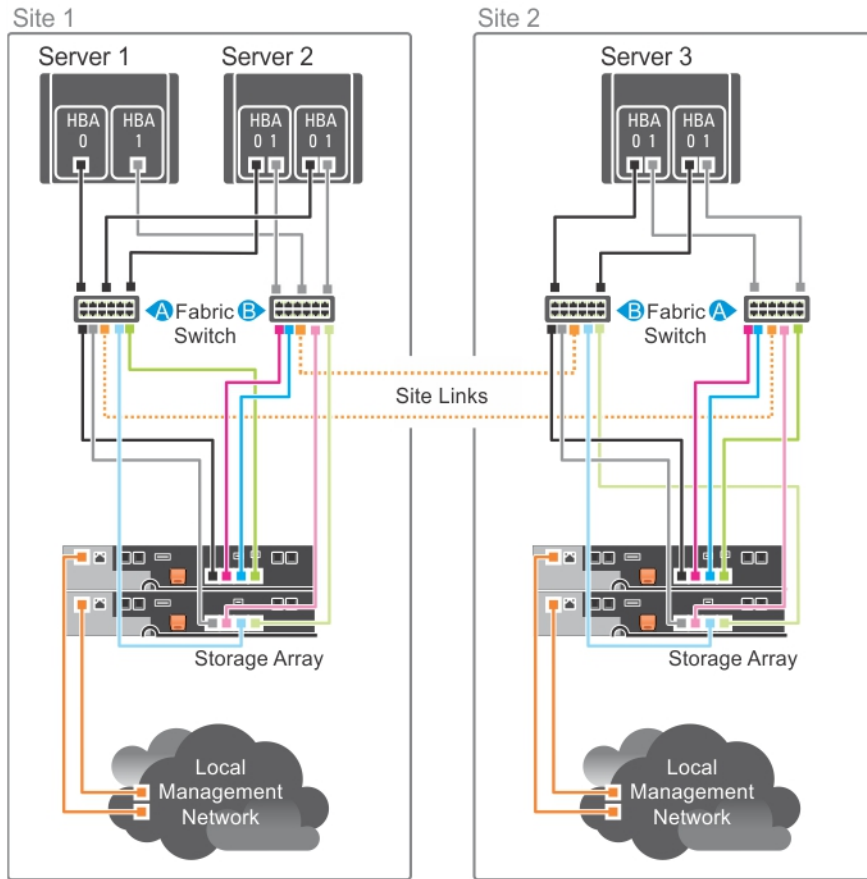

Figure 3. Remote Replication Cabling

Switch Fabric A	Switch Fabric B
Zone1_Server1_HBA_0_0	Zone6_Server1_HBA_1_1
Server1_HBA_0	Server1_HBA_1
Array1_Ctrl-0-0	Array1_Ctrl-0-1
Array1_Ctrl-1-0	Array1_Ctrl-0-2
Array1_Ctrl-1-2	Array1_Ctrl-1-1
Zone2_Server2_HBA_0_0	Zone7_Server2_HBA_0_1
Server2_HBA_0_0	Server2_HBA_0_1
Array1_Ctrl-0-0	Array1_Ctrl-0-1
Array1_Ctrl-1-0	Array1_Ctrl-0-2
Array1_Ctrl-1-2	Array1_Ctrl-1-1
Zone3_Server2_HBA_1_0	Zone8_Server2_HBA_1_1
Server2_HBA_1_0	Server2_HBA_1_1

Switch Fabric A	Switch Fabric B
Array1_Ctrl-0-0	Array1_Ctrl-0-1
Array1_Ctrl-1-0	Array1_Ctrl-0-2
Array1_Ctrl-1-2	Array1_Ctrl-1-1
Zone4_Server3_HBA_0_1	Zone9_Server3_HBA_0_0
Server3_HBA_0_1	Server3_HBA_0_0
Array2_Ctrl-0-1	Array2_Ctrl-0-0
Array2_Ctrl-0-2	Array2_Ctrl-1-0
Array2_Ctrl-1-1	Array2_Ctrl-1-2
Zone5_Server3_HBA_1_1	Zone10_Server3_HBA_1_0
Server3_HBA_1_1	Server3_HBA_1_0
Array2_Ctrl-0-1	Array2_Ctrl-0-0
Array2_Ctrl-0-2	Array2_Ctrl-1-0
Array2_Ctrl-1-1	Array2_Ctrl-1-2
Replication_Zone_1	Replication_Zone_2
Array1_Ctrl-0-3	Array1_Ctrl-1-3
Array2_Ctrl-0-3	Array2_Ctrl-1-3

Mixed Environment

The following figure shows mixed configuration, that is SAS direct attached and host connectivity via the SAN (that is FC/Ethernet switch).

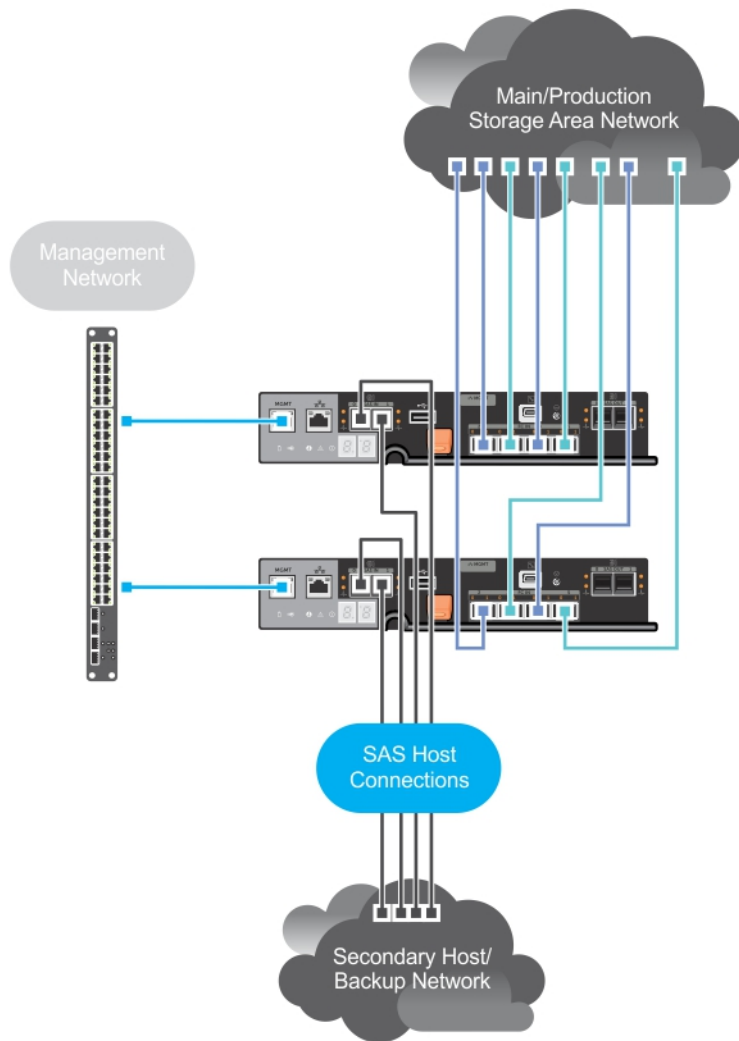

Figure 4. Mixed Environment

Cabling PowerVault MD3060e Expansion Enclosures

You can expand the capacity of your PowerVault MD3860f Series storage array by adding PowerVault MD3060e expansion enclosures. You can expand the physical disk drive pool to a maximum of 120 (or 180, if enabled using Premium Feature activation) physical disk drives using a maximum of two expansion enclosures.

To connect the MD3060e expansion enclosure to your MD Series Dense RAID storage array, refer to the diagrams given here.

MD3060e Expansion cabling diagrams

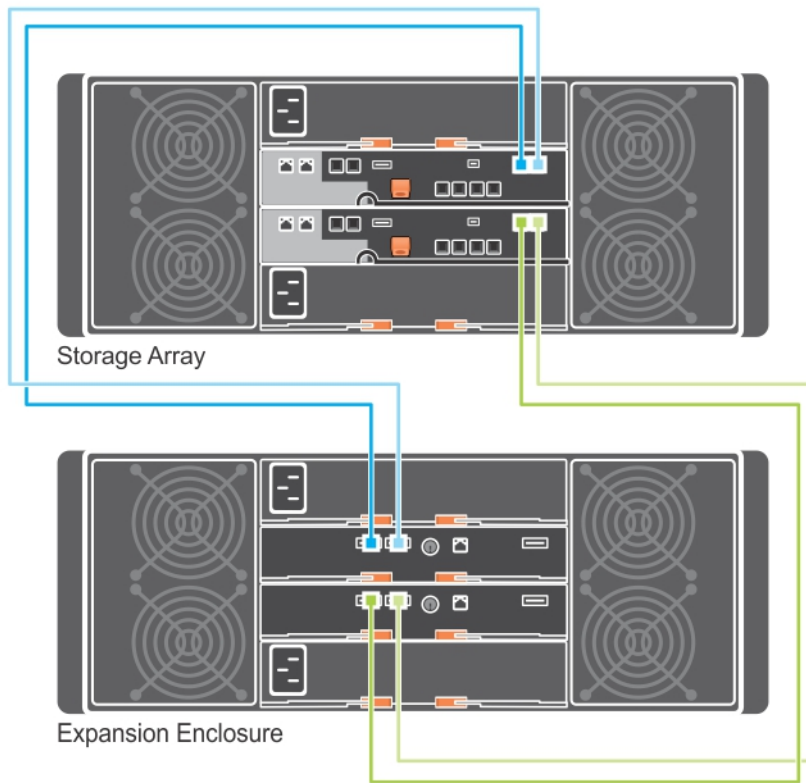

Figure 5. Single expansion diagram

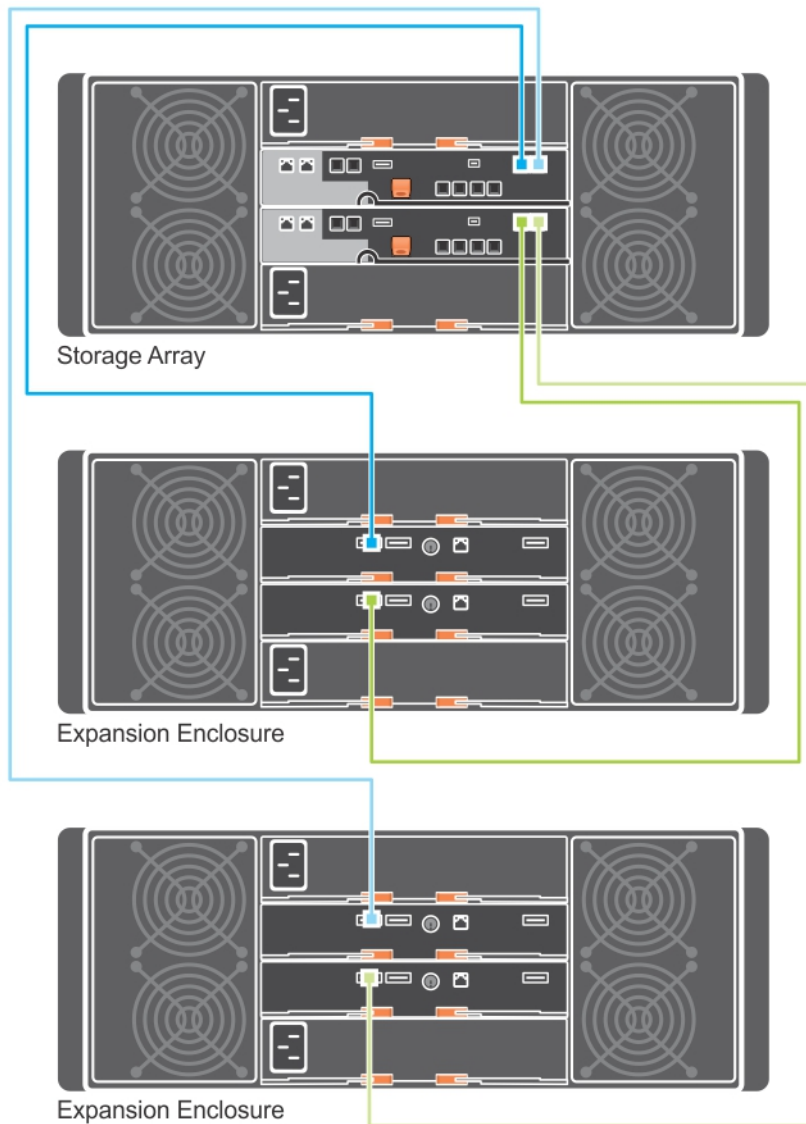

Figure 6. Dual expansion diagram

Expanding With New PowerVault MD3060e Expansion Enclosures

NOTE: Hot plug of MD3060e expansion enclosure is not recommended. Power on all MD3060e expansion enclosures before you power on the array enclosure. For helpful videos and other resources on PowerVault MD series, see dell.com/PVresources.

Perform the following steps to attach new PowerVault MD3060e expansion enclosures to a PowerVault MD3860f Series storage array:

1. Before adding the expansion enclosure(s), ensure that the storage array software is installed and is up to date.

For more information, see the Support Matrix at dell.com/powervaultmanuals.

2. Install the software and driver package included on the PowerVault MD Series resource media.
For information about installing the software, see [Installing MD Storage Manager](#).
3. Using **MD Storage Manager**, update the RAID controller module firmware and NVSRAM to the latest versions available on dell.com/support.
4. Click **Tools** → **Upgrade RAID Controller Module Firmware** from the **Enterprise Management Window** (EMW) by selecting the array enclosure that you want to update.
5. Stop all I/O to the storage array and turn off affected host systems attached to the storage array.
6. Turn off the storage array.
7. Turn off any expansion enclosure(s) in the affected system.
8. Cable the expansion enclosure(s) to the storage array. For correct cabling diagrams, see "Cabling PowerVault MD3060e Expansion Enclosure" earlier in this guide.
9. Turn on the expansion enclosure(s) and wait for the enclosure status LED to turn blue.
10. Turn on the storage array and wait for the status LED to indicate that the unit is ready:
 - When power is on, the power on indicator lights solid green.
 - If the Service action required indicator lights amber, the error can be viewed using the PowerVault Modular Disk Storage Manager.
11. After the storage array is online and ready, turn on any attached host systems.
12. Using **PowerVault MD Storage Manager**, update all attached expansion enclosure firmware if it is out of date.
13. From the EMW, select the enclosure that you want to update and launch the **Array Management Window** (AMW).
14. From the **Array Management Window**, select **Upgrade** → **EMM Firmware**.
15. Click **Select All** to update all the attached expansion enclosures simultaneously.
16. Click **Start**.

Installing MD Storage Manager

The PowerVault MD Series resource media contains software and drivers for both Linux and Microsoft Windows operating systems.

The root of the media contains a **readme.txt** file describing changes to the software, updates, fixes, patches, and other important data applicable to both Linux and Windows operating systems. The **readme.txt** file also specifies requirements for accessing documentation, information regarding versions of the software on the media, and system requirements for running the software.

 **CAUTION:** Do not install MD Storage Manager exclusively on a virtual disk that is being actively managed by MD Storage Manager. Instead, install at least one instance of MD Storage Manager on a local disk that is running SMagent and SMmonitor. Installing management software only on a virtual disk may prevent access to recovery information in the event of multiple physical disk or enclosure failures.

For more information on supported hardware and software for Dell PowerVault systems, see the Support Matrix at dell.com/powervaultmanuals.

 **NOTE:** As a first step towards managing the array, always use MD Storage Resource DVD media to update and install MD Storage Manager. For the latest updates and Support Matrix, see dell.com/powervaultmanuals.

The PowerVault MD3860f Series storage firmware installer provides features that include the core software and providers. The core software feature includes the host-based storage agent, multipath driver, and MD Storage Manager application used to configure, manage and monitor the storage array solution. The providers feature include providers for the Microsoft Virtual Disk Service (VDS) and Microsoft Volume Shadow-Copy Service (VSS) framework.

 **NOTE:** For more information about the Microsoft VDS and Microsoft VSS providers, see the Administrator's Guide at dell.com/powervaultmanuals.

 **NOTE:** To install the software on a Windows or Linux system, you must have administrative or root privileges.

 **NOTE:** If Dynamic Host Configuration Protocol (DHCP) is not used, initial configuration of the management station must be performed on the same physical subnet as the storage array. Additionally, during initial configuration, at least one network adapter must be configured on the same IP subnet as the storage array's default management port (Controller 0 MGMT (port 0) : 192.168.128.101 or Controller 1 MGMT (port 0): 192.168.128.102). After the initial configuration, the management ports are configured using MD Storage Manager and the management station's IP address can be changed back to the previous settings.

 **NOTE:** Only two management ports (Port 0) per array are supported. Second port on each controller is reserved.

The PowerVault MD Series resource media offers the following installation methods:



- Graphical Installation (Recommended) — This is the recommended installation procedure. The installer presents a graphical wizard-driven interface that allows customization of components installed.
- Console Installation — This installation procedure is useful for Linux users who do not desire to install an X-Window environment on their supported Linux platform.
- Silent Installation — This installation procedure is useful if you prefer to create scripted installations.

Installing Host Bus Adapters And Drivers

1. Install the host bus adapters (HBAs).
2. Connect the cables.
3. Install the HBA drivers and the operating system HBA patches/hotfixes.
4. Ensure that the recommended HBA settings are applied.

Graphical Installation (Recommended)

The MD Storage Manager configures, manages, and monitors the storage array. To install the MD storage manager:

1. Insert the PowerVault MD Series resource media.
Depending on your operating system, the installer may launch automatically. If the installer does not launch automatically, navigate to the root directory of the installation media (or downloaded installer image) and run the **md_launcher.exe** file. For Linux-based systems, navigate to the root of the resource media and run the autorun file.
 **NOTE:** By default, Red Hat Enterprise Linux mounts the resource media with the **-noexec** mount option which does not allow you to run executable files. To change this setting, see the **Readme** file in the root directory of the installation media.
2. Select **Install MD Storage Software**.
3. Read and accept the license agreement.
4. Select one of the following installation options from the **Install Set** menu:
 - **Full (recommended)** — Installs the MD Storage Manager (client) software, host-based storage agent, multipath driver, and hardware providers.
 - **Host Only** — Installs the host-based storage agent and multipath drivers. See Installing MD Storage Manager.
 - **Management** — Installs the management software and hardware providers.
 - **Custom** — Allows you to select specific components.
 **NOTE:** If you install the MD Storage Manager on a management station that is not connected to a network or server, only the **Management Station** option is available.
5. Choose whether to start the event monitor service manually or automatically, when the host server reboots.
 **NOTE:** This option is applicable only to Windows client software installation.
6. Confirm the installation location and click **Install**.
7. If prompted, reboot the host server after the installation completes.

8. Start **MD Storage Manager** and discover the array(s).

 **NOTE:** If Dynamic Host Configuration Protocol (DHCP) is not used on the network where the PowerVault MD storage array's management ports are connected, it is recommended that you enable IPv6 on the management station to discover the storage array(s).

 **NOTE:** If automatic discovery does not find the new array, use the manual option and provide the default management ports IP addresses Controller 0 MGMT (port 0) : 192.168.128.101 or Controller 1 MGMT (port 0): 192.168.128.102 using the same subnet or same VLAN for the MD Storage Manager management station.

9. If applicable, activate any premium features purchased with your storage array. If you purchased premium features, see the printed activation card shipped with your storage array.

 **NOTE:** The **MD Storage Manager** installer automatically installs the required drivers, firmware, and operating system patches/hotfixes to operate your storage array. These drivers and firmware are also available at dell.com/support. In addition, see the Support Matrix at dell.com/powervaultmanuals for any additional settings and/or software required for your specific storage array.

Console Installation

 **NOTE:** Console installation only applies to Linux systems that are not running a graphical environment.

The autorun script in the root of the resource media detects when there is no graphical environment running and automatically starts the installer in a text-based mode. This mode provides the same options as graphical installation.

Silent Installation

Silent Installation On Windows

To run silent installation on a Windows system:

1. Copy the **custom_silent.properties** file in the **/windows** folder of the installation media or image to a writable location on the host server.
2. Modify the **custom_silent.properties** file to reflect the features, models and installation options to be used. Then, save the file.
3. After the **custom_silent.properties** file is revised to reflect your specific installation, run the following command to begin the silent installation:

```
mdss_install.exe -f <host_server_path>\ custom_silent.properties
```

Silent Installation On Linux

To run silent installation on a Linux system:



NOTE: On Red Hat Enterprise Linux 6 operating systems, run the following script from the root directory to install prerequisite packages:

```
# md_prereq_install.sh
```

1. Copy the **custom_silent.properties** file in the **/linux** directory of the installation media or image to a writable location on the host server.
2. Modify the **custom_silent.properties** file to reflect the features, models and installation options to be used. Then, save the file.
3. After the **custom_silent.properties** file is revised, run the following command to begin the installation:

```
./mdss_install.bin -f <host_server_path>/custom_silent.properties
```

Enabling Premium Features (Optional)

If you ordered premium features, follow the instructions on the Premium Features card to install the additional features.



Upgrading PowerVault MD Storage Manager

To upgrade from a previous version of the PowerVault MD Storage Manager, uninstall the previous version (see [Uninstalling MD Storage Manager From Windows](#)), and then follow the instructions in [Installing MD Storage Manager](#) to install the new version.

Post Installation Tasks

Before using the Dell PowerVault storage array for the first time, complete these initial configuration tasks in the order shown. These tasks are performed using the MD Storage Manager.

1. For out-of-band management, you must set the network configuration for each RAID controller module, including its Internet Protocol (IP) address, subnetwork mask (subnet mask), and gateway.
 -  **NOTE:** You can set the network configuration using a DHCP server.
2. Launch **MD Storage Manager**.
 - Click **Start** → **Programs** → **Dell** → **MD Storage Manager** → **Modular Disk Storage Manager Client** on Microsoft Windows operating systems.
 - Click the **PowerVault MD Storage Manager** desktop icon on Linux operating systems.
 - You can also launch **PowerVault MD Storage Manager** in Linux by running the following commands at the command prompt:

```
cd /opt/dell/mdstoragesoftware/mdstoragemanager/client./SMclient
```
3. Go to **Setup** → **Add Storage Array** and start the automatic discovery of systems in the **Enterprise Management Window** (EMW).
 -  **NOTE:** Only storage arrays configured with IP address on the same subnet as the management stations will be detected.
 -  **NOTE:** It may take several minutes for the discovery process to complete. Closing the **Automatic Discovery Status** window before this stops the discovery process.

After discovery is complete, a confirmation screen is displayed.
4. Click **Close**.

Verifying Storage Array Discovery

The **Automatic Discovery** option automatically discovers both in-band and out-of-band arrays and adds the storage arrays to the management domain. If the out-of-band or in-band connections shown on the summary page are not accurate, complete the following steps. For more information, see the Online Help.

1. Check the hardware and connections for possible problems.

For specific procedures on troubleshooting interface problems, see the *Dell PowerVault MD Series Storage Arrays Owner's Manual* at dell.com/powervaultmanuals.
2. Verify that the array is on the local subnetwork. If it is not, using MD Storage Manager, manually add the storage array to the subnet.
3. Verify that the status of each storage array is **Optimal**.
4. If an array shows an **Unresponsive** status, complete one of the following steps:
 - To remove the array from the management domain, select the array, right-click and click **Remove** → **Storage Array**.

- To add an array, in the EMW, select **Automatic Discovery**.

 **NOTE:** You can also add an array in the EMW using its known management ports IP addresses.

Initial Setup Tasks

1. The name of the first storage array found is displayed in the **Devices** tab of the EMW.
To see a list of all storage arrays found on the local network, expand **Discovered Storage Arrays** in the **Devices** tab of the EMW.
2. The default name for a newly installed PowerVault MD3860f series storage array is *Unnamed*. If another name is displayed in MD Storage Manager, click the down arrow next to the name and click **Unnamed** in the drop-down list and rename the array.
3. Double-click on the discovered array to launch the array management window and make changes to the configuration of the array.
4. Click **Perform Initial Setup Tasks** to see an outline and links to the remaining post-installation tasks. The array is now ready to be configured. See the Administrator's Guide at dell.com/powervaultmanuals for information about each task and to perform the necessary configuration steps. The following table lists the recommended configuration steps that can be accomplished in MD Storage Manager.

 **NOTE:** Before configuring the storage array, check the status icons on the **Device** pane to ensure that the enclosures in the storage array are in an **Optimal** status. For more information on the status icons, see the Owner's Manual at dell.com/powervaultmanuals.

Task	Purpose
Rename the storage array	To provide a more meaningful name than the software-assigned label, Unnamed.
Set a storage array password	To restrict unauthorized access. MD Storage Manager may ask for a password before changing the configuration or performing a destructive operation.
Set up alert notifications	To notify individuals (by e-mail) and/or storage enterprise management consoles, such as Dell Management Console, (by SNMP) when a storage array component degrades or fails, or an adverse environmental condition occurs.
Set up e-mail alerts	
Set up SNMP alerts	
Configure a storage array	To create virtual disks and map them to hosts.

Uninstalling MD Storage Manager

Uninstalling MD Storage Manager From Windows

To uninstall the Modular Disk Storage Manager from Microsoft Windows Server:

1. Double-click **Add or Remove Programs** from the **Control Panel**.
2. Select **Dell MD Storage Software** from the list of programs.
3. Click **Change/Remove**.
The **Uninstall Complete** window is displayed.
4. Follow the instructions on screen.
5. Select **Yes** to restart the system, and then click **Done**.

Uninstall MD Storage Manager From Windows Server GUI Version

To uninstall Modular Disk Storage Manager from Windows Server GUI versions:

1. Double-click **Programs** → **Programs and Features** from the **Control Panel**.
The **Uninstall or Change a Program** window is displayed.
2. Select **MD Storage Software** from the list of programs and right-click.
3. Click **Uninstall/Change**.
The **Uninstall Complete** window is displayed.
4. Follow the instructions on screen.
5. Select **Yes** to restart the system, then click **Done**.

Uninstall MD Storage Manager From Windows Server Core Versions

To uninstall PowerVault Modular Disk Storage Manager on Windows Server Core versions:

1. Navigate to the **Dell\MD Storage Software\Uninstall Dell MD Storage Software** directory.
 **NOTE:** By default, MD Storage Manager is installed in the **\Program Files(x86)\Dell\MD Storage Software** directory. If another directory was used during installation, navigate to that directory before beginning the uninstallation procedure.
2. From the installation directory, type the following command and press <Enter>:
`Uninstall Modular Disk Storage`
3. From the **Uninstall** window, click **Next** and follow the instructions on the screen.
4. Select **Yes** to restart the system, then click **Done**.

Uninstalling MD Storage Manager From Linux

By default, PowerVault MD Storage Manager is installed in the `/opt/dell/mdstoragemanager` directory. If another directory was used during installation, navigate to that directory before beginning the uninstallation procedure.

1. From the installation directory, open the **Uninstall Dell MD Storage Software** directory.
2. Run the file **Uninstall Dell MD Storage Software.exe**.
3. From the **Uninstall** window, click **Next**, and follow the instructions on the screen.
While the software is uninstalling, the **Uninstall** window is displayed. When the uninstall procedure is complete, the **Uninstall Complete** window is displayed.
4. Click **Done**.

Load Balancing

Load Balance Policy

Multi-path drivers select the I/O path to a virtual disk through a specific RAID controller module. When the multi-path driver receives a new I/O to process, the driver tries to find a path to the current RAID controller module that owns the virtual disk. If the path to the current RAID controller module that owns the virtual disk cannot be found, the multi-path driver migrates the virtual disk ownership to the secondary RAID controller module. When multiple paths to the RAID controller module that owns the virtual disk exist, you can choose a load balance policy to determine which path is used to process I/O. Multiple options for setting the load balance policies let you optimize I/O performance when mixed host interfaces are configured.

 **NOTE:** For more information on Load Balance Policy, see your operating system's manual and updates.

You can choose one of the following load balance policies to optimize I/O performance:

- Round robin
- Least queue depth
- Least path weight (Microsoft Windows operating systems only)

Round Robin With Subset

The round robin with subset I/O load balance policy routes I/O requests, in rotation, to each available data path to the RAID controller module that owns the virtual disks. This policy treats all paths to the RAID controller module that owns the virtual disk equally for I/O activity. Paths to the secondary RAID controller module are ignored until ownership changes. The basic assumption for the round-robin policy is that the data paths are equal. With mixed host support, the data paths might have different bandwidths or different data transfer speeds.

Least Queue Depth

The least queue depth policy is also known as the least I/Os or least requests policy. This policy routes the next I/O request to a data path that has the least outstanding I/O requests queued. For this policy, an I/O request is simply a command in the queue. The type of command or the number of blocks that are associated with the command are not considered.

The least queue depth policy treats large block requests and small block requests equally. The data path selected is one of the paths in the path group of the RAID controller module that owns the virtual disk.

Least Path Weight

The least path weight policy assigns a weight factor to each data path to a virtual disk. An I/O request is routed to the path with the lowest weight value to the RAID controller module that owns the virtual disk.

If more than one data path to the virtual disk has the same weight value, the round robin with subset path selection policy is used to route I/O requests between the paths with the same weight value. The least path weight load balance policy is not supported on Linux operating systems.

Setting Load Balance Policies in Linux

Linux only supports round robin based load balancing. For more information, see *Round Robin With Subset*.

Setting Load Balance Policies in VMware

VMware supports Asymmetric Logical Unit Access (ALUA). For more information on Most Recently Used (MRU) and Round Robin (RR) load balancing policies, see VMware documents.

Appendix — Working With SFP Modules And Fiber Optic Cables

Each storage controller can have up to four FC host ports. A small-form-factor pluggable (SFP) module is used to connect a host port to a host or switch. The SFP module is inserted into the port, and then a fiber optic cable is inserted into the SFP module. The other end of the fiber optic cable is connected to an optical interface connector either in a FC HBA on a host or a switch. SFP modules are laser products.

 **WARNING: Data processing environments can contain equipment transmitting on system links with laser modules that operate at greater than Class 1 power levels. Never look into the end of an optical fiber cable or open receptacle.**

Guidelines For Using SFP Modules

The storage array requires SFP modules. SFP modules convert electrical signals to optical signals that are required for FC transmission to and from RAID controller modules. After installing the SFP modules, fiber optic cables are used to connect the storage array to other FC devices. Before installing SFP modules and fiber optic cables, read the following information:

- Use only Dell supported SFPs with the Dell PowerVault MD3860f series storage arrays. Other generic SFPs are not supported and may not work with the storage arrays.
- The SFP module housing has an integral guide key that is designed to ensure you insert the SFP module correctly.

 **CAUTION: Use minimal pressure when inserting an SFP module into a FC port. Forcing the SFP module into a port may damage the SFP module or the port.**

- You can install or remove the SFP module while the port is powered on.
- You must install the SFP module into a port before you connect the fiber optic cable.
- You must remove the fiber optic cable from the SFP module before you remove the SFP module from the port.

 **CAUTION: When handling static-sensitive devices, take precautions to avoid damaging the product from static electricity.**

Installing SFP Modules

To install SFP modules:

1. If all the FC IN ports have an SFP module installed, go to step 5.
2. Remove the SFP module from the static protective package.
3. Remove the protective cap from the SFP module and SFP port.

 **NOTE:** Store the protective caps for future use.

4. Insert the SFP module into the host port until it clicks into place.

5. Connect an FC cable. See [Installing Fibre Channel Cables](#).

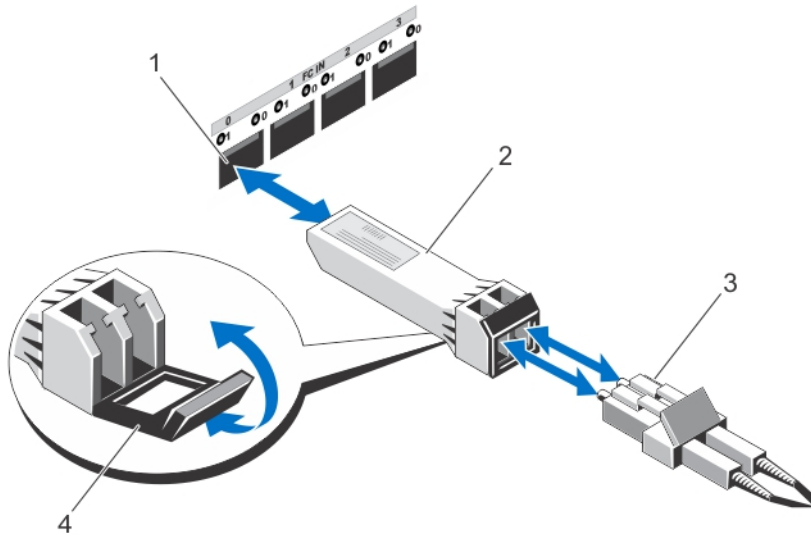

Figure 7. Installing and Removing an SFP Module

- | | |
|----------------------|---------------------|
| 1. FC IN slot (4) | 2. SFP+ transceiver |
| 3. fibre optic cable | 4. gate |

Removing SFP Modules

To remove SFP modules:

1. Remove the FC cable from the SFP module. See [Removing Fibre Channel Cables](#).
NOTE: To avoid damaging the cable or the SFP module, disconnect the FC cable before removing the SFP module.
2. Unlock the SFP module latch. For SFP modules that contain wire tabs, unlock the SFP module latch by pulling the wire latch outward.
3. With the SFP module latch in the unlocked position, remove the SFP module. For SFP modules that contain wire tabs, grasp the wire latch and pull the SFP module out of the port.
4. Replace the protective cap on the SFP module and the host port.
5. Place the SFP module into a static-protective package.

Guidelines For Using Fibre Optic Cables

- Do not route the cable along a folding cable management arm.
- For devices on slide rails, leave enough slack in the cables so they do not bend to a diameter of less than 76 mm (3 inch), or a radius less than 38 mm (1.5 inch), when extended or become pinched when retracted.
- Route the cable away from places where it can be damaged by other devices in the rack cabinet.
- Do not use plastic cable ties in place of the provided cable straps.
- Do not over-tighten the cable straps or bend the cables to a diameter of less than 76 mm (3 inch) or a radius less than 38 mm (1.5 inch).
- Do not place excess weight on the cable at the connection point. Ensure that the cable is well supported.

Installing Fibre Channel Cables



WARNING: Data processing environments can contain equipment transmitting on system links with laser modules that operate at greater than Class 1 power levels. Never look into the end of an optical fiber cable or open receptacle.

Before installing an FC cable, see [Guidelines For Using Fibre Optic Cables](#).

To install an FC cable:

1. If applicable, remove the protective cap from the SFP module and store the protective cap for future use.
2. Remove the two protective caps from one end of the cable and store them for future use.
3. Insert the cable into an SFP module that is installed in the storage array. The cable connector is keyed for correct installation. Holding the connector, push in the cable until it clicks into place.
4. Remove the two protective caps from the other end of the cable and store them future use.
5. Connect this end of the cable to one of the following devices:
 - An SFP module that is installed in an FC switch port
 - An FC HBA port

Removing Fibre Channel Cables

To remove an FC cable:

1. Press and hold the lever to release the latches before removing the cable from the SFP module. Ensure that the levers are in the released position when removing the cable. Do not grasp the SFP module plastic tab when removing the cable.
2. On the end of the cable that connects into the SFP module or HBA, press down and hold the lever to release the latches.
3. While pressing down the cable lever, pull the connector to remove the cable from the SFP module.
4. Replace the protective caps on the cable ends.
5. Replace the protective cap on the SFP module.

Appendix — Hardware Cabling Best Practices

Handling Static Sensitive Components

Static electricity can damage memory modules, system boards, and other static-sensitive components. To prevent damaging the system, follow these precautions:

- Move and store all components in the static-protective packaging.
- Place components on a grounded surface before removing them from their static-protective packaging.
- Grounded surfaces include static-dissipating mats or grounded workstations.
- Always be properly grounded when touching a static-sensitive component. To properly ground yourself, wear a wrist strap or boot strap made for this purpose.
- Handle the component by its edges. Do not touch solder joints, pins, or printed circuitry.
- Use conductive field service tools.

Host Cabling For Remote Replication

The Remote Replication premium feature provides online, real-time replication of data between storage arrays over a remote distance. In the event of a disaster or a catastrophic failure at one storage array, a second storage array can be promoted to take over responsibility for computing services. The Remote Replication premium feature requires a dedicated host port for replicating data between storage arrays. After the Remote Replication premium feature has been activated, one host I/O port on each RAID controller module is solely dedicated to replicating operations.

 **NOTE:** If Remote Replication is activated, host port 3 on each RAID controller module is dedicated for the communication that occurs between the two storage arrays (primary and secondary virtual disks). If the Remote Replication premium feature is not being used, these host ports are available for ordinary host connections.

Cabling For Performance

Data transfer performance is enhanced by maximizing bandwidth, which is the ability to process more I/O across more channels. Therefore, a configuration that maximizes the number of host channels and the number of drive channels available to process I/O, maximizes performance. Faster processing speeds also maximize performance.

In addition to planning a topology that provides maximum performance, choose a RAID level that suits the planned applications.

Labeling Cables

Cabling is an important part of creating a robust storage array. Labeling the cables identifies system components and drive channels. System maintenance is easier when the cables are correctly identified. Label both ends of each cable. You can use adhesive office labels that are folded in half over the ends of each cable. Mark the labels with the port identifiers to which the cable is connected. Additional information can be provided by using color-coded cable straps (or ties) to group all cables associated with one component or drive channel.

If a component fails, the cables must be disconnected, the failed component replaced, and the cables reattached. Detailed labeling of the cables simplifies the component replacement process.

If you are adding a new expansion enclosure to an existing configuration, correctly labeled cables help identify where to connect the new enclosure.

Free Manuals Download Website

<http://myh66.com>

<http://usermanuals.us>

<http://www.somanuals.com>

<http://www.4manuals.cc>

<http://www.manual-lib.com>

<http://www.404manual.com>

<http://www.luxmanual.com>

<http://aubethermostatmanual.com>

Golf course search by state

<http://golfingnear.com>

Email search by domain

<http://emailbydomain.com>

Auto manuals search

<http://auto.somanuals.com>

TV manuals search

<http://tv.somanuals.com>