

Dell™ XPS 400

Owner's Manual

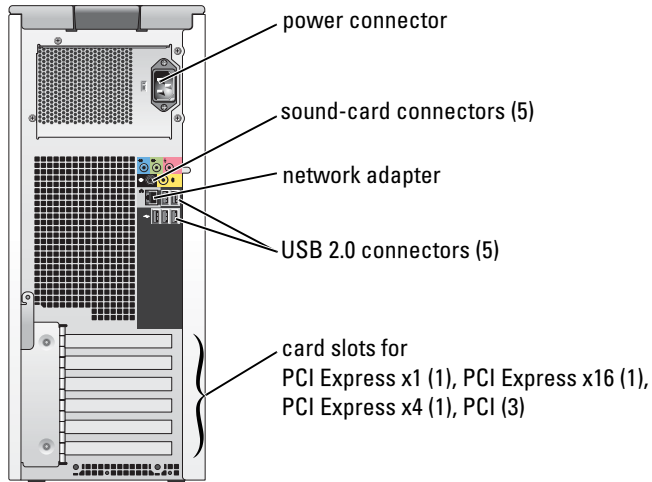
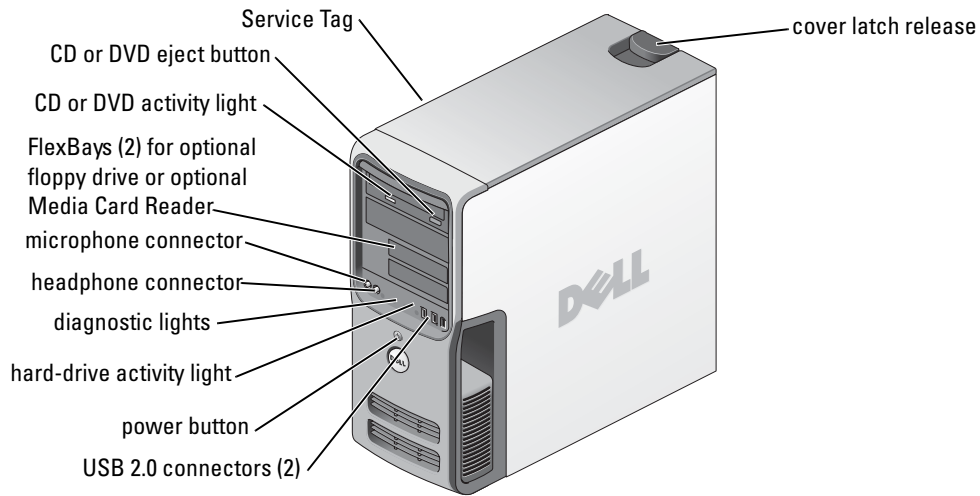

Model DCTA

Notes, Notices, and Cautions



NOTE: A NOTE indicates important information that helps you make better use of your computer.



NOTICE: A NOTICE indicates either potential damage to hardware or loss of data and tells you how to avoid the problem.



CAUTION: A CAUTION indicates a potential for property damage, personal injury, or death.

If you purchased a Dell™ n Series computer, any references in this document to Microsoft® Windows® operating systems are not applicable.

Information in this document is subject to change without notice.

© 2006 Dell Inc. All rights reserved.

Reproduction in any manner whatsoever without the written permission of Dell Inc. is strictly forbidden.

Trademarks used in this text: *Dell*, the *DELL* logo, *Inspiron*, *Dell Precision*, *Dimension*, *OptiPlex*, *Latitude*, *PowerEdge*, *PowerVault*, *PowerApp*, *DellNet*, and *PowerConnect* are trademarks of Dell Inc.; *Intel* and *Pentium*, and *Intel SpeedStep* are registered trademarks of Intel Corporation; *Microsoft*, *Windows*, and *Outlook* are registered trademarks of Microsoft Corporation.

Other trademarks and trade names may be used in this document to refer to either the entities claiming the marks and names or their products. Dell Inc. disclaims any proprietary interest in trademarks and trade names other than its own.

Model DCTA

July 2006

P/N WD741

Rev. A03

Contents

Finding Information	9
1 Setting Up and Using Your Computer	
Setting Up a Printer	13
Printer Cable	13
Connecting a USB Printer.	14
Connecting to the Internet	14
Setting Up Your Internet Connection	15
Playing CDs and DVDs	16
Adjusting the Volume	17
Adjusting the Picture	18
Copying CDs and DVDs.	18
How to Copy a CD or DVD.	18
Using Blank CDs and DVDs.	19
Helpful Tips	20
Using a Media Card Reader (Optional)	20
Connecting Two Monitors	21
Connecting Two Monitors With VGA Connectors	22
Connecting One Monitor With a VGA Connector and One Monitor With a DVI Connector	22
Connecting a TV	23
Changing the Display Settings	23
Setting Up a Home and Office Network	23
Connecting to a Network Adapter	23
Network Setup Wizard	24
Power Management	24
Standby Mode	25
Hibernate Mode.	25
Power Options Properties	25
IEEE 1394	27

Hyper-Threading	27
About Your RAID Configuration	28
RAID Level 0 Configuration	28
RAID Level 1 Configuration	29
Configuring Your Computer for RAID	29
Configuring for RAID Using the Intel® RAID Option ROM Utility	30
Configuring for RAID Using the Intel® Application Accelerator	32
Understanding Intel® Viiv™ Technology (Optional)	35
Using Intel® Viiv™ Quick Resume Technology (Optional)	36
Enabling the QRT Feature in System Setup	36
Enabling the QRT feature in the Operating system	36

2 Solving Problems

Troubleshooting Tips	37
Battery Problems	37
Drive Problems	38
CD and DVD drive problems	38
Hard drive problems	39
E-Mail, Modem, and Internet Problems	39
Error Messages	41
Media Card Reader Problems	42
Keyboard Problems	42
Lockups and Software Problems	43
The computer does not start up	43
The computer stops responding	43
A program stops responding	43
A program crashes repeatedly	43
A program is designed for an earlier Windows operating system	44
A solid blue screen appears	44
Other software problems	44
Memory Problems	45
Mouse Problems	45

Network Problems	46
Power Problems	47
Printer Problems	48
Scanner Problems	48
Sound and Speaker Problems	49
No sound from speakers	49
No sound from headphones	50
Video and Monitor Problems	50
If the screen is blank	50
If the screen is difficult to read	51

3 Troubleshooting Tools

Diagnostic Lights	53
Dell Diagnostics	56
Dell Diagnostics Main Menu	56
Drivers	57
What Is a Driver?	57
Identifying Drivers	58
Reinstalling Drivers	58
Resolving Software and Hardware Incompatibilities	59
Restoring Your Operating System	59
Using Microsoft Windows XP System Restore	60
Using Dell PC Restore by Symantec	61

4 Removing and Installing Parts

Before You Begin	63
Recommended Tools	63
Turn Off Your Computer	63
Before Working Inside Your Computer	64
Front View of the Computer	65
Back View of the Computer	67

Removing the Computer Cover	68
Inside View of Your Computer	70
System Board Components	71
Memory	72
Memory Overview	72
Installing Memory	74
Removing Memory	76
Cards	76
PCI Cards	77
PCI Express Cards	81
Drive Panels	89
Removing the Drive Panel	89
Removing the Drive-Panel Insert	90
Replacing the Drive-Panel Insert	90
Replacing the Drive Panel	91
Drives	92
General Installation Guidelines	92
Hard Drive	92
Removing a Hard Drive	93
Installing a Hard Drive	94
Adding a Second Hard Drive	95
Floppy Drive	96
Removing a Floppy Drive	96
Installing a Floppy Drive	98
Media Card Reader	99
Removing a Media Card Reader	99
Installing a Media Card Reader	101
CD/DVD Drive	102
Removing a CD/DVD Drive	103
Installing a CD/DVD Drive	104
Battery	106
Replacing the Battery	106
Replacing the Computer Cover	107

5 Appendix

Specifications	109
System Setup	113
Overview	113
Entering System Setup	114
System Setup Options.	116
Boot Sequence	119
Clearing Forgotten Passwords.	121
Clearing CMOS Settings	122
Cleaning Your Computer	122
Computer, Keyboard, and Monitor	122
Mouse.	123
Floppy Drive.	123
CDs and DVDs.	123
Dell Technical Support Policy (U.S. Only).	123
Definition of "Dell-Installed" Software and Peripherals	124
Definition of "Third-Party" Software and Peripherals.	124
FCC Notices (U.S. Only)	124
Class A	125
Class B	125
FCC Identification Information	126
Contacting Dell.	126
Index.	145

Finding Information

What Are You Looking For?

- Warranty information
- Terms and conditions (U.S. only)
- Safety instructions
- Regulatory information
- Ergonomics information
- End User License Agreement

Find It Here

Dell™ Product Information Guide



NOTE: This document is available as a PDF at support.dell.com.

-
- How to set up my computer

Setup Diagram

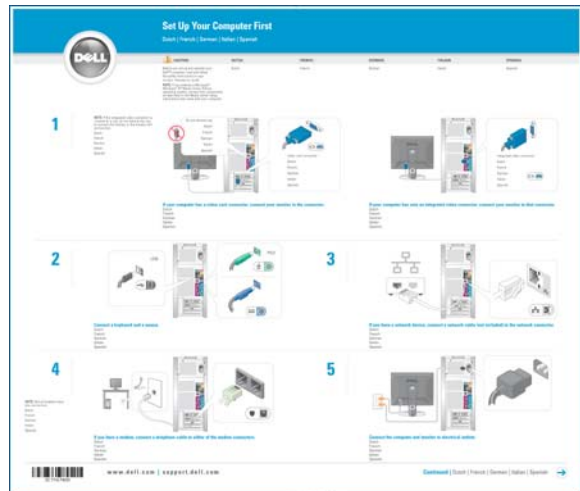

What Are You Looking For?

- Service Tag and Express Service Code
- Microsoft Windows License Label

Find It Here

Service Tag and Microsoft Windows License

These labels are located on your computer.

- Use the Service Tag to identify your computer when you use support.dell.com or contact technical support.



- Enter the Express Service Code to direct your call when contacting technical support. The Express Service Code is not available in all countries.

What Are You Looking For?

- Solutions — Troubleshooting hints and tips, articles from technicians, online courses, frequently asked questions
- Community — Online discussion with other Dell customers
- Upgrades — Upgrade information for components, such as memory, the hard drive, and the operating system
- Customer Care — Contact information, service call and order status, warranty, and repair information
- Service and support — Service call status and support history, service contract, online discussions with technical support
- Reference — Computer documentation, details on my computer configuration, product specifications, and white papers
- Downloads — Certified drivers, patches, and software updates
- Desktop System Software (DSS)— If you reinstall the operating system for your computer, you should also reinstall the DSS utility. DSS provides critical updates for your operating system and support for Dell™ 3.5-inch USB floppy drives, Intel® Pentium® M processors, optical drives, and USB devices. DSS is necessary for correct operation of your Dell computer. The software automatically detects your computer and operating system and installs the updates appropriate for your configuration.

To download Desktop System Software:

- 1 Go to support.dell.com and click **Downloads**.
- 2 Enter your Service Tag or product model.
- 3 In the **Download Category** drop-down menu, click **All**.
- 4 Select the operating system and operating system language for your computer, and click **Submit**.
- 5 Under **Select a Device**, scroll to **System and Configuration Utilities**, and click **Dell Desktop System Software**.

Find It Here

Dell Support Website — support.dell.com

NOTE: Select your region to view the appropriate support site.

NOTE: Corporate, government, and education customers can also use the customized Dell Premier Support website at premier.support.dell.com. The website may not be available in all regions.

What Are You Looking For?	Find It Here
<ul style="list-style-type: none">• How to use Windows XP• Documentation for my computer• Documentation for devices (such as a modem)	<p>Windows Help and Support Center</p> <ol style="list-style-type: none">1 Click the Start button and click Help and Support.2 Type a word or phrase that describes your problem and click the arrow icon.3 Click the topic that describes your problem.4 Follow the instructions on the screen.

Setting Up and Using Your Computer

Setting Up a Printer

 **NOTICE:** Complete the operating system setup before you connect a printer to the computer.

See the documentation that came with the printer for setup information, including how to:

- Obtain and install updated drivers
- Connect the printer to the computer
- Load paper and install the toner or ink cartridge
- Contact the printer manufacturer for technical assistance

Printer Cable

Your printer connects to your computer with a USB cable. Your printer may not come with a printer cable, so if you purchase a cable separately, ensure that it is compatible with your printer. If you purchased a printer cable at the same time you purchased your computer, the cable may arrive in the computer box.

Connecting a USB Printer

NOTE: You can connect USB devices while the computer is turned on.

- 1 Complete the operating system setup, if you have not already done so.
- 2 Install the printer driver if necessary. See the documentation that came with your printer.
- 3 Attach the USB printer cable to the USB connectors on the computer and the printer. The USB connectors fit only one way.

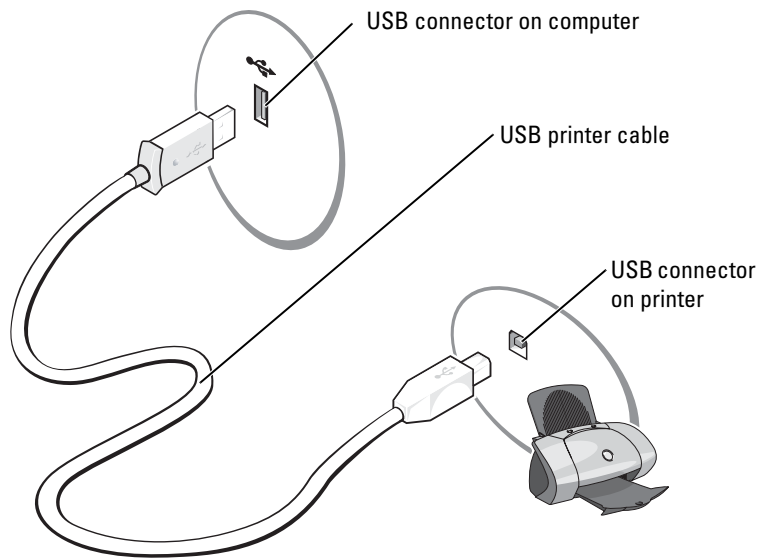

Connecting to the Internet

NOTE: ISPs and ISP offerings vary by country.

To connect to the Internet, you need a modem or network connection and an Internet service provider (ISP), such as AOL or MSN. Your ISP will offer one or more of the following Internet connection options:

- Dial-up connections that provide Internet access through a telephone line. Dial-up connections are considerably slower than DSL and cable modem connections.
- DSL connections that provide high-speed Internet access through your existing telephone line. With a DSL connection, you can access the Internet and use your telephone on the same line simultaneously.
- Cable modem connections that provide high-speed Internet access through your local cable TV line.

 **NOTE:** If you use a dial-up connection, you need an add-in PCI modem expansion card.

If you are using a dial-up connection, connect a telephone line to the modem connector on your computer and to the telephone wall jack before you set up your Internet connection. If you are using a DSL or cable modem connection, contact your ISP for setup instructions.

Setting Up Your Internet Connection

To set up an AOL or MSN connection:

- 1 Save and close any open files, and exit any open programs.
- 2 Double-click the **MSN Explorer** or **AOL** icon on the Microsoft® Windows® desktop.
- 3 Follow the instructions on the screen to complete the setup.

If you do not have an **MSN Explorer** or **AOL** icon on your desktop or if you want to set up an Internet connection with a different ISP:

- 1 Save and close any open files, and exit any open programs.
- 2 Click the **Start** button and click **Internet Explorer**.
The **New Connection Wizard** appears.
- 3 Click **Connect to the Internet**.
- 4 In the next window, click the appropriate option:
 - If you do not have an ISP and want to select one, click **Choose from a list of Internet service providers (ISPs)**.
 - If you have already obtained setup information from your ISP but you did not receive a setup CD, click **Set up my connection manually**.
 - If you have a CD, click **Use the CD I got from an ISP**.
- 5 Click **Next**.

If you selected **Set up my connection manually**, continue to step 6. Otherwise, follow the instructions on the screen to complete the setup.

 **NOTE:** If you do not know which type of connection to select, contact your ISP.

- 6 Click the appropriate option under **How do you want to connect to the Internet?**, and then click **Next**.
- 7 Use the setup information provided by your ISP to complete the setup.

If you are having problems connecting to the Internet, see "E-Mail, Modem, and Internet Problems" on page 39. If you cannot connect to the Internet but have successfully connected in the past, the ISP might have a service outage. Contact your ISP to check the service status, or try connecting again later.

Playing CDs and DVDs

→ NOTICE: Do not press down on the CD or DVD tray when you open or close it. Keep the tray closed when you are not using the drive.

→ NOTICE: Do not move the computer when you are playing CDs or DVDs.

- 1 Press the eject button on the front of the drive.
- 2 Place the disc, label side up, in the center of the tray.











- 3 Press the eject button or gently push in the tray.

To format CDs for storing data, to create music CDs, or to copy CDs, see the CD software that came with your computer.











✍ NOTE: Ensure that you follow all copyright laws when you create CDs.

A CD player includes the following basic buttons:

	Play
	Move backward within the current track
	Pause
	Move forward within the current track
	Stop
	Go to the previous track

	Eject
	Go to the next track

A DVD player includes the following basic buttons:

	Stop
	Restart the current chapter
	Play
	Fast forward
	Pause
	Fast reverse
	Advance a single frame while in pause mode
	Go to the next title or chapter
	Continuously play the current title or chapter
	Go to the previous title or chapter
	Eject

For more information on playing CDs or DVDs, click **Help** on the CD or DVD player (if available).

Adjusting the Volume

 **NOTE:** When the speakers are muted, you do not hear the CD or DVD playing.

- 1 Click the **Start** button, point to **All Programs** → **Accessories** → **Entertainment**, and then click **Volume Control**.
- 2 In the **Volume Control** window, click and drag the bar in the **Volume Control** column and slide it up or down to increase or decrease the volume.

For more information on volume control options, click **Help** in the **Volume Control** window.

Adjusting the Picture

If an error message notifies you that the current resolution and color depth are using too much memory and preventing DVD playback, adjust the display properties:

- 1 Click the **Start** button and click **Control Panel**.
- 2 Under **Pick a category**, click **Appearance and Themes**.
- 3 Under **Pick a task...**, click **Change the screen resolution**.
- 4 In the **Display Properties** window, click and drag the bar in **Screen resolution** to change the setting to 800 by 600 pixels.
- 5 Click the drop-down menu under **Color quality**, and then click **Medium (16 bit)**.
- 6 Click **OK**.

Copying CDs and DVDs

 **NOTE:** Ensure that you observe all copyright laws when creating CDs or DVDs.

This section applies only to computers that have a CD-RW, DVD +/-RW, or CD-RW/DVD (combo) drive.

 **NOTE:** The types of CD or DVD drives offered by Dell may vary by country.

The following instructions explain how to make an exact copy of a CD or DVD. You can also use Sonic DigitalMedia for other purposes, such as creating music CDs from audio files stored on your computer or backing up important data. For help, open Sonic DigitalMedia and then click the question mark icon in the upper-right corner of the window.

How to Copy a CD or DVD

 **NOTE:** CD-RW/DVD combo drives cannot write to DVD media. If you have a CD-RW/DVD combo drive and you experience recording problems, check for available software patches on the Sonic support website at www.sonic.com.

The DVD-writable drives installed in Dell™ computers can write to and read DVD +/-R, DVD +/-RW and DVD+R DL (dual layer) media, but cannot write to and may not read DVD-RAM or DVD-R DL media.

 **NOTE:** Most commercial DVDs have copyright protection and cannot be copied using Sonic DigitalMedia.

- 1 Click the **Start** button, point to **All Programs**→ **Sonic**→ **DigitalMedia Projects**, and then click **Copy**.
- 2 Under the **Copy** tab, click **Disc Copy**.

3 To copy the CD or DVD:

- *If you have one CD or DVD drive*, ensure that the settings are correct and click the **Disc Copy** button. The computer reads your source CD or DVD and copies the data to a temporary folder on your computer hard drive.

When prompted, insert a blank CD or DVD into the drive and click **OK**.

- *If you have two CD or DVD drives*, select the drive into which you have inserted your source CD or DVD and click the **Disc Copy** button. The computer copies the data from the source CD or DVD to the blank CD or DVD.

Once you have finished copying the source CD or DVD, the CD or DVD that you have created automatically ejects.

Using Blank CDs and DVDs

CD-RW drives can write to CD recording media only (including high-speed CD-RW) while DVD-writable drives can write to both CD and DVD recording media.

Use blank CD-Rs to record music or permanently store data files. After creating a CD-R, you cannot write to that CD-R again (see the Sonic documentation for more information). Use blank CD-RWs to write to CDs or to erase, rewrite, or update data on CDs.

Blank DVD+/-Rs can be used to permanently store large amounts of information. After you create a DVD+/-R disc, you may not be able to write to that disc again if the disc is "finalized" or "closed" during the final stage of the disc creation process. Use blank DVD+/-RWs if you plan to erase, rewrite, or update information on that disc later.

CD-Writable Drives

Media Type	Read	Write	Rewritable
CD-R	Yes	Yes	No
CD-RW	Yes	Yes	Yes

DVD-Writable Drives

Media Type	Read	Write	Rewritable
CD-R	Yes	Yes	No
CD-RW	Yes	Yes	Yes
DVD+R	Yes	Yes	No
DVD-R	Yes	Yes	No
DVD+RW	Yes	Yes	Yes
DVD-RW	Yes	Yes	Yes
DVD+R DL	Yes	Yes	No

Media Type	Read	Write	Rewritable
DVD-R DL	Maybe	No	No
DVD-RAM	Maybe	No	No

Helpful Tips

- Use Microsoft® Windows® Explorer to drag and drop files to a CD-R or CD-RW only after you start Sonic DigitalMedia and open a DigitalMedia project.
- Use CD-Rs to burn music CDs that you want to play in regular stereos. CD-RWs do not play in most home or car stereos.
- You cannot create audio DVDs with Sonic DigitalMedia.
- Music MP3 files can be played only on MP3 players or on computers that have MP3 software installed.
- Commercially available DVD players used in home theater systems may not support all available DVD formats. For a list of formats supported by your DVD player, see the documentation provided with your DVD player or contact the manufacturer.
- Do not burn a blank CD-R or CD-RW to its maximum capacity; for example, do not copy a 650-MB file to a blank 650-MB CD. The CD-RW drive needs 1–2 MB of the blank space to finalize the recording.
- Use a blank CD-RW to practice CD recording until you are familiar with CD recording techniques. If you make a mistake, you can erase the data on the CD-RW and try again. You can also use blank CD-RWs to test music file projects before you record the project permanently to a blank CD-R.
- See the Sonic website at www.sonic.com for additional information.

Using a Media Card Reader (Optional)

Use the Media Card Reader to transfer data directly to your computer.

The Media Card Reader supports the following memory types:

- xD-Picture Card
- SmartMedia (SMC)
- CompactFlash Type I and II (CF I/II)
- MicroDrive Card
- SecureDigital Card (SD)
- MultiMediaCard (MMC)
- Memory Stick (MS/MS Pro)

For information on installing a Media Card Reader, see "Installing a Media Card Reader" on page 101.

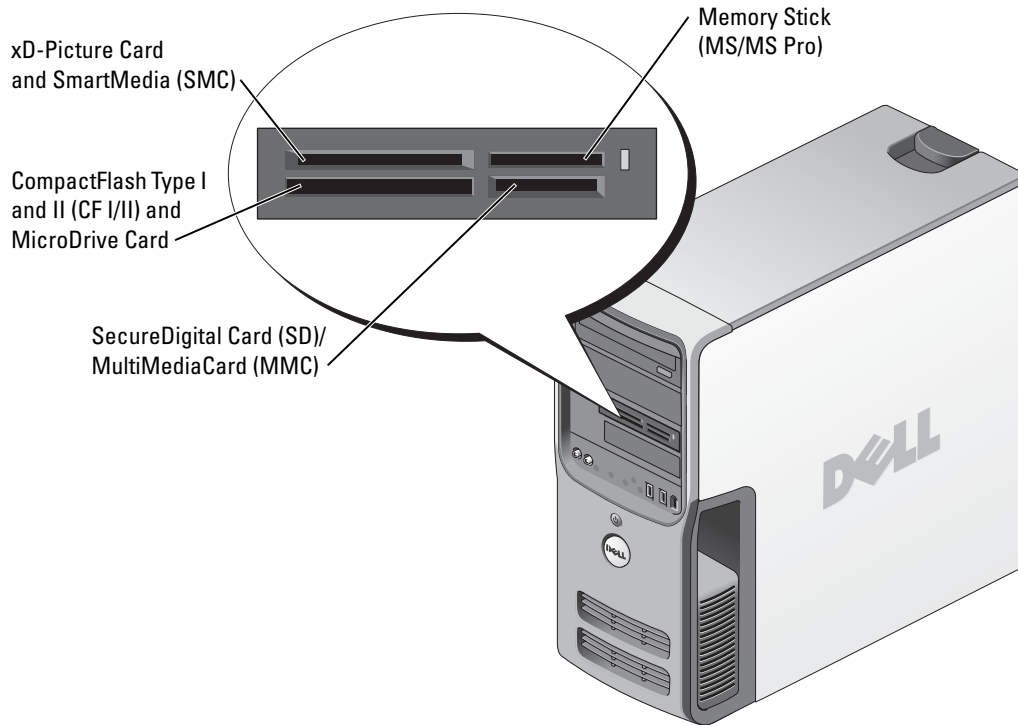

To use the Media Card Reader:

- 1 Check the media or card to determine the proper orientation for insertion.
- 2 Slide the media or card into the appropriate slot until it is completely seated in the connector.
If you encounter resistance, do not force the media or card. Check the card orientation and try again.

Connecting Two Monitors

CAUTION: Before you begin any of the procedures in this section, follow the safety instructions in the *Product Information Guide*.

NOTE: If you are connecting two monitors that have VGA connectors, you must have the optional DVI adapter. If you are connecting two flat-panel monitors, at least one of them must have a VGA connector. If you are connecting a television, you may connect only one monitor (VGA or DVI) in addition to the television.

If you purchased a graphics card that supports dual monitors, follow these instructions to connect and enable your monitors. The instructions tell you how to connect either two monitors (each with a VGA connector), one monitor with a VGA connector and one monitor with a DVI connector, or a TV.

Connecting Two Monitors With VGA Connectors

- 1 Follow the procedures in "Before You Begin" on page 63.
- 2 Connect one of the monitors to the VGA (blue) connector on the back of the computer.
- 3 Connect the other monitor to the optional DVI adapter and connect the DVI adapter to the DVI (white) connector on the back of the computer.

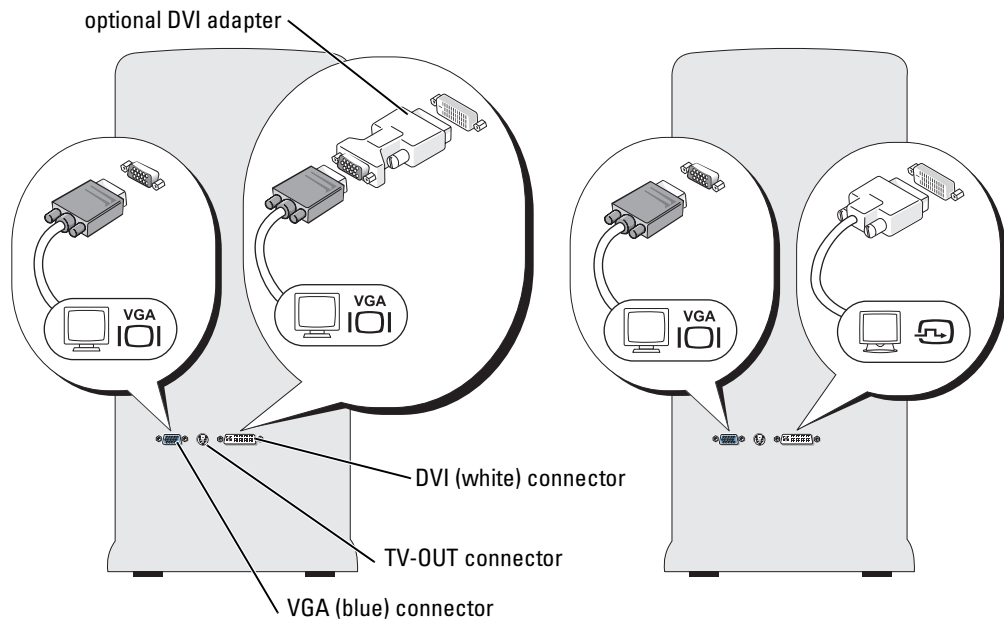

Connecting One Monitor With a VGA Connector and One Monitor With a DVI Connector

- 1 Follow the procedures in "Before You Begin" on page 63.
- 2 Connect the VGA connector on the monitor to the VGA (blue) connector on the back of the computer.
- 3 Connect the DVI connector on the other monitor to the DVI (white) connector on the back of the computer.

Connecting a TV

 **NOTE:** To connect a TV to your computer, you must purchase an S-video cable, which is available at most consumer electronics stores. An S-video cable is not included with your computer.

- 1 Follow the procedures in "Before You Begin" on page 63.
- 2 Connect one end of the S-video cable to the TV-OUT connector on the back of the computer.
- 3 Connect the other end of the S-video cable to the S-video input connector on your TV.
- 4 Connect the VGA or DVI monitor.

Changing the Display Settings

- 1 After you connect the monitor(s) or TV, turn on the computer.
The Microsoft® Windows® desktop displays on the primary monitor.
- 2 Enable clone mode or extended desktop mode in the display settings.
 - In clone mode, both monitors display the same image.
 - In extended desktop mode, you can drag objects from one screen to the other, effectively doubling the amount of viewable work space.

For information on changing the display settings for your graphics card, see the user's guide in the Help and Support Center (click the **Start** button, click **Help and Support**, click **User and system guides**, click **Device guides**, and then click the guide for your graphics card).

Setting Up a Home and Office Network

Connecting to a Network Adapter

 **NOTICE:** Plug the network cable into the network adapter connector on the computer. Do not plug the network cable into the modem connector on the computer. Do not plug a network cable into a telephone wall jack.

- 1 Connect the network cable to the network adapter connector on the back of your computer. Insert the cable until it clicks into place, and then gently pull it to ensure that it is secure.
- 2 Connect the other end of the network cable to a network device.

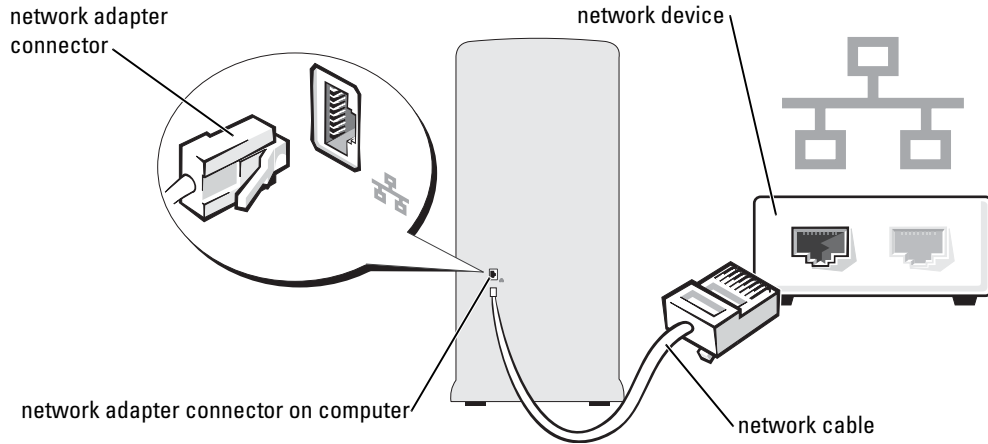

Network Setup Wizard

The Microsoft® Windows® XP operating system provides a Network Setup Wizard to guide you through the process of sharing files, printers, or an Internet connection between computers in a home or small office.

- 1 Click the **Start** button, point to **All Programs**→ **Accessories**→ **Communications**, and then click **Network Setup Wizard**.
 - 2 On the welcome screen, click **Next**.
 - 3 Click **Checklist for creating a network**.
- NOTE:** Selecting the connection method **This computer connects directly to the Internet** enables the integrated firewall provided with Windows XP Service Pack.
- 4 Complete the checklist and required preparations.
 - 5 Return to the Network Setup Wizard and follow the instructions on the screen.

Power Management

The Microsoft® Windows® XP power management features can reduce the amount of electricity your computer uses when it is on and you are not using it. You can reduce power to just the monitor or the hard drive, or you can use standby mode or hibernate mode to reduce power to the entire computer. When the computer exits from a power conservation mode, the Windows desktop is restored to the state it was in before it entered the mode.

- NOTE:** Windows XP Professional includes security and networking features not available in Windows XP Home Edition. When a Windows XP Professional computer is connected to a network, different options related to security and networking appear in certain windows.

Standby Mode

Standby mode conserves power by turning off the display and the hard drive after a time-out. When the computer exits from standby mode, it returns to the operating state it was in before it entered standby mode.

To set standby mode to automatically activate after a defined period of inactivity:

- 1 Click the **Start** button and click **Control Panel**.
- 2 Under **Pick a category**, click **Performance and Maintenance**.
- 3 Under or pick a **Control Panel icon**, click **Power Options**.

To immediately activate standby mode without a period of inactivity, click the **Start** button, click **Turn Off Computer**, and then click **Stand by**.

To exit from standby mode, press a key on the keyboard or move the mouse.



NOTICE: If your computer loses power while in standby mode, it may lose data.

Hibernate Mode

Hibernate mode conserves power by copying system data to a reserved area on the hard drive and then completely turning off the computer. When the computer exits from hibernate mode, the desktop is restored to the state it was in before it entered hibernate mode.

To activate hibernate mode:

- 1 Click the **Start** button and click **Control Panel**.
- 2 Under **Pick a category**, click **Performance and Maintenance**.
- 3 Under or pick a **Control Panel icon**, click **Power Options**.
- 4 Define your hibernate settings on the **Power Schemes** tab, **Advanced** tab, and **Hibernate** tab.

To exit from hibernate mode, press the power button. The computer may take a short time to exit from hibernate mode. Pressing a key on the keyboard or moving the mouse does not bring the computer out of hibernation, because the keyboard and the mouse do not function when the computer is in hibernate mode.

Because hibernate mode requires a special file on your hard drive with enough disk space to store the contents of the computer memory, Dell creates an appropriately sized hibernate mode file before shipping the computer to you. If the computer's hard drive becomes corrupted, Windows XP recreates the hibernate file automatically.

Power Options Properties

Define your standby mode settings, hibernate mode settings, and other power settings in the **Power Options Properties** window. To access the **Power Options Properties** window:

- 1 Click the **Start** button and click **Control Panel**.
- 2 Under **Pick a category**, click **Performance and Maintenance**.

- 3 Under or pick a **Control Panel** icon, click **Power Options**.
- 4 Define your power settings on the **Power Schemes** tab, **Advanced** tab, and **Hibernate** tab.

Power Schemes Tab

Each standard power setting is called a scheme. If you want to select one of the standard Windows schemes installed on your computer, choose a scheme from the **Power schemes** drop-down menu. The settings for each scheme appear in the fields below the scheme name. Each scheme has different settings for starting standby mode or hibernate mode, turning off the monitor, and turning off the hard drive.

The **Power schemes** drop-down menu displays the following schemes:

- **Always On** (default) — If you want to use your computer with no power conservation.
- **Home/Office Desk** — If you use your computer as a home or office computer and you require minimal power conservation.
- **Presentation** — If you want your computer to run without interruption (using no power conservation).
- **Minimal Power Management** — If you want your computer to run with minimal power conservation.
- **Max Battery** — If your computer is a portable computer and you run your computer from batteries for extended periods of time.

If you want to change the default settings for a scheme, click the drop-down menu in the **Turn off monitor**, **Turn off hard disks**, **System stand by**, or **System hibernates** field, and then select a time-out from the displayed list. Changing the time-out for a scheme field permanently changes the default settings for that scheme, unless you click **Save As** and enter a new name for the changed scheme.

 **NOTICE:** If you set the hard drive (hard disk) to time-out before the monitor does, your computer may appear to be locked up. To recover, press any key on the keyboard or click the mouse. To avoid this problem, always set the monitor to time-out before the hard drive.

Advanced Tab

The **Advanced** tab allows you to:

- Place the power options icon  in the Windows taskbar for quick access.
- Set the computer to prompt you for your Windows password before the computer exits from standby mode or hibernate mode.
- Program the power button to activate standby mode, activate hibernate mode, or turn off the computer.

To program these functions, click an option from the corresponding drop-down menu and click **OK**.

Hibernate Tab

The **Hibernate** tab allows you to enable hibernate mode. If you want to use the hibernate settings you defined on the **Power Schemes** tab, click the **Enable hibernate support** check box on the **Hibernate** tab.

For more information on power management options:

- 1 Click the **Start** button and click **Help and Support**.
- 2 In the **Help and Support** window, click **Performance and maintenance**.
- 3 In the **Performance and maintenance** window, click **Conserving power on your computer**.

IEEE 1394

IEEE 1394 is a digital interface that can move large amounts of data between computers and peripheral devices. IEEE 1394 is ideal for use with multimedia devices because it speeds the transfer of data and large files, which enables a computer to connect directly to devices such as digital video cameras.

 **NOTE:** The connector can accept 4-pin IEEE 1394 devices with the use of an adapter.

Your computer may have an optional front IEEE 1394 connector (see "Front View of the Computer" on page 65). This connector is only available if you purchased an add-in card that uses IEEE 1394. To purchase a card, contact Dell.

Hyper-Threading

Hyper-Threading[®] is an Intel[®] technology that can enhance overall computer performance by allowing one physical processor to function as two logical processors, capable of performing certain tasks simultaneously. It is recommended that you use the Microsoft[®] Windows[®] XP Service Pack 1 (SP1) or later operating system because Windows XP is optimized to take advantage of Hyper-Threading technology. While many programs can benefit from Hyper-Threading, some programs have not been optimized for Hyper-Threading and may require an update from the software manufacturer. Contact the software manufacturer for updates and information about using Hyper-Threading with your software.

To determine if your computer is using Hyper-Threading technology:

- 1 Click the **Start** button, right-click **My Computer**, and then click **Properties**.
- 2 Click **Hardware** and click **Device Manager**.
- 3 In the **Device Manager** window, click the plus (+) sign next to **Processors**. If Hyper-Threading is enabled, the processor is listed twice.

You can enable or disable Hyper-Threading through system setup. For more information on accessing system setup, see page 114. For more information on Hyper-Threading, search the Knowledge Base on the Dell Support website at support.dell.com.

About Your RAID Configuration

This section provides an overview of the RAID configuration that you might have selected when you purchased your computer. Although several RAID configurations are available, Dell offers either a RAID level 0 configuration or a RAID level 1 configuration for its Dimension™ computers. A RAID level 0 configuration is recommended for high-performance gaming, and a RAID level 1 configuration is recommended for the data integrity requirements of digital photography and audio.

The Intel® RAID controller on your computer can only create a RAID level 0 configuration using two or three physical drives. If a third drive is present, then that drive can be made part of a RAID level 0 configuration using the Intel RAID configuration program, or it can be used as a spare drive in a RAID level 1 configuration (see "Creating a Spare Hard Drive" on page 35). The drives should be the same size in order to ensure that the larger drive does not contain unallocated (and therefore unusable) space.

NOTE: RAID levels do not represent a hierarchy. A RAID level 1 configuration is not inherently better or worse than a RAID level 0 configuration.

RAID Level 0 Configuration

A RAID level 0 configuration uses a storage technique known as "data striping" to provide a high data access rate. Data striping is a method of writing consecutive segments, or stripes, of data sequentially across the physical drives to create a large virtual drive. Data striping allows one of the drives to read data while the other drive is searching for and reading the next block.

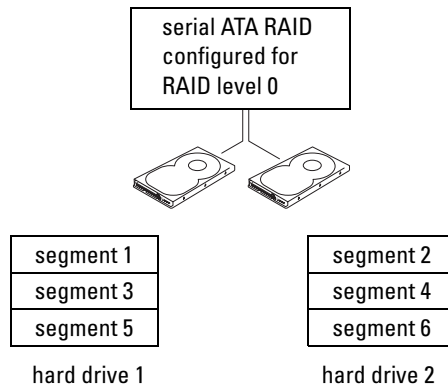

Another advantage of a RAID level 0 configuration is that it utilizes the full capacities of the drives. For example, if you have two 120-GB drives installed, you have 240 GB on which to store data.

NOTICE: Because RAID level 0 configurations provide no data redundancy, if one drive fails, then the data on the other drive is also inaccessible. Therefore, ensure that you perform regular backups when you use a RAID level 0 configuration.

RAID Level 1 Configuration

RAID level 1 uses a data-redundancy storage technique known as "mirroring." When data is written to the primary drive, it is then duplicated, or mirrored, on the other drive. A RAID level 1 configuration sacrifices high data-access rates for its data redundancy advantages.

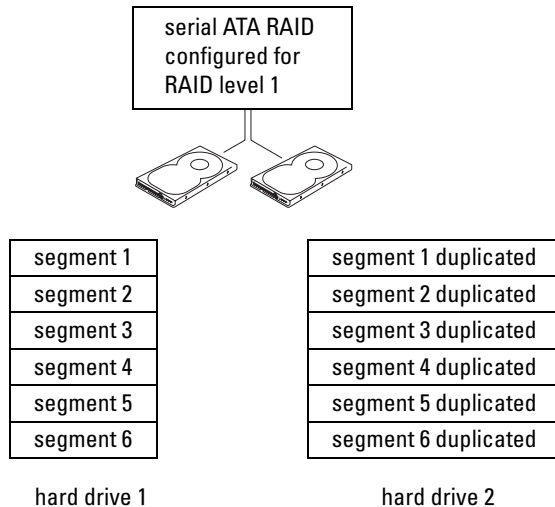

If a drive failure occurs, subsequent read and write operations are directed to the surviving drive. A replacement drive can then be rebuilt using the data from the surviving drive. Also, because data is duplicated on both drives, a RAID level 1 configuration using two 120-GB hard drives collectively has a maximum of 120 GB on which to store data.

Configuring Your Computer for RAID

At some point you may want to configure your computer for RAID if you did not select a RAID configuration when you purchased your computer. You must have at least two hard drives installed in your computer to set up a RAID configuration. For instructions on how to install a hard drive, see page 92.

You can use one of two methods to configure RAID hard drive volumes. One method uses the Intel[®] RAID Option ROM utility and is performed *before* you install the operating system onto the hard drive. The second method uses the Intel Matrix Storage Manager, or Intel Matrix Storage Console, and this method is performed *after* you have installed the operating system

and the Intel Matrix Storage Console. Both methods require that you set your computer to RAID-enabled mode before starting any of the RAID configuration procedures in this document.



Setting Your Computer to RAID-Enabled Mode

- 1 Enter system setup (see page 113).
 - 2 Press the up- and down-arrow keys to highlight **Drives**, and press <Enter>.
 - 3 Press the up- and down-arrow keys to highlight **SATA Operation**, and press <Enter>.
 - 4 Press the left- and right-arrow keys to highlight **RAID On**, press <Enter>, and then press <Esc>.
-  **NOTE:** For more information about RAID options, see "System Setup Options" on page 116.
- 5 Press the left- and right-arrow keys to highlight **Save/Exit**, and press <Enter> to exit system setup and resume the boot process.

Configuring for RAID Using the Intel® RAID Option ROM Utility

 **NOTE:** Although any size drives may be used to create a RAID configuration using the Intel RAID Option ROM utility, ideally the drives should be of equal size. In a RAID level 0 configuration, the size of the configuration will be the size of the smallest drive multiplied by the number (two) of drives in the configuration. In a RAID level 1 configuration, the size of the configuration will be the smaller of the two drives used.

Creating a RAID Level 0 Configuration



-  **NOTICE:** You will lose any data on your hard drives when you create a RAID configuration using the following procedure. Back up data you want to keep before continuing.
-  **NOTE:** Use the following procedure only if you are reinstalling your operating system. Do not use the following procedure to migrate an existing storage configuration to RAID level 0 configuration.
- 1 Set your computer to RAID-enabled mode (see page 30).
 - 2 Press <Ctrl> <i> when you are prompted to enter the Intel® RAID Option ROM utility.
 - 3 Press the up- and down-arrow keys to highlight **Create RAID Volume**, and press <Enter>.
 - 4 Enter a RAID volume name or accept the default, and press <Enter>.
 - 5 Press the up- and down-arrow keys to select **RAID0(Stripe)**, and press <Enter>.
 - 6 If there are more than two hard drives available, press the up- and down-arrow keys and spacebar to select the two or three drives you want to use to make up your configuration, and then press <Enter>.
-  **NOTE:** Select the strip size closest to the size of the average file you want to store on the RAID volume. If you do not know the average file size, choose 128 KB as your strip size.
- 7 Press the up- and down-arrow keys to change the strip size, and press <Enter>.

- 8 Select the desired capacity for the volume, and press <Enter>. The default value is the maximum available size.
- 9 Press <Enter> to create the volume.
- 10 Press <y> to confirm that you want to create the RAID volume.
- 11 Confirm that the correct volume configuration is displayed on the main Intel® RAID Option ROM utility screen.
- 12 Press the up- and down-arrow keys to select **Exit**, and press <Enter>.
- 13 Install the operating system (see "Using Microsoft Windows XP System Restore" on page 60).

Creating a RAID Level 1 Configuration

- 1 Set your computer to RAID-enabled mode (see page 30).
- 2 Press <Ctrl><i> when you are prompted to enter the Intel RAID Option ROM utility.
- 3 Use the up- and down-arrow keys to highlight **Create RAID Volume**, and press <Enter>.
- 4 Enter a RAID volume name or accept the default, and press <Enter>.
- 5 Use the up- and down-arrow keys to select **RAID1 (Mirror)**, and press <Enter>.
- 6 If there are more than two hard drives available, press the up- and down-arrow keys and spacebar to select the two drives you want to use to make up your volume, and then press <Enter>.
- 7 Select the desired capacity for the volume, and press <Enter>. The default value is the maximum available size.
- 8 Press <Enter> to create the volume.
- 9 Press <y> to confirm that you want to create the RAID volume.
- 10 Confirm that the correct volume configuration is displayed on the main Intel RAID Option ROM utility screen.
- 11 Use the up- and down-arrow keys to select **Exit**, and press <Enter>.
- 12 Install the operating system (see "Using Microsoft Windows XP System Restore" on page 60).

Deleting a RAID Volume

-  **NOTE:** When you perform this operation, all data on the RAID drives will be lost.
-  **NOTE:** If your computer currently boots to RAID and you delete the RAID volume in the Intel RAID Option ROM utility, your computer will become unbootable.
- 1 Press <Ctrl><i> when you are prompted to enter the Intel RAID Option ROM utility.
 - 2 Use the up- and down-arrow keys to highlight **Delete RAID Volume**, and press <Enter>.
 - 3 Use the up- and down-arrow keys to highlight the RAID volume you want to delete, and press <Delete>.

- 4 Press <y> to confirm the deletion of the RAID volume.
- 5 Press <Esc> to exit the Intel RAID Option ROM utility.

Configuring for RAID Using the Intel® Application Accelerator

If you already have one hard drive with the operating system installed on it, and you want to add a second hard drive and reconfigure both drives into a RAID volume without losing the existing operating system and any data, you need to use the migrating option (see "Migrating to a RAID Level 0 Configuration" on page 33 or "Migrating to a RAID Level 1 Configuration" on page 34). Create a RAID level 0 volume or RAID level 1 volume only when:

- You are adding two new drives to an existing single-drive computer (and the operating system is on the single drive), and you want to configure the two new drives into a RAID volume.
- You already have a two-hard drive computer configured into a volume, but you still have some space left on the volume that you want to designate as a second RAID volume.

Creating a RAID Level 0 Configuration



NOTE: When you perform this operation, all data on the RAID drives will be lost.

- 1 Set your computer to RAID-enabled mode (see page 30).
- 2 Click **Start** and point to **Programs**→ **Intel(R) Application Accelerator**→ **Intel Matrix Storage Manager** to launch the Intel® Storage Utility.



NOTE: If you do not see an **Actions** menu option, you have not yet set your computer to RAID-enabled mode (see page 30).

- 3 On the **Actions** menu, select **Create RAID Volume** to launch the Create RAID Volume Wizard, and then click **Next**.
- 4 On the **Select Volume Location** screen, click the first hard drive you want to include in your RAID level 0 volume, and then click the right arrow.
- 5 Click a second hard drive. To add a third hard drive in your RAID level 0 volume, click the right arrow and click on the third drive until three drives appear in the **Selected** window, and then click **Next**.
- 6 In the **Specify Volume Size** window, click the **Volume Size** desired, and then click **Next**.
- 7 Click **Finish** to create the volume, or click **Back** to make changes.

Creating a RAID Level 1 Configuration



NOTE: When you perform this operation, all data on the RAID drives will be lost.

- 1 Set your computer to RAID-enabled mode (see page 30).
- 2 Click the **Start** button and point to **Programs**→ **Intel(R) Application Accelerator**→ **Intel Matrix Storage Manager** to launch the Intel® Storage Utility.



-  **NOTE:** If you do not see an **Actions** menu option, you have not yet set your computer to RAID-enabled mode (see page 30).
- 3 On the **Actions** menu, select **Create RAID Volume** to launch the Create RAID Volume Wizard.
 - 4 Click **Next** at the first screen.
 - 5 Confirm the volume name, select **RAID 1** as the RAID level, and then click **Next** to continue.
 - 6 On the **Select Volume Location** screen, click the first hard drive you want to use to create your RAID level 0 volume, and then click the right arrow. Click a second hard drive until two drives appear in the **Selected** window, and then click **Next**.
 - 7 In the **Specify Volume Size** window, select the **Volume Size** desired and click **Next**.
 - 8 Click **Finish** to create the volume, or click **Back** to make changes.
 - 9 Follow Microsoft Windows procedures for creating a partition on the new RAID volume.

Deleting a RAID Volume



-  **NOTE:** While this procedure deletes the RAID 1 volume, it also splits the RAID 1 volume into two non-RAID hard drives with a partition, and leaves any existing data files intact. Deleting a RAID 0 volume, however, destroys all data on the volume.
- 1 Click the **Start** button and point to **Programs**→ **Intel(R) Application Accelerator**→ **Intel Matrix Storage Manager** to launch the Intel® Storage Utility.
 - 2 Right-click the **Volume** icon of the RAID volume you want to delete, and select **Delete Volume**.
 - 3 On the **Delete RAID Volume Wizard** screen, click **Next**.
 - 4 Highlight the RAID volume you want to delete in the **Available** box, click the right-arrow button to move the highlighted RAID volume into the **Selected** box, and then click **Next**.
 - 5 Click **Finish** to delete the volume.

Migrating to a RAID Level 0 Configuration

- 1 Set your computer to RAID-enabled mode (see page 30).
 - 2 Click the **Start** button and point to **All Programs**→ **Intel(R) Application Accelerator**→ **Intel Matrix Storage Manager** to launch the Intel® Storage Utility.
-  **NOTE:** If you do not see an **Actions** menu option, you have not yet set your computer to RAID-enabled mode (see page 30).
- 3 On the **Actions** menu, select **Create RAID Volume From Existing Hard Drive** to launch the Migration Wizard.
 - 4 Click **Next** on the Migration Wizard screen.
 - 5 Enter a RAID volume name or accept the default.

- 6 From the drop-down box, select **RAID 0** as the RAID level.
-  **NOTE:** Select the strip size closest to the size of the average file you want to store on the RAID volume. If you do not know the average file size, choose 128 KB as your strip size.
- 7 Select the appropriate strip size from the drop-down box, and then click **Next**.
-  **NOTE:** Select the hard drive that you want to use as your source hard drive (it should be the hard drive containing the data or operating system files that you want to keep on the RAID volume).
- 8 On the **Select Source Hard Drive** screen, double-click the hard drive from which you want to migrate, and click **Next**.
- 9 On the **Select Member Hard Drive** screen, double-click the hard drive(s) to select the member drive(s) to span the stripe array, and click **Next**.
- 10 On the **Specify Volume Size** screen, select the **Volume Size** you want, and click **Next**.
-  **NOTE:** In the following step, you will lose all data contained on the member drive.
- 11 Click **Finish** to start migrating, or click **Back** to make changes. You can use your computer normally during the migration process.

Migrating to a RAID Level 1 Configuration

- 1 Set your computer to RAID-enabled mode (see page 30).
- 2 Click the **Start** button and point to **All Programs**→**Intel(R) Application Accelerator**→**Intel Matrix Storage Manager** to launch the Intel® Storage Utility.
-  **NOTE:** If you do not see an **Actions** menu option, you have not yet set your computer to RAID-enabled mode (see page 30).
- 3 On the **Actions** menu, click **Create RAID Volume From Existing Hard Drive** to launch the Migration Wizard.
- 4 Click **Next** on the first Migration Wizard screen.
- 5 Enter a RAID volume name or accept the default.
- 6 From the drop-down box, select **RAID 1** as the RAID level.
-  **NOTE:** Select the hard drive that you want to use as your source hard drive (it should be the hard drive containing the data or operating system files that you want to keep on the RAID volume).
- 7 On the **Select Source Hard Drive** screen, double-click the hard drive from which you want to migrate, and click **Next**.
- 8 On the **Select Member Hard Drive** screen, double-click the hard drive to select the member drive that you want to act as the mirror in the configuration, and click **Next**.
- 9 On the **Specify Volume Size** screen, select the volume size you want, and click **Next**.
-  **NOTE:** In the following step, you will lose all data contained on the member drive.
- 10 Click **Finish** to start migrating, or click **Back** to make changes. You can use your computer normally during migration process.

Creating a Spare Hard Drive

A spare hard drive may be created with a RAID level 1 configuration. The spare hard drive will not be recognized by the operating system, but you will be able to see the spare drive from within Disk Manager or the Intel RAID Option ROM utility. When a member of the RAID level 1 configuration is broken, the computer automatically rebuilds the mirror configuration using the spare hard drive as the broken member's replacement.

To Mark a Drive as a Spare Hard Drive:

- 1 Click the **Start** button and point to **Programs**→ **Intel(R) Application Accelerator**→ **Intel Matrix Storage Manager** to launch the Intel® Storage Utility.
- 2 Right-click the hard drive you want to mark as a spare hard drive.
- 3 Click **Mark as Spare**.

To Remove Spare Marking From a Spare Hard Drive:

- 1 Right-click the spare hard drive icon.
- 2 Click **Reset Hard Drive to Non-RAID**

Rebuilding a Degraded RAID Level 1 Configuration

If your computer does not have a spare hard drive, and the computer has reported a degraded RAID level 1 volume, you can manually rebuild the computer's redundancy mirror to a new hard drive by performing the following steps:

- 1 Click the **Start** button and point to **Programs**→ **Intel(R) Application Accelerator**→ **Intel Matrix Storage Manager** to launch the Intel® Storage Utility.
- 2 Right-click the available hard drive to which you want to rebuild the RAID level 1 volume, and click **Rebuild to this Disk**.

You can use your computer while the computer is rebuilding the RAID level 1 volume.

Understanding Intel® Viiv™ Technology (Optional)

Intel Viiv technology is a technology aimed at the digital home enthusiast that includes:

- A BIOS with Quick Resume
- Device drivers

This technology allows the user's system to quickly return to an active state after non-use

Intel Viiv technology is an option for systems that are ordered with Microsoft® Windows® XP Media Center Edition 2005 and dual core processors.

Using Intel® Viiv™ Quick Resume Technology (Optional)

When running in the Intel Viiv Quick Resume Technology (QRT) mode, your power button is used as a quick on/off feature. Pressing the power button once causes the display to go blank and the audio to mute. In this mode, the computer is still operating as indicated by the power button indicator and diagnostic lights 1, 2, and 4 being lit. Also, you may notice that the hard drive indicator may blink when the hard drive is being accessed by an external device.

To resume normal computer operation, briefly press the power button, press any key on the keyboard, move the mouse, or press a button on the optional Microsoft® Windows® XP Media Center Edition 2005 remote control.

Enabling the QRT Feature in System Setup

The QRT drivers must be installed before this feature becomes active. These drivers are installed when this option is ordered. Also, Quick Resume is enabled in system setup when this feature is ordered.

- 1 Enter system setup (see page 114).
- 2 Press the arrow keys to highlight the **Power Management** menu option and press <Enter> to access the menu.
- 3 Press the up- and down-arrow keys to highlight the **Quick Resume** option and press <Enter> to access the menu.
- 4 Press the left- and right-arrow keys to highlight the **On** option and press <Enter> to enable the Quick Resume feature.

Enabling the QRT feature in the Operating system

- 1 Click the **Start** button and click **Control Panel**.
- 2 Under **Pick a category**, click **Performance and Maintenance**.
- 3 Under or pick a **Control Panel** icon, click **Power Options**.
- 4 Click the **Away** tab.
- 5 Ensure that the check boxes for **Enable away mode** and **Options** are checked.
- 6 Click the **Advanced** tab.
- 7 From the **When I press the power button on my computer** drop-down menu, select **Do Nothing**.
- 8 From the **When I press the sleep button on my computer** drop-down menu, select **Do Nothing**.

Solving Problems

Troubleshooting Tips

Follow these tips when you troubleshoot your computer:

- If you added or removed a part before the problem started, review the installation procedures and ensure that the part is correctly installed.
- If a peripheral device does not work, ensure that the device is properly connected.
- If an error message appears on the screen, write down the exact message. This message may help technical support personnel diagnose and fix the problem(s).
- If an error message occurs in a program, see the program's documentation.
- If you cannot boot into your operating system after you have changed your SATA operation settings, restore your previous SATA operation settings and retry booting into the operating system.

Battery Problems



CAUTION: There is a danger of a new battery exploding if it is incorrectly installed. Replace the battery only with the same or equivalent type recommended by the manufacturer. Discard used batteries according to the manufacturer's instructions.



CAUTION: Before you begin any of the procedures in this section, follow the safety instructions in the *Product Information Guide*.

REPLACE THE BATTERY — If you have to repeatedly reset time and date information after turning on the computer, or if an incorrect time or date displays during start-up, replace the battery (see page 106). If the battery still does not work properly, contact Dell (see page 126).

Drive Problems

 **CAUTION:** Before you begin any of the procedures in this section, follow the safety instructions in the *Product Information Guide*.

ENSURE THAT MICROSOFT® WINDOWS® RECOGNIZES THE DRIVE — Click the **Start** button and click **My Computer**. If the floppy, CD, or DVD drive, is not listed, perform a full scan with your antivirus software to check for and remove viruses. Viruses can sometimes prevent Windows from recognizing the drive.

TEST THE DRIVE —

- Insert another floppy, CD, or DVD to eliminate the possibility that the original one is defective.
- Insert a bootable floppy and restart the computer.

CLEAN THE DRIVE OR DISK — See page 122.

CHECK THE CABLE CONNECTIONS

RUN THE HARDWARE TROUBLESHOOTER — See page 60.

RUN THE DELL DIAGNOSTICS — See page 56.

CD and DVD drive problems

 **NOTE:** High-speed CD or DVD drive vibration is normal and may cause noise, which does not indicate a defect in the drive or the CD or DVD.

 **NOTE:** Because of different regions worldwide and different disc formats, not all DVD titles work in all DVD drives.

ADJUST THE WINDOWS VOLUME CONTROL —

- Click the speaker icon in the lower-right corner of your screen.
- Ensure that the volume is turned up by clicking the sidebar and dragging it up.
- Ensure that the sound is not muted by clicking any boxes that are checked.

CHECK THE SPEAKERS AND SUBWOOFER — See "Sound and Speaker Problems" on page 49.

Problems writing to a CD/DVD-RW drive

CLOSE OTHER PROGRAMS — The CD/DVD-RW drive must receive a steady stream of data when writing. If the stream is interrupted, an error occurs. Try closing all programs before you write to the CD/DVD-RW.

TURN OFF STANDBY MODE IN WINDOWS BEFORE WRITING TO A CD/DVD-RW DISC — Search for the keyword *standby* in Windows Help.

Hard drive problems

RUN CHECK DISK —

- 1 Click the **Start** button and click **My Computer**.
- 2 Right-click **Local Disk C:**.
- 3 Click **Properties**.
- 4 Click the **Tools** tab.
- 5 Under **Error-checking**, click **Check Now**.
- 6 Click **Scan for and attempt recovery of bad sectors**.
- 7 Click **Start**.

E-Mail, Modem, and Internet Problems



CAUTION: Before you begin any of the procedures in this section, follow the safety instructions in the *Product Information Guide*.



NOTE: Connect the modem to an analog telephone jack only. The modem does not operate while it is connected to a digital telephone network.

CHECK THE MICROSOFT OUTLOOK® EXPRESS SECURITY SETTINGS — If you cannot open your e-mail attachments:

- 1 In Outlook Express, click **Tools**, click **Options**, and then click **Security**.
- 2 Click **Do not allow attachments** to remove the checkmark.

CHECK THE TELEPHONE LINE CONNECTION —**CHECK THE TELEPHONE JACK —****CONNECT THE MODEM DIRECTLY TO THE TELEPHONE WALL JACK —****USE A DIFFERENT TELEPHONE LINE —**

- Verify that the telephone line is connected to the jack on the modem. (The jack has either a green label or a connector-shaped icon next to it.)
- Ensure that you feel a click when you insert the telephone line connector into the modem.
- Disconnect the telephone line from the modem and connect it to a telephone. Listen for a dial tone.
- If you have other telephone devices sharing the line, such as an answering machine, fax machine, surge protector, or line splitter, then bypass them and use the telephone to connect the modem directly to the telephone wall jack. If you are using a line that is 3 m (10 ft) or more in length, try a shorter one.

RUN THE MODEM HELPER DIAGNOSTICS — Click the **Start** button, point to **All Programs**, and then click **Modem Helper**. Follow the instructions on the screen to identify and resolve modem problems. (Modem Helper is not available on all computers.)

VERIFY THAT THE MODEM IS COMMUNICATING WITH WINDOWS —

- 1** Click the **Start** button and click **Control Panel**.
- 2** Click **Printers and Other Hardware**.
- 3** Click **Phone and Modem Options**.
- 4** Click the **Modems** tab.
- 5** Click the COM port for your modem.
- 6** Click **Properties**, click the **Diagnostics** tab, and then click **Query Modem** to verify that the modem is communicating with Windows.
If all commands receive responses, the modem is operating properly.

ENSURE THAT YOU ARE CONNECTED TO THE INTERNET — Ensure that you have subscribed to an Internet provider. With the Outlook Express e-mail program open, click **File**. If **Work Offline** has a checkmark next to it, click the checkmark to remove it and connect to the Internet. For help, contact your Internet service provider.

Error Messages

If the message is not listed, see the documentation for the operating system or the program that was running when the message appeared.

A FILENAME CANNOT CONTAIN ANY OF THE FOLLOWING CHARACTERS: \ / : * ? " < > | — Do not use these characters in filenames.

A REQUIRED .DLL FILE WAS NOT FOUND — The program that you are trying to open is missing an essential file. To remove and then reinstall the program:

- 1 Click the **Start** button, click **Control Panel**, and then click **Add or Remove Programs**.
- 2 Select the program you want to remove.
- 3 Click the **Change or Remove Program** icon.
- 4 See the program documentation for installation instructions.

drive letter : \ is not accessible. The device is not ready — The drive cannot read the disk. Insert a disk into the drive and try again.

INSERT BOOTABLE MEDIA — Insert a bootable floppy or CD.

NON-SYSTEM DISK ERROR — Remove the floppy from the drive and restart your computer.

NOT ENOUGH MEMORY OR RESOURCES. CLOSE SOME PROGRAMS AND TRY AGAIN — Close all windows and open the program that you want to use. In some cases, you might have to restart your computer to restore computer resources. If so, run the program that you want to use first.

OPERATING SYSTEM NOT FOUND — Contact Dell (see page 126).

Media Card Reader Problems

NO DRIVE LETTER IS ASSIGNED — When Microsoft Windows XP detects the Media Card Reader, the device is automatically assigned a drive letter as the next logical drive after all other physical drives in the system. If the next logical drive after the physical drives is mapped to a network drive, Windows XP does not automatically assign a drive letter to the Media Card Reader.

To manually assign a drive for the Media Card Reader:

- 1 Right-click My Computer and select **Manage**.
- 2 Select the **Disk Management** option.
- 3 Right-click the corresponding drive letter in the right pane that needs to be changed.
- 4 Select **Drive Letter and Paths**.
- 5 From the drop-down list, select the new drive letter assignment for the Media Card Reader.
- 6 Click **OK** to confirm your selection.

NOTE: The Media Card Reader appears as a mapped drive only when it is connected. Each of the four Media Card Reader slots are mapped to a drive even if no media is installed. If you attempt to access the Media Card Reader when no media is inserted, you are prompted to insert media.

FLEXBAY DEVICE IS DISABLED — There is a FlexBay disable option in the BIOS setup that appears only when the FlexBay device is installed. If the FlexBay device is physically installed, but it is not running, check to see if it is enabled in the BIOS setup.

Keyboard Problems



CAUTION: Before you begin any of the procedures in this section, follow the safety instructions in the *Product Information Guide*.

CHECK THE KEYBOARD CABLE —

- Ensure that the keyboard cable is firmly connected to the computer.
- Shut down the computer (see page 63), reconnect the keyboard cable as shown on the setup diagram for your computer, and then restart the computer.
- Check the cable connector for bent or broken pins and for damaged or frayed cables. Straighten bent pins.
- Remove keyboard extension cables and connect the keyboard directly to the computer.

TEST THE KEYBOARD — Connect a properly working keyboard to the computer, and try using the keyboard.

RUN THE HARDWARE TROUBLESHOOTER — See page 60.

Lockups and Software Problems



CAUTION: Before you begin any of the procedures in this section, follow the safety instructions in the *Product Information Guide*.

The computer does not start up

CHECK THE DIAGNOSTIC LIGHTS — See page 53.

ENSURE THAT THE POWER CABLE IS FIRMLY CONNECTED TO THE COMPUTER AND TO THE ELECTRICAL OUTLET

The computer stops responding



NOTICE: You might lose data if you are unable to perform an operating system shutdown.

TURN THE COMPUTER OFF — If you are unable to get a response by pressing a key on your keyboard or moving your mouse, press and hold the power button for at least 8 to 10 seconds until the computer turns off. Then restart your computer.

A program stops responding

END THE PROGRAM —

- 1 Press <Ctrl><Shift><Esc> simultaneously.
- 2 Click Applications.
- 3 Click the program that is no longer responding.
- 4 Click End Task.

A program crashes repeatedly



NOTE: Software usually includes installation instructions in its documentation or on a floppy or CD.

CHECK THE SOFTWARE DOCUMENTATION — If necessary, uninstall and then reinstall the program.

A program is designed for an earlier Windows operating system

RUN THE PROGRAM COMPATIBILITY WIZARD — The Program Compatibility Wizard configures a program so it runs in an environment similar to non-Windows XP operating system environments.

- 1 Click the **Start** button, point to **All Programs**→**Accessories**, and then click **Program Compatibility Wizard**.
- 2 In the welcome screen, click **Next**.
- 3 Follow the instructions on the screen.

A solid blue screen appears

TURN THE COMPUTER OFF — If you are unable to get a response by pressing a key on your keyboard or moving your mouse, press and hold the power button for at least 8 to 10 seconds until the computer turns off. Then restart your computer.

Other software problems

CHECK THE SOFTWARE DOCUMENTATION OR CONTACT THE SOFTWARE MANUFACTURER FOR TROUBLESHOOTING INFORMATION —

- Ensure that the program is compatible with the operating system installed on your computer.
- Ensure that your computer meets the minimum hardware requirements needed to run the software. See the software documentation for information.
- Ensure that the program is installed and configured properly.
- Verify that the device drivers do not conflict with the program.
- If necessary, uninstall and then reinstall the program.

BACK UP YOUR FILES IMMEDIATELY

USE A VIRUS-SCANNING PROGRAM TO CHECK THE HARD DRIVE, FLOPPY DISKS, OR CDS

SAVE AND CLOSE ANY OPEN FILES OR PROGRAMS AND SHUT DOWN YOUR COMPUTER THROUGH THE START MENU

Memory Problems



CAUTION: Before you begin any of the procedures in this section, follow the safety instructions in the *Product Information Guide*.

IF YOU RECEIVE AN INSUFFICIENT MEMORY MESSAGE —

- Save and close any open files and exit any open programs you are not using to see if that resolves the problem.
- See the software documentation for minimum memory requirements. If necessary, install additional memory (see page 74).
- Reseat the memory modules (see page 74) to ensure that your computer is successfully communicating with the memory.
- Run the Dell Diagnostics (see page 56).

IF YOU EXPERIENCE OTHER MEMORY PROBLEMS —

- Reseat the memory modules (see page 74) to ensure that your computer is successfully communicating with the memory.
- Ensure that you are following the memory installation guidelines (see page 74).
- Your computer supports DDR2 memory. For more information about the type of memory supported by your computer, see "Memory" on page 109.
- Run the Dell Diagnostics (see page 56).

Mouse Problems



CAUTION: Before you begin any of the procedures in this section, follow the safety instructions in the *Product Information Guide*.

CLEAN THE MOUSE — For instructions on cleaning the mouse, see "Mouse" on page 123.

CHECK THE MOUSE CABLE —

- 1 Remove mouse extension cables, if used, and connect the mouse directly to the computer.
- 2 Reconnect the mouse cable as shown on the setup diagram for your computer.

RESTART THE COMPUTER —

- 1 Simultaneously press <Ctrl><Esc> to display the **Start** menu.
- 2 Type u, press the keyboard arrow keys to highlight **Shut down** or **Turn Off**, and then press <Enter>.
- 3 After the computer turns off, reconnect the mouse cable as shown on the on the setup diagram for your computer.
- 4 Start the computer.

TEST THE MOUSE — Connect a properly working mouse to the computer, and try using the mouse.

CHECK THE MOUSE SETTINGS —

- 1 Click the **Start** button, click **Control Panel**, and then click **Printers and Other Hardware**.
- 2 Click **Mouse**.
- 3 Try adjusting the settings.

REINSTALL THE MOUSE DRIVER — See page 58.

RUN THE HARDWARE TROUBLESHOOTER — See page 60.

Network Problems



CAUTION: Before you begin any of the procedures in this section, follow the safety instructions in the *Product Information Guide*.

CHECK THE NETWORK CABLE CONNECTOR — Ensure that the network cable is firmly inserted into both the network connector on the back of the computer and the network jack.

CHECK THE NETWORK LIGHTS ON THE BACK OF THE COMPUTER — If the link integrity light is off, that indicates no network communication exists. Replace the network cable. For a description of network lights, see "Controls and Lights" on page 112.

RESTART THE COMPUTER AND LOG ON TO THE NETWORK AGAIN

CHECK YOUR NETWORK SETTINGS — Contact your network administrator or the person who set up your network to verify that your network settings are correct and that the network is functioning.

RUN THE HARDWARE TROUBLESHOOTER — See page 60.

Power Problems



CAUTION: Before you begin any of the procedures in this section, follow the safety instructions in the *Product Information Guide*.

IF THE POWER LIGHT IS GREEN AND THE COMPUTER IS NOT RESPONDING — See "Dell Diagnostics" on page 56.

IF THE POWER LIGHT IS BLINKING GREEN — The computer is in standby mode. Press a key on the keyboard, move the mouse, or press the power button to resume normal operation.

IF THE POWER LIGHT IS OFF — The computer is either turned off or is not receiving power.

- Reseat the power cable into both the power connector on the back of the computer and the electrical outlet.
- If the computer is plugged into a power strip, ensure that the power strip is plugged into an electrical outlet and that the power strip is turned on. Also bypass power protection devices, power strips, and power extension cables to verify that the computer turns on properly.
- Ensure that the electrical outlet is working by testing it with another device, such as a lamp.
- Ensure that the main power cable and front panel cable are securely connected to the system board (see page 71).

IF THE POWER LIGHT IS STEADY AMBER — A device might be malfunctioning or incorrectly installed.

- Remove and then reinstall the memory modules (see page 74).
- Remove and then reinstall any cards (see page 76).
- Remove and then reinstall the graphics card, if applicable (see page 76).

IF THE POWER LIGHT IS BLINKING AMBER — The computer is receiving electrical power, but an internal power problem might exist.

- Ensure that the voltage selection switch is set to match the AC power at your location (if applicable).
- Ensure that the processor power cable is securely connected to the system board (see page 71).

ELIMINATE INTERFERENCE — Some possible causes of interference are:

- Power, keyboard, and mouse extension cables
- Too many devices on a power strip
- Multiple power strips connected to the same electrical outlet

Printer Problems

 **CAUTION:** Before you begin any of the procedures in this section, follow the safety instructions in the *Product Information Guide*.

 **NOTE:** If you need technical assistance for your printer, contact the printer's manufacturer.

CHECK THE PRINTER DOCUMENTATION — See the printer documentation for setup and troubleshooting information.

ENSURE THAT THE PRINTER IS TURNED ON

CHECK THE PRINTER CABLE CONNECTIONS —

- See the printer documentation for cable connection information.
- Ensure that the printer cables are securely connected to the printer and the computer (see page 13).

TEST THE ELECTRICAL OUTLET — Ensure that the electrical outlet is working by testing it with another device, such as a lamp.

VERIFY THAT THE PRINTER IS RECOGNIZED BY WINDOWS —

- 1 Click the **Start** button, click **Control Panel**, and then click **Printers and Other Hardware**.
- 2 Click **View installed printers or fax printers**.
If the printer is listed, right-click the printer icon.
- 3 Click **Properties** and click the **Ports** tab. For a USB printer, ensure that the **Print to the following port(s):** setting is **USB**.

REINSTALL THE PRINTER DRIVER — See the printer documentation for instructions.

Scanner Problems

 **CAUTION:** Before you begin any of the procedures in this section, follow the safety instructions in the *Product Information Guide*.

 **NOTE:** If you need technical assistance for your scanner, contact the scanner's manufacturer.

CHECK THE SCANNER DOCUMENTATION — See the scanner documentation for setup and troubleshooting information.

UNLOCK THE SCANNER — Ensure that your scanner is unlocked if it has a locking tab or button.

RESTART THE COMPUTER AND TRY THE SCANNER AGAIN

CHECK THE CABLE CONNECTIONS —

- See the scanner documentation for cable connection information.
- Ensure that the scanner cables are securely connected to the scanner and the computer.

VERIFY THAT THE SCANNER IS RECOGNIZED BY MICROSOFT WINDOWS —

1 Click the Start button, click Control Panel, and then click Printers and Other Hardware.

2 Click Scanners and Cameras.

If your scanner is listed, Windows recognizes the scanner.

REINSTALL THE SCANNER DRIVER — See the scanner documentation for instructions.

Sound and Speaker Problems



CAUTION: Before you begin any of the procedures in this section, follow the safety instructions in the *Product Information Guide*.

No sound from speakers



NOTE: The volume control in some MP3 players overrides the Windows volume setting. If you have been listening to MP3 songs, ensure that you did not turn the player volume down or off.

CHECK THE SPEAKER CABLE CONNECTIONS — Ensure that the speakers are connected as shown on the setup diagram supplied with the speakers. If you purchased a sound card, ensure that the speakers are connected to the card.

ENSURE THAT THE SUBWOOFER AND THE SPEAKERS ARE TURNED ON — See the setup diagram supplied with the speakers. If your speakers have volume controls, adjust the volume, bass, or treble to eliminate distortion.

ADJUST THE WINDOWS VOLUME CONTROL — Click or double-click the speaker icon in the lower-right corner of your screen. Ensure that the volume is turned up and that the sound is not muted.

DISCONNECT HEADPHONES FROM THE HEADPHONE CONNECTOR — Sound from the speakers is automatically disabled when headphones are connected to the computer's front-panel headphone connector.

TEST THE ELECTRICAL OUTLET — Ensure that the electrical outlet is working by testing it with another device, such as a lamp.

ELIMINATE POSSIBLE INTERFERENCE — Turn off nearby fans, fluorescent lights, or halogen lamps to check for interference.

REINSTALL THE SOUND DRIVER — See page 59.

RUN THE HARDWARE TROUBLESHOOTER — See page 60.

No sound from headphones

CHECK THE HEADPHONE CABLE CONNECTION — Ensure that the headphone cable is securely inserted into the headphone connector (see page 66).

ADJUST THE WINDOWS VOLUME CONTROL — Click or double-click the speaker icon in the lower-right corner of your screen. Ensure that the volume is turned up and that the sound is not muted.

Video and Monitor Problems



CAUTION: Before you begin any of the procedures in this section, follow the safety instructions in the *Product Information Guide*.



NOTE: See the monitor documentation for troubleshooting procedures.

If the screen is blank

CHECK THE MONITOR CABLE CONNECTION —

- Ensure that the graphics cable is connected as shown on the setup diagram for your computer.
- If you are using a graphics extension cable and removing the cable solves the problem, the cable is defective.
- Swap the computer and monitor power cables to determine if the power cable is defective.
- Check the connector for bent or broken pins. (It is normal for monitor cable connectors to have missing pins.)

CHECK THE MONITOR POWER LIGHT — If the power light is off, firmly press the button to ensure that the monitor is turned on. If the power light is lit or blinking, the monitor has power. If the power light is blinking, press a key on the keyboard or move the mouse.

TEST THE ELECTRICAL OUTLET — Ensure that the electrical outlet is working by testing it with another device, such as a lamp.

CHECK THE DIAGNOSTIC LIGHTS — See page 53.

If the screen is difficult to read

CHECK THE MONITOR SETTINGS — See the monitor documentation for instructions on adjusting the contrast and brightness, demagnetizing (degaussing) the monitor, and running the monitor self-test.

MOVE THE SUBWOOFER AWAY FROM THE MONITOR — If your speaker system includes a subwoofer, ensure that the subwoofer is at least 60 cm (2 ft) away from the monitor.

MOVE THE MONITOR AWAY FROM EXTERNAL POWER SOURCES — Fans, fluorescent lights, halogen lamps, and other electrical devices can cause the screen image to appear "shaky." Turn off nearby devices to check for interference.

ROTATE THE MONITOR TO ELIMINATE SUNLIGHT GLARE AND POSSIBLE INTERFERENCE

ADJUST THE WINDOWS DISPLAY SETTINGS —













- 1** Click the **Start** button, click **Control Panel**, and then click **Appearance and Themes**.
- 2** Click **Display** and click the **Settings** tab.
- 3** Try different settings for **Screen resolution** and **Color quality**.





Troubleshooting Tools





Diagnostic Lights

 **CAUTION:** Before you begin any of the procedures in this section, follow the safety instructions in the *Product Information Guide*.

To help you troubleshoot a problem, your computer has four lights labeled "1," "2," "3," and "4" on the front panel (see page 65). When the computer starts normally, the lights flash. After the computer starts, all four lights display solid green. If the computer malfunctions, the color and sequence of the lights identify the problem.

Light Pattern	Problem Description	Suggested Resolution
   	<p>The computer is in a normal "off" condition or a possible pre-BIOS failure has occurred.</p> <p>All four diagnostic lights display solid green and then turn off after the system successfully boots to the operating system.</p>	Plug the computer into a working electrical outlet. Also see "Power Problems" on page 47.
   	A possible processor failure has occurred.	If the problem persists, contact Dell (see page 126).
   	Memory modules are detected, but a memory failure has occurred.	<ul style="list-style-type: none"> • If you have two or more memory modules installed, remove the modules, reinstall one module (see page 74), and then restart the computer. If the computer starts normally, reinstall an additional module. Continue until you have identified a faulty module or reinstalled all modules without error. • If available, install properly working memory of the same type into your computer (see page 74). • If the problem persists, contact Dell (see page 126).

Light Pattern	Problem Description	Suggested Resolution
	A possible graphics card failure has occurred.	<ul style="list-style-type: none"> • If the computer has a graphics card, remove the card (see page 76), reinstall it, and then restart the computer. • If the problem still exists, install a graphics card that you know works and restart the computer. • If the problem persists, contact Dell (see page 126).
	A possible floppy drive or hard drive failure has occurred.	Reseat all power and data cables and restart the computer.
	A possible USB failure has occurred.	Reinstall all USB devices, check cable connections, and then restart the computer.
	No memory modules are detected.	<ul style="list-style-type: none"> • If you have two or more memory modules installed, remove the modules, reinstall one module (see page 74), and then restart the computer. If the computer starts normally, reinstall an additional module. Continue until you have identified a faulty module or reinstalled all modules without error. • If available, install properly working memory of the same type into your computer (see page 74). • If the problem persists, contact Dell (see page 126).
	Memory modules are detected, but a memory configuration or compatibility error exists.	<ul style="list-style-type: none"> • Ensure that no special memory module/memory connector placement requirements exist (see page 72). • Verify that the memory modules that you are installing are compatible with your computer (see page 72). • If the problem persists, contact Dell (see page 126).

Light Pattern	Problem Description	Suggested Resolution
	<p>A possible expansion card failure has occurred.</p>	<ol style="list-style-type: none"> 1 Determine if a conflict exists by removing a card (not a graphics card) and restarting the computer (see page 76). 2 If the problem persists, reinstall the card that you removed, remove a different card, and then restart the computer. 3 Repeat this process for each card. If the computer starts normally, troubleshoot the last card removed from the computer for resource conflicts (see page 59). 4 If the problem persists, contact Dell (see page 126).
	<p>The system is operating in the quick resume mode. See "Using Intel® Viiv™ Quick Resume Technology (Optional)" on page 36 for additional information.</p>	<ul style="list-style-type: none"> • Press the power button • Move the mouse • Press any key on the keyboard • Press any key on the optional MCE remote control
	<p>Another failure has occurred.</p>	<ul style="list-style-type: none"> • Ensure that the cables are properly connected to the system board from the hard drive, CD drive, and DVD drive (see page 71). • If there is an error message on your screen identifying a problem with a device (such as the floppy drive or hard drive), check the device to ensure that it is functioning properly. • The operating system is attempting to boot from a device (such as the floppy drive or hard drive); check system setup (see page 113) to make sure the boot sequence is correct for the devices installed on your computer. • If the problem persists, contact Dell (see page 126).
	<p>All four diagnostic lights display solid green and then turn off after the system successfully boots to the operating system.</p>	<p>None.</p>

Dell Diagnostics

 **CAUTION:** Before you begin any of the procedures in this section, follow the safety instructions in the *Product Information Guide*.

If you experience a problem with your computer, perform the checks in "Solving Problems" on page 37 and run the Dell Diagnostics before you contact Dell for technical assistance.

 **NOTICE:** The Dell Diagnostics works only on Dell™ computers.

- 1 Turn on (or restart) your computer.
- 2 When the DELL™ logo appears, press <F12> immediately.

If you wait too long and the operating system logo appears, continue to wait until you see the Microsoft® Windows® desktop. Then shut down your computer (see page 63) and try again.

- 3 When the boot device list appears, highlight **Boot to Utility Partition** and press <Enter>.
- 4 When the Dell Diagnostics **Main Menu** appears, select the test you want to run.

Dell Diagnostics Main Menu

- 1 After the Dell Diagnostics loads and the **Main Menu** screen appears, click the button for the option you want.

Option	Function
Express Test	Performs a quick test of devices. This test typically takes 10 to 20 minutes and requires no interaction on your part. Run Express Test first to increase the possibility of tracing the problem quickly.
Extended Test	Performs a thorough check of devices. This test typically takes 1 hour or more and requires you to answer questions periodically.
Custom Test	Tests a specific device. You can customize the tests you want to run.
Symptom Tree	Lists the most common symptoms encountered and allows you to select a test based on the symptom of the problem you are having.

- 2 If a problem is encountered during a test, a message appears with an error code and a description of the problem. Write down the error code and problem description and follow the instructions on the screen.

If you cannot resolve the error condition, contact Dell (see page 126).

 **NOTE:** The Service Tag for your computer is located at the top of each test screen. If you contact Dell, technical support will ask for your Service Tag.

- 3 If you run a test from the **Custom Test** or **Symptom Tree** option, click the applicable tab described in the following table for more information.

Tab	Function
Results	Displays the results of the test and any error conditions encountered.
Errors	Displays error conditions encountered, error codes, and the problem description.
Help	Describes the test and may indicate requirements for running the test.
Configuration	Displays your hardware configuration for the selected device. The Dell Diagnostics obtains configuration information for all devices from system setup, memory, and various internal tests, and it displays the information in the device list in the left pane of the screen. The device list may not display the names of all the components installed on your computer or all devices attached to your computer.
Parameters	Allows you to customize the test by changing the test settings.

- 4 Close the test screen to return to the **Main Menu** screen. To exit the Dell Diagnostics and restart the computer, close the **Main Menu** screen.

Drivers

What Is a Driver?

A driver is a program that controls a device such as a printer, mouse, or keyboard. All devices require a driver program.

A driver acts like a translator between the device and any other programs that use the device. Each device has its own set of specialized commands that only its driver recognizes.

Dell ships your computer to you with required drivers already installed—no further installation or configuration is needed.

Many drivers, such as the keyboard driver, come with your Microsoft® Windows® operating system. You may need to install drivers if you:

- Upgrade your operating system
- Reinstall your operating system
- Connect or install a new device

Identifying Drivers

If you experience a problem with any device, identify whether the driver is the source of your problem and, if necessary, update the driver.

Windows XP

- 1 Click the **Start** button and click **Control Panel**.
- 2 Under **Pick a Category**, click **Performance and Maintenance**.
- 3 Click **System**.
- 4 In the **System Properties** window, click the **Hardware** tab.
- 5 Click **Device Manager**.
- 6 Scroll down the list to see if any device has an exclamation point (a yellow circle with a [!]) on the device icon.

If an exclamation point is next to the device name, you may need to reinstall the driver or install a new driver.

Reinstalling Drivers



NOTICE: The Dell Support website at support.dell.com provides approved drivers for Dell™ computers. If you install drivers obtained from other sources, your computer might not work correctly.

Using Windows XP Device Driver Rollback

If a problem occurs on your computer after you install or update a driver, use Windows XP Device Driver Rollback to replace the driver with the previously installed version.

- 1 Click the **Start** button and click **Control Panel**.
- 2 Under **Pick a Category**, click **Performance and Maintenance**.
- 3 Click **System**.
- 4 In the **System Properties** window, click the **Hardware** tab.
- 5 Click **Device Manager**.
- 6 Right-click the device for which the new driver was installed and click **Properties**.
- 7 Click the **Drivers** tab.
- 8 Click **Roll Back Driver**.

If Device Driver Rollback does not resolve the problem, then use System Restore to return your computer to the operating state that existed before you installed the new driver.

Manually Reinstalling Drivers

- 1 After copying the required driver files to your hard drive, click the **Start** button and right-click **My Computer**.
- 2 Click **Properties**.
- 3 Click the **Hardware** tab and click **Device Manager**.
- 4 Double-click the type of device for which you are installing the driver.
- 5 Double-click the name of the device for which you are installing the driver.
- 6 Click the **Driver** tab and click **Update Driver**.
- 7 Click **Install from a list or specific location (Advanced)** and click **Next**.
- 8 Click **Browse** and browse to the location to which you previously extracted the driver files.
- 9 When the name of the appropriate driver appears, click **Next**.
- 10 Click **Finish** and restart your computer.

Resolving Software and Hardware Incompatibilities

If a device is either not detected during the operating system setup or is detected but incorrectly configured, you can use the Hardware Troubleshooter to resolve the incompatibility.

To resolve incompatibilities using the Hardware Troubleshooter:

- 1 Click the **Start** button and click **Help and Support**.
- 2 Type `hardware troubleshooter` in the **Search** field and click the arrow to start the search.
- 3 Click **Hardware Troubleshooter** in the **Search Results** list.
- 4 In the **Hardware Troubleshooter** list, click **I need to resolve a hardware conflict on my computer**, and click **Next**.

Restoring Your Operating System

You can restore your operating system in the following ways:

- Microsoft® Windows® XP System Restore returns your computer to an earlier operating state without affecting data files. Use System Restore as the first solution for restoring your operating system and preserving data files.
- Dell PC Restore by Symantec restores your hard drive to the operating state it was in when you purchased the computer. Dell PC Restore permanently deletes all data on the hard drive and removes any applications installed after you received the computer. Use PC Restore only if System Restore did not resolve your operating system problem.
- If you received an *Operating System* CD with your computer, you can use it to restore your operating system. However, using the *Operating System* CD also deletes all data on the hard drive. Use the CD *only* if System Restore did not resolve your operating system problem.

Using Microsoft Windows XP System Restore

The Microsoft Windows XP operating system provides System Restore to allow you to return your computer to an earlier operating state (without affecting data files) if changes to the hardware, software, or other system settings have left the computer in an undesirable operating state. See the Windows Help and Support Center for information on using System Restore. To access the Windows Help and Support Center, see [Windows Help and Support Center](#)

 **NOTICE:** Make regular backups of your data files. System Restore does not monitor your data files or recover them.

 **NOTE:** The procedures in this document were written for the Windows default view, so they may not apply if you set your Dell™ computer to the Windows Classic view.

Creating a Restore Point

- 1 Click the **Start** button and click **Help and Support**.
- 2 Click the task for **System Restore**.
- 3 Follow the instructions on the screen.

Restoring the Computer to an Earlier Operating State

If problems occur after you install a device driver, use Device Driver Rollback (see page 58) to resolve the problem. If that is unsuccessful, then use System Restore.

 **NOTICE:** Before you restore the computer to an earlier operating state, save and close any open files and exit any open programs. Do not alter, open, or delete any files or programs until the system restoration is complete.

- 1 Click the **Start** button, point to **All Programs**→**Accessories**→**System Tools**, and then click **System Restore**.
- 2 Ensure that **Restore my computer to an earlier time** is selected and click **Next**.
- 3 Click a calendar date to which you want to restore your computer.

The **Select a Restore Point** screen provides a calendar that allows you to see and select restore points. All calendar dates with available restore points appear in boldface type.

- 4 Select a restore point and click **Next**.

If a calendar date has only one restore point, then that restore point is automatically selected. If two or more restore points are available, click the restore point that you prefer.

- 5 Click **Next**.

The **Restoration Complete** screen appears after System Restore finishes collecting data and then the computer restarts.

- 6 After the computer restarts, click **OK**.

To change the restore point, you can either repeat the steps using a different restore point, or you can undo the restoration.

Undoing the Last System Restore

-  **NOTICE:** Before you undo the last system restore, save and close all open files and exit any open programs. Do not alter, open, or delete any files or programs until the system restoration is complete.
- 1 Click the **Start** button, point to **All Programs**→**Accessories**→**System Tools**, and then click **System Restore**.
 - 2 Click **Undo my last restoration** and click **Next**.

Enabling System Restore

If you reinstall Windows XP with less than 200 MB of free hard-disk space available, System Restore is automatically disabled. To see if System Restore is enabled:

- 1 Click the **Start** button and click **Control Panel**.
- 2 Click **Performance and Maintenance**.
- 3 Click **System**.
- 4 Click the **System Restore** tab.
- 5 Ensure that **Turn off System Restore** is unchecked.

Using Dell PC Restore by Symantec

-  **NOTICE:** Using Dell PC Restore permanently deletes all data on the hard drive and removes any applications or drivers installed after you received your computer. If possible, back up the data before using PC Restore. Use PC Restore only if System Restore did not resolve your operating system problem.

 **NOTE:** Dell PC Restore by Symantec is not available in all countries or on all computers.

Use Dell PC Restore by Symantec only as the last method to restore your operating system. PC Restore restores your hard drive to the operating state it was in when you purchased the computer. Any programs or files added since you received your computer—including data files—are permanently deleted from the hard drive. Data files include documents, spreadsheets, e-mail messages, digital photos, music files, and so on. If possible, back up all data before using PC Restore.

To use PC Restore:

- 1 Turn on the computer.
During the boot process, a blue bar with www.dell.com appears at the top of the screen.
- 2 Immediately upon seeing the blue bar, press <Ctrl><F11>.
If you do not press <Ctrl><F11> in time, let the computer finish starting, and then restart the computer again.

-  **NOTICE:** If you do not want to proceed with PC Restore, click **Reboot** in the following step.
- 3 On the next screen that appears, click **Restore**.

- 4 On the next screen, click **Confirm**.

The restore process takes approximately 6–10 minutes to complete.

- 5 When prompted, click **Finish** to reboot the computer.



NOTE: Do not manually shut down the computer. Click **Finish** and let the computer completely reboot.

- 6 When prompted, click **Yes**.

The computer restarts. Because the computer is restored to its original operating state, the screens that appear, such as the End User License Agreement, are the same ones that appeared the first time the computer was turned on.

- 7 Click **Next**.

The **System Restore** screen appears and the computer restarts.

- 8 After the computer restarts, click **OK**.

Removing Dell PC Restore



NOTICE: Removing Dell PC Restore from the hard drive permanently deletes the PC Restore utility from your computer. After you have removed Dell PC Restore, you will not be able to use it to restore your computer's operating system.

Dell PC Restore enables you to restore your hard drive to the operating state it was in when you purchased your computer. It is recommended that you *do not* remove PC Restore from your computer, even to gain additional hard-drive space. If you remove PC Restore from the hard drive, you cannot ever recall it, and you will never be able to use PC Restore to return your computer's operating system to its original state.

- 1 Log on to the computer as a local administrator.
- 2 In Windows Explorer, go to `c:\dell\utilities\DSR`.
- 3 Double-click the filename **DSRIRRemv2.exe**.



NOTE: If you do not log on as a local administrator, a message appears stating that you that you must log on as administrator. Click **Quit**, and then log on as a local administrator.



NOTE: If the partition for PC Restore does not exist on your computer's hard drive, a message appears stating that the partition was not found. Click **Quit**; there is no partition to delete.

- 4 Click **OK** to remove the PC Restore partition on the hard drive.
- 5 Click **Yes** when a confirmation message appears.

The PC Restore partition is deleted and the newly available disk space is added to the free space allocation on the hard drive.

- 6 Right-click **Local Disk (C)** in Windows Explorer, click **Properties**, and verify that the additional disk space is available as indicated by the increased value for **Free Space**.
- 7 Click **Finish** to close the **PC Restore Removal** window.
- 8 Restart the computer.

Removing and Installing Parts

Before You Begin

This chapter provides procedures for removing and installing the components in your computer. Unless otherwise noted, each procedure assumes that the following conditions exist:

- You have performed the steps in "Turn Off Your Computer" and "Before Working Inside Your Computer."
- You have read the safety information in your Dell™ *Product Information Guide*.
- A component can be replaced by performing the removal procedure in reverse order.

Recommended Tools

The procedures in this document may require the following tools:

- Small flat-blade screwdriver
- Phillips screwdriver
- Flash BIOS update program floppy disk or CD

Turn Off Your Computer

 **NOTICE:** To avoid losing data, save and close any open files and exit any open programs before you turn off your computer.

- 1 Shut down the operating system:
 - a Save and close any open files, exit any open programs, click the **Start** button, and then click **Turn Off Computer**.
 - b In the **Turn off computer** window, click **Turn off**.
The computer turns off after the operating system shutdown process finishes.
- 2 Ensure that the computer and any attached devices are turned off. If your computer and attached devices did not automatically turn off when you shut down your operating system, press and hold the power button for 4 seconds.

Before Working Inside Your Computer

Use the following safety guidelines to help protect your computer from potential damage and to help ensure your own personal safety.

 **CAUTION:** Before you begin any of the procedures in this section, follow the safety instructions in the *Product Information Guide*.

 **CAUTION:** Handle components and cards with care. Do not touch the components or contacts on a card. Hold a card by its edges or by its metal mounting bracket. Hold a component such as a processor by its edges, not by its pins.

 **NOTICE:** Only a certified service technician should perform repairs on your computer. Damage due to servicing that is not authorized by Dell is not covered by your warranty.

 **NOTICE:** When you disconnect a cable, pull on its connector or on its strain-relief loop, not on the cable itself. Some cables have a connector with locking tabs; if you are disconnecting this type of cable, press in on the locking tabs before you disconnect the cable. As you pull connectors apart, keep them evenly aligned to avoid bending any connector pins. Also, before you connect a cable, ensure that both connectors are correctly oriented and aligned.

 **NOTICE:** To avoid damaging the computer, perform the following steps before you begin working inside the computer.

1 Turn off your computer.

 **NOTICE:** To disconnect a network cable, first unplug the cable from your computer and then unplug it from the network wall jack.

2 Disconnect any telephone or telecommunication lines from the computer.



3 Disconnect your computer and all attached devices from their electrical outlets, and then press the power button to ground the system board.

 **NOTICE:** Before touching anything inside your computer, ground yourself by touching an unpainted metal surface, such as the metal at the back of the computer. While you work, periodically touch an unpainted metal surface to dissipate any static electricity that could harm internal components.

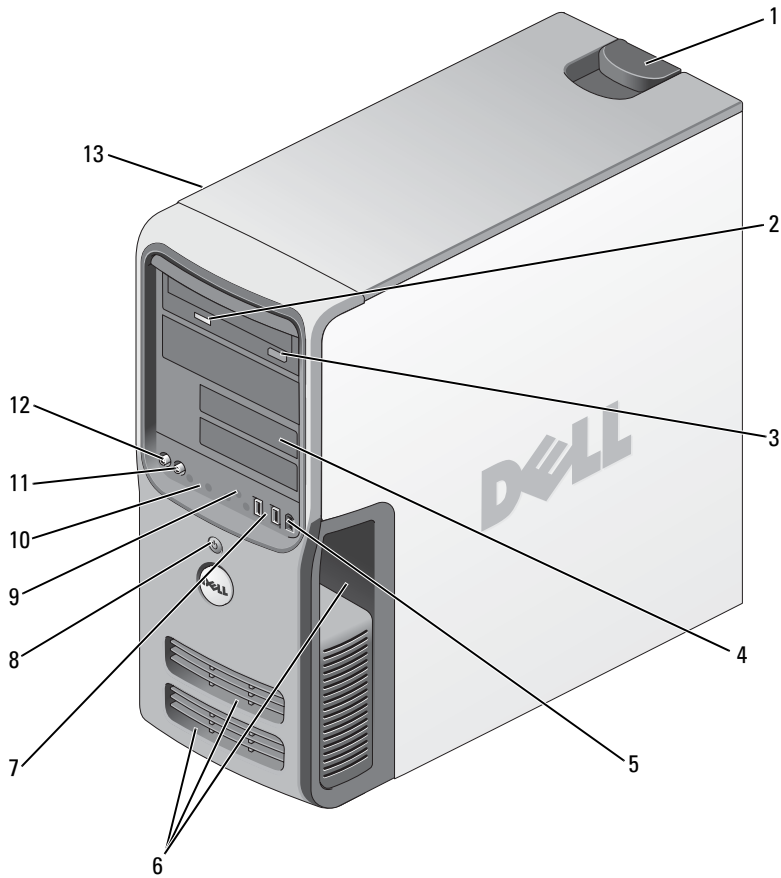
Front View of the Computer



1	cover latch release	Use this latch to remove the cover. See "Removing the Computer Cover" on page 68.
2	CD or DVD activity light	The drive light is on when the computer reads data from the CD or DVD drive.
3	CD or DVD eject button	Press to eject a disc from the CD or DVD drive.
4	FlexBay drives (2)	Can contain an optional floppy drive or optional Media Card Reader. For information on using the Media Card Reader, see "Using a Media Card Reader (Optional)" on page 20.

5	IEEE 1394 connector (optional)	Use the optional IEEE 1394 connector for high-speed data devices such as digital video cameras and external storage devices.
6	vents	<p>For adequate cooling, do not block any of the vents.</p> <p> NOTICE: Ensure that there is a minimum of two inches of space between all vents and any object near these vents.</p> <p> NOTICE: Keep the vent area clean and dust-free to ensure that the system is adequately ventilated. Use only a dry cloth to clean the vent area to avoid water damage to the system.</p>
7	USB 2.0 connectors (2)	Use the front USB connectors for devices that you connect occasionally, such as joysticks or cameras, or for bootable USB devices (see "System Setup Options" on page 116 for more information on booting to a USB device). It is recommended that you use the back USB connectors for devices that typically remain connected, such as printers and keyboards.
8	power button	<p>Press to turn on the computer.</p> <p> NOTICE: To avoid losing data, do not use the power button to turn off the computer. Instead, perform an operating system shutdown.</p>
9	hard-drive activity light	The hard drive activity light is on when the computer reads data from or writes data to the hard drive. The light might also be on when a device such as a CD player is operating.
10	diagnostic lights (4)	Use the lights to help you troubleshoot a computer problem based on the diagnostic code. For more information, see "Diagnostic Lights" on page 53.
11	headphone connector	Use the headphone connector to attach headphones and most kinds of speakers.
12	microphone connector	Use the microphone connector to attach a personal computer microphone for voice or musical input into a sound or telephony program.
13	Service Tag	Used to identify your computer when you access the Dell Support website or call technical support.

Back View of the Computer

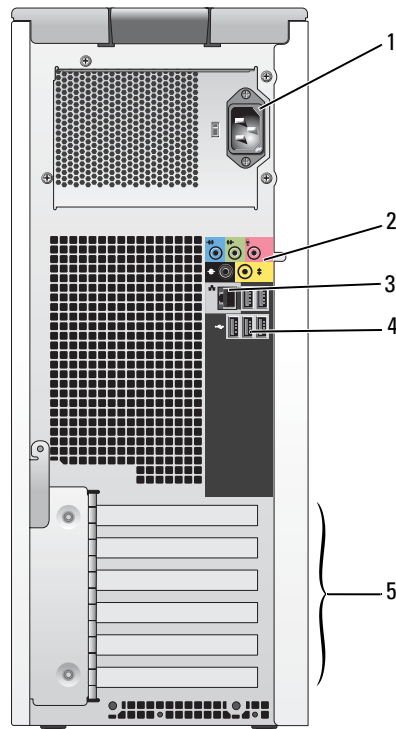

1	power connector	Insert the power cable.
2	sound card connectors (5)	<ul style="list-style-type: none">• Line-in connector — Use the blue line-in connector to attach a record/playback device such as a cassette player, CD player, or VCR.• Line-out connector — Use the green line-out connector to attach headphones and most speakers with integrated amplifiers.• Microphone connector — Use the pink microphone connector to attach a personal computer microphone for voice or musical input into a sound or telephony program.• Surround connector — Use the black surround connector to attach multichannel-capable speakers.• Center/subwoofer (Center/LFE) connector — Use the yellow subwoofer connector to attach multiple speakers.

3	network connector	<p>To attach your computer to a network or broadband device, connect one end of a network cable to either a network jack or your network or broadband device. Connect the other end of the network cable to the network connector on your computer. A click indicates that the network cable has been securely attached.</p> <p>NOTE: Do not plug a telephone cable into the network connector.</p> <p>On computers with a network connector card, use the connector on the card.</p> <p>It is recommended that you use Category 5 wiring and connectors for your network. If you must use Category 3 wiring, force the network speed to 10 Mbps to ensure reliable operation.</p>
4	USB 2.0 connectors (5)	<p>Use the back USB connectors for devices that typically remain connected, such as printers and keyboards.</p> <p>It is recommended that you use the front USB connectors for devices that you connect occasionally, such as joysticks or cameras, or for bootable USB devices.</p>
5	card slots (6)	<p>Access connectors for any installed PCI or PCI Express cards.</p>

Removing the Computer Cover



CAUTION: Before you begin any of the procedures in this section, follow the safety instructions in the *Product Information Guide*.



CAUTION: To guard against electrical shock, always unplug your computer from the electrical outlet before removing the cover.



NOTICE: Before touching anything inside your computer, ground yourself by touching an unpainted metal surface, such as the metal at the back of the computer. While you work, periodically touch an unpainted metal surface to dissipate any static electricity that could harm internal components.

1 Follow the procedures in "Before You Begin" on page 63.

2 If you have installed a security cable, remove it from the security cable slot.



NOTICE: Ensure that sufficient space exists to support the removed cover—at least 30 cm (1 ft) of desk top space.



NOTICE: Ensure that you are working on a level, protected surface to avoid scratching either the computer or the surface on which it is resting.

3 Lay your computer on its side with the computer cover facing up.

4 Pull back the cover latch release on the top panel.

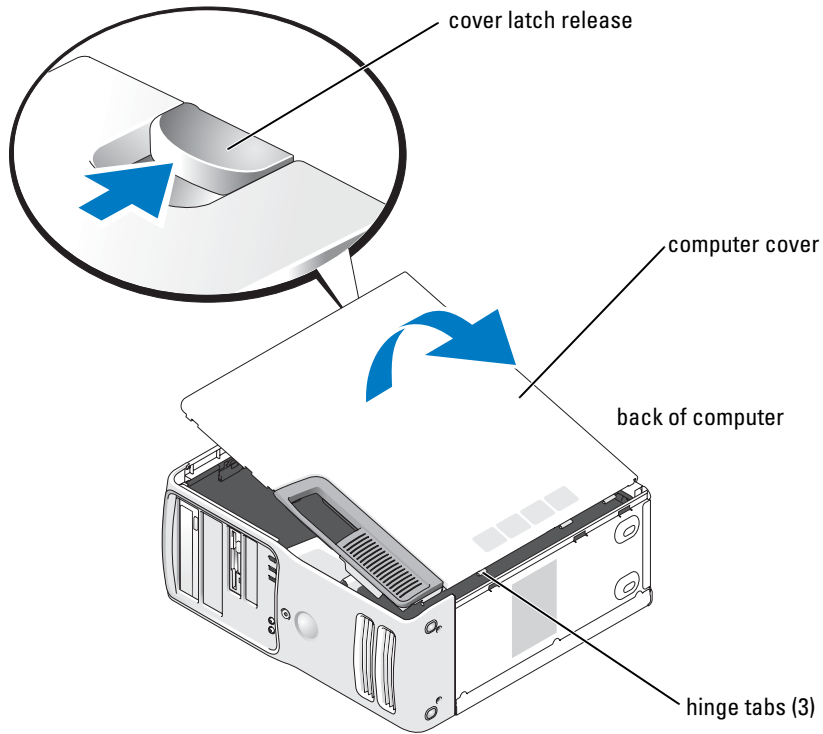

- 5** Locate the three hinge tabs on the bottom edge of the computer.
- 6** Grip the sides of the computer cover and pivot the cover up.
- 7** Lift the cover away and set it aside in a secure location.

Inside View of Your Computer

⚠ CAUTION: Before you begin any of the procedures in this section, follow the safety instructions in the *Product Information Guide*.

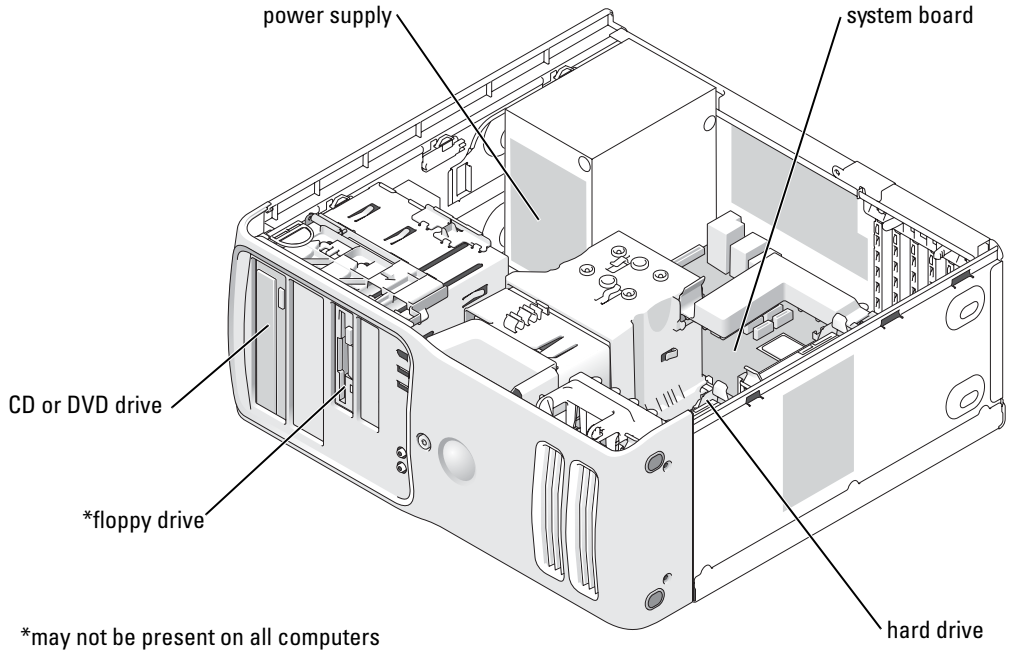

System Board Components

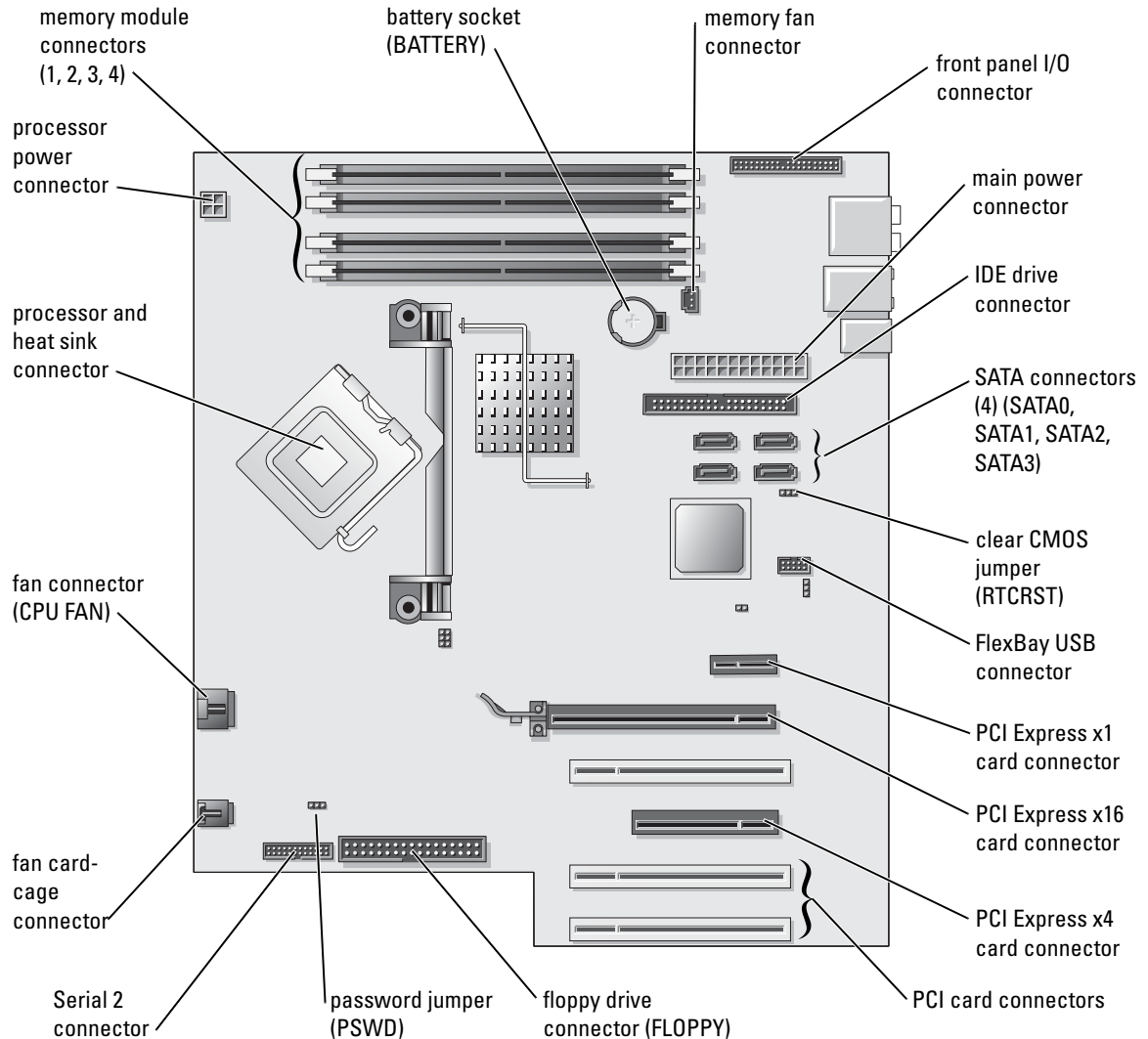

Memory

You can increase your computer memory by installing memory modules on the system board. For information on the type of memory supported by your computer, see "Specifications."

Memory Overview

- Memory modules should be installed in *pairs of matched memory size, speed, and technology*. If the memory modules are not installed in matched pairs, the computer will continue to operate, but with a slight reduction in performance. See the label in the upper-right corner of the module to determine the module's capacity.

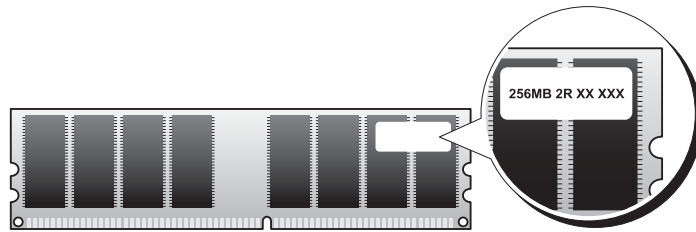



NOTE: Always install memory modules in the order indicated on the system board.

The recommended memory configurations are:

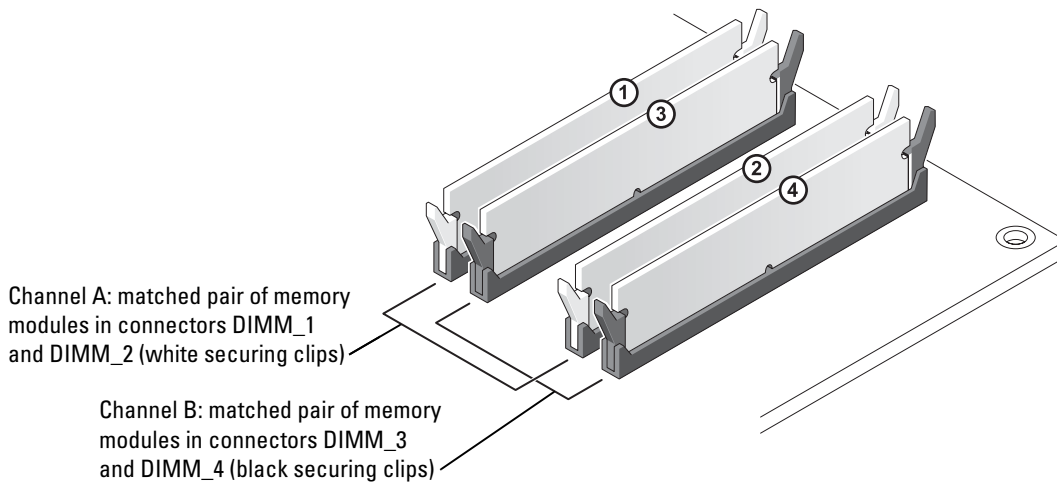
- A pair of matched memory modules installed in connectors DIMM_1 and DIMM_2
or
- A pair of matched memory modules installed in connectors DIMM_1 and DIMM_2 and another matched pair installed in connectors DIMM_3 and DIMM_4
- If you install mixed pairs of DDR2 400-MHz (PC2-3200), DDR2 533-MHz (PC2-4300) and DDR2 667-MHz (PC2-5300) memory, the modules function at the slowest speed installed.
- Be sure to install a single memory module in the DIMM_1 connector, the connector closest to the processor, before you install modules in the other connectors.
- While installing memory modules, ensure that you do not mix ECC and non-ECC memory.



 **NOTE:** Memory purchased from Dell is covered under your computer warranty.

 **NOTICE:** If you remove your original memory modules from the computer during a memory upgrade, keep them separate from any new modules that you may have, even if you purchased the new modules from Dell. If possible, *do not* pair an original memory module with a new memory module. Otherwise, your computer may not start properly. You should install your original memory modules in pairs either in connectors DIMM_1 and DIMM_2 or connectors DIMM_3 and DIMM_4.

Addressing Memory With 4-GB Configurations

Your computer supports a maximum of 4 GB of memory when you use four 1-GB DIMMs. Current operating systems, such as Microsoft® Windows® XP, can only use a maximum of 4 GB of address space; however, the amount of memory available to the operating system is less than 4 GB. Certain components within the computer require address space in the 4-GB range. Any address space reserved for these components cannot be used by computer memory.

Installing Memory

⚠ CAUTION: Before you begin any of the procedures in this section, follow the safety instructions in the *Product Information Guide*.

➡ NOTICE: To prevent static damage to components inside your computer, discharge static electricity from your body before you touch any of your computer's electronic components. You can do so by touching an unpainted metal surface on the computer.

- 1 Follow the procedures in "Before You Begin" on page 63.
- 2 Remove the computer cover (see page 68).
- 3 Lay the computer on its side so that the system board is on the bottom of the inside of the computer.
- 4 Press out the securing clip at each end of the memory module connector.

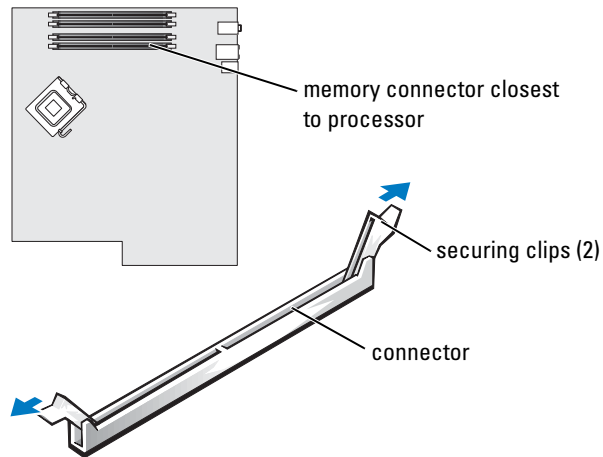

5 Align the notch on the bottom of the module with the crossbar in the connector.

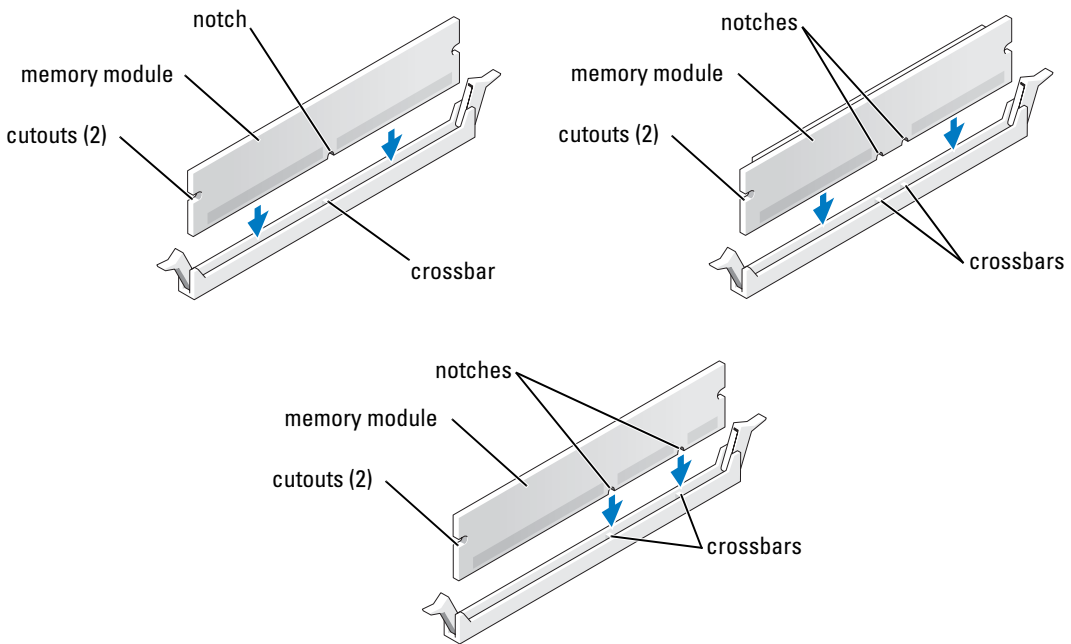

➔ **NOTICE:** To avoid damage to the memory module, press the module straight down into the connector while you apply equal force to each end of the module.

6 Insert the module into the connector until the module snaps into position.

If you insert the module correctly, the securing clips snap into the cutouts at each end of the module.

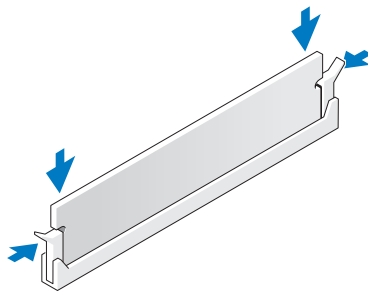

7 Close the computer cover.

-  **NOTICE:** To connect a network cable, first plug the cable into the network wall jack and then plug it into the computer.
- 8 Connect your computer and devices to electrical outlets, and turn them on.
- 9 Right-click the My Computer icon and click Properties.
- 10 Click the General tab.
- 11 To verify that the memory is installed correctly, check the amount of memory (RAM) listed.

Removing Memory



CAUTION: Before you begin any of the procedures in this section, follow the safety instructions in the *Product Information Guide*.



NOTICE: To prevent static damage to components inside your computer, discharge static electricity from your body before you touch any of your computer's electronic components. You can do so by touching an unpainted metal surface on the computer.

- 1 Follow the procedures in "Before You Begin" on page 63.
- 2 Remove the computer cover (see page 68).
- 3 Press out the securing clip at each end of the memory module connector.
- 4 Grasp the module and pull up.

If the module is difficult to remove, gently ease the module back and forth to remove it from the connector.

Cards



CAUTION: Before you begin any of the procedures in this section, follow the safety instructions in the *Product Information Guide*.



NOTICE: To prevent static damage to components inside your computer, discharge static electricity from your body before you touch any of your computer's electronic components. You can do so by touching an unpainted metal surface on the computer.

Your Dell™ computer provides the following slots for PCI and PCI Express cards:

- Three PCI card slots
- One PCI Express x1 card slot
- One PCI Express x16 card slot
- One PCI Express x4 card slot

PCI Cards

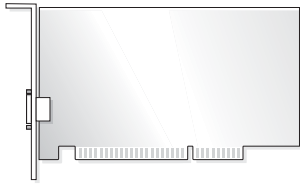

If you are installing or replacing a card, follow the procedures in the next section. If you are removing but not replacing a card, see "Removing a PCI Card" on page 80.

If you are replacing a card, remove the current driver for the card from the operating system.

If you are installing or replacing a PCI Express card, see "Installing a PCI Express Card" on page 82.

Installing a PCI Card

 **NOTE:** Dell offers an optional customer kit for Audigy II and IEEE 1394 PCI add-in-cards that includes a front-mounted IEEE 1394 connector.

- 1 Follow the procedures in "Before You Begin" on page 63.
- 2 Remove the computer cover (see page 68).

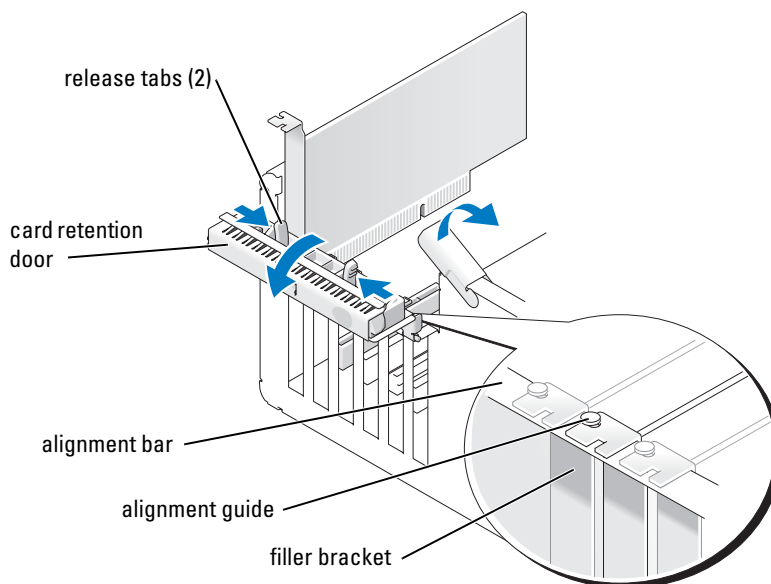

- 3 Push the two release tabs on the card retention door from the inside to pivot the door open. Because the door is captive, it will remain in the open position.

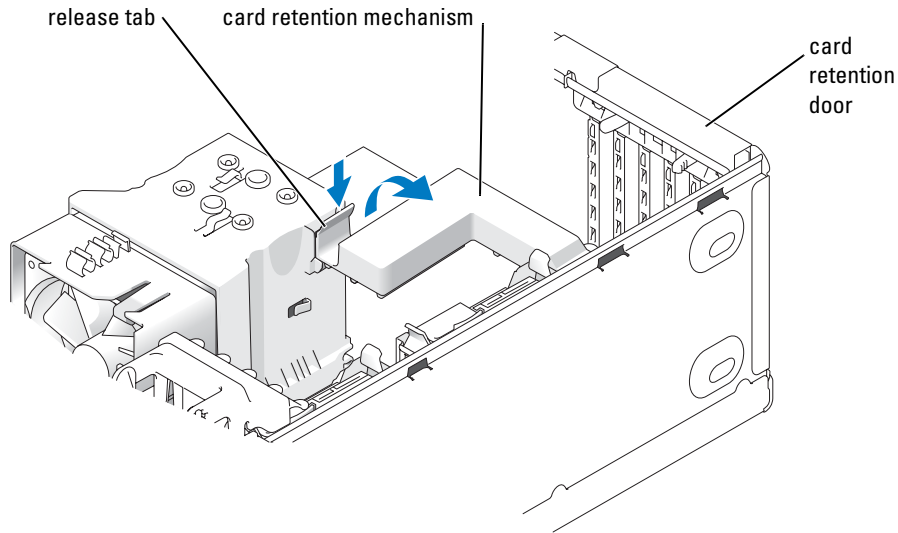

- 4 If your computer includes a card retention mechanism, to secure the x16 card in place from the top:
 - a Pivot the mechanism upward and gently press the release tab downward to release the mechanism from the two tab slots holding it in place.
 - b Set the retention mechanism aside in a secure location.
- 5 If you are installing a new card, remove the filler bracket to create a card-slot opening. Then continue with step 7.
- 6 If you are replacing a card that is already installed in the computer, remove the card.
If necessary, disconnect any cables connected to the card. Grasp the card by its top corners, and ease it out of its connector.
- 7 Prepare the card for installation.
See the documentation that came with the card for information on configuring the card, making internal connections, or otherwise customizing it for your computer.



CAUTION: Some network adapters automatically start the computer when they are connected to a network. To guard against electrical shock, be sure to unplug your computer from its electrical outlet before installing any cards.

- Place the card in the connector and press down firmly. Ensure that the card is fully seated in the slot.

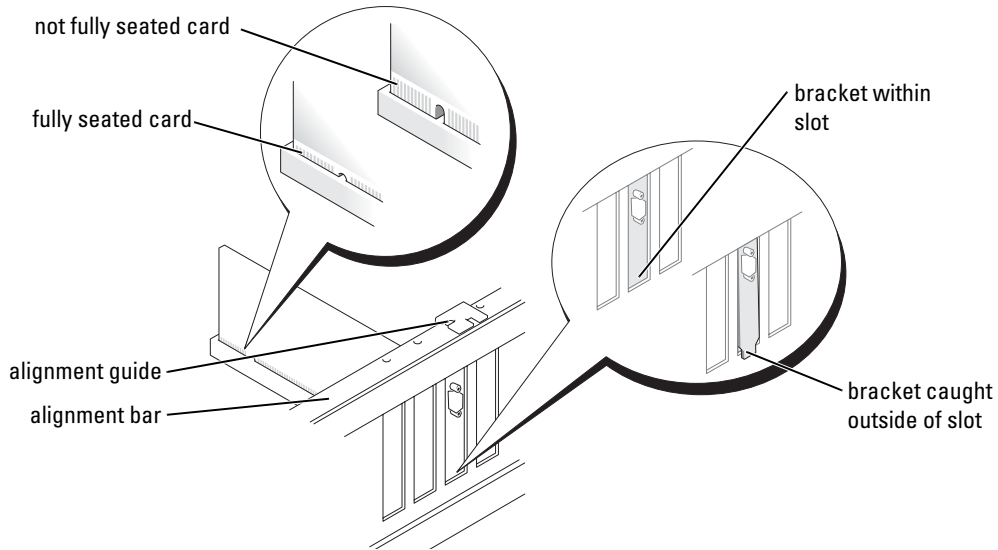

- Before you close the card retention door, ensure that:
 - The tops of all cards and filler brackets are flush with the alignment bar.
 - The notch in the top of the card or filler bracket fits around the alignment guide.

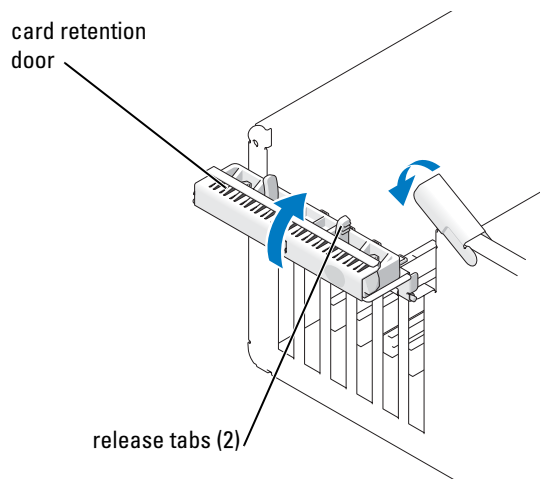

- 10 Close the card retention door by snapping it into place to secure the card(s).
- ➔ **NOTICE:** Do not route card cables over or behind the cards. Cables routed over the cards can prevent the computer cover from closing properly or cause damage to the equipment.
- 11 Connect any cables that should be attached to the card.
See the documentation for the card for information about the card cable connections.
- ➔ **NOTICE:** To connect a network cable, first plug the cable into the network device and then plug the cable into the computer.
- 12 If you replaced a card that was already installed in the computer and you removed the retention mechanism, you may reinstall the retention mechanism.
- 13 Before replacing the card retention mechanism, ensure that:
 - The tops of all cards and filler brackets are flush with the alignment bar.
 - The notch in the top of the card or filler bracket fits around the alignment guide.
- 14 Snap the card retention mechanism into place, securing the x16 PCI card.
- 15 Replace the computer cover, reconnect the computer and devices to electrical outlets, and then turn them on.
- 16 If you installed a sound card:
 - a Enter system setup, select **Integrated Audio Controller**, and then change the setting to **Off**.
 - b Connect external audio devices to the sound card connectors. Do not connect external audio devices to the microphone, speaker/headphone, or line-in connectors on the back panel.
- 17 If you installed an add-in network adapter and want to disable the integrated network adapter:
 - a Enter system setup, select **Integrated NIC Controller**, and then change the setting to **Off**.
 - b Connect the network cable to the add-in network adapter connectors. Do not connect the network cable to the integrated connector on the back panel.
- 18 Install any drivers required for the card as described in the card documentation.

Removing a PCI Card

- 1 Follow the procedures in "Before You Begin" on page 63.
- 2 Remove the computer cover (see page 68).
- 3 If you are removing the card permanently, install a filler bracket in the empty card-slot opening.
If you need a filler bracket, contact Dell (see page 126).

 **NOTE:** Installing filler brackets over empty card-slot openings is necessary to maintain FCC certification of the computer. The brackets also keep dust and dirt out of your computer.

 **NOTICE:** To connect a network cable, first plug the cable into the network device and then plug the cable into the computer.

- 4 Replace the computer cover, reconnect the computer and devices to electrical outlets, and then turn them on.
- 5 Remove the card driver from the operating system.
- 6 If you removed a sound card:
 - a Enter system setup, select **Integrated Audio Controller**, and then change the setting to **On**.
 - b Connect external audio devices to the audio connectors on the back panel of the computer.
- 7 If you removed an add-in network connector:
 - a Enter system setup, select **Integrated NIC Controller**, and then change the setting to **On**.
 - b Connect the network cable to the integrated connector on the back panel of the computer.

PCI Express Cards

Your computer supports:

- One PCI Express x1 card
- One PCI Express x16 card
- One PCI Express x4 card

If you are installing or replacing a PCI Express card, follow the procedures in the next section. If you are removing but not replacing a card, see "Removing a PCI Express Card" on page 86.

If you are replacing a card, remove the current driver for the card from the operating system.

If you are installing or replacing a PCI card, see "Installing a PCI Card" on page 77.

Installing a PCI Express Card

- 1 Follow the procedures in "Before You Begin" on page 63.

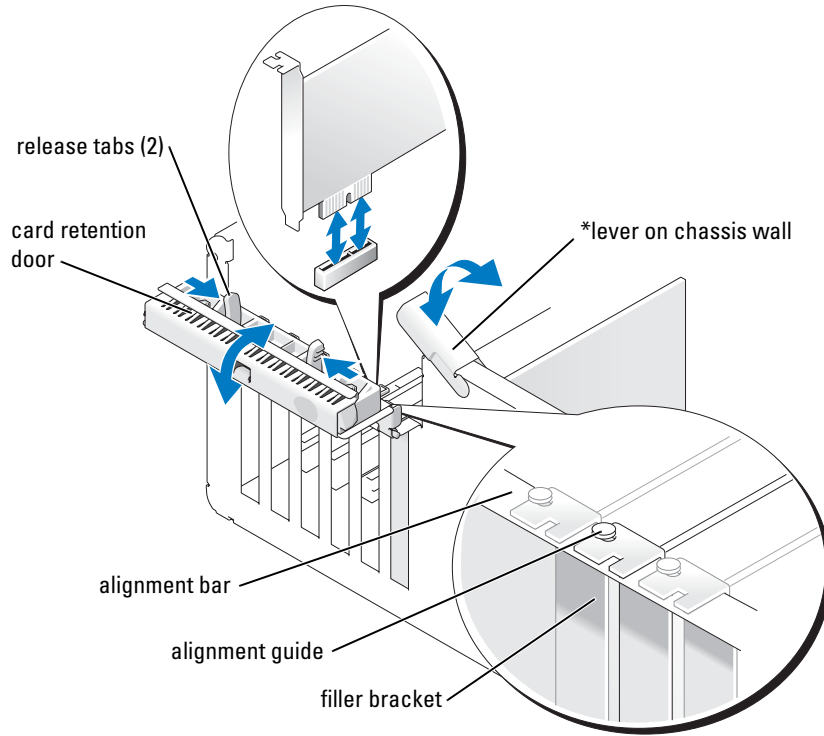

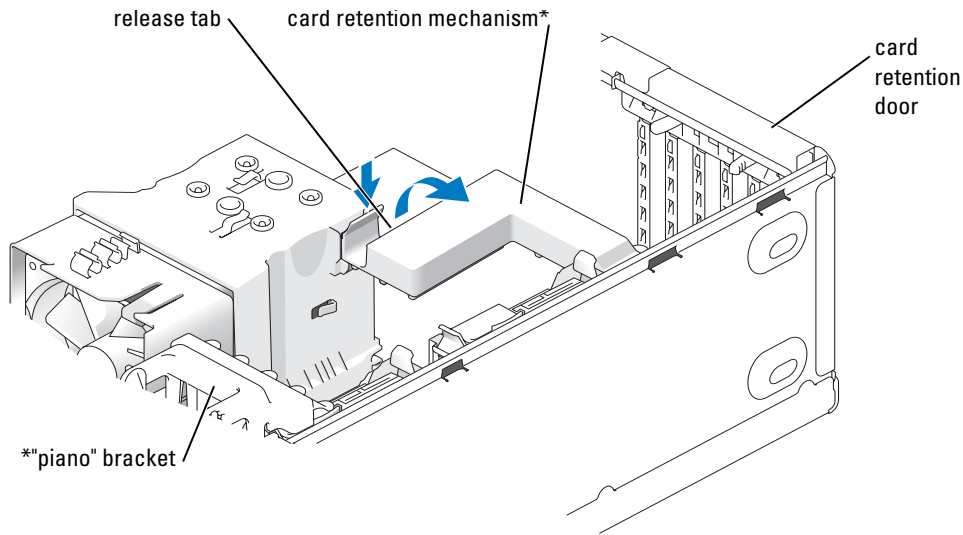

*may not be present on all computers

- 2 If present on your computer, rotate the lever on the chassis wall upward.
- 3 Push the two release tabs on the card retention door toward each other and pivot the door open. Because the door is captive, it will remain in the open position.



*may not be present on all computers

- 4 If your computer includes a card retention mechanism:
 - a Pivot the mechanism upward and gently squeeze in on the sides to release the mechanism from the two tab slots holding it in place.
 - b Set the retention mechanism aside in a secure location.
-  **NOTE:** For full-length PCI-E cards, if a "piano" bracket is present on your computer you need to rotate it upward by pressing the tabs on the side of the bracket toward each other.
- 5 If you are installing a new card, remove the filler bracket to create a card-slot opening. Then continue with step 7.
- 6 If you are replacing a card that is already installed in the computer, remove the existing card. If necessary, disconnect any cables connected to the card. If your card includes a retention mechanism, remove the top of the retention mechanism by pressing the tab and pulling up on the top.
-  **NOTE:** For full-length PCI-E cards, if a "piano" bracket is present on your computer you need to rotate it upward by pressing the tabs on the side of the bracket toward each other.

- 7 Pull the securing tab, grasp the card by its top corners, and then ease it out of its connector.

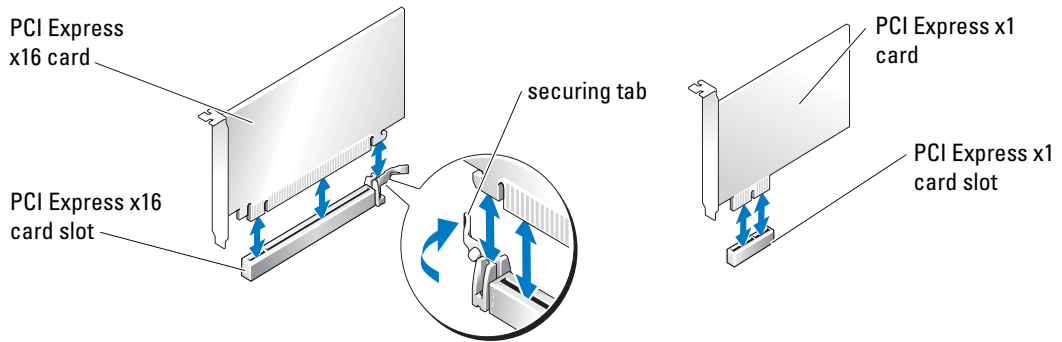

- 8 Prepare the card for installation.

See the documentation that came with the card for information on configuring the card, making internal connections, or otherwise customizing it for your computer.

CAUTION: Some network adapters automatically start the computer when they are connected to a network. To guard against electrical shock, be sure to unplug your computer from its electrical outlet before installing any cards.

- 9 If you are installing the card into the x16 card connector, position the card so that the securing slot is aligned with the securing tab.

NOTICE: Ensure that you release the securing tab to seat the card. If the card is not installed correctly, you may damage the system board.

- 10 Place the card in the connector and press down firmly. Ensure that the card is fully seated in the slot.

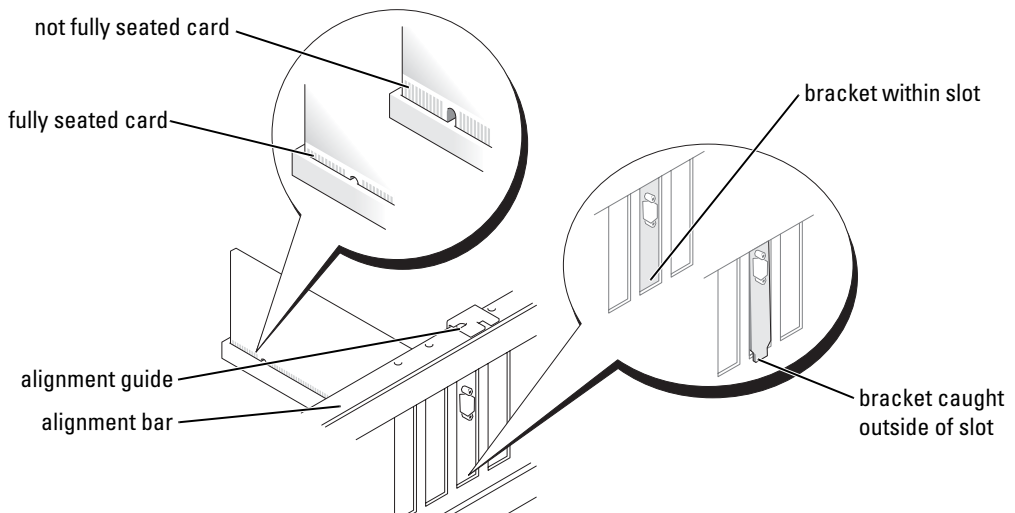

- 11 Ensure that:
- The tops of all cards and filler brackets are flush with the alignment bar.
 - The notch in the top of the card or filler bracket fits around the alignment guide.
- 12 If you removed a card retention mechanism, snap it into place, securing the x16 PCI-E card.

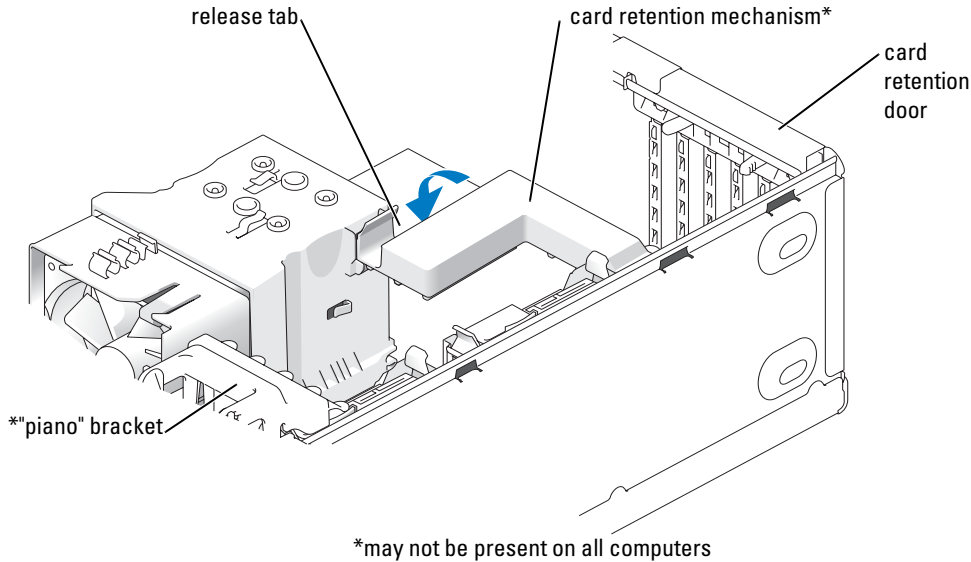

- ➔ **NOTICE:** Do not route card cables over or behind the cards. Cables routed over the cards can prevent the computer cover from closing properly or cause damage to the equipment.
- ➔ **NOTICE:** To connect a network cable, first plug the cable into the network device and then plug the cable into the computer.
- 🔧 **NOTE:** For full-length PCI-E cards, if a "piano" bracket is present on your computer you need to rotate it down into place.
- 13 Replace the computer cover, reconnect the computer and devices to electrical outlets, and then turn them on.
- 14 If you installed a sound card:
- a Enter system setup, select **Integrated Audio Controller**, and then change the setting to **Off**.
 - b Connect external audio devices to the sound card's connectors. Do not connect external audio devices to the microphone, speaker/headphone, or line-in connectors on the back panel.

- 15** If you installed an add-in network adapter and want to disable the integrated network adapter:
- a** Enter system setup select **Integrated NIC Controller**, and then change the setting to **Off**.
 - b** Connect the network cable to the add-in network adapter's connectors. Do not connect the network cable to the integrated connector on the back panel.
- 16** Install any drivers required for the card as described in the card documentation.

Removing a PCI Express Card

- 1** Follow the procedures in "Before You Begin" on page 63.
- 2** Remove the computer cover (see page 68).

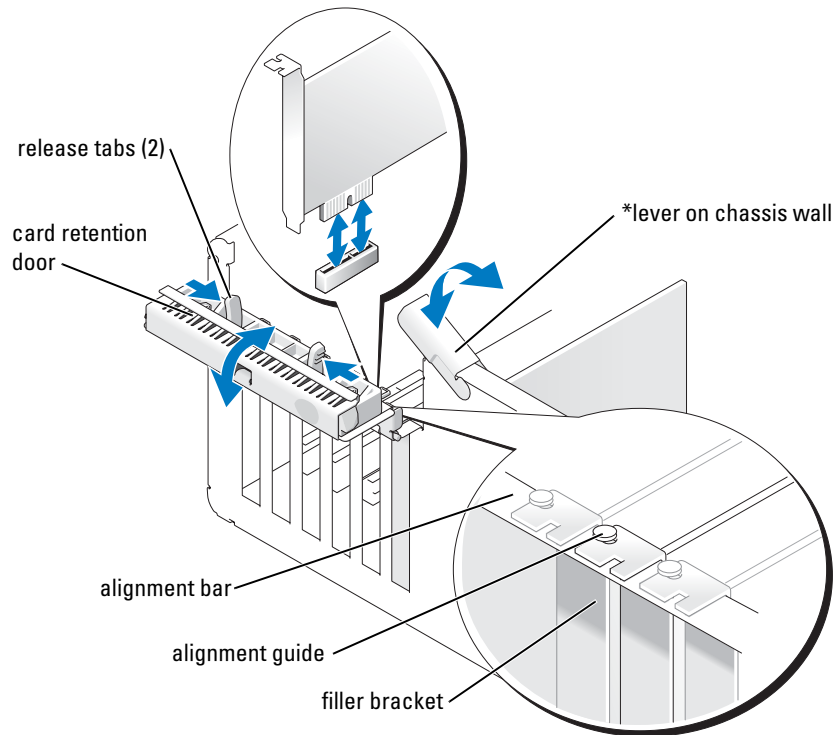

*may not be present on all computers

- 3** If present on your computer, rotate the lever on the chassis wall upward.

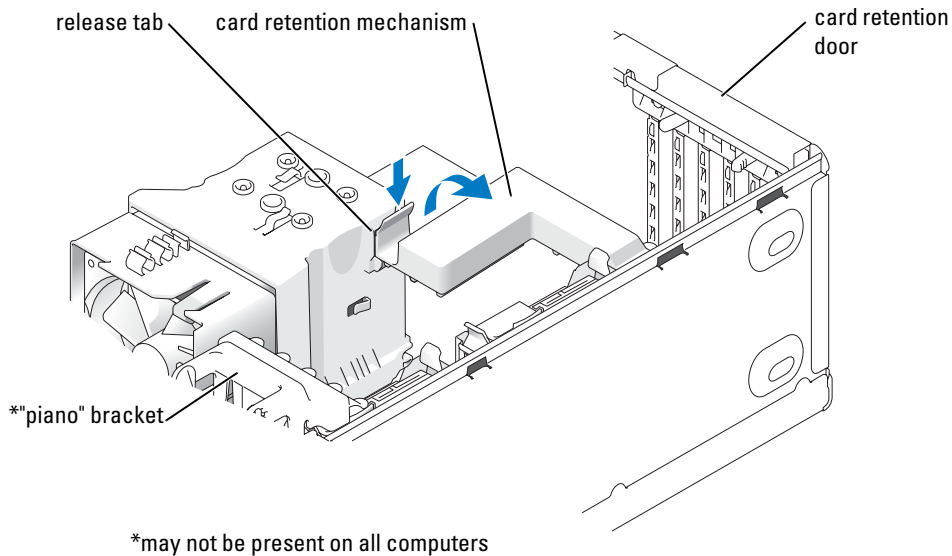

- 4 Push the two release tabs on the card retention door toward each other and pivot the door open. Because the door is captive, it will remain in the open position.

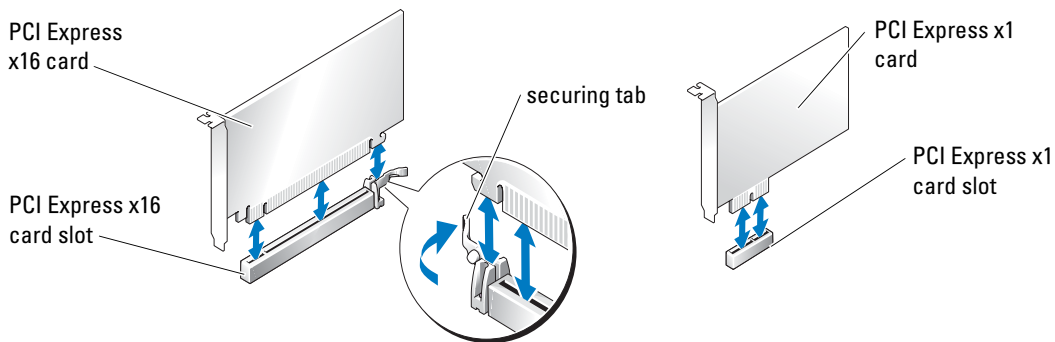

- 5 If your computer includes a card retention mechanism, to remove the x16 card:
- a Pivot the mechanism upward and gently squeeze in on the sides to release the mechanism from the two tab slots holding it in place.
 - b Set the retention mechanism aside in a secure location.

NOTE: For full-length PCI-E cards, if a "piano" bracket is present on your computer you need to rotate it upward by pressing the tabs on the side of the bracket toward each other.



- ➔ **NOTICE:** Ensure that you release the securing tab to unseat the card. If the card is not removed correctly, the system board may be damaged.
- 6 Release the securing tab on the card slot to unseat the card.
- 7 If you are removing the card permanently, install a filler bracket in the empty card-slot opening.
If you need a filler bracket, contact Dell (see page 126).
-  **NOTE:** Installing filler brackets over empty card-slot openings is necessary to maintain FCC certification of the computer. The brackets also keep dust and dirt out of your computer.
- 8 Reseat the card retention mechanism in the tabs and pivot downward to snap it into place.
- 9 Close the card retention door to snap it into place, securing the card(s).
-  **NOTE:** For full-length PCI-E cards, if a "piano" bracket is present on your computer you need to rotate it down into place.
- ➔ **NOTICE:** To connect a network cable, first plug the cable into the network device and then plug the cable into the computer.
- 10 Replace the computer cover, reconnect the computer and devices to electrical outlets, and then turn them on.
- 11 Remove the card driver from the operating system.
- 12 If you removed a sound card:
 - a Enter system setup, select **Integrated Audio Controller**, and then change the setting to **On**.
 - b Connect external audio devices to the audio connectors on the back panel of the computer.
- 13 If you removed an add-in network connector:
 - a Enter system setup, select **Integrated NIC Controller**, and then change the setting to **On**.
 - b Connect the network cable to the integrated connector on the back panel of the computer.
-  **NOTE:** Install any drivers required for the card as described in the card documentation.

Drive Panels

 **CAUTION:** Before you begin any of the procedures in this section, follow the safety instructions in the *Product Information Guide*.

 **CAUTION:** To guard against electrical shock, always unplug your computer from the electrical outlet before removing the cover.

Removing the Drive Panel

- 1 Follow the procedures in "Before You Begin" on page 63.

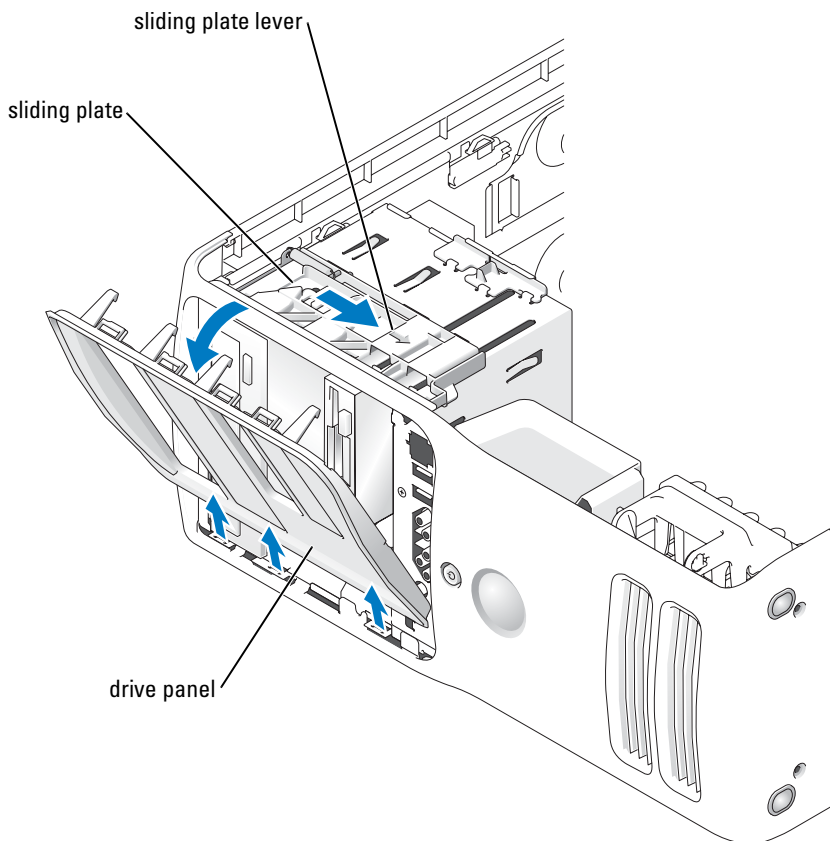

- 2 Grasping the lever on the sliding plate, pull the sliding plate to the right and hold in place.

 **NOTE:** The sliding plate secures and releases the drive panel and helps to secure the drives.

- 3 Push from the inside and pivot the drive panel to the left to release the panel from its side hinges.
- 4 Set the drive panel aside in a secure location.

Removing the Drive-Panel Insert

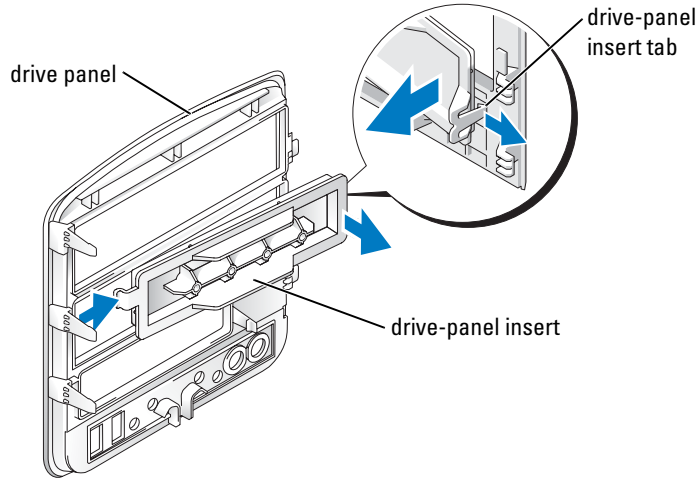

- 1 Turn the drive panel sideways and find the tip of the drive-panel insert tab that latches over a tab on the right side of the drive panel.
- 2 Pull the inner tip of the drive-panel insert tab away from the drive panel.
- 3 Pivot the drive-panel insert out and away from the drive panel.
- 4 Set the drive-panel insert aside in a secure location.

Replacing the Drive-Panel Insert

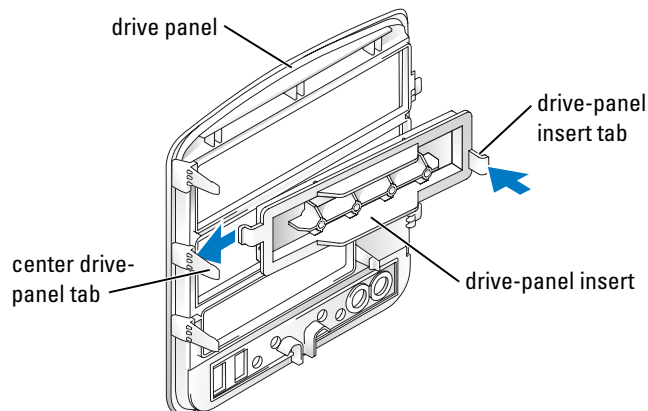

- 1 Slide the tab on the left side of the drive-panel insert under the center drive panel tab.
- 2 Rotate the drive-panel insert into place and snap the drive-panel insert tab over the corresponding tab on the drive panel.
- 3 Ensure that the drive-panel insert is correctly seated in the drive panel.

Replacing the Drive Panel

- 1 Follow the procedures in "Before You Begin" on page 63.

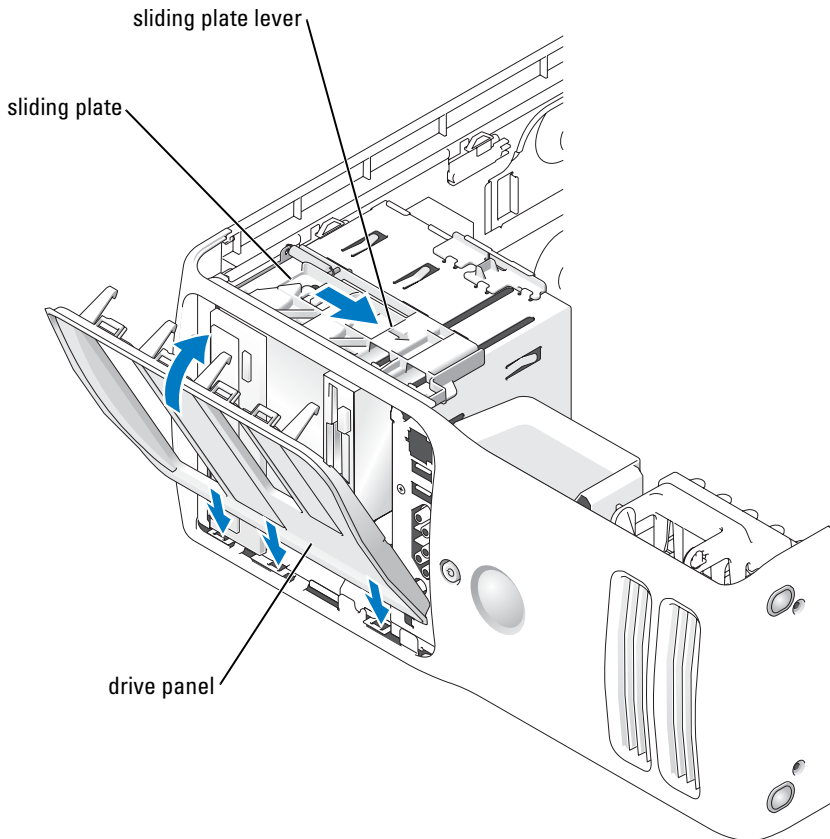

- 2 Align the drive panel tabs with the side-door hinges.
- 3 Rotate the drive panel toward the computer until the sliding plate lever clicks into place and the drive panel snaps into place on the front panel.

Drives

Your computer supports:

- Two hard drives (Serial ATA)
- Two FlexBay drives (can contain an optional floppy drive or optional Media Card Reader)
- Two CD or DVD drives

General Installation Guidelines

Connect hard drives to the connector labeled "SATA" and connect CD/DVD drives to the connector labeled "IDE".

Serial ATA hard drives should be connected to the connector labeled SATA on the system board. IDE CD/DVD drives should be connected to the connector labeled IDE.

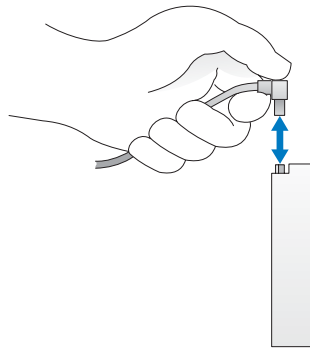

When connecting an IDE cable, ensure you align the colored stripe with the pin 1 connector. When disconnecting an IDE cable, grasp the colored pull tab and pull until the connector detaches.

When connecting and disconnecting a serial ATA cable, hold the cable by the connector at each end.

Hard Drive



CAUTION: Before you begin any of the procedures in this section, follow the safety instructions in the *Product Information Guide*.



CAUTION: To guard against electrical shock, always unplug your computer from the electrical outlet before opening the cover.

NOTICE: To avoid damage to the drive, do not set it on a hard surface. Instead, set the drive on a surface, such as a foam pad, that will sufficiently cushion it.

- 1 If you are replacing a hard drive that contains data you want to keep, back up your files before you begin this procedure.
- 2 Follow the procedures in "Before You Begin" on page 63.
- 3 Remove the computer cover (see page 68).

Removing a Hard Drive

- 1 Disconnect the power and hard drive cables from the drive.

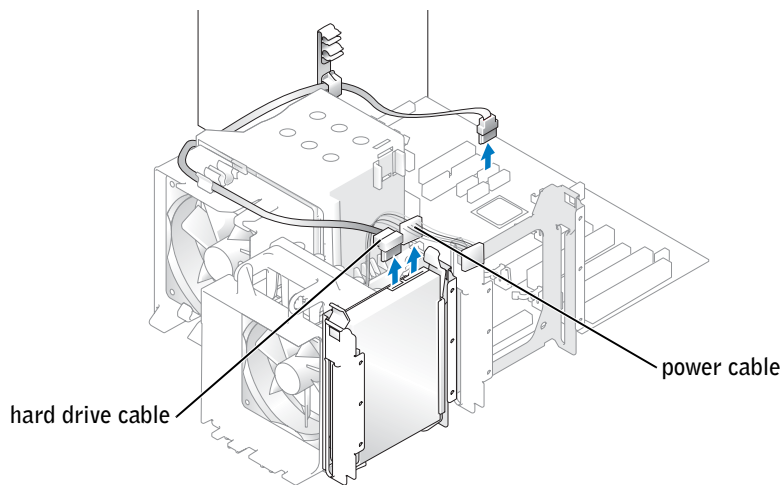

- 2 Press in on the tabs on each side of the drive and slide the drive up and out.

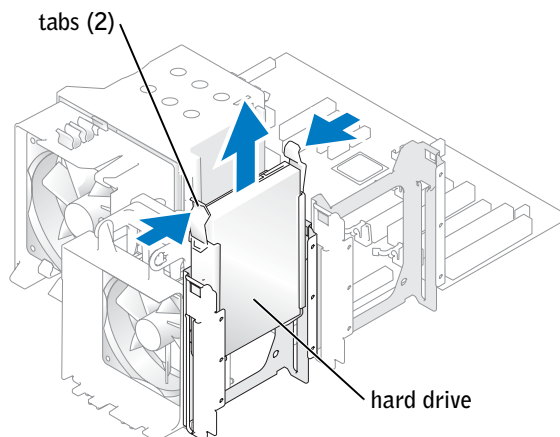

Installing a Hard Drive

- 1 Unpack the replacement hard drive, and prepare it for installation.
- 2 Check the documentation for the drive to verify that the drive is configured for your computer.
- 3 If your replacement hard drive does not have the hard drive bracket attached, remove the bracket from the old hard drive by unsnapping it from the drive.
- 4 Snap the hard drive bracket onto the replacement hard drive.
- 5 Install the hard drive into the computer by sliding the drive into place until you feel it click into place.

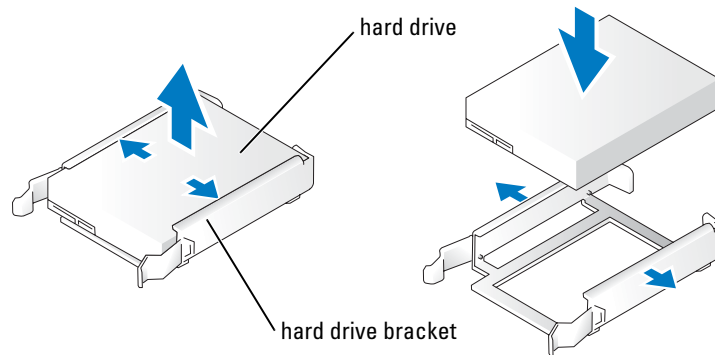

- 6 Connect the power and hard drive cables to the hard drive.

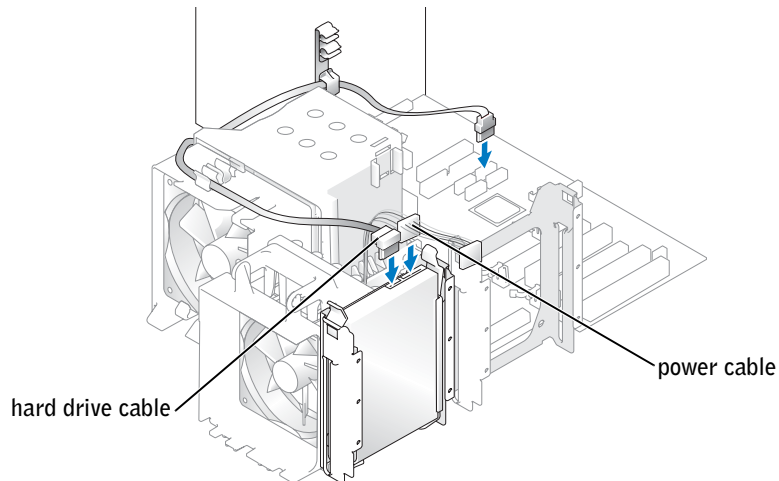

- 7 Check all connectors to be certain that they are properly cabled and firmly seated.
- 8 Close the computer cover.

➔ **NOTICE:** To connect a network cable, first plug the cable in to the network wall jack and then plug the cable in to the computer.

9 Connect your computer and devices to electrical outlets, and turn them on.

See the documentation that came with the hard drive for instructions about installing any software required for the operation of the hard drive.

Adding a Second Hard Drive

⚠ **CAUTION:** Before you begin any of the procedures in this section, follow the safety instructions in the *Product Information Guide*.

⚠ **CAUTION:** To guard against electrical shock, always unplug your computer from the electrical outlet before opening the cover.

➔ **NOTICE:** To avoid damage to the drive, do not set it on a hard surface. Instead, set the drive on a surface, such as a foam pad, that will sufficiently cushion it.

1 Check the documentation for the drive to verify that it is configured for your computer.

2 Follow the procedures in "Before You Begin" on page 63.

3 Press in on the tabs on each side of the hard drive bracket in the empty drive bay and slide the bracket up and out.

4 Snap the hard drive bracket onto the new hard drive.

➔ **NOTICE:** Do not install any drive into the lower hard-drive bay until you have removed the hard drive bracket from the inside of the hard drive bay.

5 Slide the new hard drive into empty bay until you feel a click.

🔧 **NOTE:** If your replacement hard drive does not have the hard drive bracket attached, remove the bracket from the old hard drive by unsnapping it from the drive. Snap the bracket onto the new hard drive.

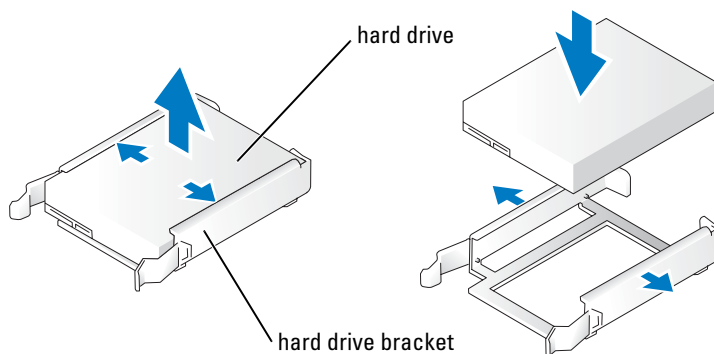

6 Gently slide the drive into place until you feel a click or feel the drive securely installed.

7 Connect the power and hard drive cables to the drive.

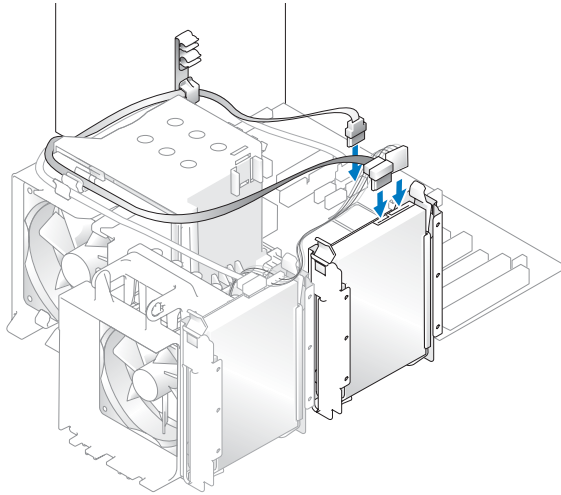

- 8 Check all connectors to be certain that they are properly cabled and firmly seated.
- 9 Replace the computer cover (page 107).
- ➔ **NOTICE:** To connect a network cable, first plug the cable into the network wall jack and then plug it into the computer.
- 10 Connect your computer and devices to electrical outlets, and turn them on.
See the documentation that came with the drive for instructions on installing any software required for drive operation.

Floppy Drive

⚠ CAUTION: Before you begin any of the procedures in this section, follow the safety instructions in the *Product Information Guide*.

⚠ CAUTION: To guard against electrical shock, always unplug your computer from the electrical outlet before opening the cover.

✍ NOTE: If you are adding a floppy drive, see "Installing a Floppy Drive" on page 98."

Removing a Floppy Drive

- 1 Follow the procedures in "Before You Begin" on page 63.
- 2 Remove the computer cover (see page 68).
- 3 Disconnect the power and floppy drive cables from the back of the floppy drive.
- 4 Disconnect the other end of the floppy drive cable from the system board.

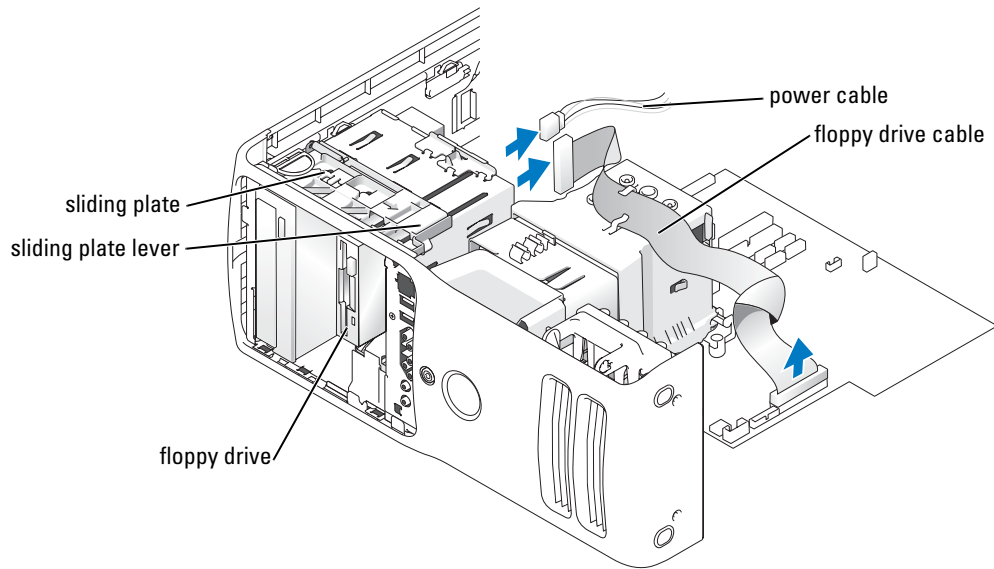

- 5** Pull the sliding plate to the right and hold in place.
- 6** Slide the floppy drive out of the floppy drive bay.

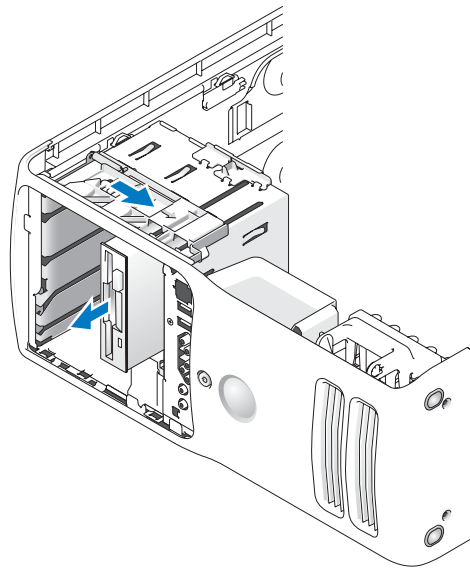

Installing a Floppy Drive

- 1 If you are installing a new floppy drive, remove the shoulder screws from the inside of the drive-panel insert and attach the screws to the new drive.

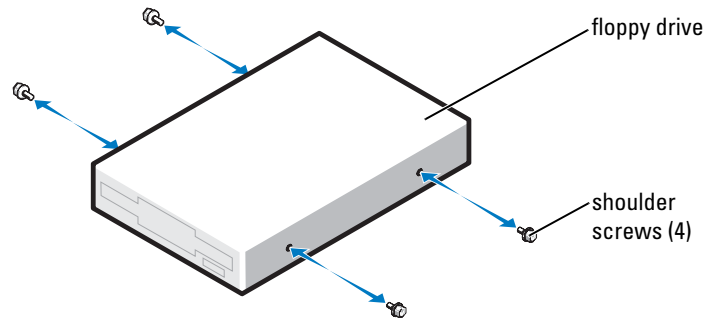

- 2 Slide the floppy drive into the floppy drive bay until the sliding plate clicks into place and the drive snaps into position.
- 3 Attach the power and floppy-drive cables to the floppy drive.
- 4 For more information on system board, see "System Board Components" on page 71.
- 5 Check all cable connections, and fold cables out of the way to provide airflow for the fan and cooling vents.
- 6 Close the computer cover.
- ➔ **NOTICE:** To connect a network cable, first plug the cable in to the network wall jack and then plug it in to the computer.
- 7 Connect your computer and devices to their electrical outlets, and turn them on.
See the documentation that came with the floppy drive for instructions on installing any software required for the operation of the drive.
- 8 Enter system setup (see page 114) and select the appropriate **Diskette Drive** option.
- 9 Verify that your computer works correctly by running the Dell Diagnostics (see page 56).

Media Card Reader

For information on using the Media Card Reader, see "Using a Media Card Reader (Optional)" on page 20.

Removing a Media Card Reader



CAUTION: Before you begin any of the procedures in this section, follow the safety instructions in the *Product Information Guide*.



NOTICE: To prevent static damage to components inside your computer, discharge static electricity from your body before you touch any of your computer's electronic components. You can do so by touching an unpainted metal surface on the computer chassis.

- 1 Follow the procedures in "Before You Begin" on page 63.
- 2 Lay the computer on its side so that the system board is on the bottom of the inside of the computer.
- 3 Remove the computer cover (see page 68).
- 4 Remove the drive panel (see page 89).

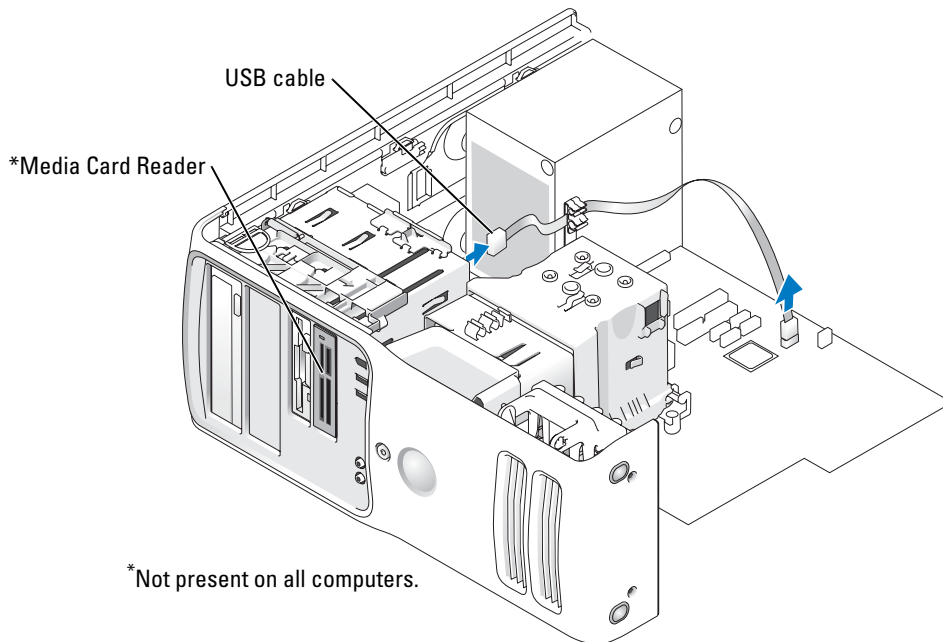

- 5 Disconnect the USB cable on the back of the Media Card Reader to the front panel USB connector on the system board (see page 71) and route the cable through the clip on the shroud.

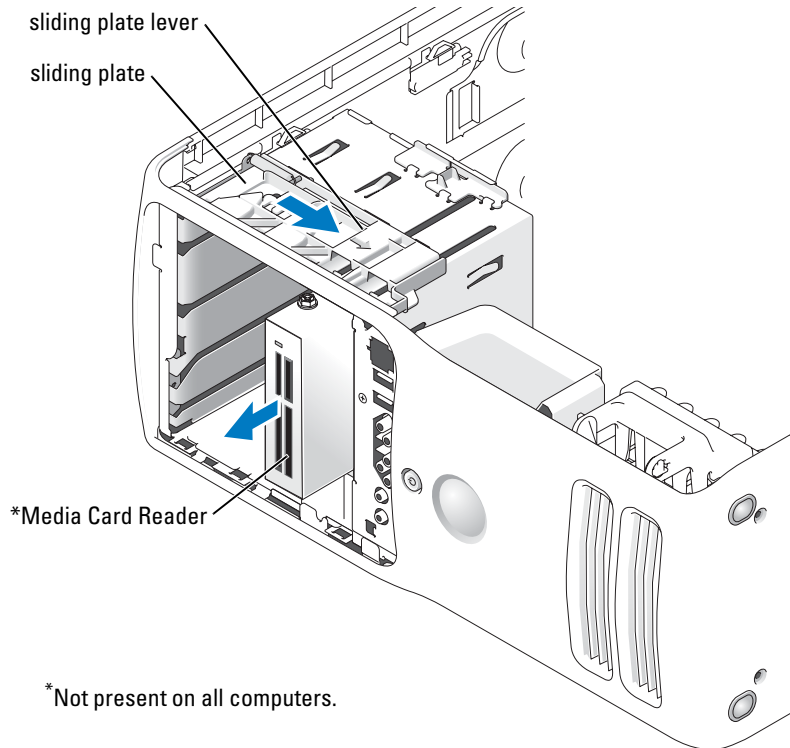

- 6 While pushing on the back of the drive, remove the Media Card Reader by sliding and holding the sliding plate.
- 7 Replace the drive panel (see page 91).
- 8 Replace the computer cover (see page 107).

Installing a Media Card Reader

⚠ CAUTION: Before you begin any of the procedures in this section, follow the safety instructions in the *Product Information Guide*.

➡ NOTICE: To prevent static damage to components inside your computer, discharge static electricity from your body before you touch any of your computer's electronic components. You can do so by touching an unpainted metal surface on the computer chassis.

- 1 Follow the procedures in "Before You Begin" on page 63.

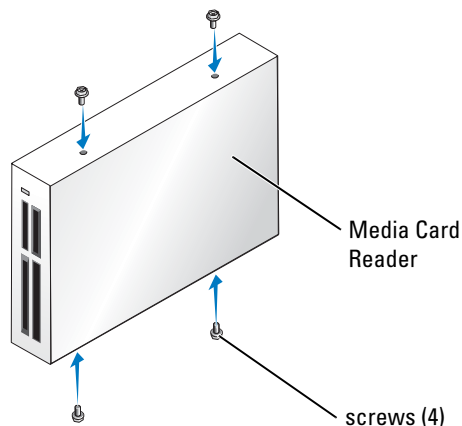

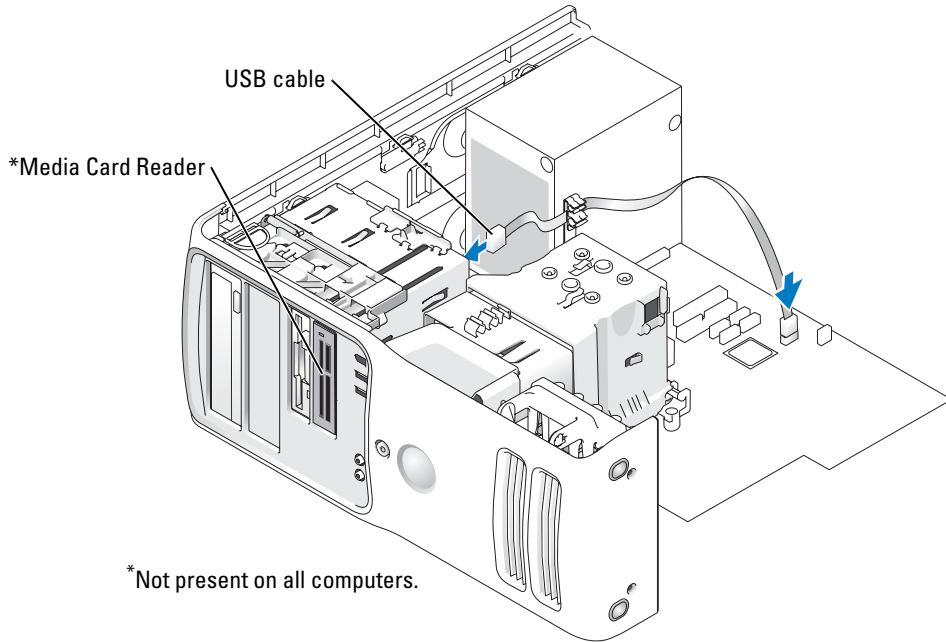

- 2 Lay the computer on its side so that the system board is on the bottom of the inside of the computer.
- 3 Remove the computer cover (see page 68).
- 4 Remove the drive panel (see page 89).
- 5 Remove the Media Card Reader from its packaging and ensure that all four screws are included..
- 6 Gently slide the drive into place until you feel a click or feel the drive securely installed. Ensure that the Media Card Reader is installed before the FlexBay cable is connected.

- 7 Connect the FlexBay USB cable to the back of the Media Card Reader and to the Media Card Reader connector on the system board (see page 71).



- 8 Insert the Media Card Reader into the bay and slide the drive in to seat it in the computer.
- 9 Route the USB cable through the cable routing clip.
- 10 Replace the computer cover (see page 107).

CD/DVD Drive

-  **CAUTION:** Before you begin any of the procedures in this section, follow the safety instructions in the *Product Information Guide*.
-  **CAUTION:** To guard against electrical shock, always unplug your computer from the electrical outlet before opening the cover.

Removing a CD/DVD Drive

- 1 Follow the procedures in "Before You Begin" on page 63.
- 2 Remove the computer cover (see page 68).
- 3 Disconnect the power cable from the back of the drive and the CD/DVD drive cable from the back of the drive and the system board.

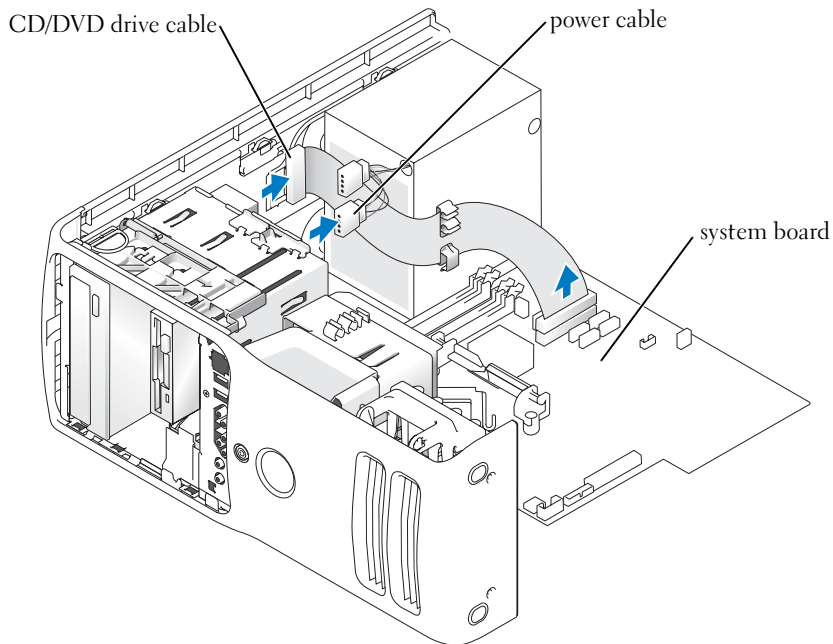

- 4 Slide the drive release mechanism to the right to release the shoulder screw and slide the drive out to remove it from the drive bay.

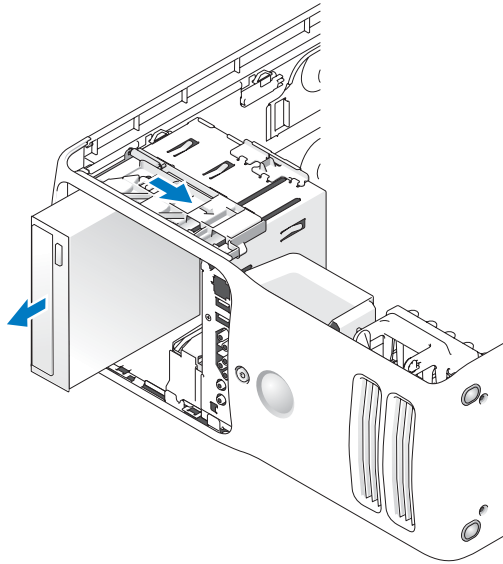

Installing a CD/DVD Drive

- 1 If you are installing a new drive, unpack the drive and prepare it for installation. Check the documentation that accompanied the drive to verify that the drive is configured for your computer. If you are installing an IDE drive, configure the drive for the cable select setting.
- 2 If you are installing a new drive, remove the three shoulder screws from the inside of the drive-panel insert and attach the screws to the new drive.

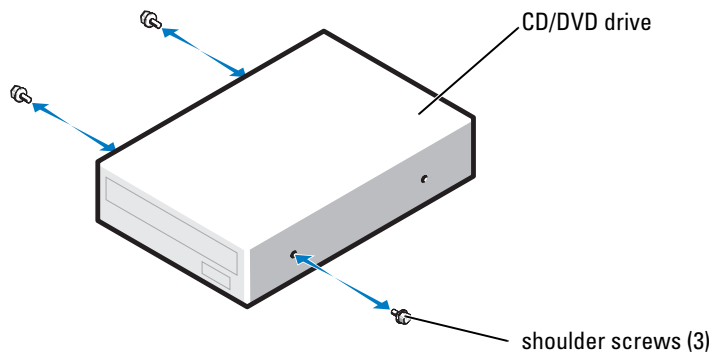

- 3 Slide the drive into the drive bay until the drive clicks into position.
- 4 Connect the power cable to the drive and the CD/DVD cable to the drive and system board.

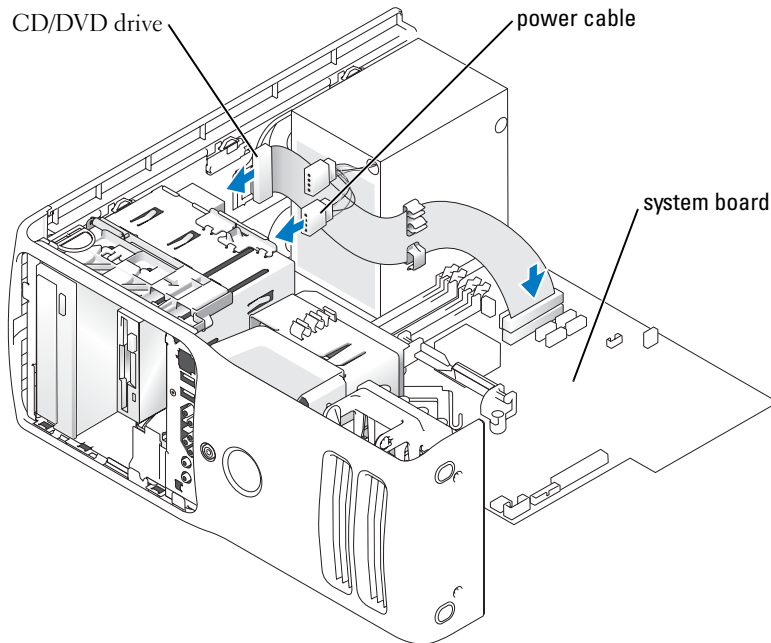

- 5 If you are installing a new CD/DVD drive rather than replacing a drive, remove the front panel inserts.
- 6 Check all cable connections, and fold cables out of the way to provide airflow for the fan and cooling vents.
- 7 Close the computer cover.
- ➔ **NOTICE:** To connect a network cable, first plug the cable in to the network wall jack and then plug it in to the computer.
- 8 Connect your computer and devices to their electrical outlets, and turn them on.
See the documentation that came with the drive for instructions on installing any software required for drive operation.
- 9 Enter system setup (see page 114) and select the appropriate **Drive** option.
- 10 Verify that your computer works correctly by running the Dell Diagnostics (see page 56).

Battery

Replacing the Battery



CAUTION: Before you begin any of the procedures in this section, follow the safety instructions in the *Product Information Guide*.



NOTICE: To prevent static damage to components inside your computer, discharge static electricity from your body before you touch any of your computer's electronic components. You can do so by touching an unpainted metal surface on the computer.

A coin-cell battery maintains computer configuration, date, and time information. The battery can last several years.

If you have to repeatedly reset time and date information after turning on the computer, replace the battery.



CAUTION: A new battery can explode if it is incorrectly installed. Replace the battery only with the same or equivalent type recommended by the manufacturer. Discard used batteries according to the manufacturer's instructions.

To replace the battery:

- 1 Record all the screens in system setup (see page 113) so that you can restore the correct settings in step 10.
- 2 Follow the procedures in "Before You Begin" on page 63.
- 3 Remove the computer cover (see page 68).
- 4 Locate the battery socket.



NOTICE: If you pry the battery out of its socket with a blunt object, be careful not to touch the system board with the object. Ensure that the object is inserted between the battery and the socket before you attempt to pry out the battery. Otherwise, you may damage the system board by prying off the socket or by breaking circuit traces on the system board.

- 5 Remove the battery by carefully prying it out of its socket with your fingers or with a blunt, nonconducting object such as a plastic screwdriver.
- 6 Insert the new battery into the socket with the side labeled "+" facing up, and snap the battery into place.

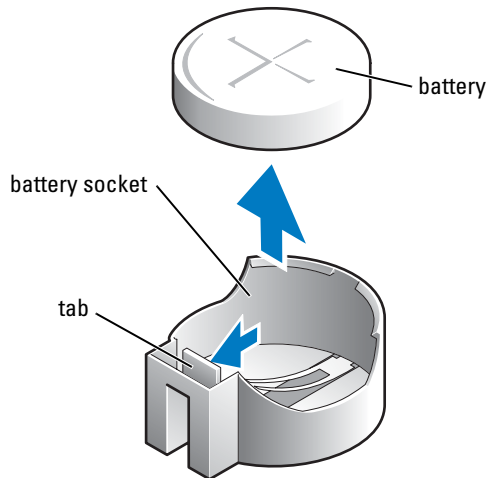

- 7 Replace the computer cover.
- ➔ **NOTICE:** To connect a network cable, first plug the cable into the network device and then plug it into the computer.
- 8 Connect your computer and devices to electrical outlets, and turn them on.
- 9 Enter system setup and restore the settings you recorded in step 1.
- 10 Properly dispose of the old battery.

Replacing the Computer Cover

⚠ CAUTION: Before you begin any of the procedures in this section, follow the safety instructions in the *Product Information Guide*.

- 1 Ensure that all cables are connected, and fold cables out of the way.
Gently pull the power cables toward you so that they do not get caught underneath the drives.
- 2 Ensure that no tools or extra parts are left inside the computer.
- 3 Close the cover:
 - a Pivot the cover down.
 - b Press down on the right side of the cover until it closes.
 - c Press down on the left side of the cover until it closes.
 - d Ensure that both sides of the cover are locked. If not, repeat all of step 3.
- ➔ **NOTICE:** To connect a network cable, first plug the cable into the network wall jack and then plug it into the computer.
- 4 Connect your computer and devices to electrical outlets, and turn them on.

Appendix

Specifications

Processor

Processor type	Intel® Pentium® 4 Socket-T with Hyper-Threading technology
Cache	1 MB or 2 MB

Memory

Type	dual-channel 400-, 533-, and 667-MHz DDR2
Memory connectors	four
Memory capacities	256 MB, 512 MB, or 1 GB
Minimum memory	512 MB
Maximum memory	4 GB
BIOS address	F0000h

Computer Information

Chipset	Intel 945P
DMA channels	eight
Interrupt levels	24
BIOS chip (NVRAM)	4 Mb
NIC	Integrated network interface capable of 10/100 communication
System clock	800- or 1066-MHz data rate (depending on your processor)

Video

Type	PCI Express
------	-------------

Audio

Type	Internal 7.1 channel or PCI option cards
------	--

Expansion Bus

Bus type	PCI 32 bit PCI Express x1, x4, and x16
Bus speed	PCI: 33 MHz PCI Express: 100 MHz
Bus throughput	PCI Express: x1 slot bidirectional speed - 500 MB/s x4 slot bidirectional speed - 2 GB/s x16 slot bidirectional speed - 8 GB/s

PCI

connectors	three
connector size	120 pins
connector data width (maximum)	32 bits

PCI Express

connector	one x1
connector size	36 pins
connector data width (maximum)	1 PCI Express lane

PCI Express

connector	one x4
connector size	98 pins
connector data width (maximum)	4 PCI Express lanes

PCI Express

connector	one x16
connector size	164 pins
connector data width (maximum)	16 PCI Express lanes

Drives

Externally accessible:	two 3.5-inch drive bays (FlexBay) two 5.25-inch drive bays
Available devices	serial ATA drives (2), floppy drive, USB memory devices, CD drive, CD-RW drive, DVD drive, DVD-RW drive, Media Card Reader, and DVD/CD-RW combo drive
Internally accessible:	two 3.5-inch hard-drive bays

Connectors

External connectors:	
IEEE 1394	one front-panel 6-pin serial connector (with optional card)
Video	15-pin VGA connector 28-pin DVI connector
Network adapter	RJ-45 connector
USB	two front-panel and five back-panel USB 2.0-compliant connectors
Audio	five back-panel connectors for line-in, line-out, microphone, surround, and center/Low Frequency Effects (LFE) channel; two front-panel connectors for headphones/microphone
System board connectors:	
Primary IDE drive	40-pin connector on PCI local bus
Serial ATA	four 7-pin connectors
FlexBay Drive	USB 10-pin header for optional floppy drive or optional Media Card Reader (3.5-inch bay devices)
Fan	5-pin connector
PCI	three 120-pin connectors
PCI Express x1	36-pin connector
PCI Express x4	98-pin connector
PCI Express x16	164-pin connector

Controls and Lights

Power control	push button
Power light	green light — Blinking green in sleep state; solid green for power-on state. amber light — Blinking amber indicates a problem with the power supply inside the computer. If the system cannot boot and there is a solid amber light, this indicates a problem with the system board (see "Power Problems" on page 47).
Hard-drive access light	green
Link integrity light (on integrated network adapter)	green light — A good connection exists between a 10-Mbps network and the computer. orange light — A good connection exists between a 100-Mbps network and the computer. off (no light) — The computer is not detecting a physical connection to the network.
Activity light (on integrated network adapter)	yellow light — Blinking indicates activity on the network.
Diagnostic lights	four lights on the front panel (see "Diagnostic Lights" on page 53.)
Standby power light	AUXPWR on the system board

Power

DC power supply:	
Wattage	375 W
Heat dissipation	1280 BTU/hr NOTE: Heat dissipation is calculated based upon the power supply rating.
Voltage (See the safety instructions in the <i>Product Information Guide</i> for important voltage setting information.)	manual selection power supplies — 90 to 135 V and 180 to 265 V at 50/60 Hz
Backup battery	3-V CR2032 lithium coin cell

Physical

Height	46.05 cm (18.13 inches)
Width	18.75 cm (7.38 inches)
Depth	45.42 cm (17.88 inches)
Weight	12.7 kg (28 lb)

Environmental

Temperature:

Operating	10° to 35°C (50° to 95°F)
Storage	-40° to 65°C (-40° to 149°F)

Relative humidity 20% to 80% (noncondensing)

Maximum vibration:

Operating	0.25 G at 3 to 200 Hz at 0.5 octave/min
Storage	0.5 G at 3 to 200 Hz at 1 octave/min

Maximum shock:

Operating	bottom half-sine pulse with a change in velocity of 20 inches/sec (50.8 cm/sec)
Storage	27-G faired square wave with a velocity change of 200 inches/sec (508 cm/sec)

Altitude:

Operating	-15.2 to 3048 m (-50 to 10,000 ft)
Storage	-15.2 to 10,668 m (-50 to 35,000 ft)

System Setup

Overview

Use system setup as follows:

- To change the system configuration information after you add, change, or remove any hardware in your computer
- To set or change a user-selectable option such as the user password
- To read the current amount of memory or set the type of hard drive installed

Before you use system setup, it is recommended that you write down the system setup screen information for future reference.

 **NOTICE:** Unless you are an expert computer user, do not change the settings for this program. Certain changes can make your computer work incorrectly.

Entering System Setup

- 1 Turn on (or restart) your computer.
- 2 When the blue DELL™ logo is displayed, you must watch for the F2 prompt to appear.
- 3 Once this F2 prompt appears, press <F2> immediately.

 **NOTE:** The F2 prompt indicates that the keyboard has initialized. This prompt can appear very quickly, so you must watch for it to display, and then press <F2>. If you press <F2> before you are prompted, this keystroke will be lost.

- 4 If you wait too long and the operating system logo appears, continue to wait until you see the Microsoft® Windows® desktop. Then, shut down your computer (see page 63) and try again.

System Setup Screens

The system setup screen displays current or changeable configuration information for your computer. Information on the screen is divided into three areas: the options list, active options field, and key functions.

<p>Options List — This field appears on the left side of the system setup window. The field is a scrollable list containing features that define the configuration of your computer, including installed hardware, power conservation, and security features.</p>	<p>Option Field — This field contains information about each option. In this field you can view your current settings and make changes to your settings.</p> <p>Use the right and left arrow keys to highlight an option. Press <Enter> to make that selection active.</p>
<p>Scroll up and down the list with the up- and down-arrow keys. As an option is highlighted, the Option Field displays more information about that option and the option's current and available settings. By pressing <Enter> or the left and right arrow keys, you can toggle between a primary topic (collapsed) and subtopics (expanded).</p>	<p>Key Functions — This field appears below the Option Field and lists keys and their functions within the active system setup field.</p>

System Setup Options

 **NOTE:** Depending on your computer and installed devices, the items listed in this section may not appear, or may not appear exactly as listed.

System	
System Info	Lists system information such as the computer name, the BIOS version number and date, system tags, and other system-specific information. NOTE: The system name listed in the BIOS may not appear exactly as the name that appears on the computer or in the computer's documentation.
CPU Info	Identifies whether the computer's processor supports Hyper-Threading and lists the processor bus speed, processor ID, clock speed, and L2 cache.
Memory Info	Indicates amount of installed memory, memory speed, channel mode (dual or single), and type of memory installed.
Date/Time	Displays current date and time settings.
Boot Sequence	The computer attempts to boot from the sequence of devices specified in this list. NOTE: If you insert a boot device and restart the computer, this option appears in the system setup menu. To boot from a USB memory device, select the USB device and move it so it becomes the first device in the list.
Drives	
Diskette Drive	Identifies and defines the floppy drive attached to the FLOPPY connector on the system board as Off , USB , Internal , or Read Only .
Drives 0 through 3	Identifies the drives attached to the SATA connectors on the system board, and lists the capacity for hard drives.
SATA Operation	Identifies and defines the SATA controller settings for RAID. You can set the SATA controller to RAID Autodetect/AHCI , RAID Autodetect/ATA , or RAID On .
Onboard Devices	
Integrated NIC Controller	You can set the NIC to On (default), Off , or On w/ PXE . When the On w/ PXE setting is active (available only for the future boot process), the computer prompts you to press <Ctrl><Alt>. Pressing this key combination causes a menu to display that allows you to select a method for booting from a network server. If a boot routine is not available from the network server, the computer attempts to boot from the next device in the boot sequence list.
Integrated Audio Controller	Enables or disables the onboard audio controller.
USB Controller	Set to On (default) so that USB devices will be detected and supported in the operating system.

USB for FlexBay	<p>This field enables and disables the internal USB for FlexBay.</p> <p>Off = Internal USB for FlexBay is disabled.</p> <p>On = Internal USB for FlexBay is enabled.</p> <p>No Boot = Internal USB for FlexBay is enabled but not bootable.</p> <p>The factory default setting is No Boot.</p> <p>NOTE: This USB option appears only if a FlexBay device is installed.</p>
Video	
Primary Video	This setting specifies which video controller is primary when two video controllers are present on the computer.
Video Memory Size	Offering selectable options of 1MB and 8MB, this field configures the system memory allocation reserved for the integrated video controller.
Performance	
SpeedStep	If applicable, Intel SpeedStep® appears in the Options List under Performance .
HyperThreading	If your computer processor supports Hyper-Threading, this option appears in the Options List.
Hard Drive Acoustics	<ul style="list-style-type: none"> • Bypass (default) — Your computer does not test or change the current acoustics mode setting. • Quiet — The hard drive operates at its most quiet setting. • Suggested — The hard drive operates at the level suggested by the drive manufacturer. • Performance — The hard drive operates at its maximum speed. <p>NOTE: Switching to performance mode will cause the drive heads to move faster, causing the hard drive to be noisier. However, some drives may not see an increase in data transfer rates.</p> <p>NOTE: Changing the acoustics setting does not alter your hard drive image.</p>
Security	
Admin Password	This option provides restricted access to the computer's system setup program in the same way that access to the system can be restricted with the System Password option.
System Password	Displays the current status of the system's password security feature and allows a new system password to be assigned and verified.
Password Status	This option locks the system password field with the setup password. When the field is locked, you can no longer disable password security by pressing <Ctrl><Enter> when the computer starts.

Power Management	
AC Recovery	Determines what happens when AC power is restored to the computer.
Auto Power On	<p>Sets the computer to automatically turn on. Choices are every day or every Monday through Friday.</p> <p>The default setting is Off.</p> <p>This feature does not work if you turn off your computer using a power strip or surge protector.</p>
Auto Power Time	<p>Sets time to automatically turn on the computer.</p> <p>Time is kept in the standard 12-hour format (<i>hours:minutes</i>). Change the startup time by pressing the right- or left-arrow key to increase or decrease the numbers, or type numbers in both the date and time fields.</p> <p>This feature does not work if you turn off your computer using a power strip or surge protector.</p>
Low Power Mode	When Low Power Mode is selected, remote wakeup events no longer power up from Hibernate or Off .
Remote Wake Up	<p>This option allows the computer to power up when a NIC or Remote Wakeup-capable modem receives a wake up signal.</p> <p>On is the default setting. On w/ Boot to NIC allows the computer to attempt to boot from a network prior to using the boot sequence.</p> <p>NOTE: Normally, the system can be powered up remotely from suspend mode, hibernate mode, or when powered off. When Low Power Mode (in the Power Management menu) is enabled, the computer can only be powered up remotely from Suspend.</p>
Suspend Mode	The options are S1 , a suspend state where the computer is running in a low-power mode, and S3 , a standby state where the power is reduced or turned off for most components, however, system memory remains active.
Quick Resume	<p>This feature enables/disables the Intel Viiv Quick Resume Technology.</p> <p>The default setting is Off.</p>
Maintenance	
CMOS Defaults	This setting restores the computer's default settings.
Event Log	Displays the system event log.
POST Behavior	
Fastboot	When set to On (default), your computer starts more quickly because it skips certain configurations and tests.
Numlock Key	This option involves the rightmost bank of keys on your keyboard. When set to On (default), this option activates the numeric and mathematical features shown at the top of each key. When set to Off , this option activates the cursor-control functions labeled on the bottom of each key.

POST Hotkeys	This option allows you to specify the function keys to display on the screen when the computer starts.
Keyboard Errors	This option disables or enables keyboard error reporting when the computer starts.

Boot Sequence

This feature allows you to change the boot sequence for devices.



NOTICE: If you modify any boot sequence settings, save the new settings to avoid losing the changes.

Option Settings



NOTE: The computer attempts to boot from all bootable devices but if no bootable device is found, the computer generates an error message that states `No boot device available`. Press the <F1> key to retry the boot, or press the <F2> key to enter the setup utility.

- **Diskette Drive** — The computer attempts to boot from the floppy drive. If there is no floppy in the drive or there is no floppy drive installed, the computer attempts to boot from the next bootable device in the sequence.



NOTE: If there is a non-bootable floppy in the drive, the computer generates an error message. Follow the on-screen instructions to retry the boot.

- **Hard Drive** — The computer attempts to boot from the primary hard drive. If no operating system is on the drive, the computer attempts to boot to the next bootable device.
- **CD Drive** — The computer attempts to boot from the CD drive. If no CD is in the drive, or if the CD has no operating system, the computer attempts to boot to the next bootable device.
- **USB Flash Device** — Insert the memory device into a USB port and restart the computer. When `F12 = Boot Menu` appears in the upper-right corner of the screen, press <F12>. The BIOS detects the device and adds the USB flash option to the boot menu.



NOTE: To boot to a USB device, the device must be bootable. To ensure that your device is bootable, check the device documentation.

Changing Boot Sequence for the Current Boot

You can use this feature, for example, to restart your computer to a USB device such as a floppy drive, memory key, or CD-RW drive.



NOTE: If you are booting to a USB floppy drive, you must first set the floppy drive to OFF in system setup (see page 113).

- 1 If you are booting to a USB device, connect the USB device to a USB connector (see page 111).
- 2 Turn on (or restart) your computer.

- 3 When F2 = Setup, F12 = Boot Menu appears in the upper-right corner of the screen, press <F12>.

If you wait too long and the operating system logo appears, continue to wait until you see the Microsoft Windows desktop. Then shut down your computer (see page 63) and try again.

The **Boot Device Menu** appears, listing all available boot devices. Each device has a number next to it.

- 4 At the bottom of the menu, enter the number of the device that is to be used for the current boot only.

For example, if you are booting to a USB memory key, highlight **USB Flash Device** and press <Enter>.



NOTE: To boot to a USB device, the device must be bootable. To make sure your device is bootable, check the device documentation.

Changing Boot Sequence for Future Boots

- 1 Enter system setup (see page 114).
- 2 Use the arrow keys to highlight the **Boot Sequence** menu option and press <Enter> to access the menu.



NOTE: Write down your current boot sequence in case you want to restore it.

- 3 Press the up- and down-arrow keys to move through the list of devices.
- 4 Press the spacebar to enable or disable a device (enabled devices have a checkmark).
- 5 Press plus (+) or minus (-) to move a selected device up or down the list.

Clearing Forgotten Passwords

CAUTION: Before you begin any of the procedures in this section, follow the safety instructions in the *Product Information Guide*.

- 1 Follow the procedures in "Before You Begin" on page 63.

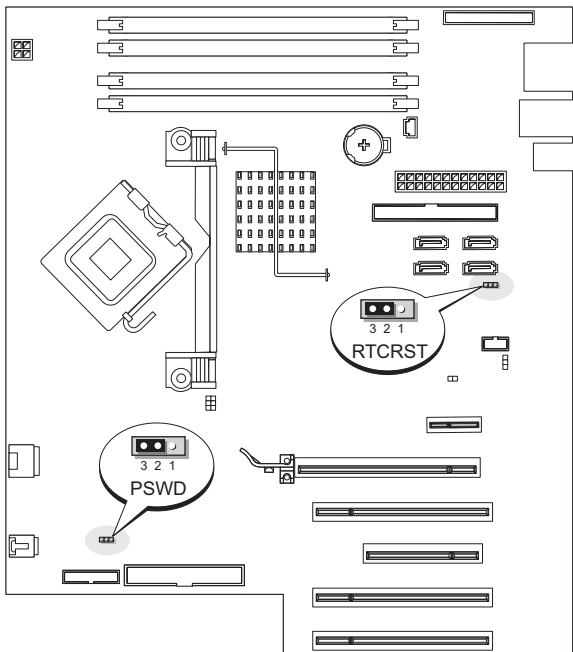

- 2 Locate the 3-pin password jumper (PSWD) on the system board (see page 71), and attach the jumper plug to pins 2 and 3 to clear the password.

NOTE: When you receive your computer, the jumper plug is attached to pins 1 and 2.

- 3 Close the computer cover (see page 107).
- 4 Connect your computer and monitor to electrical outlets, and turn them on.
- 5 After the Microsoft® Windows® desktop appears on your computer, shut down the computer (see page 63).
- 6 Turn off the monitor and disconnect it from the electrical outlet.
- 7 Disconnect the computer power cable from the electrical outlet, and press the power button to ground the system board.
- 8 Open the computer cover (see page 68).
- 9 Locate the 3-pin password jumper (PSWD) on the system board (see page 71) and attach the jumper to pins 1 and 2 to reenble the password feature.

- 10 Close the computer cover (see page 107).
-  **NOTICE:** To connect a network cable, first plug the cable into the network device and then plug it into the computer.
- 11 Connect your computer and devices to electrical outlets, and turn them on.

Clearing CMOS Settings

 **CAUTION:** Before you begin any of the procedures in this section, follow the safety instructions in the *Product Information Guide*.

- 1 Follow the procedures in "Before You Begin" on page 63.
- 2 Reset the current CMOS settings:
 - a Locate the 3-pin CMOS jumper (RTCRST) on the system board (see page 71).
 - b Remove the jumper plug from pins 2 and 3.
 - c Place the jumper plug on pins 1 and 2 and wait approximately five seconds.
 - d Replace the jumper plug on pins 2 and 3.
- 3 Close the computer cover (see page 107).

-  **NOTICE:** To connect a network cable, first plug the cable into the network wall jack and then plug it into the computer.
- 4 Connect your computer and devices to electrical outlets, and turn them on.

Cleaning Your Computer

 **CAUTION:** Before you begin any of the procedures in this section, follow the safety instructions in the *Product Information Guide*.

Computer, Keyboard, and Monitor

 **CAUTION:** Before you clean your computer, disconnect the computer from the electrical outlet. Clean your computer with a soft cloth dampened with water. Do not use liquid or aerosol cleaners, which may contain flammable substances.

- Use a vacuum cleaner with a brush attachment to gently remove dust from the slots and holes on your computer and from between the keys on the keyboard.

 **NOTICE:** Do not wipe the display screen with any soap or alcohol solution. Doing so may damage the antiglare coating.

- To clean your monitor screen, lightly dampen a soft, clean cloth with water. If possible, use a special screen-cleaning tissue or solution suitable for the monitor's antistatic coating.
- Wipe the keyboard, computer, and plastic part of the monitor with a soft cleaning cloth moistened with a solution of three parts water and one part dishwashing detergent.

Do not soak the cloth or let water drip inside your computer or keyboard.

Mouse

If your screen cursor skips or moves abnormally, clean the mouse. To clean a non-optical mouse:

- 1 Turn the retainer ring on the underside of your mouse counterclockwise, and then remove the ball.
- 2 Wipe the ball with a clean, lint-free cloth.
- 3 Blow carefully into the ball cage to dislodge dust and lint.
- 4 If the rollers inside the ball cage are dirty, clean the rollers with a cotton swab moistened lightly with isopropyl alcohol.
- 5 Recenter the rollers in their channels if they are misaligned. Ensure that fluff from the swab is not left on the rollers.
- 6 Replace the ball and retainer ring, and turn the retainer ring clockwise until it clicks into place.

Floppy Drive

- ➡ **NOTICE:** Do not attempt to clean drive heads with a swab. You might accidentally misalign the heads, which prevents the drive from operating.

Clean your floppy drive using a commercially available cleaning kit. These kits contain pretreated floppies to remove contaminants that accumulate during normal operation.

CDs and DVDs

- ➡ **NOTICE:** Always use compressed air to clean the lens in the CD/DVD drive, and follow the instructions that come with the compressed air. Never touch the lens in the drive.

If you notice problems, such as skipping, with the playback quality of your CDs or DVDs, try cleaning the discs.

- 1 Hold the disc by its outer edge. You can also touch the inside edge of the center hole.

- ➡ **NOTICE:** To prevent damaging the surface, do not wipe in a circular motion around the disc.

- 2 With a soft, lint-free cloth, gently wipe the bottom of the disc (the unlabeled side) in a straight line from the center to the outer edge of the disc.

For stubborn dirt, try using water or a diluted solution of water and mild soap. You can also purchase commercial products that clean discs and provide some protection from dust, fingerprints, and scratches. Cleaning products for CDs are safe to use on DVDs.

Dell Technical Support Policy (U.S. Only)

Technician-assisted technical support requires the cooperation and participation of the customer in the troubleshooting process and provides for restoration of the operating system, software programs, and hardware drivers to the original default configuration as shipped from Dell, as well as

the verification of appropriate functionality of the computer and all Dell-installed hardware. In addition to this technician-assisted technical support, online technical support is available at support.dell.com. Additional technical support options may be available for purchase.

Dell provides limited technical support for the computer and any "Dell-installed" software and peripherals¹. Support for third-party software and peripherals is provided by the original manufacturer, including those purchased and/or installed through Dell Software and Peripherals, Readyware, and Custom Factory Integration².

- ¹ Repair services are provided pursuant to the terms and conditions of your limited warranty and any optional support service contract purchased with the computer.
- ² All Dell-standard components included in a Custom Factory Integration (CFI) project are covered by the standard Dell limited warranty for your computer. However, Dell also extends a parts replacement program to cover all nonstandard, third-party hardware components integrated through CFI for the duration of the computer's service contract.

Definition of "Dell-Installed" Software and Peripherals

Dell-installed software includes the operating system and some of the software programs that are installed on the computer during the manufacturing process (Microsoft® Office, Norton Antivirus, and so on).

Dell-installed peripherals include any internal expansion cards, or Dell-branded module bay or PC Card accessories. In addition, any Dell-branded monitors, keyboards, mice, speakers, microphones for telephonic modems, docking stations/port replicators, networking products, and all associated cabling are included.

Definition of "Third-Party" Software and Peripherals

Third-party software and peripherals include any peripheral, accessory, or software program sold by Dell not under the Dell brand (printers, scanners, cameras, games, and so on). Support for all third-party software and peripherals is provided by the original manufacturer of the product.

FCC Notices (U.S. Only)

Most Dell computer systems are classified by the Federal Communications Commission (FCC) as Class B digital devices. To determine which classification applies to your computer system, examine all FCC registration labels on the bottom, side, or back panel of your computer, on card-mounting brackets, and on the cards themselves. If any one of the labels carries a Class A rating, your entire system is considered to be a Class A digital device. If *all* labels carry an FCC Class B rating as distinguished by either an FCC ID number or the FCC logo, (**FCC**), your system is considered to be a Class B digital device.

Once you have determined your system's FCC classification, read the appropriate FCC notice. Note that FCC regulations provide that changes or modifications not expressly approved by Dell could void your authority to operate this equipment.

This device complies with Part 15 of the FCC Rules. Operation is subject to the following two conditions:

This device may not cause harmful interference.

This device must accept any interference received, including interference that may cause undesired operation.

Class A

This equipment has been tested and found to comply with the limits for a Class A digital device pursuant to Part 15 of the FCC Rules. These limits are designed to provide reasonable protection against harmful interference when the equipment is operated in a commercial environment. This equipment generates, uses, and can radiate radio frequency energy and, if not installed and used in accordance with the manufacturer's instruction manual, may cause harmful interference with radio communications. Operation of this equipment in a residential area is likely to cause harmful interference, in which case you will be required to correct the interference at your own expense.

Class B

This equipment has been tested and found to comply with the limits for a Class B digital device pursuant to Part 15 of the FCC Rules. These limits are designed to provide reasonable protection against harmful interference in a residential installation. This equipment generates, uses, and can radiate radio frequency energy and, if not installed and used in accordance with the manufacturer's instruction manual, may cause interference with radio communications. However, there is no guarantee that interference will not occur in a particular installation. If this equipment does cause harmful interference to radio or television reception, which can be determined by turning the equipment off and on, you are encouraged to try to correct the interference by one or more of the following measures:

- Reorient or relocate the receiving antenna.
- Increase the separation between the equipment and the receiver.
- Connect the equipment into an outlet on a circuit different from that to which the receiver is connected.
- Consult the dealer or an experienced radio/television technician for help.

FCC Identification Information

The following information is provided on the device or devices covered in this document in compliance with FCC regulations:

- Model number: DCTA
Company name:

Dell Inc.
One Dell Way
Round Rock, Texas 78682 USA
512-338-4400

Contacting Dell

To contact Dell electronically, you can access the following websites:

- www.dell.com
- support.dell.com (technical support)
- premiersupport.dell.com (technical support for educational, government, healthcare, and medium/large business customers, including Premier, Platinum, and Gold customers)

For specific web addresses for your country, find the appropriate country section in the table below.

NOTE: Toll-free numbers are for use within the country for which they are listed.

NOTE: In certain countries, technical support specific to Dell Inspiron™ XPS computers is available at a separate telephone number listed for participating countries. If you do not see a telephone number listed that is specific for Inspiron XPS computers, you may contact Dell through the technical support number listed and your call will be routed appropriately.

When you need to contact Dell, use the electronic addresses, telephone numbers, and codes provided in the following table. If you need assistance in determining which codes to use, contact a local or an international operator.

Country (City) International Access Code Country Code City Code	Department Name or Service Area, Website and E-Mail Address	Area Codes, Local Numbers, and Toll-Free Numbers
Anguilla	General Support	toll-free: 800-335-0031
Antigua and Barbuda	General Support	1-800-805-5924

Country (City) International Access Code Country Code City Code	Department Name or Service Area, Website and E-Mail Address	Area Codes, Local Numbers, and Toll-Free Numbers
Argentina (Buenos Aires) International Access Code: 00 Country Code: 54 City Code: 11	Website: www.dell.com.ar E-mail: us_latin_services@dell.com E-mail for desktop and portable computers: la-techsupport@dell.com E-mail for servers and EMC® storage products: la_enterprise@dell.com	Customer Care toll-free: 0-800-444-0730 Tech Support toll-free: 0-800-444-0733 Tech Support Services toll-free: 0-800-444-0724 Sales 0-810-444-3355
Aruba	General Support	toll-free: 800-1578
Australia (Sydney) International Access Code: 0011 Country Code: 61 City Code: 2	E-mail (Australia): au_tech_support@dell.com E-mail (New Zealand): nz_tech_support@dell.com Home and Small Business Government and Business Preferred Accounts Division (PAD) Customer Care Technical Support (portables and desktops) Technical Support (servers and workstations) Corporate Sales Transaction Sales Fax	1-300-655-533 toll-free: 1-800-633-559 toll-free: 1-800-060-889 toll-free: 1-800-819-339 toll-free: 1-300-655-533 toll-free: 1-800-733-314 toll-free: 1-800-808-385 toll-free: 1-800-808-312 toll-free: 1-800-818-341
Austria (Vienna) International Access Code: 900 Country Code: 43 City Code: 1	Website: support.euro.dell.com E-mail: tech_support_central_europe@dell.com Home/Small Business Sales Home/Small Business Fax Home/Small Business Customer Care Preferred Accounts/Corporate Customer Care Home/Small Business Technical Support Preferred Accounts/Corporate Technical Support Switchboard	0820 240 530 00 0820 240 530 49 0820 240 530 14 0820 240 530 16 0820 240 530 14 0660 8779 0820 240 530 00
Bahamas	General Support	toll-free: 1-866-278-6818

Country (City) International Access Code Country Code City Code	Department Name or Service Area, Website and E-Mail Address	Area Codes, Local Numbers, and Toll-Free Numbers
Barbados	General Support	1-800-534-3066
Belgium (Brussels)	Website: support.euro.dell.com	
International Access Code: 00	E-mail for French-speaking Customers: support.euro.dell.com/be/fr/emailldell/	
Country Code: 32	Technical Support for Inspiron XPS computers only	02 481 92 96
City Code: 2	Technical Support for all other Dell computers	02 481 92 88
	Technical Support Fax	02 481 92 95
	Customer Care	02 713 15 .65
	Corporate Sales	02 481 91 00
	Fax	02 481 92 99
	Switchboard	02 481 91 00
Bermuda	General Support	1-800-342-0671
Bolivia	General Support	toll-free: 800-10-0238
Brazil	Website: www.dell.com/br	
International Access Code: 00	Customer Support, Technical Support	0800 90 3355
Country Code: 55	Technical Support Fax	51 481 5470
City Code: 51	Customer Care Fax	51 481 5480
	Sales	0800 90 3390
British Virgin Islands	General Support	toll-free: 1-866-278-6820
Brunei	Customer Technical Support (Penang, Malaysia)	604 633 4966
Country Code: 673	Customer Service (Penang, Malaysia)	604 633 4949
	Transaction Sales (Penang, Malaysia)	604 633 4955

Country (City) International Access Code Country Code City Code	Department Name or Service Area, Website and E-Mail Address	Area Codes, Local Numbers, and Toll-Free Numbers
Canada (North York, Ontario) International Access Code: 011	Online Order Status: www.dell.ca/ostatus AutoTech (automated technical support) Customer Care (Home Sales/Small Business) Customer Care (med./large business, government) Technical Support (Home Sales/Small Business) Technical Support (med./large bus., government) Technical Support (printers, projectors, televisions, handhelds, digital jukebox, and wireless) Sales (Home Sales/Small Business) Sales (med./large bus., government) Spare Parts Sales & Extended Service Sales	toll-free: 1-800-247-9362 toll-free: 1-800-847-4096 toll-free: 1-800-326-9463 toll-free: 1-800-847-4096 toll-free: 1-800-387-5757 1-877-335-5767 toll-free: 1-800-387-5752 toll-free: 1-800-387-5755 1 866 440 3355
Cayman Islands	General Support	1-800-805-7541
Chile (Santiago) Country Code: 56 City Code: 2	Sales, Customer Support, and Technical Support	toll-free: 1230-020-4823

Country (City) International Access Code Country Code City Code	Department Name or Service Area, Website and E-Mail Address	Area Codes, Local Numbers, and Toll-Free Numbers
China (Xiamen) Country Code: 86 City Code: 592	Technical Support website: support.dell.com.cn Technical Support E-mail: cn_support@dell.com Customer Care E-mail: customer_cn@dell.com Technical Support Fax Technical Support (Dell™ Dimension™ and Inspiron) Technical Support (OptiPlex™, Latitude™, and Dell Precision™) Technical Support (servers and storage) Technical Support (projectors, PDAs, switches, routers, and so on) Technical Support (printers) Customer Care Customer Care Fax Home and Small Business Preferred Accounts Division Large Corporate Accounts GCP Large Corporate Accounts Key Accounts Large Corporate Accounts North Large Corporate Accounts North Government and Education Large Corporate Accounts East Large Corporate Accounts East Government and Education Large Corporate Accounts Queue Team Large Corporate Accounts South Large Corporate Accounts West Large Corporate Accounts Spare Parts	592 818 1350 toll-free: 800 858 2969 toll-free: 800 858 0950 toll-free: 800 858 0960 toll-free: 800 858 2920 toll-free: 800 858 2311 toll-free: 800 858 2060 592 818 1308 toll-free: 800 858 2222 toll-free: 800 858 2557 toll-free: 800 858 2055 toll-free: 800 858 2628 toll-free: 800 858 2999 toll-free: 800 858 2955 toll-free: 800 858 2020 toll-free: 800 858 2669 toll-free: 800 858 2572 toll-free: 800 858 2355 toll-free: 800 858 2811 toll-free: 800 858 2621
Colombia	General Support	980-9-15-3978
Costa Rica	General Support	0800-012-0435

Country (City) International Access Code Country Code City Code	Department Name or Service Area, Website and E-Mail Address	Area Codes, Local Numbers, and Toll-Free Numbers
Czech Republic (Prague)	Website: support.euro.dell.com	
International Access Code: 00	E-mail: czech_dell@dell.com	
Country Code: 420	Technical Support	22537 2727
	Customer Care	22537 2707
	Fax	22537 2714
	Tech Fax	22537 2728
	Switchboard	22537 2711
Denmark (Copenhagen)	Website: support.euro.dell.com	
International Access Code: 00	E-mail: support.euro.dell.com/dk/da/emaildell/	
Country Code: 45	Technical Support for Inspiron XPS computers only	7010 0074
	Technical Support for all other Dell computers	7023 0182
	Customer Care (Relational)	7023 0184
	Home/Small Business Customer Care	3287 5505
	Switchboard (Relational)	3287 1200
	Switchboard Fax (Relational)	3287 1201
	Switchboard (Home/Small Business)	3287 5000
	Switchboard Fax (Home/Small Business)	3287 5001
Dominica	General Support	toll-free: 1-866-278-6821
Dominican Republic	General Support	1-800-148-0530
Ecuador	General Support	toll-free: 999-119
El Salvador	General Support	01-899-753-0777
Finland (Helsinki)	Website: support.euro.dell.com	
International Access Code: 990	E-mail: support.euro.dell.com/fi/fi/emaildell/	
Country Code: 358	Technical Support	09 253 313 60
City Code: 9	Customer Care	09 253 313 38
	Fax	09 253 313 99
	Switchboard	09 253 313 00

Country (City) International Access Code Country Code City Code	Department Name or Service Area, Website and E-Mail Address	Area Codes, Local Numbers, and Toll-Free Numbers
France (Paris) (Montpellier)	Website: support.euro.dell.com	
International Access Code: 00	E-mail: support.euro.dell.com/fr/fr/emaildell/	
Country Code: 33	Home and Small Business	
City Codes: (1) (4)	Technical Support for Inspiron XPS computers only	0825 387 129
	Technical Support for all other Dell computers	0825 387 270
	Customer Care	0825 823 833
	Switchboard	0825 004 700
	Switchboard (calls from outside of France)	04 99 75 40 00
	Sales	0825 004 700
	Fax	0825 004 701
	Fax (calls from outside of France)	04 99 75 40 01
	Corporate	
	Technical Support	0825 004 719
	Customer Care	0825 338 339
	Switchboard	01 55 94 71 00
	Sales	01 55 94 71 00
	Fax	01 55 94 71 01
Germany (Langen)	Website: support.euro.dell.com	
International Access Code: 00	E-mail: tech_support_central_europe@dell.com	
Country Code: 49	Technical Support for Inspiron XPS computers only	06103 766-7222
City Code: 6103	Technical Support for all other Dell computers	06103 766-7200
	Home/Small Business Customer Care	0180-5-224400
	Global Segment Customer Care	06103 766-9570
	Preferred Accounts Customer Care	06103 766-9420
	Large Accounts Customer Care	06103 766-9560
	Public Accounts Customer Care	06103 766-9555
	Switchboard	06103 766-7000

Country (City) International Access Code Country Code City Code	Department Name or Service Area, Website and E-Mail Address	Area Codes, Local Numbers, and Toll-Free Numbers
Greece	Website: support.euro.dell.com	
International Access Code: 00	E-mail: support.euro.dell.com/gr/en/emaildell/	
Country Code: 30	Technical Support	00800-44 14 95 18
	Gold Service Technical Support	00800-44 14 00 83
	Switchboard	2108129810
	Gold Service Switchboard	2108129811
	Sales	2108129800
	Fax	2108129812
Grenada	General Support	toll-free: 1-866-540-3355
Guatemala	General Support	1-800-999-0136
Guyana	General Support	toll-free: 1-877-270-4609
Hong Kong	Website: support.ap.dell.com	
International Access Code: 001	Technical Support E-mail: apsupport@dell.com	
Country Code: 852	Technical Support (Dimension and Inspiron)	2969 3188
	Technical Support (OptiPlex, Latitude, and Dell Precision)	2969 3191
	Technical Support (PowerApp™, PowerEdge™, PowerConnect™, and PowerVault™)	2969 3196
	Customer Care	3416 0910
	Large Corporate Accounts	3416 0907
	Global Customer Programs	3416 0908
	Medium Business Division	3416 0912
	Home and Small Business Division	2969 3105
India	Technical Support	1600 33 8045
	Sales (Large Corporate Accounts)	1600 33 8044
	Sales (Home and Small Business)	1600 33 8046

Country (City) International Access Code Country Code City Code	Department Name or Service Area, Website and E-Mail Address	Area Codes, Local Numbers, and Toll-Free Numbers
Ireland (Cherrywood)	Website: support.euro.dell.com	
International Access Code: 16	E-mail: dell_direct_support@dell.com	
Country Code: 353	Technical Support for Inspiron XPS computers only	1850 200 722
City Code: 1	Technical Support for all other Dell computers	1850 543 543
	U.K. Technical Support (dial within U.K. only)	0870 908 0800
	Home User Customer Care	01 204 4014
	Small Business Customer Care	01 204 4014
	U.K. Customer Care (dial within U.K. only)	0870 906 0010
	Corporate Customer Care	1850 200 982
	Corporate Customer Care (dial within U.K. only)	0870 907 4499
	Ireland Sales	01 204 4444
	U.K. Sales (dial within U.K. only)	0870 907 4000
	Fax/Sales Fax	01 204 0103
	Switchboard	01 204 4444
Italy (Milan)	Website: support.euro.dell.com	
International Access Code: 00	E-mail: support.euro.dell.com/it/it/emaildell/	
Country Code: 39	Home and Small Business	
City Code: 02	Technical Support	02 577 826 90
	Customer Care	02 696 821 14
	Fax	02 696 821 13
	Switchboard	02 696 821 12
	Corporate	
	Technical Support	02 577 826 90
	Customer Care	02 577 825 55
	Fax	02 575 035 30
	Switchboard	02 577 821
Jamaica	General Support (dial from within Jamaica only)	1-800-682-3639

Country (City) International Access Code Country Code City Code	Department Name or Service Area, Website and E-Mail Address	Area Codes, Local Numbers, and Toll-Free Numbers
Japan (Kawasaki)	Website: support.jp.dell.com	
International Access Code: 001	Technical Support (servers)	toll-free: 0120-198-498
Country Code: 81	Technical Support outside of Japan (servers)	81-44-556-4162
City Code: 44	Technical Support (Dimension and Inspiron)	toll-free: 0120-198-226
	Technical Support outside of Japan (Dimension and Inspiron)	81-44-520-1435
	Technical Support (Dell Precision, OptiPlex, and Latitude)	toll-free:0120-198-433
	Technical Support outside of Japan (Dell Precision, OptiPlex, and Latitude)	81-44-556-3894
	Technical Support (PDAs, projectors, printers, routers)	toll-free: 0120-981-690
	Technical Support outside of Japan (PDAs, projectors, printers, routers)	81-44-556-3468
	Faxbox Service	044-556-3490
	24-Hour Automated Order Service	044-556-3801
	Customer Care	044-556-4240
	Business Sales Division (up to 400 employees)	044-556-1465
	Preferred Accounts Division Sales (over 400 employees)	044-556-3433
	Large Corporate Accounts Sales (over 3500 employees)	044-556-3430
	Public Sales (government agencies, educational institutions, and medical institutions)	044-556-1469
	Global Segment Japan	044-556-3469
	Individual User	044-556-1760
	Switchboard	044-556-4300
Korea (Seoul)	Technical Support	toll-free: 080-200-3800
International Access Code: 001	Sales	toll-free: 080-200-3600
Country Code: 82	Customer Service (Penang, Malaysia)	604 633 4949
City Code: 2	Fax	2194-6202
	Switchboard	2194-6000
	Technical Support (Electronics and Accessories)	toll-free: 080-200-3801

Country (City) International Access Code Country Code City Code	Department Name or Service Area, Website and E-Mail Address	Area Codes, Local Numbers, and Toll-Free Numbers
Latin America	Customer Technical Support (Austin, Texas, U.S.A.)	512 728-4093
	Customer Service (Austin, Texas, U.S.A.)	512 728-3619
	Fax (Technical Support and Customer Service) (Austin, Texas, U.S.A.)	512 728-3883
	Sales (Austin, Texas, U.S.A.)	512 728-4397
	SalesFax (Austin, Texas, U.S.A.)	512 728-4600 or 512 728-3772
Luxembourg	Website: support.euro.dell.com	
International Access Code: 00	E-mail: tech_be@dell.com	
Country Code: 352	Technical Support (Brussels, Belgium)	3420808075
	Home/Small Business Sales (Brussels, Belgium)	toll-free: 080016884
	Corporate Sales (Brussels, Belgium)	02 481 91 00
	Customer Care (Brussels, Belgium)	02 481 91 19
	Fax (Brussels, Belgium)	02 481 92 99
	Switchboard (Brussels, Belgium)	02 481 91 00
Macao	Technical Support	toll-free: 0800 105
Country Code: 853	Customer Service (Xiamen, China)	34 160 910
	Transaction Sales (Xiamen, China)	29 693 115
Malaysia (Penang)	Website: support.ap.dell.com	
International Access Code: 00	Technical Support (Dell Precision, OptiPlex, and Latitude)	toll-free: 1 800 88 0193
Country Code: 60	Technical Support (Dimension, Inspiron, and Electronics and Accessories)	toll-free: 1 800 88 1306
City Code: 4	Technical Support (PowerApp, PowerEdge, PowerConnect, and PowerVault)	toll-free: 1800 88 1386
	Customer Service (Penang, Malaysia)	04 633 4949
	Transaction Sales	toll-free: 1 800 888 202
	Corporate Sales	toll-free: 1 800 888 213

Country (City) International Access Code Country Code City Code	Department Name or Service Area, Website and E-Mail Address	Area Codes, Local Numbers, and Toll-Free Numbers
Mexico	Customer Technical Support	001-877-384-8979
International Access Code: 00		or 001-877-269-3383
Country Code: 52	Sales	50-81-8800
		or 01-800-888-3355
	Customer Service	001-877-384-8979
		or 001-877-269-3383
	Main	50-81-8800
		or 01-800-888-3355
Montserrat	General Support	toll-free: 1-866-278-6822
Netherlands Antilles	General Support	001-800-882-1519
Netherlands (Amsterdam)	Website: support.euro.dell.com	
International Access Code: 00	Technical Support for Inspiron XPS computers only	020 674 45 94
Country Code: 31	Technical Support for all other Dell computers	020 674 45 00
City Code: 20	Technical Support Fax	020 674 47 66
	Home/Small Business Customer Care	020 674 42 00
	Relational Customer Care	020 674 4325
	Home/Small Business Sales	020 674 55 00
	Relational Sales	020 674 50 00
	Home/Small Business Sales Fax	020 674 47 75
	Relational Sales Fax	020 674 47 50
	Switchboard	020 674 50 00
	Switchboard Fax	020 674 47 50
New Zealand	E-mail (New Zealand): nz_tech_support@dell.com	
International Access Code: 00	E-mail (Australia): au_tech_support@dell.com	
Country Code: 64	Technical Support (for desktop and portable computers)	toll-free: 0800 446 255
	Technical Support (for servers and workstations)	toll-free: 0800 443 563
	Home and Small Business	0800 446 255
	Government and Business	0800 444 617
	Sales	0800 441 567
	Fax	0800 441 566

Country (City) International Access Code Country Code City Code	Department Name or Service Area, Website and E-Mail Address	Area Codes, Local Numbers, and Toll-Free Numbers
Nicaragua	General Support	001-800-220-1006
Norway (Lysaker)	Website: support.euro.dell.com	
International Access Code: 00	E-mail: support.euro.dell.com/no/no/emaildell/	
Country Code: 47	Technical Support	671 16882
	Relational Customer Care	671 17575
	Home/Small Business Customer Care	23162298
	Switchboard	671 16800
	Fax Switchboard	671 16865
Panama	General Support	001-800-507-0962
Peru	General Support	0800-50-669
Poland (Warsaw)	Website: support.euro.dell.com	
International Access Code: 011	E-mail: pl_support_tech@dell.com	
Country Code: 48	Customer Service Phone	57 95 700
City Code: 22	Customer Care	57 95 999
	Sales	57 95 999
	Customer Service Fax	57 95 806
	Reception Desk Fax	57 95 998
	Switchboard	57 95 999
Portugal	Website: support.euro.dell.com	
International Access Code: 00	E-mail: support.euro.dell.com/pt/en/emaildell/	
Country Code: 351	Technical Support	707200149
	Customer Care	800 300 413
	Sales	800 300 410 or 800 300 411 or 800 300 412 or 21 422 07 10
	Fax	21 424 01 12
Puerto Rico	General Support	1-800-805-7545
St. Kitts and Nevis	General Support	toll-free: 1-877-441-4731
St. Lucia	General Support	1-800-882-1521
St. Vincent and the Grenadines	General Support	toll-free: 1-877-270-4609

Country (City) International Access Code Country Code City Code	Department Name or Service Area, Website and E-Mail Address	Area Codes, Local Numbers, and Toll-Free Numbers
Singapore (Singapore)	Website: support.ap.dell.com	
International Access Code: 005 Country Code: 65	Technical Support (Dimension, Inspiron, and Electronics and Accessories)	toll-free: 1800 394 7430
	Technical Support (OptiPlex, Latitude, and Dell Precision)	toll-free: 1800 394 7488
	Technical Support (PowerApp, PowerEdge, PowerConnect, and PowerVault)	toll-free: 1800 394 7478
	Customer Service (Penang, Malaysia)	604 633 4949
	Transaction Sales	toll-free: 1 800 394 7412
	Corporate Sales	toll-free: 1 800 394 7419
Slovakia (Prague)	Website: support.euro.dell.com	
International Access Code: 00 Country Code: 421	E-mail: czech_dell@dell.com	
	Technical Support	02 5441 5727
	Customer Care	420 22537 2707
	Fax	02 5441 8328
	Tech Fax	02 5441 8328
	Switchboard (Sales)	02 5441 7585
South Africa (Johannesburg)	Website: support.euro.dell.com	
International Access Code: 09/091 Country Code: 27 City Code: 11	E-mail: dell_za_support@dell.com	
	Gold Queue	011 709 7713
	Technical Support	011 709 7710
	Customer Care	011 709 7707
	Sales	011 709 7700
	Fax	011 706 0495
	Switchboard	011 709 7700
Southeast Asian and Pacific Countries	Customer Technical Support, Customer Service, and Sales (Penang, Malaysia)	604 633 4810

Country (City) International Access Code Country Code City Code	Department Name or Service Area, Website and E-Mail Address	Area Codes, Local Numbers, and Toll-Free Numbers
Spain (Madrid)	Website: support.euro.dell.com	
International Access Code: 00	E-mail: support.euro.dell.com/es/es/emaildell/	
Country Code: 34	Home and Small Business	
City Code: 91	Technical Support	902 100 130
	Customer Care	902 118 540
	Sales	902 118 541
	Switchboard	902 118 541
	Fax	902 118 539
	Corporate	
	Technical Support	902 100 130
	Customer Care	902 115 236
	Switchboard	91 722 92 00
	Fax	91 722 95 83
Sweden (Upplands Vasby)	Website: support.euro.dell.com	
International Access Code: 00	E-mail: support.euro.dell.com/se/sv/emaildell/	
Country Code: 46	Technical Support	08 590 05 199
City Code: 8	Relational Customer Care	08 590 05 642
	Home/Small Business Customer Care	08 587 70 527
	Employee Purchase Program (EPP) Support	20 140 14 44
	Technical Support Fax	08 590 05 594
	Sales	08 590 05 185
Switzerland (Geneva)	Website: support.euro.dell.com	
International Access Code: 00	E-mail: Tech_support_central_Europe@dell.com	
Country Code: 41	E-mail for French-speaking HSB and Corporate Customers: support.euro.dell.com/ch/fr/emaildell/	
City Code: 22	Technical Support (Home and Small Business)	0844 811 411
	Technical Support (Corporate)	0844 822 844
	Customer Care (Home and Small Business)	0848 802 202
	Customer Care (Corporate)	0848 821 721
	Fax	022 799 01 90
	Switchboard	022 799 01 01

Country (City) International Access Code Country Code City Code	Department Name or Service Area, Website and E-Mail Address	Area Codes, Local Numbers, and Toll-Free Numbers
Taiwan	Website: support.ap.dell.com	
International Access Code: 002	E-mail: ap_support@dell.com	
Country Code: 886	Technical Support (OptiPlex, Latitude, Inspiron, Dimension, and Electronics and Accessories)	toll-free: 00801 86 1011
	Technical Support (PowerApp, PowerEdge, PowerConnect, and PowerVault)	toll-free: 00801 60 1256
	Transaction Sales	toll-free: 00801 65 1228
	Corporate Sales	toll-free: 00801 651 227
Thailand	Website: support.ap.dell.com	
International Access Code: 001	Technical Support (OptiPlex, Latitude, and Dell Precision)	toll-free: 1800 0060 07
Country Code: 66	Technical Support (PowerApp, PowerEdge, PowerConnect, and PowerVault)	toll-free: 1800 0600 09
	Customer Service (Penang, Malaysia)	604 633 4949
	Corporate Sales	toll-free: 1800 006 009
	Transaction Sales	toll-free: 1800 006 006
Trinidad/Tobago	General Support	1-800-805-8035
Turks and Caicos Islands	General Support	toll-free: 1-866-540-3355

Country (City) International Access Code Country Code City Code	Department Name or Service Area, Website and E-Mail Address	Area Codes, Local Numbers, and Toll-Free Numbers
U.K. (Bracknell)	Website: support.euro.dell.com	
International Access Code: 00	Customer Care website: support.euro.dell.com/uk/en/ECare/Form/Home.asp	
Country Code: 44		
City Code: 1344	E-mail: dell_direct_support@dell.com	
	Technical Support (Corporate/Preferred Accounts/PAD [1000+ employees])	0870 908 0500
	Technical Support (direct and general)	0870 908 0800
	Global Accounts Customer Care	01344 373 186
	Home and Small Business Customer Care	0870 906 0010
	Corporate Customer Care	01344 373 185
	Preferred Accounts (500–5000 employees) Customer Care	0870 906 0010
	Central Government Customer Care	01344 373 193
	Local Government & Education Customer Care	01344 373 199
	Health Customer Care	01344 373 194
	Home and Small Business Sales	0870 907 4000
	Corporate/Public Sector Sales	01344 860 456
	Home and Small Business Fax	0870 907 4006
Uruguay	General Support	toll-free: 000-413-598-2521

Country (City) International Access Code Country Code City Code	Department Name or Service Area, Website and E-Mail Address	Area Codes, Local Numbers, and Toll-Free Numbers
U.S.A. (Austin, Texas)	Automated Order-Status Service	toll-free: 1-800-433-9014
International Access Code: 011 Country Code: 1	AutoTech (portable and desktop computers) Consumer (Home and Home Office) Technical Support Customer Service DellNet™ Service and Support Employee Purchase Program (EPP) Customers Financial Services website: www.dellfinancialservices.com Financial Services (lease/loans) Financial Services (Dell Preferred Accounts [DPA]) Business Customer Service and Technical Support Employee Purchase Program (EPP) Customers Printers and Projectors Technical Support Public (government, education, and healthcare) Customer Service and Technical Support Employee Purchase Program (EPP) Customers Dell Sales Dell Outlet Store (Dell refurbished computers) Software and Peripherals Sales Spare Parts Sales Extended Service and Warranty Sales Fax Dell Services for the Deaf, Hard-of-Hearing, or Speech-Impaired	toll-free: 1-800-247-9362 toll-free: 1-800-624-9896 toll-free: 1-800-624-9897 toll-free: 1-877-Dellnet (1-877-335-5638) toll-free: 1-800-695-8133 toll-free: 1-877-577-3355 toll-free: 1-800-283-2210 toll-free: 1-800-822-8965 toll-free: 1-800-695-8133 toll-free: 1-877-459-7298 toll-free: 1-800-456-3355 toll-free: 1-800-234-1490 toll-free: 1-800-289-3355 or toll-free: 1-800-879-3355 toll-free: 1-888-798-7561 toll-free: 1-800-671-3355 toll-free: 1-800-357-3355 toll-free: 1-800-247-4618 toll-free: 1-800-727-8320 toll-free: 1-877-DELLTTY (1-877-335-5889)
U.S. Virgin Islands	General Support	1-877-673-3355
Venezuela	General Support	8001-3605

Index

A

audio. See *sound*

B

battery

- problems, 37
- replacing, 106

BIOS, 113

boot sequence

- about, 119
- changing, 119-120
- option settings, 119

booting

- to a USB device, 119

C

cards

- installing PCI Express, 82
- PCI Express, 81
- removing PCI, 80
- removing PCI Express, 86
- slots, 68

CD/DVD drive

- activity light, 65
- eject button, 65
- problems, 38

CD-RW drive

- problems, 39

CDs, 18

- playing, 16

Check Disk, 39

CMOS settings

- clearing, 122

computer

- components inside, 70
- crashes, 43-44
- inside view, 70
- restore to previous state, 59-60
- stops responding, 43

connectors

- center/LFE, 67
- headphone, 66
- IEEE 1394, 66
- line-in, 67
- line-out, 67
- microphone, 66-67
- network adapter, 68
- power, 67
- sound, 67
- surround, 67
- USB, 66, 68

copying CDs

- general information, 18
- helpful tips, 20
- how to, 18

copying DVDs

- general information, 18
- helpful tips, 20
- how to, 18

cover

- replacing, 107

D

Dell

- Dell Diagnostics, 56
- support policy, 123
- support site, 11

Dell Premier Support

- website, 9, 11

diagnostic lights, 53

diagnostics

- Dell, 56
- lights, 53, 66

documentation

- online, 11
- Product Information Guide, 9
- Setup Diagram, 9

drive panel, 66, 89

- removing, 89
- replacing, 91

drive-panel insert

- removing, 90
- replacing, 90

drivers

- about, 57
- identifying, 58

drives

- problems, 38
- RAID, 28

DVD drive
problems, 38

DVDs, 18
playing, 16

E

e-mail
problems, 39

error messages
diagnostic lights, 53
troubleshooting, 41

F

Files and Settings Transfer
Wizard, 27

Finding Information, 9

Flex Bay drive
Media Card Reader, 65

H

hard drive
activity light, 66
problems, 39

hardware
Dell Diagnostics, 56
drives, RAID configuration, 28

Hardware Troubleshooter, 59

headphone
connector, 66

Help and Support Center, 12

hibernate mode, 25, 27

Hyper-Threading, 27

I

IEEE 1394
connector, 66

installing parts
before you begin, 63
recommended tools, 63
turning off your computer, 63

Internet
connection, about, 14
connection, options, 14
connection, setting up, 15
problems, 39

K

keyboard
problems, 42

L

labels
Microsoft Windows, 10
Service Tag, 10, 66

latch release
cover, 65

lights
diagnostic, 53, 66
front of computer, 53
hard drive activity, 66

M

Media Card Reader
installing, 99, 101
problems, 42
removing, 99
using, 20

memory
problems, 45

messages
error, 41

microphone
connector, 66-67

Microsoft Windows label, 10

modem
problems, 39

monitor
blank, 50
clone mode, 23
connect DVI, 21-22
connect TV, 21, 23
connect two, 21-22
connect VGA, 21-22
display settings, 23
extended desktop mode, 23
hard to read, 51

motherboard. See *system board*

mouse
problems, 45

N

network
connector, 68
Network Setup Wizard, 24
problems, 46
setting up, 23
Network Setup Wizard, 24

O

operating system
reinstalling Windows XP, 60

P

password
clearing, 121
jumper, 121
PC Restore, 61
PCI cards
removing, 80
PCI Express cards
installing, 82
removing, 86
playing CDs and DVDs, 16
power
button, 66
connector, 67
conserving, 24
hibernate mode, 25, 27
managing, 24

power (*continued*)
options, 25
options, advanced, 26
options, hibernate, 27
options, schemes, 26
problems, 47
standby mode, 25
power light
conditions, 47
Power Options Properties, 25
printer
cable, 13
connecting, 13
problems, 48
setting up, 13
USB, 14
problems
battery, 37
blue screen, 44
CD drive, 38
CD-RW drive, 39
computer crashes, 43-44
computer stops responding, 43
Dell Diagnostics, 56
diagnostic lights, 53
drives, 38
DVD drive, 38
e-mail, 39
error messages, 41
general, 43
hard drive, 39
Internet, 39
keyboard, 42
Media Card Reader, 42
memory, 45
modem, 39
monitor is blank, 50

problems (*continued*)
monitor is hard to read, 51
mouse, 45
network, 46
power, 47
power light conditions, 47
printer, 48
program crashes, 43
program stops responding, 43
programs and Windows
compatibility, 44
restore to previous state, 59-60
scanner, 48
screen is blank, 50
screen is hard to read, 51
software, 43-44
sound and speakers, 49
technical support policy, 123
troubleshooting tips, 37
volume adjusting, 49
Program Compatibility
Wizard, 44

R

RAID
configuring, 28
reinstalling
Windows XP, 60

S

safety instructions, 9
scanner
problems, 48
Service Tag, 10, 66

- settings
 - system setup, 113
- Setup Diagram, 9
- software
 - Hyper-Threading, 27
 - problems, 43-44
- sound
 - problems, 49
 - volume, 49
- sound connectors, 67
- speaker
 - problems, 49
 - volume, 49
- specifications
 - audio, 109
 - computer information, 109
 - connectors, 111
 - controls and lights, 112
 - drives, 111
 - environmental, 113
 - expansion bus, 110
 - memory, 109
 - physical, 112
 - power, 112
 - processor, 109
 - technical, 109
 - video, 109
- standby mode, 25
- support
 - policy, 123

- system board, 71
- System Restore, 59-60
- system setup
 - about, 113
 - entering, 114
 - options, 116
 - screens, 114

T

- technical support
 - policy, 123
- transferring information to a
 - new computer, 27
- troubleshooting
 - Dell Diagnostics, 56
 - diagnostic lights, 53
 - Hardware Troubleshooter, 59
 - Help and Support Center, 12
 - restore to previous state, 59-60
 - tips, 37

TV

- connect to computer, 21, 23

U

- USB
 - booting to devices, 119
 - connectors, 66, 68

V

- vents, 66
 - front panel, 66
- volume
 - adjusting, 49

W

- warranty, 9

Windows XP

- Device Driver Rollback, 58
- Files and Settings Transfer Wizard, 27
- Hardware Troubleshooter, 59
- Help and Support Center, 12
- Hyper-Threading, 27
- Network Setup Wizard, 24
- Program Compatibility Wizard, 44
- reinstalling, 60
- scanner, 49
- System Restore, 59-60

wizards

- Files and Settings Transfer Wizard, 27
- Network Setup Wizard, 24
- Program Compatibility Wizard, 44

Free Manuals Download Website

<http://myh66.com>

<http://usermanuals.us>

<http://www.somanuals.com>

<http://www.4manuals.cc>

<http://www.manual-lib.com>

<http://www.404manual.com>

<http://www.luxmanual.com>

<http://aubethermostatmanual.com>

Golf course search by state

<http://golfingnear.com>

Email search by domain

<http://emailbydomain.com>

Auto manuals search

<http://auto.somanuals.com>

TV manuals search

<http://tv.somanuals.com>