

*Mythos Solo Surround Array Loudspeakers*

## Thank You

Thank you for choosing the Definitive Technology Mythos Solo Surround Array Loudspeaker System featuring Spatial Array™ technology. The Mythos SSA-42 is a unique speaker that provides a stunning 5-channel surround experience from just one speaker. This extraordinary speaker makes enjoying a high performance surround audio system more convenient than ever before. You chose wisely.

Our engineers spent many years developing this product. In order to ensure that you experience the finest performance possible, we encourage you to take a moment to fully read this owner's manual and familiarize yourself with the proper installation and set-up procedures for your Mythos SSA-42 speaker.

*Definitive Technology*®  
The Leader in High-Performance Loudspeakers®

**Specifications****SSA-42**

Dimensions:	40 <sup>7</sup> / <sub>8</sub> " W (102.5 cm) x 4 <sup>1</sup> / <sub>8</sub> " D (10.48 cm) x 4 <sup>1</sup> / <sub>2</sub> " H (11.4 cm) (speaker only, not including bracket)
Driver Complement:	Three 3 <sup>3</sup> / <sub>4</sub> " (8.3 cm) BDSS High-output drivers with coincident array 3 <sup>3</sup> / <sub>4</sub> " (20 mm) ferro-magnetic fluid damped pure aluminum dome tweeter. Two 3 <sup>3</sup> / <sub>4</sub> " (8.3 cm) BDSS High-output full-range drivers. Four 3" (7.6 cm) full-range high-output surround drivers with butyl rubber surrounds.
Frequency Response:	60 Hz – 30 kHz
Nominal Impedance:	8 Ohms
Rec. Assoc. Amplification:	20 – 175 Watts/channel
Sensitivity:	89 dB
Weight:	20 lbs. (4.52 kg)

Specifications subject to change without notice.

**Unpacking Your SSA Speakers**

## Please Inspect For Shipping Damage

Each loudspeaker leaves our plant in perfect condition. Any visible or concealed damage most likely occurred in handling after it left our plant and should be reported at once to your Definitive dealer or the delivery company that delivered your loudspeaker. Please unpack your system carefully. Save all cartons and packing materials in case you move or need to ship your system. Record the serial number found on the back of the Mythos SSA in the appropriate place on the product registration card, answer all questions and send it in.

## VERY IMPORTANT: Accessories

Various parts and accessories that you will need to use your Mythos SSA are in the carton but are easy to overlook. Open both ends of the shipping carton. Carefully examine the contents of the shipping carton and packing material to find the plastic bags with accessories.

## Positioning the SSA

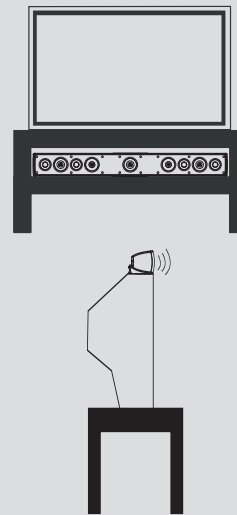
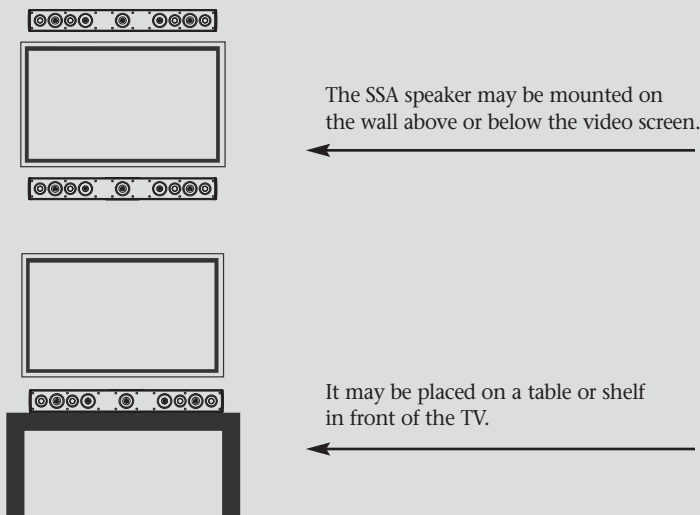

If placed on a shelf under a TV, adjust the leveling feet (screwed all the way in) to aim the speaker up towards the listeners.

The SSA speaker may be placed directly on top of TVs that have at least 5-inches (13 cm) of flat surface on top. Do not place the SSA speaker on top of any surface that is not large or stable enough to securely support the speaker. If the speaker seems at all unstable or “tipsy” place the speaker somewhere else. **The warranty does not cover damage caused by falls due to improper positioning of the speaker.** If the speaker is above seated listener height, extend the leveling feet to point the speaker downward [See *Using the Leveling Feet* on page 3].

**Even if you intend to place the SSA speaker on a TV or shelf you must attach the wall-mount bracket to the speaker. See *Using the Leveling Feet* on page 3.**

## Wall Mounting the SSA

- We recommend that the SSA speaker be wall mounted by professional installers or by those appropriately skilled in the use of power tools and who have knowledge of building codes and structural issues.
- We recommend that you determine a suitable location for your speaker installation, and that you complete all wiring (especially “hidden” in-wall wiring) before mounting the bracket to your wall.
- Mythos Brackets are not suitable for ceiling mounting.

The Mythos Solo Surround Array loudspeaker comes with a wall mounting bracket and template that makes secure mounting a breeze. Follow these directions for installing the wall mounting bracket.

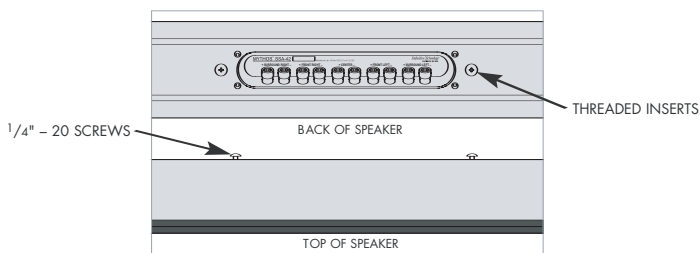

- Two 1/4"-20 screws have been factory installed on the back of the speaker. Gently hand-turn the screws to make sure they are in as far as they can go. Do not force them beyond the “stop” point. The screws cannot screw all the way into the speaker and should protrude as shown in the illustration.
- Make sure the location you have selected for wall-mounting does not conceal behind-wall electrical wiring or plumbing.
- Hold the cardboard template (included) in the intended location. Make sure the speaker clears the ceiling, adjacent walls, corners, beams, lighting fixtures and door/window frames. Leave at least 1 1/2" (38 mm) above the speaker location to allow the speaker to slide down onto the bracket.
- Make sure the center of the template is perfectly centered with the TV screen.

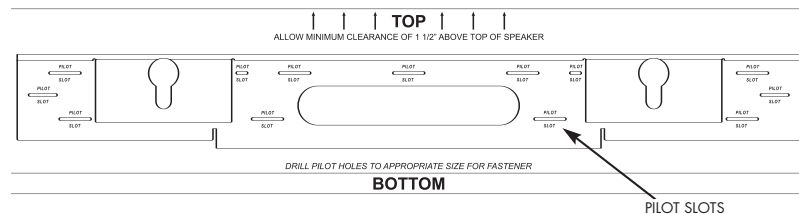

- Use a bubble level to make sure the template is level. If the TV is wall mounted and not level, the speaker will look better if it is off-level in exactly the same way as the TV.
- Use push pins to secure the template to the wall.
- Mark the location of pilot holes noted on the Mounting Template with a pencil; remove the template.
- Pre-drill the pilot hole locations for mounting screws (not included). Use screws rated to hold securely in the wall material (we recommend #10 screws).
- It is best if at least one screw hits a wall stud. If there is no stud behind the pilot hole location, install wall anchors (not included) to secure the bracket screws. Follow the wall anchor manufacturer's directions. Each wall anchor should be rated to hold at least one-half of the product net weight [see specifications on front cover].

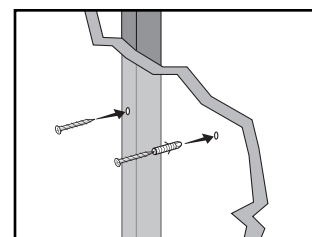

- For masonry walls, use a masonry drill bit to pre-drill holes, and use masonry anchors and screws (not included).
- Pull the five sets of speaker wires through the hole in the bracket.
- Screw the bracket to the wall.

# SSA-42

- When the wall mounting bracket is securely screwed to the wall, line up the speaker's protruding Mounting Screws with the keyhole slots on the wall mounting bracket. Let the speaker slide straight down, allowing the screw heads to slip behind the smaller end of the keyhole slots. Gently push the bottom front edge of the speaker toward the wall until the speaker snaps onto the lower lip of the bracket.

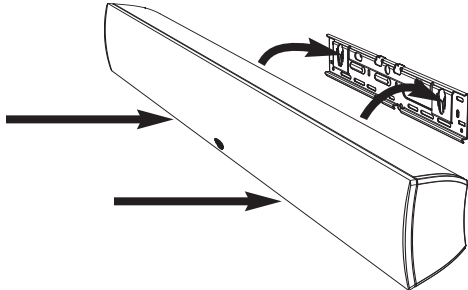

## Mounting the SSA to an articulating TV bracket

If you have a Plasma or LCD TV that is attached to the wall via a swing-out articulating bracket such as those offered by Chief, Sanus and OmniMount, the SSA speaker may be attached to the bracket without using the SSA wall-mount plate. Simply use 1/8"-20 screws to attach the SSA speaker directly to the TV bracket. Consult the TV bracket manufacturer's user manual for more specific speaker mounting instructions.

## Using the Leveling Feet

If you are going to use the speaker on a TV, shelf or table, first attach the wall-bracket to the speaker as described above. Attach the two "L" brackets to the wall-bracket using two M4 x 10 mm screws provided. Thread the foot screws into the two "L" brackets and adjust to the required height.



## Connecting the SSA

Your Mythos SSA has one pair of 5-way binding posts for each channel — Left Front, Right Front, Center, Left Surround and Right Surround.

To start, strip 1/2" (3 mm) of insulation from each speaker wire to expose the bare metal wire and twist each of the individual conductors into single un-frayed strands.

Note that one of the terminals for each channel is marked with red band (+) and the other is marked with black band (-). Make certain that you connect the wire from the red (+) terminal of your amplifier or receiver to the red (+) terminal of your speaker and the wire from the black (-) terminal of your amplifier or receiver to the black (-) terminal on your speaker. Most speaker

wire has some indicator (such as color-coding, ribbing or writing) on one of the two conductors to help you maintain consistency. It is essential to connect all channels of the speaker to the amplifier in the same way (in phase). If you experience a poor surround effect, it is likely that one or more of the channels is connected in incorrect polarity and needs to be rewired. Pay close attention and connect positive to positive; negative to negative on all channels.

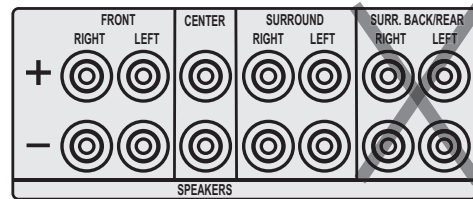

If you have a 6.1 or 7.1 channel receiver, connect the SSA's surround channel inputs to the "Surround" outputs of your receiver, not the "Rear" or "Surround Back" outputs.



To connect wire to the binding post [see figure above], unscrew the knurled nut and insert the bare wire into the hole near the base of the binding post. Do not insert the insulated part of the wire into the hole as this will not give you a good connection. Twist the nut back down the binding post until it firmly meets the wire. Do not over tighten.

Connect a single RCA cable from the "SUB OUT" of your receiver to the LFE input of the subwoofer (not included). This connecting method bypasses the subwoofer's internal "crossover" or low pass filter and relies on the crossover filter built into your receiver. **NOTE: Make no other signal connections. Do not use speaker wire to make the connection to the subwoofer**

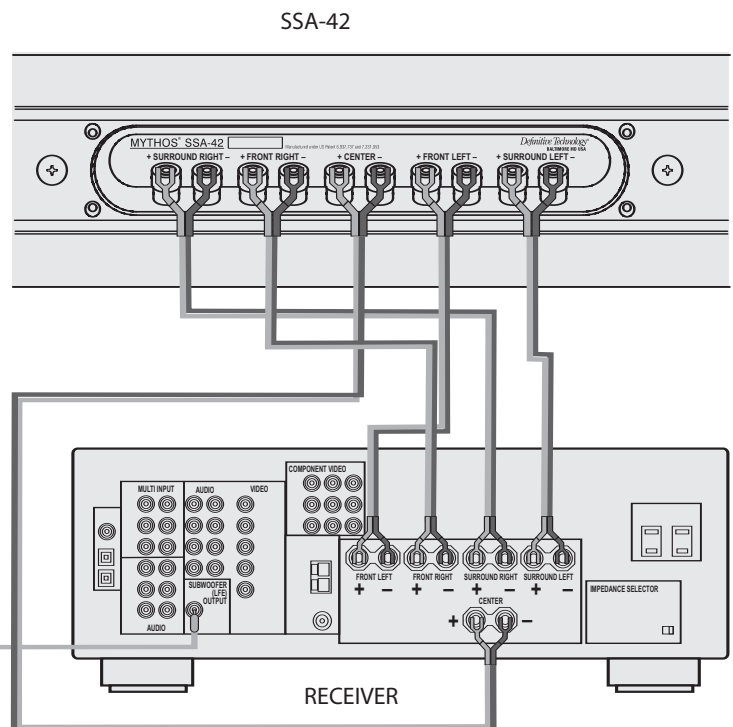
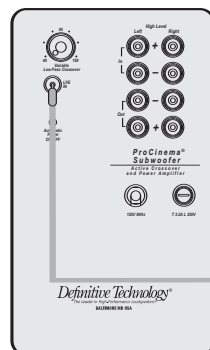

## Receiver/Speaker Set-up

**DO NOT USE THE "AUTO SETUP" FEATURE IF IT IS INCLUDED IN YOUR RECEIVER.** Because the SSA produces surround sound from a single front mounted speaker, the auto setup feature will not operate correctly and will actually make your system sound worse.

Access Your Receiver's "Speaker Set-up" or "Speaker Configuration" menu



1. In the Speaker Set-up/Configure function of your receiver, set all channels to "Small."

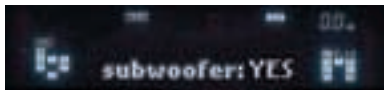

2. Select "Yes" when asked if you are using a subwoofer.
3. Set the subwoofer crossover frequency on the receiver to 120 Hz.

In the receiver's "Speaker Distance" Set-up Menu, select the same distance for all channels. If your receiver or processor uses a "Channel delay" setup function that requires a delay-time entry, use the minimum setting (in Ms) that it allows for the center and surround channels.

## Surround Sound Settings



Dolby Digital or DTS on all 5.1 channel programming; Dolby ProLogic or Dolby ProLogic II for all 2 channel sources such as radio and CDs.

## Set Surround Volume Levels:

1. Set Left, Center and Right to "Zero" (0dB).
2. Set Left and Right surround levels to a minimum of "+5" dB. Don't hesitate to set surround channels to "+7" dB or higher in order to hear enveloping surround sound.

## Optional 6.1 and 7.1 Channel Hookup

If you choose to use additional speakers with a 6.1 or 7.1 channel receiver, connect those speakers to the "Rear" channel outputs of your receiver. Consult the receiver owner's manual for specific information about 6.1 or 7.1 channel operation.

## Technical Assistance

It is our pleasure to offer assistance if you have any questions regarding your Mythos SSA or its set-up. Please contact your nearest Definitive Technology dealer or call us directly at (800) 228-7148 (US & Canada), 01 (410) 363-7148 (all other countries) or e-mail [info@definitivetech.com](mailto:info@definitivetech.com).

## Service

Service and warranty work on your Definitive loudspeakers will normally be performed by your local Definitive Technology dealer. If, however, you wish to return the speaker to us, please contact us first, describing the problem and requesting authorization as well as the location of the nearest factory service center. Please note that the address given in this booklet is the address of our offices only. **Under no circumstances should loudspeakers be shipped to our offices or returned without contacting us first and obtaining return authorization.**

Definitive Technology Offices  
 11433 Cronridge Drive, Owings Mills, Maryland 21117  
 Phone: (800) 228-7148 (US & Canada),  
 01 (410) 363-7148 (all other countries)

### Limited Warranty: 5-Years for Drivers and Cabinets, 3-Years for Electronic Components

DEI Sales Co., dba Definitive Technology (herein "Definitive") warrants to the original retail purchaser only that this Definitive loudspeaker product (the "Product") will be free from defects in material and workmanship for a period of five (5) years covering the drivers and cabinets, and three (3) years for the electronic components from the date of the original purchase from a Definitive Authorized Dealer. If the Product is defective in material or workmanship, Definitive or its Authorized Dealer will, at its option, repair or replace the warranted product at no additional charge, except as set forth below. All replaced parts and Product(s) become the property of Definitive. Product that is repaired or replaced under this warranty will be returned to you, within a reasonable time, freight collect. This warranty is non-transferrable and is automatically void if the original purchaser sells or otherwise transfers the Product to any other party.

*This Warranty does not include service or parts to repair damage caused by accident, misuse, abuse, negligence, inadequate packing or shipping procedures, commercial use, voltage in excess of the rated maximum of the unit, cosmetic appearance of cabinetry not directly attributable to defects in material or workmanship. This warranty does not cover the elimination of externally generated static or noise, or the correction of antenna problems or weak reception. This warranty does not cover labor costs or damage to the Product caused by installation or removal of the Product. Definitive Technology makes no warranty with respect to its products purchased from dealers or outlets other than Definitive Technology Authorized Dealer.*

THE WARRANTY IS AUTOMATICALLY VOID IF:

- 1) The product has been damaged, altered in any way, mishandled during transportation, or tampered with.
- 2) The product is damaged due to accident, fire, flood, unreasonable use, misuse, abuse, customer applied cleaners, failure to observe manufacturers warnings, neglect or related events.
- 3) Repair or modification of the Product has not been made or authorized by Definitive Technology.
- 4) The product has been improperly installed or used.

Product must be returned (insured and prepaid), together with the original dated proof of purchase to the Authorized Dealer from whom the Product was purchased, or to the nearest Definitive factory service center. Product must be shipped in the original shipping container or its equivalent. Definitive is not responsible or liable for loss or damage to Product in transit.

THIS LIMITED WARRANTY IS THE ONLY EXPRESS WARRANTY THAT APPLIES TO YOUR PRODUCT. DEFINITIVE NEITHER ASSUMES NOR AUTHORIZES ANY PERSON OR ENTITY TO ASSUME FOR IT ANY OTHER OBLIGATION OR LIABILITY IN CONNECTION WITH YOUR PRODUCT OR THIS WARRANTY. ALL OTHER WARRANTIES, INCLUDING BUT NOT LIMITED TO EXPRESS, IMPLIED, WARRANTY OF MERCHANTABILITY OR FITNESS FOR A PARTICULAR PURPOSE, ARE EXPRESSLY EXCLUDED AND DISCLAIMED TO THE MAXIMUM EXTENT ALLOWED BY LAW. ALL IMPLIED WARRANTIES ON PRODUCT ARE LIMITED TO THE DURATION OF THIS EXPRESSED WARRANTY. DEFINITIVE HAS NO LIABILITY FOR ACTS OF THIRD PARTIES. DEFINITIVE'S LIABILITY, WHETHER BASED ON CONTRACT, TORT, STRICT LIABILITY, OR ANY OTHER THEORY, SHALL NOT EXCEED THE PURCHASE PRICE OF THE PRODUCT FOR WHICH A CLAIM HAS BEEN MADE. UNDER NO CIRCUMSTANCE WILL DEFINITIVE BEAR ANY LIABILITY FOR INCIDENTAL, CONSEQUENTIAL OR SPECIAL DAMAGES. THE CONSUMER AGREES AND CONSENTS THAT ALL DISPUTES BETWEEN THE CONSUMER AND DEFINITIVE SHALL BE RESOLVED IN ACCORDANCE WITH CALIFORNIA LAWS IN SAN DIEGO COUNTY, CALIFORNIA. DEFINITIVE RESERVES THE RIGHT TO MODIFY THIS WARRANTY STATEMENT AT ANY TIME.

Some states do not allow the exclusion or limitation of consequential or incidental damages, or implied warranties, so the above limitations may not apply to you. This warranty gives you specific legal rights, and you may also have other rights which vary from state to state.

©2008 DEI Sales Co.

All rights reserved.



This product complies with the essential requirements of the EMC directive 89/336/EEC.

**Definitive Technology®**  
 The Leader in High-Performance Loudspeakers®

For more information on Definitive Technology Loudspeakers and accessories, visit [www.definitivetech.com](http://www.definitivetech.com), or email [info@definitivetech.com](mailto:info@definitivetech.com).  
 Definitive Technology, Owings Mills, Maryland, USA. 800-228-7148

## Free Manuals Download Website

<http://myh66.com>

<http://usermanuals.us>

<http://www.somanuals.com>

<http://www.4manuals.cc>

<http://www.manual-lib.com>

<http://www.404manual.com>

<http://www.luxmanual.com>

<http://aubethermostatmanual.com>

Golf course search by state

<http://golfingnear.com>

Email search by domain

<http://emailbydomain.com>

Auto manuals search

<http://auto.somanuals.com>

TV manuals search

<http://tv.somanuals.com>