



INSTRUCTION MANUAL

DVD6019-B

PRECAUTIONS

A lightning bolt with an arrowhead symbol within an equilateral triangle is intended to alert the user to the presence of uninsulated "dangerous voltage" within the product's enclosure that may be of sufficient magnitude to constitute a risk of electric shock to persons.



The exclamation point within an equilateral triangle is intended to alert the user to the presence of important operating and maintenance (servicing) instructions in the literature accompanying the appliance.



WARNING: TO AVOID THE DANGER OF FIRE OR ELECTRIC SHOCK, DO NOT EXPOSE THIS APPLIANCE TO RAIN OR MOISTURE. NEVER OPEN THE CABINET, AS DANGEROUS HIGH VOLTAGES ARE CONTAINED INSIDE. ONLY A QUALIFIED SERVICE TECHNICIAN SHOULD ATTEMPT TO OPEN THE CABINET.

CAUTION: TO PREVENT ELECTRIC SHOCK, MATCH WIDE BLADE OF PLUG TO WIDE SLOT, AND FULLY INSERT INTO ELECTRICAL SOCKET.

CAUTION: This DVD receiver unit employs a laser system. To prevent direct exposure to the laser beam, do not open the enclosure. Visible laser radiation is present when enclosure is open. DO NOT STARE INTO BEAM. Additionally, the use of controls or adjustments or performance of procedures other than those specified herein may result in hazardous radiation exposure.

To ensure proper use of this product, please read this owner's manual carefully and retain for future reference.

PROTECT YOURSELF!

Record the model and serial numbers for this unit while it is easy to see them. These numbers are located on the back of the unit's cabinet. Retain this information for future reference.

Model No. _____

Serial No. _____

Retain this information for future reference.



CAUTION

RISK OF ELECTRIC SHOCK DO NOT OPEN

CAUTION: TO REDUCE THE RISK OF ELECTRIC SHOCK, DO NOT REMOVE COVER (OR BACK). THERE IS NO USER SERVICEABLE PART INSIDE. REFER SERVICING TO QUALIFIED SERVICE PERSONNEL.

IMPORTANT-- SAFETY INFORMATION

CAUTION: Is it important that you read and follow all of the instructions in this booklet and any marked on the unit itself. Retain this booklet for future reference.

Accessories--- Never place this product on an unstable platform, stand, cart, wall mount, shelf, or table. The product may fall, causing serious personal injury to persons and pets, as well as seriously damaging the product.

Any mounting of the product should follow the manufacturer's instructions, and use a mounting accessory recommended by the manufacturer. This unit while positioned on some type of cart must be moved with care. Quick stops, excessive force, and uneven surfaces may cause the product and cart combination to overturn.

Cleaning--- Always unplug this unit from the wall electrical outlet before cleaning. Do not use liquid or aerosol cleaners; use a damp cloth for cleaning.

Lightning--- For added product protection during a lightning storm or when it is left unattended and unused for long periods of time, unplug it from the wall outlet and/or disconnect the antenna or cable system. This will prevent damage to the product due to lightning and power-line surges.

Object and Liquid Entry--- Never push objects of any kind into this product through openings as they may touch dangerous voltage points or short-out parts that could result in a fire or electric shock. Never spill liquid of any kind on or into the product.

Outdoor Antenna Grounding--- If an outside antenna or cable system is connected to the product, be sure the antenna or cable system is grounded so as to provide protection against voltage surges and built-up static charges. Article 810 of the National Electrical Code, ANSI/NFPA 70, provides information with regard to proper grounding of the mast and supporting structure, grounding of the lead-in wire to an antenna discharge unit, size or grounding conductors, location of antenna-discharge unit, connection to grounding electrodes, and requirements for the grounding electrode.

Overloading--- Do not overload wall outlets, extension cords, or integral convenience receptacles, as this may result in a fire or electric shock.

Power - Cord Protection - Power - supply cords should be routed so that they are not likely to be walked on or pinched by items placed upon or against them, paying particular attention to cords at plugs, convenience receptacles, and the point where they exit from the product.

Power Lines--- An outside antenna system should not be located in the vicinity of overhead power lines or other electric light or power circuits, or where it can fall into such power lines or circuits. When installing an outside antenna system, extreme care should be taken to keep from touching such power lines or circuits as contact with them might be fatal.

Power Sources--- This product should be operated only from the type of power source indicated on the marking label. If you are not sure of the type of power supply to your home, consult your product dealer or local power company. For products intended to operate from battery power or other sources, refer to the operating instructions. This DVD home theater operates on 100-240V~50/60Hz. Do not turn off unit immediately after turning on; wait at least 10 seconds.

Replacement Parts--- If replacement parts are required, be sure the service technician has used replacement parts specified or have the same characteristics as the original part. Unauthorized substitutions may result in fire, electric shock, or other hazards.

Safety Check--- Upon completion of any service or repairs to this product, ask the service technician to perform safety checks to determine that the product is in proper operating condition.

Servicing--- Do not attempt to service this product yourself as opening or removing covers may expose you to dangerous voltage or other hazards. Refer all servicing to qualified service personnel.

TV System--- This unit is compatible with television sets featuring either the NTSC or PAL color system.

Ventilation--- Slots and openings in the cabinet are provided for ventilation and to ensure reliable operation and protection from overheating. These openings should never be blocked by placing the product on a bed, sofa, rug, or other similar surface. This product should not be placed in a built-in installation such as a bookcase or rack unless proper ventilation is provided. Never place this product near a heat source, such as heat registers, stoves, radiators, or any other product that produces heat.

Water and Moisture--- Do not use this product near sources of water and moisture, such as bath tub, wash bowl, kitchen sink, or wash machine; in a wet, damp basement; or near a swimming pool or similar locations. If moisture condensation occurs, remove any disc, connect the unit's power cord to a wall outlet, turn the unit on, and leave it on for two to three hours. By then, the unit will have warmed up and evaporated any moisture.

TABLE OF CONTENTS

Precaution	3	General Steps In The Setup Menu	21
Safety Information	4	1 System Setup	22
Table of Contents	5	1.1 System Setup	22
About Your DVD Player	6	1.1.1 Source	22
Best Location	6	1.1.2 Tv System	22
To Obtain a Clear Picture	6	1.1.3 Video	22
Playable Discs	6	1.1.4 Tv Type	22
Digital Audio Output	6	1.1.5 Password	22
Laser-Head Over-Current Protection System	6	1.1.6 Rating	22
Use of Disc	7	1.1.7 Default	23
Handling	7	1.2 Language Setup	23
Cleaning	7	1.2.1 Osd Language	23
Storing	7	1.2.2 Audio Lang	23
Front and Back panels	8	1.2.3 Subtitle Lang	23
Back Panel	8	1.2.4 Menu Language	23
Front Panel	8	1.3 Audio Setup	24
Remote Control	9	1.3.1 Audio Out	24
Operating the remote control	10	1.3.2 Lpcm Output	24
Connecting Devices	11	1.3.3 Prologic	24
Speakers	12	1.4 Video Setup	24
Arrangement of speakers	12	1.4.1 Brightness	24
Connecting speakers	13	1.4.2 Contrast	24
Connecting antenna	14	1.4.3 Hue	24
Connecting power supply	15	1.4.4 Saturation	25
Playing the radio	16	1.5 Speaker Setup	25
Basic DVD operation	17	1.5.1 Downmix	25
Functions	18	1.5.2 Center Delay	25
		1.5.3 Rear Delay	25
		1.6 Digital Setup	25
		1.6.1 Dynamic Range	25
		1.6.2 Dual Mono (left + Right)	25
		Mp3 & Mpeg Function	27
		Jpeg Files	28
		Troubleshooting	29
		Specifications	30

ABOUT YOUR DVD PLAYER

[Accessories]

Video/Audio cable x1PC

Remote Control x1PC

User' Manual x1PC

Batteries 2x1,5V AAA

Warranty Card x1PC

Speaker Cable x1set

The following will help you get the most enjoyment from your DVD receiver system.

BEST LOCATION

The unit should be placed on a firm, flat surface, away from VCRs, stereos, radios, or large speakers, as the magnetic flux from these devices may cause distortion in the sound and a poor picture. If placed in a cabinet, be sure there is at least 1" of free space completely around the unit for proper ventilation.

TO OBTAIN A CLEAR PICTURE

ADVD receiver is a precision device. If the optical pick-up lens and disc drive parts become dirty or worn down, picture quality will become poor. To obtain a clear picture, regular inspection and maintenance are recommended every 1,000 hours of use, depending on the operating environment. Contact dealer for details.

6

PLAYABLE DISCS

This DVD receiver system will play the following types of discs: DVD, MP3, CD, CD-R, and CD-RW with super-error correction ability. It is also capable of displaying picture CDs and digital photo albums. It supports eight languages, up to 32 subtitles, and multi-angle viewing. It features easy setup and operation with on-screen menus. It has full function CPU up grade able capability.

DIGITAL AUDIO OUTPUT

The unit's coaxial output capability enables you to connect an external six-channel AV amplifier and processor with built-in Dolby Digital code and MPEG modulating capacity with just one cord. This enables you to conveniently enjoy different DVD, CD, and Mp3 discs.

ANALOG AUDIO OUTPUT

Speaker system plug-and-play convenience through the built-in six-channel power amplifier eliminates the use of an external power amplifier.

LASER-HEAD OVER-CURRENT PROTECTION SYSTEM

To extend the service life of the laser head, the unit includes a unique laser-head over-current protection system, ensuring a constant laser current.

This page contains valuable information regarding the handling, cleaning, and storage of discs played in this unit.

Handling

- Do not touch the playback side of the disc.
- Do not attach paper or tape to discs.
- Do not stick or write anything on the surface. Protect against fingerprints.
- Always hold a disc by the center and edge portions.

Cleaning

- Fingerprints and dirt on the disc may cause picture and/or sound deterioration. Wipe the disc from the center outward with a soft cloth. Always keep the disc clean.
- If you cannot wipe the dirt off, lightly use a slightly moistened soft cloth and finish with a dry cloth.
- Do not use any type of solvent such as: Paint thinner, benzene, commercially available cleaners or anti-static spray for vinyl LPs.

Storing

- Do not store discs in places subject to direct sunlight or near heat sources.
- Do not store discs in places subject to moisture and dust.
- Store discs vertically in a case. Stacking or placing objects on discs outside of their case may cause warping.

FRONT AND BACK PANELS

Front Panel Functions

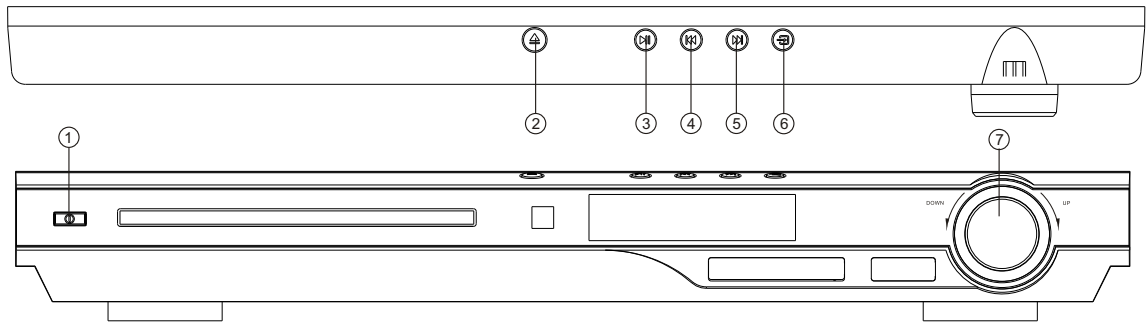

1. POWER

Before plugging the power cord into the AC outlet, check to make sure all of the connections have been properly completed. When they have been, carefully plug power cord into outlet.

Press the POWER button on the front panel to power the unit.

When the unit is initially powered, a brief surge of electricity may cause interference with other electronic equipment on the same circuit. If this occurs, connect the unit to an outlet on a different circuit.

2. \blacktriangle OPEN/CLOSE

Use this button to open and close the disc tray while in DVD mode.

3. $\blacktriangleright\parallel$ PLAY / PAUSE

Use this button to begin play function while in DVD mode.

Use this button to pause play function while in DVD mode.

4. $\blacktriangle\blacktriangle$ PREV

While in the DVD status, you may press this button for previous track.

5. $\blacktriangleright\blacktriangleright$ NEXT

While in the DVD status, you may press this button for next track.

6. \square INPUT SIGNAL SOURCE

Use this button to select the proper input signal source. (Note: The selected input will correspond to the selected input terminal on the rear panel.)

7. VOLUME

Use this button to control the unit's volume. It controls all six channels simultaneously.

Back Panel Functions

1. 100-240V~ 50/60Hz

This unit comes with an AC power cord. Be sure its prongs are dry before plugging it into an electrical outlet. Take caution not to overextend the cord or walk on it.

2. ANTENNA

Use to connect the provided indoor FM and AM loop antennas.

3. REAR

Use to connect the four terminals of the left and right surround sound speakers.

4. FRONT/MAIN

Use to connect the four terminals of the left and right front or main speakers.

5. CENTER/SUBWOOFER

Use to connect the four terminals of the center and subwoofer speakers.

6. AUX AUDIO INPUT

7. AUDIO MIXED OUTPUT

8. SUBWOOFER LINE OUT

9. COAXIAL OUTPUT

10. AUX VIDEO IN

11. COMPONENT VIDEO OUTPUT

12. VIDEO OUTPUT

13. S-VIDEO OUTPUT

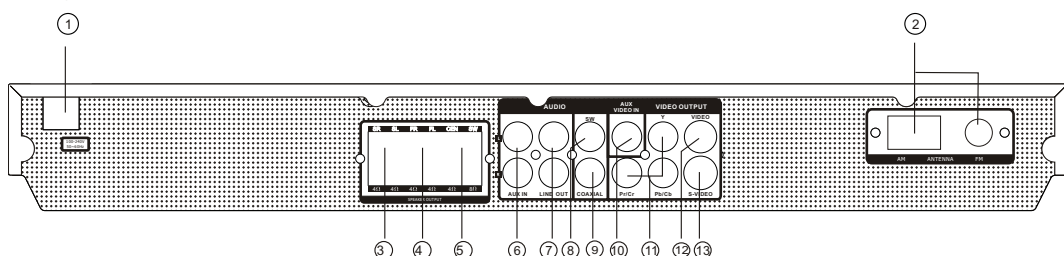

REMOTE CONTROLLER

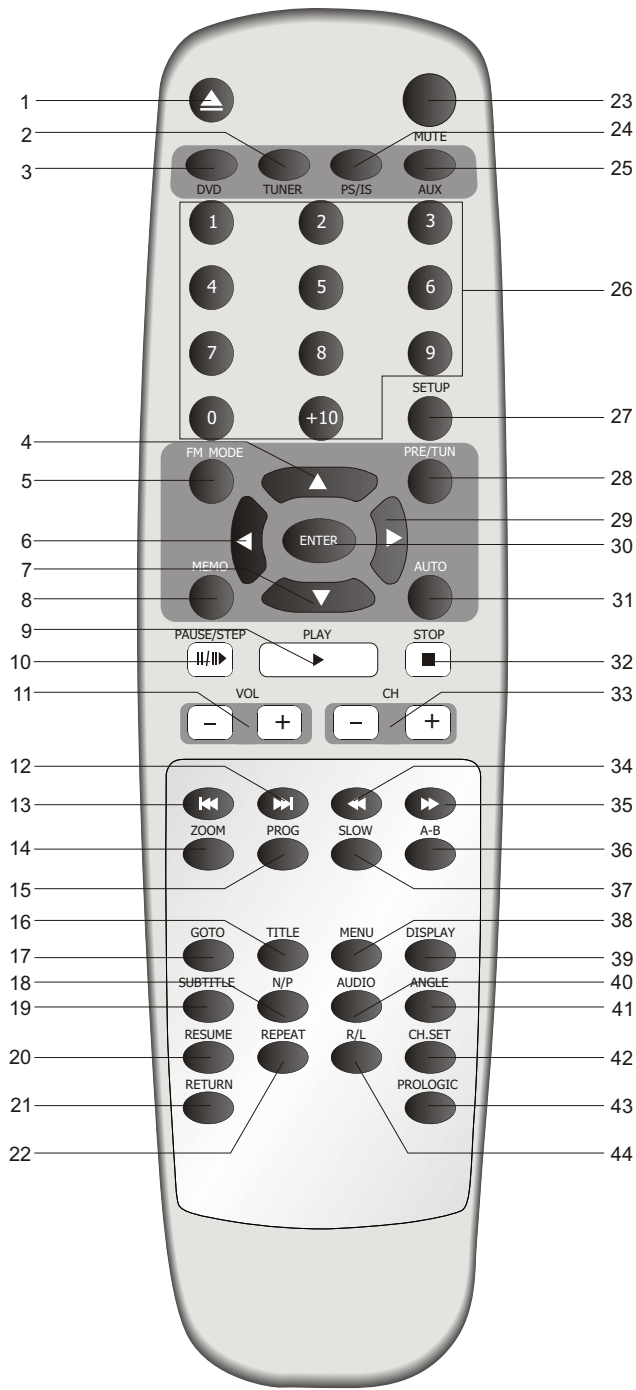

1. Open/Close
2. Tuner
3. DVD
4. Scroll Up
5. FM Mode
6. Scroll Left
7. Scroll Down
8. Memo
9. Play
10. Pause/Step
11. Volume Up and Down
12. Next
13. Previous
14. Zoom
15. Program
16. Title
17. Goto
18. N/P
19. Subtitle
20. Resume
21. Return
22. Repeat
23. Mute
24. PS/IS
25. AUX
26. 0-10+ Digits
27. Setup
28. Preset/Tuning
29. Scroll Right
30. Enter
31. Auto tuning
32. Stop
33. Channel Up and Down
34. Fast Reverse
35. Fast Forward
36. A - B Repeat
37. Slow
38. Menu
39. Display
40. Audio
41. Angle
42. CH.SEL
43. Pro Logic
44. R/L

Battery Installation

1. Push down and out on the battery Compartment cover to remove it.
2. Insert the two "AAA" batteries into the battery compartment of the remote control, making sure the + and - signs on the batteries and inside the battery compartment match up.
3. Replace the battery compartment cover.

Notes:

- Do not mix batteries from different manufacturers, nor old ones with new.
- If the remote control will not be used for an extended period of time, remove the batteries to prevent damage-causing corrosion.
- Remove dead batteries immediately to prevent damage-causing corrosion.
- If battery leakage occurs, wipe the battery liquid from the battery compartment, then replace both batteries.
- Always replace both batteries at the same time, using new, fully charged batteries.
- Life expectancy of batteries may vary depending on amount of use.

Using the Remote Control

Point the remote control at the remote sensor on the DVD receiver. When the signal is received from the remote, the unit will function accordingly. The remote will operate to approximately 16' from the remote sensor at an angle of around 30° each direction.

Notes:

- Do not direct the remote sensor toward any light source, such as direct sunlight or a strong fluorescent light, as it may cause the unit to not operate correctly.
- When other remote controls are used nearby or when the remote is used near equipment using infrared rays, interference may occur.
- Placing an object on the remote control may cause it to inadvertently depress a button, changing a function and shortening battery life.
- Do not glaze the front of the DVD receiver with colored glass, as it may cause interference with normal operation of the controller.
- Make sure there is no barrier between the remote control and remote sensor, as it could prevent the unit from receiving the signal.
- Do not spill water or put wet items on the remote control.
- Never disassemble remote control.



BATTERIES

INCORRECT USE OF BATTERIES MAY CAUSE THEM TO LEAK, CORRODE OR EXPLODE.

CONNECTING DEVICES

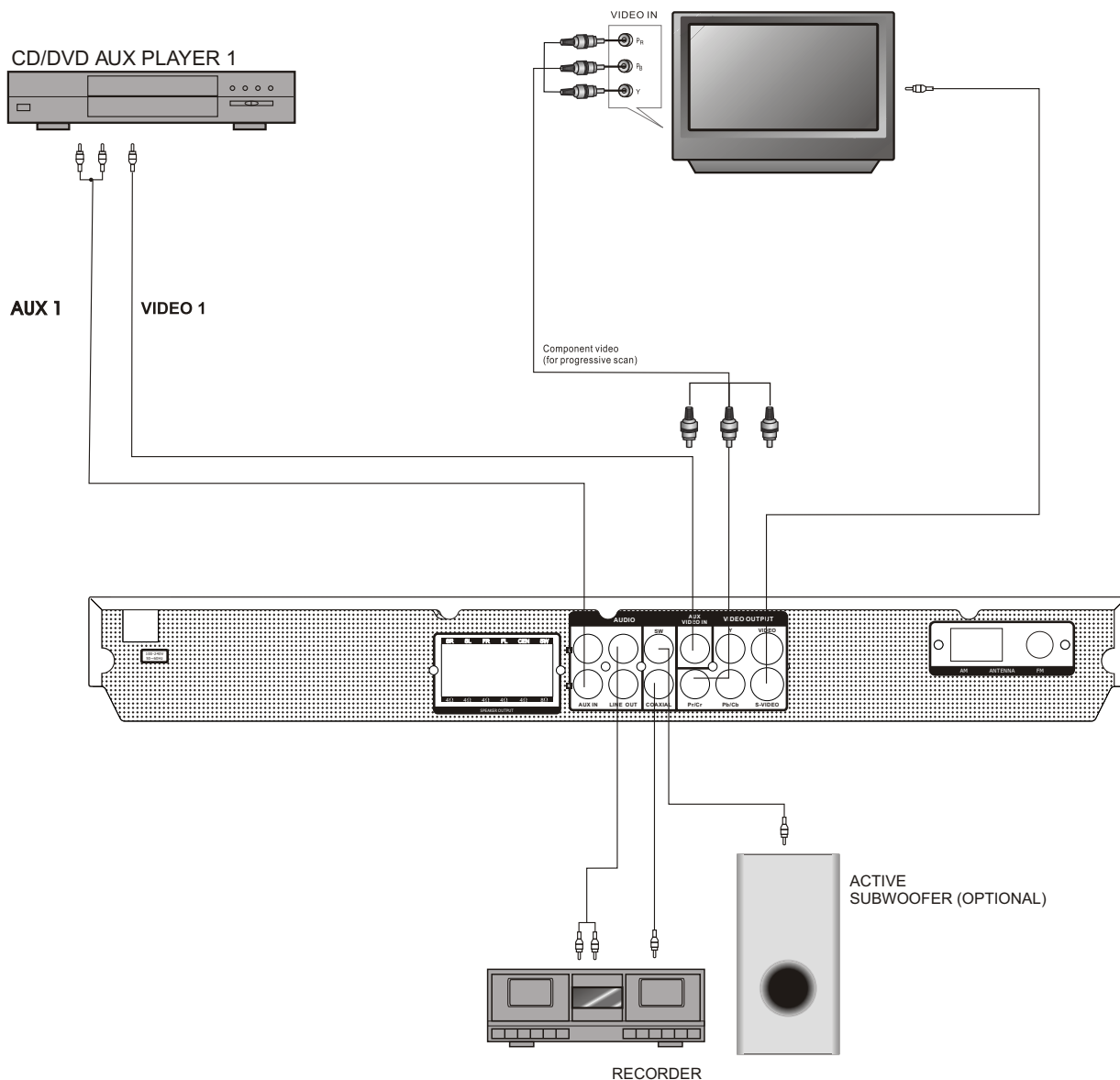

11

- Connection terminals for this DVD receiver are found on the rear panel. Read carefully and follow the manufacturers' instructions of any video and audio device being connected to this unit.
- Do not connect the power until all connections have been properly completed.
- Red terminal (marked R) is for connecting the right channel. The white terminal (marked L) is for connecting the left channel. The yellow terminal is for video connection. Make sure all connections are securely made. Improper connections may cause noise, poor performance, or cause damage to the equipment.
- Do not tie the AV cord with any other cords, such as the power cord or speaker wires, as it may result in poor picture and/or sound quality.

SPEAKERS

The configuration and arrangement of a surround sound system's speakers is critical. For maximum listening enjoyment, refer to the Arrangement of Speakers section in this manual prior to connecting speakers.

Surround Sound Speakers

Front or main right and left speakers; center speaker

- These three speakers provide extensive sound imaging and augment the dynamic effect of the audio. A movie's principal dialogue comes through these speakers.

Rear or surround sound speakers

- These two speakers provide 3-D dynamic sound effects, and create an enveloping atmosphere, as they add background sounds.

Subwoofer speaker

- Provides rich and powerful bass, adding a powerful dimension of realism.

Note: Audio recorded for the center speaker and subwoofer will be assigned to the front and 3-D rear speakers to obtain the optimum 3-D surround sound effect.

ARRANGEMENT OF SPEAKERS

The ideal surround sound speaker configuration may vary according to room size and wall material. The figure below illustrates a typical arrangement.

Hints:

- Front or main speakers and central speaker should be placed at the same level and in a way that sound is oriented toward the listener's ears.
- 3D surround sound or rear speakers should be placed 3' higher than the height of listener's ears.
- Subwoofer speaker may be placed anywhere within the room, as its location produces little effect on a listener's sensation to sound. To obtain the optimum bass effect, a subwoofer is recommended in home theater systems.

12

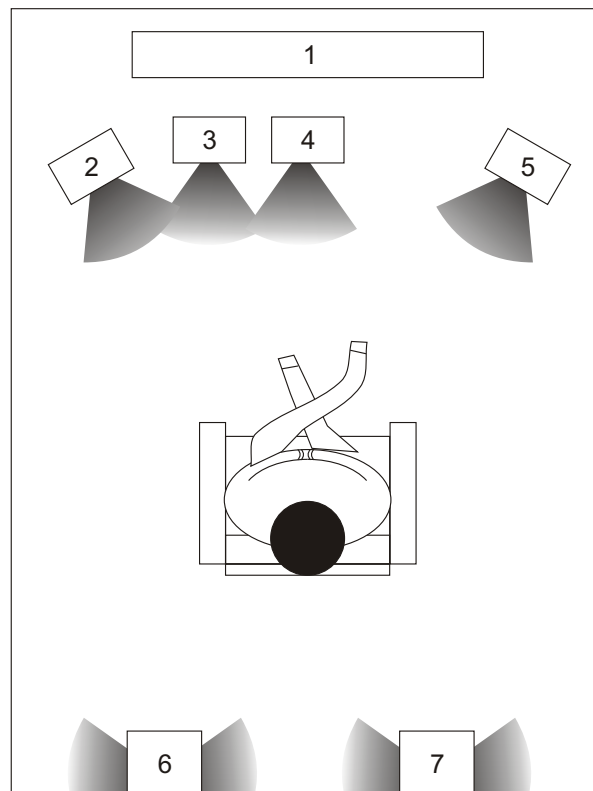

1. TV set or screen

2. Front or main left speaker

3. Subwoofer

4. Center speaker

5. Front or main right speaker

6. 3-D surround sound left speaker

7. 3-D surround sound right speaker

8. Viewer's location

CONNECTING SPEAKERS

This well-designed DVD receiver provides optimum sound quality when the speakers used are within the range of their rated impedance.

Important

- The minimum impedance of the five speaker terminals is 4 ohm; for the subwoofer, it is 8 ohm.
- If you want to use only one speaker or listen to monophonic music, do not parallel connect individual speakers to the left and right channel terminals. See the figure on the left below.

Connecting Speaker Cables

1. Peel off approximately 1/2" of cable insulation
2. Tighten the wire end (#2 below)
3. Open cable terminal by pressing back on tab
4. Insert wire end into terminal
5. Release tab; make sure wire is in terminal securely

Note: To prevent damage to the circuit, care should be taken to prevent short circuiting from occurring at the positive and negative poles of the speaker cord.

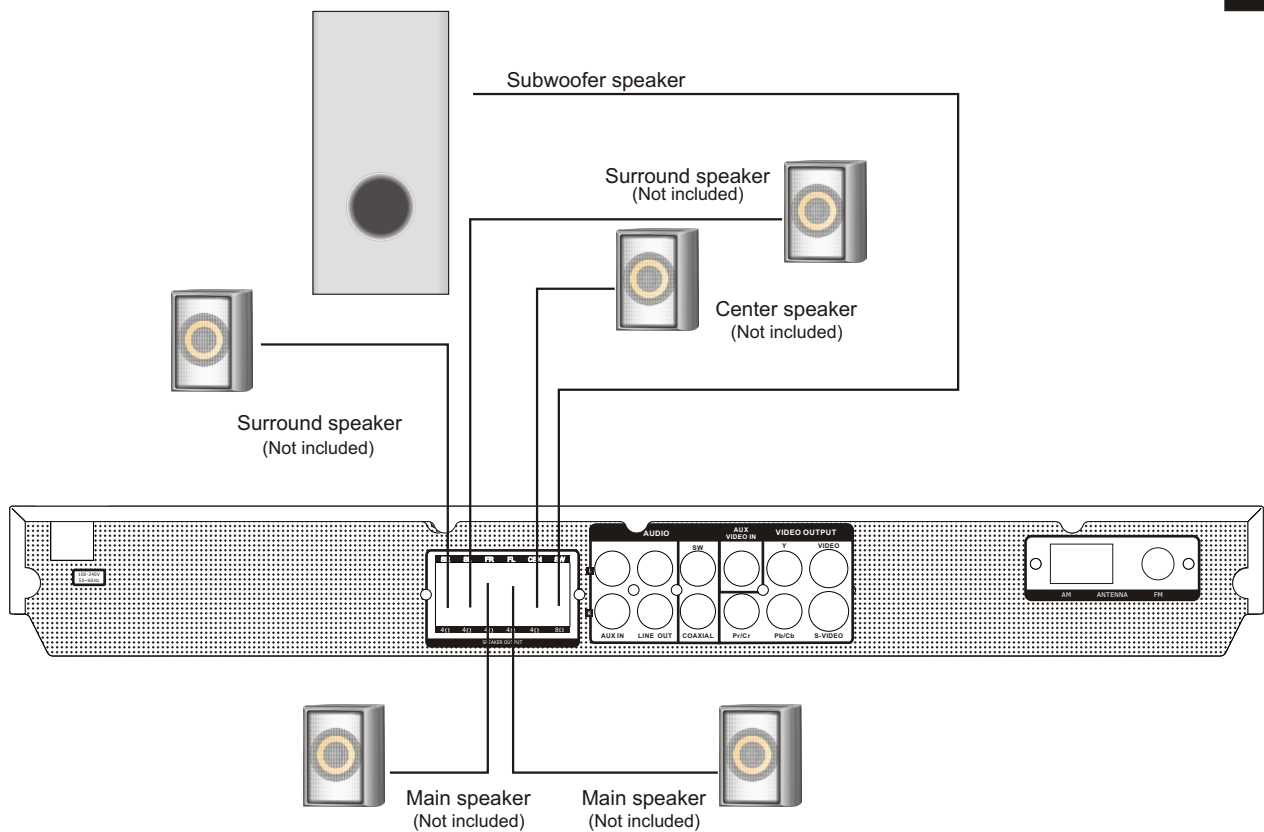
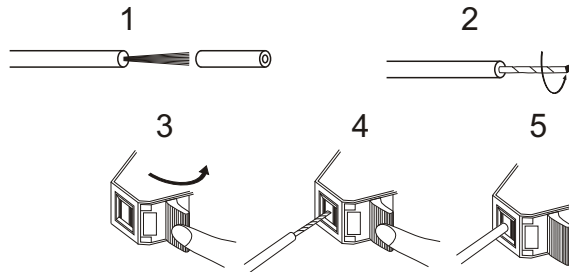
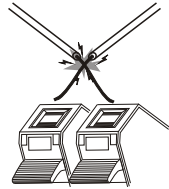
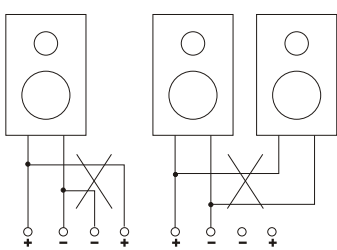

CONNECTING ANTENNA

Radio signals may be difficult to receive in some buildings and under certain conditions. The provided antennas will help in their reception. They are intended for indoor use only.

AM Loop Antenna

The placement of the AM loop antenna should be in a direction that provides the clearest reception. Keep as far as possible from DVD receiver, TV set, and speaker and power cords. If reception remains poor, an outdoor antenna may be necessary.

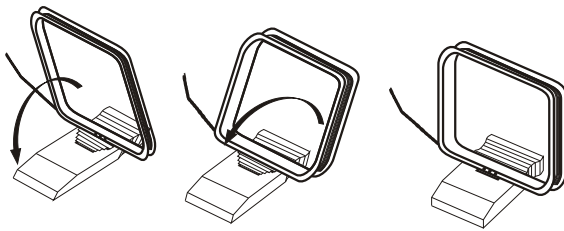

To connect the AM loop antenna:

1. Hold down handle
 2. Insert wire end into hole
 3. Release handle
- Position for best reception

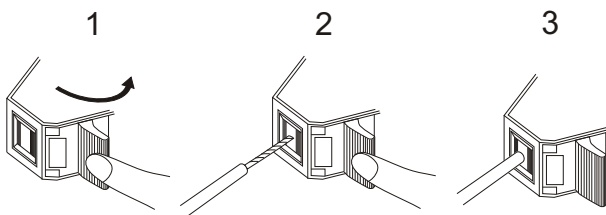

FM Indoor Antenna

The FM antenna should be fully extended and in a direction that provides the clearest signal. Secure the antenna ends in a location where distortion is a minimum. If reception remains poor, an outdoor antenna may be necessary.

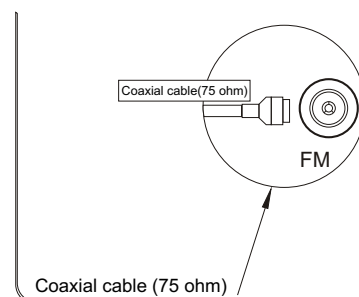
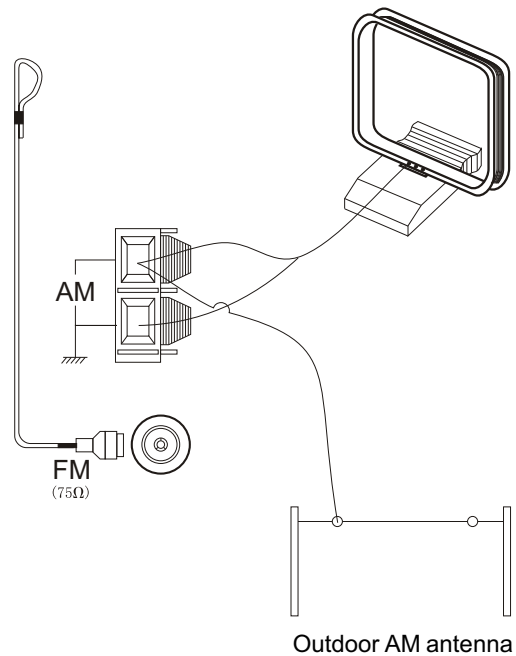

Outdoor FM antenna

CONNECTING POWER SUPPLY

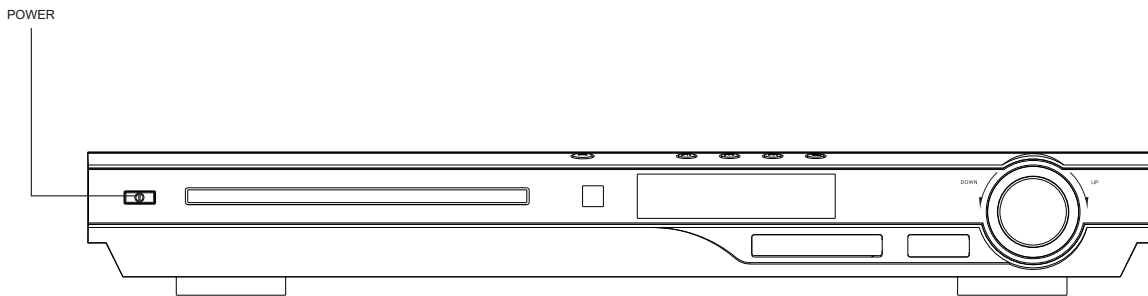

Before plugging the power cord into the AC outlet, check to make sure all of the connections have been properly completed. When they have been, carefully plug power cord into outlet.

Press the POWER button on the front panel to power the unit. The display panel will light.

When the unit is initially powered, a brief surge of electricity may cause interference with other electronic equipment on the same circuit. If this occurs, connect the unit to an outlet on a different circuit.

15

BASIC OPERATION

Selecting Sound Source

1. Press any function button (DVD, TUNER, AUX) to select the desired sound source. The appropriate symbol will appear in the display.
2. When the TUNER button is pressed, the last station listened to will play.

Note: The desired program source will not play unless it and the selected signal button coincide with the active program source signal input.

Volume Control

The volume may be adjusted by either turning the large volume knob on the front panel or using the appropriate volume button on the remote control.

Mute

Pressing the MUTE button temporarily mutes every speaker. To resume audio, press MUTE button again.

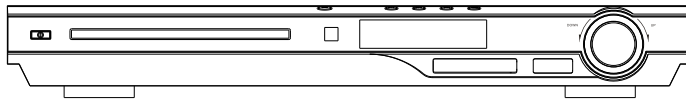

16

Positioning

1. Press TUNER button to select desired wave band (AM or FM).
2. Press CH+ or CH- button to find a station. The frequency will change with each press. When a station's signal is received, it will appear in the display.
3. To lock onto a station quickly, hold the UP or DOWN button for two seconds. The unit will start automatic tuning. When a station is found, automatic tuning stops.
4. To add a station to memory, press the MEMO button. The memory storage number will blink for four seconds in the display. Press MEMO again to store the station.

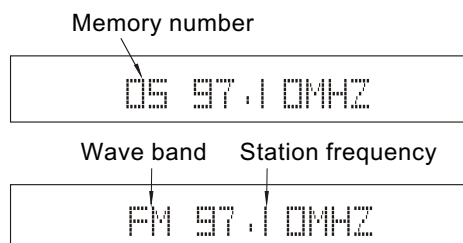

5. To reduce noise when an FM-stereo program has been received, press the MONO button. The word STEREO will disappear from the display. The program is now heard in monographic form, reducing the noise. To resume stereo play, press the MONO button again.

Automatic Tuning

This unit will store up to 40 individual AM or 50 individual FM radio stations in its memory.

1. Press the >> button. The word AUTO will appear in the display and the automatic tuning mode is activated.
2. Stations will be stored in ascending order until 50 stations of that particular wave band have been saved. When a station is stored, the memory storage number, as well as the station's frequency, will flash for four seconds in the display.
3. When the total number of stations reaches 40, in a particular wave's (AM or FM) memory, no further station in that wave band will be saved.

To Play Preset Stations

1. Press the TUNER button to select the desired wave band.
2. Press the PRE/TUN button.
3. Press any of the numbered buttons to select the desired station's memory number. For example, to play the station at memory #5, simply press the 5 button; for memory #17, press the 1 button followed by the 7 button.
4. Stations in the memory function may also be accessed by pressing the UP or DOWN button.

BASIC DVD OPERATION

Once the unit is connected to a television set and any other accessory equipment, you are ready to enjoy the excitement of DVD videos or your favorite CDs and MP3 files.

To play an audio disc:

Turn on the audio system and choose the input source that is connected to the DVD player. Set the SPDIF OUTPUT to SPDIF OFF from the SETUP MENU display if you don't have the proper equipment for Dolby Digital surround sound.

1. Press the POWER key on front panel. DISC LOADING appears on screen.



If there is no disc, NO DISC shown on screen:



2. Press the OPEN/CLOSE key. The disc tray will open.

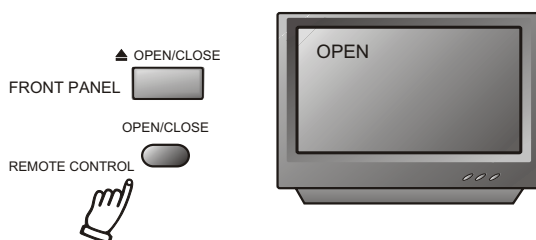

3. Place the disc on the disc tray. Be sure play side is face down on the tray.

4. Press OPEN/CLOSE key to close tray. The disc tray will close. The disc type will appear in the upper-left-hand corner of the screen.

Once it has read the disc, the unit automatically will begin playback. When playing a DVD, the DVD title or menu will appear. CD tracks are played in sequence.

Note:

- It is possible to damage a disc if it is not placed correctly on the guides in the disc tray. This may also cause the DVD player to malfunction. Do not force or place anything other than a 5" DVD or CD onto the disc tray.
- Never move the DVD player during playback, as this may cause damage to the disc as well as the player. To open and close the disc tray, only use the OPEN/CLOSE key found on both the remote control and on the unit's front panel.

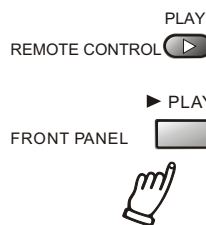

Press PAUSE key:

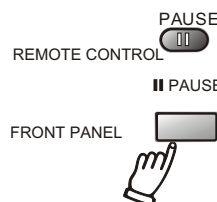

5. PREV/NEXT playback

Press ◀◀key or ▶▶key, play previous or next track. To resume normal playback, press PLAY key.

Press PREV key:

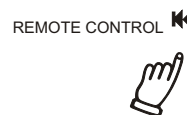

Press NEXT key:



6. Fast Forward/Reverse Playback

The unit features both fast forward and fast reverse playback. Either mode will speed up: 2x, 4x, 8x, 16x.

BASIC DVD OPERATION

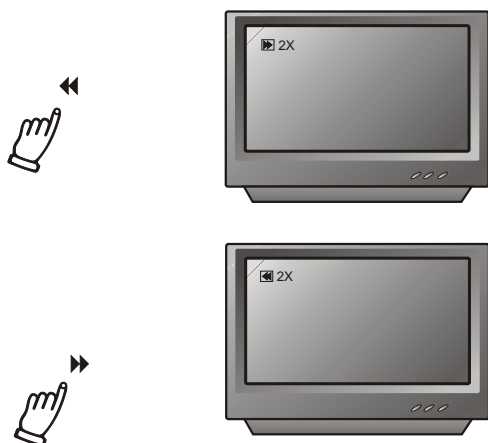

To activate either function, simply press the **▶▶** key or **◀◀** key on the remote control. The speed changes each time the key is pressed. To resume normal playback, press the **▶** key.

Memory Playback

This unit allows the viewer to stop playback, then later continue playback from that exact disc location. Press the **STOP** key to halt playback. The unit then will memorize the location where playback was stopped. To resume watching, press the **PLAY** key and the unit will resume playback from the exact location where playback was stopped. (Exclude Mp3 DISC)

When you play DVD discs, press **MENU** or **TITLE** key return menu and title, the unit then will memorize the location, To resume watching press the **PLAY** key and the unit will resume playback from the exact location.



Slow Motion

This DVD receiver has the ability to play discs in slow motion in either forward or reverse direction. Each time the **SLOW** key is pressed, the speed will slow from forward slow speed 1/2, to 1/4, to 1/8, to 1/16 to reverse slow speed 1/2, to 1/4, to 1/8, to 1/16, to normal speed. To resume normal playback, press the **PLAY** key.

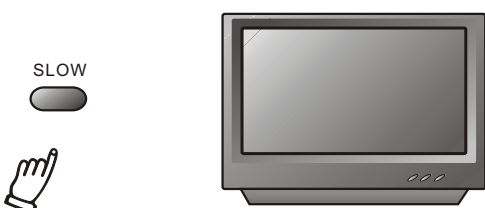

FUNCTIONS

Screen Display

While a disc is playing, the status of various functions may be checked, such as the title, track number, and several time categories.

1. Press the **DISPLAY** key once and the title appears along with the chapter and how much time has played.

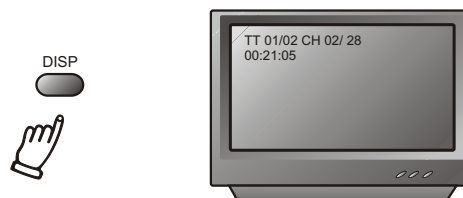

2. Press the **DISPLAY** key again and the remaining time for that particular title appears.



3. Press the **DISPLAY** key again and the total elapsed time for that particular chapter appears.

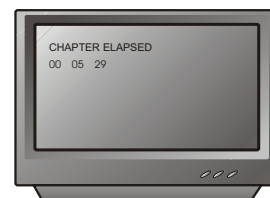

4. Press the **DISPLAY** key again and the total remaining time for that particular chapter appears.

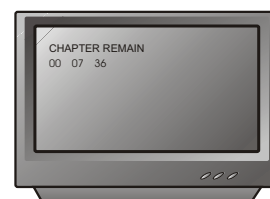

5. Press the **DISPLAY** key again and the display turns off.

FUNCTIONS

N/P

This DVD receiver supports video output of various systems, including auto, NTSC, and PAL. The picture will blink and become colourless when the wrong system is selected. (NTSC for North America, PAL for Europe). For more information on output format, refer to the TV set's manufacturer's instructions.

Subtitles

The unit has the capability to display subtitles in any of 32 different languages.

1. Press the SUBTITLE key. The subtitle menu will appear. Select the desired language by pressing the SUBTITLE key.

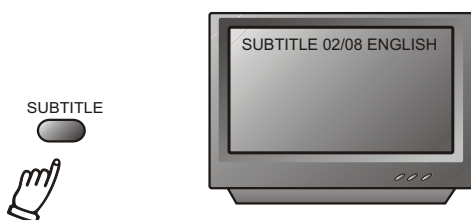

2. To remove the subtitles from view, press the SUBTITLE key until they disappear.

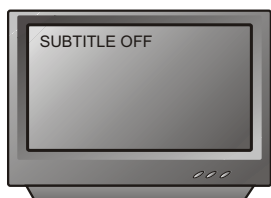

Note: The disc being played must be multi-subtitle encoded.

Camera Angle

The ability to change the camera angle allows viewer to play director and watch a movie from different perspectives.

1. Press the ANGLE key on the remote control. With each press, the camera angle changes.

2. The key may be pressed only when the flashing angle icon appears in the unit's display panel.

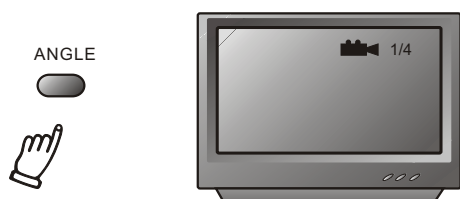

Note: Camera angle may be changed only in discs with multi-angle capability encoded into them.

Language

The unit has the capability to show movies in one of eight languages.

1. Press the AUDIO key. The language menu will appear. Select the desired language by pressing the AUDIO key.

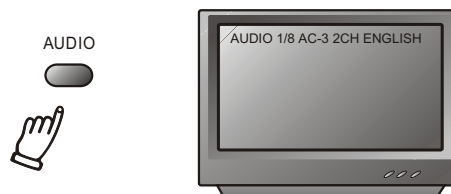

Note: The disc being played must be multi-language encoded.

LOCATING A TITLE

DVD discs are normally divided into titles, which are then sub-divided into chapters. A specific title can be easily found with this unit. Specific titles can be found using either the title menu function, if the DVD disc contains a title menu, or through its unique title number.

Title Menu Function

1. Press the TITLE key. The title menu will appear on the TV screen.

2. Press the appropriate scroll key to select the desired title. A title may also be located by pressing its assigned number with the number buttons.

3. Press the ENTER key. This will start playback from chapter 1 of the selected title.

Note:

Some discs do not respond to this function. If different instructions appear on the TV screen, follow those instructions. The Instructions given here describe the basic procedure. Procedures may vary depending on the content of the DVD disc. When playing a VCD2.0 disc, TITLE key can be used to return to menu.

FUNCTIONS

Time

This DVD receiver can display various data regarding the disc being played. Press the DISP button for the following.

1. Press once, the number of titles and chapters in each title appears

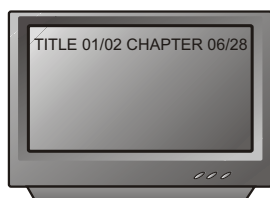

2. Press again, the time of a selected title appears.

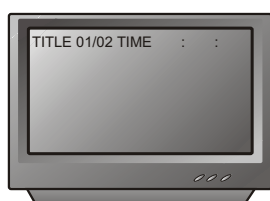

The repeat mode changes each time the REPEAT key is pressed (i.e., from title repeat to chapter repeat, all repeat, to repeat off.)



MENU: MENU/PBC

With the PBC function on, choosing a song on a CD can only be done when at the main menu. With the PBC function off, song selections can be made by entering the relevant number keys. The menu content of the disc will appear when the MENU button is pressed while a DVD disc is playing.



AMP Volume up/down Adjustment

Press the CH.SEL button on the remote control, TV OSD appears:

VOL_L +00db

Press CH.SEL twice, OSD Appears:

VOL_R +00db

Press CH.SEL thrice to seven times the OSD converts in turn of RF, LS, RS, CN and SW;

VOL_RS +00db

VOL_LS +00db

VOL_C +00db

Press CH.SEL continually it goes in cycle. Press the VOL+ or VOL- button on the remote control to change the Volume value of ALL, LF, RF, LS, RS, CN separately.

Repeat Play

This DVD receiver allows repeated playback of specific titles, chapters/tracks, or segment. It even allows switching between two items that are being repeated.

1. Select the item to repeat.
2. Press the REPEAT key.

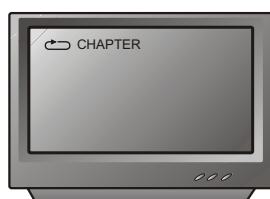

FUNCTIONS

Zoom

A picture may be enlarged up to four times during either playback or slow motion through the unit's zoom function. Press the ZOOM key once and it enlarges the image 2x, press a second time and the image enlarges 3x. A third press enlarges the image 4x. A fourth press the image 1/2x, a fifth press the image 1/3x, a sixth press the image 1/4x. To return to normal-size playback, press the ZOOM key a seventh time. Enlargement takes place in the center of the picture.

Volume and Mute

The volume on this DVD receiver is easily controlled with the remote control by pressing either the VOL + key to raise the volume or the VOL- key to lower it. By pressing the MUTE key, no audio will be heard. To reinstate the audio, press the MUTE key again.

Program

Allows you to program specific tracks in a desired order of play. Press PROG key program menu will appear on the screen, set up the program play in number key. The scroll to the START, Press ENTER key to program play. To exit the Programmed play mode, press the PROG button again.

SYSTEM SETUP

1. General Steps in the setup menu

A) Press the setup button, the main setup menu appears.

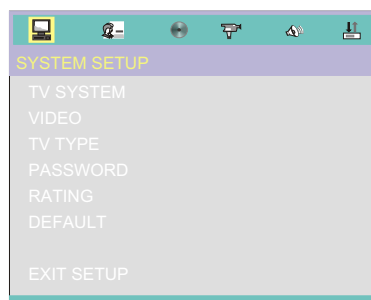

B) Press the Left and Right arrow buttons to highlight the icon of the desired page, then press the Down or Right arrow button to activate that page; For example, if you want to setup the video page, press Right to highlight the video icon, the video page will be displayed on the screen.

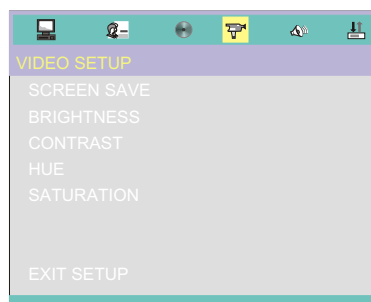

C) Press the Down arrow button to highlight the desired option. Press Enter or press Right to select. The choices of that option appear on the right; For example, press the Down arrow button to highlight the BRIGHTNESS option, the press Enter to select, the brightness choices appear on the right.



A) Press the Arrow buttons to highlight the Exit Setup option, then press Enter or Setup again to exit Setup Menu.

1 SYSTEM SETUP

1.1 SYSTEM SETUP

The system setup options are illustrated below:

1.1.1 TV SYSTEM

According to the Color System of the TV, you can choose the TV System.

Note:

NTSC is primarily used in the United States

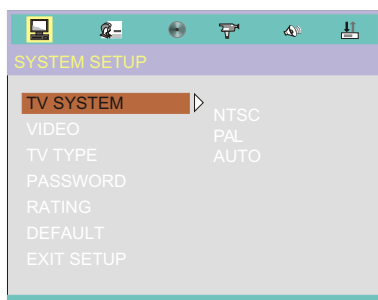

1.1.2 VIDEO

According to the output jack of TV set, you can choose P-SCAN YPbPr, INTERLACE-YUV, TV-RGB and S-VIDEO.

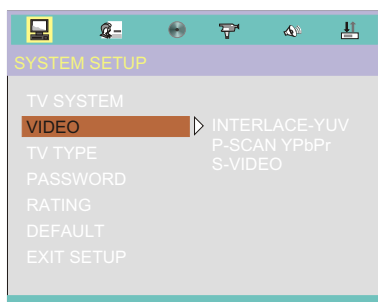

1.1.3 TV TYPE

According to the TV type, you can choose 16:9, 4:3LB or 4:3PS.

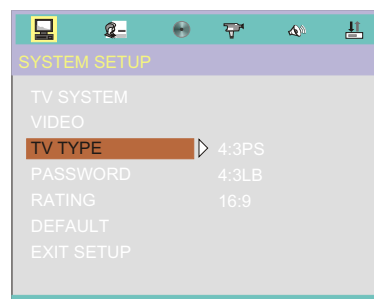

1.1.4 PASSWORD

The password option is initialized locked, and you can not set the ratings limit or change the password. In order for the Ratings feature to work, the password mode must be turned on. If you want to set the ratings limit, you will need to enter the default password. Which is 6666, then press Enter to confirm. To change the password, you will be prompted for the old password, then be prompted for anew. Enter a 4-digit number (this is your 6666 password). Press remember your PASSWORD, as the DEFAULT setting will revert everything. But the PASSWORD to the factory defaults.

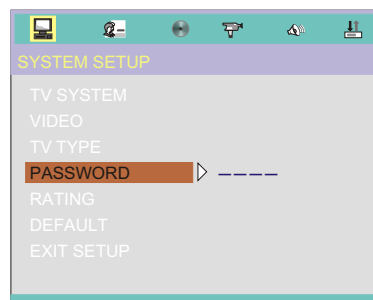

1.1.5 RATING

The Rating feature is a rating limit system, like movie ratings. It works with DVD discs that have been assigned a rating. This helps you control the types for DVDs that your family watches.

SYSTEM SETUP

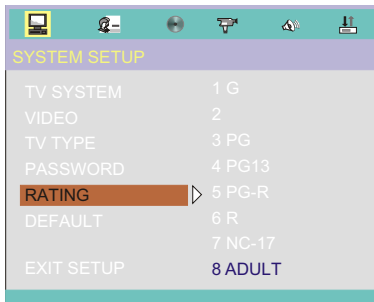

1.1.6 DEFAULT

The DEFAULT setup options are RESTORE factory setup. Let your player work on best state.

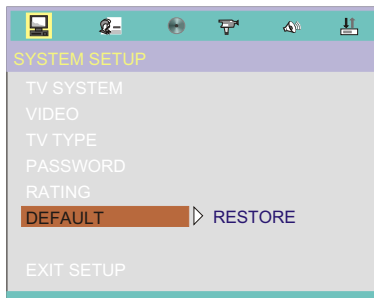

When your unit does not work properly, it may probably result from some wrong settings. Please try the Restore Factory Setting function to see if the unit can restore to its normal working status.

1.2 LANGUAGE SETUP

The language setup options are illustrated below:

1.2.1 OSD LANGUAGE

Highlight the OSD LANGUAGE option, and press the Arrow buttons to choose the OSD language you prefer. Press Enter to confirm, and it will display OSD in that language.



1.2.2 AUDIO LANGUAGE

Highlight the AUDIO LANG option, and press the Arrow buttons to choose the audio language you prefer. Press Enter to confirm. If the disc you are playing has that language available, it will output that language.



1.2.3 SUBTITLE LANGUAGE

Highlight the SUBTITLE LANG option, and press the Arrow buttons to choose the subtitle language you prefer. Press Enter to confirm. If the disc you are playing has that language available, it will display subtitles in that language.



1.2.4 MENU LANGUAGE

Highlight the MENU LANG option, and press the Arrow buttons to choose the menu language you prefer. Press Enter to confirm. If the disc you are playing has that language available, it will display the menu in the language.

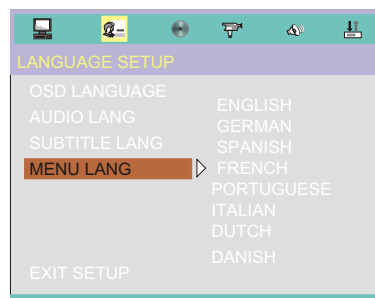

Notes:

If your preferred language is not available, the disc's default language will be played.

1.3 AUDIO SETUP

The audio setup options are illustrated below:

1.3.1 AUDIO OUT

Highlight the AUDIO OUT option, and press the Arrow buttons to choose the audio output mode you prefer. Press ENTER to confirm; There are 3 optional audio output modes: SPDIF/OFF, SPDIF / RAW, and SPDIF/ PCM.

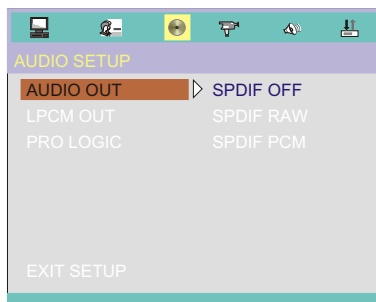

1.3.2 LPCM OUTPUT

Use the Up and Down arrow button to move the scroll and adjust the sampling rate of the digital output.

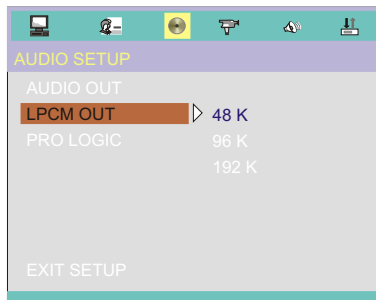

1.3.3 PROLOGIC

There are 3 optional PROLOGIC: MOVIE MODE, MUSIC MODE, OFF.

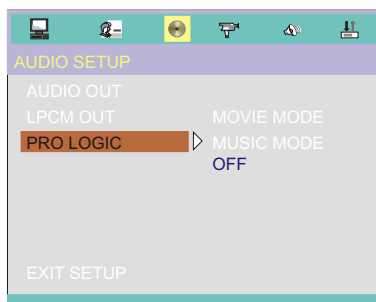

1.4 VIDEO SETUP

The video setup options are illustrated below:

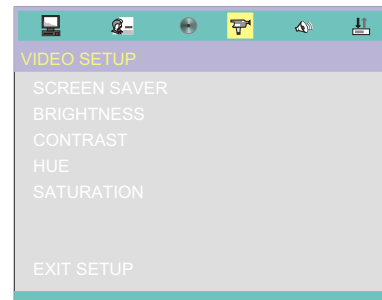

1.4.1 BRIGHTNESS

Use the Up and Down arrow buttons to move the scroll and adjust the brightness

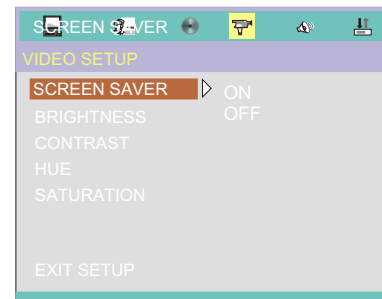

1.4.2 SCREEN SAVER

If the screen saver is on, when your DVD player is in Stop, Open, or No Disc state, or there is a frame frozen for more than 60sec, the screen saver will be displayed. This feature can protect the screen from damage.

- ON: Choose this setting to activate the screen saver.
- OFF: Choose this setting to cancel the screen saver

The default setting is ON.

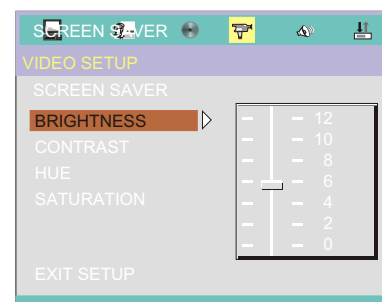

1.4.3 CONTRAST

Use the Up and Down arrow buttons to move the scroll and adjust the contrast.

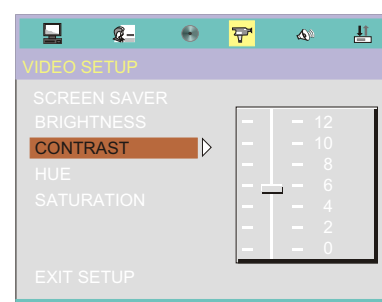

SYSTEM SETUP

1.4.4 HUE

Use the Up and Down arrow buttons to move the scroll and adjust the hue.

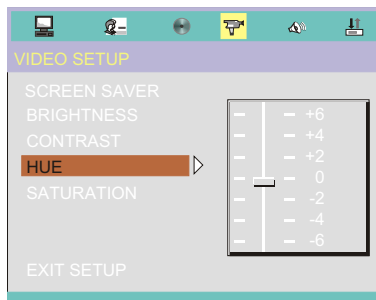

1.4.5 SATURATION

Use the Up and Down arrow buttons to move the scroll and adjust the saturation.

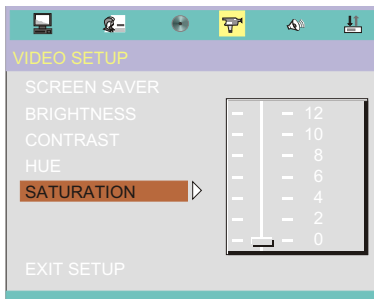

1.5 SPEAKER SETUP

The speaker setup options are illustrated below:

1.5.1 DOWNMIX

- A) LT / RT Choose this setting when you are connected to a 2 Channel Analog Audio Input.
- B) STEREO Choose this setting when the DVD player is connected only to a TVset.
- D) 5.1CH Choose this setting when the DVD player is connected to a 5.1 speaker set.



1.5.2 CENTER DELAY

You can adjust the center by using the Up and Down buttons to move the scroll the scroll bar.

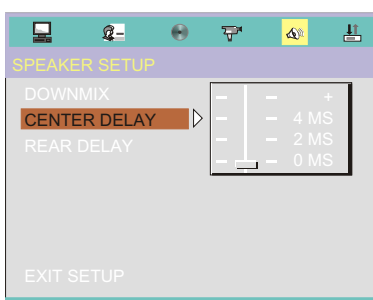

1.5.3 REAR DELAY

You can adjust the Center and the Rear delay by using the Up and Down buttons to move the scroll bar.

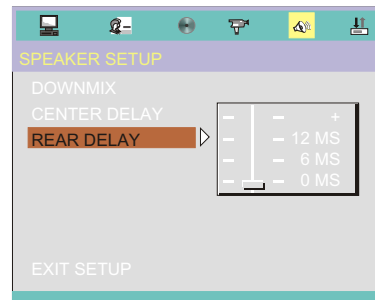

1.6 DIGITAL SETUP

The DIGITAL SETUP options are illustrated below:

1.6.1 DYNAMIC RANGE:

To avoid disturbing the neighbours at night, you can use this function to reduce the sound effects volume without changing the original tone.

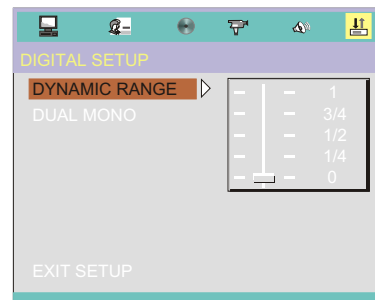

1.6.2 DUAL MONO (LEFT + RIGHT)

Choose to setup the L and R mono output mode. There are four modes in this option: STEREO, MONO L, MONO R, and MIX MONO.

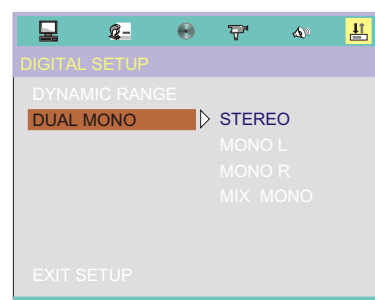

REFERENCE:

1. To protect your DVD player, the interval between turning the unit on and off, via the Main Power button, should be more than 30 seconds.
2. If the unit will not be used for an extended period of time, please disconnect the power plug from the outlet.
3. The player should only be operated with the correct power supply that corresponds to the marking label. The incorrect power supply could damage the unit.
4. The player may not be compatible with some encrypted discs.
5. If the player stops during playback, eject the disc and power off the unit. Wait 10 minutes and power the unit back on.

Mp3 & MPEG FUNCTION

When a MPEG and a Mp3 disc is loaded, the screen will display as follows:

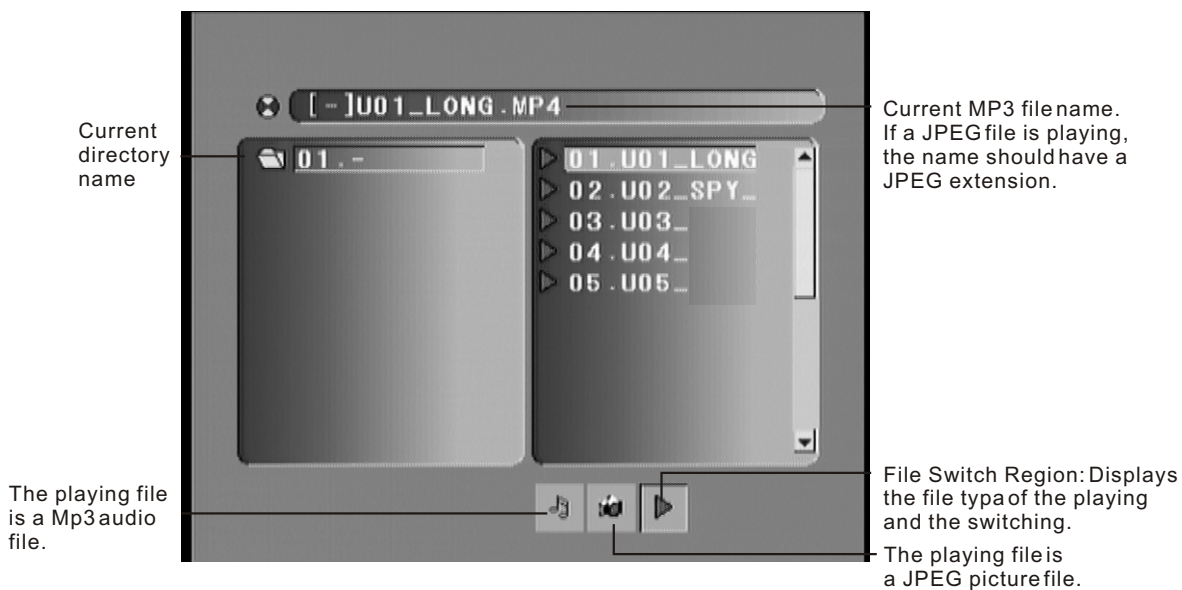
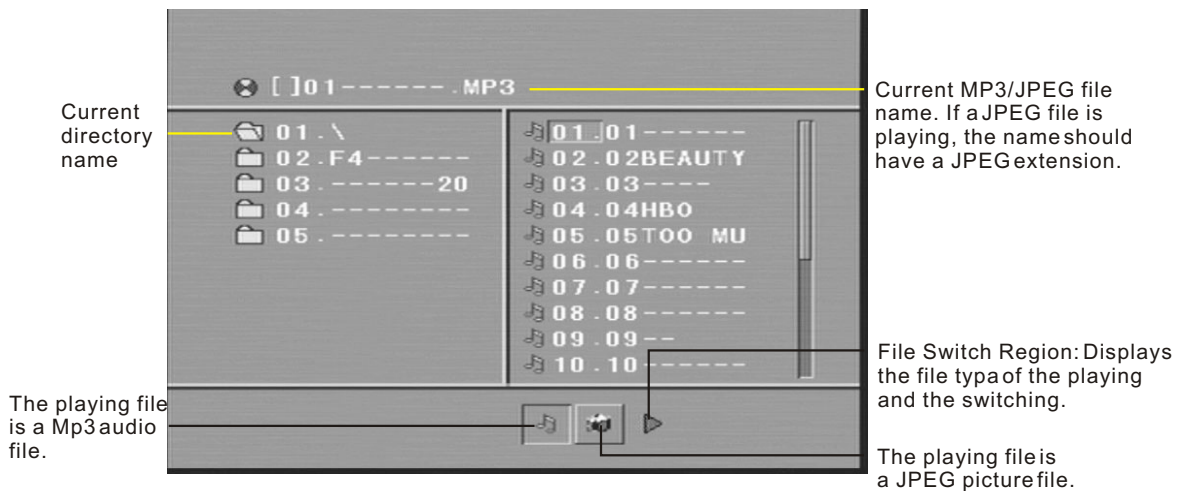

Press \uparrow / \downarrow to select the file when the cursor appears in the file window. Press select to play the current file select by the cursor.

Press \leftarrow / \rightarrow to switch between the directory window and the file window.

Note:

During Mp3 playback, Forward Scan and Reverse Scan are not available.

Note:

The player will not identify or play a MP3 disc under the following conditions: the recording format is not supported (make sure the files are in MP3 format), the disc is badly scratched, damaged or dirty, the disc is not finalized.

JPEG files contain picture information which can be encoded by micro computer software and transmitted to the TV screen via a video output interface. This function is useful in many contexts. For example teachers can change pictures to be shown in the classroom to JPG files by means of a digital camera or a scanner which are often used within the IT world and transfer the pictures to CD-R discs. This will make things easier for the pupils when the teachers play the discs via a TV set or other types of equipment in the classroom. It reduces the repetitive work for the teachers, and the discs are easy to store (information on discs can be stored for more than 100 years). By means of a digital camera or scanner, families can transfer pictures to CD-R discs. If, for example, a picture requires 100K bytes, one disc will hold about 6000 pictures. Manufacturers can show their customers pictures of their products one by one.

Note: The actual contents vary from one type of disc to the other.

1. When a JPEG disc is loaded in the DVD-player, an automatic slide show will be launched. Each picture will be displayed and scaled to fit the screen. Press STOP to enter the file library. Use the SCROLL key to navigate the pictures, and press PLAY to display a picture. When the a picture has been chosen, the slide show will resume with the next picture in the library.
2. Press SCROLL to rotate the picture. These operations are allowed only when a picture is being displayed normally and will be cancelled automatically when a new picture is displayed.
3. Press ZOOM to execute the zoom function and select the zoom enlarging scale with |<< and >>|. In zoom mode, press the SCROLL buttons to move the picture on the screen. With zoom mode off, the next picture will be scaled to fit the screen. Press PLAY to cancel the zoom mode and resume the slide show.

JPEG limitations

- JPEG files containing CMYK colors is not supported by this DVD-player.
- The range of pixels should not be exceeding 3840 X 3840 pixels, in order to achieve the best Performance.

This troubleshooting guide may help you find a possible cause of and solution to a problem. If there are still problems, please contact the local service centre or distributor.

PROBLEMS AND POSSIBLE SOLUTIONS

Common symptom	Possible cause	Remedy
No function	Mains power is not connected Power is OFF	Connect to mains power outlet Turn the power ON.
No playback	No disc is inserted ("no disc" will be shown on screen). Disc is upside down. ("no disc" will be shown on screen). Dirty disc Deformed/scratched disc Condensation in unit	Insert a disc. Reload disc. The label side should face upward. Clean disc surface. Replace disc. Turn power on for 1-2 hours before using the unit.
No sound Sound in one or more Speaker(s) is missing	Wrong audio output setting Poor or missing cable connection	Check audio output setting Check connections
No sound in centre/ surround speakers	Downmix settings are wrong Disc or TV program is recorded in stereo	Change downmix settings Set prologic II on.
Sound on scart connector is very weak or missing	Sound in scart connector is Volume regulated.	Turn the volume up to max.. (Can only be used without speakers connected)
No picture	Disconnection of video equipment Wrong output setting of video output	Check video connections Check video output setting of Video output in general setup

SPECIFICATIONS

DVD Player

TV System	NTSC/PAL
Compatible Discs	DVD, CD, Mp3, JPEG, CD-R, CD-RW
Resolution Ratio	Greater Than 500 lines
Video S/N Ratio	65dB
Frequency Response	fs (96KHz/24bit) 4Hz - 44KHz: +/- 2dB
Audio S/N Ratio	95dB
Degree of Distortion	<0.01%
D/A Converter	192KHz/24bit
Video Out	1Vp-p
S-Video Out	Y: 1Vp-p(75 Ω) C: 0.3Vp-p(75 Ω);
Audio Out	2.0V, 5.1 Channel,
Digital Audio Output Connections	Coaxial S-Video, 5.1 Channel Output

FM Tuner

Tuning Range	87.5-108MHz
S/N Ratio	>46dB
Monophonic	>46dB
Stereo	>50dB (DIN)
Selectance	50dB
THD	
Monophonic	2%
Stereo	3%
Frequency Response	30Hz-10kHz +/- 1dB
Stereo Resolution	35dB (1kHz) 30dB (100Hz-10kHz)

AM Tuner

Tuning Range	531-1710KHz
S/N Ratio	35dB
THD	3%

Remote Control

Transmitter	Infrared Ray
Signal Range	Approximately 5m
Power Source	2 "AAA" Batteries

General

Power Supply	AC 100-240~50/60Hz
Consumed Power	130W

Because its products are subject to continuous improvement, We reserves the right to modify product design and/or specifications without notice and without incurring any obligations.



Free Manuals Download Website

<http://myh66.com>

<http://usermanuals.us>

<http://www.somanuals.com>

<http://www.4manuals.cc>

<http://www.manual-lib.com>

<http://www.404manual.com>

<http://www.luxmanual.com>

<http://aubethermostatmanual.com>

Golf course search by state

<http://golfingnear.com>

Email search by domain

<http://emailbydomain.com>

Auto manuals search

<http://auto.somanuals.com>

TV manuals search

<http://tv.somanuals.com>