

Cuisinart®

STEP-BY-STEP GETTING STARTED

Your Cuisinart® DLC-10S or DLC-10C will look like this after you follow the easy step-by-step assembly instructions inside.

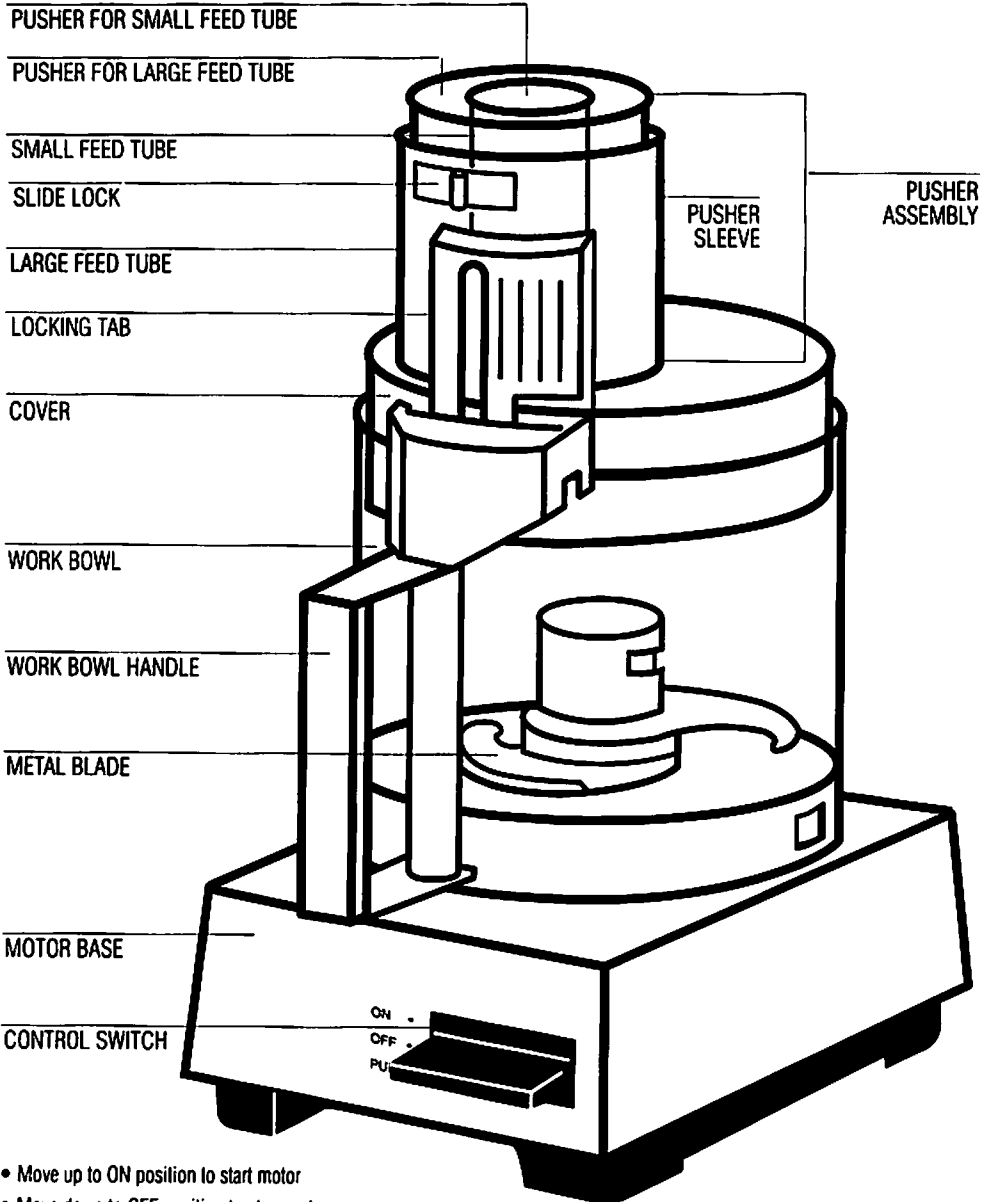

- Move up to ON position to start motor
- Move down to OFF position to stop motor
- Press down to PULSE position and release for pulse/chopping

CHOPPING AND PUREEING WITH THE METAL BLADE

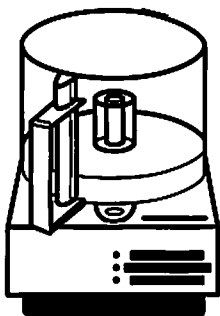

1
Put base on counter, with nameplate facing you.

Pick up work bowl, with handle facing you, and place it on base with handle at about 7 o'clock.

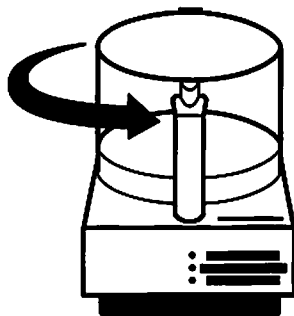

2
Turn work bowl counterclockwise until it clicks.

SLICING AND SHREDDING WITH THE SLICING AND SHREDDING DISCS

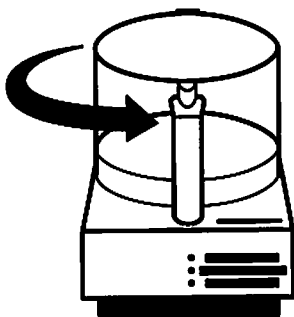

1
Lock bowl in place. (See 1 and 2 above.)

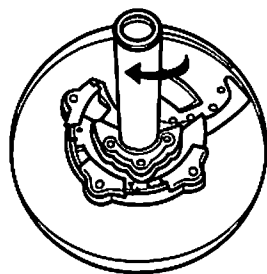

2
Place disc, cutting side down, on flat, stable surface and hold it down firmly with one hand. With other hand, line up two symbols (○ and △) on stem with similar symbols on disc. Turn stem clockwise until it clicks into position.

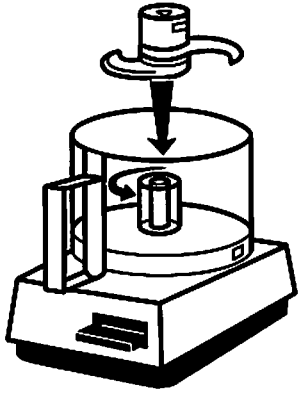

3 Place metal blade over shaft, matching outline  on top of hub to shape of shaft. Lower blade will almost touch bottom of bowl.

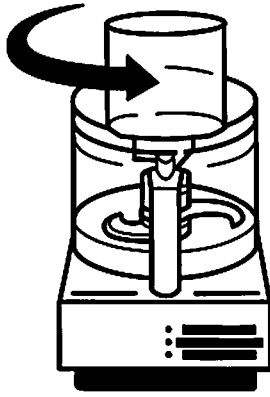

4 Put cover on work bowl, with feed tube at about 7 o'clock. Turn cover counterclockwise until it fits into position.

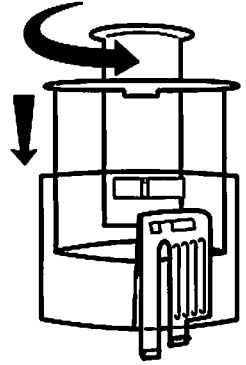

5 The pusher assembly slides over the large feed tube. It has a large pusher and a small pusher. Push the small white pusher all the way down and twist it to lock. Push the large pusher all the way down and push white Slide Lock right to lock.

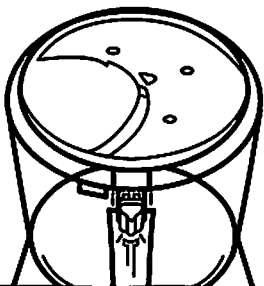

3 Place disc over shaft, matching outline  on its top to shape of shaft. Without touching blade edge, push disc down as far as it will go.

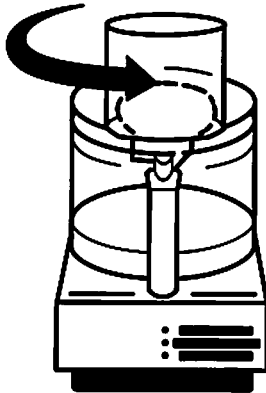

4 Put cover on bowl, feed tube at 7 o'clock, and turn until it clicks. Insert food in feed tube.

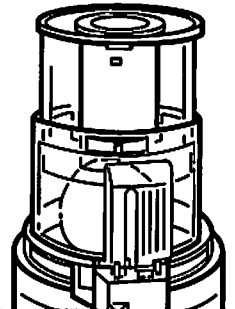

5 Twist small pusher to lock it and push Slide Lock to left to unlock pusher sleeve. Slide large pusher sleeve over feed tube and push all the way down until tabs click into place.

Cuisinart®

Cuisinart® is a registered trademark of Cuisinart
150 Millford Road
East Windsor, NJ 08520
1-800-726-0190
Printed in China

U PG-3200

CUI 9228.94

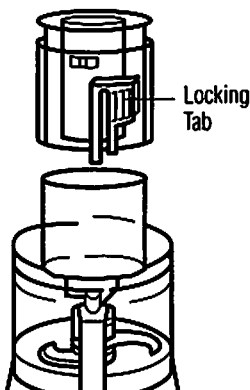

6
Hold pusher with white Slide Lock toward you. Slide pusher over feed tube on cover and push locking tab down until locking tab clicks.

CAUTION: Machine must be unplugged when you practice locking and unlocking pusher. Repeated locking and unlocking with machine plugged in is never necessary in normal use and will make machine inoperable.

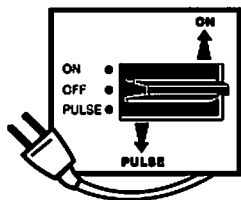

7
Plug in machine. Move control switch up to ON position to start motor. Move control switch down to OFF position to stop motor. Move control switch down to PULSE position and release it for pulse/chopping. If machine doesn't start, make sure it is plugged in and work bowl, cover and pusher assembly are locked in position.

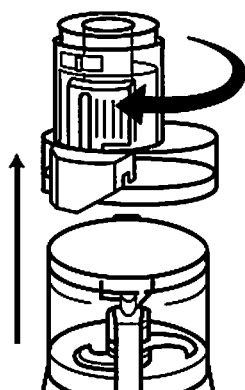

8
To remove cover, hold pusher assembly with thumb away from two locking tabs. Turn and lift. The work bowl won't come off until the cover is unlocked.

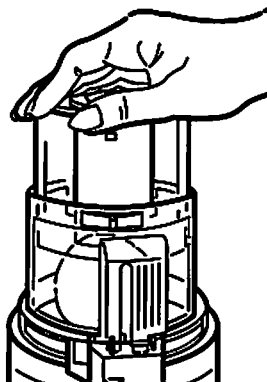

6
Apply even pressure to large pusher while holding lever down at PULSE position, and push food through.

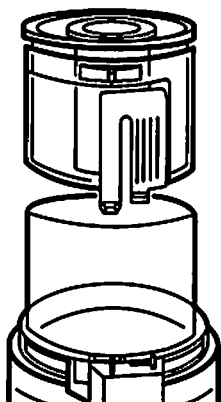

7
To remove pusher assembly, hold it with thumb on large tab. Press firmly on tab and tilt straight up. Cover will stay in place, allowing you to reload feed tube.

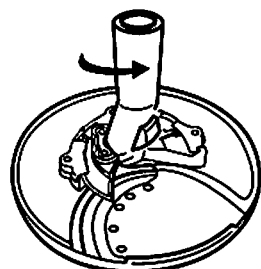

8
To remove disc from stem, slide button up as far as it will go and turn stem counterclockwise.

IMPORTANT SAFEGUARDS

Always follow these safety precautions when using this appliance.

Getting Ready

1. Read all instructions.
2. Blades are sharp. Handle them carefully.
3. Unplug from outlet when not in use, before putting on or taking off parts, and before cleaning. To unplug, grasp plug and pull from electrical outlet. Never pull cord.
4. Do not use outdoors.
5. Do not let cord hang over edge of table or counter, or touch hot surfaces.
6. Do not operate any appliance with damaged cord or plug, or after appliance has been dropped or damaged in any way.

Operation

1. Do not use pusher assembly if sleeve becomes detached from pusher.
2. Keep hands as well as spatulas and other utensils away from moving blades or discs while processing food, to prevent possibility of severe personal injury or damage to food processor. A plastic scraper may be used but must be used only when food processor motor is stopped.
3. Avoid contact with moving parts. Never push food down by hand when slicing or shredding. Always use pusher.

4. Make sure motor has been completely stopped before removing cover. (If machine does not stop within 2 seconds when you turn cover, call 1-800-726-0190 for assistance. Do not use machine.)

5. Never store any blade or disc on motor shaft. No blade or disc should be placed on the shaft except when the bowl is properly locked in place and the processor is in use. Store blades and discs, as you would sharp knives, out of reach of children.
6. Be sure cover is securely locked in place before operating food processor.
7. Do not try to override cover interlock mechanism.

Cleaning

To protect against risk of electrical shock, do not put base in water or other liquid.

General

1. Close supervision is necessary when any appliance is used by or near children.
2. Do not operate this, or any other motor-driven appliance, while under the influence of alcohol or other substances that affect your reaction time or perception.
3. This food processor is UL listed for household use. Use it only for food preparation as described in the accompanying recipe and technique book.
4. The use of attachments not recommended or sold by Cuisinart may cause fire, electrical shock, personal injury or damage to your food processor.

5. To avoid possible malfunction of work-bowl switch, never store processor with pusher assembly in locked position.

6. Maximum rating of 5.1 amperes is based on attachment that draws greatest current. Other recommended attachments may draw significantly less current.

SAVE THESE INSTRUCTIONS

NOTICE

This appliance has a polarized plug (one blade is wider than the other). As a safety feature, this plug will fit in a polarized outlet only one way. If the plug does not fit fully in the outlet, reverse the plug. If it still does not fit, contact a qualified electrician. Do not attempt to defeat this safety feature.

Cuisinart®



PRO CLASSIC™ Food Processor 7-cup Bowl

Use and Care and Recipe Booklet

IMPORTANT SAFEGUARDS

Always follow these safety precautions when using this appliance.

Getting Ready

1. Read all instructions.
2. Blades are sharp. Handle them carefully.
3. Unplug from outlet when not in use, before putting on or taking off parts and before cleaning. To unplug, grasp plug and pull from electrical outlet. Never pull cord.
4. Do not use outdoors.
5. Do not let cord hang over edge of table or counter, or touch hot surfaces.
6. Do not operate any appliance with damaged cord or plug, or after appliance has been dropped or damaged in any way. Return appliance to the nearest authorized service facility for examination, repair or electrical or mechanical adjustment.

Operation

1. Do not use pusher assembly if sleeve becomes detached from pusher.
2. Keep hands as well as spatulas and other utensils away from moving blades or discs while processing food, to prevent possibility of severe personal injury or damage to food processor. A plastic scraper may be used but must be used only when food processor motor is stopped.
3. Avoid contact with moving parts. Never push food down by hand when slicing or shredding. Always use pusher.

4. Make sure motor has completely stopped before removing cover. (machine does not stop within 4 seconds when you turn cover, call 1-800-762-0190 for assistance. Do not use machine).

5. Never store any blade or disc on motor shaft. To reduce the risk of injury, no blade or disc should be placed on the shaft except when the bowl is properly locked in place and the processor is in use. Store blades and discs, as you would sharp knives, out of reach of children.

6. Be sure cover is securely locked in place before operating food processor.
7. Do not try to override cover interlock mechanism.

Cleaning

To protect against risk of electrical shock, do not put base in water or other liquid.

General

1. Close supervision is necessary when any appliance is used by or near children.
2. Do not operate this, or any other motor-driven appliance, while under the influence of alcohol or other substances that affect your reaction time or perception.
3. The food processor is UL listed for household use. Use it only for food preparation as described in the accompanying recipe and technique book.
4. The use of attachments not recommended or sold by Cuisinart, may cause fire, electrical shock, personal injury or damage to your food processor.

5. To avoid possible malfunction of work-bowl switch, never store processor with pusher assembly in locked position.

6. Maximum rating of 5 amperes is based on attachment that draws greatest current. Other recommended attachments may draw significantly less current.

SAVE THESE INSTRUCTIONS

NOTICE

This appliance has a polarized plug (one blade is wider than the other). As a safety feature, this plug will fit in a polarized outlet only one way. If the plug does not fit fully in the outlet, reverse the plug. If it still does not fit, contact a qualified electrician. Do not attempt to defeat this safety feature.

Compact Cover

1. Do not use the Compact Cover when mixing hot, thin liquids such as soups or sauces. If you do, it is possible that hot liquid may splash and injure you.
2. DO NOT use any slicing, shredding, julienne, French fry-cut or fine grater discs with the Compact Cover. Doing so may expose the user to injury.
3. Although the Cuisinart Compact Cover may seem compatible with machines from other manufacturers, using the cover with other machines may be dangerous and may expose the user to injury. We specifically caution you not to use the Compact Cover with other brand machines.

FOR HOUSEHOLD USE ONLY

CONTENTS

IMPORTANT SAFEGUARDS		KNEADING BREAD DOUGH	13
		KNEADING SWEET DOUGH	13
THE PARTS	2	RISING	13
		SHAPING, FINISHING AND BAKING	13
PRACTICING WITH FOOD	4	MAKING CONSECUTIVE BATCHES	13
		PROBLEMS & SOLUTIONS FOR MAKING DOUGH	14
REMOVING PROCESSED FOOD	5	PREPARING FOOD FOR SLICING AND SHREDDING	16
CHOPPING, PURÉEING & MOONG WITH METAL BLADE	6	ROUND FRUITS AND VEGETABLES	16
TO CHOP RAW FRUITS AND VEGETABLES	6	WHOLE PEPPERS	16
TO PURÉE FRUIT AND COOKED VEGETABLES	6	LARGE FRUITS LIKE PINEAPPLE	16
TO CHOP HARD FOOD LIKE GARLIC	7	CABBAGE AND ICEBERG LETTUCE	16
TO CHOP PARSLEY, OTHER FRESH HERBS	7	IF THE FOOD DOESN'T FIT	17
TO CHOP PEEL FROM CITRUS FRUIT	7	PACKING FEED TUBE FOR DESIRED RESULTS	17
TO CHOP STICKY FRUIT LIKE DATES	7	PRACTICING SLICING AND SHREDDING	18
TO CHOP MEAT, POULTRY AND FISH	8		
TO PURÉE MEAT, POULTRY AND FISH	8	REMOVING SLICED OR SHREDDED FOODS	19
TO CHOP NUTS	9		
TO MAKE PEANUT BUTTER	9	SLICING AND SHREDDING TECHNIQUES	20
TO MAKE FLAVORED BUTTERS, SPREADS AND DIPS	9	SMALL, ROUND FRUITS AND VEGETABLES	20
TO MAKE MAYONNAISE	10	LONG FRUITS AND VEGETABLES	20
TO BEAT EGG WHITES	10	SMALL AMOUNTS OF FOOD	20
TO WHIP CREAM	10	FRENCH-CUT GREEN BEANS	21
TO MAKE CRUMBS AND CRUMB CRUSTS	11	MATCHSTICKS OR JULIENNE STRIPS	21
TO MAKE PASTRY	11	SLICING COOKED MEAT AND POULTRY	22
TO MAKE QUICK BREADS AND CAKES	11	SLICING FRANKFURTERS AND OTHER SAUSAGES	22
		SLICING AND SHREDDING CHEESE	23
KNEADING YEAST DOUGH WITH DOUGH BLADE	12	IF YOU HAVE A PROBLEM	24
TYPICAL BREAD DOUGH	12		
TYPICAL SWEET DOUGH	12	CLEANING AND STORING	24
MACHINE CAPACITY	12		
USING THE RIGHT BLADE	12	FOR YOUR SAFETY	25
MEASURING THE FLOUR	12		
PROOFING THE YEAST	12	SOME TECHNICAL DATA	25
PROCESSING DRY INGREDIENTS	12		
ADDING LIQUIDS	13	RECIPES	26
		WARRANTY	49

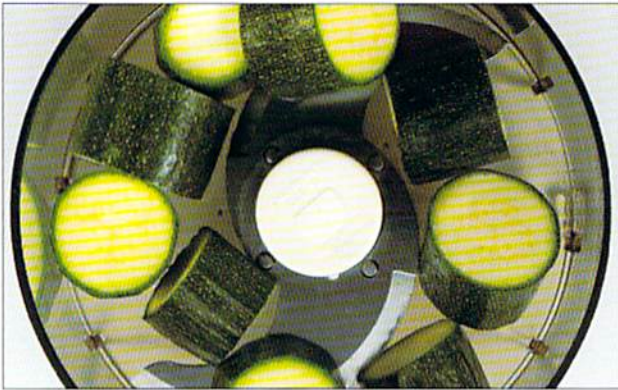

Try chopping some practice foods before you process food to eat. A zucchini or potato is a good choice. First cut it into 1-inch pieces.

Insert the metal blade and put the pieces in the work bowl. Put on the cover and the pusher assembly; press the pusher assembly down to lock it into place. Press the lever down to PULSE and release it. Repeat two or three times and see what happens. Each time the blade stops, let the pieces drop to the bottom of the bowl before you pulse again. That puts them in the path of the blade each time the motor starts.

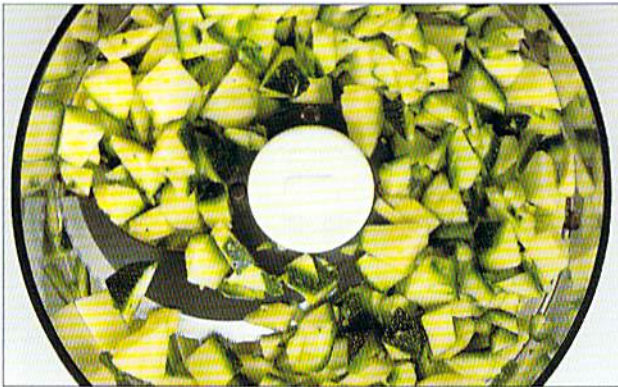

Using the pulse/chopping technique, you can get an even chop without danger of over-processing. Check the texture frequently by looking through the cover of the work bowl. If you want a finer chop, keep pressing the lever down to PULSE and releasing it until you achieve the desired texture. Onions and other food with a high water content will quickly end up as a puree unless examined after each pulse to make sure it is not overprocessed.



Try chopping other food, like meat for hamburger or sausage. Then make mayonnaise, pastry or bread, as described in the recipes in this book. To obtain consistent results:

- ▶ Be sure all the pieces you add to the bowl are about the **same size**
- ▶ Be sure the **amount of food** is no larger than recommended.

Before you do anything, wait for the blade to stop spinning.

When it does, remove the cover first. You can remove the cover and pusher assembly in one operation. Hold the pusher assembly with your thumb **away** from the descending tabs and turn it clockwise. Lift it off, and the cover will come with it.

Never try to remove the cover and the work bowl together; this can damage the work bowl.

Remove the bowl from the base of the machine before removing the blade. This creates a seal to prevent food from leaking. Turn the bowl clockwise to unlock it from the base and lift it straight up to remove it.

To prevent the blade from falling out of the work bowl onto your hand, use one of the methods shown at the right. Be sure your hands are dry. Remove the metal blade before tilting the bowl, using a spatula to scrape off any food sticking to it. Or insert your finger through the hole in the bottom of the work bowl, gripping the blade from the bottom, and grip the outside of the work bowl with your thumb. Or hold the blade in place with your finger or a spatula while pouring out processed food.

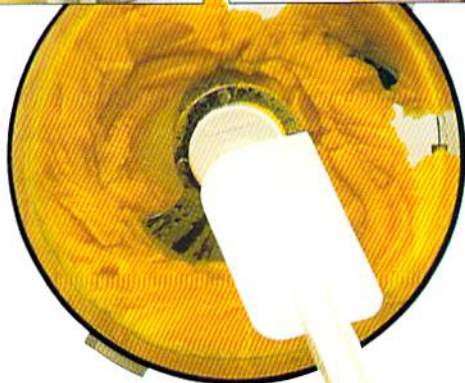

CHOPPING AND PUREEING WITH THE METAL BLADE

6



To chop raw fruits and vegetables

First, cut the food into 1-inch pieces. You get a more even chop when all pieces are about the same size.

Put no more than 2 cups of food into the work bowl. Lock the cover and pusher assembly in place. Press the lever down to PULSE and release it, repeating at the rate of 1 second on, 1 second off until the food is coarsely chopped. Then move the lever up to ON, letting the machine run continuously until the food is chopped. Check frequently to avoid overprocessing. Use the spatula to scrape down any pieces that stick to the sides.



To puree fruit and cooked vegetables

First, cut the food into 1-inch pieces. You get a smoother puree faster when all pieces are about equal in size. Put no more than 2 cups of food in the work bowl. Lock the cover and pusher assembly in place. Pulse to chop coarsely, then move the lever up to ON and process continuously until the food is pureed. (NOTE: Cooked potatoes are an exception to this procedure. They develop a gluey texture when processed with the metal blade. See the recipe for mashed potatoes at the end of the book.)



puree faster and smoother without liquid. Then add just enough liquid to make the puree pourable, return it to the soup liquid and stir to combine.

removing the small pusher. Move the lever up to ON and drop the food pieces through the small feed tube while the machine is running. After adding a cupful this way, add the remaining food to the bowl and process in the usual way.

▶ When making soup, you will want to puree vegetables that have cooked in liquid. Don't add the liquid to the work bowl — just the cooked vegetables; remove them with a slotted spoon. They will

▶ Occasionally, a piece of food may become wedged between the blade and the work bowl. If this happens, remove the cover, lift the blade out carefully and remove the wedged piece. Empty the bowl, reinsert the blade and lock the cover and the pusher assembly into place, first

TECHNIQUES FOR CHOPPING AND PURÉEING WITH THE METAL BLADE

To chop hard food like garlic, hard cheese

Remove the small pusher, press the ON lever and drop the food through the small feed tube while the machine is running.

Small foods like garlic can be dropped in whole. Large foods like hard cheese should be cut into 1-inch pieces. This method of processing minces garlic, shallots and onions. Hard cheese and coconut will have the same texture as if they had been hand grated.

IMPORTANT: Never try to process cheese that is too hard to cut with a knife. You may damage the blade or the machine.

To chop parsley and other fresh herbs

The herbs, the work bowl and the metal blade must all be thoroughly clean and dry. Remove stems from herbs. Add leaves to bowl and process until they are chopped as fine as you want. The more herbs you chop at a time, the finer chop you can obtain. If completely dry when chopped, parsley and other herbs will keep for at least 10 days, stored in an airtight bag in the refrigerator. They may be frozen for months, stored in an airtight container or bag.

To chop peel from citrus fruit or to chop sticky fruit like dates or raisins

For citrus, remove the peel with a vegetable peeler, leaving on the white pith, which is bitter tasting. Cut the peel into lengths of 2 inches or less and process with 1/2 cup of granulated sugar until finely chopped. This may take 2 minutes or longer.

For sticky fruit like dates, raisins, prunes and candied fruit, first freeze the fruit for about 10 minutes. Add to it some of the flour called for in the recipe. Use no more than 1 cup of flour for each cup of fruit.

COMPACT FLAT COVER

Use the Compact Cover for added convenience when your recipe calls for chopping, mixing, puréeing and kneading. It is particularly useful when you are preparing baked goods such as cakes, cookies, pies and breads.

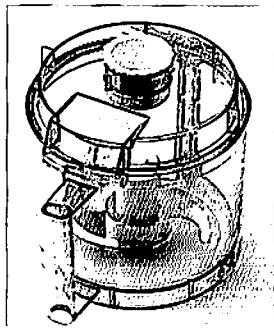

To assemble the Compact Cover: Begin with the work bowl and the metal blade, dough blade, or whisk attachment in place. Place the Compact Cover on the work bowl so that the *Cuisinart logo written on the cover* is face up and readable. Then turn cover **COUNTER-CLOCKWISE** to lock into place.

To disassemble the Compact Cover:

Place one hand near the Cuisinart logo and one hand on opposite end of cover; turn cover **CLOCKWISE**. Lift cover up and off work bowl.

CHOPPING AND PUREEING WITH THE METAL BLADE

8

To chop meat, poultry, fish and seafood

The food should be very cold, but not frozen. Cut it into 1-inch pieces to ensure an even chop. Process no more than 2-1/2 cups (1-1/4 pounds) at a time. Press the lever down to PULSE and release it, repeating 3 or 4 times at a rate of 1 second on, 1 second off. If the food is not chopped fine enough, let the processor run continuously for a few seconds. Check the texture often to avoid overprocessing. Use a spatula to scrape food from the sides of the bowl as necessary.

To puree meat, poultry, fish and seafood

Prepare the food as described above. Pulse until it is evenly chopped, then process continuously to the desired texture. Scrape the bowl with a spatula as needed.

Leave the puree in the work bowl and add eggs, cream and seasonings as called for by the recipe. Process to combine thoroughly.

Remember **you** control texture by the length of time you process. By varying the processing time, you can get a range of textures suitable for hamburgers, hash, stuffed peppers, rough pates or smooth mousses.

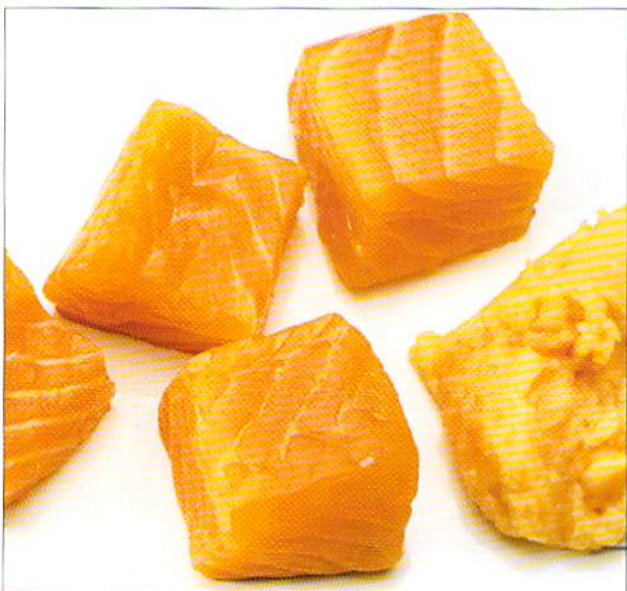



To chop nuts

Chop no more than 2 cups at one time. Press the lever down to PULSE and release it, repeating several times. Check frequently to avoid letting powdered nuts clump together in a nut butter.

When a recipe calls for flour or sugar, add some to the nuts before you chop them — about 1/2 cup for each cup of nuts. This allows you to chop the nuts as fine as you want without turning them into a nut butter.

You can also chop nuts with a shredding disc. The optional Fine Shredding Disc is particularly good.

To make peanut butter and other nut butters

Process up to 2 cups of nuts. Let the machine run continuously. After 2 or 3 minutes, the ground nuts will form a ball that will gradually smooth out. Scrape the sides of the bowl and continue processing until drops of oil are visible. Taste for consistency. The longer you process, the softer the butter will be. For chunk style, add a handful of nuts just after the ball of nut butter begins to smooth out. To make cashew butter, add a little bland vegetable oil. Processor nut butters contain no preservatives. Store in the refrigerator to keep them without separating.

To make flavored butters, spreads and dips

Cut room-temperature butter into tablespoon size pieces. Process flavoring ingredients first — anchovies, cheese, herbs, etc. — chopping them fine. Be sure the work bowl is clean and dry. Add small hard ingredients like garlic and hard cheese through the feed tube while the machine is running. Next, add the butter and process until smooth. Add any liquid ingredients last, while the processor is running, and process just long enough to blend. Process ingredients for spreads and dips in the same way. They should be at room temperature and cut into 1-inch cubes, or added by tablespoonfuls.



TECHNIQUES FOR CHOPPING AND PURÉEING WITH THE METAL BLADE

10

To make mayonnaise

The work bowl and metal blade must be clean and dry. Use one whole large egg, or the yolks from two large eggs. Mayonnaise made from yolks will be almost as thick as butter. You should be able to add 2/3 cup of oil for each yolk or 1-1/4 cups for a whole egg.

Process the yolks or egg with salt, mustard and 2 tablespoons of vegetable oil for at least 30 seconds. Then, while the machine is running, pour 1/4 cup of oil into the small pusher. After it dribbles through the pinhole at the bottom, remove the small pusher and slowly add the remaining oil while the machine runs. See the recipe at the back of this book.

To beat egg whites

Use this method only for recipes that can be done almost entirely by food processor.

The work bowl must be absolutely clean. Add 3 or more egg whites and press the ON lever. Add about 1 teaspoon of lemon juice or vinegar for every egg white. Vinegar makes stiffer whites; its flavor is hardly detectable in cakes, soufflés or ice creams. Continue processing until the egg whites hold their shape - about 1-1/2 to 2-1/2 minutes.

For the lightest, fluffiest egg whites, use the Whisk Attachment which is an optional attachment for the Pro Classic™ Food Processor.

To whip cream

Processor whipped cream holds its shape very well. It is good for decoration or as a topping for gingerbread, berries or other desserts. It will not whip to the light, fluffy consistency obtained by methods that beat in more air. Use the optional Whisk Attachment for the fluffiest whipped cream.

Chill the cream well before starting. Process continuously until it begins to thicken. Then add sugar as desired and continue processing, watching carefully until the cream reaches the desired consistency. For consistently reliable results, add 2 tablespoons of non-fat dried milk for every cup of cream, before whipping.

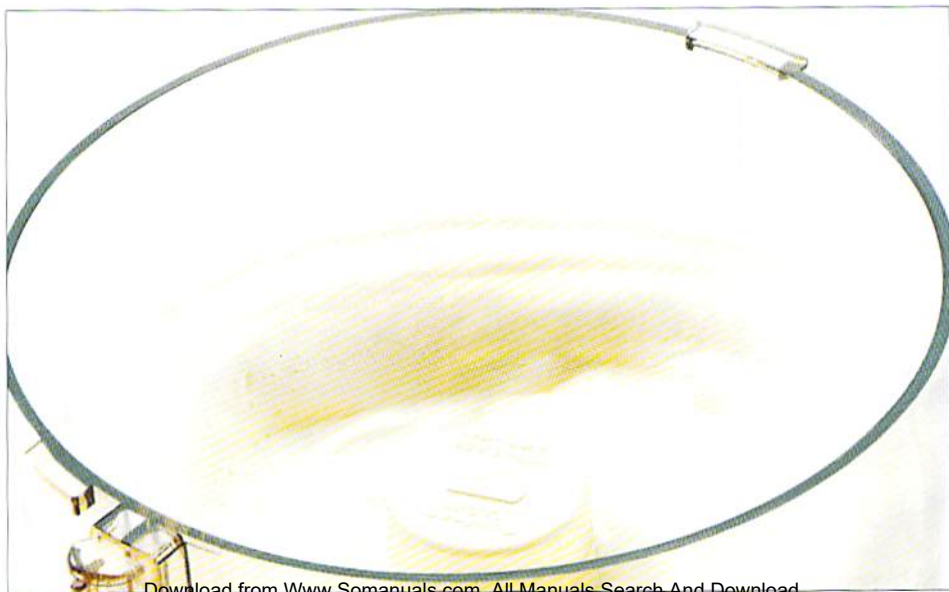

To make crumbs and crumb crusts

Cut or break bread, crackers or cookies into pieces and put them in the work bowl. Process continuously until they reach the desired texture. For seasoned crumbs, chop the parsley or other fresh herbs with the crumbs. For buttered crumbs, process until the dry crumbs are of the desired texture, then dribble melted butter through the small feed tube while the machine is running.

For crumb crusts, process crackers or cookies as described above. Add sugar, spices and butter, cut into pieces, as specified by your recipe. Process until well combined.

To make pastry

This describes general procedure. A recipe giving exact proportions is at the back of this book.

Combine unbleached all-purpose flour, salt and pieces of very cold or frozen butter in the work bowl. Process to the consistency of cornmeal. While the machine is running, start pouring ice water through the feed tube. Stop processing as soon as the dough begins to form a ball, to ensure tender, flaky pastry. Use the dough immediately or form it into a round disc about 1 inch thick. Wrap it in plastic wrap and refrigerate or freeze for later use.

To make quick breads, and cakes that use baking powder and/or soda.

The most important rule for success is not to overmix after the flour is added.

The ingredients for these soft doughs should be cold. If the recipe calls for chopped ingredients like lemon peel or nuts, chop them first while the work bowl is clean and dry. Then set them aside until needed. (Always use sugar when chopping lemon peel; see page 7.)

Put dry ingredients like flour, salt and leavening in the work bowl and process with the metal blade for 5 seconds to mix them. Remove and reserve the dry ingredients.

Add the eggs and sugar to the work bowl and process to mix, letting the machine run about 1 minute. Next, add butter, at room temperature and cut into 1-inch pieces. Let the machine run continuously for a minute, until the butter is thoroughly mixed with the sugar and eggs. Then add flavoring and liquid - vanilla, spices, cocoa, etc. Process until mixed. Add the dry ingredients to the work bowl. Process by pulsing, inspecting after each pulse. Stop pulsing as soon as the dry ingredients have *almost* disappeared into the batter. Overprocessing will cause quick breads and cakes to be tough. (If your recipe calls for ingredients that are to be coarsely chopped - like raisins or nuts - add them last with the mixed dry ingredients.)

To make cake mix

Your food processor work bowl is large enough for the preparation of an 18.5-ounce packaged cake mix.

Insert the metal blade and add the cake mix to the work bowl. While the machine is running, add the eggs and liquid through the small feed tube and process for 5 seconds. Scrape down the side of the work bowl and process again for 1 minute for maximum volume. Do not remove the metal blade. Insert a finger into the underside of the blade from the bottom of the work bowl to hold the blade in place while emptying the batter.

Tip:

After emptying cake batter or puréed soup from the work bowl, replace the bowl on the motor base. Insert the metal blade and pulse once. Centrifugal force will spin the batter off the blade onto the side of the work bowl. Remove the blade, and use the spatula to scrape any remaining batter from the bowl.

TECHNIQUES FOR KNEADING YEAST DOUGH WITH THE DOUGH BLADE

12

The Pro Classic™ Food Processor can mix and knead dough in a fraction of the time it takes to do it by hand. You will get perfect results every time if you follow these directions. NEVER TRY TO PROCESS DOUGH THAT IS TOO STIFF TO KNEAD COMFORTABLY BY HAND.

There are two general types of yeast dough.

Typical bread dough is made with a flour mix that contains at least 50% white flour. It is uniformly soft, pliable and slightly sticky when properly kneaded. It always cleans the inside of the work bowl completely when properly kneaded.



Typical sweet dough contains a higher proportion of sugar, butter and/or eggs than typical bread dough. It is rich and sticky and it does not clean the inside of the work bowl. It requires less kneading after the ingredients are mixed. Although 30 seconds is usually sufficient, 60 to 90 seconds gives better results if the machine does not slow down. Except for kneading, described below, the processing procedures are the same for both types of dough.



Machine capacity

If a bread dough calls for more than the recommended amount of flour, mix and knead it in equal batches. Do the same for sweet doughs that call for more than 3-1/2 cups of flour. Recommended maximum amount of flour is: 4 cups of all-purpose flour or 2-1/2 cups of whole-grain flour.

Using the right blade

Measure flour by the "stir, scoop and sweep" method described below. Use the dough blade when the recipe calls for more than 3-1/2 cups (17-1/2 ounces) of flour. Use the metal blade when a recipe calls for less than 3-1/2 cups of flour.

Because the dough blade does not extend to the outside rim of the work bowl, it cannot pick up all the flour when small amounts are processed.

Whichever blade you use, always push it down as far as it will go on the motor shaft.

Measuring the flour

It's best to weigh it. If you don't have a scale, or the recipe doesn't specify weight, measure by the "stir, scoop and sweep"

method. Use a standard, graduated dry measure, not a cup for liquid ingredients.

With a spoon or fork, *stir* the flour in its container. With the dry measure, *scoop* up the flour so it overflows. With a spatula, knife or chopstick — being careful not to press down — *sweep* excess flour back into the container so the top of the measure is level.

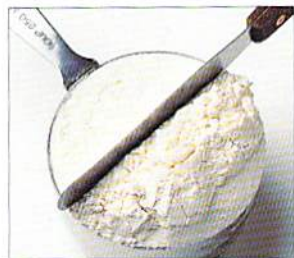

Proofing the yeast

The expiration date is marked on the packages. To be sure your yeast is active, dissolve it in a small amount of warm liquid (about 1/3 cup for one package of dry yeast). If the recipe includes a sweetener like sugar or honey, add a tablespoon with the yeast. If no sweetener is called for, add a pinch. *The yeast won't foam without it.* Let the mixture stand until it foams — up to 10 minutes.

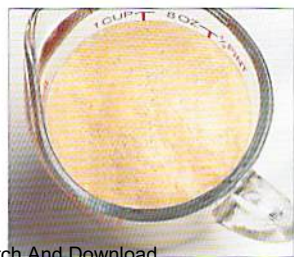

Processing dry ingredients

Put the flour in the work bowl with all the other dry ingredients. If the recipe calls for herbs, oil or solid fats like butter, add them with the flour. Turn the machine on and let it run for about 20 seconds. (Cheese, nuts and raisins may be added with the dry ingredients or during the final kneading. To leave them almost whole, add them 5 seconds before you stop kneading. For a finer texture, add them sooner.)

Adding liquids

All liquid should be added through the feed tube while the machine is running. Add liquid in a slow, steady stream, only as fast as dry ingredients absorb it. If liquid splashes or splatters, stop adding it but do not turn off machine. Wait until ingredients in bowl have mixed, then add remaining liquid slowly. Pour liquid onto dough as it passes under feed tube opening. Do not pour liquid directly onto bottom of bowl.

Follow the recipe carefully. It is important to add enough liquid to make the dough soft enough to knead. Kneading dough that is too stiff can strain the machine.

The temperature of liquids used to dissolve and activate yeast must be between 105° and 120°F. Yeast cells are not activated at temperatures lower than this and they die when exposed to temperatures higher than 130°F.

All liquid *except* that used to activate yeast should be cold, to min-

imize the possibility of overheating the dough. You must never knead a yeast dough to a temperature higher than 100°F. Doing so will slow or even prevent the action of the yeast.

Kneading bread dough

Do not try to use the machine to knead dough that is too stiff to knead comfortably by hand. Doing so can strain the machine.

After the dough starts to clean the inside of the work bowl completely and forms a ball, process it for 60 seconds to knead it. Stop the machine and test the dough to be sure it's properly kneaded. Typical bread dough should have a soft, pliable texture and it should feel slightly sticky. Stretch the dough with your hands to test it. If it feels hard, lumpy or uneven, continue processing until it feels uniformly soft and pliable. Make sure that the blade is firmly pressed back into place after removing the dough to test it.

Kneading dough for coffee

cakes, batter bread and brioche
Process dough for at least 30 seconds after all the ingredients are incorporated. It will not clean the inside of the work bowl. If necessary, scrape the bowl and process for 5 more seconds.

Rising

Put the dough in a large, lightly floured plastic bag. Squeeze out all the air and close the end with a wire twist, allowing space for the dough to rise.
Or put the ball of dough in a large bowl coated with soft butter or

vegetable oil. Roll the dough around to coat its entire surface. Cover it with a damp towel or a piece of oiled plastic wrap.

Let it rise in a warm, draft-free place — about 80°F. The rising time is usually about 1-1/2 hours but will vary from 45 minutes to several hours, depending on the type of flour and the humidity of the air. To test if the dough has risen enough, stick a finger in it. An indentation should remain. If it doesn't, let the dough rise more and test again. When it has risen enough, punch the dough down.

Shaping, finishing and baking

If you shape the dough in loaf pans, fill them only half full. Let rise until dough is just slightly above the top of the pan. If shaping free-form loaves, let them rise on an oiled baking sheet until at least doubled in bulk.

Making consecutive batches

You can make several batches of bread dough in a row.

The motor in the Pro Classic™ Food Processor is extremely efficient. Follow the recipe for White Bread, pg. 43.

TECHNIQUES FOR KNEADING YEAST DOUGH WITH THE DOUGH BLADE

14

Problems and Solutions with Typical Bread Dough

Blade doesn't incorporate ingredients

Always start processor before adding liquid. Add liquid in slow, steady stream, only as fast as dry ingredients absorb it. If you hear liquid sloshing, stop adding it but do not turn off machine. Instead, wait until ingredients in work bowl have mixed, then add remaining liquid slowly. Pour liquid onto dough as it passes under feed tube; do not pour liquid directly onto bottom of work bowl.

Blade rises in work bowl

Blade may not have been pushed down as far as it will go before processing started.

Excessively sticky dough can cause blade to rise even though it cleans inside of work bowl. If dough feels very sticky, reinsert blade and immediately add 2 tablespoons flour through feed tube while machine is running.

Dough doesn't clean inside of work bowl.

- Amount of dough may exceed maximum capacity of your food processor. Remove half and process in 2 batches.

- Dough may be too dry. If it feels crumbly, add water - 1 tablespoon at a time - while machine is running, until dough becomes moist and cleans inside of work bowl. Wait 10 seconds between additions of water.

- Dough may be too wet. While machine is running, add 1 tablespoon of flour. If necessary, add more - 1 tablespoon at a time - until dough cleans inside of work bowl and forms a ball.

- Plastic dough blade is intended only for recipes calling for at least 3-1/2 cups of flour (17-1/2 ounces, 495g). If your recipe calls for less flour, remove plastic dough blade and insert metal blade. Always use metal blade for recipes calling for less than 3-1/2 cups of flour, such as pizza dough.

Nub of dough forms on top of blade and does not become uniformly kneaded.

Stop machine, carefully remove dough, divide it into 3 pieces and redistribute them evenly in work bowl. Continue processing until dough is uniformly soft and pliable.

Dough feels tough after kneading

Divide dough into 2 or 3 pieces and redistribute evenly in bowl. Process 10 seconds or until uniformly soft and pliable.

Soft dough or liquid leaks onto base of food processor

Always start processor before adding liquid and add liquid only as fast as dry ingredients absorb it.



Nub of dough forms.



Dough is too dry.



Dough is too wet and sticky.

Motor stops

- Pusher assembly may have become unlocked. Push down pusher sleeve to lock it into place and continue processing.
- Cover may have become unlocked. Lock cover and continue processing.
- Power cord may have become unplugged. Plug machine in and continue processing.
- Excessive strain may have caused motor to overheat and stop. Wait for the motor to cool off, 5-10 minutes. A safety protector in the motor prevents it from excessive overheating. If the motor stops, turn the machine off. After 5-10 minutes, divide dough into 2 batches and complete processing. Pinch dough to make sure that it is not too stiff to knead comfortably by hand. If it is, add liquid - 1 teaspoon at a time - until dough is sufficiently moist to clean inside of bowl.

Dough doesn't rise

We recommend that you always test activity of yeast before using it by stirring it and at least 1/2 teaspoon sugar into about 1/3 cup warm liquid (105° - 120°F). Within 10 minutes foam should develop, indicating yeast is active. Do not use dry yeast after expiration date on package.

Avoid killing yeast cells by dissolving yeast in too warm water or overheating dough by excessive kneading. Dissolve yeast in about 1/3 cup of warm liquid at 105°-120° F. All other liquid should be cold.

Don't knead so long that it becomes overheated. The ideal temperature for kneaded dough is 80°F; it should never exceed 100°F.

Let dough rise in draft-free environment of about 80°-90°F.

Dough containing whole grain flour will take longer to rise than dough made of white flour only.

Baked bread too heavy

Next time, feel dough to be sure it is uniformly soft, pliable and slightly sticky before setting it aside to rise. Let dough fully double in bulk in bowl or bag, punch it down, then let it double again after it is shaped.

PROBLEMS AND SOLUTIONS WITH TYPICAL SWEET DOUGHS**Motor slows down.**

- Amount of dough may exceed maximum capacity of your food processor. Remove half and process in 2 batches.
- Don't process too long after all the ingredients are incorporated. These rich doughs will give you good results after only 30 seconds of kneading.

Blade doesn't incorporate ingredients.

Butter or margarine, if not melted, must be cut into tablespoon-size pieces before being added to work bowl.

Metal blade rises in work bowl

Blade may not have been pushed down as far as it will go before processing started. Machine may be overloaded.

Stop it, remove half of dough and process in 2 batches.

Motor stops

See comments under "Typical Bread Dough".

Dough doesn't rise

See comments under "Typical Bread Dough".

PREPARING FOOD FOR SLICING AND SHREDDING

16

Round fruits and vegetables

Before processing onions, apples and other large, round fruits and vegetables, trim them with a knife. Cut the bottom end flat, to make the food lie stable on the disc.

Place the food in the feed tube, flat side down. Position it as far right as possible, to prevent it from tilting when being processed.

Choose fruits that are firm and not too ripe. Always remove large hard pits and seeds from fruits before processing. Seeds from citrus fruits need not be removed. You may remove the rind before slicing or shredding, or leave the rind on.

Whole peppers are an exception

Remove the stem and cut the stem end flat. Remove the core and scoop out the seeds. Leave the end opposite the stem whole, to keep the structure stiff. This ensures round, even slices.

Large fruits like pineapple and cantaloupe

Cut them in half and remove the seeds or core. If necessary, cut the halves into smaller pieces to fit the feed tube. Remember to cut the ends flat.

Cabbage and iceberg lettuce

Turn the head on its side and slice off the top and bottom, leaving a center section about 3 inches deep. Remove the core and cut the center section in wedges to fit the feed tube. Remove the core from the



bottom piece and cut it and the top piece into wedges to fit the feed tube. The optional 2mm or 1mm Slicing Discs are excellent for slicing cabbage for coleslaw.

If the fruit or vegetable doesn't fit

Try inserting it from the bottom of the feed tube. The opening there is slightly larger.

Pack the feed tube for desired results

For small, round, slices or short shreds from carrots, zucchini and other long vegetables, cut them in feed-tube heights and pack them tightly upright.

For long slices or shreds, cut the the food in feed-tube widths and pack the pieces horizontally.

Food should fit snugly but not so tight that it prevents the pusher from moving.

When slicing or shredding food, always use the pusher. **Never put your fingers or a spatula into the feed tube.**

Never push down hard on the pusher. Use *light* pressure for soft fruits and vegetables like bananas, mushrooms, strawberries and tomatoes, and for all cheese. Use *medium* pressure for most food — apples, celery, citrus fruit, potatoes and zucchini. Use *firm* pressure for really hard vegetables like carrots and yams.

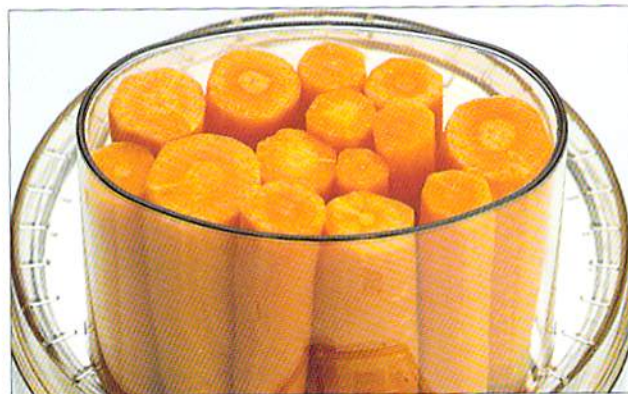

PRACTICING SLICING AND SHREDDING

18



1. Insert a slicing or shredding disc, put the cover on the work bowl and insert the prepared food in the feed tube.

2. Prepare the pusher assembly. Lock the small pusher in place and unlock the slide lock on back of the sleeve, so the pusher can move up and down freely.

3. Slide the pusher assembly over the feed tube and push the sleeve down to lock it into place. Apply pressure to the pusher while pressing the lever down to PULSE. Release the lever as soon as the food is sliced or shredded.

4. You can load the feed tube repeatedly without removing the work bowl cover. Simply grasp the pusher assembly with your thumb on the wide locking tab. Press firmly on the tab and lift up. The pusher assembly will come off easily, leaving the cover and feed tube in place. Your other hand is free to reload the feed tube.



REMOVING SLICED OR SHREDDED FOOD



Before you do anything, wait for the disc to stop spinning.

When it does, remove the cover first. Hold the pusher assembly with your thumb *away* from the locking tabs and turn it clockwise. Lift, and the pusher assembly and cover will come off together.

Remove the slicing or shredding disc before removing the work bowl. Place two fingers under each side of the disc and lift it straight up. Then turn the bowl clockwise to unlock it from the base and lift it straight up to remove it.

You can place the disc on top of the inverted work bowl cover, to minimize drips and spills.



SLICING AND SHREDDING TECHNIQUES

20

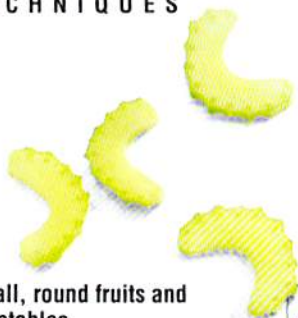

Small, round fruits and vegetables

For large berries, radishes and mushrooms, trim the opposite ends flat with a knife. Insert the food through the feed tube, standing each piece on a flat end. You can fill the tube to about 1 inch from the top. The bottom layer gives you perfect slices for garnish.

If you want all the slices to be perfect, it's best to process one layer at a time.

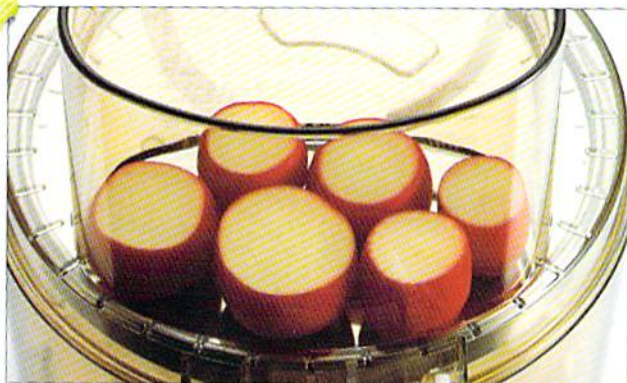

Long fruits and vegetables

Trim food like bananas, celery, and zucchini by cutting them into pieces a little shorter than the feed tube. Cut both ends flat. (Use a ruler as a guide, or the pusher assembly with the pusher pulled out as far as it will go.)

Fill the feed tube with the pieces, standing them vertically and adding enough pieces so they are solidly packed and cannot tilt sideways as they are sliced or shredded.



Small amounts of food

Use the small feed tube and the small pusher. Remove the small pusher from the pusher assembly. Slide the pusher assembly over the feed tube and press the sleeve down to lock it into place. Be sure the slide lock on the sleeve is locked.

Cut the food in lengths a little shorter than the feed tube. If you are slicing one or two long, thin vegetables like carrots, push them against the right. If you are slicing a





few vegetables that are wide at one end and narrow at the other — carrots, celery or scallions — cut them in half and pack in pairs, one wide end up, one narrow end up.

French-cut green beans

Trim fresh green beans to feed-tube widths. Blanch them for 60 seconds in boiling salted water. Plunge them immediately into cold water to stop the cooking. When they are cold to the touch, drain and dry them. Stack them in the feed tube horizontally to about 1 inch from the top. Use the slicing disc.



Be sure the small pusher is locked and the slide lock on the sleeve is unlocked. Apply light pressure to the pusher and press the lever down to PULSE until beans are sliced. To make long, horizontal slices or shreds of raw zucchini or carrots, use the same procedure.

Matchsticks or julienne strips

Process the food twice — “double-slice” it. Insert any large fruit or vegetable — potatoes, turnips, zucchini, apples — in the feed tube horizontally. Apply pressure to the pusher while pressing the lever down to PULSE until the food is sliced. You will get long slices. Remove the slices from the work bowl and reassemble them as shown. Reinsert them in the feed tube, wedging them in tightly. Slice them again. You will obtain long julienne strips. With the optional Square Julienne Discs, you can make square julienne strips in one operation.



Cooked meat and poultry

The food must be very cold. If possible, use a chunk of food just large enough to fit the feed tube. To make julienne strips of ham, bologna or luncheon meat, stack slices of them. Then roll or fold them double and stand them upright in the feed tube, wedging in as many rolls as possible. This technique works better with square or rectangular pieces than with round ones.

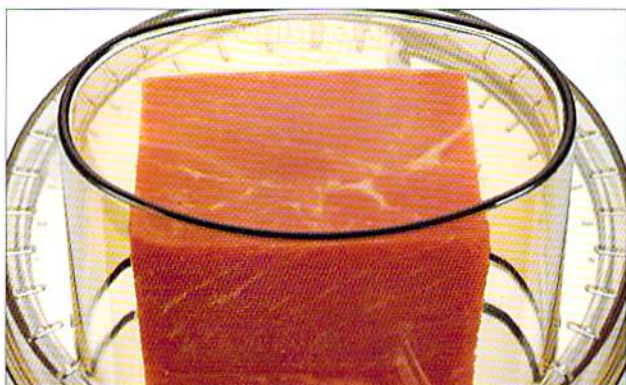

Uncooked meat and poultry

Cut the food into pieces to fit the feed tube. Boned, skinned chicken breasts will usually fit when cut in half crosswise. Wrap the pieces in plastic wrap and put them in the freezer. They are ready to slice when they pass this "knife test". They are easily pierced with the tip of a sharp knife although semi-frozen and hard to the touch. Stand them in the feed tube, cut side down, and slice them *against* the grain, using firm pressure on the pusher. Or lay them flat in the feed tube, as many as will fit, and slice *with* the grain, using firm pressure.

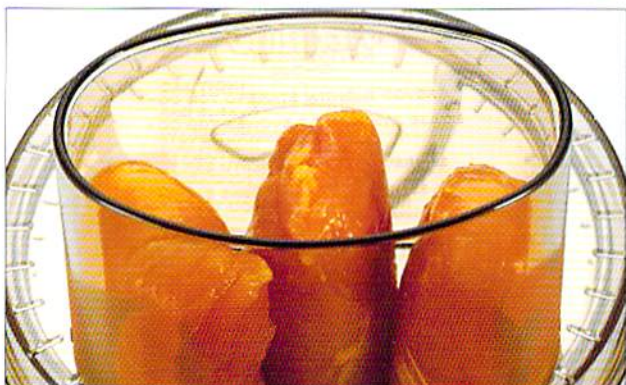

Frankfurters, salami and other sausages

If the sausage is soft, freeze it until hard to the touch but easily pierced with the tip of a sharp knife. Hard sausages need not be frozen. If the sausage is thin enough to fit in the small feed tube, use that tube. Otherwise, cut the sausage into pieces to fit the large feed tube completely. Stand the pieces vertically, packing them in tightly so they cannot tilt sideways.



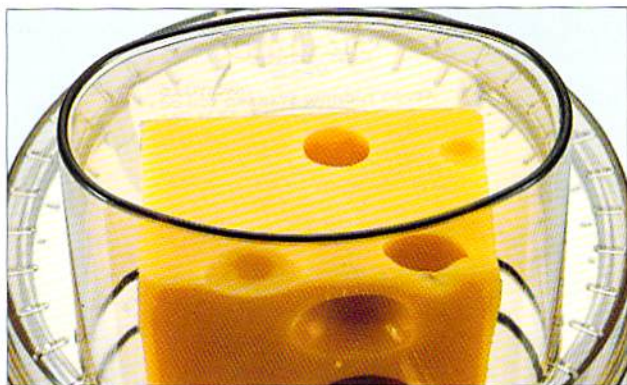

Firm cheese like Swiss and Cheddar

Cut the cheese into pieces to fit the feed tube. Put it in the freezer until it is semi-frozen — hard to the touch but easily pierced with the tip of a sharp knife. Stand the pieces in the feed tube and apply light pressure to the pusher.

IMPORTANT: Never try to slice soft cheese like Mozzarella or hard cheese like Parmesan. You may damage the slicing disc or the food processor itself. You can successfully shred most cheeses except soft ones. The exception is Mozzarella, which shreds well if thoroughly chilled. Hard cheeses like Parmesan shred well only at room temperature.

TYPE OF CHEESE	CHOP	SHRED	SLICE
Soft <i>Brie, Camembert, Mozzarella, ricotta, Liederkrantz, cottage, cream</i>	yes	no	no
Semi-Soft <i>blue, Fontina, Bel Paese</i>	yes	yes chill chill chill	no
Semi-Hard <i>Cheddar, Monterey Jack, Longhorn, Swiss, Jarlsberg, Edam, Gouda, Provolone</i>	yes	yes chill chill chill chill chill	yes chill chill chill chill chill
Hard <i>Parmesan, Romano, Pecorino, Sapsago</i>	yes	yes room temp	no

IF YOU HAVE A PROBLEM

Most problems with the food processor are easily solved. Here are some possible problems and their solutions.

Food is unevenly chopped

Either you are trying to process too much food at one time, or you are running the machine continuously instead of pulsing on and off until pieces of food are no larger than 1/2-inch cubes.

Liquid leaks from bottom of bowl onto motor base

Remove bowl from base as soon as you finish processing. Do not remove metal blade first. When bowl and blade are removed together, blade drops down and forms an almost perfect seal against the bowl.

Liquid leaks out between bowl and cover when machine is running

You added too much liquid. Never use more than:

2-3/4 cups thin, 5 cups thick liquid.

The thicker the liquid, the more you can use. The figures above are for thick mixtures like pancake or cake batter.

Slices are uneven or slanted

Pack feed tube more carefully as described on pages 16 and 17. Maintain even pressure on pusher.

Carrots or similar food falls over in feed tube

Cut food into enough short pieces of equal height to fill feed tube. To slice one or two pieces, use small feed tube. Cut carrots in half and insert one piece point down and the other stem down.

Sliced or shredded food piles up on one side of work bowl

This is normal. Remove disc occasionally and even out processed food. When food gets close to bottom of disc, empty work bowl.

A few pieces of food remain on top of slicing or shredding disc

This is normal. In most cases, you can shred more of the food by moving the large pusher up and down, allowing the piece to be shredded, or by repositioning the piece in the feed tube and reshredding it.

Soft cheese like mozzarella spreads out and collects on top of shredding disc

The cheese was not cold enough, or the pressure on the pusher was too great. To shred soft cheese, do not push on the pusher but let the cheese go through by itself. Tap on the pusher to guide it through.

CLEANING AND STORING

Keep your Pro Classic™ Food Processor ready to use on a kitchen counter. When it's not being used, leave it unplugged. Don't leave it with the pusher assembly in locked position; this could damage the on-off mechanism.

Store the blades and discs as you would sharp knives — out of the reach of children. The Disc and Blade Holders, optional accessories, offer safe and convenient storage.

All parts except for the motor base are dishwasher-safe, and we recommend washing them in the dishwasher. Insert the work bowl upside down. Remember where you place sharp blades and discs, and unload the dishwasher carefully.

To simplify cleaning, rinse the work bowl, cover, pusher assembly and blade or disc immediately after use so food won't dry on them. Openings at the bottom of the large pusher provide drainage and make cleaning easy. If food lodges in the pusher, remove it by running water through or by using a bottle brush.

If you wash blades and discs by hand, do it carefully. Avoid leaving them in soapy water where they may disappear from sight. To clean the metal blade, fill the work bowl with soapy water, hold the blade by its plastic center and move it rapidly up and down on the center shaft of the bowl. Use of a spray attachment is also effective. If necessary, use a brush.

The work bowl is made of Lexan® plastic, which is shatter-resistant and heat-resistant. It should not be placed in a microwave oven. The tube at the back of the bowl houses the metal rod that activates the motor.

Chopping certain foods may scratch or cloud the work bowl. Among them are ice, whole spices and oils like wintergreen. If you like to prepare your own spice blends, you may want to keep a second bowl just for that purpose.

The base housing is made of a tough plastic with high impact resistance. Its smooth surface will look new for years. Keep a sponge handy as you work and wipe spills from the base.

Four rubber feet on the underside keep the base from moving on most work surfaces when the machine is processing heavy loads. If the feet leave spots on the counter, spray them with a spot remover like Fantastik or K2-R and wipe with a damp sponge. If any trace of the spot remains, repeat the procedure and wipe the area with a damp sponge and non-abrasive cleaning powder.

To clean the inside of the detachable stem, slide the stem release button on the side up as far as it will go and hold it there as you run water through the stem.

IMPORTANT: Never store any blade or disc on the motor shaft. No blade or disc should be placed on the shaft except when the processor is about to be used.

FOR YOUR SAFETY

Like all powerful electrical appliances, a food processor should be handled with care. Follow these guidelines to protect you and your family from misuse that could cause injury.

- ▶ Handle metal blade and discs carefully. Their cutting edges are very sharp.
- ▶ Always place disc on flat stable surface before connecting detachable stem.
- ▶ Never put blade or disc on motor shaft until work bowl is locked in place.
- ▶ Always be sure that blade or disc is down on motor shaft as far as it will go.
- ▶ Always insert metal blade in work bowl before putting ingredients in bowl.
- ▶ When slicing or shredding food, always use pusher. Never put your fingers or a spatula into feed tube.
- ▶ Always wait for blade or disc to stop spinning before you remove pusher assembly or cover from work bowl.
- ▶ Always remove work bowl from base of machine before you remove metal blade or dough blade.
- ▶ Be careful to prevent metal blade from falling out of work bowl when emptying bowl. Remove it before

tilting bowl, or hold it in place with your finger, a spatula or a spoon.

- ▶ Do not use pusher assembly if sleeve becomes detached from pusher. Call Cuisinart Owner Service immediately. Our toll-free number is listed in the warranty.

SOME TECHNICAL DATA

The motor in your food processor operates on standard line operating current. The appropriate voltage and frequency for your machine are shown on a label under the base.

An automatic, temperature-controlled circuit breaker in the motor ensures complete protection against motor burnout. If the processor runs for an exceptionally long time when chopping, mixing or kneading a thick or heavy mixture in successive batches, the motor may overheat. If this happens, the processor will stop. Turn it off and wait for the motor to cool off before proceeding. It will usually cool off within 10 minutes. In extreme cases, it could take an hour.

Safety switches prevent the machine from operating when the work bowl or the cover is not locked into position. The motor stops within seconds when the motor is turned off, and a fast-stop circuit stops it instantly when the pusher assembly is unlocked.

RECIPES

26

APPETIZERS

GUACAMOLE	27
BLUE CHEESE AND PECAN SPREAD	27
CHICKEN LIVER PATE	28
CHEESE COINS	28

SOUPS

CHUNKY GAZPACHO	29
LEEK AND POTATO SOUP/VICHYSOISE	29
LENTIL SOUP	30
SPLIT PEA SOUP	30

MEATS AND FISH

HAMBURGERS	31
MEATLOAF OR MEATBALLS	31
CHILI	32
SAUSAGE	33
FARMHOUSE HASH	33
CHICKEN AND VEGETABLES STIR-FRY	34
CRAB CAKES	35

VEGETABLES

BROCCOLI PUREE	35
MASHED POTATOES	36
POTATOES AU GRATIN	36
SHREDDED CARROTS AND ZUCCHINI	37

SALADS

TOMATO SALAD	37
CREAMY COLE SLAW	38
SHREDDED CARROT SALAD	38

SAUCES

PESTO	39
MEXICAN SALSA	39
MAYONNAISE	40
NO-COOK CRANBERRY RELISH	40
PASTRY CREAM	40
CHOCOLATE SAUCE	41
RASPBERRY SAUCE	41

PASTRY

PIE PASTRY	41
FRUIT TART	41

QUICK BREADS, YEAST BREAD AND PIZZA

CORN BREAD	42
COFFEE CAKE	42
WHITE BREAD	43
WHOLE WHEAT BREAD	43
PIZZA DOUGH	44
PIZZA IN A HURRY	44
PIZZA SAUCE	45

DESSERTS

BROWNIES	45
CHOCOLATE CHIP OATMEAL COOKIES	46
CARROT CAKE	46
CREAM CHEESE FROSTING	47
PEAR YOGURT	47
BANANA-APPLE SHERBET	47
APPLE PIE	48

TIP: Use the Compact Cover for added convenience when your recipe calls for chopping, mixing, pureeing or kneading. It is particularly useful when you are preparing baked goods such as cakes, cookies, pies and bread.

Guacamole

Serve with tortilla chips or crisp vegetables. For a less pungent taste, use flat-leaf parsley instead of cilantro.

INGREDIENTS	
1	large garlic clove, peeled
1	medium jalapeno pepper, halved and seeded
1/2	cup tightly packed cilantro leaves
1	medium scallion, white part and 2 inches of green, cut in 1-inch pieces
3	ripe medium avocados (1/2 pound each), peeled, halved and pitted
3	tablespoons lemon juice
	Pinch cumin
1/4	teaspoon salt
1	medium tomato, quartered, seeds removed
1/4	teaspoon chili powder
2-1/4	<i>cups yield</i>

Use metal blade to chop garlic, pepper, cilantro, and scallion until minced, about 15 seconds. Scrape down work bowl. Add avocados and all remaining ingredients except tomato. Process until smooth, about 1 minute, scraping bowl as necessary. Add tomato and pulse about 6 to 8 times, until it is finely chopped. Adjust salt if necessary.

Blue Cheese and Pecan Spread

You can substitute cottage cheese for all or part of the cream cheese and you can substitute walnuts for pecans.

INGREDIENTS	
1/4	cup shelled pecans
6	ounces cream cheese, in 1-inch pieces
2	tablespoons blue cheese
1	<i>cup yield</i>

Process nuts with metal blade until they are finely chopped, about 10 seconds. Add cream cheese and blue cheese. Process until well mixed and smooth, about 10 seconds. (If substituting cottage cheese, process it until smooth, about 90 seconds.)



Chicken Liver Pate

An extraordinarily good party dish that is easy to make and keeps well. Serve it on toasted French bread or apple slices.

INGREDIENTS

1	large unpeeled garlic clove
3	tablespoons butter, for sauteeing
1	pound chicken livers, trimmed
8	ounces unsalted butter
1	teaspoon salt
1/8	teaspoon freshly ground black pepper
1/4	teaspoon freshly ground allspice
1	tablespoon Cognac

2-1/4 *cups yield*

Put garlic in small saucepan, cover with water and simmer 10 minutes. Reserve. Heat butter in skillet until it bubbles. Saute chicken livers over medium-high heat until brown on the outside but still pink within.

Squeeze softened interior of garlic into work bowl. Add livers and remaining ingredients. Process until creamy and smooth, about 1 minute. Scrape down bowl as necessary.

Transfer pate to crock or serving dish, cover and refrigerate at least 4 hours. Let stand at room temperature for 30 minutes before serving. Well covered, can be refrigerated for up to 5 days.

Cheese Coins

These tender and flavorful appetizers are easy to make, convenient to serve, and they can be refrigerated or frozen.

INGREDIENTS

8	ounces Cheddar cheese, cut in 1-inch pieces
4	ounces unsalted butter, at room temperature, cut in pieces
1/4	teaspoon salt
1/4	teaspoon Tabasco sauce or pinch of cayenne pepper
1	cup flour

100 *cheese coins*

Use metal blade to chop cheese until it resembles coarse meal, about 30 seconds. Add butter, salt and pepper. Process until smooth, about 60 seconds. Scrape down bowl, add flour and process until flour is just mixed in. Chill dough until firm enough to shape into logs, about 1 hour.

Divide dough into 3 equal parts and roll each into a cylinder about 1-1/2 inches in diameter. Chill until firm, about 2 hours.

Preheat oven to 400°F. Cut dough into 1/8-inch slices and place slices 1-1/2 inches apart on lightly greased baking sheet. Bake until lightly colored, about 10 minutes, being careful not to brown them. Transfer to wire rack to cool.

Unbaked, plastic-wrapped cylinders keep for about a week in the refrigerator. Cooked cheese coins can be frozen and reheated for 6 to 8 minutes in a 300°F oven.



Chunky Gazpacho

This refreshing cold soup can be ready in less than 10 minutes. You may serve it at once, but it improves with chilling.

INGREDIENTS

1	small garlic clove, peeled
1/2	small jalapeno pepper*
4	scallions
1	celery stalk
1/2	medium bell pepper
2	tomatoes
2	cups tomato or V-8 juice
1	medium cucumber
2	tablespoons lemon juice
1	teaspoon salt
1/4	teaspoon freshly ground black pepper

4-1/2 *cups yield*

Halve jalapeno pepper and remove seeds. Trim scallions and celery and cut into 1-inch pieces. Quarter and seed bell pepper and tomatoes. Peel cucumber and cut in half lengthwise. Remove seeds and cut to fit feed tube vertically.

Use metal blade to process garlic and jalapeno pepper until finely chopped. Add scallion, celery and bell pepper. Pulse/chop to medium chop. Put in large mixing bowl. Pulse/chop 1/2 the tomatoes until coarsely chopped. Add to mixing bowl. Puree remaining tomatoes until smooth, about 1 minute. With machine running, pour in 1/2 cup of tomato juice. Add to mixing bowl with remaining tomato juice and stir.

Insert slicing disc, stand cucumber pieces upright in feed tube and slice, using light pressure. Add to mixing bowl with remaining ingredients and stir to combine. Cover and chill before serving.

*Handle hot peppers carefully. Their oil can irritate the skin and eyes. Wash your hands after preparing them.

Leek and Potato Soup/Vichyssoise

Louis Diat, longtime chef at the New York Ritz Hotel, transformed the everyday Leek and Potato Soup into a cold soup suitable for parties.

INGREDIENTS

2	medium leeks, white part only, thoroughly cleaned
1/2	medium onion, peeled and halved
1	tablespoon unsalted butter
2	medium all-purpose potatoes, peeled
1-1/2	cups chicken stock
1	cup water
	Salt and freshly ground pepper to taste
1	cup milk
1/4	cup heavy cream
	Chopped chives, for garnish

4 *cups yield*

Cut leeks to fit feed tube. Use slicing disc to slice leeks and onions. Melt butter in large saucepan. Add leeks and onion and saute, stirring often, until soft but not brown, about 10 minutes.

Cut potatoes in half crosswise, then quarter lengthwise. Use slicing disc to slice them. Add potatoes, stock and water to saucepan. Bring to boil, reduce heat, cover and simmer gently, stirring occasionally, until vegetables are very tender, about 25 minutes. Adjust seasoning and serve hot as Leek and Potato Soup or proceed as follows for cold Vichyssoise.

Strain liquid into large saucepan and set aside. Use metal blade to puree vegetables, stopping once to scrape bowl. Whisk puree into reserved liquid, add milk and bring to a boil over moderate heat, stirring constantly. Remove from the heat and stir in cream. Season to taste with salt and pepper. Refrigerate until thoroughly chilled. Taste again for seasoning and sprinkle with chopped chives.

Lentil Soup

This hearty winter soup is a meal on its own, accompanied by crusty bread and a salad.

INGREDIENTS

8	ounces lentils
1/2	large garlic clove, peeled
1/2	small onion, peeled and halved
1/2	medium celery rib, in 1-inch pieces
1/2	medium carrot, in 1-inch pieces
2	medium tomatoes, quartered
2-1/2	cups beef broth
2-1/2	cups water
2	teaspoons white-wine vinegar
1/2	teaspoon paprika
1/2	teaspoon salt*
1/8	teaspoon freshly ground pepper
	Pinch dried thyme
1/2	pound Polish kielbasa or other smoked sausage

6 *cups yield*

Wash lentils under cold running water, drain them and place them in a large saucepot.

Use metal blade to pulse/chop garlic, onions, celery and carrots until finely chopped. Put in pot with lentils. Chop tomato into fine pieces. Add to pot with all remaining ingredients except sausage. Cover pot and cook for about 1 hour.

Freeze sausage until hard to the touch but easily pierced with tip of sharp knife, about 30 minutes.

Drain and reserve soup liquid and puree solids with metal blade. Return puree to broth and stir to combine. Use slicing disc to slice sausage. Add sausage to soup and reheat gently until sausage is warm, stirring occasionally, about 20 minutes.

*Omit salt if using salty sausage.

Split Pea Soup

A perfect family lunch or supper.

INGREDIENTS

1/2	pound split green peas
1/2	large onion, quartered
1/2	large garlic clove
3/4	pound smoked ham hocks
3-1/2	cups water
1	medium carrot
1/2	large celery rib
1/2	medium potato
	Salt and pepper

4 *cups yield*

Rinse peas and place in large pot. Peel onion and garlic. Use metal blade to chop garlic fine, about 10 seconds. Add onion and pulse until coarsely chopped, about 6 to 8 pulses. Add to pot with ham hocks and water. Bring to a boil and reduce heat. Cover and simmer for 1 hour, stirring occasionally. Uncover and simmer until hocks are tender, about 30 to 40 minutes. Stir occasionally and add more water if necessary. Remove hocks and let them cool while preparing vegetables.

Peel carrot, cut in feed-tube lengths, then halve lengthwise. Cut celery in feed-tube lengths then halve lengthwise. Peel potato, halve crosswise then quarter halves lengthwise. Insert slicing disc. Stand vegetables upright in feed tube and slice with medium to firm pressure. Reserve.

Puree soup with metal blade until smooth, about 15 seconds. Return to pot. Remove meat from hocks and pulse until coarsely chopped, 4 to 6 pulses. Add to pot with vegetables. Cover and simmer until tender, stirring occasionally to prevent sticking. This will take about 20 minutes. Season to taste.

Hamburgers

Chop meat to the exact texture you want — *and* control the amount of fat. Our test kitchen finds 20% fat ideal — less than the usual supermarket mixture. Use boneless beef — round, chuck or any cut you choose. Before chopping it, trim off all membrane, gristle and fat. Reserve the fat, which will usually be more than you need. Cut the beef into 1-inch cubes and chill until slightly firm — usually 30 minutes in the freezer.

INGREDIENTS

3/4 pound *combined* meat and fat

If you don't have a kitchen scale, measure solidly packed beef cubes and solidly packed fat cubes in cups, *before* chilling them, as follows:

1-1/4 cups beef cubes
 1/4 cup fat cubes

Put beef and fat in work bowl and chop with metal blade. Pulse/chop a few times to start, then let machine run continuously, checking every 5 seconds to check consistency. Be very careful not to over-process.

Handle hamburger with a light touch. Remove work bowl from processor base and carefully take out metal blade. Use as little pressure as possible in shaping patties.

Meatloaf or Meatballs

For a spicier meat loaf, add a few drops of Tabasco sauce and a teaspoon of Worcestershire sauce.

INGREDIENTS

1 small onion, quartered
 1/4 cup loosely packed parsley leaves
 1 slice day-old bread, broken in pieces
 3/4 pound boneless chuck, cut in 1-inch pieces*
 1-1/2 tablespoons milk*
 1/2 teaspoon salt
 1/8 teaspoon dried thyme leaves
 1 large egg

3/4 *pound of meatloaf*

Put all ingredients except egg in work bowl and pulse/chop 4 to 6 times. Then process continuously until chopped fine. Add egg and pulse 4 or 5 times or until desired consistency is reached, watching carefully to avoid overprocessing. Pack mixture into loaf pan and bake at 350°F until cooked through, about 40 to 50 minutes.

*You can vary these ingredients by using a mixture of beef, veal and pork or replacing the milk with tomato juice.

Variation: Instead of making a meat loaf, shape mixture into balls of 2 tablespoons each, arrange them in single layer in baking dish and bake at 375°F for about 25 minutes.

Chili

Kids love chili and it's a versatile dish. Serve it on hot dogs, fill tacos with it or eat it plain. This one freezes well for about 6 months.

INGREDIENTS

3	medium garlic cloves
1	medium onion
1	pound boneless beef chuck, chilled
1-1/2	teaspoons whole cumin seed
2	tablespoons vegetable oil
2	tablespoons chili powder
2	tablespoons paprika
1	teaspoon salt
1/8	teaspoon crushed red peppers
1	8-ounce can whole tomatoes
1	cup water
2	cups red kidney bean

4-1/2 cups yield

Peel garlic and onion; quarter onion. Process both with metal blade until finely chopped, about 15 seconds. Remove and reserve. Trim beef of all fat and cut it into 1-inch cubes. Process until coarsely chopped, about 10 to 12 pulses.

Brown cumin in saucepot over medium heat. Shake pan constantly and cook until cumin begins to smoke, about 1 minute. Remove and reserve.

Heat vegetable oil in same saucepot over medium heat. Add garlic and onions and cook for 2 minutes. Add beef and cook, stirring often, until no pink color remains, about 5 minutes.

Reduce heat to low, stir in cumin, chili powder, paprika, salt and red peppers and cook uncovered for 5 minutes, stirring occasionally.

Use metal blade to chop tomatoes coarse, pulsing twice. Add to saucepot with water and bring to boil. Reduce heat and simmer, partially covered, over medium-low heat for 45 minutes, stirring occasionally.

Stir in the beans and cook until heated through. Taste and add salt, if needed.

Try some of these garnishes with the chili: shredded Cheddar or Monterey Jack cheese, shredded lettuce, sliced jalapeno peppers, sliced scallions, sliced black olives, chopped tomato or chopped avocado.



Sausage

When you make your own sausage, you're in control of the ingredients. These sausages have no additives and less than the usual amount of fat.

INGREDIENTS	
1/2	pound pork or beef, cut in 1-inch cubes and chilled
3	ounces pork or beef fat, cut in 1-inch cubes and chilled
1	tablespoon cold water
3/4	teaspoon salt
1/2	teaspoon dried sage
1/8	teaspoon dried thyme
1/8	teaspoon pepper
	Flour
3/4	<i>pound, approximate yield</i>

Put all ingredients except flour in work bowl and chop with metal blade. Pulse/chop to start, then let machine run continuously, stopping every 5 seconds until desired texture is reached.

Shape mixture into cylinder 2 inches in diameter. Wrap in plastic wrap or foil and refrigerate for 3 hours or overnight. Cut into 1/2 inch slices and cook, or wrap individually and freeze.

To cook, coat each patty with flour. Place patties in cold skillet and cook over moderate heat until browned. Turn and cook second side over medium to low heat, allowing 15 to 20 minutes total cooking time.

Farmhouse Hash

If you don't have a kitchen scale, measure in cups — 2-1/4 cups of tightly packed meat cubes weigh about a pound.

INGREDIENTS	
4	tablespoons unsalted butter
1	small onion, peeled and halved
1/2	pound leftover meat, cut in 1-inch pieces
1/2	pound cooked potatoes, cut in -inch pieces
	Salt and freshly ground pepper
1/4	cup beef or chicken stock
3	<i>servings</i>

Melt half the butter in a heavy skillet. Use metal blade to pulse/chop onion until it is finely chopped, 8 to 10 pulses. Saute onion in skillet until soft but not brown, about 5 minutes. Reserve.

Use metal blade to process beef until coarsely chopped. Add potatoes, salt, pepper and sauteed onions and pulse only until potatoes are coarsely chopped.

Heat remaining butter in skillet over medium heat. Add hash, pour stock over all and pat down gently with spatula. Cook over low heat for 20 to 25 minutes, turning mixture over with spatula as crust forms on bottom. Transfer to warm serving plate.

Chicken and Vegetable Stir-Fry

Stir-frying and the food processor are a most effective combination to put a meal on the table in no time.

INGREDIENTS

2	red peppers, cored, seeded, stemmed and cut vertically into 3 slabs
6	scallions, cut to fit feed tube horizontally
2	zucchini, cut to fit feed tube horizontally
1	yellow squash, cut to fit feed tube horizontally
1	garlic cloves, peeled
1	1-inch pieces fresh ginger
2	pounds boneless chicken breasts
1/3	cup water
2	tablespoons dry Sherry
3	tablespoons soy sauce
2	teaspoons Oriental sesame oil
1/4	teaspoon black pepper
2	teaspoons cornstarch
3	tablespoons vegetable oil
6	<i>servings</i>

Split chicken breasts lengthwise. Tuck ends under to form compact shapes of uniform thickness. Wrap individually and freeze on baking sheet until firm to the touch but easily pierced with the tip of a sharp knife.

Stand peppers on long ends and use slicing disc to slice them, using light pressure. Lay scallion pieces in feed tube horizontally and slice into slivers, using light pressure.

Insert shredding disc and zucchini and squash, using light pressure. Remove and reserve vegetables.

Use metal blade to chop garlic and ginger fine, about 4 pulses. Do not empty work bowl. Insert slicing disc. Stand chicken pieces tightly in feed tube and slice, using firm pressure. Remove and reserve on plate, loosely covered with plastic wrap.

Use metal blade to mix water, Sherry, soy sauce, sesame oil, ground pepper, and cornstarch until smooth, about 15 seconds. Remove metal blade, leaving contents in work bowl.

Heat vegetable oil in skillet over high heat until very hot. Add chicken pieces and cook, stirring vigorously, until chicken is opaque, about 3 minutes.

Add vegetable mixture and stir-fry over medium-high heat until crisp-tender, about 2 minutes. Add sauce mixture. Cook, stirring, until sauce thickens, about 1 minute. Serve over brown or white rice.



Crab Cakes

These delicate seafood cakes are perfect with drinks. If you're feeling festive, substitute cooked lobster meat for half of the crabmeat.

INGREDIENTS	
4	slices white bread, lightly toasted
1	medium garlic clove, peeled
1	small onion, peeled and quartered
1	tablespoon unsalted butter
1	tablespoon parsley leaves
1	pound lump crabmeat, picked over to remove cartilage
1/4	cup mayonnaise
1	large egg
1	tablespoon lemon juice
1/4	teaspoon salt
	Tartar sauce (see recipe on page 38)
54	<i>1/2-ounce crab cakes</i>

Preheat oven to 375oF. Break bread in quarters and process with metal blade to fine crumbs, about 40 seconds. Reserve 1/4 of crumbs and put remainder in pie plate.

Drop garlic through feed tube with machine running and process until finely chopped, about 10 seconds. Add onion and chop fine, about 10 seconds. Cook mixture in the butter over low heat until golden brown, stirring, about 10 minutes.

Chop parsley fine, about 5 seconds. Add onion mixture, crabmeat, mayonnaise, egg, lemon juice, salt and reserved bread crumbs and pulse until combined, about 8 times.

Form mixture into 1-1/2-inch cakes by generous teaspoon measures. Coat them with crumbs in pie plate and place on buttered baking sheet. (Recipe may be prepared ahead to this point and refrigerated up to 4 hours.) Bake in preheated oven until golden brown, 10 to 15 minutes. Serve with Tartar Sauce.

Broccoli Puree

Broccoli is high in fiber, high in potassium and low in calories. This recipe uses the stems, which are often discarded.

INGREDIENTS	
1	bunch broccoli, about 1-1/2 pounds
1	small onion, peeled
2	tablespoons butter
1	teaspoon lemon juice
	Salt and pepper to taste
2-1/2	<i>cups yield</i>

Remove stems from broccoli and reserve florets. Use slicing disc to slice stems and onion. Cook sliced vegetables in boiling water to cover with 1/2 reserved florets until tender, about 6 to 8 minutes. Drain, reserving liquid.

Use metal blade to puree solids with remaining ingredients until smooth, about 1 minute.

Cut reserved florets into smaller florets and cook in reserved liquid until tender, about 3 minutes. Remove with slotted spoon. Pour enough hot cooking liquid into work bowl to reach desired consistency, then pulse in florets. Season to taste. Or serve the florets on a bed of pureed broccoli.

Mashed Potatoes

The shredding disc processes cooked potatoes to the right texture. Be careful not to over process when you mix them with the other ingredients.

INGREDIENTS	
1/4	cup hot milk
2	tablespoons butter, in pieces
1/2	teaspoon salt
	Freshly ground pepper
	Pinch of nutmeg (optional)
3	large potatoes, peeled, boiled and drained
4	<i>servings</i>

Put all ingredients except potatoes in work bowl and insert shredding disc. Process potatoes and leave them in work bowl. Remove shredding disc and carefully insert metal blade. Pulse 2 or 3 times, until liquid is absorbed. Potatoes will become gluey if you overprocess.

Wonderfully light, fluffy mashed potatoes can also be made with the optional Whisk Attachment (DLC-155).

Potatoes au Gratin

You can use baking or boiling potatoes for this substantial yet elegant dish.

INGREDIENTS	
3	ounces Gruyère cheese, cut in cubes
2	medium garlic cloves, peeled
1	medium onions, peeled and quartered
2-1/2	cups milk or half-and-half
1	teaspoons salt
	Freshly ground white pepper
3	large potatoes (about 10 ounces each), peeled and cut flat at ends
2-quart	baking dish
8	<i>servings</i>

Preheat oven to 400°F and butter baking dish. Chop cheese with metal blade until it is finely grated. Remove and reserve it. Drop onion and garlic through feed tube while machine is running and process until finely chopped. Put onion/garlic mixture in saucepan with milk, salt and pepper.

Shred potatoes with shredding disc, one at a time, using firm pressure on pusher. Add shredded potatoes to saucepan and bring mixture to a boil, stirring continuously to prevent scorching.

Remove saucepan from heat and spread potato mixture in prepared baking dish. Sprinkle with reserved cheese and bake for 25 minutes or until potatoes are tender and cheese is golden. Let stand for 10 minutes before serving.





Shredded Carrots and Zucchini

Because shredded vegetables cook so quickly, all their natural flavor and crispness is preserved. If you like, substitute an equal amount of parsnips for zucchini.

INGREDIENTS	
3	medium carrots (about 2 ounces each)
2	medium zucchini (about 4 ounces each)
1/4	cup unsalted butter
	Salt and pepper to taste
1/2	teaspoon chopped fresh tarragon or 1/4 as much dried (optional)
4	<i>servings</i>

Peel carrots and cut them and unpeeled zucchini to fit feed tube horizontally. Process with shredding disc.

Melt butter in large skillet. Add shredded vegetables and sprinkle with a little salt and pepper. Cover and cook until just tender, 2 or 3 minutes.

Season with tarragon, salt and pepper to taste.

Sliced Tomatoes on Shredded Lettuce

You can prepare all the elements of this salad in the work bowl.

INGREDIENTS	
1/4	cup parsley leaves, loosely packed
1	medium shallot, peeled
1-1/2	tablespoons red-wine vinegar
4-1/2	tablespoons safflower oil
1/2	teaspoon Dijon-style mustard
1/2	teaspoon sugar
1/2	teaspoon salt
	Freshly ground black pepper
4	firm, ripe, medium tomatoes, cored and cut flat at ends
1	medium head romaine lettuce
6	<i>servings</i>

Use metal blade to chop parsley and shallots fine. Add all remaining ingredients, except tomatoes and lettuce, through the feed tube opening while the machine is running. Remove metal blade and insert slicing disc.

Slice tomatoes into dressing, using light pressure.

Cut lettuce into sections to fit feed tube. Use slicing disc to slice it, using medium pressure.

Transfer contents of work bowl to platter, arranging tomatoes over lettuce in an attractive pattern.

TIP: When preparing a meal, make the dishes with the least amount of wet ingredients first. For example, make the bread first, then you don't need to wash the bowl before making the salad. In many cases, wiping the bowl with a paper towel between recipes is sufficient.

Creamy Cole Slaw

Cole slaw only takes minutes to prepare when you don't have to slice the cabbage by hand.

INGREDIENTS

1/4	cup loosely packed parsley leaves
1	1-ounce piece peeled onion
1/3	cup mayonnaise
1/2	tablespoon red-wine vinegar
1/4	teaspoon salt
1/4	teaspoon freshly ground pepper
1/2	large carrot, peeled
1/2	medium head green cabbage, about 2 pounds

5 *cups yield*

Process parsley with metal blade until minced. Add onion and process until minced. Add all remaining ingredients except carrot and cabbage and process 5 seconds to combine. Remove metal blade.

Cut carrot in half crosswise. Core cabbage and cut it into wedges. Insert shredding disc and shred carrot, using firm pressure. Insert slicing disc and slice cabbage, using firm pressure. Add contents of work bowl to mixing bowl and toss to combine. Adjust seasoning. Serve immediately or refrigerate for up to 24 hours. Before serving, drain excess liquid and adjust seasoning. Serve chilled.

Shredded Carrot Salad

The brilliant color of carrots and peas make this fresh and simple salad a welcome addition to a party buffet table.

INGREDIENTS

2	pounds young carrots, peeled
3	large scallions, trimmed
1/4	cup fresh lemon juice
1/4	cup vegetable oil
1	teaspoon salt
1	teaspoon sugar
	Pinch of cinnamon
	Pinch of allspice
	Freshly ground black pepper
1/2	cup cooked peas, fresh or frozen

8 *servings*

Cut carrots in lengths to fit feed tube horizontally and parboil them in salted water until you can just pierce them with the tip of a sharp knife, about 3 to 5 minutes. Drain them and rinse under cold water. When they are cool, blot dry with paper towels.

Cut scallions into 1-inch pieces and process scallions with metal blade until they are finely chopped. Add lemon juice, oil, salt, sugar, cinnamon, allspice and pepper and process for about 3 seconds. Leave the dressing in the work bowl.

Insert shredding disc, pack carrots lengthwise in feed tube and shred, using medium pressure. Transfer contents of work bowl to serving bowl, add peas and toss gently to coat all ingredients with dressing. Serve cold or at room temperature. Adjust seasoning just before serving.



Pesto

A classic pasta sauce from Italy. One cup is enough for 1 pound of pasta. It's also good on boiled potatoes or in soups.

INGREDIENTS

3	ounces imported Parmesan cheese, at room temperature, in 1-inch pieces
3	small garlic clove, peeled
2	cups tightly packed fresh basil leaves
1/4	cup pine nuts
1/2	teaspoon salt
1/4	cup olive oil
1	<i>cup yield</i>

Use metal blade to chop cheese and garlic, about 30 seconds. Add remaining ingredients except oil and process until combined, about 8 pulses. With machine running, pour oil through feed tube. Process until combined, about 10 seconds. Scrape down bowl and continue processing until smooth, about 20 seconds.

This keeps for up to 5 days in the refrigerator and it also freezes well. Some people prefer to omit the cheese when freezing pesto and add it just before serving.

Mexican Salsa

Serve this sauce as a topping for tacos, or with grilled fish or chicken. It is best when fresh; it may become slightly bitter after standing a day.

INGREDIENTS

1-1/2	jalapeno peppers
1/2	medium onion
1/3	cup packed cilantro leaves*
1/8	teaspoon salt
2	teaspoons lime juice
3	medium tomatoes, cored and quartered
2	<i>cups yield</i>

Cut peppers in half lengthwise, remove and discard stems, seeds and membranes. (Handle hot peppers with care. Their oil may irritate your skin and cause your eyes to sting. Wash hands after handling them.) Peel and quarter onion.

Use metal blade to process peppers and cilantro until finely chopped, about 20 seconds. Scrape bowl, add salt and lime juice and pulse twice.

Add tomatoes and onions and pulse until they are coarsely chopped, about 10 to 12 times.

Transfer to serving dish, stir and serve within 1 or 2 hours.

*Substitute flat-leaf parsley if cilantro is not available.

Basic Mayonnaise

For a classical mayonnaise, as thick as butter, substitute 2 egg yolks for each whole egg.

INGREDIENTS	
1	large egg
1	tablespoon fresh lemon juice or wine vinegar
1	tablespoon mustard, preferably Dijon-style
1-1/4	cups oil*
1-1/2	<i>cups yield</i>

Use metal blade to process egg, lemon juice or vinegar, mustard and 1 tablespoon oil in work bowl for 60 seconds. While machine is running, pour 1/4 cup of oil into small pusher. (Do not put in more than this or it will dribble through too quickly.) When it has dribbled through hole in bottom of small pusher, remove small pusher from feed tube and gradually add remaining oil, while machine continues to run. Mayonnaise will thicken as oil is added. Taste and adjust seasoning if necessary.

*You can use one oil or a combination, about 20% light olive oil to 80% vegetable oil, for example.

Low cholesterol variation: Substitute 2 tablespoons of Egg Beaters[®] for the egg, omit vinegar, increase salt and add pepper. Proceed as above.

Herb Mayonnaise: Add 1/4 cup tightly packed fresh green herbs when you put in the egg. Recommended herbs are parsley, dill and tarragon, with stems removed.

Tartar Sauce: Triple the amount of lemon juice. When mayonnaise is finished, add these ingredients: 3 small gherkins, 1/4 small onion, 1 tablespoon capers, 1 tablespoon bottled horseradish and 3 drops Tabasco sauce. Process until gherkins and onion are chopped fine, about 10 seconds.

No-Cook Cranberry-Orange Relish

Because this is an uncooked relish, it requires only 1 cup of sugar to sweeten 1 pound of cranberries. Most cooked relishes call for 2 cups.

INGREDIENTS	
2	cups fresh cranberries
1/2	navel orange, unpeeled and quartered
1/2	cup sugar
1-3/4	<i>cups yield</i>

Use metal blade to chop cranberries and oranges until coarsely chopped, about 8 to 10 pulses. Add sugar and process to mix, about 20 seconds. Taste and add more sugar if desired. Refrigerate in airtight container.



Chocolate Sauce

You can make a delicious chocolate sauce in your work bowl in 1 minute! No more worries about melting chocolate on top of the stove.

INGREDIENTS	
5	ounces semi-sweet chocolate, broken into 1/2-inch pieces
1/4	cup super-fine sugar
1/3	cup water, heated to boiling
7/8	<i>cup yield</i>

Use metal blade to chop chocolate and sugar until coarsely chopped, about 6 pulses. Then process continuously until chopped to a fine powder, about 60 seconds. With machine running, slowly pour hot water through feed tube. Process until chocolate melts, about 45 seconds, stopping once to scrape down bowl.

Mint variation: Add 1 tablespoon of peppermint extract, creme de menthe or peppermint schnapps to water after it is heated.

Raspberry Sauce

A fine finish for any fruit or chocolate dessert: ice cream, sherbet or cake. You can substitute strawberries for the raspberries.

INGREDIENTS	
1	10-ounce package frozen raspberries in syrup, thawed
1	tablespoon honey
1	<i>cup yield</i>

Use metal blade to puree raspberries and honey for 30 seconds. Transfer to fine sieve over bowl. Press solids through with back of spoon and discard seeds in sieve. Serve at room temperature or warm slightly to serve over ice cream.

Basic Pastry

This is the basic dough for pies, tarts and quiches.

INGREDIENTS	
1-1/2	cups all-purpose flour
1	stick very cold unsalted butter, in 1-inch pieces
1/2	teaspoon salt
1/4	cup ice water
1	<i>11-inch pie shell</i>

Use metal blade to process flour, butter and salt until mixture is like coarse meal, about 8 seconds. Add ice water and pulse until dough begins to clump together. Do not let it form a ball. Put dough in a plastic food storage bag. Work through bag to press dough together into a ball, then a flat disc.

Refrigerate dough for at least 1 hour.

Roll dough on lightly floured surface to a circle about 1/8 inch thick. Press into place in pie pan. Use kitchen shears to trim dough, leaving 1-inch overlap beyond pan. Fold overlap under. Pinch crust to form decorative edge. Prick bottom and sides with fork and refrigerate crust for 30 minutes, or until firm.

Preheat oven to 400°F 15 minutes before baking.

Line pie shell with parchment paper and fill it with uncooked beans or rice. Bake it for 12 minutes. Remove paper, beans or rice, prick shell again and bake it 6 minutes longer, or until it is lightly browned. Remove shell from pan and let cool on wire rack.

Fruit Tart:

To make a one-crust tart, use a tart pan instead of a pie pan. When cooked shell is thoroughly cool, spread about 1 cup of pastry cream (see recipe) on the bottom. Arrange sliced fresh fruit decoratively on top.

QUICK BREAD, YEAST BREAD AND PIZZA

42

Corn Bread

This is a particularly moist and flavorful corn bread which is best served warm.

INGREDIENTS

3	tablespoons butter
3/4	cup yellow cornmeal
3/4	cup all-purpose flour
1-1/2	tablespoons sugar
2	teaspoons baking powder
1/4	teaspoon baking soda
1/4	teaspoon salt
1	cup buttermilk
1	large egg
1/3	cups fresh, frozen or canned corn kernels

8x8 *pan size in inches*

Preheat oven to 425°F. Melt butter in baking pan.

Use metal blade to process all dry ingredients until combined, about 10 seconds. Add butter and remaining ingredients except corn kernels and process until mixed, about 5 seconds. Scrape down work bowl and gently stir in corn.

Pour into prepared pan and bake until a toothpick inserted in center comes out clean, about 25 minutes.

Muffin Variation: For corn muffins, pour batter into greased, standard-size muffin tins, filling them 3/4 full. Bake in preheated 425°F oven for about 25 minutes. Makes 6 muffins.

Coffee Cake

This makes an excellent breakfast, or adds a sweet flavor to lunch or supper.

INGREDIENTS

1	package dry yeast
2	tablespoons sugar
1/4	cup warm water
1/3	cup sour cream
1/4	cup cold milk
1	large egg
1	teaspoon vanilla
3	cups flour
1/4	cup butter
1/2	teaspoon salt

Filling

2	tablespoons melted butter
1/2	cup light brown sugar
1/2	cups raisins or dates, cut in 1-inch pieces
1/2	cup pecans
1	teaspoon cinnamon

To make the dough, dissolve the yeast and half the sugar in warm water in a 2-cup liquid measure. Let stand until foamy. Whisk together the sour cream, milk, egg, and vanilla extract and add to the yeast mixture.

Use metal blade to process flour, butter, salt and remaining sugar for 10 seconds. With machine running, add liquid ingredients through feed tube in steady stream as fast as flour absorbs them. After dough cleans inside of work bowl, continue processing 40 seconds more to knead it.

Shape dough into ball and place it in lightly floured plastic food storage bag. Squeeze out air and close top with wire twist. Let rise in warm place until double, about 1 hour.

Roll dough on lightly floured surface to rectangle about 20 inches long and 12 inches wide. Brush with

melted butter. With remaining butter, brush inside of 9x13-inch pan.

To make filling, use metal blade to process sugar, dates or raisins, pecans, and cinnamon until coarsely chopped, about 45 seconds. Spread filling over dough. Roll dough up, jelly-roll fashion, from long side. Use sharp knife to cut rolled dough into 3/4-inch slices. Place slices in pan, cut sides up, and let rise until doubled.

Preheat oven to 375°F and bake coffee cake until golden and bubbly, about 20 to 25 minutes.

White Bread

It's best to make this bread with bread flour, or unbleached flour, or a combination of both. Bread made with bread flour will rise higher in the oven.

INGREDIENTS

1	package dry yeast
1/3	cup warm water
2	teaspoons sugar
4	cups white flour
3	tablespoons unsalted butter, in tablespoon-size pieces
1	teaspoon salt
1	cup ice water
2	<i>1-pound loaves</i>

Stir yeast and sugar into warm water in 2-cup measure and let stand until foamy, 3 to 5 minutes. Use dough blade to process flour, butter and salt for 20 seconds. Add ice water to yeast mixture.

With machine running, pour liquid through feed tube in steady stream, only as fast as flour absorbs it. Continue processing until dough cleans inside of work bowl and forms a ball. Then let machine run for 60 seconds to knead dough.

Shape dough into ball and place in lightly floured plastic storage bag. Squeeze out air and close end with wire twist, allowing space for dough to rise. Let rise in warm place until dough has doubled in bulk, about 1 to 1-1/2 hours.

Punch dough down and shape into 2 loaves. Place each in greased 4-cup loaf pan. Cover with oiled plastic wrap and let rise in warm place until dough just rises above top of pan, about 45 minutes. Bake in middle rack of preheated 375°F oven until top is brown, about 35 minutes. Remove from pan and cool on wire rack.

Whole Wheat Variation: Replace 1/2 of white flour with an equal amount of whole wheat flour.





Basic Pizza Dough

With this dough, you can make large pizza crusts to serve several, or small ones to serve a few.

INGREDIENTS	
1	package active dry yeast
1	teaspoon sugar
2/3	cup warm water
1-2/3	cups all-purpose flour
3/4	teaspoon salt
2	teaspoons oil
	Vegetable oil for pan
1-1/2	tablespoons cornmeal for pan
1	<i>14-inch pizza crust OR</i>
2	<i>9-inch pizza crusts</i>

Stir yeast and sugar into warm water and let stand until foamy, about 10 minutes. Insert metal blade, put flour and salt in work bowl and turn on machine. Pour yeast mixture through feed tube and process about 45 seconds, until dough pulls away from sides of bowl. Add oil through feed tube and process 60 seconds longer.

If dough sticks to sides of bowl, add more flour, 1 tablespoon at a time, processing for 10 seconds after each addition, until dough leaves sides of bowl but remains soft.

Roll dough on floured surface into circle, rotating and turning dough often and using enough flour so it doesn't stick. If dough resists rolling, let it rest for a few minutes and try again. Roll dough into 15-inch circle for flat 14-inch pizza pan, or into 10-inch circles for flat 9-inch pizza pans.

Oil pan(s) lightly and sprinkle with cornmeal. Fold rolled dough in half loosely and then in half again. Position point at center of pan and gently unfold. Press into place from center outward, turn under the 1-inch overhang and shape it into a rim. Crust(s) is now ready to bake and fill.

Pizza in a Hurry

It takes no longer to make this pizza than to wait for one you order to take out.

INGREDIENTS	
1	14-ounce pizza crust (see recipe, left)
4	ounces Parmesan cheese, at room temperature
2	ounces pepperoni, peeled, in 3 pieces
12	ounces Mozzarella cheese, very cold
1	small onion, peeled, ends cut flat
1	medium green pepper, cored, seeded and cut flat at stem
1	medium tomato, cored, cut flat at ends
1	cup Tomato Pizza sauce (see recipe, right)
	Pinch of sugar
	Freshly ground black pepper
1/2	teaspoon dried basil or 1 teaspoon fresh
1/2	teaspoon dried oregano or 1 teaspoon fresh

Preheat oven to 425°F and place rack in lower third. Bake pizza crust for 6 minutes. In the meantime, prepare filling.

Use metal blade to process Parmesan cheese and pepperoni until coarsely chopped. Set aside on dish or waxed paper.

Insert shredding disc and process Mozzarella cheese. Set aside.

Insert slicing disc and slice onion. Set aside. Slice green pepper and set aside. Slice tomato, using light pressure. Set aside on paper towels to drain.

Use rubber spatula to spread tomato sauce evenly over crust, leaving rim exposed. Separate each onion slice into rings and distribute them over sauce. Distribute shredded Mozzarella over onions. Arrange tomato slices over cheese and sprinkle with pinch of sugar and pepper.

Distribute Parmesan cheese and pepperoni mixture, then green pepper slices, over tomatoes. Sprinkle evenly with basil and oregano. Return pizza to oven and bake for 18 minutes, or until rim of crust is golden and bottom is deep brown.

Tomato Pizza Sauce

When this sauce stands, liquid may accumulate on surface. Pour off all but 2 tablespoons, then stir well before using.

INGREDIENTS	
2	large tomatoes, peeled, seeded and quartered
1	cup canned tomato sauce
1/4	cup canned tomato paste
3/4	teaspoon dried oregano or 1-1/2 teaspoons fresh
3/4	teaspoon dried basil or 1-1/2 teaspoons fresh
1	teaspoon sugar Salt and freshly ground black pepper
2	<i>cups yield</i>

Use metal blade to pulse/chop tomatoes about 6 times, until coarsely chopped. Add remaining ingredients and pulse 4 times to mix.

Fudgy Brownies

These easy-to-make brownies are always a favorite in lunch boxes or for after-school snacks.

INGREDIENTS	
3	ounces unsweetened chocolate
1	cup light brown sugar
1/3	cup butter, melted
3	large eggs
1	teaspoon vanilla extract
2/3	cup flour
1/4	teaspoon salt
1	teaspoon baking powder
1/2	cup pecan halves
8x8	<i>inch pan</i>
16	<i>brownies</i>

Preheat oven to 350°F. Grease pan.

Break chocolate into 1-inch pieces. Use metal blade to chop with half the sugar until coarsely chopped, 6 to 8 pulses. Then process continuously until finely chopped, about 20 seconds.

With machine running, pour hot butter through feed tube. Process until smooth, about 30 seconds. Add remaining sugar, eggs and vanilla. Pulse twice, then process 10 seconds more. Add dry ingredients and nuts. Pulse/chop until mixed, 6 to 8 times. Spread in prepared pan.

Bake until lightly crusty and moist inside, about 20 minutes. Cool and cut into squares.

Chocolate Chip Oatmeal Cookies

Toasted nuts and oatmeal make these cookies good for you as well as delicious.

INGREDIENTS

1/2	cup quick-cooking oatmeal
3/4	cup pecans
3/4	cup butter
1/3	cup sugar
1/2	cup firmly packed light brown sugar
1	large egg
3/4	teaspoon vanilla extract
1	cup flour
1/2	teaspoon salt
3/4	teaspoon baking soda
6	ounces semi-sweet chocolate chips
35	<i>2-1/2-inch cookies</i>

Preheat oven to 350°F and place rack in center. Toast oatmeal and pecans on baking sheet until lightly browned, about 10 minutes. Remove and reserve. Turn oven up to 375°F.

Cut butter into 1-inch pieces. Use metal blade to process with both sugars until smooth, about 2 minutes. Scrape work bowl as necessary. Add egg and vanilla and pulse until just mixed, about 6 times.

Add pecans, flour, salt, baking soda, and half the oatmeal. Pulse until mixed, about 8 times. Remove to large bowl, add remaining oatmeal and chocolate chips and stir to mix. Drop by rounded teaspoonfuls onto greased baking sheets 1 inch apart and bake until golden brown, about 11 minutes.

Carrot Cake

To make this delicious, moist cake look really professional, put a marzipan carrot in the center. You can buy them at many pastry or candy shops.

INGREDIENTS

	Fine, dry bread crumbs, for dusting pans
1/2	pound carrots
1/2	cup granulated sugar
1/2	cup firmly packed dark brown sugar
2	large eggs
1/2	cup corn oil
1	teaspoon vanilla
3/4	cup walnut pieces
1	cup all-purpose flour
1	tablespoon unsweetened cocoa
1	teaspoon baking powder
1	teaspoon cinnamon
1/2	teaspoon baking soda
1/2	teaspoon salt
1/2	cup raisins, steamed over boiling water for 10 minutes
	Cream Cheese Frosting (recipe follows)

2 8-inch *round cake pans*
6 to 10 *servings*

Preheat oven to 350°F. Butter cake pans, line bottoms with parchment paper and butter paper. Dust pans with bread crumbs.

Cut carrots into lengths to fit feed tube horizontally. Use shredding disc to shred carrots and reserve them.

Process sugars, eggs, oil and vanilla with metal blade until smooth, about 15 seconds. Add walnuts and dry ingredients and pulse until combined, about 6 times, stopping once to scrape down work bowl. Use spatula to stir in raisins and carrots.

Divide batter between prepared pans and bake in preheated oven until a cake tester inserted in the center comes out clean, about 35 to 40 minutes. Cool in pans

for 2 to 3 minutes and turn out onto wire racks to cool completely. Remove paper.

Spread frosting between layers and on top and sides of cake.

Cream Cheese Frosting

This quick and easy frosting is delicious on carrot cake, but it's also good on many other cakes.

INGREDIENTS

1/2	pound cream cheese, in pieces
1/2	stick butter, in pieces
1	cups confectioner's sugar
1/2	teaspoon vanilla extract

2 8-in. *frosts layers listed at left*

Use metal blade to process cheese and butter until combined, about 10 seconds. Add sugar and process until smooth, about 5 seconds. Add vanilla and process until smooth, about 15 seconds.



Sherbet and Frozen Yogurt:

At least 5 hours before serving, prepare fruit by cutting it into 1-inch pieces. For frozen yogurts, freeze all of fruit in single layer on baking sheet. For sherberts, freeze 3/4 of fruit in same way and refrigerate remaining fruit.

A few minutes before serving, process frozen fruit and sugar with metal blade, pulsing about 8 times then processing continuously until fruit is finely chopped, scraping down work bowl and cover as necessary.

Add refrigerated fruit or yogurt and any additional ingredients called for in recipe. Process just until mixture become smooth and creamy, scraping down work bowl as necessary. Taste for sweetness, adding more sugar if necessary.

Sherberts and frozen yogurts are best when served immediately, but they may be frozen for later use. To prepare frozen mixture for serving, cut it into 1-inch chunks. Process with metal blade just until mixture becomes smooth and creamy.

Pear Yogurt

INGREDIENTS

3	medium pears
1/4	cup confectioners' sugar
1/2	cup yogurt
1	tablespoon lemon juice

Banana-Apple Sherbet

INGREDIENTS

2	small bananas
1	tablespoons confectioners' sugar
2	medium Golden Delicious apples
1-1/2	tablespoons lemon juice

Apple Pie

Use the basic pastry recipe and about 2 pounds of apples, peeled and cored.

To assemble the pie, use the metal blade to mix 1/2 cup sugar, 3/4 teaspoon cinnamon, 1/8 teaspoon salt, 1/8 teaspoon nutmeg and 3 tablespoons flour for 5 seconds.

Slice the apples into the sugar and spice mixture. Transfer the apples to the pie crust. Place second crust over the apples. Pinch crust edges together. With a sharp knife, make 6-8 small cuts in top crust to allow steam to escape. Bake in preheated 375° F oven until juices bubble, about 45 minutes.

CUISINART® PRO CLASSIC™ FOOD PROCESSOR THREE-YEAR LIMITED WARRANTY ON THE ENTIRE MACHINE.

FIVE YEAR FULL WARRANTY ON MOTOR

This warranty supersedes all previous warranties on Cuisinart® Pro Classic™ Food Processor.

This warranty is available to consumers only. You are a consumer if you are the owner of a Cuisinart® Pro Classic™ Food Processor that was purchased at retail for personal, family or household use. Except as otherwise required under applicable state law, this warranty is not available to retailers or other commercial purchasers or owners.

We warrant that your Cuisinart® Pro Classic™ Food Processor will be free of defects in material or workmanship under normal home use for three years from the date of original purchase.

We warrant that the motor for your Cuisinart Pro Classic™ Food Processor will be free of defects in material or workmanship under normal home use for five years from the date of original purchase. This motor warranty covers the motor and excludes all other parts in the motor base assembly area such as the upper and lower plastic housings, workbowl and cover, blades and all electrical components and vertical projecting motor shaft sheath.

We suggest that you complete and return the enclosed warranty registration card promptly to facilitate verification of the date of original purchase. However

return of the warranty registration card is not a condition of this warranty.

If your Cuisinart® Pro Classic™ Food Processor should prove to be defective within the warranty period, we will repair it, or if we think necessary replace it, without charge to you. To obtain warranty service, simply call our toll-free number 800-726-0190 for additional information from our Customer Service Representatives. Or send the defective product to Customer Service at Cuisinart, 150 Milford Road, East Windsor, New Jersey 08520. To facilitate the speed and accuracy of your return, please enclose a check or money order for \$10.00 shipping and handling. **DO NOT SEND CASH.**

Under California law, only proof of purchase is required. California residents should call 1-800-726-0190 for shipping instructions. If the problem with the machine is determined to be a defect of the motor within the warranty period all postage and handling charges will be refunded.

Please be sure to include a return address, daytime telephone number, description of the product defect, product serial number, original date of purchase, and any other information pertinent to the product's return.

Your Cuisinart® Pro Classic™ Food Processor has been manufactured to the strictest specifications and has been designed for use with the Cuisinart® Pro Classic™ Food Processor authorized accessories and replacement parts. This warranty

expressly excludes any defects or damages caused by accessories, replacement parts or repair service other than those that have been authorized by Cuisinart.

This warranty excludes all incidental or consequential damages. Some states do not allow the exclusion of or limitation of incidental damages, so this may not apply to you.

This warranty gives you specific legal rights, and you may have other legal rights which vary from state to state.

Warning:

Our Pro Classic™ Food Processor, Food Processors, and Accessories have been carefully designed and manufactured with the highest quality materials to assure your satisfaction and safety when you use them. Although accessories sold by companies other than Cuisinart may be compatible with your Cuisinart® machine, they may also be extremely dangerous, and expose the user to serious injury.

We specifically caution you not to use other brand accessories, such as juicers, which permit your machine to operate with exposed cutting of shredding discs. We also caution you not to use the large feed tube on this machine with machines built by other manufacturers.

If you have any questions about the safety feature of your Cuisinart® Pro Classic™ Food Processor or any other Cuisinart® product, please call us at the toll-free number that appears above.

© 2002 Cuisinart
Cuisinart® is a registered
trademark of Cuisinart
150 Milford Road
East Windsor, NJ 08520
Printed in China

U IB-2376C

Free Manuals Download Website

<http://myh66.com>

<http://usermanuals.us>

<http://www.somanuals.com>

<http://www.4manuals.cc>

<http://www.manual-lib.com>

<http://www.404manual.com>

<http://www.luxmanual.com>

<http://aubethermostatmanual.com>

Golf course search by state

<http://golfingnear.com>

Email search by domain

<http://emailbydomain.com>

Auto manuals search

<http://auto.somanuals.com>

TV manuals search

<http://tv.somanuals.com>