

DESCRIPTION

Specification grade, wet listed 71 watt MR16 lamp adjustable fixture. Adjustment mechanism features hot aiming capability, aiming marks and tool-less locking. Optics provide glare-free 50° cutoff to lamp and lamp image. For use with all halogen MR16 lamp varieties. Units small size is ideal for tight construction areas. Insulation must be kept 3" away from sides and top of fixture. **Optical element can be changed after installation to provide a variety of distributions. e.g. into a Downlight**

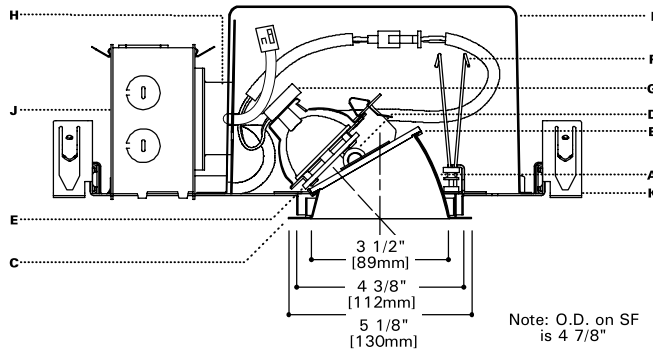

SPECIFICATION FEATURES

A...Reflector

.040 thick aluminum spun parabolic interior reflector in Clear, Gold, Haze, Warm Haze, Black Alzak® finish painted gloss white or matte white. Special cone colors listed below.

B...Glass

.125 thick tempered clear glass protects lamp from direct spray of water and is retained during relamping.

C...Flange

Self flange reflector or die-cast flange with either matte white or clear coat finish. Die-cast flanges are easily removed for field painting. Elements are keyed for proper insertion.

D...Adjustability

Removable lamp adjustment mechanism provides up to 45° tilt and 361° rotation and locks into any aiming position. Unit is relamped without unlocking adjustments. Translating centerbeam optics maximize light output.

E...Lens

Soft focus lens standard for smooth beam patterns. Up to two filter media can be used which are retained during relamping.

F...Attachment

Positive torsion springs pull flange tight to ceiling. Mechanical light trap eliminates spill light at edge of flange or reflector.

G...Socket

GX5.3 base for Bi-pin MR16 lamps. Back light shield keeps interior of fixture dark.

H...Transformer

Truvolt™ toroidal transformer with dual-output taps for proper 12.0V operation and quiet operation when dimmed. Dimmer tap compensates for inherent voltage loss from dimmers, resulting in 30% more lumens than traditional laminated transformers. Toroidal design, with 90% or greater efficiency, features a rolled one-piece continuous core of

M3 grade grain oriented silicon steel complete with an integral thermal to protect against overheating. For dimming, use dimmers rated for electromagnetic transformers. **Transformer is warranted for 5 years and is serviceable from below ceiling.**

Note: If a dimming system is operated for construction lighting in its "shunt" mode, i.e. bypassing the dimmer modules, for an extended period of time, fixtures with the dual-tap toroidal transformer should be operated on the "Switched Fixture" output until the dimmers are in use. Operating fixtures on the "Dimmed Fixture" output with a full 120v input for an extended period will overdrive the lamp and cause shortened lamp life.

I...Frame/Housing

Hot dipped galvanized 20 gauge steel frame with built in 1/2 inch plaster lip. Gunsights allow for consistent alignment.

J...Junction Box

18 cubic inches, listed for 4#12 AWG or 6#14 AWG 90° C additional feed through conductors, has three 1/2" pryouts.

K...Bar Hangers

No Flex® bar hangers with positive locking, for use with wood, engineered wood and steel frame joists spaced up to 24" O.C. ship with platform. For use in T-bar ceilings order accessory push on clips. Nailless barb and locator lip provide consistent installation height.

L...Codes

Thermally protected, IP labeled. Unit is airtight and exchanges less than 2.0 CFM with the plenum at a pressure of 75 pascals. Insulation must be kept three inches away from fixture sides and none on top as to entrap heat.

M...Labels

UL and cUL listed, standard wet label, IBEW union made

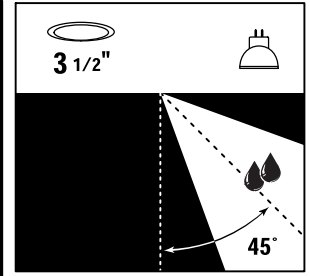

**PN3MR
E3AASR**

71 W MR16

**3" ADJUSTABLE
SHOWER**

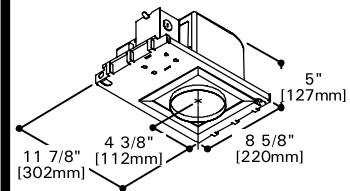

Ceiling Cutout:
4 3/8" [112mm]

ENERGY DATA

120V Input		
Lamp Watts	Input Watts	Operating Current
20	23	.19
35	41	.34
37	42	.35
42	47	.39
50	57	.48
65	70	.58
71	77	.64
75	81	.68

ORDERING INFORMATION

SAMPLE NUMBER: PN3MR-E3AASRC

Complete unit consists of a platform and element

Platform	Optical Element	Finish	Flange	Accessories	
PN3MR	E3AASR				
PN3MR = 3" Non-IC Low Voltage Housing	E3AASR = 3" MR16 0 - 45° Adjustable Accent Lensed Reflector	Standard C = Clear H = Haze G = Gold WMH = Warm Haze W = Gloss White B = Black MW = Matte	White Custom K = Cognac KH = Cognac Haze CC = Chocolate Custom CCH = Chocolate Haze	BU = Blush Custom Cont. BUH = Blush Haze GP = Graphite GPH = Graphite Haze PN = Pine PNH = Pine Haze SK = Sky SKH = Sky Haze	Blank = White die-cast SF = Self Flange SFWF = Self Flange Painted White RAW = Natural Die Cast MBCLP = 40 Push On T Bar Clips (for 10 Units) PLE3 = Plaster Lip Extension for Max 2" Thick Ceiling L-SPD = Spread Lens L-LNR = Linear Spread Lens L-LPINK = Light Pink Lens L-LSTRAW = Light Straw Lens L-27K = 2700K dichroic filter L-UV = UV Reduction Lens L-SPINK = Surprise Pink Lens L-PLAV = Pale Lavender Lens L-HEX = Hex Cell Louver

COOPER LIGHTING

For additional options please consult factory.

PHOTOMETRICS

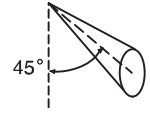
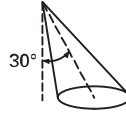
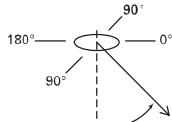

Lamp	Luminance cd/m ² @ Maximum Tilt	0° Aiming Angle Horizontal Footcandles				30° Aiming Angle Horizontal Footcandles					30° Aiming Angle Vertical Footcandles					45° Aiming Angle Vertical Footcandles							
		D	FC	L	W	D	FC	L	W	CB	D	FC	L	W	CB	D	FC	L	W	CB			
OS 65MR16Q/O/NSP/10 Beam Spread: 10° CBCP: 14,000		4'	618	0.7	0.7	4'	250	1	1	2.3	2'	220	1.2	0.8	3.5	2'	712	0.6	0.5	2.0			
		7'	202	1.1	1.1	7'	82	1.7	1.8	4.0	3'	98	1.9	1.3	5.2	3'	316	0.9	0.7	3.0			
		10'	99	1.6	1.6	10'	40	2.4	2.5	5.8	4'	55	2.5	1.7	6.9	4'	178	1.2	0.9	4.0			
		12' 6"	63	2	2	12' 6"	26	3	3.2	7.2	5'	35	3.1	2.1	8.7	5'	114	1.5	1.2	5.0			
			Test # H21269				Test # H21273					Test # H21273					Test # H21274						
OS 65MR16Q/40/FL Beam Spread: 40° CBCP: 2,100	Degree@ 180°@ 90°	D	FC	L	W	D	FC	L	W	CB	D	FC	L	W	CB	D	FC	L	W	CB			
	85°	0	1869	4'	130	2.3	2.3	4'	85	2.8	2.7	2.3	2'	104	2.1	1.9	3.5	2'	195	1.5	1.7	2.0	
	75°	629	629	7'	42	4	4	7'	28	5	4.7	4.0	3'	46	3.2	2.9	5.2	3'	87	2.3	2.5	3.0	
	65°	385	385	10'	21	5.8	5.8	10'	14	7.1	6.8	5.8	4'	26	4.3	3.9	6.9	4'	49	3.0	3.3	4.0	
	55°	852	568	12' 6"	13	7.2	7.2	12' 6"	9	8.9	8.4	7.2	5'	17	5.3	4.8	8.7	5'	31	3.8	4.2	5.0	
	45°	10367	2765	Test # H21263				Test # H21264				Test # H21264				Test # H21265							
GE Q50MR16C/NSP15 Beam Spread: 15° CBCP: 9,500	Degree@ 180°@ 90°	D	FC	L	W	D	FC	L	W	CB	D	FC	L	W	CB	D	FC	L	W	CB			
	85°	0	1869	4'	445	1	1	4'	291	1.2	1.2	2.3	2'	252	1.5	1.0	3.5	2'	639	0.8	0.7	2.0	
	75°	629	629	7'	145	1.8	1.8	7'	95	2.1	2.1	4.0	3'	112	2.2	1.5	5.2	3'	284	1.2	1.1	3.0	
	65°	385	385	10'	71	2.5	2.5	10'	47	3	3	5.8	4'	63	2.9	1.9	6.9	4'	160	1.6	1.5	4.0	
	55°	568	284	12' 6"	46	3.1	3.1	12' 6"	30	3.7	3.7	7.2	5'	40	3.7	2.4	8.7	5'	102	2.1	1.8	5.0	
	45°	3686	1382	Test # H21246				Test # H21243				Test # H21243				Test # H21244							
GE Q50MR16C/NFL25 Beam Spread: 25° CBCP: 3,000	Degree@ 180°@ 90°	D	FC	L	W	D	FC	L	W	CB	D	FC	L	W	CB	D	FC	L	W	CB			
	85°	0	1847	4'	174	1.6	1.6	4'	108	2	2.2	0	4'	27	4.5	3.4	6.9	6'	28	3.9	3.8	6	
	75°	622	622	7'	57	2.9	2.9	7'	35	3.5	3.8	0	6'	12	6.7	5.1	10.4	8'	16	5.2	5.1	8	
	65°	381	381	10'	28	4.1	4.1	10'	17	5	5.4	0	10'	4	11.2	8.5	17.3	10'	10	6.5	6.4	10	
	55°	561	561	12' 6"	18	5.1	5.1	12' 6"	11	6.2	6.7	0	12'	3	13.4	10.2	20.8	12'	7	7.8	7.7	12	
	45°	4099	1366	Test # H21185				Test # H21187				Test # H21193				Test # H21185							
GE Q50MR16C/FL40 Beam Spread: 40° CBCP: 1,700	Degree@ 180°@ 90°	D	FC	L	W	D	FC	L	W	CB	D	FC	L	W	CB	D	FC	L	W	CB			
	85°	0	0	4'	129	2.0	2.0	4'	66	2.8	2.8	2.3	2'	100	1.8	1.7	3.5	2'	159	1.5	1.6	2	
	75°	0	0	7'	42	3.4	3.4	7'	22	5.0	4.8	4.0	3'	45	2.7	2.5	5.2	3'	71	2.3	2.4	3	
	65°	0	0	10'	21	4.9	4.9	10'	11	7.1	6.9	5.8	4'	25	3.6	3.3	6.9	4'	40	3	3.2	4	
	55°	0	0	12' 6"	13	6.1	6.1	12' 6"	7	8.9	8.6	7.2	5'	16	4.5	4.1	8.7	5'	25	3.8	4	5	
	45°	0	1997	Test # H21204				Test # H21249				Test # H21199				Test # H21202				Test # H21203			
PH Q45MR16C/RC/SP8 Beam Spread: 8° CBCP: 16,000	Degree@ 180°@ 90°	D	FC	L	W	D	FC	L	W	CB	D	FC	L	W	CB	D	FC	L	W	CB			
	85°	0	821	4'	696	0.6	0.8	4'	342	1	0.9	2.3	2'	300	1.3	0.8	3.5	2'	722	0.7	0.7	2.0	
	75°	0	277	7'	227	1.1	1.4	7'	112	1.8	1.7	4.0	3'	133	2.0	1.2	5.2	3'	321	1.0	1.0	3.0	
	65°	0	169	10'	111	1.6	2	10'	55	2.5	2.4	5.8	4'	75	2.6	1.5	6.9	4'	181	1.3	1.3	4.0	
	55°	125	250	12' 6"	71	2	2.5	13'	32	3.3	3.1	7.2	5'	48	3.3	1.9	8.7	5'	116	1.7	1.6	5.0	
	45°	1316	2024	Test # H22402				Test # H21223				Test # H21227				Test # H21227				Test # H21228			
GE Q42MR16C/VNSP Beam Spread: 9° CBCP: 12,500	Degree@ 180°@ 90°	D	FC	L	W	D	FC	L	W	CB	D	FC	L	W	CB	D	FC	L	W	CB			
	85°	1849	1849	4'	498	0.5	0.8	4'	284	0.8	0.8	2.3	2'	261	1.0	0.7	3.5	2'	571	0.5	0.6	2.0	
	75°	623	623	7'	163	0.9	1.4	7'	93	1.4	1.4	4.0	3'	116	1.5	1.0	5.2	3'	254	0.7	1.0	3.0	
	65°	381	381	10'	80	1.2	2	10'	45	2.1	2	5.8	4'	65	2.0	1.4	6.9	4'	143	0.9	1.3	4.0	
	55°	281	0	12' 6"	51	1.6	2.5	12' 6"	29	2.6	2.5	7.2	5'	42	2.5	1.7	8.7	5'	91	1.2	1.6	5.0	
	45°	3190	2279	Test # H21210				Test # H21212				Test # H21211				Test # H21211				Test # H21210			
OS Q37MR16/IR/SP10 Beam Spread: 10° CBCP: 13,100	Degree@ 180°@ 90°	D	FC	L	W	D	FC	L	W	CB	D	FC	L	W	CB	D	FC	L	W	CB			
	85°	0	0	4'	681	0.6	0.8	4'	356	1	0.9	2.3	2'	303	1.3	0.7	3.5	2'	909	0.7	0.5	2.0	
	75°	0	0	7'	222	1.1	1.4	7'	116	1.7	1.5	4.0	3'	135	2.0	1.1	5.2	3'	404	1.0	0.7	3.0	
	65°	0	0	10'	109	1.6	2	10'	57	2.5	2.1	5.8	4'	76	2.6	1.4	6.9	4'	227	1.3	1.0	4.0	
	55°	284	284	12' 6"	70	1.9	2.5	12' 6"	36	3.1	2.7	7.2	5'	48	3.3	1.8	8.7	5'	145	1.6	1.2	5.0	
	45°	3225	2304	Test # H21250				Test # H21253				Test # H21254				Test # H21254				Test # H21255			
GE Q20MR16C/VNSP7 Beam Spread: 7° CBCP: 7,400	Degree@ 180°@ 90°	D	FC	L	W	D	FC	L	W	CB	D	FC	L	W	CB	D	FC	L	W	CB			
	85°	0	0	4'	312	0.5	0.5	4'	153	0.8	0.5	2.3	2'	150	0.9	0.5	3.5	2'	482	0.4	0.3	2.0	
	75°	0	0	7'	102	0.8	0.8	7'	50	1.4	0.9	4.0	3'	67	1.3	0.8	5.2	3'	214	0.6	0.5	3.0	
	65°	0	0	10'	50	1.2	1.2	10'	24	2.1	1.3	5.8	4'	38	1.7	1.0	6.9	4'	120	0.8	0.6	4.0	
	55°	0	0	12' 6"	32	1.5	1.5	12' 6"	16	2.6	1.7	7.2	5'	24	2.1	1.3	8.7	5'	77	1.0	0.8	5.0	
	45°	1152	1382	Test # H21237				Test # H21232				Test # H21234				Test # H21234				Test # H21237			

Notes and Definitions:

Luminance: To convert cd/m² to footlamberts, multiply by 0.2919

- Data is based upon bare lamps photometrics.
- Beam spread is to 50% center beam candlepower (CBCP.)

D = Distance to floor or wall.

FC = Footcandles on floor or wall at center beam aiming location.

L = Effective Visual Beam length in feet (50% of maximum footcandle level.)

W = Effective Visual Beam width in feet (50% of maximum footcandle level.)

CB = Distance across or down to center beam location..

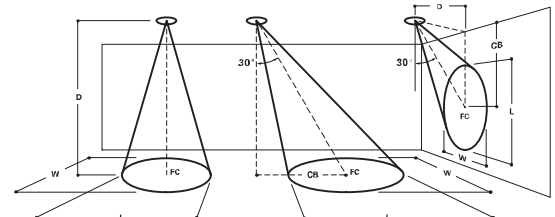

Note: Specifications and Dimensions subject to change without notice. Visit our web site at www.cooperlighting.com

Free Manuals Download Website

<http://myh66.com>

<http://usermanuals.us>

<http://www.somanuals.com>

<http://www.4manuals.cc>

<http://www.manual-lib.com>

<http://www.404manual.com>

<http://www.luxmanual.com>

<http://aubethermostatmanual.com>

Golf course search by state

<http://golfingnear.com>

Email search by domain

<http://emailbydomain.com>

Auto manuals search

<http://auto.somanuals.com>

TV manuals search

<http://tv.somanuals.com>