



Envoy

Parking Garage Luminaire

ENVOY



PARKING GARAGE LUMINAIRE

TABLE OF CONTENTS

Design Considerations	3
Innovation.....	4
Installation + Maintenance.....	5
Lamps + Egress Options	6
Mounting Configurations	7
Optical Versatility.....	9
Configurations + Layouts	11
Optical Renderings.....	15
Energy	16
Specification Features	19
Options.....	21
Ordering Information	22

LIGHTING SOLUTIONS

Parking structures are dynamic settings requiring special considerations in planning, construction and safety. In both day and evening conditions, safe and effective movement of pedestrian and vehicular traffic is the number one priority in designing for parking structures. Beyond the construction and code requisites, the element of human interaction, pleasantry and security is the reoccurring focus.

PARKING | CANOPY | PATH OF EGRESS



DESIGN + FORM

Envoy is a unique presentation of form, function and performance. Uniformity, minimum foot-candles and other design criteria are accomplished through Envoy's multitude of reflector and shielding options. Coupled with toolless access and release features throughout the mounting, maintenance and removal process, Envoy offers service friendly solutions throughout every aspect of its design.

MATERIALS + PERFORMANCE

The Envoy design is driven by material and performance specifications. The alliance of lens and reflector has been tactfully planned with careful considerations of fit and function. The lens and reflector embody the foundation of Envoy. Completing the blueprint is the housing and mounting framework, with its intricate yet elementary system that locates and secures the unit in place, allowing unparalleled toolless maintenance solutions.

DESIGN CONSIDERATIONS

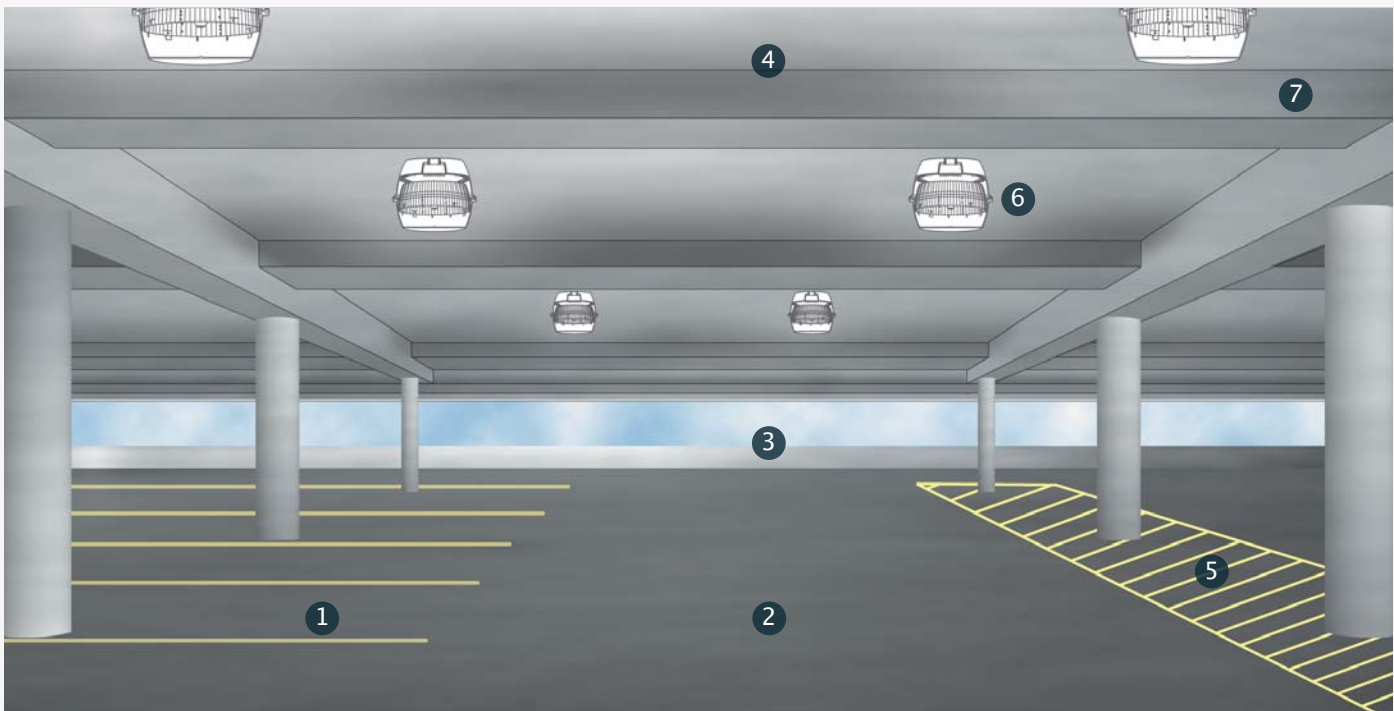

THE MULTITUDE OF TASKS ENCOUNTERED IN A PARKING GARAGE ENVIRONMENT REQUIRE FORETHOUGHT AND PLANNING WHEN DESIGNING A NEW LIGHTING SYSTEM.

- [1] Adequate horizontal and vertical illumination is required for the safety and security of occupants within the structure. Direct and indirect illumination allows safe movement of pedestrian and vehicular traffic, including the ability to easily identify vehicles, parking spaces and direction of traffic flow.
- [2] Glare from luminaires can distract pedestrians and drivers, ultimately compromising safety. Optical systems should minimize glare and improve visual comfort allowing drivers and pedestrians to safely navigate their paths.
- [3] Quality and control of the installed lighting system as viewed from both the interior and exterior of the structure. Avoid light trespass to the surrounding properties.
- [4] Parking structures tend to create a feeling of enclosure also known as the "cave effect", caused by dark ceilings and walls. System designs that offer an upright component help illuminate ceiling surfaces and create an open feeling of space while improving depth perception.
- [5] When the power goes out, emergency "path of egress" is the highest concern. Exiting individuals in a safe and timely manner needs to be planned for accordingly.
- [6] Garage lighting should be viewed as an investment in property, savings and safety. Fixture design, installation and maintenance all play an important role and should heavily influence buying decisions. Garage luminaires should offer flexibility in mounting, resist accumulation of insects, dirt and water, and offer options that impede bird nesting and vandalism.
- [7] Luminaires must be flexible to account for varying needs of the garage and lighting design. Elements including size, ceiling heights, depth of structural beams and complexities of parking stalls and pathways needs to be considered.

INNOVATION

Envoy is truly unique in form and construction. Practical and useful features abound throughout the design, culminating in an extremely versatile parking garage luminaire. By focusing on solutions that meet contractor and end user needs, Envoy overcomes the challenges of effectively and efficiently lighting parking structures.

- **FIXTURE DESIGN**—Envoy’s form is clean and practical with minimal ledges and a smooth surface finish to minimize dirt and insect accumulation. Coupled with an IP66 ingress rating, Envoy can safely be cleaned by power washing.
- **REFLECTOR DESIGN**—Lens contains “locate and lock” emboss features allowing the reflector to be positioned accurately offering repeatable optical performance. Envoy’s industry leading reflector systems are composed of three elements and are specified based on distribution requirements of the application.
- **ADJUSTABLE LIGHT SHIELDS**—Mounted internally, all shield media has the ability to rotate 360° per user preference, promoting maximum light control flexibility and visual comfort. Three [3] different types of light control shields are available. House Side Shield [HS], offers 120° of coverage in upper and lower windows which may be used together or independently. Drive Lane Shield [DLS], offers 60° of coverage on the lower window and can be used with one-way or two-way directional traffic via use of two shields. Concentrated Downlight [CD], offers 360° of coverage around the uplight window for a true “cutoff” rated garage fixture.
- **QUICK MOUNT/RELEASE BRACKET SYSTEM**—Spring loaded mounting bracket and toolless lever action release, coupled with toolless release hand latches for access to the lens and electrical compartment. Envoy is the market leader in ease of installation, maintenance and removal.
- **EGRESS LAMP OPTIONS**—For path of egress requirements, Envoy offers 26 different options, featuring compact fluorescent, quartz and MR16 lamp sources. Multiple circuit options including integral battery pack are available. An exclusive Task Light [TL] option featuring an adjustable light head is available for emergency or task lighting needs.
- **MOUNTING OPTIONS**—Envoy offers 6 different mounting configurations to accommodate any garage lighting application.

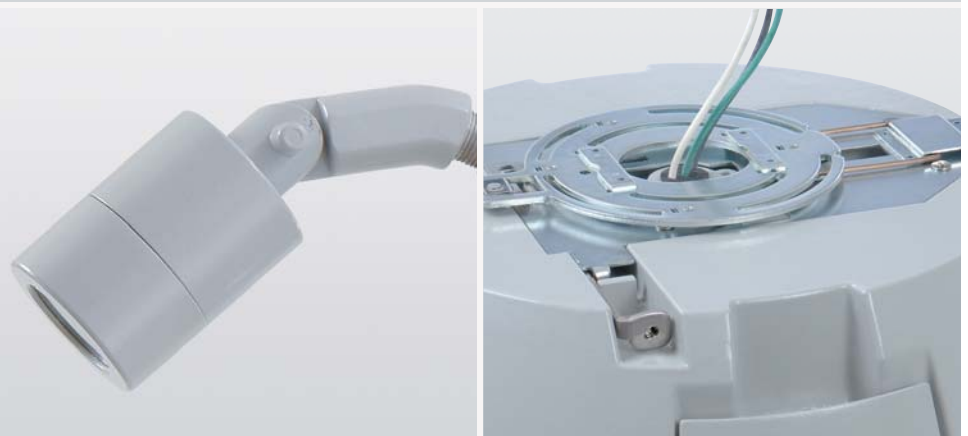

PATENTS PENDING

INSTALLATION + MAINTENANCE

SIMPLE, EFFICIENT AND SECURE.

Envoy's "quick mount + release" attachment mechanism is standard on all fixtures and may be used with standard 4" J-Boxes and Envoy's multiple mounting accessories. A positive audible "click" is heard which signals the fixture is firmly secured and locked into place.

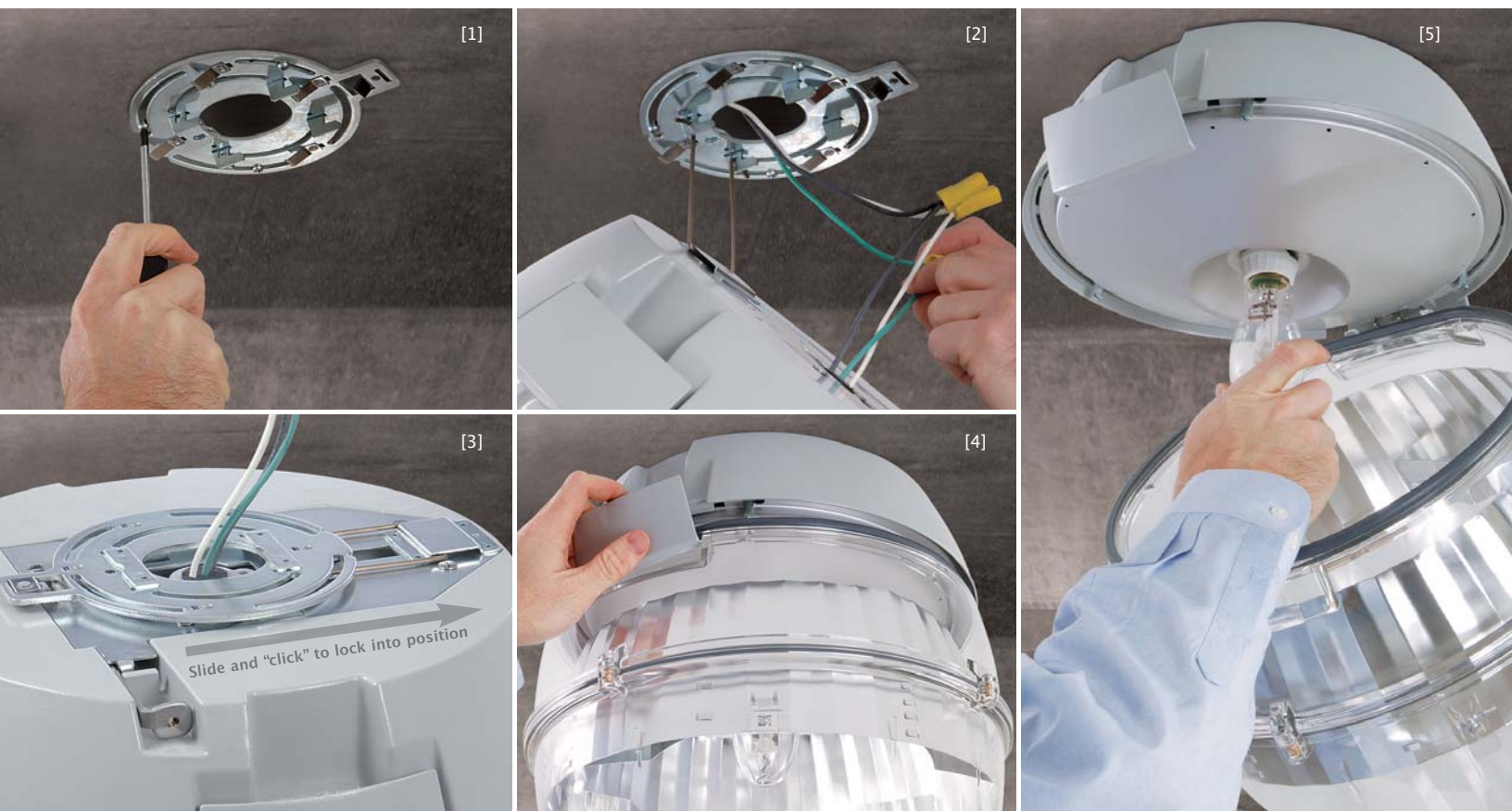

INSTALLATION

- [1] Install "Quick Mount" plate
- [2] Loop hook, hang fixture and make wiring connections
- [3] Guide the wires into center access hole. Swing up and slide fixture onto bracket hooks. When "click" is heard, installation is complete.

[4] ACCESS + INSPECTION + REMOVAL

Other garage fixtures force you to remove the lens and ballast cover to access the connections within the junction box. Envoy's "quick release" mechanism allows access with the simple act of sliding an external lever. No need to undo your work if you need to inspect connections. Slide the lever in and push the fixture away to lower the luminaire and inspect electrical connections.

[5] MAINTENANCE

All of the fundamental tasks, including re-lamping, inspection and fixture removal, are achieved without the use of tools. Toolless latches allow the user easy access to the lens and electrical compartments. By unlatching two latches, the lens swings out of the way and is self-retained during service and relamping. The "quick release" system allows the user to remove the fixture by sliding the lever in, pushing away and lowering the luminaire, removing the electrical connections and finally removing the fixture off the mounting plate. This is especially useful when servicing or replacing fixtures and allows service to take place without having to block or shut down driving lanes for extended periods of time.

LAMPS + EGRESS OPTIONS

PATH OF EGRESS.

Safe movement of pedestrian and vehicular traffic is the number one priority when designing for required "path of egress" codes. Envoy offers the most comprehensive selection of path of egress options available to the market, with a board range of lamp sources and configurations to choose from.



QUARTZ HALOGEN

Utilizing a T4 double contact bayonet base [DCB], this lamp is a traditional option for various types of circuit and lighting needs. Options [Q and EM] utilize a relay device to sense power supply conditions and extinguish the standby lamp when power is restored. Option [EM/SC] features the same lamp with no relay device, and is designed to connect directly to a backup power source via a separate circuit.

COMPACT FLUORESCENT [CF]

Advancements in compact fluorescent technology have influenced migration to these sources for emergency lighting needs. Compact fluorescent technology offers an effective solution for egress applications in providing equivalent circuit options similar to quartz lamps with better uniformity, less power consumption and longer lamp life. When using HID as the primary lamp, various compact fluorescent wattage options are available using two [2] CF lamps in standby mode. Integral and remote mounted battery pack options are available in multiple wattages when either HID or compact fluorescent lamps are used as the primary source.

TASK LIGHT [TL] MR16

Unique to Envoy, the flexibility and usefulness of the task light option is immense as seen through the number of circuit options and lamp types available. Featuring a rugged vandal resistant die-cast aluminum housing, the task light is mounted to the exterior of the Envoy fixture and carries the same IP66 rating.

Using the MR16 lamp source, this option can be used as a primary means to light signage and retail entrances or as a standby means to illuminate pathways and stairwells in the event of power interruptions and outages. Task Light features a lamp head that can be rotated in both vertical and horizontal planes. Various types of MR16 lamp sources can be used to fit your lighting applications. 120V lamps can be used with restrike relays or can be placed on separate circuits to provide light while HID lamps are in restrike mode. 12V MR16 lamps can be used with remote mounted battery packs for power outage applications. For the most lighting punch, Task Light is even available with a dedicated transformer contained within the Envoy housing that will operate 50 and 75W MR16 12V lamps. Envoy is available with up to four [4] task lights to meet your general and egress lighting needs.



MOUNTING CONFIGURATIONS

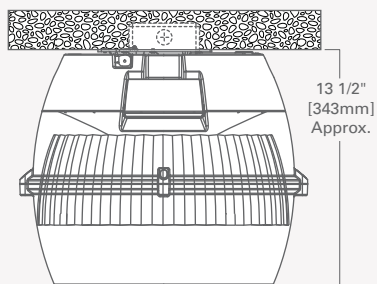

STANDARD J-BOX MOUNT [Recessed]

The J-Box is recessed/cast into ceiling. Envoy is attached using the quick mount release bracket system.

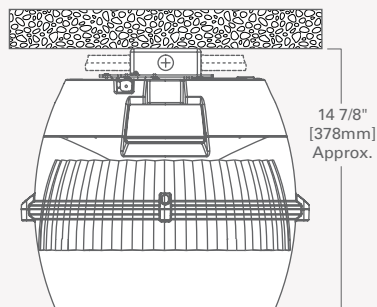

STANDARD J-BOX MOUNT [Surface]

The J-Box is surface mounted to ceiling where J-Box and conduit are visible. Envoy is attached using the quick mount release bracket system.

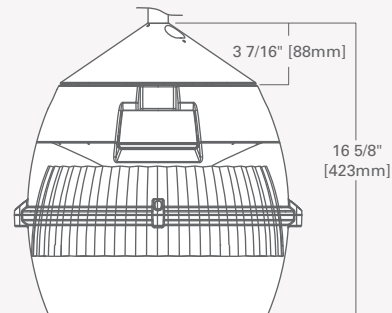

PENDANT BOX/BIRD GUARD [PBG]

The pendant box accessory also acts as a bird guard and may be used with a free swinging or rigid pendant system, allowing the fixture to level and hang straight. Envoy is attached using the same quick mount release bracket similar to J-Box installation.

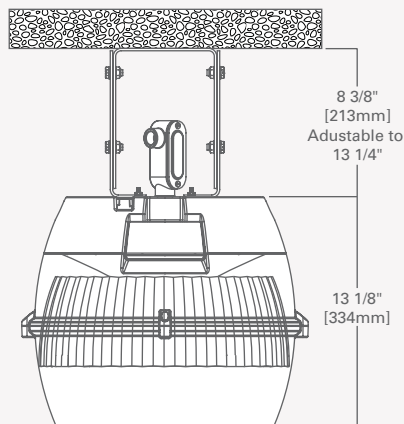

TRUNNION-MOUNT [TM]

The trunnion mount bracket allows direct attachment to ceiling using anchors and provides a 1/2" threaded connection box for wiring connections outside the fixture. Trunnion mount is adjustable from 8 3/8" to 13 1/4" depth off mounting surface to top of fixture. Water-tight power cord option is available.

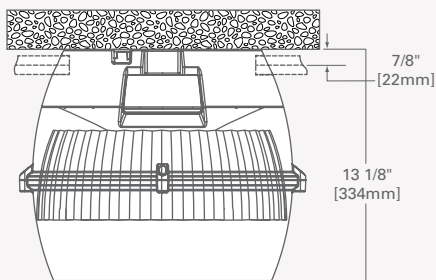

DIRECT SURFACE MOUNT WITH CONDUIT

Cast "knock outs" are provided on the back surface of the cast housing to allow mounting directly to concrete surface using anchors. Power is routed through Conduit Taps [CT] option, that are located 90° offset from latches.

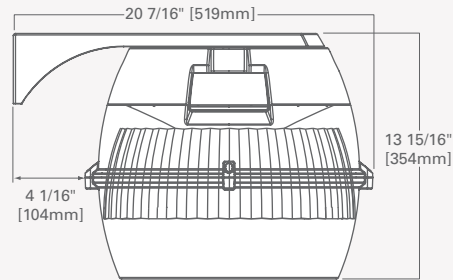

WALL MOUNT [WM]

The wall mount arm allows you to match path or perimeter lighting within or outside the garage. Envoy is attached using the same quick mount release bracket similar to J-Box installation. Power is routed in wall and through access hole within arm to fixture.

THROUGH BRANCH WIRING

Rated for use with 4IN/4OUT #12GA wires. Through branch wiring requires Conduit Tap [CT] option and provides [2] 3/4" NPSM threaded hubs for wire access into side of fixture.

DOUBLE-T STRUCTURAL CEILING

In typical double-T structural ceiling designs, the luminaire is placed between 2 beams that are no more than 4 feet apart. In a surface mount scenario this method traps a significant amount of light within the ceiling structure, leading to compromised light levels on the work plane.



When designing for T structure ceilings, the optimal solution is to mount the fixture via pendant pipe at or below the bottom plane of the beam level. Since beams typically traverse laterally along the width of the garage, using the rectangular [TG] distribution in the same direction generally offers the best solution.

PENDANT MOUNT APPLICATIONS

Garage fixtures are commonly mounted to pendant pipes to bring the light source closer to ground level to achieve increased light levels. Many times this is desirable due to higher ceiling heights or structural supports at the ceiling level that interfere and block light emitted from the luminaire. Envoy offers multiple pendant mount solutions. When a bird nesting deterrent is required in pendant applications, use the [PBG] accessory.

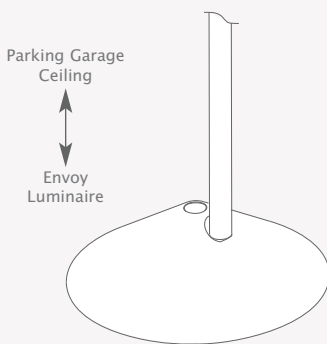

FREE SWING PENDANT + PBG ACCESSORY [OFFSET POSITION]
Envoy is attached to the pendant box [PBG] accessory using the standard quick mount release bracket system. The pendant conduit pipe and free swing swivel hanger system are provided by others. Because the system is free swinging, the offset pipe position must be used to allow the fixture to hang straight.

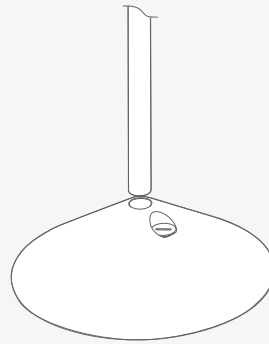

RIGID PENDANT + PBG ACCESSORY [CENTER or OFFSET POSITION]
Envoy is attached to the pendant box [PBG] accessory using the standard quick mount release bracket system. The pendant conduit pipe and suspension mechanism are provided by others. Because the system is rigid and non-moving, the center or offset pipe position may be used to hang the fixture.

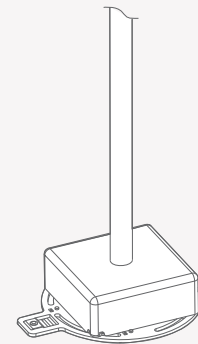

RIGID PENDANT + J-BOX [CENTER POSITION]
Envoy is attached to a 4" junction box using the standard quick mount release bracket system. The pendant conduit pipe and junction box with center pendant entry access are provided by others. The center position of the J-Box may be used to hang the fixture.

OPTICAL VERSATILITY



[RD]



[SQ]



[TG]



[CD]



[HS]



[DLS]

ROUND [RD]

Bright specular Alzak® anodized aluminum main reflector and diffuse anodized aluminum upper reflector.

CONCENTRATED DOWN LIGHT [CD]

360° Internal shield efficiently redirects uplight downward to offer higher illumination values on the ground where light may be needed most. Useful in areas requiring higher footcandle values such as parking garage entrances/exits or where restricted uplight is desired. The concentrated downlight option may be used with any of the three primary optical distributions: Round [RD], Square [SQ] and Rectangular [TG].

SQUARE [SQ]

Bright specular Alzak® anodized aluminum main reflector, four [4] sets of premium 95% reflective specular pre-anodized sheet aluminum inserts and diffuse anodized aluminum upper reflector.

HOUSE SIDE SHIELD [HS]

The house side shield is a two-part internal shield accessory controlling both an uplight and downlight component. Each shield covers a 120° horizontal range and is 360° rotationally adjustable [upper shield in 30° increments]. Shields may be used together or independently to control different angles and elevations of light. House side shield may be used with any of the three primary optical distributions: Round [RD], Square [SQ] and Rectangular [TG].

RECTANGULAR [TG]

Bright specular Alzak® anodized aluminum main reflector, two [2] sets of premium 95% reflective specular pre-anodized sheet aluminum inserts and diffuse anodized aluminum upper reflector.

DRIVE LANE SHIELD [DLS]

The drive lane shield accessory covers a 60° horizontal range. Shield is adjustable but is most often centered in line with the driving lane. Shield blocks direct high angle light towards oncoming drivers in the vertical plane from above 70° down to 40°. Two [2] sets of shields may be used for 2-way traffic. Shields install without the use of tools. Drive lane shields may be used with any of the three [3] primary optical distributions: Round [RD], Square [SQ] and Rectangular [TG].

OPTICAL SOLUTIONS FOR DIVERSE NEEDS AND ENVIRONMENTS.

Envoy offers three optical distributions and a variety of light control media to optimize lighting performance and comply with local lighting ordinances. The standard Envoy system features the main reflector contributing to both horizontal and vertical illumination. The upper reflector contributes 10% uplight, reducing the visual cave effect within the parking structure.

DESIGN PRACTICES

Lighting design for parking structures normally follows specific published guidelines and design practices as defined by the Illuminating Engineering Society of North America [IESNA]. IESNA publishes recommended guidelines to help facilitate garage lighting design. The following minimum guidelines are established for safety and security of pedestrians and property within the space.

RECOMMENDED MAINTAINED ILLUMINANCE VALUES FOR PARKING GARAGES

Horizontal Illuminance [On Floor]	Minimum Horizontal Footcandles [fc]*	Vertical Illuminance [60° Above Floor]	Minimum Vertical Footcandles [fc]*
Basic	1.0	Basic	0.5
Ramps Day	2.0	Ramps Day	1.0
Ramps Night	1.0	Ramps Night	0.5
Entrance Areas Day	50	Entrance Areas Day	25
Entrance Area Night	1.0	Entrance Areas Night	0.5
Stairways	2.0	Stairways	1.0

*NOTE: IES Recommended Practices RP-20.

In addition to the amount of light measured on the work plane, uniformity of light must be balanced as well. As with minimum footcandle values listed on the above table, the maximum/minimum uniformity ratio within the space is an important element in minimizing eyestrain and creating an inviting and safe environment. The IESNA recommended maximum/minimum uniformity ratio is no greater than 10:1.

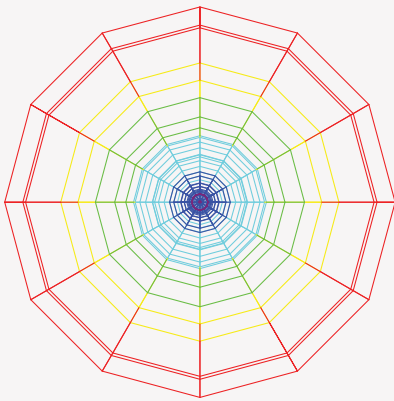

ROUND [RD]

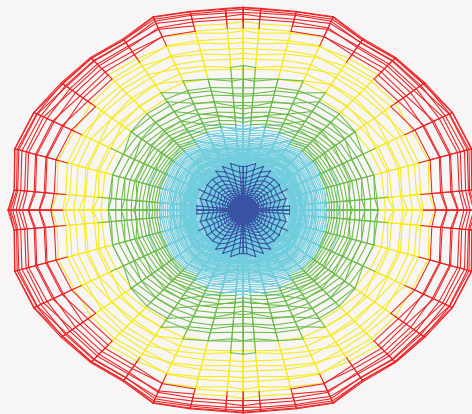

CONCENTRATED DOWN LIGHT [CD]

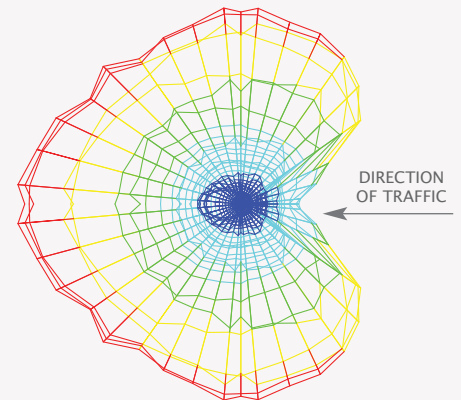

DRIVE LANE SHIELD [DLS1]

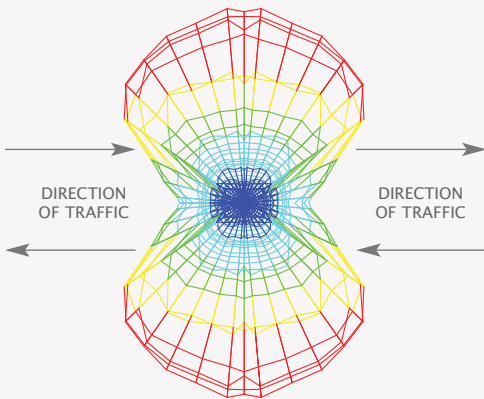

DRIVE LANE SHIELD [DLS2]

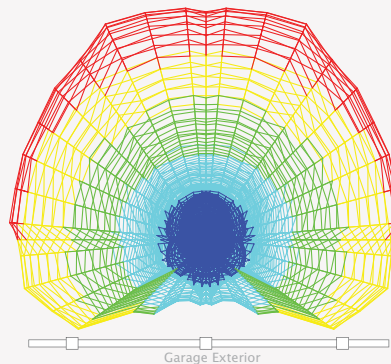

HOUSE SIDE SHIELD 120° [HS]

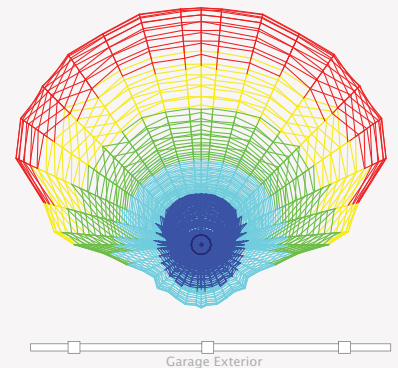

HOUSE SIDE SHIELD 180° [HS]

CONFIGURATIONS + LAYOUTS

ROUND [RD]

- | | | |
|----------|------------|-------------------|
| Up Light | Down Light | Reflector Inserts |
| | | none |

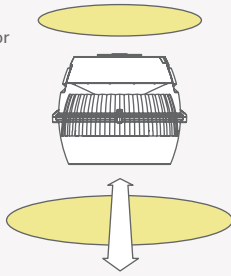

Driving Direction

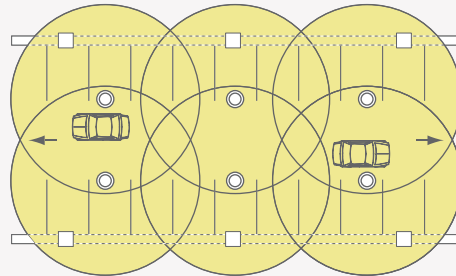

Two-way Drive Lane
Double Luminaire Row

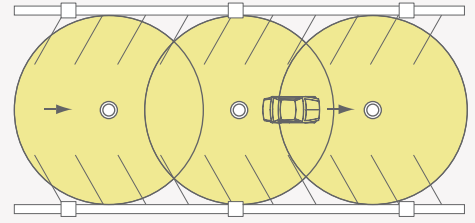

One-way Drive Lane
Single Luminaire Row

SQUARE [SQ]

- | | | |
|----------|------------|-------------------|
| Up Light | Down Light | Reflector Inserts |
| | | |

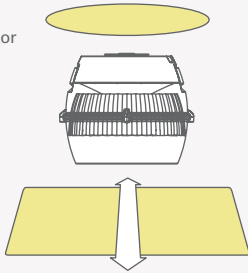

Driving Direction

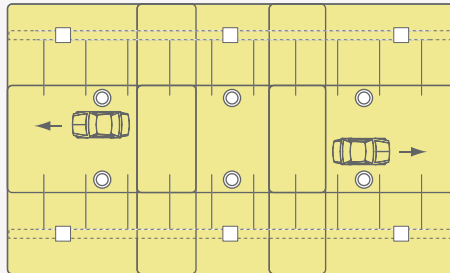

Two-way Drive Lane
Double Luminaire Row

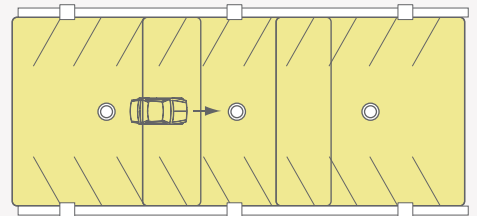

One-way Drive Lane
Single Luminaire Row

RECTANGULAR [TG]

- | | | |
|----------|------------|-------------------|
| Up Light | Down Light | Reflector Inserts |
| | | |

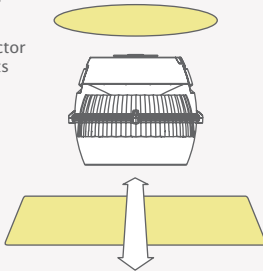

Driving Direction

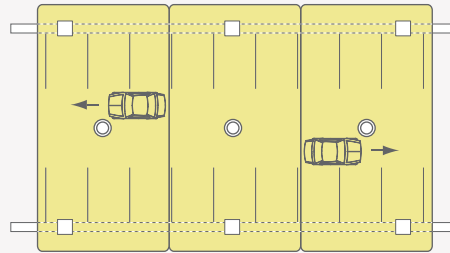

Two-way Drive Lane
Single Luminaire Row

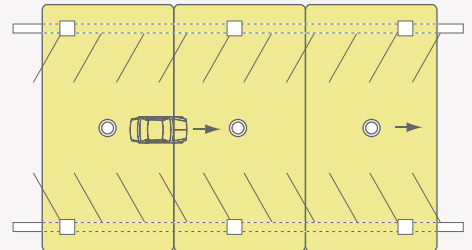

One-way Drive Lane
Single Luminaire Row

RECTANGULAR [TG]

- | | | |
|----------|------------|-------------------|
| Up Light | Down Light | Reflector Inserts |
| | | |

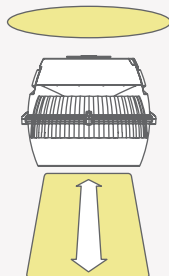

Driving Direction

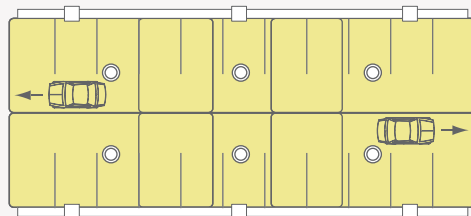

Two-way Drive Lane
Double Luminaire Row

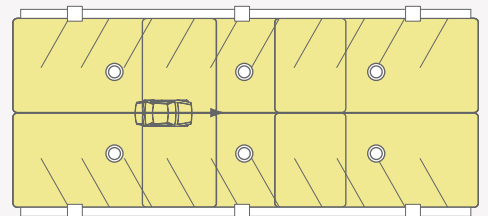

One-way Drive Lane
Double Luminaire Row

LIGHT CONTROL

Envoy's numerous reflector options and light controlling shields allow flexibility in application for all garage types. All of the three [3] main distributions are available with the complete line of shield options and accessories.

CONCENTRATED DOWNLIGHT [CD]

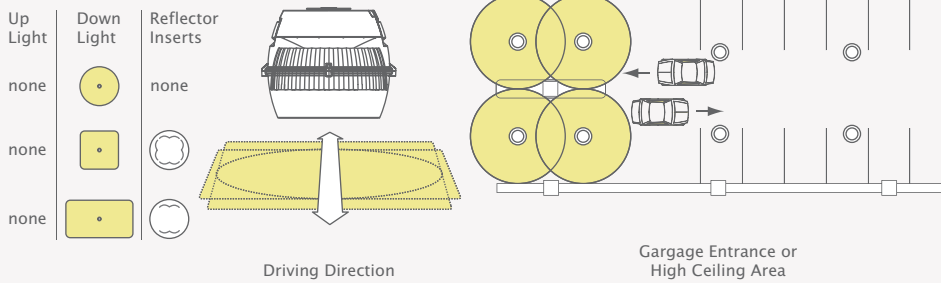

HOUSE-SIDE SHIELD [HS]

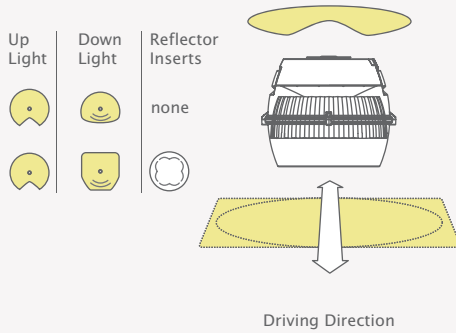

ROUND [RD]

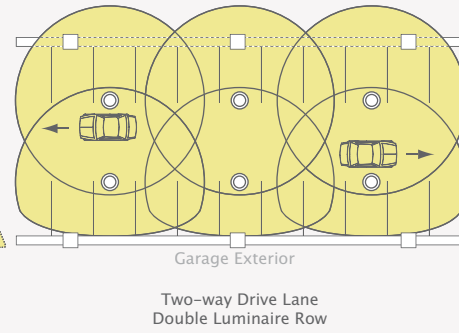

SQUARE [SQ]

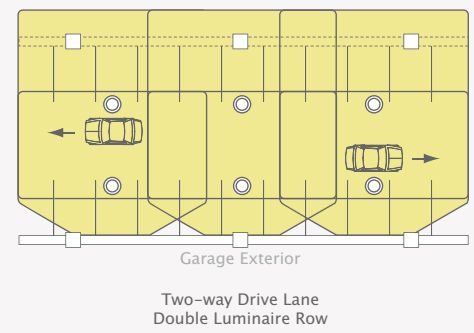

HOUSE-SIDE SHIELD [HS]

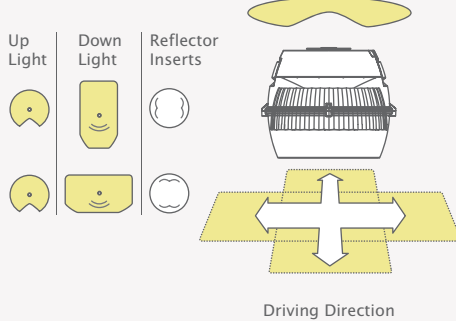

RECTANGULAR [TG]

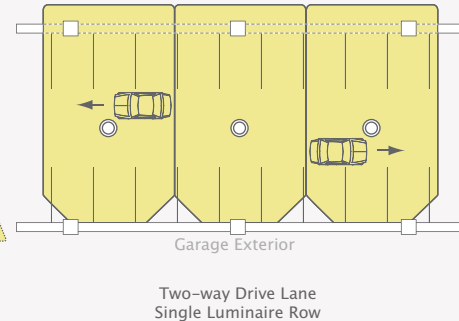

RECTANGULAR [TG]

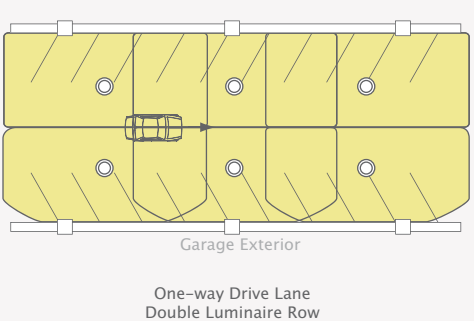

DRIVE LANE SHIELD [DLS]

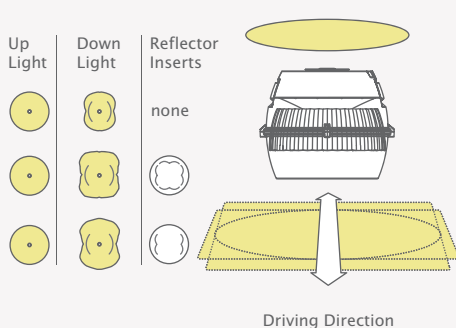

DRIVE LANE SHIELD [2-WAY]

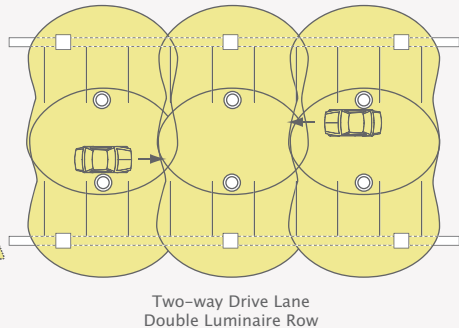

DRIVE LANE SHIELD [1-WAY]

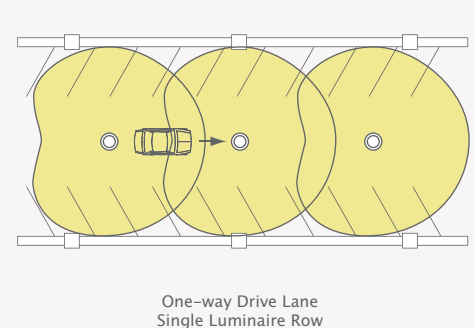

CONFIGURATIONS + LAYOUTS

SINGLE FIXTURE ROW LAYOUT [1 FIXTURE PER BAY] Bay Width=60 Foot

Note: All values are maintained illumination and account for 20% ceiling and floor reflectance with flat ceilings. Contribution from subsequent fixtures mounted in line, but no contribution from adjacent bays. Lamp, electrical and surface reflection characteristics can affect accuracy and may vary.

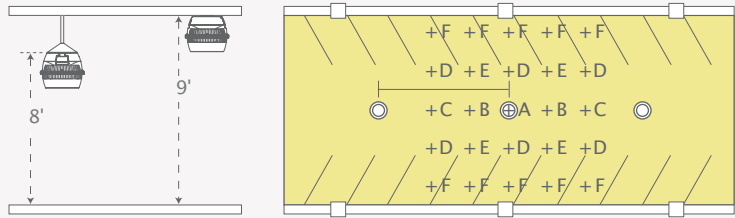

DESCRIPTION FIXTURE/TEST NUMBER	Fixture Mounting Height ¹	Fixture Spacing [Down Drive Lane]	Fc Values On Deck						Horiz. Avg. [fc]	Horiz. Min [fc]	Horiz. Max./Min.	Vert. Min. [fc] @ 5' above floor
			A	B	C	D	E	F				
175w MP, Round Distribution Medium Base, Clear Lamp, 17,500 Lumens Test No. EPL-175-MP-RD ² Light Loss Factor: 0.80	8'	20'	15.6	14.4	15.4	9.2	9.0	2.9	7.7	2.8	7.4	0.5
		30'	10.6	8.9	11.2	5.9	6.5	2.1	5.1	1.7	8.6	0.3
	9'	20'	13.3	13.0	13.7	9.0	8.2	3.7	7.6	3.6	5.1	0.9
		30'	9.2	8.1	10.1	5.7	6.0	2.5	5.1	2.4	5.6	0.4
175w MP, Rectangular Distribution Medium Base, Clear Lamp, 17,500 Lumens Test No. EPL-175-MP-TG ² Light Loss Factor: 0.80	8'	20'	14.8	13.7	14.9	9.3	9.3	3.1	7.8	3.1	6.5	0.5
		30'	10.1	8.4	10.5	5.9	7.3	2.1	5.2	2.0	7.0	0.4
	9'	20'	13.0	12.4	13.2	9.4	8.6	3.9	7.6	3.9	4.5	1.1
		30'	8.5	7.8	9.6	5.7	6.7	2.8	5.1	2.4	5.3	0.5
175w MP, Square Distribution Medium Base, Clear Lamp, 17,500 Lumens Test No. EPL-175-MP-SQ ² Light Loss Factor: 0.80	8'	20'	13.2	12.5	13.3	10.1	10.1	3.1	7.8	2.9	6.1	0.5
		30'	10.1	6.9	10.1	6.1	7.7	2.3	5.2	1.7	7.8	0.4
	9'	20'	11.3	11.3	11.8	9.6	9.0	4.1	7.7	4.1	3.8	0.9
		30'	8.5	6.7	9.0	5.7	6.7	3.1	5.1	2.4	5.0	0.5
175w MP, Square Distribution w/(1) Drive Lane Shield (Shield facing oncoming traffic) Medium Base, Clear Lamp, 17,500 Lumens Test No. EPL-175-MP-SQ-DLS1 ² Light Loss Factor: 0.80	8'	20'	12.8	12.1	13.7	8.8	9.4	2.8	7.1	2.5	7.3	0.7
		30'	10.0	6.3	10.1	5.3	7.0	2.1	4.7	1.5	9.2	0.4
	9'	20'	11.2	11.0	10.9	8.6	8.1	3.6	7.0	3.3	4.7	1.1
		30'	8.2	5.7	9.3	5.3	6.4	2.8	4.6	1.9	6.7	0.5
175w MP, Square w/HS 120° Lower Only (Shield facing oncoming traffic) Medium Base, Clear Lamp, 17,500 Lumens Test No. EPL-175-MP-SQ-HS120 LOWER ONLY ² Light Loss Factor: 0.80	8'	20'	14.4	12.2	15.0	7.7	10.1	2.3	7.2	2.0	10.3	0.7
		30'	11.4	6.1	10.8	4.9	7.0	1.6	4.7	1.3	11.4	0.4
	9'	20'	12.5	11.4	12.9	8.0	8.2	3.3	7.0	3.1	5.7	0.8
		30'	9.6	5.7	10.0	4.5	6.5	2.4	4.6	1.9	7.5	0.5
175w MP, Square w/HS 180° Upper/Lower (Shield facing oncoming traffic) Medium Base, Clear Lamp, 17,500 Lumens Test No. EPL-175-MP-SQ-HS180 UPPER/LOWER ² Light Loss Factor: 0.80	8'	20'	15.3	12.4	14.9	7.3	8.1	1.6	6.3	1.6	12.7	0.7
		30'	11.8	7.2	11.7	3.9	6.0	1.1	4.1	0.9	17.1	0.4
	9'	20'	13.0	11.2	13.4	7.4	7.3	2.4	6.2	2.1	8.4	0.9
		30'	10.1	6.7	10.1	4.8	5.9	1.7	4.1	1.3	10.1	0.5
150w HPS, Round Distribution Medium Base, Clear Lamp, 16,000 Lumens Test No. EPL-150-HPS-RD Light Loss Factor: 0.81	8'	20'	13.7	12.9	13.8	8.6	8.2	3.3	7.32	3.2	4.31	0.8
		30'	9.4	8.0	10.1	5.5	5.9	2.3	4.87	2.1	4.81	0.4
	9'	20'	11.2	11.5	11.7	8.3	7.5	3.9	7.00	3.8	3.08	1.6
		30'	7.7	7.1	8.6	5.3	5.4	2.7	4.67	2.6	3.31	0.8
150w HPS, Rectangular Distribution Medium Base, Clear Lamp, 16,000 Lumens Test No. EPL-150-HPS-TG Light Loss Factor: 0.81	8'	20'	15.1	13.7	15.0	9.0	8.8	2.8	7.53	2.7	5.59	0.6
		30'	9.3	6.9	9.7	5.7	6.4	2.3	4.93	2.3	4.22	0.4
	9'	20'	13.1	12.4	13.2	9.0	8.1	3.6	7.38	3.4	3.88	1.3
		30'	7.8	6.5	8.7	5.3	5.8	2.9	4.82	2.9	3.00	0.8
150w HPS, Square Distribution Medium Base, Clear Lamp, 16,000 Lumens Test No. EPL-150-HPS-SQ Light Loss Factor: 0.81	8'	20'	13.1	12.3	13.2	9.3	9.4	3.1	7.44	3.0	4.40	0.6
		30'	9.4	7.4	9.9	5.8	7.4	2.3	4.98	1.8	5.50	0.4
	9'	20'	11.3	11.1	11.7	8.9	8.2	4.1	7.28	3.9	3.00	1.3
		30'	8.0	6.8	8.9	5.5	6.5	2.9	4.86	2.3	3.87	0.7
150w MP, Round Distribution Medium Base, Clear Lamp, 14,000 Lumens Test No. EPL-150-MP-RD ² Light Loss Factor: 0.80	8'	20'	12.5	11.5	12.4	7.4	7.3	2.3	6.2	2.2	5.9	0.4
		30'	8.5	7.1	9.0	4.7	5.2	1.7	4.1	1.4	6.9	0.2
	9'	20'	10.7	10.5	11.0	7.3	6.6	3.0	6.1	2.9	4.1	0.7
		30'	7.4	6.5	8.1	4.6	4.8	2.0	4.1	1.9	4.5	0.3
150w MP, Rectangular Distribution Medium Base, Clear Lamp, 14,000 Lumens Test No. EPL-150-MP-TG ² Light Loss Factor: 0.80	8'	20'	11.8	11.0	11.9	7.5	7.5	2.5	6.2	2.5	5.2	0.4
		30'	8.1	6.7	8.4	4.7	5.9	1.7	4.2	1.6	5.6	0.3
	9'	20'	10.5	9.9	10.6	7.6	6.9	3.1	6.1	3.1	3.6	0.9
		30'	6.8	6.3	7.7	4.6	5.3	2.2	4.1	1.9	4.3	0.4
150w MP, Square Distribution Medium Base, Clear Lamp, 14,000 Lumens Test No. EPL-150-MP-SQ ² Light Loss Factor: 0.80	8'	20'	10.6	10.0	10.7	8.1	8.1	2.5	6.2	2.3	4.9	0.4
		30'	8.1	5.5	8.1	4.9	6.2	1.8	4.1	1.4	6.2	0.3
	9'	20'	9.1	9.1	9.5	7.7	7.3	3.3	6.1	3.3	3.1	0.7
		30'	6.8	5.3	7.3	4.6	5.3	2.5	4.1	1.9	4.0	0.4

¹ Ceiling height is constant at 9 feet. Actual fixture mounting height is 8' and 9' respectively to where top of fixture is suspended. Photometric center where data is first measured out of the luminaire is 86.5" to floor for 8' and 98.5" to floor for 9' mounting heights. ² Taken from prorated data. ³ Footcandle data points are spaced 12' center to center.

DOUBLE FIXTURE ROW LAYOUT [2 FIXTURES PER BAY]

Bay Width=60 Foot

Note: All values are maintained illumination and account for 20% ceiling and floor reflectance with flat ceilings. Contribution from subsequent fixtures mounted in line, but no contribution from adjacent bays. Lamp, electrical and surface reflection characteristics can affect accuracy and may vary.

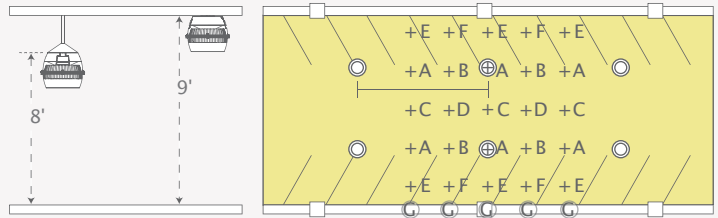

Description Fixture/Test Number	Fixture Mounting Height ¹	Fixture Spacing [Down Drive Lane]	Fixture Spacing [Across Drive Lane]	Fc Values On Deck						G [Garage Exterior] ²	Horiz. Avg. [fc]	Horiz. Min [fc]	Horiz. Max./Min.	Vert. Min. [fc] @ 5' above floor
				A	B	C	D	E	F					
175w MP, Round Distribution Medium Base, Clear Lamp, 17,500 Lumens Test No. EPL-175-MP-RD ³ Light Loss Factor: 0.80	8'	20'	25'	18.2	17.0	17.7	17.4	9.7	9.6	---	14.36	9.3	2.62	2.8
		30'	25'	12.6	10.6	11.2	12.6	6.3	6.8	---	9.54	6.1	2.83	1.1
	9'	20'	25'	17.2	16.6	17.7	16.4	10.1	9.2	---	13.86	8.8	2.69	7.4
		30'	25'	11.7	10.5	11.0	11.8	6.3	6.4	---	9.24	6.1	2.71	2.0
175w MP, Rectangular Distribution Medium Base, Clear Lamp, 17,500 Lumens Test No. EPL-175-MP-RD ³ Light Loss Factor: 0.80	8'	20'	25'	17.7	16.6	17.7	18.2	10.0	10.0	---	14.43	9.8	2.46	3.3
		30'	25'	12.5	9.8	11.7	14.4	6.4	7.6	---	9.80	6.3	3.06	1.2
	9'	20'	25'	16.8	16.1	18.1	16.6	10.5	9.4	---	13.89	9.0	2.67	9.7
		30'	25'	10.9	10.5	10.1	13.2	6.0	7.3	---	9.28	5.9	2.99	1.9
175w MP, Square Distribution Medium Base, Clear Lamp, 17,500 Lumens Test No. EPL-175-MP-SQ ³ Light Loss Factor: 0.80	8'	20'	25'	17.3	16.5	18.0	18.8	10.0	10.1	---	14.43	9.8	2.54	3.7
		30'	25'	11.7	9.0	11.3	15.2	6.1	7.8	---	9.54	6.1	3.30	1.1
	9'	20'	25'	15.3	15.4	18.8	17.8	10.2	9.6	---	13.67	9.2	2.71	11.0
		30'	25'	10.5	10.5	9.8	14.0	5.7	7.4	---	9.30	5.6	3.33	2.1
175w MP, Square Distribution w/ [2] Drive Lane Shields (centered in drive lane) Medium Base, Clear Lamp, 17,500 Lumens Test No. EPL-175-MP-SQ-DLS2 ³ Light Loss Factor: 0.80	8'	20'	25'	14.2	12.2	14.9	18.4	8.4	9.6	---	12.17	8.2	2.97	3.6
		30'	25'	11.6	8.6	6.3	14.4	3.6	7.7	---	8.46	3.3	5.75	1.3
	9'	20'	25'	13.2	12.2	15.4	15.8	8.8	8.8	---	11.69	8.5	2.50	6.7
		30'	25'	10.1	6.7	8.9	12.4	5.3	6.7	---	7.78	5.1	3.26	1.5
175w MP, Square w/HS 120° Lower [Shields face garage exterior] Medium Base, Clear Lamp, 17,500 Lumens Test No. EPL-175-MP-SQ-HS120 LOWER ONLY & EPL-175-MP-SQ ³ Light Loss Factor: 0.80	8'	20'	25'	18.5	15.2	20.2	21.7	10.5	10.5	2.5	14.10	5.2	5.56	3.3
		30'	25'	13.0	9.0	11.8	16.9	6.3	8.0	2.1	9.42	2.3	9.94	0.8
	9'	20'	25'	16.2	15.4	20.5	18.8	10.5	9.6	3.5	13.55	6.0	4.55	10.1
		30'	25'	12.0	9.6	11.4	14.2	6.3	7.0	2.3	9.11	2.5	7.91	1.5
175w MP, Square w/HS 180° [Shields face garage exterior] Medium Base, Clear Lamp, 17,500 Lumens Test No. EPL-175-MP-SQ-HS180 UPPER/LOWER & EPL-175-MP-SQ ³ Light Loss Factor: 0.80	8'	20'	25'	17.3	15.4	19.7	21.1	10.6	10.6	1.2	13.47	2.9	9.62	1.3
		30'	25'	12.0	10.9	12.0	14.1	6.5	6.7	0.9	8.72	2.0	9.48	0.7
	9'	20'	25'	15.6	15.7	19.8	18.5	10.6	9.7	1.9	12.99	3.7	7.08	4.3
		30'	25'	13.8	9.7	11.6	14.1	6.4	7.2	1.3	8.70	2.0	9.40	0.7
150w HPS, Round Distribution Medium Base, Clear Lamp, 16,000 Lumens Test No. EPL-150-HPS-RD Light Loss Factor: 0.81	8'	20'	25'	16.9	16.0	16.7	16.3	9.5	9.1	---	13.51	8.8	1.92	5.3
		30'	25'	11.6	10.0	10.6	11.7	6.1	6.5	---	9.00	5.9	2.08	1.7
	9'	20'	25'	14.9	15.2	16.2	14.9	9.5	8.7	---	12.72	8.4	1.93	10.8
		30'	25'	10.2	9.6	10.2	10.6	6.1	6.0	---	8.46	5.8	1.91	3.7
150w HPS, Rectangular Distribution Medium Base, Clear Lamp, 16,000 Lumens Test No. EPL-150-HPS-TG Light Loss Factor: 0.81	8'	20'	25'	17.7	16.4	17.2	17.4	9.7	9.5	---	14.06	9.3	1.91	4.6
		30'	25'	11.5	10.7	10.0	13.4	5.7	7.3	---	9.40	5.6	2.39	1.4
	9'	20'	25'	16.4	15.9	17.5	16.1	10.0	9.1	---	13.54	8.7	2.01	10.6
		30'	25'	10.7	10.3	10.2	12.2	6.0	6.7	---	9.04	5.8	2.10	3.7
150w HPS, Square Distribution Medium Base, Clear Lamp, 16,000 Lumens Test No. EPL-150-HPS-SQ Light Loss Factor: 0.81	8'	20'	25'	16.1	15.2	17.5	18.6	9.6	9.9	---	13.73	9.4	1.98	4.8
		30'	25'	11.2	9.4	10.1	14.6	5.6	7.7	---	9.18	5.6	2.61	1.1
	9'	20'	25'	15.2	14.9	17.4	16.5	9.8	9.2	---	13.14	8.7	2.00	12.4
		30'	25'	10.3	9.5	9.9	12.9	5.8	6.9	---	8.78	5.6	2.30	2.8
150w MP, Round Distribution Medium Base, Clear Lamp, 14,000 Lumens Test No. EPL-150-MP-RD ³ Light Loss Factor: 0.80	8'	20'	25'	14.6	13.7	14.2	14.0	7.8	7.7	---	11.5	7.5	2.1	2.2
		30'	25'	10.1	8.5	9.0	10.1	5.0	5.4	---	7.6	4.9	2.3	0.9
	9'	20'	25'	13.8	13.3	14.2	13.1	8.1	7.4	---	11.1	7.0	2.2	6.0
		30'	25'	9.4	8.4	8.9	9.5	5.0	5.1	---	7.4	4.9	2.2	1.6
150w MP, Rectangular Distribution Medium Base, Clear Lamp, 14,000 Lumens Test No. EPL-150-MP-TG ³ Light Loss Factor: 0.80	8'	20'	25'	14.2	13.3	14.2	14.6	8.0	8.0	---	11.6	7.9	2.0	2.7
		30'	25'	10.0	7.9	9.4	11.5	5.1	6.1	---	7.9	5.0	2.5	1.0
	9'	20'	25'	13.4	12.9	14.5	13.3	8.4	7.6	---	11.1	7.3	2.1	7.8
		30'	25'	8.7	8.4	8.1	10.6	4.8	5.9	---	7.4	4.7	2.4	1.5
150w MP, Square Distribution Medium Base, Clear Lamp, 14,000 Lumens Test No. EPL-150-MP-SQ ³ Light Loss Factor: 0.80	8'	20'	25'	13.9	13.2	14.4	15.0	8.0	8.1	---	11.6	7.9	2.0	3.0
		30'	25'	9.4	7.3	9.1	12.2	4.9	6.3	---	7.6	4.9	2.6	0.9
	9'	20'	25'	12.3	12.4	15.0	14.3	8.2	7.7	---	11.0	7.4	2.2	8.9
		30'	25'	8.4	8.4	7.9	11.2	4.6	6.0	---	7.5	4.5	2.7	1.7

¹ Ceiling height is constant at 9 feet. Actual fixture mounting height is 8' and 9' respectively to where top of fixture is suspended. Photometric center where data is first measured out of the luminaire is 86.5" to floor for 8' and 98.5" to floor for 9' mounting heights. ² Values indicated when used with two fixtures per bay and house side shield accessory, pointed towards exterior of garage. Value represents the average foot-candle reading along very edge of garage floor. ³ Taken from prorated data. ⁴ Footcandle data points are spaced 12' center to center.

OPTICAL RENDERINGS

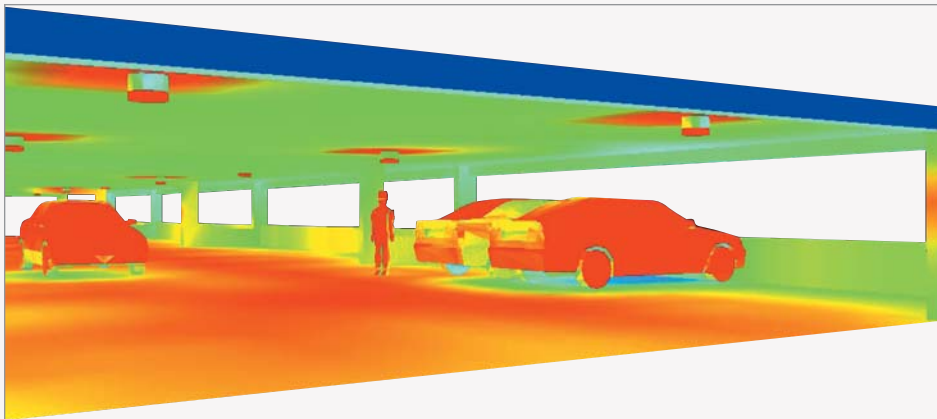
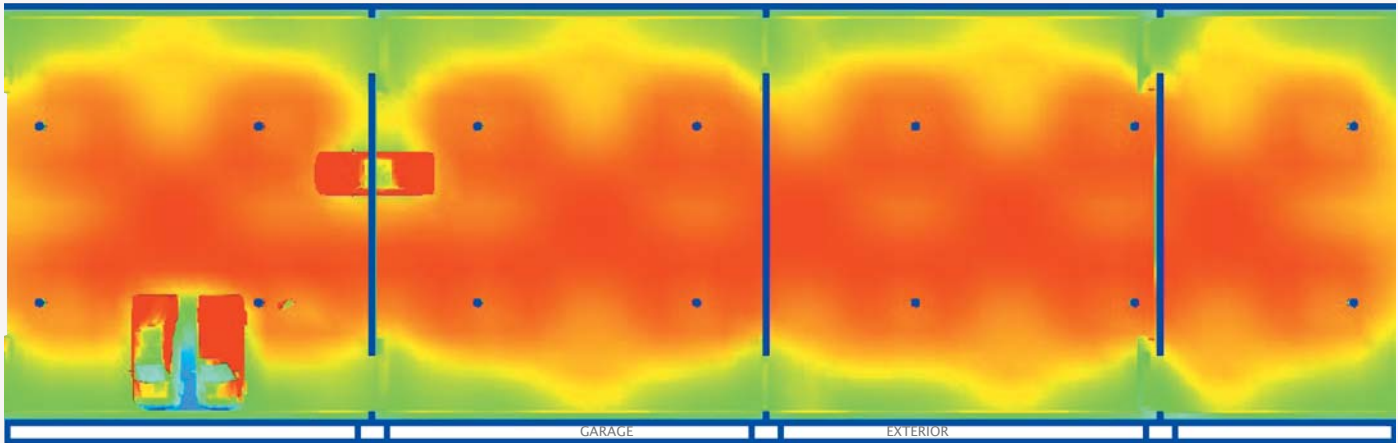

Effective lighting designs provide for excellent uniformity, vehicle identification and facial recognition. Strong vertical illumination of cars and pedestrians is important for detection of vehicles, walking pedestrians and facial recognition of possible criminal threats.

EPL-175-MH-SQ
 60' Wide Double Bay, 9' Ceiling
 .2, 0, .2 Reflectance
 30' Spacing Between Fixtures [East/West]
 25' Spacing Between Fixtures [North/South]

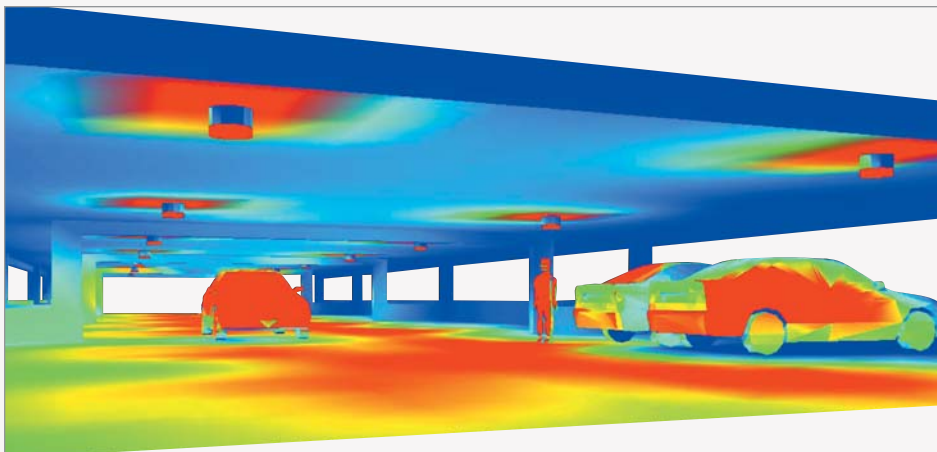

In applications where light trespass is a concern, Envoy's house-side shield [HS] accessory controls spill light on the garage exterior while still maintaining illuminance criteria within the garage, including strong vertical illumination for vehicle and facial recognition.

EPL-175-MH-SQ-HS180
 60' Wide Double Bay, 9' Ceiling
 .2, 0, .2 Reflectance
 30' Spacing Between Fixtures [East/West]
 25' Spacing Between Fixtures [North/South]

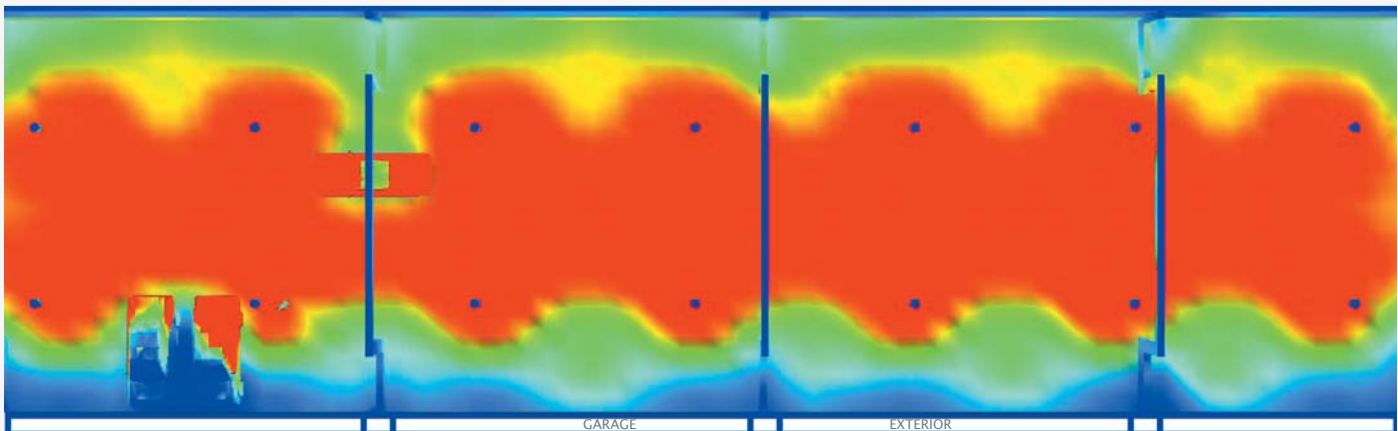

ENERGY



ENERGY SAVINGS

Energy savings is important to end users, and in some instances may be a compliance requirement of the project. When comparing past methods to present and future technologies, there is no apparent single method to solve all energy challenges while meeting the multitude of application specific job requirements. Envoy has numerous options to consider when energy savings is desired.

LAMP OPTIONS

Pulse Start Metal Halide/High Pressure Sodium/Compact Fluorescent/Induction-Lamp choice should be the first consideration when addressing energy concerns. Various lamp technologies offer different capabilities in the amount of light that is achievable per consumed watt [defined as efficacy], and the expected lifetime of the light source.

Watts/Lamp Type	Bulb Type	ANSI Code	Nominal Lamp Watts	Initial Lumens	Life [Hours]	
175w MH	Clear	ED17	M57	175	14,000	10,000
200w MP	Clear	ED17	M136	200	21,000	12,000
175w MP	Clear	ED17	M152	175	17,500	15,000
150w MP	Clear	ED17	M102	150	14,000	15,000
100w MP	Clear	ED17	M90	100	9,000	15,000
150w HPS	Clear	ED17	S55	150	16,000	24,000
100w HPS	Clear	ED17	S54	100	9,500	24,000
70w CF	Coated	GX24q-6	--	70	5,200	12,000
57w CF	Coated	GX24q-5	--	57	4,300	12,000
42w CF	Coated	GX24q-4	--	42	3,200	12,000
85w Induction	Coated	P41	--	85	6,000	100,000

NOTE: Values are per [1] lamp. Information varies; consult manufacturer for specific information.

CONTROL OPTIONS

Consider Envoy's available control options to vary output and save energy. By harvesting available daylight along garage perimeters, designers can strategically place sensor activated luminaires that can be dimmed during daylight hours. Photo sensors, timers and motion sensors [all available by others] are all viable control methods that can be used to promote energy savings during daytime operating hours.

Hi/Low Dimming [HL]: Available with specific HID lamps and CWA ballast circuits, this option features a PC board within Envoy that allows step dimming through low voltage wires hooked to a control module, making it ideal to harvest natural daylight along perimeters of open parking structures. Compared to the same fixture at full power, this method offers an astounding energy savings of approximately 51% in low power mode.

CF Multi-Switching: Compact Fluorescent makes energy savings possible through dimming or by using multiple lamps and circuits. Fixtures with multiples of two, three and four lamps are able to save energy 33-50% by simply switching 1 or 2 lamps off.

Electronic Ballasts: HID electronic ballasts can be used integrally or remote mounted to save energy 12-15% over magnetic technology and up to 50% energy savings with dimmable electronic ballasts.

Lamp Source	Average Input Watts	Number of Fixtures ⁴	Hours ⁵	Days/Year	\$/kW-hr ⁶	Yearly Cost [\$]	Total Savings Per Year [\$]
175W MP [Full Power]	208 ¹	1250	12	365	.1065	121,282	
175W MP [Low Power] ²	101 ²	1250	12	365	.1065	58,892	62,390
[4] 42W CF [4 Lamps-Full Power]	186	1250	12	365	.1065	108,454	
[4] 42W CF [2 Lamps-Low Power] ³	93	1250	12	365	.1065	54,227	54,227

NOTE: 1 Magnetic ballast CWA circuit. 2 Pulse Start Metal Halide using HL option with Lumark CML Industrial HID dimming system. 3 Compact Fluorescent lamps using 4CF2 option. Lamps are wired on 2 separate circuits. Control management by others. 4 Fixture quantity and amount of usable daylight may vary in garage application and design. 5 12 hour low power mode used for example, applications may vary.

6 Average national cost per kilo-watt hour, DOE 2007



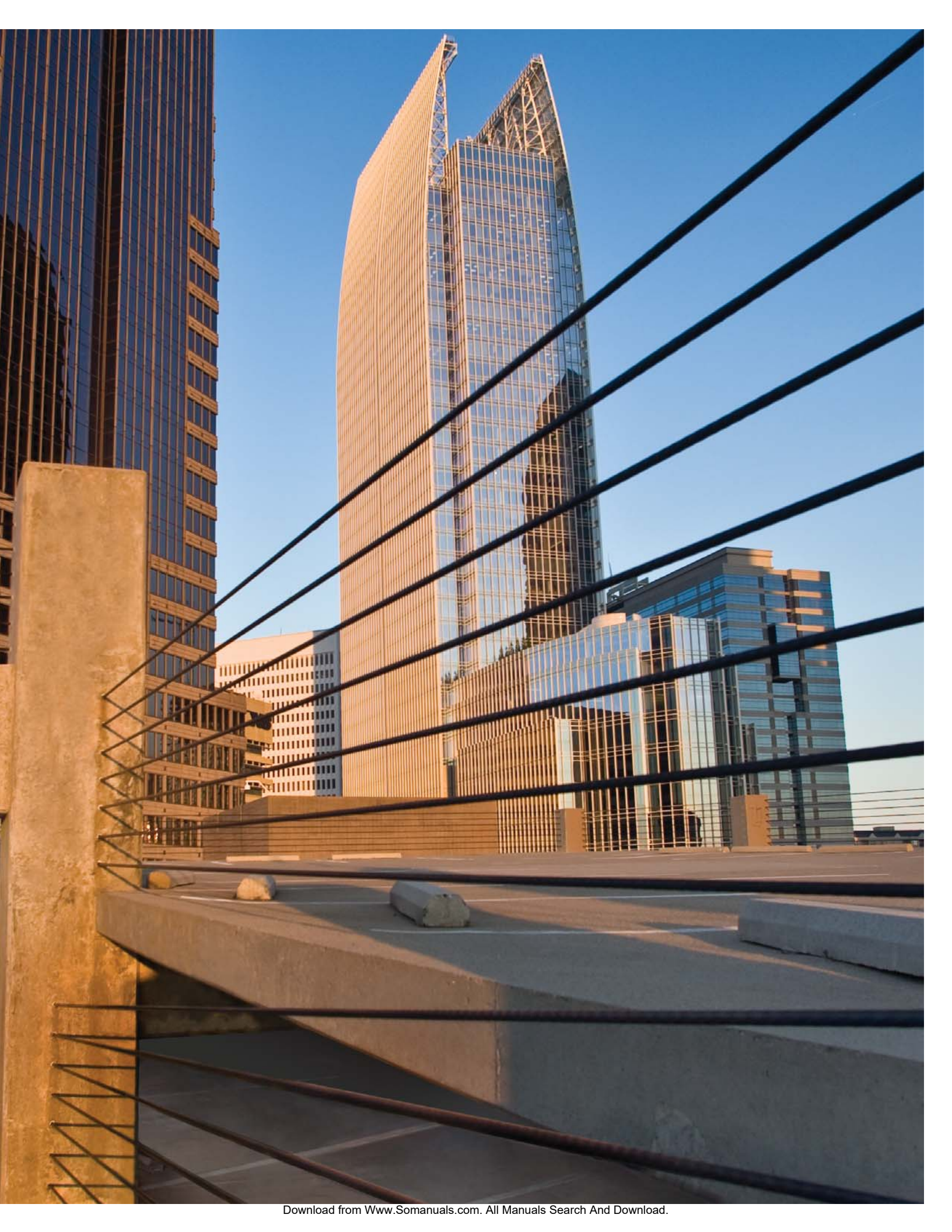

SPECIFICATION FEATURES

CONSTRUCTION

Low copper, one-piece aluminum die-cast electrical housing features heavy cast walls designed for effective heat dissipation and resistance to corrosion. Toolless release aluminum die-cast latches securely hold lens in place and aid in efficient installation and maintenance. A tamper resistant option is available to prevent unauthorized access. Envoy is IP66 rated, promoting long term optical efficiency while allowing for fast efficient cleaning by power washing. All gaskets contained within Envoy are silicone material including lens gasket and housing wire grommet.

OPTICAL

Lens: Lens employs a 2 part system [upper and lower] by which the reflector is accurately located and securely locked in place. Injection molded, virgin Acrylic material is standard due to its ability to resist radiation from UV and for its superior clarity [polycarbonate is available]. Lens is attached via two [2] toolless die-cast latches. When released, lens will hinge off housing and remain captive on one side to allow for easy, obstruction free lamp placement or electrical access. Lens perimeter is completely sealed at housing junction using a one-piece extruded, vulcanized silicone gasket. **Reflectors:** Envoy reflectors use premium materials and a durable finish process to ensure longevity of optical performance. The 3-part reflector system employs a bright specular Alzak®

anodized aluminum hydro-formed main reflector, a diffuse anodized aluminum hydro-formed upper reflector and die-formed premium 95% reflective, specular pre-anodized sheet aluminum inserts. A choice of three [3] different optical distributions with a variety of light controlling media may be used to optimize lighting performance.

ELECTRICAL

Electrical components are hard mounted to electrical housing for optimal heat dissipation. HID units use medium-base 4KV pulse rated sockets with standard magnetic, high power factor ballasts [minimum starting -30°C/-22°F MH-MP, -40°C/-40°F HPS]. Compact Fluorescent [CF] units use 4-pin lamp sockets with standard high power factor electronic ballast [minimum starting -18°C/0°F]. Induction lamp features a high frequency, high power factor generator [available in 100-120V or 200-277V, minimum starting -25°C/-13°F]. The electrical reflector cover is keyed and accessed via two [2] toolless thumbscrews.

MOUNTING

Standard fixture mounts to a square or octagonal 4" surface or recessed mounted j-box via electro-zinc plated, heavy-gauge "quick mount release" bracket system, complete with stainless steel hanger which allows for "hands-free" wiring connection. "Quick Mount System" enables efficient fixture mounting, wiring connection

inspection and fixture removal. Quick mount plate features stainless steel springs that help absorb vibration. A variety of other mounting options and accessories including free swinging balanced Pendant Box/Bird Guard [PBG], Trunion Mount [TM] and Wall Mount [WM] arm are available.

EGRESS OPTIONS

Envoy offers multiple egress lamp sources including quartz halogen, compact fluorescent and MR16 quartz halogen, available in multiple circuit options. Compact fluorescent battery packs are available integral within fixture or remote mount in various wattage configurations.

FINISH

Housing is finished in 5 stage premium TGIC polyester powder coat paint, 2.5 mil nominal thickness for superior protection against fade and wear. Envoy is supplied standard in grey and is available in black, white and bronze. RAL and custom color matches available.

PATENTS PENDING



Lens



Toolless Latch



Reflector



Certifications

IP66 Rated	U.L. 1598 Listed	2G Vibration Tested
C-UL Listed	40°C Ambient*	ISO 9001

NOTES: * Varies by model.



Wire Grommet

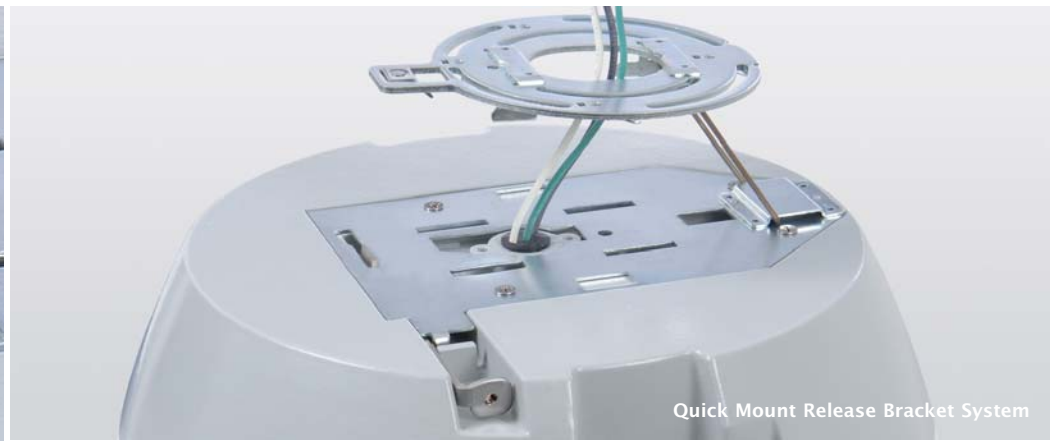

Quick Mount Release Bracket System



Lens Gasket

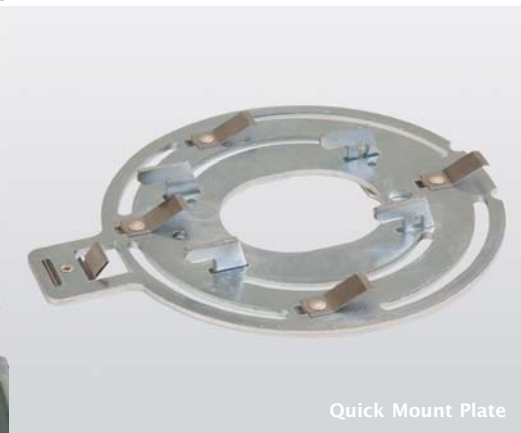

Quick Mount Plate



Release Lever

OTHER OPTIONS

VANDAL RESISTANT SOLUTIONS

In applications where vandalism is a concern, a typical solution is to mount the luminaires out of reach. Mounting at elevated heights predictably results in lower light levels. To address vandalism Envoy has inherent, robust design features and various options to help prevent damage and unauthorized access.



TAMPER RESISTANT [TR]

This option features tamper resistant stainless steel hardware for lens, lens latches and fixture slide release mechanism. Head type T20 Torx™ center-pin reject type fasteners are provided. Vandal resistant screwdriver is available [separately as an accessory].

LUMINAIRE DESIGN

Envoy's lens section ranges in thickness from minimum 0.125" in optical area to 0.250" in latch and fastening area for a robust design. A polycarbonate upper and lower lens option is available for additional impact strength.

TASK LIGHT [TL] APPLICATIONS

For complex lighting needs that require adjustability and flexibility, consider how the task light option can best offer solutions. This option features an MR16 lamp source available in 120v and 12v lamp types with a wide variety of beam patterns. Task lights can be used to bring visual attention to dedicated pathways that enter and exit the garage. Areas of high congestion may also benefit through use of multiple task lights when negotiation between vehicles and pedestrians is prominent. Illuminating stairwells, signage, parking appliances and pay booths for general and emergency lighting needs demonstrates the true and complete functionality of the task light feature.

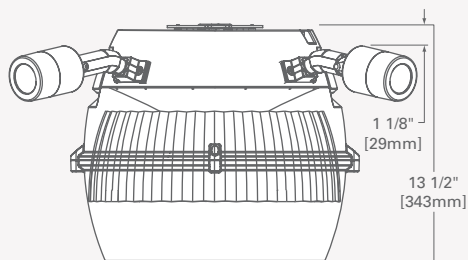

Task light locations are specified by zones, A1-A4. Up to four [4] task lights are possible depending on specific configurations of the luminaire [see ordering information and footnotes].

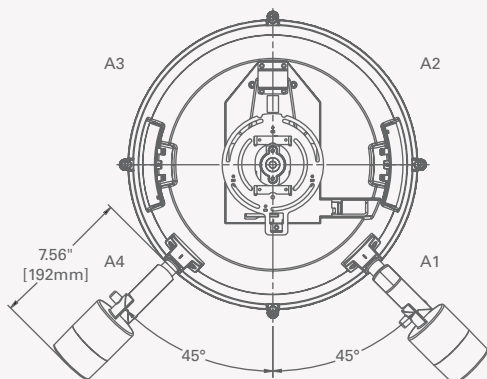

EPL ENVOY

ORDERING INFORMATION

SAMPLE NUMBER: EPL-175-MP-MB-MT-TG-AP-L-EM/SC

PRODUCT FAMILY	LAMP WATTAGE			LAMP TYPE	BALLAST	VOLTAGE ⁵	DISTRIBUTION	COLOR	OPTIONS + ACCESSORIES
	MH ¹	HPS	CF	MH=Metal Halide	MB=Magnetic Ballast ³	120=120V	RD=Round	[add as suffix/must specify]	[See Below]
EPL=Envoy	175=175W	70=70W	84= [2] 42W	MP=Pulse Start Metal Halide	EB=Electronic Ballast ⁴	208=208V	SQ=Square		
Parking Luminaire	MP ²	100=100W	114= [2] 57W	HPS=High Pressure Sodium		240=240V	TG=Rectangular		
	70=70W	150=150W	126= [3] 42W	CF=Compact Fluorescent		277=277V		AP=Grey	
	100=100W	Induction	140= [2] 70W	QL=Induction		480=480V		BK=Black	
	150=150W	85= 85W	168= [4] 42W			DT=Dual-Tap w/277V ⁶		BZ=Bronze	
	175=175W					MT=Multi-Tap w/277V ⁶		WH=White	
	200=200W					TT=Triple-Tap w/347V ⁶			

OPTIONS + ACCESSORIES [Must be listed in the order shown and separated by a dash]

OPTIONS⁷ [add as suffix]

CD=Concentrated Downlight [Restricts Uplight 360°]⁸
 CT=Conduit Taps [Qty [2] 3/4" NPSM]⁹
 F=Single Fuse [Specify 120, 277 OR 347 in "Voltage" column]
 FF=Double Fuse [Specify 208, 240 OR 480 in "Voltage" column]
 HA=40° C Ambient¹⁰
 HL=Hi/Low Dimming¹¹
 L=Lamp Included, HID
 LF=Lamp Included, Compact Fluorescent
 LQ=Lamp Included, Quartz Halogen DCB
 PH=Upper Polycarbonate Lens [Near Aluminum Back Housing]
 PL=Lower Polycarbonate Lens
 QD=Quick Disconnect[s] [between cover/housing]
 TMB=Trunnion Mount with Connection Box [some assembly required]
 TMC=Trunnion Mount with Power Cord [some assembly required]
 TR=Tamper Resistant [Torx T20 CPR]
 WL=24" Lead Wires

STANDBY + EGRESS LAMP OPTIONS

Q=Quartz Restrike [hot restrike only, 120v T4 DCB quartz lamp]¹²
 EM=Quartz Time Delay [hot and cold restrike, 120v T4 DCB quartz lamp]¹²
 EM/SC=Emergency Separate Circuit [120v T4 DCB quartz lamp]¹²
 __CFSC=CF [1] Separate Circuit [Specify 52, 64 or 84, supplied with 120-277v electronic ballast]¹³
 __CFHR=CF Hot Restrike Relay [Specify 52, 64 or 84, supplied with 120-277v electronic ballast]¹³
 __CFTR=CF Time Delay Relay [Hot and Cold Restrike] [Specify 52, 64 or 84, supplied with 120-277v electronic ballast]¹³
 CFRB=CF Remote Battery Pack, sockets accommodate 26-42w CF lamps [Battery Pack specified/supplied/wired by Others]¹³
 36CFIB=CF Integral Battery Pack operates [2] 18w CFL¹⁴
 CFRBT=CF Remote Battery Pack with Time Delay Relay, sockets accommodate 26-42w CF lamps [Battery Pack specified/supplied/wired by Others]¹³
 36CFIBT=CF Integral Battery Pack operates [2] 18w CFL with Time Delay Relay¹⁴
 RBP=Remote Battery Pack, sockets accommodate 26-42w CF lamps [CF units only; Battery Pack specified/supplied/wired by Others]¹⁵
 42IBP=Integral Battery Pack, [1] 42w CF lamp standby¹⁶
 42ICB=Integral Cold Weather Battery Pack, [1] 42w CF lamp standby¹⁷
 4CF3=4 CF lamps wired as 3 independent circuits, 3 electronic ballasts [2 lamps/1 lamp/1 lamp]¹⁸
 4CF2=4 CF lamps wired as 2 independent circuits, 2 electronic ballasts [2 lamps/2 lamps]¹⁸
 3CF2=3 CF lamps wired as 2 independent circuits, 2 electronic ballasts [2 lamps/1 lamp]¹⁹
 2CF2=2 CF lamps wired as 2 independent circuits, 2 electronic ballasts [1 lamp/1 lamp]²⁰
 TL__=Task Light 120v MR16 [GU10 Twist Lock Base]²¹
 2TL__=[2] Task Lights 120v MR16 [GU10 Twist Lock Base]²¹
 TLQ__=Task Light 120v MR16 wired to Hot Restrike Relay [GU10 Twist Lock Base]²²
 2TLQ__=[2] Task Lights 120v MR16 wired to Hot Restrike Relay [GU10 Twist Lock Base]²²
 TLEM__=Task Light, 120v MR16 wired to Time Delay Relay [GU10 Twist Lock Base]²²
 2TLEM__=[2] Task Lights, 120v MR16 wired to Time Delay Relay [GU10 Twist Lock Base]²²
 TL12V__=Task Light, 12v MR16 [GU5.3 Bi-Pin Base]²³
 2TL12V__=[2] Task Lights, 12v MR16 [GU5.3 Bi-Pin Base]²³
 TL__MR__=Task light with transformer [GU5.3 Bi-Pin Base, specify 50 or 75w lamp, specify 120 or 277v transformer]²⁴

ACCESSORIES²⁵ [order separately/replace XX with color designation]

EPL/PBG-XX=Balanced Pendant Box/Bird Guard
 EPL/WM-XX=Wall Mount Arm²⁶
 EPL/HS=House Side Shield Up and Downlight 120° Coverage [HID Lamps Only]²⁷
 EPL/HSCF=House Side Shield Up and Downlight 120° Coverage [CF Lamps Only]²⁷
 EPL/DLS=Drive Lane Shield²⁸
 VRSD=T20 Torx CPR Tamper Resistant Screwdriver
 EPL/TL=Task Light Field Install Kit for 120V MR16 lamp [GU10 Base]
 EPL/TL12V=Task Light Field Install Kit for 12V MR16 lamp [GU5.3 Base]

DIMENSIONS

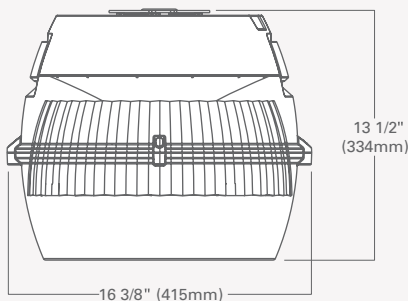

STANDARD COLORS

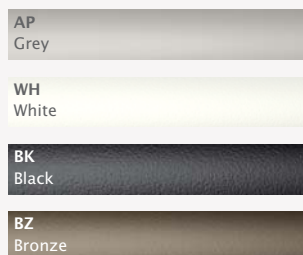

SHIPPING DATA

Net Weight [21 lbs.] Volume [2.1 cu. ft.]

WATTAGE TABLE

LAMP TYPE	WATTAGE
Metal Halide	175W
High Pressure Sodium	70, 100, 150W
Pulse Start Metal Halide	70, 100, 150, 175, 200W
Compact Fluorescent	[2] 42, [2] 57, [3] 42, [2] 70, [4] 42W
Induction	85W

CERTIFICATIONS

IP66 Rated	
40°C Ambient Temperature*	NOTE: * Varies by model.
C-UL/U.L. 1598 Listed Wet Location	
2G Vibration Tested	
ISO 9001	

NOTES: 1 Metal Halide lamps with probe start circuit. 2 Pulse Start Metal Halide circuit includes igniter. 3 HID lamps only. 4 Must specify voltage. EB standard on CF. Available integrally in HID 100w MP [max] and 85w QL. HID availability may vary by lamp source, wattage and voltage. For HID wattages higher than 100w, remote mount ballast possible within 5 feet of unit. Consult customer service. 5 Product also available in non-US voltages and 50Hz for international markets. Must specify voltages for battery packs. Consult your customer service representative for availability and ordering information. 6 Dual tap ballast is 120/277V wired 277V. Multi-tap ballast is 120/208/240/277V wired 277V. Triple tap ballast is 120/277/347 wired 347V. 7 Add as suffix in order shown. 8 Requires option PL for use in 40°C application with HID lamps 175-200w. 9 CT option required for through branch wiring. Through branch wiring is not available with specific configurations including HID CF egress options and fixtures with integral battery pack. 10 Not available with 85w QL and options using CF lamp sources. Requires option PH on 200-175w HID. 11 Available in 150-200w MP, 175w MH and 70-150w HPS. Operates on 24VDC type output control module. Circuit relay board is mounted internal to fixture housing with leads exiting back. Requires low voltage wires to control module to be routed in conduit. 12 For use with HID primary lamp only. Quartz lamp 100w maximum. 13 For use with 175w [max] or less HID primary lamp only. Requires option "CT". Uses [2] 4 pin CF lamps. CF minimum starting temperature 0°F [-18°C]. RB requires "CT" option 14 For use with 150w [max] or less HID primary lamp only. Uses [2] 18w 4 pin CF lamps. Battery rated minimum 32°F / 0°C. Specify 120 or 277v in "VOLTAGE" column. 15 For use with 168, 126, 84 CF units only. Requires option "CT". Battery supplied by others. Standby lamp combination wired by others. 16 For use with 168, 126, 84 CF units only. Battery rated minimum 32°F / 0°C. Specify 120 or 277v in "VOLTAGE" column. 17 For use with 168, 126, 84 CF units only. Battery rated minimum -4°F / -20°C. Specify 120 or 277v in "VOLTAGE" column. 18 For use with 168 CF only. 19 For use with 126 CF only. 20 For use with 84, 114, or 140 CF only. 21 Task Light[s] with separate leads through back of fixture. Specify TL location by adding to back of option logic [ex.2TLA1A2]-see diagram. Some assembly required, order lamps separately. 22 For use with HID lamps only. Task Light[s] supplied wired to relay. Specify TL location by adding to back of option logic [ex.2TLA1A2]-see diagram. Some assembly required, order lamps separately. 23 Task Light[s] supplied with separate leads through back of fixture for connection to 12v circuit or battery system. Specify TL location by adding to back of option logic [ex.2TLA1A2]-see diagram. Some assembly required, order lamps separately. 24 Task Light max quantity [1], supplied with transformer. Specify TL location by adding to back of option logic [ex.2TLA1A2]-see diagram. Some assembly required, order lamps separately. 25 Order separately, replace XX with color suffix 26 Luminaire requires option WL. 27 Order additional shield set for more coverage [ex. 2 sets for 180° shielding] Maximum of 2 sets total. 28 Placed towards side of oncoming traffic for 60° shielding coverage. Order [2] for 2-Way traffic lanes. 29 Some options and accessories are not available in all configurations. Consult your customer service representative for ordering information. 30 Specifications and dimensions subject to change without notice.

Cooper Lighting

Customer First Center
1121 Highway 74 South
Peachtree City, GA 30269

P: 770-486-4800
F: 770-486-4801

www.cooperlighting.com

International Sales, USA

Cooper Lighting
1121 Highway 74 South
Peachtree City, GA 30269

P: 770-486-4800
F: 770-486-4801

Canada

Cooper Lighting
5925 McLaughlin Road
Mississauga, Ontario L5R 1B8

P: 905-507-4000
F: 905-568-7049

The Cooper Lighting Family

Halo
Metalux
Lumark
Sure-Lites
Neo-Ray
Corelite
Portfolio
Iris
Shaper
io
Lumière
Invue
McGraw-Edison
Streetworks
Fail-Safe
MWS
DLS
RSA
Ametrix

Domestic Facilities

Cranbury, New Jersey
Elk Grove Village, Illinois
Irving, Texas
Ontario, California
Peachtree City, Georgia

Canadian Facility

Calgary, Alberta T2E 7V9

Cooper Lighting and McGraw-Edison are valuable trademarks of Cooper Industries in the United States and other countries.
You are not permitted to use the Cooper Trademarks without the prior written consent of Cooper Industries.

Cooper Industries, Ltd.
600 Travis, Ste. 5800
Houston, TX 77002-1001
P: 713-209-8400
www.cooperindustries.com

Free Manuals Download Website

<http://myh66.com>

<http://usermanuals.us>

<http://www.somanuals.com>

<http://www.4manuals.cc>

<http://www.manual-lib.com>

<http://www.404manual.com>

<http://www.luxmanual.com>

<http://aubethermostatmanual.com>

Golf course search by state

<http://golfingnear.com>

Email search by domain

<http://emailbydomain.com>

Auto manuals search

<http://auto.somanuals.com>

TV manuals search

<http://tv.somanuals.com>