

ARC GENERATION SERIES

ARCHITECTURAL DECORATIVE LUMINAIRE

50-400W
MH/HPS/QL



STREETWORKS™

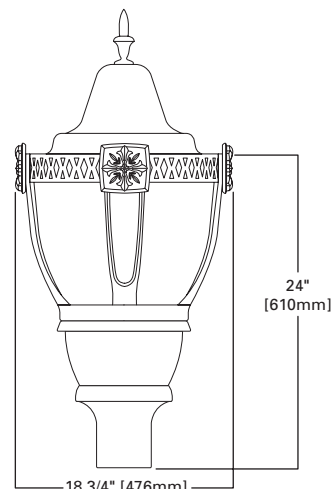

GLOBE

Refractive globe is a 9" high efficiency UV resistant acrylic or optional polycarbonate design and utilizes a combination of refractive and reflective prisms for optional Type III or V distributions. Globes maintain consistency in form and photometric performance between both distributions. Polycarbonate not recommended for MH applications.

HOUSING

Heavy duty-cast aluminum housing and door. Wide handhole provide toolless entry for access to plug-in starters and optional NEMA twistlock PCR. 1" ANSI wattage/source label. Fixture is 3G vibration rated.

ELECTRICAL

Available up to 400W MH and 250W HPS. Ballast assembly is mounted on a removable tray with quick disconnects for ease of installation and maintenance. Plug in starter standard when applicable. Terminal block is hard mounted to the casting and easily accessible through the door's wide entryway. UL listing and optional induction fluorescent lamp available.

CAGE ASSEMBLIES

All uprights are manufactured of cast aluminum. Banding is extruded aluminum. All cage assemblies are mounted to the exterior of the housing via four (4) stainless steel fasteners. A variety of finishes are available.

TOPS + FINIALS

All hard mount tops are made of spun aluminum and all glow tops are manufactured of acrylic. Finials are manufactured of cast aluminum.

MOUNTING

Post top mount fits 3" OD tenons. Four (4) stainless steel fasteners standard.

FINISH

Standard polyester powder coat finish in black. For more color options see optional color or consult your Streetworks representative for more information.

EPA:

Effective Projective Area: 2.1

SHIPPING DATA

Approximate Net Weight:
50 lbs. (23 kgs.)

ORDERING INFORMATION

SAMPLE NUMBER: ARC15SWW33112

PRODUCT FAMILY	LAMP WATTAGE ³	LAMP TYPE ³	BALLAST TYPE ³	VOLTAGE ³	REFRACTOR TYPE	CAGE TYPE ⁷	TOP TYPE	FINIAL TYPE	OPTIONS + ACCESSORIES
ARC=Architectural	50=50W 70=70W 85=85W ¹ 10=100W 15=150W 17=175W 25=250W 40=400W ²	M=Metal Halide ⁴ S=High Pressure Sodium Q=Induction	R=Reac./NPF ⁵ H=Reac./HPF N=Hi. Reac./NPF P=Hi. Reac./HPF W=CWA K=10KV CWA ⁶ I=Induction	2=120V 0=208V 4=240V 7=277V 8=480V 9=347V W=Multi-Tap wired 120V N=Multi-Tap wired 277V	33=Type III 55=Type V	1=CLASSICAL A=Classical/Sun Gold B=Classical/Antique Gold C=Classical/Colonial Bronze 2=MODERN D=Modern/Sun Gold E=Modern/Antique Gold F=Modern/Colonial Bronze 3=ARCHITECTURAL G=Architectural/Sun Gold H=Architectural/Antique Gold J=Architectural/Colonial Bronze X=None	1=Acorn 2=Modern 3=Victorian 4=Classical 6=Nostalgic (Top Access) 7=Architectural (Top Access)	1=Victorian 2=Modern 3=Architectural 4=Nostalgic X=None	(See Below)

OPTIONS + ACCESSORIES [Must be ordered in alphanumeric order]

OPTIONS (add as suffix)
 1=Single Fuse (120 or 277V)
 2=Double Fuse (208, 240 or 480V)
 4=Internal NEMA photocontrol Receptacle
 P=Polycarbonate Refractor⁸
 WH=White
 BZ=Bronze
 AP=Grey
 DP=Dark Platinum
 H=Hartford Green
 A=Twistlock Refractor
 R=Internal Downlight Reflector
 U=UL/CSA Listed
 B=Decorative Brass Banding⁹

ACCESSORIES (order separately)
 AA2000=House Side Shield—Mogul-base Socket
 AA2001=House Side Shield—Medium-base Socket

OPTIONAL COLORS [Standard color is black, other finish colors available. Consult your Cooper Lighting representative]



OPTIONAL METALLIC COLORS [Classical, Modern, and Architectural Cage Type Only]⁷



NOTE: 1 Induction only. 120/240V only. 2 400W available only in Metal Halide. Not Available in 480V. 3 Refer to technical section for lamp/ballast/voltage compatibility. 4 Medium-base socket standard for 150 watt and below Metal Halide. 5 Available 120V only. 6 Available 50-150W, 120/240 or single voltage only. 7 Cage Type 1, 2, 3 will be finished same color as base. 8 Polycarbonate parts used with metal halide or mercury vapor lamps will eventually yellow. 9 When brass banding is chosen, finial finished in gold.

PHOTOMETRICS [Complete IES files available at www.cooperlighting.com]

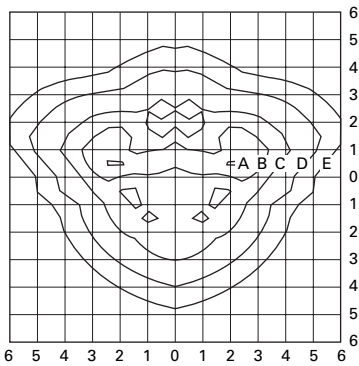

ARC15S31.IES
150-Watt HPS
16,000-Lumen Clear ED-23.5 Lamp
Type III Acrylic Refractor

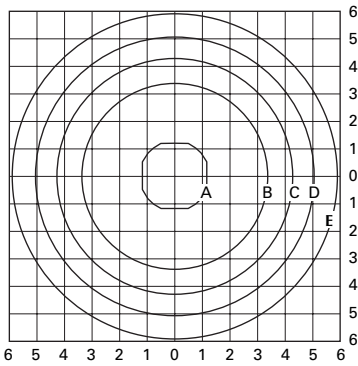

ARC15S51.IES
150-Watt HPS
16,000-Lumen Clear ED-23.5 Lamp
Type V Acrylic Refractor

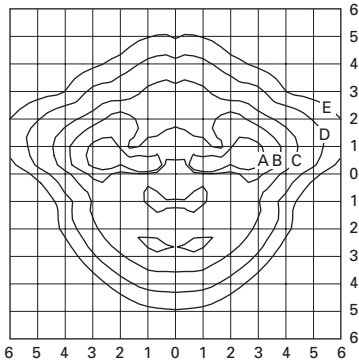

ARC17M31R.IES
175-Watt MH
14,000-Lumen Clear ED-28 Lamp
Type III Acrylic Refractor

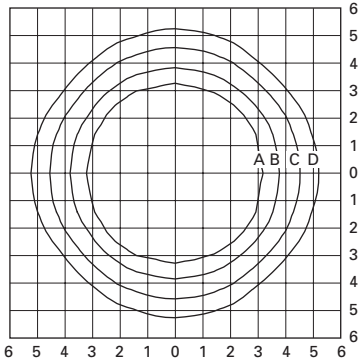

ARC17M51.IES
175-Watt MH
14,000-Lumen Clear ED-28 Lamp
Type V Acrylic Refractor

Footcandle Table

Select mounting height and read across for footcandle values of each isofootcandle line. Distance in units of mounting height.

Mounting Height	Footcandle Values for Isofootcandle Lines				
	A	B	C	D	E
ARC15S31.IES					
10'	4.50	2.25	1.12	0.45	0.22
15'	2.00	1.00	0.50	0.20	0.10
20'	1.12	0.56	0.28	0.11	0.05

ARC15S51.IES					
10'	2.25	1.12	0.45	0.22	0.11
15'	2.00	1.00	0.50	0.20	0.10
20'	0.56	0.28	0.11	0.05	0.02

FOOTCANDLE TABLE

Select mounting height and read across for footcandle values of each isofootcandle line. Distance in units of mounting height.

Mounting Height	Footcandle Values for Isofootcandle Lines				
	A	B	C	D	E
ARC17M31R.IES					
10'	8.00	4.00	2.00	0.80	0.40
15'	3.40	1.70	0.85	0.34	0.17
20'	2.00	1.00	0.50	0.20	0.10

ARC17M51.IES					
10'	2.25	1.12	0.45	0.22	
15'	1.00	0.50	0.20	0.10	
20'	0.56	0.28	0.11	0.05	

CONFIGURATIONS

CAGE TYPE

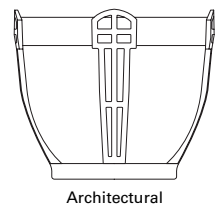
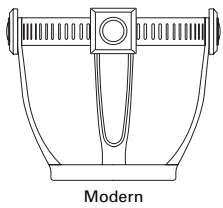
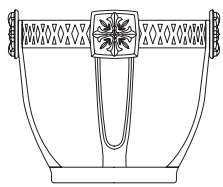

TOP TYPE

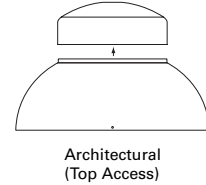
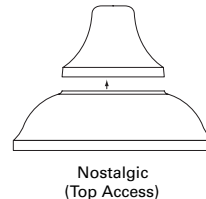
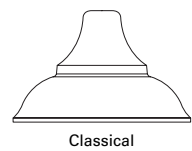
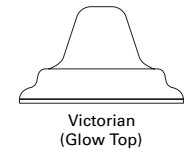
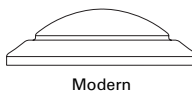
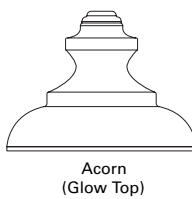

FINIAL TYPE

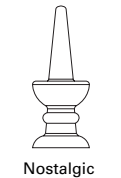
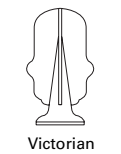
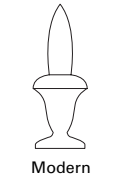
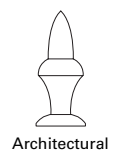

Free Manuals Download Website

<http://myh66.com>

<http://usermanuals.us>

<http://www.somanuals.com>

<http://www.4manuals.cc>

<http://www.manual-lib.com>

<http://www.404manual.com>

<http://www.luxmanual.com>

<http://aubethermostatmanual.com>

Golf course search by state

<http://golfingnear.com>

Email search by domain

<http://emailbydomain.com>

Auto manuals search

<http://auto.somanuals.com>

TV manuals search

<http://tv.somanuals.com>