

ANG MANCHESTER

DECORATIVE GLASS LUMINAIRE

70-175W
MH/HPS



STREETWORKS™

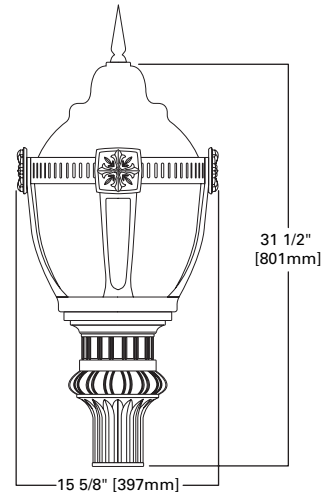

FINIAL

Cast finial optional. Finial painted to match cast housing.

GLOBE

Borosilicate two-piece prismatic glass refractor, available in either a Type III or Type V distribution.

CAGE OR BAND

Optional decorative cage or band is available. Cage uprights are manufactured of cast aluminum. Bands are extruded aluminum. Finish colors match housing color choice. Optional gold anodized band available. Other finish colors available. Consult your Streetworks Representative.

HOUSING

Heavy-duty cast aluminum housing. Optional NEMA PCR is accessible through door assembly. Provided with 1" ANSI wattage source label.

BALLAST

Ballast provided with a power tray assembly for ease of maintenance. Mogul-base is standard for 70W through 150W HPS and 175W MH. 70W through 150W MH use medium-base. Standard plug-in starter when applicable. U.L. Listing is available.

MOUNTING

Post top mount fits 3" O.D. tenons and secures in place with four (4) allen-head set screws.

FINISH

Standard polyester powder coat finish in black. For more color options see optional color or consult your Streetworks representative for more information.

EPA:

Effective Projective Area: 1.6

SHIPPING DATA

Approximate Net Weight:

60 lbs. (27 kgs.)

ORDERING INFORMATION

SAMPLE NUMBER: ANG17MWW33431

PRODUCT FAMILY	LAMP WATTAGE ¹	LAMP TYPE ¹	BALLAST TYPE ¹	VOLTAGE ¹	REFRACTOR TYPE	CAGE/BAND TYPE	TOP TYPE	FINIAL TYPE ⁴	OPTIONS + ACCESSORIES (See Below)
ANG=Manchester	70=70W 10=100W 15=150W 17=175W	M=Metal Halide ² S=High Pressure Sodium	R=Reac./NPF ³ H=Reac./HPF N=Hi. Reac./NPF P=Hi. Reac./HPF W=CWA	2=120V 0=208V 4=240V 7=277V 8=480V 9=347V W=Multi-Tap Wired 120V N=Multi-Tap Wired 277V	33=Type III 55=Type V	1=Classical A=Classical/Sun Gold B=Classical/Antique Gold C=Classical/Colonial Bronze 4=Gold Anodized Band ⁴ 5=Painted Band X=None	3=Victorian	1=Victorian 2=Modern 3=Architectural 4=Nostalgic 5=Old World X=None	

OPTIONS + ACCESSORIES [Must be ordered in alphanumeric order]

OPTIONS (add as suffix)
 1=Single Fuse (120 or 277V)
 2=Double Fuse (208, 240, or 480V)
 4=Internal NEMA photocontrol Receptacle
 BZ=Bronze
 AP=Grey
 DP=Dark Platinum
 H=Hartford Green
 U=UL/CSA Listed

ACCESSORIES (order separately)
 AA3000=House Side Shield—Mogul-base Socket
 AA3001=House Side Shield—Medium-base Socket

OPTIONAL COLORS [Standard color is black, other finish colors available. Consult your Cooper Lighting representative]

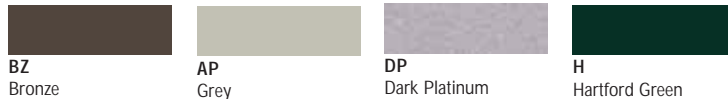

NOTE: 1 Refer to technical section for lamp/ballast/voltage compatibility. 2 Medium-base socket standard for 150W and below MH. 3 Available in 120V only. 4 When gold anodized band is chosen, finial finished in gold.

PHOTOMETRICS [Complete IES files available at www.cooperlighting.com]

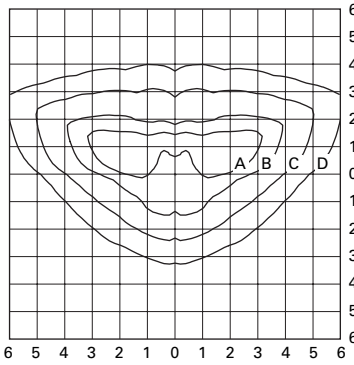

ANG15S33.IES
150-Watt HPS
16,000-Lumen Lamp
Type III Glass Refractor

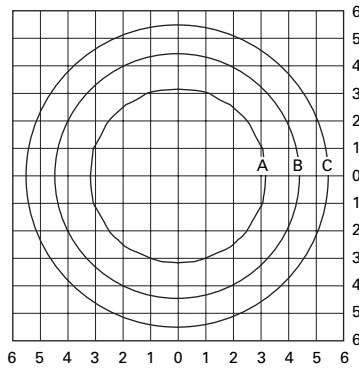

ANG15S55.IES
150-Watt HPS
16,000-Lumen Lamp
Type V Glass Refractor

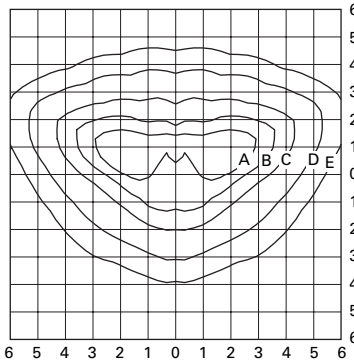

ANG17M33.IES
175-Watt MH
14,000-Lumen Lamp
Type III Glass Refractor

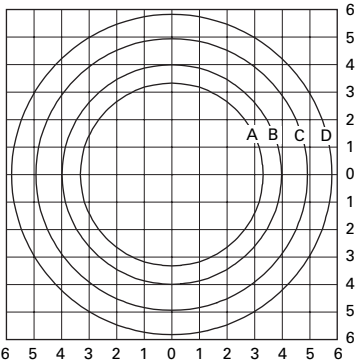

ANG17M55.IES
175-Watt MH
14,000-Lumen Lamp
Type V Glass Refractor

FOOTCANDLE TABLE

Select mounting height and read across for footcandle values of each isofootcandle line. Distance in units of mounting height.

Mounting Height	Footcandle Values for Isofootcandle Lines			
	A	B	C	D
ANG15S33.IES				
10'	2.25	1.12	0.45	0.22
15'	1.00	0.50	0.20	0.10
20'	0.56	0.28	0.11	0.05

ANG15S55.IES

10'	1.12	0.45	0.22
15'	0.50	0.20	0.10
20'	0.28	0.11	0.05

FOOTCANDLE TABLE

Select mounting height and read across for footcandle values of each isofootcandle line. Distance in units of mounting height.

Mounting Height	Footcandle Values for Isofootcandle Lines				
	A	B	C	D	E
ANG17M33.IES					
10'	2.00	1.00	0.50	0.20	0.10
15'	0.88	0.44	0.22	0.09	0.04
20'	0.50	0.25	0.3	0.05	0.03

ANG17M55.IES

10'	1.00	0.50	0.20	0.10
15'	0.44	0.22	0.09	0.04
20'	0.25	0.3	0.05	0.03

FINIAL OPTIONS [Painted to match housing]

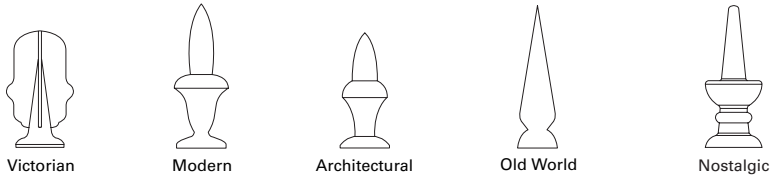

Free Manuals Download Website

<http://myh66.com>

<http://usermanuals.us>

<http://www.somanuals.com>

<http://www.4manuals.cc>

<http://www.manual-lib.com>

<http://www.404manual.com>

<http://www.luxmanual.com>

<http://aubethermostatmanual.com>

Golf course search by state

<http://golfingnear.com>

Email search by domain

<http://emailbydomain.com>

Auto manuals search

<http://auto.somanuals.com>

TV manuals search

<http://tv.somanuals.com>