

DESCRIPTION

"The Europa" embodies the highest attention to architectural design and detail as well as lighting performance. This luminaire creates a balanced, visually comfortable environment. Perforated metal side panels facilitate a soft "glow", a parabolic louver controls the independent downlight component, and an articulated joiner provides for an elegant continuous arrangement of luminaires. This truly versatile direct/indirect luminaire is designed to provide three distinct lighting distributions...Indirect, Direct, and Direct/Indirect...by the mere separate switching of the single lamp direct component and the two lamp indirect component.

Catalog #		Type
Project		
Comments		Date
Prepared by		

SPECIFICATION FEATURES

A ... Construction

20-gauge steel housing with staggered round hole pattern backed by white acrylic diffuser. Nominal 3', 4', 6' or 8' illuminated sections.

End Plates

Die-formed aluminum.

B ... Shielding

Parabolic, Semi-Specular Aluminum.

C ... Electrical

120, 277, 347 or Universal Voltage electronic ballast. Fixtures and electrical components certified to UL and CUL standards.

D ... Finish

Durable, low gloss, white, powder coated acrylic finish.

Mounting

Pendant: Single stem (standard); single cable. Canopy: 5" diameter cover (standard).

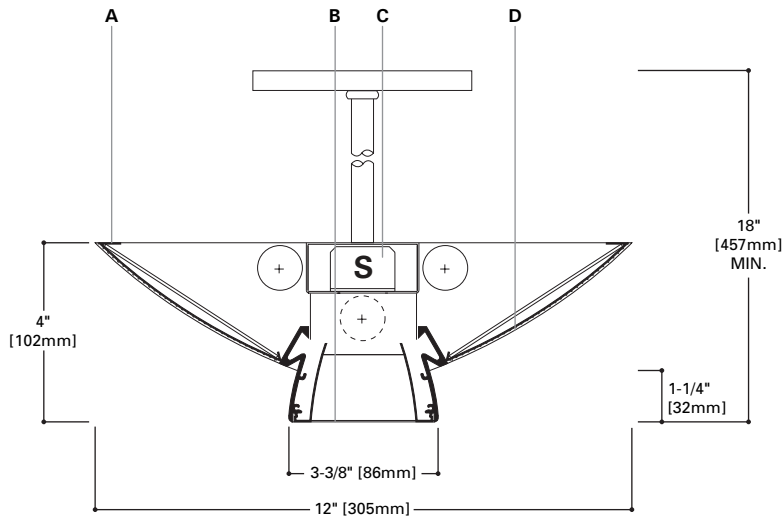

S = Slim Line Ballast only.

Europa 16-DIP 16-IP

2 & 3T8
2 & 3T5
2 & 3T5HO

SUSPENDED
INDIRECT/DIRECT

Light Distribution
Indirect - 66.1%
Direct - 33.9%

Perforated Patterns



Round Hole (Standard)



S - Slotted

ORDERING INFORMATION

Sample Number: S16IP/2T8/ST84/1EB-DU-BP

Series 16: Europa	Light Output I : Indirect DI : Direct/Indirect	Number of Lamps 2 : 2 Lamps 3 : 3 Lamps	Pendant SC : Single Cable ST : Single Stem ¹	Voltage ² 1 : 120V 2 : 277V 3 : 347V	Switching Options SI : Single Switching DU : Double Switching	Perforation SP : Slotted RP : Round BP : None	Fusing GLR : GLR GMF : GMF
	Mounting P : Pendant	Lamp Type T8 : T8 T5 : T5 T5HO : T5HO	Run Length Overall Nominal Run Length ___ ft.	Ballast EB : Electronic Ballast DB : Dimming Ballast		Emergency EM : Emergency Pack	

Notes: 1 Available with 7° or earthquake 45° swivel canopy assembly.
2 Not all options available. Please consult your Cooper Lighting Representative for availability.

PHOTOMETRICS

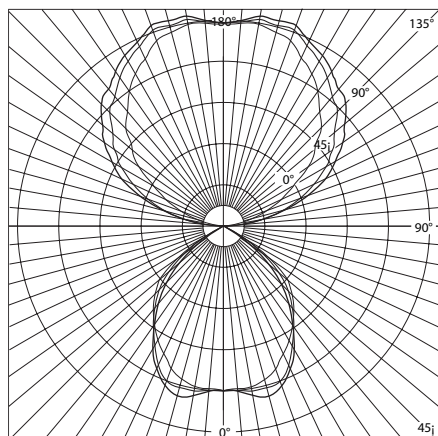

16DIP/3
(All Lamps)
 (3) F32T8/735/RS
 2850 Lumens
 Efficiency 62.5%
 Test Report
 #9055.0

Coefficients of Utilization

rc	Effective floor cavity reflectance									
	80%			50%			30%			
	70	50	30	10	50	30	10	50	30	10
Rw	70	50	30	10	50	30	10	50	30	10
RCR										
1	59	57	61	58	40	39	37	24	23	23
2	61	55	51	47	35	33	31	23	21	20
3	55	49	43	39	31	28	26	20	18	17
4	50	43	37	33	27	24	19	16	14	13
5	46	38	32	28	22	19	16	14	12	11
6	42	34	28	24	22	19	16	14	12	11
7	39	31	25	21	20	16	14	13	11	10
8	36	28	22	19	18	15	12	12	10	08
9	34	25	20	17	16	13	11	11	09	07
10	31	23	18	15	15	12	10	10	08	07

Zonal Lumen Summary

Zone	Lumens	%Lamp	%Fixture
0-30	681	8.0	12.7
0-40	1081	12.6	20.2
0-60	1648	19.3	30.8
0-90	1811	21.2	33.9
90-180	3533	41.3	66.1
0-180	5344	62.5	100.0

Total Luminaire Efficiency = 62.5%

Candela

Angle	Along II	45°	Across ⊥
0	836	836	836
5	842	842	848
15	810	857	895
25	728	787	795
35	625	639	625
45	473	442	424
55	290	247	187
65	102	91	96
75	27	44	62
85	3	18	36
95	30	65	83
105	169	306	326
115	355	512	580
125	537	682	749
135	705	821	883
145	842	925	964
155	952	1016	1039
165	1031	1071	1092
175	1048	1051	1057
180	1043	1043	1043

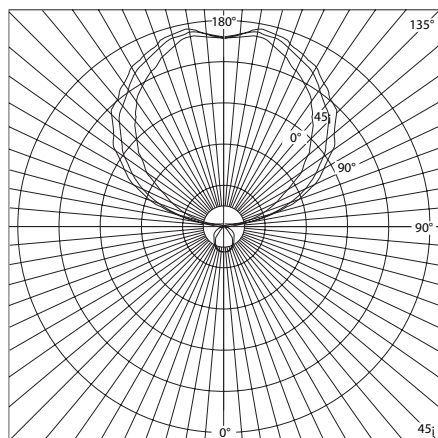
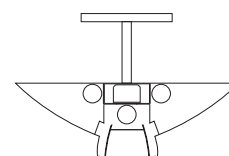

16DIP/3
(Top Lamps Only)
 (2) F32T8/735/RS
 2850 Lumens
 Efficiency 75.0%
 Test Report
 #9056.0

Coefficients of Utilization

rc	Effective floor cavity reflectance									
	80%			50%			30%			
	70	50	30	10	50	30	10	50	30	10
Rw	70	50	30	10	50	30	10	50	30	10
RCR										
1	67	64	61	58	40	39	37	26	25	24
2	61	55	51	47	35	33	31	23	21	20
3	55	49	43	39	31	28	26	20	18	17
4	50	43	37	33	27	24	22	18	16	15
5	46	38	32	28	24	21	19	16	14	13
6	42	34	28	24	22	19	16	14	12	11
7	39	31	25	21	20	16	14	13	11	10
8	36	28	22	19	18	15	12	12	10	08
9	34	25	20	17	16	13	11	11	09	07
10	31	23	18	15	15	12	10	10	08	07

Zonal Lumen Summary

Zone	Lumens	%Lamp	%Fixture
0-30	123	2.2	2.9
0-40	200	3.5	4.7
0-60	338	5.9	7.9
0-90	444	7.8	10.4
90-180	3832	67.2	89.4
0-180	4276	75.0	100.0

Total Luminaire Efficiency = 75.0%

Candela

Angle	Along II	45°	Across ⊥
0	206	206	206
5	207	207	207
15	205	209	210
25	174	179	184
35	146	155	165
45	103	115	125
55	65	82	100
65	30	55	74
75	11	30	50
85	1	14	28
95	31	92	107
105	193	307	368
115	388	457	541
125	568	622	676
135	747	782	827
145	869	887	912
155	976	1008	1000
165	1074	1103	1109
175	1085	1093	1097
180	1089	1089	1089

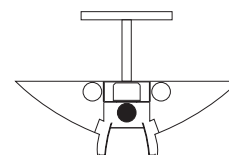

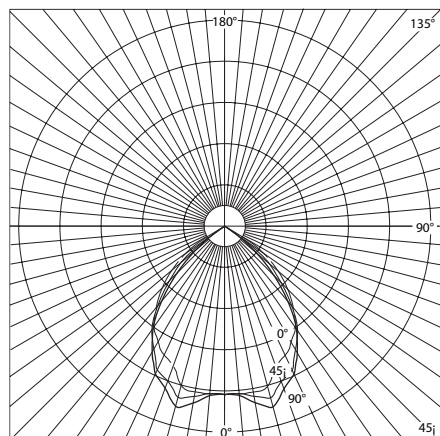

**16DIP/3
(Bottom Lamp Only)**

(1) F32T8/735/RS
2850 Lumens

Efficiency 48.0%

Test Report
#9055.0

Coefficients of Utilization

rc	Effective floor cavity reflectance									
	80%			50%			20%			
rw	70	50	30	10	50	30	10	50	30	10
RCR										
1	54	52	51	50	49	48	47	48	47	46
2	51	48	45	43	45	44	42	44	42	41
3	47	44	41	38	42	39	37	40	38	37
4	44	40	36	34	38	35	33	37	35	33
5	41	36	33	30	35	32	30	34	31	29
6	38	30	26	24	32	29	27	31	28	26
7	35	30	26	24	20	16	14	13	11	10
8	33	27	24	21	26	23	21	26	23	21
9	34	25	20	17	16	13	11	23	20	18
10	28	22	19	17	22	19	16	21	18	16

Candela

Angle	Along ll	45°	Across ⊥
0	687	687	687
5	691	692	698
10	688	706	731
15	680	726	766
20	588	651	662
25	588	651	662
30	545	588	587
35	508	528	511
40	439	433	416
45	378	347	318
50	304	260	203
55	226	171	93
60	136	87	41
65	73	36	19
70	39	16	10
75	19	7	4
80	7	4	3
85	3	1	1
90	0	0	0

Zonal Lumen Summary

Zone	Lumens	%Lamp	%Fixture
0-30	566	19.9	41.3
0-40	894	31.4	65.3
0-60	1316	46.2	96.1
0-90	1369	48.0	100.0
90-180	0	0.0	0.0
0-180	1369	48.0	100.0

Total Luminaire Efficiency = 48.0%

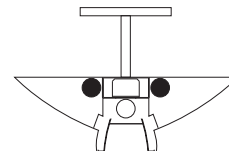

MOUNTING INFORMATION

3FT. Individual

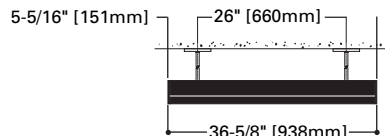

4FT. Individual

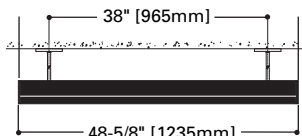

6FT. Individual

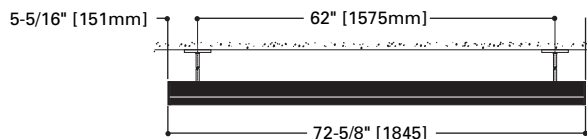

8FT. Individual

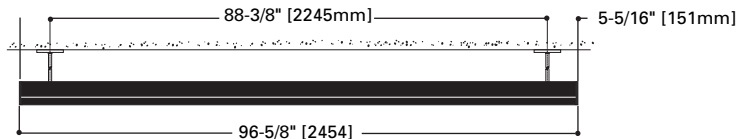

20FT. (Typical)

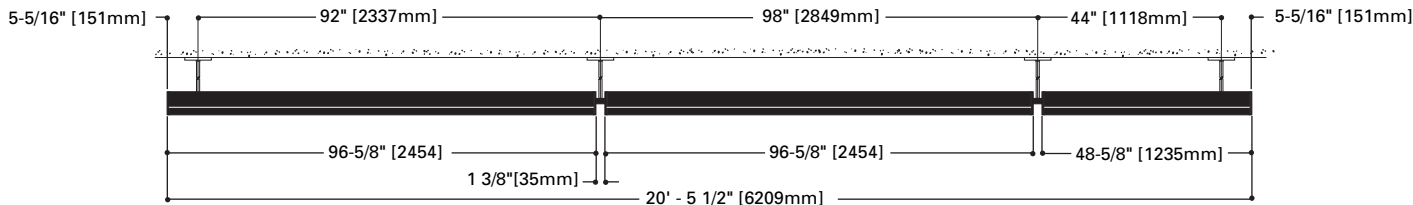

Free Manuals Download Website

<http://myh66.com>

<http://usermanuals.us>

<http://www.somanuals.com>

<http://www.4manuals.cc>

<http://www.manual-lib.com>

<http://www.404manual.com>

<http://www.luxmanual.com>

<http://aubethermostatmanual.com>

Golf course search by state

<http://golfingnear.com>

Email search by domain

<http://emailbydomain.com>

Auto manuals search

<http://auto.somanuals.com>

TV manuals search

<http://tv.somanuals.com>