



2009

OWNER'S MANUAL



DODGE

VIPER

VEHICLES SOLD IN CANADA

With respect to any Vehicles Sold in Canada, the name Chrysler LLC shall be deemed to be deleted and the name Chrysler Canada Inc. used in substitution therefore.

DRIVING AND ALCOHOL

Drunken driving is one of the most frequent causes of accidents.

Your driving ability can be seriously impaired with blood alcohol levels far below the legal minimum. If you are drinking, don't drive. Ride with a designated non-drinking driver, call a cab, a friend, or use public transportation.

WARNING!

Driving after drinking can lead to an accident. Your perceptions are less sharp, your reflexes are slower, and your judgment is impaired when you have been drinking. Never drink and then drive.

This manual illustrates and describes the operation of features and equipment that are either standard or optional on this vehicle. This manual may also include a description of features and equipment that are no longer available or were not ordered on this vehicle. Please disregard any features and equipment described in this manual that are not on this vehicle.

Chrysler LLC reserves the right to make changes in design and specifications, and/or make additions to or improvements to its products without imposing any obligation upon itself to install them on products previously manufactured.

Copyright © 2008 Chrysler LLC



TABLE OF CONTENTS

SECTION		PAGE	
1	INTRODUCTION	3	1
2	THINGS TO KNOW BEFORE STARTING YOUR VEHICLE	9	2
3	UNDERSTANDING THE FEATURES OF YOUR VEHICLE	63	3
4	UNDERSTANDING YOUR INSTRUMENT PANEL	97	4
5	STARTING AND OPERATING	131	5
6	WHAT TO DO IN EMERGENCIES	179	6
7	MAINTAINING YOUR VEHICLE	197	7
8	MAINTENANCE SCHEDULES	249	8
9	IF YOU NEED CONSUMER ASSISTANCE	269	9
10	INDEX	279	10

INTRODUCTION

CONTENTS

■ Introduction	4	■ Vehicle Identification Number	6
■ How To Use This Manual	4	■ Vehicle Modifications/Alterations	7
■ Warnings And Cautions	6		

INTRODUCTION

This Owner's Manual has been prepared with the assistance of service and engineering specialists to acquaint you with the operation and maintenance of your vehicle. It is supplemented by a Warranty Information Booklet and various customer-oriented documents. You are urged to read these publications carefully. Following the instructions and recommendations in this manual will help assure safe and enjoyable operation of your vehicle.

NOTE: After you read the manual, it should be stored in the vehicle for convenient referencing and remain with the vehicle when sold, so that the new owner will be aware of all safety warnings.

When it comes to service, remember that your authorized dealer knows your vehicle best, has the factory-trained technicians and genuine Mopar® parts, and is interested in your satisfaction.

HOW TO USE THIS MANUAL

Consult the Table of Contents to determine which section contains the information you desire.

The detailed index at the back of this Owner's Manual contains a complete listing of all subjects.

Consult the following table for a description of the symbols that may be used on your vehicle or throughout this Owner's Manual:



010505550

WARNINGS AND CAUTIONS

This Owner's Manual contains **WARNINGS** against operating procedures that could result in an accident or bodily injury. It also contains **CAUTIONS** against procedures that could result in damage to your vehicle. If you do not read this entire manual, you may miss important information. Observe all Warnings and Cautions.

VEHICLE IDENTIFICATION NUMBER

The Vehicle Identification Number (VIN) is on the left front corner of the instrument panel and is visible from outside the vehicle through the windshield. This number also appears on the Automobile Information Disclosure Label affixed to a window on your vehicle, the vehicle registration, and the title.

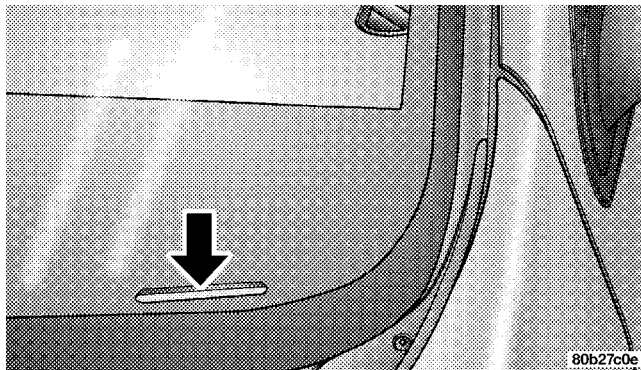

Vehicle Identification Number

NOTE: It is illegal to remove the VIN.

VEHICLE MODIFICATIONS/ALTERATIONS

WARNING!

Any modifications or alterations to this vehicle could seriously affect its roadworthiness and safety and may lead to an accident resulting in serious injury or death.

THINGS TO KNOW BEFORE STARTING YOUR VEHICLE

CONTENTS

■ A Word About Your Keys	12	■ Illuminated Entry System	18
□ Ignition Key Removal	12	■ Remote Keyless Entry (RKE)	18
□ Key-In-Ignition Reminder	13	□ To Unlock The Doors	18
■ Vehicle Security Alarm System	13	□ To Lock The Doors	20
□ Rearming Of The System	13	□ To Unlatch The Trunk/Liftgate	21
□ To Arm The System	13	□ Using The Panic Alarm	21
□ To Disarm The System	16	□ Programming Additional Transmitters	22
□ Electronic Immobilization System — Canada Only	17	□ Battery Replacement	23
		□ General Information	24

10 THINGS TO KNOW BEFORE STARTING YOUR VEHICLE

■ Door Locks	25	■ Occupant Restraints	33
□ Manual Door Lock	26	□ Lap/Shoulder Belts	34
□ Power Door Locks	26	□ Lap/Shoulder Belt Untwisting Procedure	39
■ Windows	28	□ Enhanced Seat Belt Reminder System (BeltAlert®)	39
□ Power Windows	28	□ Automatic Locking Mode	40
□ Auto Down Feature	30	□ Seat Belts And Pregnant Women	41
□ Wind Buffeting	30	□ Seat Belt Extender	41
■ Liftgate — Coupe Models Only	30	□ Driver And Passenger Supplemental Restraint System (SRS) - Airbag	42
■ Trunk Lock And Release — Convertible Models Only	32	□ Child Restraint	53
■ Trunk Safety Warning — Convertible Models Only	32	■ Break-In Recommendations	59
□ Trunk Emergency Release	33		

- Safety Tips 60
 - Exhaust System 60
 - Safety Checks You Should Make Inside The Vehicle 61

- Periodic Safety Checks You Should Make Outside The Vehicle 62

A WORD ABOUT YOUR KEYS

You can insert the double-sided keys into the locks with either side up.

The authorized dealer that sold you your new vehicle has the key code numbers for your vehicle's locks. These numbers can be used to order duplicate keys from your authorized dealer or a locksmith. Ask your authorized dealer for these numbers and keep them in a safe place.

Ignition Key Removal

1. Press the clutch pedal to the floor.
2. Bring the vehicle to a stop.
3. Place the shift lever into gear.
4. Apply the parking brake fully.
5. Press the key removal RELEASE button, turn the key to place the ignition switch in the OFF/LOCK position, and then pull the key out of the switch.

6. Release the clutch pedal.

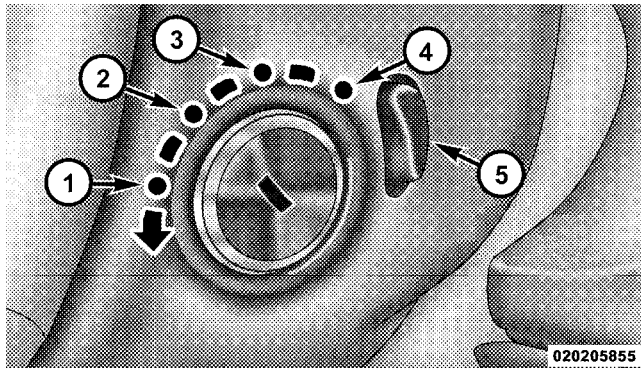

Ignition Key Positions

- | | |
|--------------|--------------------|
| 1 — ACC | 4 — ON/RUN |
| 2 — OFF/LOCK | 5 — RELEASE Button |
| 3 — UNLOCK | |

NOTE: The Power Accessory Delay feature allows you to operate the radio and the power windows for two minutes after turning OFF the ignition switch. Removing the key from the ignition switch and opening the driver's door will cancel this feature. Your authorized dealership can enable or disable the Power Accessory Delay feature as desired.

Key-In-Ignition Reminder

If you open the driver's door when the key is in the ignition, a chime will sound to remind you to remove the key.

NOTE: The Key-In-Ignition reminder only sounds when the ignition switch is placed in the OFF/LOCK or ACC positions.

VEHICLE SECURITY ALARM SYSTEM

The Vehicle Security Alarm monitors the doors, trunk/liftgate, and hood for unauthorized entry and the ignition switch for unauthorized operation. If something triggers the alarm, the Vehicle Security Alarm will prevent the vehicle from starting. It will also sound the horn and flash the park lights, the taillights and the fog lights.

Rearming of the System

If something triggers the alarm, and no action is taken to disarm it, the Vehicle Security Alarm will turn off the horn after three minutes, turn off all of the visual signals (flashing lights) after 15 minutes, and then rearm itself.

To Arm the System

Remove the key from the ignition switch and either press a power door LOCK switch while the driver's or passenger's door is open or press the LOCK button on the Remote Keyless Entry (RKE) transmitter. After the last door is closed, or if all doors are closed, the system will

14 THINGS TO KNOW BEFORE STARTING YOUR VEHICLE

arm itself in approximately 16 seconds. During the arming process, the Vehicle Security Light will flash at a fast rate. Once the system is armed, the light will flash once every six seconds.

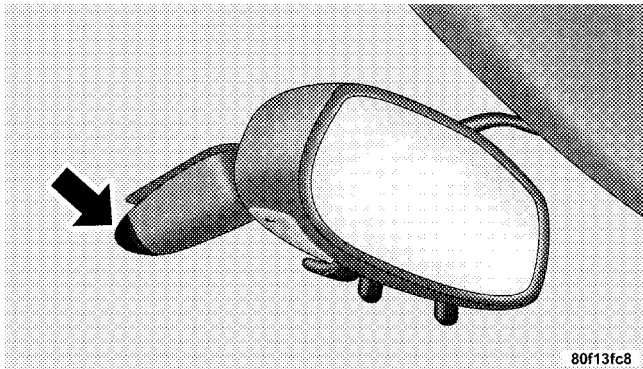

Vehicle Security Light

NOTE:

- The system will not cancel the arming process if you open the hood or trunk/liftgate. It will, however, cancel the arming process if you open a door or turn on the ignition. If this occurs, and you wish to rearm the system, simply repeat either of the previously described arming sequences.
- The Vehicle Security Light will remain on steady if the hood or trunk/liftgate is open during the arming process or if there is a fault in the system. If you verify that the hood and trunk/liftgate are not open, and the light remains on steady, see your authorized dealer for service.

Entering the Trunk with the System Armed — Convertible

NOTE: Using the key to open the trunk while the system is armed will trigger the alarm.

Press the TRUNK button on the RKE transmitter to allow access without triggering the alarm or having to disarm the system. The trunk lid will pop open.

Entering the Liftgate with the System Armed — Coupe

NOTE: Using the key to open the liftgate while the Vehicle Security Alarm is armed will trigger the alarm.

Press the LIFTGATE button on the RKE transmitter to allow access without triggering the alarm or having to disarm the Vehicle Security Alarm. Then, within 30 seconds, open the liftgate by using the key cylinder or the LIFTGATE RELEASE switch located in the exterior liftgate handle.

NOTE: If you do not open the liftgate within 30 seconds, the system will rearm and ignore the switch input.

After closing the liftgate, the Vehicle Security Alarm will arm immediately without having to re-lock the vehicle.

To Disarm the System

There are two ways to disarm the system:

- Use the key to unlock the driver's door. The door lock is located on the outside door panel beneath the mirror.

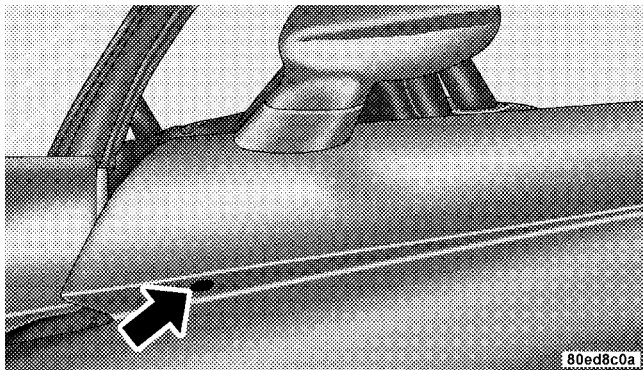

Mechanical Door Lock

- Press the UNLOCK button on the RKE transmitter. The front and rear park lights and the turn signal lights will flash to acknowledge the signal.

NOTE: The vehicle will not start unless the Vehicle Security Alarm is disarmed by either method. Inserting the key in the ignition WILL NOT disarm the system. Furthermore, turning the ignition key to any position while the Vehicle Security Alarm is armed will trigger an alarm.

Tamper Alert

If something has triggered the Vehicle Security Alarm in your absence, the Vehicle Security Light will flash twice every six seconds. In addition, the horn will sound three times when you disarm the Vehicle Security Alarm.

Electronic Immobilization System — Canada Only

The Electronic Immobilization system prevents unauthorized vehicle operation by disabling the engine. The system does not need to be armed or activated. Operation is automatic, regardless of whether the vehicle is locked or unlocked.

To Arm the System

The Electronic Immobilization system will passively arm 30 seconds after the key is removed from the vehicle. When the system is armed the Vehicle Security Light will flash at a rate of a half-second ON, a half-second OFF, a half-second ON, followed by a 10 second pause. While in this mode the vehicle will not start.

NOTE: If the Electronic Immobilization system is armed and the vehicle is unlocked it will remain unlocked until the driver presses either the LOCK button on the RKE transmitter or the power door LOCK

button on the door. At this time the Vehicle Security Alarm will also arm itself in approximately 16 seconds.

To Disarm the System

Pressing the UNLOCK button on the RKE transmitter after the Electronic Immobilization system is activated, will allow the driver 60 seconds to start the vehicle. Failure to complete the process within 60 seconds will cause the system to passively re-arm. The driver must repeat the process again by pressing the UNLOCK button on the RKE transmitter to start the vehicle.

NOTE: Pressing the RKE transmitter UNLOCK button during the 30 second Electronic Immobilization arming process will allow the driver 60 seconds to start the vehicle.

ILLUMINATED ENTRY SYSTEM

The interior lights will turn on whenever a door is opened or the liftgate is opened (Coupe models) and the dimmer switch is not in the defeat position.

The interior lights will turn on, remain on for about 30 seconds, and then fade to off if any of the following occur:

- A door is opened using the outside door handle and then closed.
- A door is unlocked using the Remote Keyless Entry (RKE) transmitter.
- A door is unlocked using the outside driver's door key cylinder.

The interior lights will turn on and remain on for about four seconds and then fade to off if a door is opened using the inside door handle.

REMOTE KEYLESS ENTRY (RKE)

This system allows you to lock or unlock the doors, open the trunk/liftgate, or activate the Panic Alarm from distances up to about 23 ft (7 m) using a Remote Keyless Entry (RKE) transmitter. The RKE transmitter does not need to be pointed at the vehicle to activate the system.

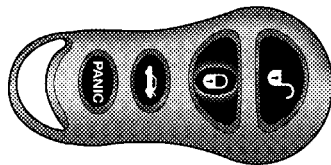

80b31f52

RKE Transmitter

To Unlock the Doors

Press and release the UNLOCK button on the RKE transmitter once to unlock the driver's door, or twice to unlock both doors. The park lights and turn signal lights will flash to acknowledge the signal and the illuminated entry system will turn on. In addition, the words DOOR

UNLOCKED will flash in the odometer if one door is unlocked or will remain on steadily if both doors are unlocked.

NOTE: On Coupe models, pressing either the UNLOCK button or the LIFTGATE button will allow liftgate access.

Remote Key Unlock, Driver Door/Both Doors First

This feature lets you program the system to unlock either the driver's door or both doors on the first press of the UNLOCK button on the RKE transmitter. To change the current setting, proceed as follows:

1. Press the UNLOCK button on a programmed RKE transmitter for at least four seconds, but not longer than 10 seconds. Then, press the LOCK button.
2. Release both buttons at the same time.

3. Test the feature while outside of the vehicle, by pressing the UNLOCK button on the RKE transmitter with the ignition in the OFF/LOCK position, and the key removed.

4. Repeat these steps if you want to return this feature to its previous setting.

NOTE: Pressing the LOCK button on the RKE transmitter while you are in the vehicle will activate the Vehicle Security Alarm. Opening a door with the Vehicle Security Alarm System activated will cause the alarm to sound. Press the UNLOCK button to deactivate the Vehicle Security Alarm System.

Flash Lights with Remote Key Lock

This feature will cause the park lights and turn signal lights to flash when the doors are locked or unlocked with the RKE transmitter. This feature can be turned on or turned off. To change the current setting, proceed as follows:

1. Press the LOCK button on a programmed RKE transmitter for at least four seconds, but no longer than 10 seconds. Then, press the TRUNK/LIFTGATE button.
2. Release both buttons at the same time.
3. Test the feature while outside of the vehicle, by pressing the LOCK/UNLOCK buttons on the RKE transmitter with the ignition in the OFF/LOCK position, and the key removed.
4. Repeat these steps if you want to return this feature to its previous setting.

NOTE: Pressing the LOCK button on the RKE transmitter while you are in the vehicle will activate the Vehicle Security Alarm. Opening a door with the Vehicle Security Alarm activated will cause the alarm to sound. Press the UNLOCK button to deactivate the Vehicle Security Alarm System.

To Lock the Doors

Press and release the LOCK button on the RKE transmitter to lock the doors. The horn will chirp once and the park lights and turn signal lights will flash to acknowledge the signal.

Sound Horn with Remote Key Lock

This feature will cause the horn to chirp when the doors are locked with the RKE transmitter. This feature can be turned on or turned off. To change the current setting, proceed as follows:

1. Press the LOCK button on a programmed RKE transmitter for at least four seconds, but no longer than 10 seconds. Then, press the UNLOCK button.

2. Release both buttons at the same time.
3. Test the feature while outside of the vehicle, by pressing the LOCK button on the RKE transmitter with the ignition in the OFF/LOCK position, and the key removed.
4. Repeat these steps if you want to return this feature to its previous setting.

NOTE: Pressing the LOCK button on the RKE transmitter while you are in the vehicle will activate the Vehicle Security Alarm System. Opening a door with the Vehicle Security Alarm System activated will cause the alarm to sound. Press the UNLOCK button to deactivate the Vehicle Security Alarm System.

To Unlatch the Trunk/Liftgate

Press and hold the TRUNK/LIFTGATE button on the RKE transmitter for at least one second to unlatch the trunk/liftgate. The parking lights and turn signal lights will flash three times to acknowledge the signal.

Using The Panic Alarm

The Panic Alarm unlocks the driver's door, turns on the interior lights, flashes the park lights and fog lights, and sounds the horn. The Panic Alarm will not work when driving the vehicle.

To turn the Panic Alarm on or off, press and hold the PANIC button on the RKE transmitter for at least one second and release. The alarm can also be turned off by inserting the key into the ignition switch and turning it to the ON/RUN position. If not deactivated through the RKE transmitter or the ignition switch, the alarm will turn off automatically after three minutes.

Programming Additional Transmitters

NOTE: You must have at least one programmed RKE transmitter to perform this procedure. If you do not have a programmed RKE transmitter, contact your authorized dealer for details.

Use this procedure to program up to three additional transmitters for your vehicle. To activate the programming feature, proceed as follows:

1. Turn the ignition switch to the ON/RUN position.
2. Set the parking brake.
3. Press and hold the UNLOCK button for at least five seconds, but no longer than 10 seconds on a previously programmed RKE transmitter. Then, press the PANIC button while still holding the UNLOCK button.

4. Release both buttons at the same time. A chime will sound to signal that the programming feature is activated.

5. Within 30 seconds, press and release the LOCK button and the UNLOCK button at the same time on the new RKE transmitter.

6. Press and release any button one time on the new RKE transmitter. A chime will sound to indicate that the new RKE transmitter is programmed. An additional chime will sound at the end of the 30-second programming period. It will also sound if the ignition is switched OFF.

7. Repeat Steps 3 through 6 to program each additional RKE transmitter.

Battery Replacement

The recommended replacement battery is 2016. This is a generic battery, readily available at local retail stores.

NOTE:

- Perchlorate Material — special handling may apply. See www.dtsc.ca.gov/hazardouswaste/perchlorate.
 - Do not touch the battery terminals that are on the back housing or the printed circuit board.
1. Separate the two halves of the RKE transmitter with a coin or similar object.

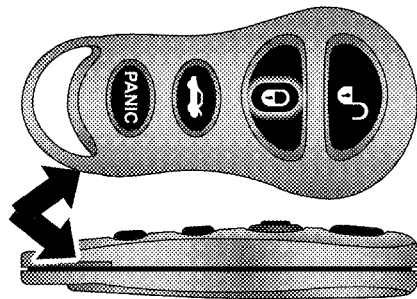

81ac76e6

Separating RKE transmitter Halves

2. Remove and replace the battery. Avoid touching the new battery with your fingers. Skin oils may cause battery deterioration. If you touch a battery, clean it with rubbing alcohol.

3. To assemble the RKE transmitter case, snap the two halves together.
4. Test the RKE transmitter operation.

General Information

This RKE transmitter complies with FCC rules Part 15. Operation is subject to the following conditions:

1. This device may not cause harmful interference.
2. This device must accept any interference that may be received, including interference that may cause undesired operation.

If your RKE transmitter ever fails to operate from a normal distance, check the following:

1. Closeness to a radio transmitter, such as a radio station tower, airport transmitter, and some mobile or CB radios

can affect transmitter operation. To verify if this is the cause, move the vehicle to another area and test RKE transmitter operation.

2. The RKE transmitter may become “out of sync” and will no longer function if operated more than 255 times while out of range of the vehicle (23 ft or 7 m) or if operated while the vehicle battery is dead or disconnected. To “synchronize” the RKE transmitter, remove the key from the ignition. Close the hood and all doors. Press both buttons on the RKE transmitter for about 10 seconds. The horn will chirp once to acknowledge the signal. Normal RKE transmitter operation should resume.

3. The RKE transmitter battery may be weak or dead. The expected life of the battery is a minimum of three years.

DOOR LOCKS

WARNING!

- Do not touch the exhaust pipe sill covers when entering or exiting your vehicle. They can be hot enough to burn you. Observe the warning labels on each door closure panel.
- For personal security and safety in the event of an accident, lock the vehicle doors as you drive as well as when you park and leave the vehicle.
- When leaving the vehicle, always remove the key from the ignition lock, and lock your vehicle. Unsupervised use of vehicle equipment may cause severe personal injuries and death.

(Continued)

WARNING! (Continued)

- Never leave children alone in a vehicle. Leaving unattended children in a vehicle is dangerous for a number of reasons. A child or others could be injured seriously or fatally. Don't leave the key in the ignition. A child could operate power windows, other controls, or move the vehicle.

Manual Door Lock

The driver's door can be locked or unlocked with the key. The door lock is located on the outside door panel beneath the mirror.

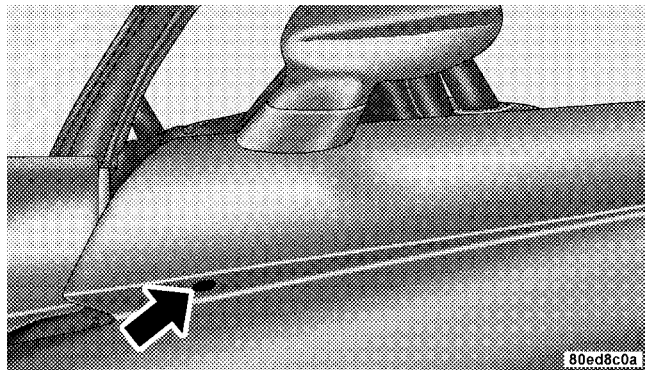

Mechanical Door Lock

Power Door Locks

A power door lock switch is on each door trim panel. Use this switch to lock or unlock the doors.

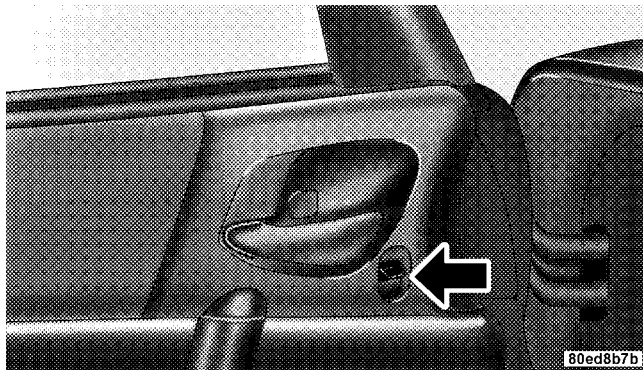

Power Door Lock Switch

NOTE: To prevent you from accidentally locking your keys in the vehicle, the power door locks will not operate if the key is in the ignition and the driver's door is open.

Electronic Door Lock

This vehicle is equipped with a virtual lock system. Input from the outside door handle is ignored if the vehicle is virtually locked.

Door Lock Messaging

The words "DOOR UNLOCKED" will flash in the odometer if one door is unlocked or will remain on steadily if both doors are unlocked. A door is considered unlocked if the inside door handle is pulled. With the key in the ignition switch, this display will turn off approximately 40 seconds after switching OFF the ignition, or if the Power Accessory Delay feature is active, it will turn off approximately 40 seconds after the delay feature times out.

Automatic Door Locks

This feature locks the doors automatically once vehicle speed reaches 18 mph (29 km/h).

NOTE: Input from the door handles is ignored once the vehicle is moving faster than 5 mph (8 km/h).

Automatic Door Locks Programming

The Automatic Door Locks feature can be enabled or disabled as follows:

1. Close all doors and place the key in the ignition.
2. Cycle the ignition switch between ON/RUN and OFF/LOCK four times ending up in the OFF/LOCK position.
3. Depress the power door LOCK switch to lock the doors.
4. A single chime will indicate the completion of the programming.
5. Repeat these steps if you want to return this feature to its previous setting.

This feature can also be disabled at an authorized dealership if desired.

NOTE: Use the Automatic Door Locks feature in accordance with local laws.

WINDOWS

Power Windows

The power window switches are located between the driver and passenger seats on the center tunnel bezel, just to the left of the parking brake. The switch on the left side controls the driver's window and the switch on the right controls the passenger's window. The power window switches are active when the ignition is in ON/RUN or ACC position.

NOTE:

- The Power Accessory Delay feature allows you to operate the power windows for two minutes after turning OFF the ignition switch. Removing the key

from the ignition switch and opening the driver's door will cancel this feature. Your authorized dealership can enable or disable the Power Accessory Delay feature as desired.

- Windows cannot be driven up during Power Accessory Delay with a door open. Furthermore, opening the door will stop the window movement immediately if the window is in the process of going up.
- The window will lower slightly if it is closed completely when opening the door. The window will return to its fully closed position after closing the door. This action is necessary in order to clear the seal when opening the door.

WARNING!

Never leave children in a vehicle with the key in the ignition switch. Occupants, particularly unattended children, can become entrapped by the power windows while operating the power window switch. Such entrapment may result in serious injury or death.

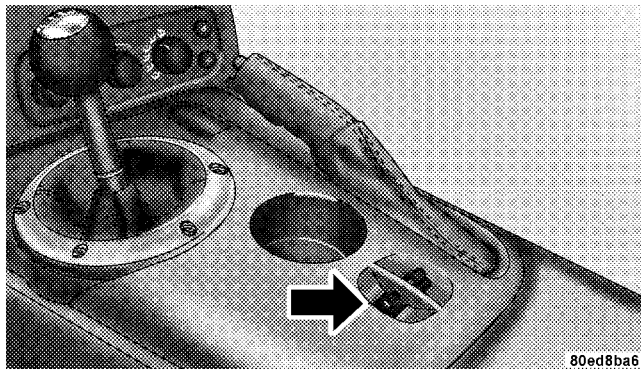

2

Power Window Switches

Auto Down Feature

Both windows have an Auto Down feature. Press the WINDOW switch to the second detent, release, and the window will go down automatically. Press the switch a second time in either direction to stop the window.

To open the window to a desired position, press and hold the WINDOW switch in the first detent. Release the switch when you want the window to stop.

Wind Buffeting

Wind buffeting can be described as the perception of pressure on the ears or a helicopter-type sound in the ears. Your vehicle may exhibit wind buffeting with the windows down, or the top down (convertible models). This is a normal occurrence and can be minimized by adjusting one or both windows up or down slightly.

LIFTGATE — COUPE MODELS ONLY

The liftgate can be unlocked or locked by the Remote Keyless Entry (RKE) transmitter or by activating either of the power door lock switches located on the door trim panels.

To unlock the liftgate with the RKE transmitter, press the LIFTGATE button on the RKE transmitter for at least one second. The parking lights and turn signal lights will flash three times to acknowledge the signal.

NOTE: Pressing the UNLOCK button on the RKE transmitter will also allow liftgate access.

Once unlocked, the liftgate can be opened or closed. To open the liftgate, depress the LIFTGATE RELEASE switch located in the exterior liftgate handle and pull the liftgate open with one fluid motion.

NOTE: The liftgate release switch will be ignored under the following conditions:

- When the ignition is in RUN and the parking brake is not set.
- When vehicle speed is not 0 mph (0 km/h).
- When all doors are locked (except for RKE transmitter liftgate access). Refer to “Entering the liftgate with the System Armed — Coupe” under “Security Alarm System” in this section for additional information.

The word “DECK” will flash in the odometer when the liftgate is open. With the key in the ignition switch, this display will turn off approximately 40 seconds after switching OFF the ignition, or if the Power Accessory Delay feature is active, it will turn off approximately 40 seconds after the delay feature times out.

WARNING!

- **Driving with the liftgate open can allow poisonous exhaust gases into your vehicle. You and your passengers could be injured by these fumes. Keep the liftgate closed when you are operating the vehicle.**
- **If you are required to drive with the liftgate open, make sure that all windows are closed, and the climate control blower switch is set at high speed. DO NOT use the recirculation mode.**

Gas props support the liftgate in the open position. However, because the gas pressure drops with temperature, it may be necessary to assist the props when opening the liftgate in cold weather.

TRUNK LOCK AND RELEASE — CONVERTIBLE MODELS ONLY

You can unlatch the trunk lid by pressing the TRUNK button on the Remote Keyless Entry (RKE) transmitter for at least one second. The park lights and turn signal lights will flash three times to acknowledge the signal and the trunk lid will pop open.

You can also unlatch the trunk lid with the key. The key cylinder is located on the trunk lid.

The word “DECK” will flash in the odometer when the trunk lid is open. With the key in the ignition switch, this display will turn off approximately 40 seconds after switching OFF the ignition, or if the Power Accessory Delay feature is active, it will turn off approximately 40 seconds after the delay feature times out.

NOTE: Gas props support the trunk lid in the open position. However, because the gas pressure drops with temperature, it may be necessary to assist the props when opening the trunk lid in cold weather.

TRUNK SAFETY WARNING — CONVERTIBLE MODELS ONLY**WARNING!**

Do not allow children to have access to the trunk, either by climbing into the trunk from outside, or through the inside of the vehicle. Always close the trunk lid when your vehicle is unattended. Once in the trunk, young children may not be able to escape. If trapped in the trunk, children can die from suffocation or heat stroke.

Trunk Emergency Release

The trunk of your vehicle is equipped with an emergency release handle. It is located on the inside of the trunk lid, near the latch, and is coated so that it glows in a darkened trunk. Pull on the handle to open the trunk.

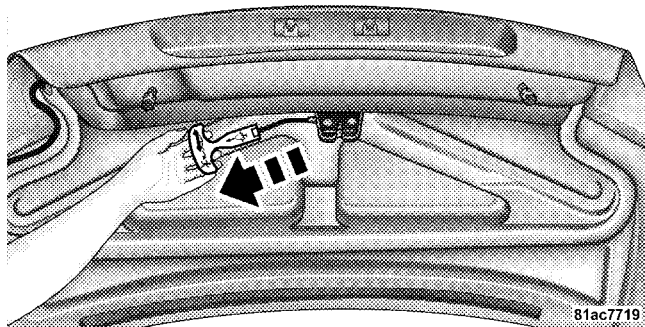

Emergency Release

OCCUPANT RESTRAINTS

Some of the most important safety features in your vehicle are the restraint systems. These include the seat belts and the airbags for the driver and passenger.

Please pay close attention to the information in this section. It explains how to use your restraint system properly to keep you and your passenger as safe as possible. Note that all of the warnings in this section apply no matter which system you have.

WARNING!

In a collision, you and your passenger can suffer much greater injuries if you are not buckled up properly. You can strike the interior of your vehicle or your passenger, or you can be thrown out of the vehicle. Always be sure you and your passenger are buckled up properly.

Buckle up even though you are an excellent driver, even on short trips. Someone on the road may be a poor driver and cause a collision that includes you. This can happen far away from home or on your street.

Research has shown that seat belts save lives. They also can reduce the seriousness of injuries in a collision. Some of the worst injuries happen when people are thrown from the vehicle. Seat belts reduce the possibility of ejection and the risk of injury caused by striking the inside of the vehicle. **Everyone** in a motor vehicle should be belted at all times.

Lap/Shoulder Belts

Each seat belt is a combined lap/shoulder belt system. The belt webbing retractor will lock only during very sudden stops or impacts. This feature allows the shoulder portion of the belt to move freely with you under normal

conditions. However, in a collision, the belt will lock and reduce your risk of striking the inside of the vehicle or being thrown out of the vehicle.

WARNING!

- **It is extremely dangerous to ride in a cargo area, inside or outside of a vehicle. In a collision, people riding in these areas are more likely to be seriously injured or killed.**
- **Do not allow people to ride in any area of your vehicle that is not equipped with seats and seat belts.**
- **Be sure everyone in your vehicle is in a seat and using a seat belt properly.**

(Continued)

WARNING! (Continued)

- Wearing a seat belt incorrectly is dangerous. Seat belts are designed to go around the large bones of your body. These are the strongest parts of your body and can take the forces of a collision the best.
- Wearing your belt in the wrong place could make your injuries in a collision much worse. You might suffer internal injuries, or you could even slide out of part of the belt. Follow these instructions to wear your seat belt safely and to keep your passengers safe, too.
- Two people should never be belted into a single seat belt. People belted together can crash into one another in an accident, hurting one another badly. Never use a lap/shoulder belt or a lap belt for more than one person, no matter what their size.

Lap/Shoulder Belt Operating Instructions

1. Enter the vehicle and close the door. Sit back and adjust the seat.
2. The seat belt latch plate is located at the side of your seat back. Grasp the latch plate and pull out the belt.

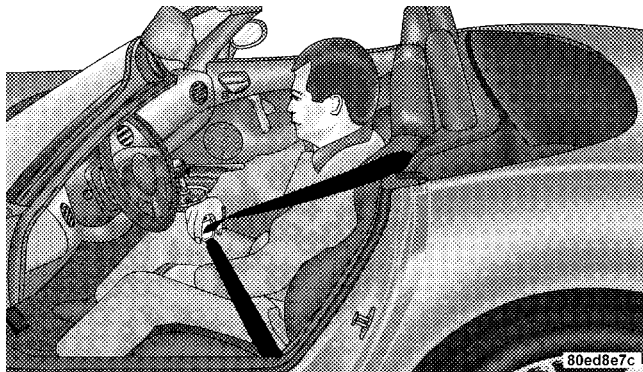
2**Latch Plate (Convertible Shown)**

3. Slide the latch plate up the webbing as far as necessary to make the belt go around your lap.

4. When the belt is long enough to fit, insert the latch plate into the buckle until you hear a "click."

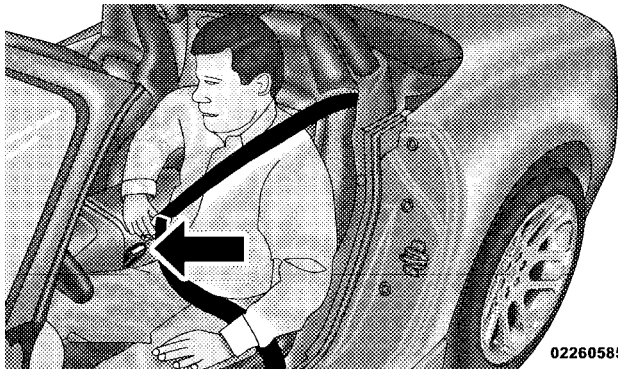

022605856

Latch Plate To Buckle (Convertible Shown)

WARNING!

- A belt that is buckled into the wrong buckle will not protect you properly. The lap portion could ride too high on your body, possibly causing internal injuries. Always buckle your belt into the buckle nearest you.
- A belt that is too loose will not protect you as well. In a sudden stop, you could move too far forward, increasing the possibility of injury. Wear your seat belt snugly.

(Continued)

WARNING! (Continued)

- A belt that is worn under your arm is very dangerous. Your body could strike the inside surfaces of the vehicle in a collision, increasing head and neck injury. A belt worn under the arm can cause internal injuries. Ribs aren't as strong as shoulder bones. Wear the belt over your shoulder so that your strongest bones will take the force in a collision.
- A shoulder belt placed behind you will not protect you from injury during a collision. You are more likely to hit your head in a collision if you do not wear your shoulder belt. The lap and shoulder belt are meant to be used together.

5. Position the lap belt across your thighs, below your abdomen. To remove slack in the lap belt portion, pull up a little on the shoulder belt, as shown.

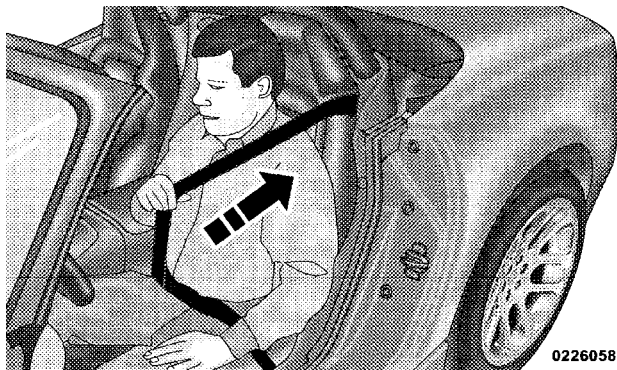

022605857

Removing Slack From Belt (Convertible Shown)

6. To loosen the lap belt if it is too tight, lift up on the shoulder belt and pull on the lap belt. A snug belt reduces the risk of sliding under the belt in a collision.

WARNING!

- A lap belt worn too high can increase the risk of internal injury in a collision. The belt forces won't be at the strong hip and pelvic bones, but across your abdomen. Always wear the lap belt as low as possible and keep it snug.
- A twisted belt can't do its job as well. In a collision, it could even cut into you. Be sure the belt is straight. If you can't straighten a belt in your vehicle, take it to an authorized dealer and have it fixed.

7. Position the shoulder belt on your chest so that it is comfortable and not resting on your neck. The retractor will withdraw any slack in the belt.

8. To release the belt, push the red button in the buckle. The belt will retract automatically to its stowed position. If necessary, slide the latch plate down the webbing to allow it to retract fully.

WARNING!

A frayed or torn belt could rip apart in a collision and leave you with no protection. Inspect the belt system periodically, checking for cuts, frays, or loose parts. Damaged parts must be replaced immediately. Do not disassemble or modify the system. Seat belt assemblies must be replaced after a collision if they have been damaged (bent retractor, torn webbing, etc.).

Lap/Shoulder Belt Untwisting Procedure

Use the following procedure to untwist a twisted lap/shoulder belt.

1. Position the latch plate as close as possible to the anchor point.
2. At about 6 to 12 in (15 to 30 cm) above the latch plate, grasp and twist the belt webbing 180 degrees to create a fold that begins immediately above the latch plate.
3. Slide the latch plate upward over the folded webbing. The folded webbing must enter the slot at the top of the latch plate.
4. Continue to slide the latch plate up until it clears the folded webbing.

Enhanced Seat Belt Reminder System (BeltAlert®)

If the driver does not buckle their seat belt and vehicle speed exceeds 5 mph (8 km/h), or if the passenger does not buckle their seat belt within 10 seconds of vehicle

speed exceeding 5 mph (8 km/h), the Enhanced Warning System (BeltAlert®) will alert the occupant(s) to buckle their seat belt(s). Once triggered, BeltAlert® will flash the Seat Belt Reminder Light and chime for up to 96 seconds to alert the occupant(s) to buckle their seat belt(s). If the driver unbuckles their seat belt while vehicle speed is greater than 5 mph (8 km/h), or if the passenger unbuckles their seat belt for more than 10 seconds while vehicle speed is greater than 5 mph (8 km/h), BeltAlert® will reactivate.

BeltAlert® Programming

BeltAlert® can be enabled or disabled by your authorized dealer or by performing the following steps:

NOTE: Chrysler LLC does not recommend deactivating BeltAlert®.

1. Close all doors.
2. Turn the ignition switch to the OFF/LOCK position.

3. Buckle the driver's seat belt.
4. Turn the ignition switch to the ON/RUN position, but do not start the engine. Wait for the Seat Belt Reminder Light to turn off and then proceed to the next step.

NOTE: You must perform the following steps within 60 seconds of turning the ignition switch to the ON/RUN position.

5. Within 60 seconds of turning the ignition switch to the ON/RUN position, unbuckle and then re-buckle the driver's seat belt at least three times within 10 seconds, ending with the seat belt buckled.

NOTE: Watch for the Seat Belt Reminder Light to turn on while unbuckling the seat belt and turn off while re-buckling the seat belt. It may be necessary to retract the seat belt.

6. Turn the ignition switch to the OFF/LOCK position. A single chime will sound to signify that you have completed the programming successfully.

BeltAlert® can be reactivated by repeating this procedure.

NOTE: When BeltAlert® is deactivated, the Seat Belt Reminder Light will continue to illuminate as long as the driver's seat belt or the passenger's seat belt is unbuckled.

Automatic Locking Mode

The seat belts for both occupants are equipped with emergency locking retractors for normal use. Emergency locking retractors activate during very sudden stops or impacts. The passenger seat belt in your vehicle can also be converted to an automatic locking retractor to secure child restraint systems. Seat belts equipped with automatic locking retractors have a distinctive label on the webbing.

How to Engage the Automatic Locking Mode

To convert the passenger seat belt from emergency locking mode to automatic locking mode, grasp the shoulder portion of the belt and pull all of the webbing out of the retractor. Then, allow some of the webbing to retract back into the retractor. As the belt retracts, you will hear a clicking sound indicating that the belt is now in automatic locking mode.

NOTE: Once the belt is in automatic locking mode, you will not be able to pull any more of the webbing out of the retractor. In this mode, you will only be able to retract excess webbing into the retractor to secure the child restraint.

How To Disengage The Automatic Locking Mode

Simply allow all of the webbing to retract back into the retractor to disengage the automatic locking mode. This will return the retractor to the emergency locking mode for normal use.

Seat Belts and Pregnant Women

We recommend that pregnant women use the seat belts throughout their pregnancy. Keeping the mother safe is the best way to keep the baby safe.

Pregnant women should wear the lap portion of the belt across the thighs and as snug across the hips as possible. Keep the belt low so that it does not come across the abdomen. That way the strong bones of the hips will take the force if there is a collision.

Seat Belt Extender

If a seat belt is too short, even when extended fully, your authorized dealer can provide you with a seat belt extender. This extender should only be used if the existing belt is not long enough. When it is not required, remove the extender, and store it.

WARNING!

Using a seat belt extender when not needed can increase the risk of injury in a collision. Only use a seat belt extender when the seat belt is not long enough when worn low and snug and in the recommended seating positions. Remove and store the extender when not needed.

Driver and Passenger Supplemental Restraint System (SRS) - Airbag

This vehicle is equipped with airbags for the driver and passenger as a supplement to the seat belt restraint systems. The driver's airbag is mounted in the steering wheel. The passenger's airbag is mounted underneath a cover in the passenger's side of the instrument panel. The words SRS/AIRBAG is embossed on the airbag covers.

NOTE: The airbags are certified to the Federal regulations that allow less forceful deployment. The passenger's airbag is certified to the Federal regulations that define Occupant Classification (Refer to "How The Airbag System Works" in this section).

The airbags have a multistage inflator design. This may allow the airbag to have different rates of inflation that are based on collision severity and occupant size.

WARNING!

- **Do not put anything on or around the airbag covers or attempt to open them manually. You may damage the airbags and you could be injured because the airbags are no longer functional. These protective covers for the airbag cushions are designed to open only when the airbags are inflating.**

(Continued)

WARNING! (Continued)

- **Do not drill, cut, or tamper with the knee bolster in any way.**
- **Do not mount any accessories to the knee bolster such as alarm lights, stereos, citizens band radios, etc.**
- **Relying on the airbags alone could lead to more severe injuries in a collision. The airbags work with your seat belt to restrain you properly. In some collisions, the airbags won't deploy at all. Always wear your seat belts even though you have airbags.**
- **Being too close to the steering wheel or instrument panel during airbag deployment could cause serious injury. Airbags need room to inflate. Sit back, extending your arms comfortably to reach the steering wheel or instrument panel.**

The airbags work with the instrument panel knee bolsters and the seat belts to provide improved protection for the driver and passenger. While the seat belts are designed to protect the driver and passenger in many types of collisions, the airbags will deploy in moderate to severe frontal collisions. However, even in collisions where the airbags deploy, all occupants need the seat belts to keep them in the right position for the airbags to protect properly.

NOTE: The passenger airbag may not deploy if the Occupant Classification System (refer to "How The Airbag System Works" in this section) determines the seat is empty or is occupied by someone that is classified in the "child" category. This could be a child, a teenager, or even a small adult. Therefore, even if the driver's airbag deploys, the passenger's airbag may not deploy.

Here are some simple steps you can take to minimize the risk of harm from a deploying airbag.

1. An infant up to one year or approximately 20 lbs (9 kg) should never ride in the vehicle because in the event of a crash, the rear-facing child seat places them too close to the passenger airbag.
2. An infant in a rear-facing child safety seat, designed for a child up to one year or approximately 20 lbs (9 kg), should **NEVER** ride in the front seat of a vehicle equipped with a passenger airbag, unless the airbag is shut OFF. An airbag deployment can cause severe injury or death to an infant in this position. Refer to "Passenger Airbag Disabled (PAD) Indicator Light" in this section.
3. A child who is not big enough to wear the vehicle seat belt properly (refer to information on Child Restraint in this section) should be secured in a child safety seat or booster seat.

4. An older child who does not use a child safety seat or booster seat should ride buckled properly in their seat.
5. Never allow a child to place the shoulder belt behind them or under the arm.
6. Never allow a child to lean forward toward the instrument panel as a passenger airbag deployment could cause severe injury or death to a child in this position.
7. For a child from 1 to 12 years old: Move the passenger seat as far back as possible. For a child from 20 to 60 lbs (9 kg to 27 kg): Secure them in the appropriate child safety seat or booster seat. If too large for a booster seat, the child should wear the lap/shoulder belt properly.
8. Read the instructions provided with your child restraint to make sure that you are using it properly.

9. Read the instructions provided with your child safety seat or booster seat to make sure that you are using it properly.

10. All occupants should wear their lap and shoulder belts properly.

11. Position the driver seat and passenger seat as far away from the instrument panel as practical to allow the airbags room to inflate. Note that the power adjustable pedals allow for more driver's seat adjustment options. Refer to "Adjustable Pedals" in Section 3 of this manual for details.

Airbag System Components

The Airbag System consists of the following:

- Occupant Restraint Controller (ORC)
- Airbag Warning Light
- Driver Airbag
- Passenger Airbag
- Passenger Airbag Off Light
- Steering Wheel and Column
- Instrument Panel
- Seat Track Position Sensors
- Interconnecting Wiring
- Seat Belt Reminder Light
- Knee Impact Bolsters
- Front Acceleration Sensors
- Passenger Seat Occupant Classification System (OCS)
 - Occupant Classification Module (OCM)
 - Passenger Airbag Disabled (PAD) Indicator Light
 - Flex Mat

- Interconnecting Wiring
- Seat Track Position Sensors

How the Airbag System Works

- The **Occupant Restraint Controller (ORC)** determines if a frontal collision is severe enough to require the airbags to inflate. The airbag inflators are designed to provide different rates of inflation. Based on the level of collision severity, the ORC determines the proper rate of inflation. The ORC may modify the rate of passenger airbag inflation or prevent passenger airbag deployment based on input from the Occupant Classification System (OCS). The ORC will not detect roll-over or rear impacts. Furthermore, the airbags are not on and will not inflate if the key is in the OFF/LOCK position, in the ACC position, or not in the ignition.

The ORC also monitors the readiness of the electronic parts of the system whenever the ignition switch is in the ON/RUN position. These include all of the items listed under “Airbag System Components,” except the steering wheel and column and the knee bolsters.



- The ORC turns on the Airbag Warning Light and Passenger Airbag Disable (PAD) Indicator Light for six to eight seconds as a self-check when the ignition is first turned ON. After the self-check, the Airbag Warning Light will turn off and the PAD Indicator Light will function normally (Refer to “Passenger Airbag Disable (PAD) Indicator Light” in this section). If the ORC detects a malfunction in any part of the system, it turns on the Airbag Warning Light either momentarily or continuously. A single chime will sound if the light comes on again after initial start up.

WARNING!

Ignoring the Airbag Warning Light in your instrument panel could mean you won't have the airbags to protect you in a collision. If the light does not come on, stays on after you start the vehicle, or if it comes on as you drive, have the airbag system checked right away.

- The **Driver Airbag/Inflator Unit** is mounted in the steering wheel. The **Passenger Airbag/Inflator Unit** is mounted underneath a cover in the passenger side of the instrument panel. When the ORC detects a collision requiring the airbags, it signals the inflator units. A large quantity of non-toxic gas is generated to inflate the airbags. Different airbag inflation rates may be possible based on collision severity and occupant size. The steering wheel hub trim cover and the upper right side of the instrument panel separate and then fold out of the way, as the bags inflate to their full size. The
- The **Knee Impact Bolsters** help protect the knees of the driver and the passenger, and position everyone for the best interaction with the airbags.
- The **Occupant Classification Module (OCM)** is located underneath the passenger seat. The OCM uses input from the Flex Mat to classify the occupant in the passenger seat into a size category. The OCM communicates this information to the ORC. The ORC may modify the rate of passenger airbag inflation or prevent passenger airbag deployment based on occupant classification.

bags inflate fully in about 50 to 70 ms. This is about half of the time it takes to blink your eyes. The bags then deflate quickly while helping to restrain the driver and passenger. The airbag gas is vented toward the instrument panel through vent holes in the airbag material. In this way, the airbags do not interfere with your control of the vehicle.

If there is a fault present in the OCS, the Airbag Warning Light will turn on. This indicates that you should take the vehicle to an authorized dealer for service. The Airbag Warning Light will turn on whenever there is a fault present, which can affect the operation of the airbag system. If there is a fault present in the OCS, both the PAD Indicator Light and the Airbag Warning Light will illuminate to show that the passenger airbag is turned off. Should this occur the passenger airbag would remain off until the fault is cleared. If an object is lodged under the seat and interferes with operation of the Flex Mat, a fault will occur which turns on both the PAD Indicator Light and the Airbag Warning Light. Once the lodged object is removed, the fault will be cleared automatically after a short period.

- The **Passenger Airbag Disabled (PAD) Indicator Light** indicates to the driver and passenger when the passenger airbag is turned OFF. In the presence of an

occupant seated properly in the passenger seat, when the PAD Indicator Light is illuminated, the passenger airbag is turned OFF.

The passenger airbag will be enabled for most any size adult who is seated properly in the passenger seat. The passenger airbag may or may not be enabled for (depending on size) a small teenager or a small adult who is seated properly in the passenger seat. The driver and passenger should always use the PAD Indicator Light as an indication that the passenger is positioned properly in their seat. If the PAD Indicator Light comes on when an adult or teenager is in the passenger seat, have the passenger reposition themselves in the seat until the light goes out. Remember, if the PAD Indicator Light is illuminated the passenger airbag will not inflate in the event of a collision.

The passenger airbag will not be enabled for most any size child who is seated properly in the passenger seat

and for most properly installed child restraint systems. However, under certain conditions, even with a properly installed child restraint system, the PAD Indicator Light may not be on, even though the airbag is disabled. This can occur if the child restraint is lighter than the threshold weight necessary to turn the PAD Indicator Light on. In any case, **DO NOT** assume the airbag is turned off if the PAD Indicator Light is not illuminated.

WARNING!

An infant in rear facing child safety seat, designed for a child up to one year or approximately 20 lbs (9 kg), should NEVER ride in the front seat of a vehicle equipped with a passenger airbag, unless the airbag is shut OFF. An airbag deployment can cause severe injury or death to an infant in this position.

- The **Flex Mat** is located beneath the passenger seat cushion foam. The Flex Mat sends signals to the OCM for classifying the occupant in the passenger seat.

Any weight on the seat will be sensed by the Flex Mat. Therefore, the occupant in the passenger seat needs to sit in a normal position (with their feet on or near the floor) in order to be classified properly. If an occupant's weight is transferred to another part of the vehicle (like the door or instrument panel), the system may not classify the occupant properly. Furthermore, objects lodged under the seat can prevent the occupant's weight from being measured properly and may result in the occupant being classified improperly.

The passenger seat assembly contains critical components that affect passenger airbag deployment. Correctly functioning passenger seat components are critical for the OCS to classify the passenger properly and calculate the

proper airbag deployment. Do not make any modifications to the passenger seat components, assembly, or to the seat cover. If the seat, trim cover, or cushion needs service for any reason, take the vehicle to your authorized dealer. Only manufacturer approved seat accessories may be used.

The following requirements must be strictly adhered to:

- Do not modify the passenger seat assembly or components in any way.
- Do not use prior or future model year seat covers not designated for the specific model being repaired. Always use the correct seat cover specified for the vehicle.
- Do not replace the seat cover with an aftermarket seat cover.

- Do not add a secondary seat cover other than those approved by Chrysler LLC/Mopar®.
- At no time should any supplemental restraint system (SRS) component or SRS related component or fastener be modified or replaced with any part except those which are approved by Chrysler LLC/Mopar®.

WARNING!

Unapproved modifications or service procedures to the passenger seat assembly, its related components, or seat cover may inadvertently change the airbag deployment in case of a frontal crash. This could result in death or serious injury to the passenger if the vehicle is involved in an accident. A modified vehicle may not comply with required Federal Motor Vehicle Safety Standards (FMVSS).

If a Deployment Occurs

The airbag system is designed to deploy when the ORC detects a moderate-to-severe frontal collision, to help restrain the driver and passenger, and then to deflate immediately.

NOTE: A frontal collision that is not severe enough to need airbag protection will not activate the system. This does not mean something is wrong with the airbag system.

If you do have a collision, which deploys the airbags, any or all of the following may occur:

- The nylon airbag material may sometimes cause abrasions and/or skin reddening to the driver and passenger as the airbags deploy and unfold. The abrasions are similar to friction rope burns or those you might get sliding along a carpet or gymnasium floor. They are not caused by contact with chemicals. They are not permanent and normally heal quickly. However, if you

haven't healed significantly within a few days, or if you have any blistering, see your doctor immediately.

- As the airbags deflate, you may see some smoke-like particles. The particles are a normal by-product of the process that generates the non-toxic nitrogen gas used for airbag inflation. These airborne particles may irritate the skin, eyes, nose, or throat. If you have skin or eye irritation, rinse the area with cool water. For nose or throat irritation, move to fresh air. If the irritation continues, see your doctor. If these particles settle on your clothing, follow the garment manufacturer's instructions for cleaning.
- It is not advisable to drive your vehicle after the airbags have been deployed. If you are involved in another collision, the airbags will not be in place to protect you.

WARNING!

Deployed airbags can't protect you in another collision. Have the airbags replaced by an authorized dealer as soon as possible.

Maintaining Your Airbag System**WARNING!**

- Modifications to any part of the airbag system could cause it to fail when you need it. You could be injured because the airbag is not there to protect you. Do not modify the components or wiring, including adding any kind of badges or stickers to the airbag covers. Do not modify the front bumper or vehicle body structure.

(Continued)

WARNING! (Continued)

- You need proper knee impact protection in a collision. Do not mount or locate any aftermarket equipment on or behind the knee impact bolsters.
- It is dangerous to try to repair any part of the airbag system yourself. Be sure to tell anyone who works on your vehicle that it has airbags.

NOTE: Perchlorate Material — special handling may apply. See www.dtsc.ca.gov/hazardouswaste/perchlorate.

Airbag Warning Light



You will want to have the airbags ready for your protection in a collision. While the airbag system is designed to be maintenance free, if any of the following occurs, have an authorized dealer service the system immediately:

- The Airbag Warning Light does not come on or flickers during the six to eight seconds when the ignition switch is first turned on.
- The light remains on or flickers after the six to eight second interval.
- The light flickers or comes on and remains on while driving.

Child Restraint

Everyone in your vehicle needs to be buckled up all the time — babies and children, too. Every state in the United

States and all Canadian provinces require small children ride in proper restraint systems. This is the law, and you can be prosecuted for ignoring it.

WARNING!

In a collision, an unrestrained child, even a tiny baby, can become a missile inside the vehicle. The force required to hold even an infant on your lap could become so great that you could not hold the child, no matter how strong you are. The child and others could be injured badly. Any child riding in your vehicle should be in a proper restraint for the child's size.

There are different sizes and types of restraints for children from newborn size to the child almost large enough for an adult safety belt. Always check the child

seat Owner's Manual to ensure you have the correct seat for your child. Use the restraint that is correct for your child:

Infant and Child Restraints

- Safety experts recommend that children ride rearward-facing in the vehicle until they are at least one year old **and** weigh at least 20 lbs (9 kg). Two types of child restraints can be used rearward-facing: infant carriers and "convertible" child seats.
- The infant carrier is only used rearward-facing in the vehicle. It is recommended for children who weigh up to about 20 lbs (9 kg). "Convertible" child seats can be used either rearward-facing or forward-facing in the vehicle. Convertible child seats often have a higher weight limit in the rearward-facing direction than infant carriers do, so they can be used rearward-facing by children who weigh more than 20 lbs (9 kg) but are

less than one year old. Both types of child restraints are held in the vehicle by the lap/shoulder belt.

WARNING!

A rearward-facing infant restraint must not be used in your vehicle unless the passenger airbag has been turned off. A rearward-facing infant restraint may be struck by a deploying passenger airbag, which may cause severe or fatal injury to the infant.

Older Children and Child Restraints

Children who weigh more than 20 lbs (9 kg) and who are older than one year can ride forward-facing in the vehicle. Forward-facing child seats and convertible child seats used in the forward-facing direction are for children who weigh 20 to 40 lbs (9 to 18 kg) and who are older than one year. These child seats are also held in the vehicle by the lap/shoulder belt.

The belt-positioning booster seat is for children weighing more than 40 lbs (18 kg), but who are still too small to fit the vehicle's seat belts properly. If the child cannot sit with knees bent over the vehicle's seat cushion while the child's back is against the seat back, they should use a belt-positioning booster seat. The child and belt-positioning booster seat are held in the vehicle by the lap/shoulder belt.

Children Too Large for Booster Seats

Children who are large enough to wear the shoulder belt comfortably, and whose legs are long enough to bend over the front of the seat when their back is against the seat back, should use the lap/shoulder belt in a rear seat.

- Make sure that the child is upright in the seat.
- The lap portion should be low on the hips and as snug as possible.

- Check belt fit periodically. A child's squirming or slouching can move the belt out of position.
- If the shoulder belt contacts the face or neck, move the child closer to the center of the vehicle. Never allow a child to put the shoulder belt under an arm or behind their back.

NOTE: For additional information, refer to www.seatcheck.org or call 1-866-SEATCHECK.

WARNING!

Improper installation can lead to failure of a child restraint. It could come loose in a collision. The child could be injured badly or killed. Follow the manufacturer's directions exactly when installing a child restraint.

Here are some tips on getting the most out of your child restraint:

- Before buying any restraint system, make sure that it has a label certifying that it meets all applicable Safety Standards. We also recommend that you make sure that you can install the child restraint in the vehicle where you will use it before you buy it.
- The restraint must be appropriate for your child's weight and height. Check the label on the restraint for weight and height limits.
- Carefully follow the instructions that come with the restraint. If you install the restraint improperly, it may not work when you need it.
- Buckle the child into the seat according to the child restraint manufacturer's directions.

- When your child restraint is not in use, secure it in the vehicle with the seat belt or remove it from the vehicle. Do not leave it loose in the vehicle. In a sudden stop or collision, it could strike the occupants or seat backs and cause serious personal injury.

Child Restraint Tether Anchor

Child restraints having tether straps and hooks for connection to tether anchors have been available for some time. In fact, many child restraint manufacturers will provide add-on tether-strap kits for some of their older products. There is a tether strap anchor located behind the child tether access cover behind the passenger seat.

To attach a child restraint tether strap:

1. Move the seat forward.
2. Move the seatback to its full forward position.

3. Remove the child tether access cover by prying either side with a screwdriver or similar tool, as shown.

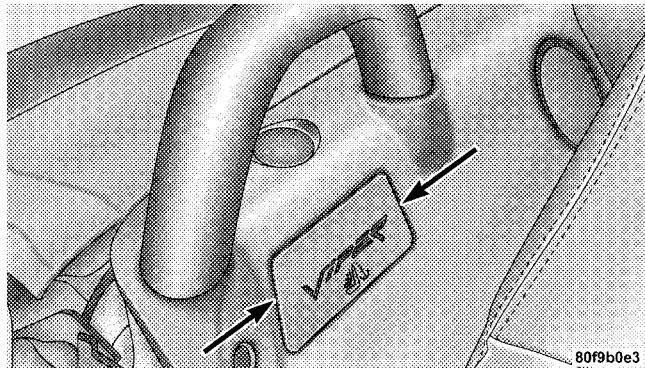

Child Tether Access Cover

NOTE: While the child tether is in use, keep the access cover in a safe place so that it can be replaced after use of the child tether.

4. Pass the child restraint tether hook through either opening in the seatback underneath the head restraint.
5. Attach the tether hook to the anchor loop.

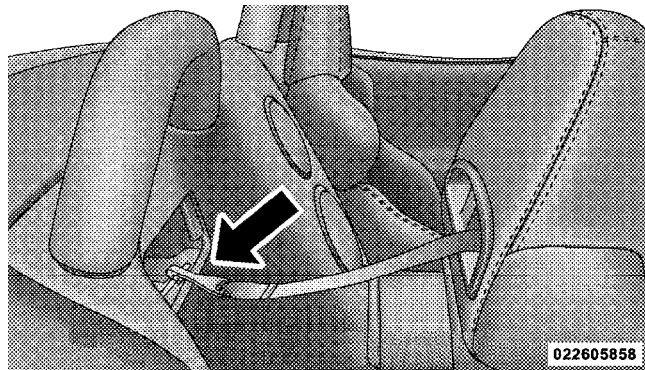

Tether Hook

6. Move the seat to its farthest rearward position. Apply body pressure to the seat to be sure the seat adjusters have latched.

7. Return the seatback to an upright position.
8. Install the child restraint according to the manufacturer's directions.
9. Remove slack from the tether strap according to the child restraint manufacturer's directions.

WARNING!

An incorrectly anchored tether strap could lead to increased head motion and possible injury to the child. Use only the anchor position directly behind the child seat to secure a child restraint top tether strap.

Installing Child Restraints Using the Vehicle Seat belt

The passenger seat belt is equipped with an automatic locking retractor for child restraint system installation. It is designed to keep the lap portion of the restraint held tightly to the passenger seat. Seat belts equipped with automatic locking retractors have a distinctive label on the webbing. (Refer to "Automatic Locking Mode" in this section for additional information).

To restrain the child seat:

1. Pull enough webbing from the retractor to allow the belt to pass through the child restraint and insert the latch plate into the buckle until you hear a "click."
2. Grasp the shoulder portion of the belt and pull all of the webbing out of the retractor.

3. Allow some of the webbing to retract back into the retractor. As the belt retracts, you will hear a clicking sound indicating that the belt is now in automatic locking mode.
4. Tighten the lap portion of the belt and allow the excess webbing to retract back to the retractor. If it still does not make the child restraint secure, then secure the child restraint with the Child Restraint Tether Anchor.

NOTE: Once the belt is in automatic locking mode, you will not be able to pull any more of the webbing out of the retractor. In this mode, you will only be able to retract excess webbing into the retractor to secure the child restraint.

Transporting Pets

Deploying airbags could harm your pet. An unrestrained pet will be thrown about and possibly injured, or injure a passenger during panic braking or in a collision.

Pets should be restrained in pet harnesses or pet carriers that are secured by seat belts.

BREAK-IN RECOMMENDATIONS

A long break-in period is not required for the drivetrain (engine, transmission, and rear axle) in your new vehicle. Following these few simple guidelines is all that is necessary for a good break-in.

For the first 500 miles (800 km):

- Keep your vehicle speed below the legal, posted speed limit and your engine speed below 4,000 RPM.
- Avoid driving at a constant speed, either fast or slow, for long periods.
- Do not make any full throttle starts and avoid full throttle acceleration.
- Use the proper gear for your speed range.
- Wait until the engine has reached normal operating temperature before driving at the recommended maximum break-in speed.

- Avoid excessive idling.
- Check the engine oil level at every fuel fill.

NOTE: A new engine will consume some oil during the first few thousand miles (kilometers) of operation. This should be considered as a normal part of the break-in and not interpreted as a sign of difficulty.

SAFETY TIPS

Exhaust System

WARNING!

Exhaust gases contain carbon monoxide, an extremely toxic gas that by itself is colorless and odorless. To avoid inhaling these gases, the following precautions should be observed:

(Continued)

WARNING! (Continued)

- Do not run the engine in a closed garage or in confined areas any longer than needed to move your vehicle in or out of the area.
- It may be necessary to sit in a parked vehicle with the engine running for more than a short period. If so, adjust your climate control system to force outside air into the vehicle. Set the blower at high speed and the controls in any position except OFF or RECIRC.
- The best protection against carbon monoxide entry into the vehicle body is a properly maintained engine exhaust system.

Be aware of changes in the sound of the exhaust system, exhaust fumes detected inside the vehicle, or damage to the underside or rear of the vehicle. Have a competent mechanic inspect the complete exhaust system and adjacent body areas for broken, damaged, deteriorated or

mispositioned parts. Open seams or loose connections could permit exhaust fumes to seep into the passenger compartment. In addition, inspect the exhaust system each time the vehicle is raised for lubrication or oil change. Replace or adjust as required.

Safety Checks You Should Make Inside the Vehicle

Seat Belts

Inspect the belt system periodically, checking for cuts, frays and loose parts. Damaged parts must be replaced immediately. Do not disassemble or modify the system.

Seat belt assemblies must be replaced after an accident if they have been damaged (bent retractor, torn webbing, etc.). If there is any question regarding belt or retractor condition, replace the belt.

Airbag Warning Light

The light should come on and remain on for six to eight seconds as a bulb check when the ignition switch is first turned ON. If the light does not come on or flickers during or after the six to eight seconds, or flickers or comes on while driving, have the system checked by an authorized dealer.

Defrosters

Check operation by selecting the defrost mode and place the blower control on high speed. You should be able to feel the air directed against the windshield. If the windshield defroster is not working properly, have the system checked as soon as possible by an authorized dealer.

Periodic Safety Checks You Should Make Outside The Vehicle

Tires

Examine tires for excessive tread wear or uneven wear patterns. Check for stones, nails, glass, or other objects lodged in the tread. Inspect the tread and side wall for cuts and cracks. Check the wheel nuts for tightness. Check the tires for proper pressure.

Lights

Have someone observe the operation of exterior lights while you work the controls. Check Turn Signal and High Beam Indicator Lights on the instrument panel.

Door Latches

Check for positive closing, latching, and locking.

Fluid Leaks

Check the area under the vehicle after overnight parking for fuel, water, oil, or other fluid leaks. Also, if gasoline fumes are present, the cause should be corrected immediately.

UNDERSTANDING THE FEATURES OF YOUR VEHICLE

CONTENTS

■ Convertible Top Operation — If Equipped	65	□ Power Mirrors	78
□ To Lower The Top	65	■ Seats	79
□ To Raise The Top	66	□ Manual Seat Adjustments	79
□ Convertible Top Boot Cover Installation — If Equipped	69	■ To Open And Close The Hood	81
□ Convertible Top Boot Cover Removal And Storage	74	■ Lights	83
■ Mirrors	77	□ Exterior And Interior Lighting Control	83
□ Inside Day/Night Mirror	77	□ Headlights And Parking Lights	83
□ Outside Mirrors	77	□ Headlight Time Delay	83
		□ Daytime Running Lights	84

64 UNDERSTANDING THE FEATURES OF YOUR VEHICLE

<input type="checkbox"/> Lights-On Reminder	84	<input type="checkbox"/> Mist Feature	90
<input type="checkbox"/> Battery Saver Feature — Exterior Lights	84	<input type="checkbox"/> Windshield Washers	91
<input type="checkbox"/> Fog Lights	84	■ Tilt Steering Column	91
<input type="checkbox"/> Turn Signals	85	■ Adjustable Pedals	92
<input type="checkbox"/> High Beam/Low Beam Select Switch	86	<input type="checkbox"/> Adjustable Foot Rest	94
<input type="checkbox"/> Flash-To-Pass	86	■ Console Features	94
<input type="checkbox"/> Interior Lights	86	■ Rear Window Features	95
■ Windshield Wipers And Washers	89	<input type="checkbox"/> Electric Rear Window Defroster	95
<input type="checkbox"/> Intermittent Wiper System	90		

CONVERTIBLE TOP OPERATION — IF EQUIPPED**WARNING!**

The convertible top does not provide the structural protection that a reinforced metal roof does, and the fabric top cannot be expected to prevent the ejection of the occupants of a vehicle in a collision. Therefore, it is important that all occupants wear their seat belts at all times when riding in a convertible. Studies have shown that during a collision it is generally safer to remain inside a vehicle than to be ejected from the vehicle.

CAUTION!

- To insure that no damage occurs, be sure that the vehicle is at a complete stop with the shift lever in the NEUTRAL position before lowering or raising the top.
- Do not operate the convertible top with ice or snow build up on the top. Damage to the top may occur.

To Lower the Top

1. Lower the window in each door at least 1 in (2.5 cm).
2. Lower both sun visors.

3. Depress the button located at the top of the latch and then pull the latch handle downward and rearward.

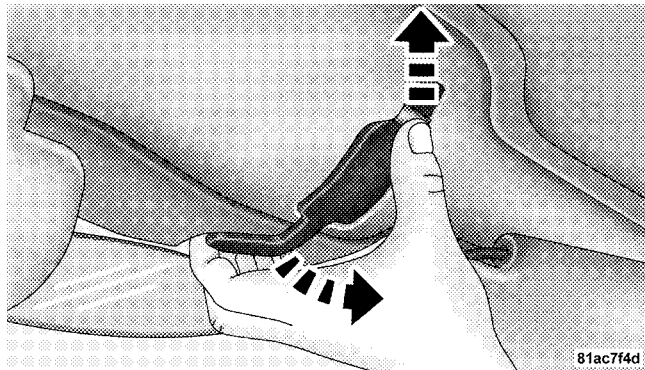

Unlatching Convertible Top

4. Disengage the latch hook from the windshield receiver rod and then pull the latch all the way back to the detent stow position.

5. Pull the convertible top away from the windshield header.
6. Raise both sun visors if so desired.
7. Open the trunk.
8. Pull the convertible top all the way back into the storage well behind the seats.
9. Push the leading edge of the top downward to engage the downstack latch.
10. Close the trunk.

To Raise the Top

1. Lower the window in each door at least one inch.
2. Lower both sun visors.
3. Open the trunk.

4. Press downward on the convertible top and then press the lever behind the driver seat to release the downstack latch.

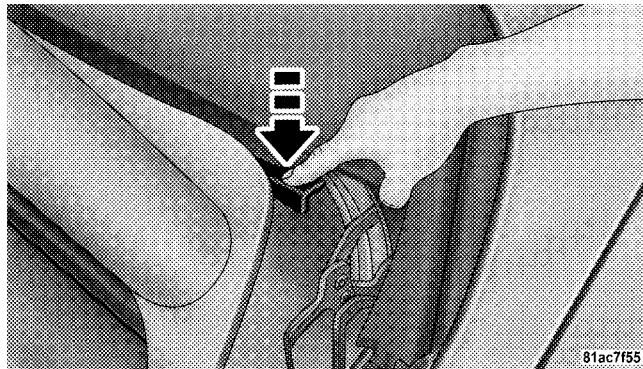

Convertible Top Latch

5. Manually raise the convertible top until it meets the windshield header.

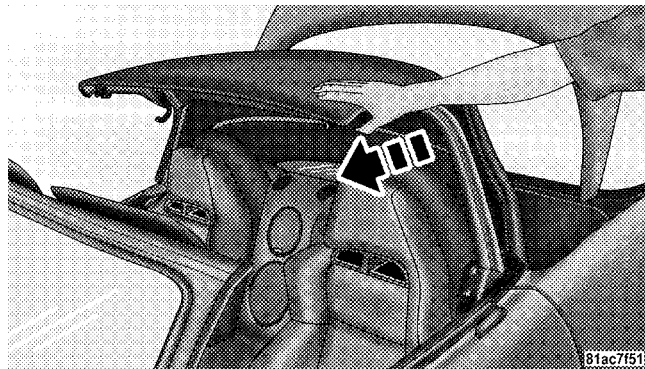

Raising Convertible Top

6. Close the trunk.

7. From inside the vehicle, grasp the handles and pull the convertible top toward the windshield header. Then, push the latch handle forward so that the latch hook engages the windshield receiver rod.

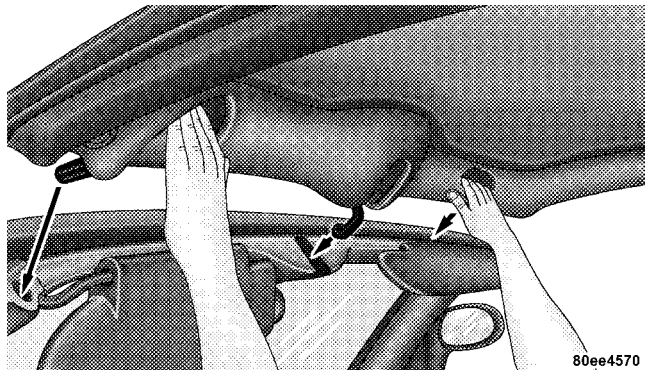

Aligning Convertible Top

8. Ensure that the outboard locating pins are in their respective receiving holes in the windshield header and then push the latch handle forward all the way to close the latch.

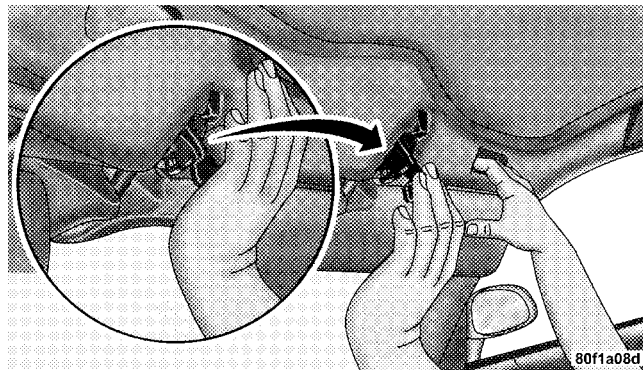

Engaging Convertible Top

NOTE: Until the convertible top system has had adequate time to break-in, it may take a greater effort to engage the latch hook and close the latch. However, several weeks of normal convertible top usage will reduce these efforts.

9. Raise both sun visors if so desired.
10. Adjust the windows as desired.

Convertible Top Boot Cover Installation — If Equipped

1. Open the trunk.
2. Lower the convertible top. Verify that the latch handle is placed in the detent stow position.

3. Lay the unfolded boot cover across the convertible top.

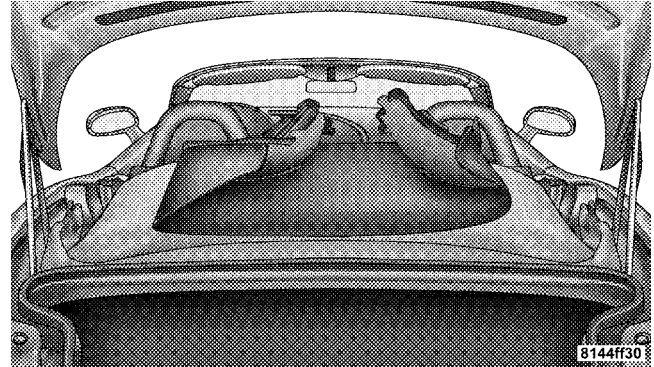

Unfolded Boot Cover

4. Slide the boot cover pocket over the front corner of the convertible top on the driver side of the vehicle. Then, stretch and slide the boot cover pocket over the front corner of the convertible top on the passenger side of the vehicle.

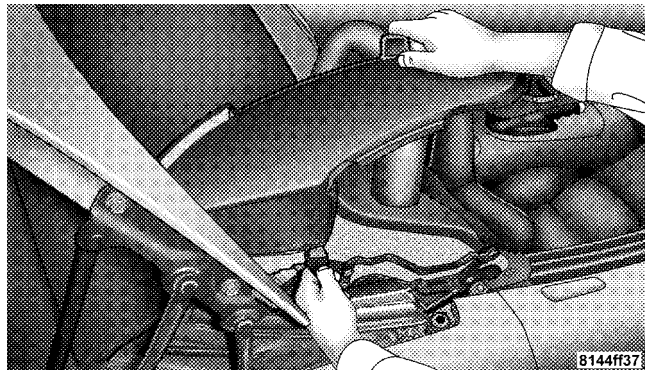

Attaching Passenger Side

5. Tuck the boot cover underneath the leading edge of the convertible top.

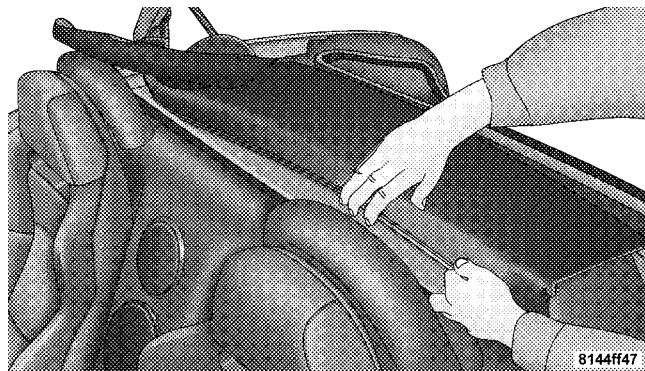

Tucking Boot Cover

6. On the passenger side of the vehicle, clip the tab under the trunk lid stop and on the outer edge of the quarter panel flange.

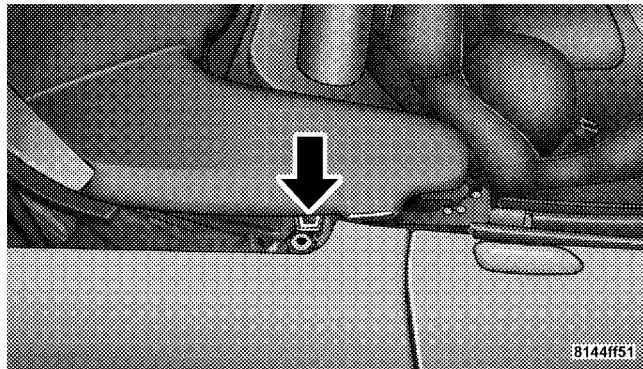

Attaching Passenger Side Tab

7. Push downward on the boot cover pocket to engage the inboard tab.

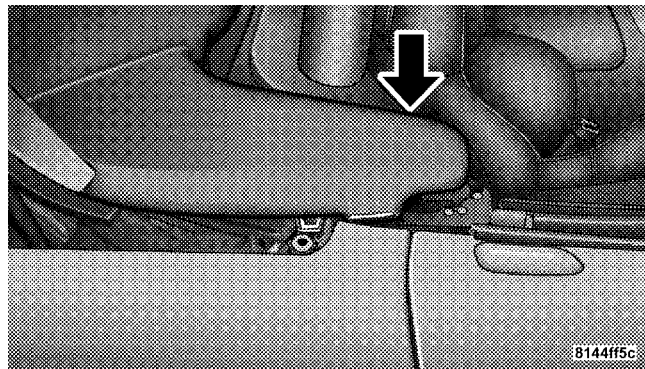

Engaging Passenger Side Tab

8. On the driver side of the vehicle, clip the tab under the trunk lid stop and on the outer edge of the quarter panel flange.

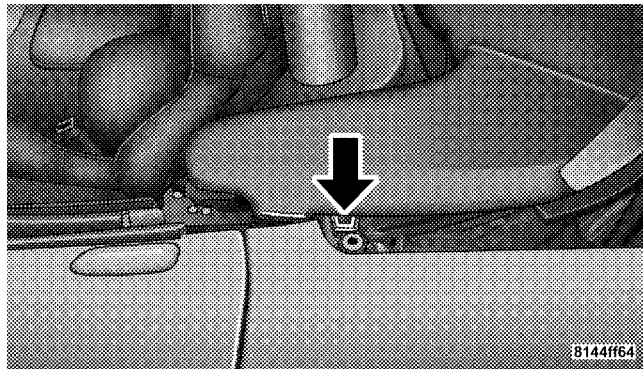

Attaching Driver Side Tab

9. Push downward on the boot cover pocket to engage the inboard tab.

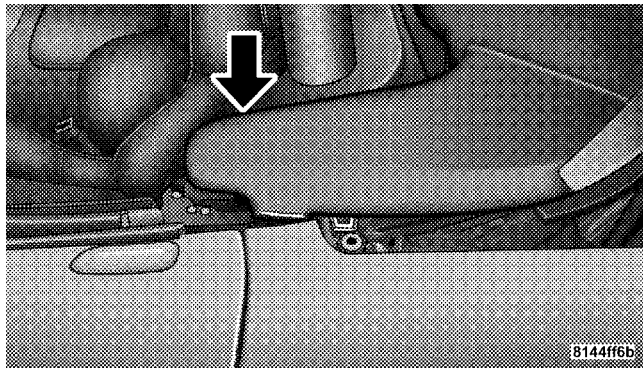

Engaging Driver Side Tab

10. Push downward on the boot cover behind driver seat to lock down the boot cover.
11. Stretch and smooth out the boot cover from the rear of vehicle.

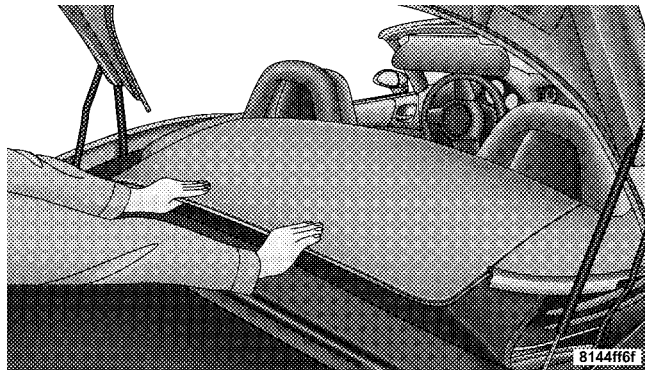

Stretching and Smoothing Cover

12. Close the trunk.
13. Ensure that the forward edge of the boot cover is tucked in fully.

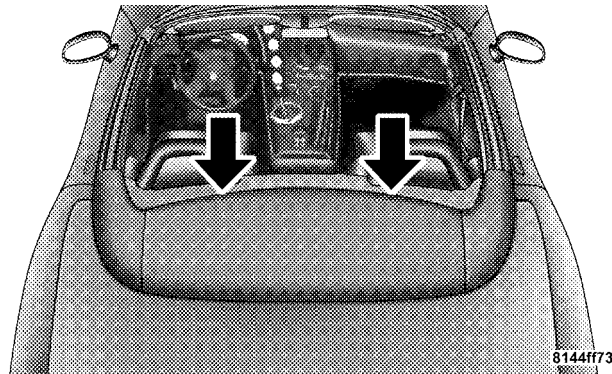

Forward Edge

Convertible Top Boot Cover Removal and Storage

1. Open the trunk.
2. On the driver side of the vehicle, pull upward on the boot cover to disengage the inboard tab.

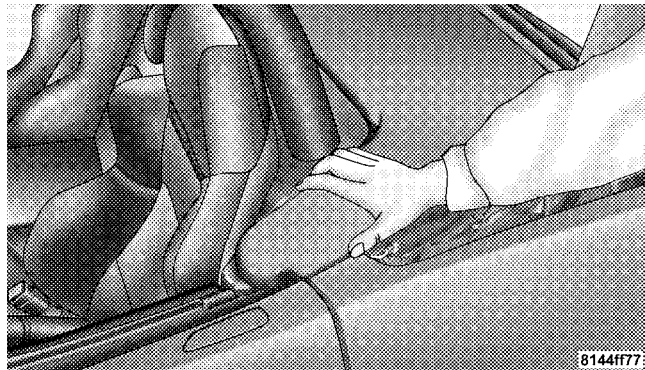

Disengaging Driver Side Tab

3. Unclip the tab under the trunk lid stop and on the outer edge of the quarter panel flange.

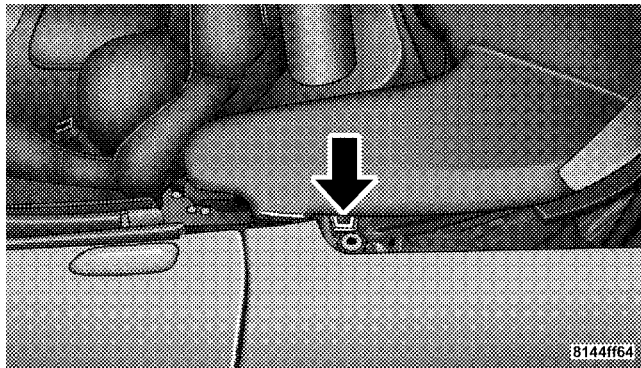

Tab Under Trunk Lid Stop

4. On the passenger side of the vehicle, pull upward on the boot cover to disengage the inboard tab.

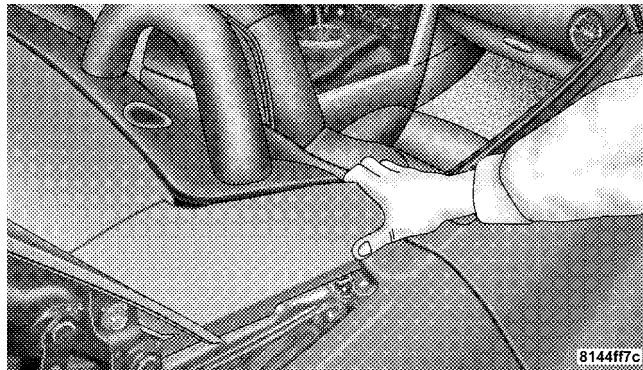

Disengaging Passenger Side Tab

5. Unclip the tab under the trunk lid stop and on the outer edge of the quarter panel flange.

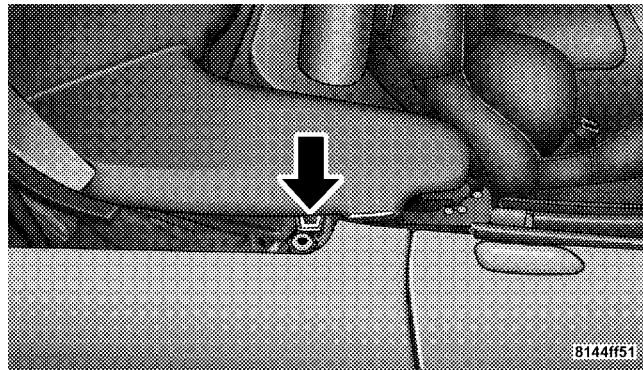

Tab Under Trunk Lid Stop

- Slide the boot cover pockets off the front corners of the convertible top.
- Fold the outer edges of the boot cover inward.

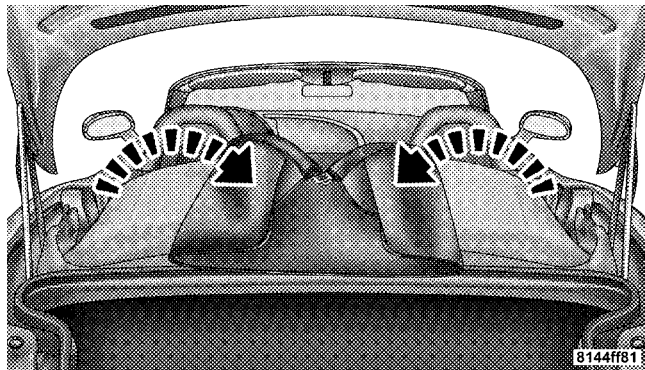

Folding Outer Edges

- Fold the boot cover again.

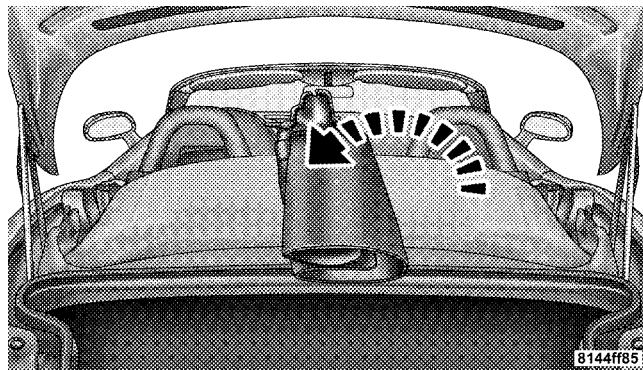

Folding Boot Cover

- Place the boot cover into the bag and store it in the trunk or a secure dry area.
- Close the trunk.

MIRRORS

Inside Day/Night Mirror

Adjust the mirror to center on the view through the rear window. A pivot system allows for horizontal and vertical mirror adjustment.

Headlight glare can be reduced by moving the small control under the mirror to the night position (toward the rear of the vehicle). The mirror should be adjusted while set in the day position (toward the windshield).

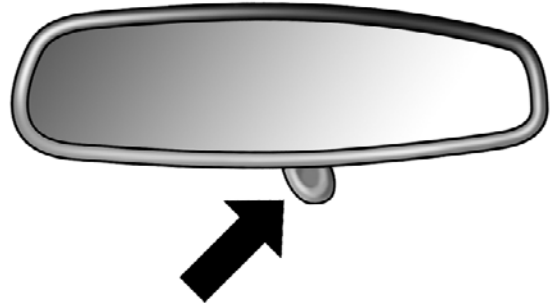

3

030406176

Adjusting Rearview Mirror

Outside Mirrors

To receive maximum benefit, adjust the outside mirrors to center on the adjacent lane of traffic and a slight overlap of the view obtained from the inside mirror.

NOTE: The passenger side convex outside mirror will give a much wider view to the rear, and especially of the lane next to your vehicle.

WARNING!

Vehicles and other objects seen in the passenger side convex mirror will look smaller and farther away than they really are. Relying too much on your passenger side convex mirror could cause you to collide with another vehicle or other object. Use your inside mirror when judging the size or distance of a vehicle seen in the passenger side convex mirror.

Power Mirrors

The power mirror switch is located on the driver's door trim panel below the door handle. Press the button marked "L" to select the driver's outside mirror or the button marked "R" to select the passenger's outside mirror. After selecting a mirror, either press on the top,

bottom, left, or right side of the directional switch and the mirror will move in the direction that the arrow is pointing. To return the power mirror switch to the neutral (off) position, press lightly on the push button not previously pressed until the opposite push button pops outward.

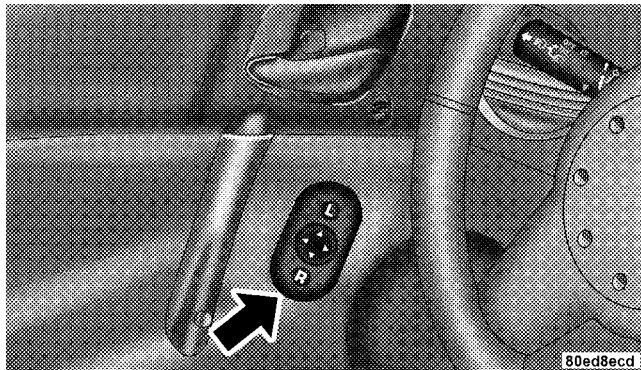

Power Mirror Controls

NOTE: When not in use, return the power mirror switch to the neutral (off) position to prevent accidental mirror movement.

SEATS

Manual Seat Adjustments

Forward and Rearward Adjustment

The adjusting bar is at the front of the seat, near the floor. Pull the bar upward to move the seat forward or rearward. Release the bar once the seat is in the desired position. Then, using body pressure, move forward and rearward on the seat to be sure that the seat adjusters have latched.

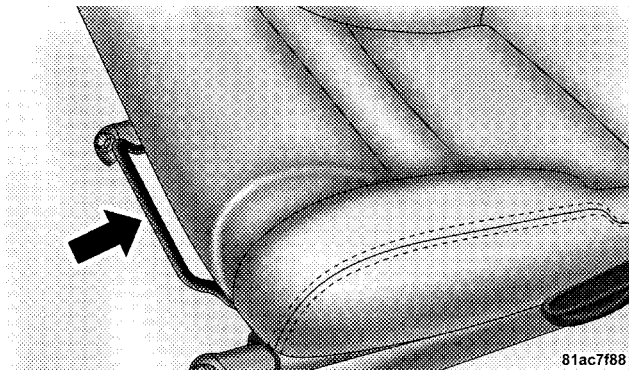

Seat Adjusting Bar

WARNING!

- Adjusting a seat while the vehicle is moving is dangerous. The sudden movement of the seat could cause you to lose control. The seat belt might not be properly adjusted and you could be injured. Adjust the seat only while the vehicle is parked.
- Do not ride with the seatback reclined so that the shoulder belt is no longer resting against your chest. In a collision, you could slide under the seat belt and be seriously or even fatally injured. Use the recliner only when the vehicle is parked.

Recliner Adjustment

The recliner control is located on the outboard side of the seat. To recline the seat, lean forward slightly, pull the recliner control lever upward, lean backward until the seat is in the desired position, and release the lever. To return the seat to its full upright position, lean forward,

pull the recliner control lever upward and hold it until the seat returns to its full upright position.

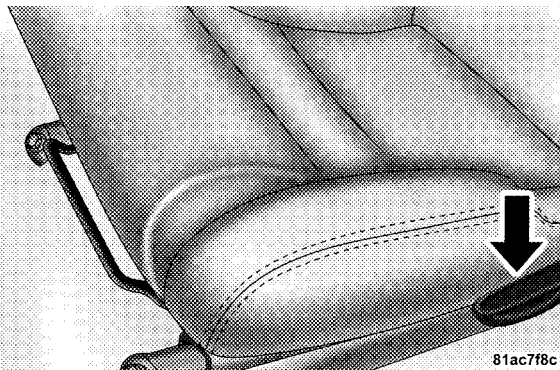

81ac7f8c

Recliner Control

TO OPEN AND CLOSE THE HOOD

Two latches must be released to open the hood.

1. Reach into the lower right grille opening and pull the primary hood latch forward.

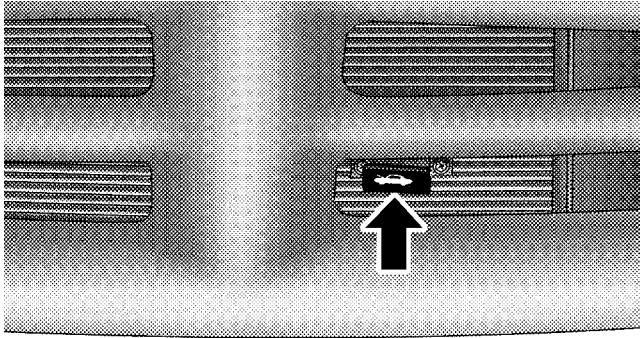

80ed9989

Hood Release Lever

2. Raise the front of the hood slightly and push the safety catch handle to the right. The safety catch handle is located under the front edge of the hood.

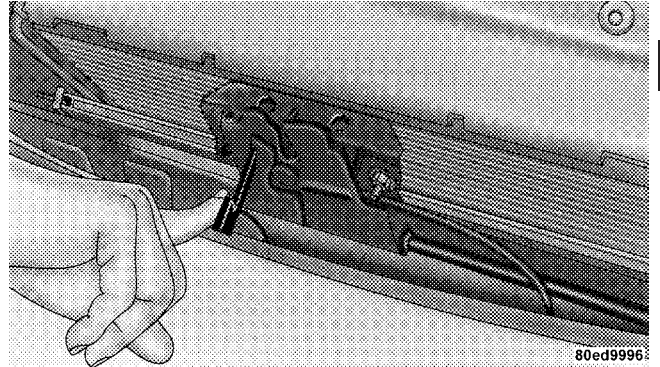

80ed9996

Hood Safety Catch

3

NOTE: Assist props will raise the hood to a normal usage position. If greater access is required, the hood may be pushed up at the front, raising the hood beyond the initial opening height.

CAUTION!

Do not leave the hood open in areas where strong gusts of wind are likely. Such a place might be by the side of the road where large trucks pass by. Strong gusts of wind may damage your hood. Always close the hood in such situations.

To prevent possible damage, do not slam the hood to close it. Simply lower the hood until it is open approximately 6 in (15 cm) and then drop it. This should secure both latches. Never drive your vehicle unless the hood is fully closed with both latches engaged.

WARNING!

If the hood is not fully latched, it could open when the vehicle is moving and block your forward vision. Be sure the hood latches are fully latched before driving.

LIGHTS

Exterior and Interior Lighting Control



The multifunction lever on the left side of the steering column controls the operation of the headlights, parking lights, turn signal lights, front fog lights, instrument panel lights, and interior lights.

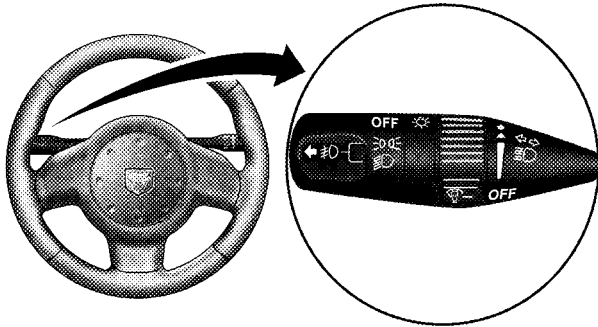

814f6d87

Multifunction Lever

Headlights and Parking Lights

Turn the end of the multifunction lever to the first detent for parking light operation. Turn the end of the lever to the second detent for headlight operation.

Headlight Time Delay

This feature is particularly useful when exiting your vehicle in an unlit area. It provides the safety of headlight illumination for about 90 seconds after turning the ignition switch OFF.

To activate the delay, turn the ignition switch OFF while the headlights are still on. Then, turn off the headlights within 45 seconds. The delay interval begins when the headlight switch is turned off.

If you turn the headlights, parking lights, or ignition switch ON again, the system will cancel the delay.

If you turn the headlights off before the ignition, they will turn off in the normal manner.

This feature can be disabled at the authorized dealership, if so desired.

Daytime Running Lights

The fog lights will come on as Daytime Running Lights, whenever the ignition switch is ON, the headlights are off, and the parking brake is off. The headlight switch must be used for normal night time driving.

NOTE: This feature is standard on all Canadian vehicles and cannot be disabled. For U.S. vehicles, this feature is shipped disabled and can be enabled or disabled at a authorized dealership, if so desired.

Lights-On Reminder

If the headlights or parking lights are on and the ignition switch is turned OFF, a chime will sound when the driver's door is opened to alert the driver.

Battery Saver Feature — Exterior Lights

To protect the battery, the exterior lights will turn off automatically three minutes after the ignition switch is turned OFF. To restore exterior light operation, either turn the ignition switch ON or cycle the headlight switch.

Fog Lights

 To activate the front fog lights, turn on the parking lights or the low beam headlights and pull out on the end of the multifunction lever.

NOTE: The fog lights will only operate with the headlights on low beam. Selecting high beam headlights will turn off the fog lights.

Turn Signals

Move the multifunction lever upward or downward and the corresponding turn signal indicator on the instrument panel will flash to show proper operation of the front and rear turn signal lights.

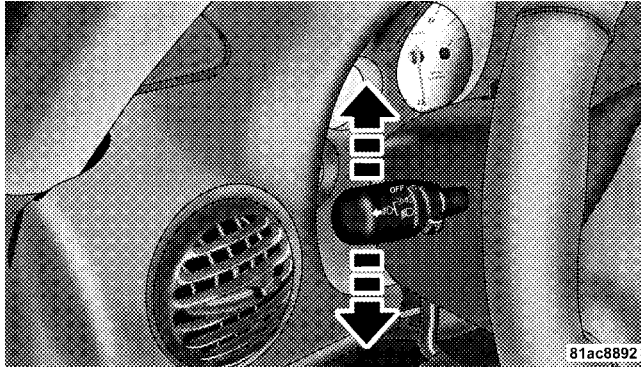

Turn Signal Control

You can also signal a lane change by moving the lever partially upward or downward without moving beyond the detent. The turn signals will continue to operate until you release the multifunction lever.

If either light has a very fast flash rate, check for a defective outside light bulb. If an indicator fails to light when the multifunction lever is moved, it would suggest that the fuse or indicator is defective or there may be a circuit failure.

High Beam/Low Beam Select Switch

Pull the multifunction lever toward you to switch the headlights to high beam. Pull the lever a second time to switch the headlights back to low beam.

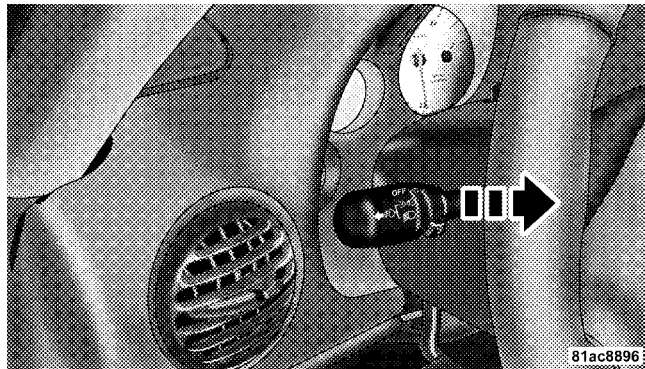

Headlight Beam Control

Flash-to-Pass

You can signal another vehicle with your headlights by lightly pulling the multifunction lever toward you. This will cause the headlights to turn on at high beam and remain on until the lever is released.

Interior Lights

The interior lights will turn on whenever a door is opened or the liftgate is opened (Coupe models) and the dimmer switch is not in the defeat position.

The interior lights will turn on, remain on for about 30 seconds, and then fade to off if any of the following occur:

- A door is opened using the outside door handle and then closed.
- A door is unlocked using the Remote Keyless Entry (RKE) transmitter.

- A door is unlocked using the outside driver's door key cylinder.

The interior lights will turn on and remain on for about four seconds and then fade to off if a door is opened using the inside door handle.

Courtesy/Reading Lights

Two courtesy/reading lights are located in the bottom of the rearview mirror. You can turn these lights on and off from the switches in the bottom of the mirror or from the dimmer control in the multifunction lever. These lights are also controlled automatically by the illuminated entry system.

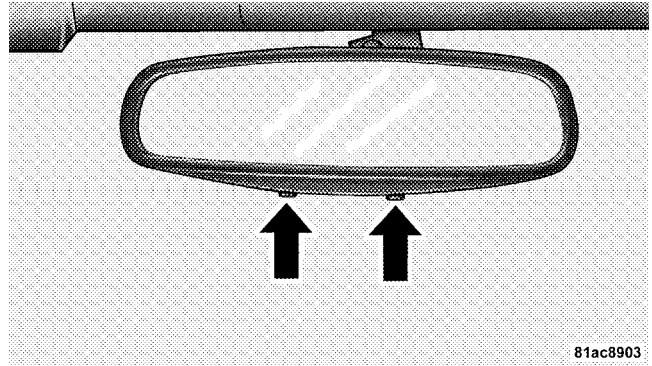

3

Courtesy/Reading Light Switches

Courtesy lights are also found in the driver's foot well, the passenger's foot well, and in the liftgate on Coupe models. You can turn this light on and off from the dimmer control in the multifunction lever. This light is also controlled automatically by the illuminated entry system.

Battery Saver Feature — Interior Lights

To protect the battery, the interior lights will turn off automatically 15 minutes after the ignition switch is moved to the OFF/LOCK position. This will occur if the interior lights were switched on manually or are on because a door is open or the liftgate is open (Coupe models). To restore interior light operation, turn the ignition switch to the ON/RUN position or cycle the light switch.

Dimmer Control

The dimmer control is part of the multifunction lever. It controls the operation of the interior lights and the brightness of the instrument panel lights.

Instrument Panel Dimming

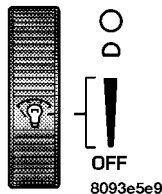

With the parking lights or headlights on, rotate the dimmer control upward to increase the brightness of the instrument panel lights or rotate it downward to decrease the brightness of the instrument panel lights.

Interior Light (ON)

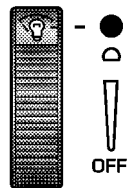

Rotate the dimmer control completely upward to the second detent to turn on the interior lights. The interior lights will remain on when the dimmer control is in this position.

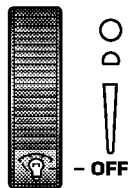
Interior Light Defeat (OFF)

8093e60e

Rotate the dimmer control to the extreme bottom OFF position. The interior lights will remain off when the doors are open.

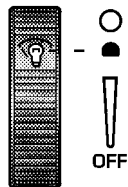
Parade Mode (Daytime Brightness Feature)

8093e650

Rotate the dimmer control to the first detent (white semi-circle). This feature brightens the odometer and radio display when the parking lights or headlights are on during daylight conditions.

WINDSHIELD WIPERS AND WASHERS

The windshield wiper/washer control lever is on the right side of the steering column.

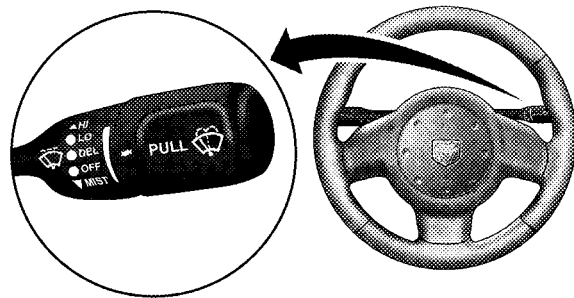

814f6f09

Windshield Wiper/Washer

From the off position, push the windshield wiper/washer control lever upward to the first detent past the

intermittent DEL setting for Low-speed wiper operation, or to the second detent past the intermittent DEL setting for High-speed wiper operation.

CAUTION!

Turn the windshield wipers off when driving through an automatic car wash. Damage to the windshield wipers may result if the wiper switch is left in any position other than off.

Intermittent Wiper System

Use the intermittent wiper when weather conditions make a single wiping cycle with a variable pause between cycles desirable. From the off position, push the windshield wiper/washer control lever upward to the first detent DEL position, and then rotate the end of the lever to select the desired delay interval. There are seven delay settings, which allow you to regulate the wipe interval from a minimum of one cycle every second to a

maximum of approximately 15 seconds between cycles. Rotating the lever upward decreases the delay time.

WARNING!

Sudden loss of visibility through the windshield could lead to an accident. You might not see other vehicles or other obstacles. To avoid sudden icing of the windshield during freezing weather, warm the windshield with defroster before and during windshield washer use.

Mist Feature

From the off position, push the windshield wiper/washer control lever downward to activate a single wipe cycle to clear the windshield of road mist or spray from a passing vehicle. The wipers will continue to operate until you release the lever.

Windshield Washers

To use the washer, pull the windshield wiper/washer control lever toward you and hold it for as long as washer spray is desired.

If you activate the washer while the windshield wiper is in the delay range, the wipers will operate in low speed for two wipe cycles after releasing the lever and then resume the intermittent interval previously selected.

If you activate the washer while the windshield wiper is turned off, the wipers will operate for two wipe cycles and then turn off.

TILT STEERING COLUMN

The tilt release lever is located below the multifunction lever on the left side of the steering column. To tilt the column, simply pull the release lever downward and then move the steering wheel upward or downward as

desired. When the column is in the desired position, push the release lever upward to lock the column firmly in place.

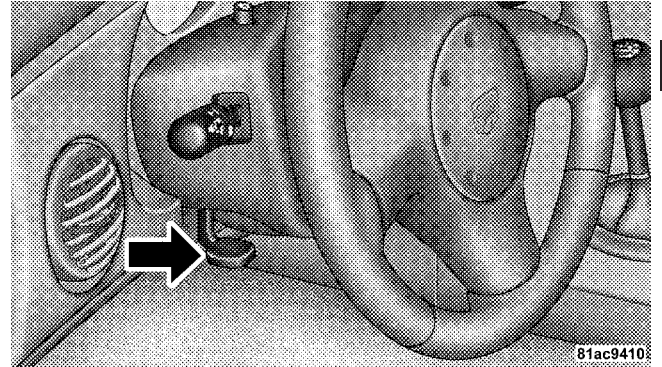

Tilt Steering Column Control

WARNING!

Tilting the steering column while the vehicle is moving is dangerous. Without a stable steering column, you could lose control of the vehicle and have an accident. Adjust the column only while the vehicle is stopped. Be sure it is locked before driving.

ADJUSTABLE PEDALS

This feature allows the driver to move the brake and accelerator pedals about 3 in (72 mm) forward or rearward to allow for greater driving comfort. The adjustable pedals switch is recessed into the knee bolster beneath the steering column.

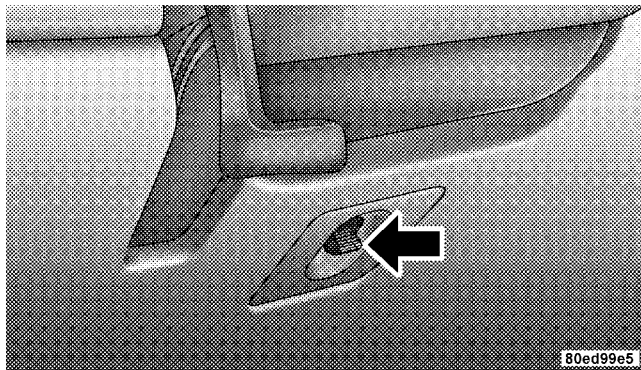

Adjustable Pedals Switch

To adjust the pedals:

1. Adjust the seat and steering column to a comfortable position.
2. Either press the adjustable pedals switch forward to move the pedals forward (toward the front of the vehicle), or pull the switch rearward to move the pedals rearward (toward the rear of the vehicle).

NOTE:

- Always adjust the pedals to a position that allows full pedal travel.
- Further small adjustments may be necessary to find the best possible seat/pedal position.

CAUTION!

Do not place any article under the adjustable pedals or impede its ability to move as it may cause damage to the pedal controls. Pedal travel may become limited if movement is stopped by an obstruction in the adjustable pedal's path.

WARNING!

Do not adjust the pedals while the vehicle is moving. You could lose control and have an accident. Always adjust the pedals while the vehicle is parked.

Adjustable Foot Rest

This feature allows the driver to adjust the foot rest forward or backward and to rotate it upward or downward to allow for greater driving comfort.

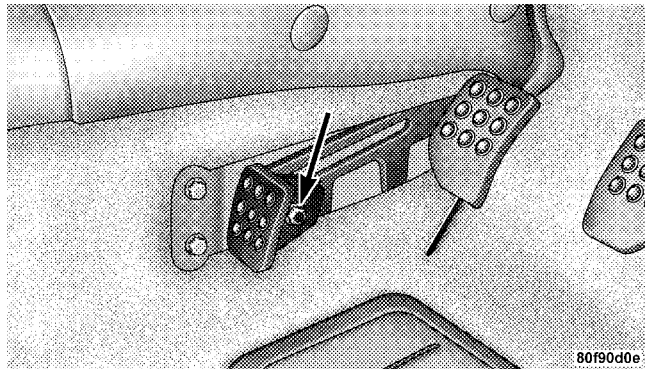

Adjustable Foot Rest

To adjust the pedal:

1. Adjust the seat and steering column to a comfortable position.
2. Using a 13 mm socket wrench, loosen the nut on the pedal.
3. Slide the pedal either forward or backward and rotate it upward or downward as desired.
4. Tighten the nut, being careful not to over tighten it.

CONSOLE FEATURES

The front console has a removable ashtray, power outlet/cigarette lighter, and power window switches.

The center console compartment is equipped with a cigarette lighter/power outlet.

REAR WINDOW FEATURES

Electric Rear Window Defroster



The electric rear window defroster control is located on the climate control. Press this button to turn on the rear window defroster. A light above the button will illuminate when the rear window defroster is ON. The defroster automatically turns off after approximately 15 minutes of operation for the first push of the button, and will turn off after approximately eight minutes for the second push of the button.

CAUTION!

- To avoid damaging the electrical conductors of the rear window defroster, do not use scrapers, sharp instruments, or abrasive window cleaners on the interior surface of the window.
- Labels can be peeled off after soaking with warm water.

UNDERSTANDING YOUR INSTRUMENT PANEL

CONTENTS

■ Instrument Panel Features	99	□ Radio Operation	111
■ Instrument Cluster Description	100	□ CD Player Operation	115
□ Speedometer	100	□ CD/DVD Changer Operation	116
□ Message Center	101	□ Notes On Playing MP3 Files	117
□ Gauges And Indicator Lights	107	□ Operation Instructions - (CD Mode For MP3 Audio Play)	119
■ Setting The Digital Clock	110	■ Satellite Radio — If Equipped	120
□ Clock Setting Procedure	110	□ System Activation	121
■ Sales Code RAH — AM And FM Stereo Radio With CD Player And CD/DVD Changer Controls.	111	□ Electronic Serial Number/Sirius Identification Number (ENS/SID)	121

- Selecting Satellite Mode In RBB, RAH, REV
And RBK Radios 122
- Selecting Satellite Mode In RBP, RBU, RAZ,
RB1 And RBQ Radios. 122
- Selecting a Channel 122
- Storing And Selecting Pre-Set Channels 123
- Using The PTY (Program Type) Button
(If Equipped). 123
- PTY (Scan) Button 123
- PTY (Seek) Button 124
- Satellite Antenna 124
- Reception Quality 124
- Radio Antenna 124
- CD/DVD Maintenance 124
- Radio Operation And Cellular Phones 125
- Climate Controls 125
 - Air Conditioning And Heating System 126
 - Operating Tips 129

INSTRUMENT PANEL FEATURES

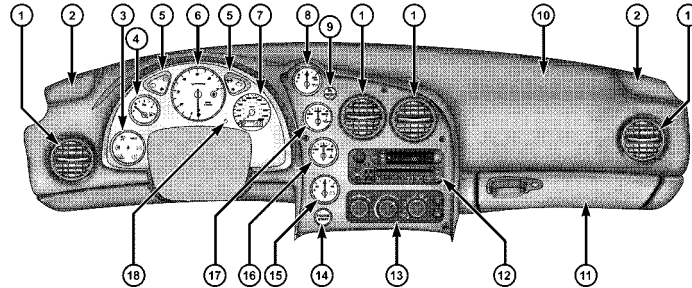

81ac955b

- 1 - Air Outlet
- 2 - Sound System Speaker
- 3 - Main Message Center
- 4 - Fuel Gauge
- 5 - Auxiliary Message Center
- 6 - Tachometer

- 7 - Speedometer/Odometer
- 8 - Oil Pressure Gauge
- 9 - Passenger Airbag Off Light
- 10 - Passenger Airbag
- 11 - Glove Compartment
- 12 - Sound System Controls

- 13 - Climate Control
- 14 - ENGINE START Button
- 15 - Voltage Gauge
- 16 - Engine Coolant Temperature Gauge
- 17 - Engine Oil Temperature Gauge
- 18 - TRIP Button

INSTRUMENT CLUSTER DESCRIPTION

Speedometer

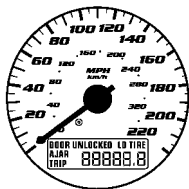

Shows the vehicle's speed in miles-per-hour (mph) and kilometers-per-hour (km/h).

Odometer/Trip Odometer

The odometer shows the total distance the vehicle has been driven.

NOTE: U.S. federal regulations require upon transfer of vehicle ownership, the seller certify the mileage the vehicle has been driven. Therefore, if the odometer reading is changed because of repair or replacement, be sure to keep a record of the reading before and after the service so that the correct mileage can be determined.

The trip odometer shows individual trip mileage. Press and release the TRIP button once to switch the display from odometer to trip odometer. Press and release the TRIP button a second time to return the display to odometer. While in trip mode, press and hold the TRIP button for at least one second to reset the trip odometer to zero.

Liquid Crystal Display (LCD) Panel

The LCD panel at the bottom of the speedometer displays specific messages for given conditions. These messages are as follows:

- The words "DOOR AJAR" will display if a door is not closed completely. In addition, a single chime will sound if you move the vehicle when a door is not closed completely.
- The words "DOOR UNLOCKED" will flash in the display if one door is unlocked and will remain on steady if both doors are unlocked.

- The word “DECK” will flash in the display if the trunk/liftgate is open.
- The words “LOW TIRE” will flash slowly in the display and a chime will sound if the tire pressure is low.
- The words “FLAT TIRE” will flash rapidly in the display and a chime will sound if critically low tire pressure is detected.

Message Center



When the appropriate conditions exist, the Message Center displays the following indicators and warnings:

High Beam Light

 This light will turn on when the high beam headlights are on. Pull the Multifunction Lever on the left side of the steering column toward you to switch the headlights from low beam to high beam. Pull the lever a second time to switch the headlights back to low beam.

Front Fog Light Indicator

 This light will turn on when the front fog lights are on.

Anti-Lock Brake (ABS) Warning Light

 The amber Anti-Lock Brake Warning Light will turn on and stay on briefly as a bulb check when the ignition is first turned on. If the light does not turn on during starting, see your authorized dealer for service.

This light also illuminates at vehicle start-up to indicate that the ABS self-check is in process. If the light remains on after start-up, or turns on and remains on at road speeds, it may indicate a system malfunction or that the system is inoperative. In this case, the system reverts to standard non-anti-lock brakes. If this occurs, safely bring the vehicle to a complete stop as soon as possible and cycle the ignition key to attempt to reset the ABS. If the light remains on, see your authorized dealer immediately to have the system serviced. Furthermore, if the red BRAKE Warning Light and the amber ABS Warning Light are on, and the parking brake is fully released, see your authorized dealer immediately.

WARNING!

If the ABS and/or Brake Warning Lights illuminate, please seek service immediately! Your vehicle will have diminished braking capability and control if ABS and/or service brake systems are not working properly. Have your brake system serviced immediately.

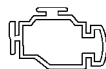
Malfunction Indicator Light (MIL)

The Malfunction Indicator Light (MIL) is part of an onboard diagnostic system called OBD. The OBD system monitors engine control systems. The light will turn on when the key is in the ON/RUN position before engine start. If the light does not come on when turning the key from OFF/LOCK to ON/RUN, have the condition checked promptly.

Certain conditions such as a loose or missing gas cap, poor fuel quality, etc., may illuminate the light after engine start. The vehicle should be serviced if the light remains on through several of your typical driving cycles. In most situations, the vehicle will drive normally and will not require towing.

The MIL flashes to alert you to serious conditions that could lead to immediate loss of power or severe catalytic converter damage. The vehicle should be serviced as soon as possible if this occurs.

CAUTION!

Prolonged driving with the light on could cause further damage to the emission control system. It could also affect fuel economy and driveability. The vehicle must be serviced before any state emissions tests can be performed.

Turn Signal Indicators

 The left or right arrow will flash in unison with the corresponding front and rear turn signals when the TURN SIGNAL switch is operated.

Hazard Indicators

 Both turn signal arrows will flash in unison with the front and rear turn signals when the HAZARD WARNING button is operated.

NOTE: Leaving the hazard flashers on for extended periods will wear down the battery.

Airbag Warning Light



This light will turn on for six to eight seconds as a bulb check when the ignition switch is first turned on. If the light does not turn on during starting, remains on after starting, or turns on while driving, have the system checked immediately by an authorized dealer.

Brake Warning Light

BRAKE The red Brake System Warning Light turns on when the ignition is first turned on. It should stay on briefly as a bulb check. If the light does not turn on during starting, have it repaired promptly. If the light remains on following the bulb check, it may be an indication that the parking brake is not released. If the light remains on when the parking brake is released, it indicates a possible hydraulic brake system malfunction. In this case, immediate repair is necessary and continued operation of the vehicle in this condition is dangerous.

NOTE: The light will turn on when the ignition switch is in the ON/RUN position and the parking brake is applied. This light shows only that the parking brake is applied. It does not show the degree of brake application.

WARNING!

Driving a vehicle with the brake light on is dangerous. Part of the brake system has failed. It will take longer to stop the vehicle. You could have an accident. Have the brakes checked immediately.

Electronic Throttle Control (ETC) Light



This light will turn on briefly as a bulb check when turning on the ignition switch. It will also turn on while the engine is running to warn of a problem with the Electronic Throttle Control (ETC) system.

- If the light fails to turn on during the bulb check, see you authorized dealer for service.

- If the light turns on steady while the engine is running, safely bring the vehicle to a complete stop as soon as possible, cycle the ignition key, and then restart the engine. The light should turn off. However, if the light remains on steady, see your authorized dealer for service as soon as possible.
- If the light is flashing when the engine is running, immediate service is required. If this occurs, you may experience reduced vehicle performance, an elevated/rough idle or engine stall, and your vehicle may require towing.

Low Tire Pressure Telltale / TPMS Malfunction Indicator



Each tire, including the spare (if provided), should be checked monthly when cold and inflated to the inflation pressure recommended by the vehicle manufacturer on the vehicle placard or tire inflation pressure label. (If your vehicle has tires of

a different size than the size indicated on the vehicle placard or tire inflation pressure label, you should determine the proper tire inflation pressure for those tires.)

As an added safety feature, your vehicle has been equipped with a Tire Pressure Monitoring System (TPMS) that illuminates a low tire pressure telltale when one or more of your tires is significantly under-inflated. Accordingly, when the low tire pressure telltale illuminates, you should stop and check your tires as soon as possible and inflate them to the proper pressure. Driving on a significantly under-inflated tire causes the tire to overheat and can lead to tire failure. Under-inflation also reduces fuel efficiency and tire tread life and may affect the vehicle's handling and stopping ability.

Please note that the TPMS is not a substitute for proper tire maintenance, and it is the driver's responsibility to maintain correct tire pressure, even if under-inflation has not reached the level to trigger illumination of the TPMS low tire pressure telltale.

Your vehicle has also been equipped with a TPMS malfunction indicator to indicate when the system is not operating properly. The TPMS malfunction indicator is combined with the low tire pressure telltale.

When the system detects a malfunction, the telltale will flash for approximately one minute and then remain continuously illuminated. This sequence will continue upon subsequent vehicle start-ups as long as the malfunction exists. When the malfunction indicator is illuminated, the system may not be able to detect or signal low tire pressure as intended.

TPMS malfunctions may occur for a variety of reasons, including the installation of replacement or alternate tires or wheels on the vehicle that prevent the TPMS from functioning properly. Always check the TPMS malfunction telltale after replacing one or more tires or wheels on

your vehicle to ensure that the replacement or alternate tires and wheels allow the TPMS to continue to function properly.

CAUTION!

The Tire Pressure Monitor System (TPMS) has been optimized for the original equipment tires and wheels. The TPMS pressures have been established for the tire size equipped on your vehicle. Undesirable operation or sensor damage may result when using replacement equipment that is not of the same size, type, and/or style. Aftermarket wheels can cause sensor damage. Do not use aftermarket tire sealants or balance beads if your vehicle is equipped with the TPMS, as damage to the sensors may result.

WARNING!

Do not exceed 55 mph (88 km/h) if the LOW Tire indicator is activated. Vehicle handling and braking may be reduced. You could have an accident and be severely or fatally injured.

Seat Belt Reminder Light

If the driver does not buckle their seat belt and vehicle speed exceeds 5 mph (8 km/h), or if the passenger does not buckle their seat belt within 10 seconds of vehicle speed exceeding 5 mph (8 km/h), the Enhanced Warning System (BeltAlert®) will alert the occupant(s) to buckle their seat belt(s). Once triggered, the BeltAlert® will flash the Seat Belt Reminder Light and chime for up to 96 seconds to alert the occupant(s) to buckle their seat belt(s). If the driver unbuckles their seat belt while vehicle speed is greater than 5 mph (8 km/h),

or if the passenger unbuckles their seat belt for more than 10 seconds while vehicle speed is greater than 5 mph (8 km/h), the BeltAlert® will reactivate.

Gauges and Indicator Lights**Tachometer**

This gauge shows engine speed in revolutions-per-minute (RPM) times 1,000. Avoid excessive engine speeds in any part of the red warning zone, particularly when driving downhill or in lower gears.

Skip Shift Indicator Light

This indicator is located in the Tachometer. When the indicator light turns amber, it means that you are being prevented from shifting the transmission from First to Second or to Third gear. When the indicator light turns red, it means that the tachometer gauge pointer is at

6000 RPM. This serves as a visual aid to shift before reaching the red line. This warning will turn off when the tachometer pointer falls below 5900 RPM.

Coolant Temperature Gauge

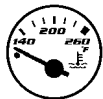

This gauge shows the engine coolant temperature. The gauge pointer will likely show higher temperatures when driving in hot weather, up mountain grades, or in heavy stop and go traffic. If the red Warning Light turns on while driving, safely bring the vehicle to a stop, and turn off the engine. DO NOT operate the vehicle until the cause is corrected.

Engine Temperature Warning Light



The red Engine Temperature Warning Light is located in the Coolant Temperature Gauge. It will turn on to warn of an overheated engine condition. If this light turns on while driving, safely bring the vehicle to a stop and turn off the engine. DO NOT operate the vehicle until the cause is corrected.

Oil Temperature Gauge



This gauge shows the oil temperature. The gauge pointer will likely show higher temperatures when driving in hot weather, up mountain grades, or in heavy stop and go traffic. If the red Warning Light remains on after the bulb check or turns on while driving, safely bring the vehicle to a complete stop and turn off the engine. DO NOT operate the vehicle until the cause is corrected.

Oil Pressure Gauge



This gauge shows engine oil pressure when the engine is running. The pressure will vary with engine speed, oil viscosity, and engine temperature. Oil pressures will be higher as the engine is warming up. The normal operating pressure is between 20 and 80 psi (pounds per square inch). If the pointer remains in the red range, safely bring the vehicle to a complete stop and turn off the engine. DO NOT operate the vehicle until the cause is corrected.

This gauge does not indicate the amount of oil in the engine. The engine oil level must be checked under the hood. Check the level often during severe usage.

Oil Pressure Warning Light

 The red Oil Pressure Warning Light is located in the Oil Pressure Gauge. It will turn on to indicate low engine oil pressure. The light should turn on briefly as a bulb check when the engine is first started. If the light remains on or turns on while driving, safely bring the vehicle to a complete stop and turn off the engine. DO NOT operate the vehicle until the cause is corrected.

NOTE: This light does not indicate how much oil is in the engine. The engine oil level must be checked using the procedure shown in section 7.

Fuel Gauge



This gauge shows the amount of fuel in the gas tank. The reaction time of the gauge has been slowed to avoid needle fluctuation during periods of high G force cornering.

Voltage Gauge



This gauge shows the electrical system voltage. The normal operating voltage is from 12 to 14 Volts with the engine running. If the pointer remains at either the high or low ends of the scale, the electrical system should be serviced.

Charge System Light



The red Charge System Light is located in the Voltage Gauge. It will turn on when there is a charging system malfunction or a possible accessory drive belt failure.

CAUTION!

The accessory belt also drives the water pump. Operating the vehicle with a failed belt can cause engine overheating and possible severe engine damage.

SETTING THE DIGITAL CLOCK

The digital display panel on the radio displays the time in hours and minutes. The display panel is operative when the ignition switch is in the ON/RUN or ACC position. Press and release the TIME button on the radio to display the time. Press and release the button a second time to turn off the time display.

Clock Setting Procedure

1. Turn the ignition switch to the ON/RUN or ACC position.
2. Using the point of a ballpoint pen or similar object, press either the H (HOUR) or M (MINUTE) button on the radio. The display will show the time.
3. Press the "H" button to set hours or the "M" button to set minutes. The time setting will increase each time you press a button.

SALES CODE RAH — AM AND FM STEREO RADIO WITH CD PLAYER AND CD/DVD CHANGER CONTROLS

NOTE: The radio sales code is located on the lower left side of your radio faceplate.

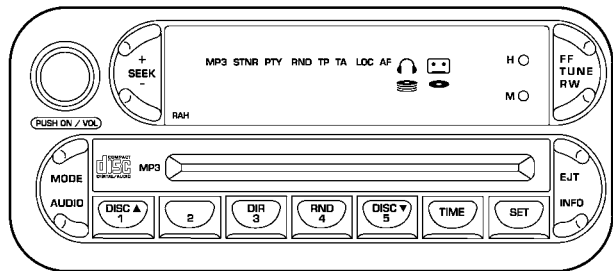

8141b8a1

RAH Radio

Radio Operation

Power/Volume Control

Push the ON/VOL control to turn the radio on. Turn the volume control clockwise to increase the volume.

NOTE: Power to operate the radio is supplied through the ignition switch. It must be in the ON or ACC position to operate the radio.

PTY (Program Type)

Pressing the INFO button once while in FM mode will turn on the PTY mode for five seconds. If no action is taken during the five second time out, the PTY icon will turn off. Pressing the TUNE button within five seconds will allow the program format type to be selected. Many radio stations do not currently broadcast PTY information.

Toggle the TUNE button to select the following format types:

Program Type	Radio Display
Adult Hits	Adult Hit
Classical	Classical
Classic Rock	Classic Rock
College	College
Country	Country
Information	Inform
Jazz	Jazz
Foreign Language	Language
News	News
Nostalgia	Nostalgia
Oldies	Oldies
Personality	Personality
Public	Public
Rhythm and Blues	R & B

Program Type	Radio Display
Religious Music	Religious Music
Religious Talk	Religious Talk
Rock	Rock
Soft	Soft
Soft Rock	Soft Rock
Soft Rhythm and Blues	Soft R&B
Sports	Sports
Talk	Talk
Top 40	Top 40
Weather	Weather

By pressing the SEEK button when the PTY icon is displayed, the radio will be tuned to the next frequency station with the same selected PTY name. The PTY function only operates when in the FM and Satellite (if equipped) modes.

The radio display will flash “SEEK” and the selected PTY program type when searching for the next PTY station. If no station is found with the selected PTY program type, the radio will return to the last preset station.

If a preset button is activated while in the PTY (Program Type) mode, the PTY mode will be exited and the radio will tune to the preset station.

Mode

Press the MODE button to select between, AM, FM, CD, CD/DVD changer or the Satellite Radio (if equipped). When the Satellite Radio (if equipped) is selected, “SA” will appear in your radio display.

A disc may remain in the radio while in the Satellite or radio mode.

Seek

Press and release the SEEK button to search for the next station in either the AM, FM or Satellite mode. Press the

top of the button to seek up and the bottom to seek down. The radio will remain tuned to the new station until you make another selection. Holding the button in will bypass stations without stopping until you release it.

Tuning

Press the TUNE control up or down to increase or decrease the frequency. If you press and hold the button, the radio will continue to tune until you release the button. The frequency will be displayed and continuously updated while the button is pressed.

Balance

The Balance control adjusts the left-to-right speaker balance. Press the AUDIO button, select BALANCE, then press SEEK + or SEEK – to adjust the balance.

Fade

The Fade control provides for balance between the front and rear speakers. Press the AUDIO button, select FADE, then press SEEK + or SEEK – to adjust the fade balance.

Tone Control

The Bass and/or Treble controls sound for the desired tone. Press the AUDIO button, select Bass or TREBLE, then press SEEK + or SEEK - to increase or decrease amplification of the band.

To Set the Radio Pushbutton Memory

When you are receiving a station that you wish to commit to pushbutton memory, press the SET button. SET 1 will show in the display window. Select the pushbutton you wish to lock onto this station and press and release that button. If a station is not selected within five seconds after pressing the SET button, the station will continue to play but will not be locked into pushbutton memory.

You may add a second station to each pushbutton by repeating the above procedure with this exception: Press the SET button twice and SET 2 will show in the display window. Each button can be set for SET 1 and SET 2 in

both AM and FM. This allows a total of 10 AM and 10 FM stations to be locked into memory. You can recall the stations stored in SET 2 memory by pressing the pushbutton twice.

To Change from Clock to Radio Mode

Press the TIME button to change the display between radio frequency and time.

General Information

This radio complies with Part 15 of FCC rules and with RSS-210 of Industry Canada. Operation is subject to the following conditions:

1. This device may not cause harmful interference.
2. This device must accept any interference received, including interference that may cause undesired operation.

NOTE: Changes or modifications not expressly approved by the party responsible for compliance could void the user's authority to operate the equipment.

CD Player Operation

NOTE:

- The ignition switch must be in the ON or ACC position and the volume control ON before the CD player will operate.
- This Radio is capable of playing compact discs (CD), recordable compact discs (CD-R), rewritable compact discs (CD-RW), compact discs with MP3 tracks, and multisession compact discs with CD and MP3 tracks.

Inserting The Compact Disc

CAUTION!

This CD player will accept only 4-3/4 in (12 cm) discs only. The use of other sized discs may damage the CD player mechanism.

You may either insert or eject a disc with the radio OFF.

If you insert a disc with the ignition ON and the radio OFF, the display will show the time of day. If you insert a disc with the ignition OFF, the display will show the time of day for about five seconds, then go out.

If the power is ON, the unit will switch from radio to CD mode and begin to play when you insert the disc. The display will show the track number and index time in minutes and seconds. Play will begin at the start of track one.

Seek

Press the top of the SEEK button for the next selection on the CD. Press the bottom of the button to return to the beginning of the current selection, or return to the beginning of the previous selection if the CD is within the first 10 seconds of the current selection.

EJT — Eject

Press the EJT button and the disc will unload and move to the entrance for easy removal. The unit will switch to the radio mode.

If you do not remove the disc within 15 seconds, it will be reloaded. The radio mode will continue to appear.

The disc can be ejected with the radio off.

FF/TUNE/RW

Press FF (Fast Forward) and the CD player will begin to fast forward until FF is released. The RW (Rewind) button works in a similar manner.

RND — Random Play

Press the RND button while the CD is playing to activate Random Play. This feature plays the selections on the compact disc in random order to provide an interesting change of pace.

Press the SEEK button to move to the next randomly selected track.

Press TUNE FF to fast forward through the tracks. Press the FF button a second time to stop the fast forward feature. If TUNE RW is pressed, the current track will reverse to the beginning of the track and begin playing.

Press the RND button a second time to stop Random Play.

CD/DVD Changer Operation

Press the MODE button to select between the CD player and the optional remote CD/DVD changer.

Time

Press the TIME button to change the display from elapsed CD or DVD playing time to time of day.

Notes On Playing MP3 Files

The radio can play MP3 files, however, acceptable MP3 file recording media and formats are limited. When writing MP3 files, pay attention to the following restrictions.

Supported Media (Disc Types)

The MP3 file recording media supported by the radio are CD-ROM, CD-R and CD-RW.

Supported Medium Formats (File Systems)

The medium formats supported by the radio are ISO 9660 Level 1 and Level 2 and includes the Joliet extension. When reading discs recorded using formats other than ISO 9660 Level 1 and Level 2, the radio may fail to read files properly and may be unable to play the file normally. UDF and Apple HFS formats are not supported.

The radio uses the following limits for file systems:

- Maximum number of directory levels: 15
- Maximum number of files: 255
- Maximum number of folders: 100
- Maximum number of characters in file/folder names:
 - Level 1: 12 (including a separator "." and a 3-character extension)
 - Level 2: 31 (including a separator "." and a 3-character extension)

Multisession disc formats are supported by the radio. Multisession discs may contain combinations of normal CD audio tracks and computer files (including MP3 files). Discs created with an option such as "keep disc open after writing" are most likely multisession discs. The use of multisession for CD audio or MP3 playback may result in longer disc loading times.

Supported MP3 File Formats

The radio will recognize only files with the *.mp3 extension as MP3 files. Non-MP3 files named with the *.mp3 extension may cause playback problems. The radio is designed to recognize the file as an invalid MP3 and will not play the file.

When using the MP3 encoder to compress audio data to an MP3 file, the bit rate and sampling frequencies in the following table are supported. In addition, variable bit rates (VBR) are also supported. The majority of MP3 files use a 44.1 kHz sampling rate and a 192, 160, 128, 96 or VBR bit rates.

MPEG Specification	Sampling Frequency (kHz)	Bit rate (kbps)
MPEG-1 Audio Layer 3	48, 44.1, 32	320, 256, 224, 192, 160, 128, 112, 96, 80, 64, 56, 48, 40, 32
MPEG-2 Audio Layer 3	24, 22.05, 16	160, 128, 144, 112, 96, 80, 64, 56, 48, 40, 32, 24, 16, 8

ID3 Tag information for artist, song title and album title are supported for version 1 ID3 tags. ID3 version 2 is not supported by the radios.

Playlist files are not supported. MP3 Pro files are not supported.

Playback of MP3 files

When a medium containing MP3 data is loaded, the radio checks all files on the medium. If the medium contains a lot of folders or files, the radio will take more time to start playing the MP3 files.

Loading times for playback of MP3 files may be affected by the following:

- Media - CD-RW media may take longer to load than CD-R media
- Medium formats - Multisession discs may take longer to load than non-multisession discs
- Number of files and folders - Loading times will increase with more files and folders

To increase the speed of disc loading, it is recommended to use CD-R media and single-session discs. To create a single-session disc, enable the Disc at Once option before writing to the disc.

Operation Instructions - (CD Mode For MP3 Audio Play)

SEEK Button (CD Mode For MP3 Play)

Pressing the SEEK + button plays the next MP3 File. Pressing the SEEK – button plays the beginning of the MP3 file. Pressing the button within the first ten seconds plays the previous file.

INFO Button (CD Mode for MP3 Play)

Press the INFO button while playing MP3 disc, and the radio will scroll through the following TAG information: Song Title, Artist, File Name, and Folder Name (if available).

Press the INFO button once more to return to "elapsed time" priority mode.

RW/FF (CD Mode for MP3 Play)

Press the FF side of the button to move forward through the MP3 selection. Press the RW side of the button to move back through the MP3 selection.

AM/FM Button (CD Mode for MP3 Play)

Switches the Radio into the AM or FM Radio mode.

RND Button (CD Mode for MP3 Play)

Pressing this button plays files randomly.

DIR Button (CD Mode for MP3 Play)

Press the DIR Button to display folders, when playing an MP3 discs that have a file/folder structure. Press DISC up (button 1) or DISC down (button 5) to move through the folders. Press the SET button to select a folder.

Operating Instructions - Hands Free Phone (If Equipped)

Refer to Hands Free Phone section of the Owner's Manual.

Operating Instructions - Satellite Radio Mode (If Equipped)

Refer to the Satellite Radio section of the Owner's Manual.

Operating Instructions - Video Entertainment System (VES)TM (If Equipped)

Refer to 6 Disc CD/DVD Changer (RDV) section of the Owner's Manual.

SATELLITE RADIO — IF EQUIPPED

Satellite radio uses direct satellite to receiver broadcasting technology to provide clear digital sound, coast to coast. The subscription service provider is Sirius Satellite Radio. This service offers up to 100 channels of music, sports, news, entertainment, and programming for children, directly from its satellites and broadcasting studios.

System Activation

Sirius Satellite Radio service is pre-activated, and you may begin listening immediately to the one year of SIRIUS audio service that is included with the factory-installed satellite radio system in your vehicle. Sirius will contact you to supply a welcome kit and to confirm subscription information, including the set up of your on-line listening account at no additional charge. For further information, call the toll-free number 888-539-7474, or visit the Sirius web site at www.sirius.com, or at www.siriuscanada.ca for Canadian residents. Please have the following information available when changing your subscription:

1. The Electronic Serial Number/Sirius Identification Number (ESN/SID).
2. Your Vehicle Identification Number (VIN).

Electronic Serial Number/Sirius Identification Number (ENS/SID)

The Electronic Serial Number/Sirius Identification Number is needed to activate your Sirius Satellite Radio system. To access the ESN/SID, refer to the following steps:

ESN/SID Access with RBB, RAH, REV and RBK Radios

With the ignition switch in the ACCESSORY position and the radio OFF, press the Tape Eject or CD "EJT" button (depending on the radio type) and TIME buttons simultaneously for three seconds. The first four digits of the twelve-digit ESN/SID number will be displayed. Press the SEEK UP (+) button to display the next four digits. Continue to press the SEEK UP (+) button until all twelve ESN/SID digits have been displayed. The SEEK DOWN (-) will page down until the first four digits are displayed. The radio will exit the ESN/SID mode when any other button is pushed, the ignition is turned OFF, or five minutes has passed since any button was pushed.

ESN/SID Access with RBP, RBU, RAZ, RB1 and RBQ Radios

With the ignition switch in the ACCESSORY position and the radio OFF, press the CD Eject and TIME buttons simultaneously for three seconds. All twelve ESN/SID numbers will be displayed. The radio will exit the ESN/SID mode when any other button is pushed, the ignition is turned OFF, or five minutes has passed since any button was pushed.

Selecting Satellite Mode in RBB, RAH, REV and RBK Radios

Press the MODE button repeatedly until "S A" appears in the display. A CD or tape may remain in the radio while in the Satellite radio mode.

Selecting Satellite Mode in RBP, RBU, RAZ, RB1 and RBQ Radios

Press the MODE button repeatedly until the word "SIRIUS" appears in the display. These radios will also display the following:

- After three seconds, the current channel name and channel number will be displayed for five seconds.
- The current program type and channel number will then be displayed for five seconds.
- The current channel number will then be displayed until an action occurs.

A CD or tape may remain in the radio while in the Satellite radio mode.

Selecting a Channel

Press and release the SEEK or TUNE buttons to search for the next channel. Press the top of the button to search up

and the bottom of the button to search down. Holding the TUNE button causes the radio to bypass channels until the button is released.

Press and release the SCAN button (if equipped) to automatically change channels every seven seconds. The radio will pause on each channel for seven seconds before moving on to the next channel. The word "SCAN" will appear in the display between each channel change. Press the SCAN button a second time to stop the search.

NOTE: Channels that may contain objectionable content can be blocked. Contact Sirius Customer Care at 888-539-7474 to discuss options for channel blocking or unblocking. Please have your ESN/SID information available.

Storing and Selecting Pre-Set Channels

In addition to the 10 AM and 10 FM pre-set stations, you may also commit 10 satellite stations to pushbutton memory. These satellite channel pre-set stations will not

erase any AM or FM pre-set memory stations. Follow the memory pre-set procedures that apply to your radio.

Using the PTY (Program Type) Button (If Equipped)

Follow the PTY button instructions that apply to your radio.

PTY (SCAN) Button

When the desired program type is obtained, press the SCAN button within five seconds. The radio will play seven seconds of the selected channel before moving to the next channel of the selected program type. Press the SCAN button a second time to stop the search.

NOTE: Pressing the SEEK or SCAN button while performing a music type scan will change the channel by one and stop the search. Pressing a pre-set MEMORY button during a music type scan, will call up the memory channel and stop the search.

PTY (SEEK) Button

When the desired program is obtained, press the SEEK button within five seconds. The channel will change to the next channel that matches the program type selected.

Satellite Antenna

To ensure optimum reception, do not place items on the roof around the rooftop antenna location or strap items to the trunk lid around the trunk lid antenna (if equipped). Metal objects placed within the line of sight of the antenna will cause decreased performance. Larger luggage items such as bikes should be placed as far rearward as possible, within the loading design of the rack. Do not place items directly on or above the antenna.

Reception Quality

Satellite reception may be interrupted due to one of the following reasons.

- The vehicle is parked in an underground parking structure or under a physical obstacle.

- Dense tree coverage may interrupt reception in the form of short audio mutes.
- Driving under wide bridges or along tall buildings can cause intermittent reception.
- Placing objects over or too close to the antenna can cause signal blockage.

RADIO ANTENNA

The radio antenna is located in the windshield.

CD/DVD MAINTENANCE

To keep a CD/DVD in good condition, take the following precautions:

1. Handle the disc by its edge; avoid touching the surface.
2. If the disc is stained, clean the surface with a soft cloth, wiping from center to edge.

3. Do not apply paper or tape to the disc; avoid scratching the disc.
4. Do not use solvents such as benzene, thinner, cleaners, or antistatic sprays.
5. Store the disc in its case after playing.
6. Do not expose the disc to direct sunlight.
7. Do not store the disc where temperatures may become too high.

NOTE: If you experience difficulty in playing a particular disc, it may be damaged (i.e. scratched, reflective coating removed, a hair, moisture or dew on the disc) oversized, or have theft protection encoding. Try a known good disc before considering disc player service.

RADIO OPERATION AND CELLULAR PHONES

Under certain conditions, the cellular phone being ON in your vehicle can cause erratic or noisy performance from your radio. This condition may be lessened or eliminated by relocating the cellular phone antenna. This condition is not harmful to the radio. If your radio performance does not satisfactorily “clear” by the repositioning of the antenna, it is recommended that the radio volume be turned down or off during cellular phone operation.

CLIMATE CONTROLS

The Air Conditioning and Heating System is designed to make you comfortable in all types of weather.

Air Conditioning and Heating System

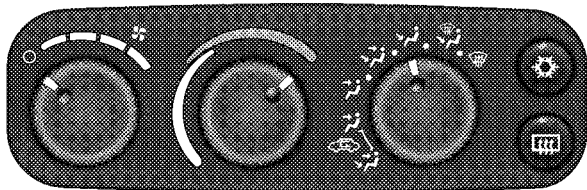

Air Conditioning And Heater Controls

814f6464

Blower Control



80ede9d

Use this control to regulate the amount of air forced through the system in any mode you select. Turn the control clockwise to increase fan speed. Turn the control to the O (Off) position to shut off the fan and to prevent any outside air from entering the vehicle. This also turns off the A/C compressor.

NOTE: For vehicles equipped with Remote Start, the climate controls will not function during Remote Start operation if the blower control is left in the "O" (Off) position.

Temperature Control

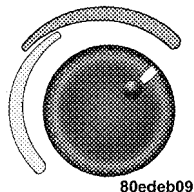

80edeb09

Use this control to regulate the temperature of the air inside the passenger compartment. The blue area of the control indicates cooler temperatures while the red area indicates warmer temperatures.

Mode Control



814f63b7

Use this control to select the direction of air flow.

NOTE: The dot between the mode control icons is a mix position between the two modes.

The mode settings are as follows:

- *Recirculation Control*



Air is recirculated inside the vehicle. You may choose between Bi-Level and Panel air outlets while in this mode. Use this mode to temporarily block out any outside odors, smoke, or dust and to cool the interior rapidly upon initial start up in very hot or humid weather.

- *Panel*



Air is directed through the outlets in the instrument panel. These outlets can be adjusted to direct air flow.

- *Bi-Level*



Air is directed through the instrument panel and floor outlets. A small amount of air is also directed through the defrost outlets.

NOTE: There is a varying temperature differential between the upper and lower outlets for added comfort. The warmer air goes to the floor outlets. This feature provides improved comfort during sunny but cool conditions.

- *Floor*

 Air is directed through the floor outlets with a lesser amount through the defrost outlets.

- *Defrost/Floor*

 Air is directed through the windshield defrost and the floor outlets. This setting works best in cold or snowy conditions that require extra heat at the windshield. This setting is good for maintaining comfort while reducing moisture on the windshield.

- *Defrost*

 Air is directed through the windshield defrost outlet. Use this mode with maximum fan and temperature settings for best windshield defrosting.

NOTE: The air conditioning compressor operates in this mode. This dehumidifies the air to help dry the windshield. To improve fuel economy, leave in the Defrost mode only when necessary.

Air Conditioning Control

 With the fan control in the ON position, push the A/C button to turn on the air conditioning compressor. An indicator light above the button shows that the Air Conditioning compressor is on. Conditioned air is now directed through the outlets selected. Pushing the button a second time turns the compressor OFF.

Slight changes in engine speed or power may be noticed when the compressor is on. This is a normal occurrence since the compressor will cycle on and off to maintain comfort and increase fuel economy.

NOTE: If your air conditioning performance seems lower than expected, check the front of the A/C condenser for an accumulation of dirt or insects.

Operating Tips

NOTE: Refer to the chart at the end of this section for suggested control settings for various weather conditions.

Summer Operation

The engine cooling system in air-conditioned vehicles must be protected with a high-quality antifreeze coolant to provide proper corrosion protection and to protect against engine overheating. A 50% solution of ethylene glycol antifreeze coolant in water is recommended. Refer to "Maintenance Procedures" in Section 7 of this manual for proper coolant selection.

Winter Operation

- Use the Defrost mode to direct cold air away from the occupants during engine warm-up in cold weather.
- The blower air will heat faster in cold weather if you use only the low blower speeds for the first ten minutes of vehicle operation.
- Use of the air Recirculation mode during winter months is not recommended because it may cause window fogging.

Vacation Storage

Anytime you store your vehicle, or keep it out of service (i.e., vacation) for two weeks or more, run the air conditioning system at idle for about five minutes in the fresh air and high blower setting. This will insure adequate system lubrication to minimize the possibility of compressor damage when the system is started again.













Window Fogging

Interior fogging on the windshield can be quickly removed by turning the mode selector to Defrost. The Defrost/Floor mode can be used to maintain a clear windshield and provide sufficient heating. If side window fogging becomes a problem increase blower speed. Vehicle windows tend to fog on the inside in mild but rainy or humid weather.

Outside Air Intake

When operating the system, particularly during the winter months, make sure the air intake, at the right side of the hood, is free of ice, slush, snow, or other obstructions such as leaves. Leaves collected in the air-intake plenum may reduce airflow and plug the plenum water drains.

Control Setting Suggestions for Various Weather Conditions

WEATHER	CONTROL SETTINGS
<p>HOT WEATHER AND VEHICLE INTERIOR IS VERY HOT</p> 	<p>Start vehicle and put Mode Control in  position and turn on A/C. Set Fan Control to High. Roll windows down to flush out hot air. Roll windows up after hot air is flushed out. Turn Mode Control to  and set Fan and Temp Knobs as desired once car has cooled.</p>
<p>WARM WEATHER</p> 	<p>Set the Mode Control to  position and turn A/C on in sunny weather. Choose the  position for cloudy or dark conditions with A/C on.</p>
<p>COOL OR COLD HUMID CONDITIONS</p> 	<p>Set the Mode Control to  position and turn the A/C on in sunny weather. Choose the  position and turn on the A/C in cloudy or dark conditions.</p>
<p>COLD DRY CONDITIONS</p> 	<p>Use the  position in sunny weather, the  position in cloudy or dark weather, and the  Mode Knob setting for snowy or very cold weather that requires extra heat to the windshield.</p>

815193c4

STARTING AND OPERATING

CONTENTS

■ Starting Procedures	134	□ Traction	141
□ Normal Starting	135	■ Driving Through Water	142
□ If Engine Fails To Start	136	□ Flowing/Rising Water	142
□ After Starting	137	□ Shallow Standing Water	142
■ Manual Transmission	137	■ Power Steering	144
□ Recommended Shift Speeds	139	□ Power Steering Fluid Check	144
□ Skip Shift Indicator Light	139	■ Parking Brake	145
■ Driving On Slippery Surfaces	141	■ Brake System	147
□ Acceleration	141	□ Brake Pad Break-In	147

132 STARTING AND OPERATING

□ Anti-Lock Brake System	148	□ Replacement Tires	166
■ Tire Safety Information	151	□ Tire Storage	167
□ Tire Markings	151	■ Tire Chains	167
□ Tire Identification Number (TIN)	155	■ Snow Tires	167
□ Tire Loading And Tire Pressure	156	■ Tire Rotation Recommendations	167
■ Tires — General Information	160	■ Tire Pressure Monitor System (TPMS)	169
□ Tire Pressure	160	□ Low Tire Indicator	169
□ Tire Inflation Pressures	161	■ Fuel Requirements	170
□ Tire Pressures For High Speed Operation	162	□ 8.4L Engine	170
□ Radial Ply Tires	163	□ Reformulated Gasoline	171
□ Tire Spinning	164	□ Gasoline/Oxygenate Blends	171
□ Tread Wear Indicators	164	□ E-85 Usage In Non-Flex Fuel Vehicles	172
□ Life Of Tire	165	□ MMT In Gasoline	172

□ Materials Added To Fuel	173	■ Recreational Towing (Behind Motorhome, Etc.).	176
□ Fuel System Cautions	173	□ Towing This Vehicle Behind Another Vehicle (Flat Towing With All Four Wheels On The Ground)	176
□ Carbon Monoxide Warnings	174	■ Ground Clearance	177
■ Adding Fuel	175		
□ Fuel Filler Cap (Gas Cap)	175		
■ Trailer Towing	176		

STARTING PROCEDURES

Before starting your vehicle, adjust your seat, adjust the inside and outside mirrors, fasten your seat belt, and if present, instruct any other occupant to buckle their seat belt.

WARNING!

- Never leave children alone in a vehicle. Leaving children in a vehicle unattended is dangerous for a number of reasons. A child or others could be injured seriously or fatally. Don't leave the keys in the ignition. A child could operate power windows, other controls, or move the vehicle.
- Do not leave animals or children inside parked vehicles in hot weather; interior heat build up may cause serious injury or death.

(Continued)

WARNING! (Continued)

- Be sure to turn off the engine if you want to rest or sleep in your car. Accidents can be caused by inadvertently moving the gear selection lever or by pressing the accelerator pedal. This may cause excessive heat in the exhaust system, resulting in overheating and vehicle fire, which may cause serious or fatal injuries.

CAUTION!

Long periods of engine idling, especially at high engine speeds, can cause excessive exhaust temperatures, which can damage your vehicle. Do not leave your vehicle unattended with the engine running.

Normal Starting

CAUTION!

The engine in your vehicle is designed for operation down to 0°F (-18°C). Starting the engine below 0°F (-18°C) creates a potential for scuffing or seizing of internal components in this very high performance engine. To prevent engine damage, do not start the engine at temperatures below 0°F (-18°C).

NOTE:

- You must disarm the security system in order to start the engine. For details, refer to “Security Alarm System” in Section 2 of this manual
- Normal Starting of either a cold or a warm engine does not require pumping or depressing the accelerator pedal. However, if the engine has not started within three seconds, slightly depress the accelerator pedal

while continuing to crank. If the engine fails to start within 15 seconds, turn the key to the OFF/LOCK position, wait five seconds, then repeat the normal starting procedure.

To start the engine:

1. Fully apply the parking brake.
2. Press the clutch pedal to the floor.

NOTE: The engine will not start unless the clutch pedal is pressed to the floor.

3. Place the gear selector in NEUTRAL
4. Insert the ignition key fully into the ignition switch
5. Turn the key to the ON/RUN position.

6. Press the red ENGINE START button located on the instrument panel. Release the button when the engine starts.

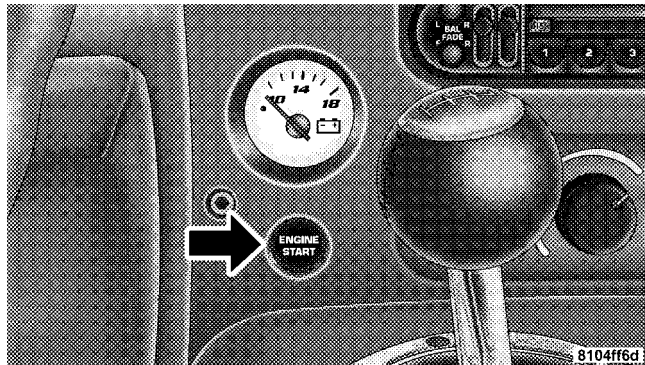

ENGINE START Button

If Engine Fails to Start

CAUTION!

To prevent damage to the starter, do not crank the engine for more than 15 seconds at a time. Wait 10 to 15 seconds before trying again.

WARNING!

- Never pour fuel or other flammable liquid into the throttle body air inlet opening in an attempt to start the vehicle. This could result in flash fire causing serious personal injury.

(Continued)

WARNING! (Continued)

- **Do not attempt to push or tow your vehicle to get it started. Unburned fuel could enter the catalytic converter and once the engine has started, ignite and damage the converter and vehicle. If the vehicle has a discharged battery, booster cables may be used to obtain a start from a booster battery or the battery in another vehicle. This type of start can be dangerous if done improperly, so follow this procedure carefully. See section 6 of this manual for jump starting instructions.**

If the engine is flooded, it may start to run, but not have enough power to continue running when the ENGINE START button is released. If this occurs, continue cranking up to 15 seconds with the accelerator pedal pushed all the way to the floor. Release the accelerator pedal and the ENGINE START button once the engine is running smoothly.

If the engine shows no sign of starting after two 15 second periods of cranking with the accelerator pedal held to the floor, the NORMAL STARTING procedure should be repeated.

After Starting

The idle speed will automatically decrease as the engine warms up.

MANUAL TRANSMISSION

NOTE: The parking brake should be engaged and the shift lever selector placed in REVERSE before leaving the vehicle, especially when parked on an incline.

Your vehicle is equipped with a high torque capacity dual disc clutch. The clutch pedal must be fully depressed to the floor during each shift. As you release the clutch pedal, lightly depress the accelerator pedal.

CAUTION!

Failure to depress the clutch pedal fully to the floor may cause increased shift efforts, and may result in damage to the clutch and transmission.

Be sure the transmission is in **FIRST** gear when moving forward from a standing position.

CAUTION!

Failure to start out in **FIRST gear when moving forward from a starting position may result in damage to the clutch.**

You will find it easier to use only the lower gears for most city driving. For steady highway driving with light accelerations, **SIXTH** gear is recommended.

Never drive with your foot resting on the clutch pedal, or try to hold the vehicle on a hill with the clutch pedal partially engaged. This will cause abnormal wear on the clutch.

Never shift into **REVERSE** until the vehicle has come to a complete stop.

NOTE:

- Your vehicle is equipped with a transmission reverse inhibitor system. When vehicle speed is greater than 5 mph (8 km/h), the reverse inhibitor activates to help prevent shifts into **REVERSE**. When at a complete stop, you may notice light shift efforts into **REVERSE** with the ignition key **ON**, and increased shift efforts into **REVERSE** with the ignition key **OFF**. This is normal operation of the transmission reverse inhibitor system.

- Shifting gears during cold weather may require an increased effort until the transmission lubricant is warm. This is normal and not harmful to the transmission.
- Due to the high performance nature of your drivetrain, a certain amount of noise from the transmission is normal. This noise can be most noticeable when the vehicle is idling in NEUTRAL with the clutch engaged (clutch pedal released), but it may also be heard when driving. The noise may also be more noticeable when the transmission is warm. This noise is normal and is not an indication of a problem with your clutch or transmission.

Recommended Shift Speeds

To use your manual transmission for fuel economy it should be upshifted as listed below. Shift at the vehicle speeds listed for acceleration. Earlier upshifts during

cruise conditions (relatively steady speeds) will result in increased fuel economy, and may be used as indicated.

MANUAL TRANSMISSION RECOMMENDED SHIFT SPEEDS					
	1-2	2-3	3-4	4-5	5-6
mph	15	25	40	45	50
(km/h)	(24)	(40)	(64)	(72)	(80)

Higher upshift speeds may be used to obtain a desired acceleration rate.

Skip Shift Indicator Light



There are times when you must shift the transmission directly from FIRST gear to FOURTH gear instead of from FIRST gear to SECOND gear. This is to help you get the best possible fuel economy from your vehicle. This occurs when engine coolant is higher than 106°F (41°C), and vehicle speed is greater than 12 mph (19 km/h) but less than 20 mph (32 km/h), and engine speed is less than 1,322 RPM, and the transmission is in

FIRST gear, and the accelerator is at 1/4 throttle or less. The Skip Shift Indicator Light located in the tachometer will turn Amber during these times.

When the indicator light turns amber, the shift mechanism will only allow shifts from FIRST gear to FOURTH gear. After you shift the transmission into FOURTH gear, you can press the clutch in and shift to another forward gear.

Downshifting - Proper downshifting will improve fuel economy and prolong engine life.

To maintain a safe speed and prolong brake life, downshift to maintain a safe speed when descending a steep grade.

WARNING!

Skipping more than one gear while downshifting, could cause you to lose control of your vehicle. You could have an accident.

CAUTION!

If you skip more than one gear while downshifting or downshift at too high an engine speed, you could damage the engine, transmission, or clutch.

DRIVING ON SLIPPERY SURFACES

Acceleration

WARNING!

Rapid acceleration on slippery surfaces is dangerous. You could lose control of the vehicle and possibly have an accident. Accelerate slowly and carefully whenever there is likely to be poor traction (ice, snow, wet, mud, loose sand, etc.).

Traction

When driving on wet or slushy roads, it is possible for a wedge of water to build up between the tire and road surface. This is hydroplaning and may cause partial or complete loss of vehicle control and stopping ability. To reduce this possibility, the following precautions should be observed:

1. Slow down during rainstorms or when roads are slushy.
2. Slow down if road has standing water or puddles.

CAUTION!

Driving your vehicle through deep puddles at speeds over 5 mph (8 km/h), may cause water to be ingested into the engine. This can cause severe engine damage.

3. Replace tires when tread wear indicators first become visible.
4. Keep tires properly inflated.
5. Maintain enough distance between your vehicle and the vehicle in front to avoid a collision in a sudden stop.

DRIVING THROUGH WATER

Driving through water more than a few inches/centimeters deep will require extra caution to ensure safety and prevent damage to your vehicle.

Flowing/Rising Water

WARNING!

Do not drive on or cross a road or a path where water is flowing and/or rising (as in storm run-off). Flowing water can wear away the road or path's surface and cause your vehicle to sink into deeper water. Furthermore, flowing and/or rising water can carry your vehicle away swiftly. Failure to follow this warning may result in injuries that are serious or fatal to you, your passengers, and others around you.

Shallow Standing Water

Although your vehicle is capable of driving through shallow standing water, consider the following Caution and Warning before doing so.

CAUTION!

- Always check the depth of the standing water before driving through it. Never drive through standing water that is deeper than the bottom of the tire rims mounted on the vehicle.
- Determine the condition of the road or the path that is under water and if there are any obstacles in the way before driving through the standing water.
- Do not exceed 5 mph (8 km/h) when driving through standing water. This will minimize wave effects.

(Continued)

CAUTION! (Continued)

- Driving through standing water may cause damage to your vehicle's drivetrain components. Always inspect your vehicle's fluids (i.e., engine oil, transmission/transaxle, axle, etc.) for signs of contamination (i.e., fluid that is milky or foamy in appearance) after driving through standing water. Do not continue to operate the vehicle if any fluid appears contaminated, as this may result in further damage. Such damage is not covered by the New Vehicle Limited Warranty.
- Getting water inside your vehicle's engine can cause it to lock up and stall out, and cause serious internal damage to the engine. Such damage is not covered by the New Vehicle Limited Warranty.

WARNING!

- Driving through standing water limits your vehicle's traction capabilities. Do not exceed 5 mph (8 km/h) when driving through standing water.
- Driving through standing water limits your vehicle's braking capabilities, which increases stopping distances. Therefore, after driving through standing water, drive slowly and lightly press on the brake pedal several times to dry the brakes.
- Getting water inside your vehicle's engine can cause it to lock up and stall out, and leave you stranded.
- Failure to follow these warnings may result in injuries that are serious or fatal to you, your passengers, and others around you.

POWER STEERING

The standard power steering system will give you good vehicle response and increased ease of maneuverability in tight spaces. The system will provide mechanical steering capability if power assist is lost.

If for some reason the power assist is interrupted, it will still be possible to steer your vehicle. Under these conditions, you will observe a substantial increase in steering effort, especially at very low vehicle speeds and during parking maneuvers.

NOTE: Increased noise levels at the end of the steering wheel travel are considered normal and do not indicate that there is a problem with the power steering system.

Upon initial start-up in cold weather, the power steering pump may make noise for a short amount of time. This is due to the cold, thick fluid in the steering system. This noise should be considered normal, and it does not in any way damage the steering system.

WARNING!

Continued operation with reduced power steering assist could pose a safety risk to yourself and others. Service should be obtained as soon as possible.

CAUTION!

Prolonged operation of the steering system at the end of the steering wheel travel will increase the steering fluid temperature and it should be avoided when possible. Damage to the power steering pump may occur.

Power Steering Fluid Check

Checking the power steering fluid level at a defined service interval is not required. The fluid should only be checked if a leak is suspected, abnormal noises are

apparent, and/or the system is not functioning as anticipated. Coordinate inspection efforts through an authorized dealer.

No chemical flushes should be used in any power steering system; only the approved lubricant may be used.

WARNING!

Fluid level should be checked on a level surface and with the engine off to prevent injury from moving parts and to ensure accurate fluid level reading. Do not overfill. Use only manufacturer's recommended power steering fluid.

If necessary, add fluid to restore to the proper indicated level. With a clean cloth, wipe any spilled fluid from all surfaces. Refer to "Fluids, Lubricants, and Genuine Parts" in Section 7 for the correct fluid type.

PARKING BRAKE

The parking brake should always be applied when the driver is not in the vehicle.

WARNING!

Before leaving the vehicle, make sure you fully apply the parking brake and shift the transmission into REVERSE. Failure to do so may cause the vehicle to roll and cause damage or injury.

5

As an added precaution when parking the vehicle, turn the front wheels toward the curb on a downhill grade and away from the curb on an uphill grade.

To apply the parking brake, grasp the handle and pull it rearward until you feel resistance. To release the parking brake, grasp the handle and pull it slightly while pressing the button on the end of the handle. When the button

drops into the handle (releasing the lock), guide the handle downward to its stop and then release the button and the handle.

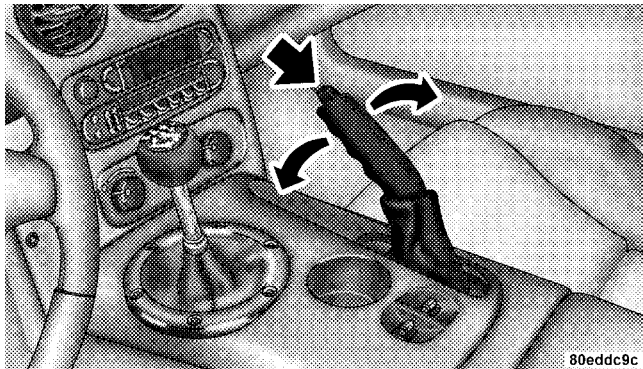

Parking Brake

The Brake System Warning Light in the instrument cluster will turn on when the ignition is in the ON/RUN position and the parking brake is applied.

NOTE: This light only shows that the parking brake is applied. It does not show the degree of brake application.

WARNING!

- Never leave children alone in a vehicle. Leaving children in a vehicle unattended is dangerous for a number of reasons. A child or others could be injured seriously or fatally. Don't leave the keys in the ignition. A child could operate power windows, other controls, or move the vehicle.
- Be sure the parking brake is fully disengaged before driving. Failure to do so can lead to brake failure, and an accident.

BRAKE SYSTEM

BRAKE Your vehicle is equipped with dual hydraulic brake systems. If either of the two hydraulic systems loses normal capability, the remaining system will still function. However, there will be some loss of overall braking effectiveness. You may notice increased pedal travel during application, greater pedal force required to slow or stop, and potential activation of the Brake System Warning Light.

In the event power assist is lost for any reason (i.e., repeated brake applications with the engine off) the brakes will still function. However, the effort required to brake the vehicle will be much greater than that required with the power system operating.

Brake Pad Break-In

NOTE: Your vehicle is equipped with a high performance braking system. The brake pads are a semi-metallic compound, which offer superior fade resistance for consistent operation. A compromise to using this type of brake pad is that the brakes may squeal slightly under certain weather and operating conditions (i.e., during light brake applications).

The brakes on your new vehicle do not require a long break-in period. However, you should avoid repeated hard brake applications from high speeds during initial break-in. In addition, you should avoid severe brake loading, such as may be encountered when descending long mountain grades.

Safe Operating Tips

WARNING!

To use your brakes and accelerator more safely, follow these tips:

- Do not “ride” the brakes by resting your foot on the pedal. This could overheat the brakes and result in unpredictable braking action, longer stopping distances, or brake damage.
- When descending mountains or hills, repeated braking can cause brake fade with loss of braking control. Avoid repeated heavy braking by downshifting the transmission whenever possible.

(Continued)

WARNING! (Continued)

- Do not drive too fast for road conditions, especially when roads are wet or slushy. A wedge of water can build up between the tire tread and the road. This hydroplaning action can cause loss of traction, braking ability, and control.
- After going through deep water or a car wash, brakes may become wet, resulting in decreased performance and unpredictable braking action. Dry the brakes by gentle, intermittent pedal action while driving at very slow speeds.

Anti-Lock Brake System

The Anti-Lock Brake System (ABS) is designed to aid the driver in maintaining vehicle control under adverse braking conditions. The system operates with a separate computer to modulate hydraulic pressure to prevent wheel lock-up and help avoid skidding on slippery surfaces.

NOTE: During severe braking conditions, a pulsing sensation may occur and a clicking noise will be heard. This is normal, indicating that the Anti-Lock Brake System is functioning.

The Anti-Lock Brake System conducts a low-speed self-test at about 12 mph (20 km/h). If you have your foot lightly on the brake while this test is occurring, you may feel slight pedal movement. The movement can be more apparent on ice and snow. This is normal.

The Anti-Lock Brake System pump motor runs during the self-test at 12 mph (20 km/h) and during an ABS stop. The pump motor makes a low humming noise during operation, which is normal.

CAUTION!

The Anti-Lock Brake System is subject to possible detrimental effects of electronic interference caused by improperly installed aftermarket radios or telephones.

WARNING!

- The Anti-Lock Brake System contains sophisticated electronic equipment that may be susceptible to interference caused by improperly installed or high output radio transmitting equipment. This interference can cause possible loss of anti-lock braking capability. Installation of such equipment should be performed by qualified professionals.

(Continued)

WARNING! (Continued)

- Pumping of the Anti-Lock Brakes will diminish their effectiveness and may lead to an accident. Pumping makes the stopping distance longer. Just press firmly on your brake pedal when you need to slow down or stop.
- Anti-lock system (ABS) cannot prevent the natural laws of physics from acting on the vehicle, nor can it increase braking or steering efficiency beyond that afforded by the condition of the vehicle brakes and tires or the traction afforded.
- The ABS cannot prevent accidents, including those resulting from excessive speed in turns, following another vehicle too closely, or hydroplaning. Only a safe, attentive, and skillful driver can prevent accidents.

(Continued)

WARNING! (Continued)

- The capabilities of an ABS equipped vehicle must never be exploited in a reckless or dangerous manner, which could jeopardize the user's safety or the safety of others.

All vehicle wheels and tires must be the same size and type as the original equipment and the tires must be properly inflated to produce accurate signals for the computer.

WARNING!

Significant over- or under-inflation of tires, or mixing sizes of front or rear tires or wheels on the vehicle can lead to loss of braking effectiveness.

Anti-Lock Brake Warning Light



The amber Anti-Lock Brake Warning Light will turn on and stay on briefly as a bulb check when the ignition is first turned on. If the light does not turn on during starting, have it repaired promptly.

This light also illuminates at vehicle start-up to indicate that the ABS self-check is in process. If the light remains on after start-up, or turns on and remains on at road speeds, it may indicate a system malfunction or that the system is inoperative. In this case, the system reverts to standard non-anti-lock brakes. If this occurs, safely bring the vehicle to a complete stop as soon as possible and cycle the ignition key to attempt to reset the ABS. If the light remains on, see your authorized dealer immediately to have the system serviced. Furthermore, if the red BRAKE Warning Light and the amber ABS Warning Light are on, and the parking brake is fully released, see your authorized dealer immediately.

TIRE SAFETY INFORMATION

Tire Markings

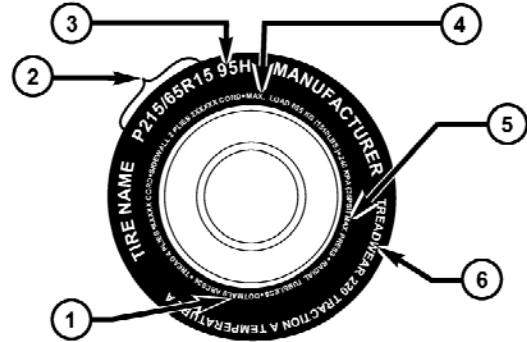

054903773

- 1 — U.S. DOT Safety Standards Code (TIN)
- 2 — Size Designation
- 3 — Service Description

- 4 — Maximum Load
- 5 — Maximum Pressure
- 6 — Treadwear, Traction and Temperature Grades

NOTE:

- P (Passenger) - Metric tire sizing is based on U.S. design standards. P-Metric tires have the letter "P" molded into the sidewall preceding the size designation. Example: P215/65R15 95H.
- European-Metric tire sizing is based on European design standards. Tires designed to this standard have the tire size molded into the sidewall beginning with the section width. The letter "P" is absent from this tire size designation. Example: 215/65R15 96H.
- LT (Light Truck) - Metric tire sizing is based on U.S. design standards. The size designation for LT-Metric tires is the same as for P-Metric tires except for the letters "LT" that are molded into the sidewall preceding the size designation. Example: LT235/85R16.
- Temporary spare tires are high-pressure compact spares designed for temporary emergency use only. Tires designed to this standard have the letter "T" molded into the sidewall preceding the size designation. Example: T145/80D18 103M.
- High flotation tire sizing is based on U.S. design standards and it begins with the tire diameter molded into the sidewall. Example: 31x10.5 R15 LT.

Tire Sizing Chart

EXAMPLE:
Size Designation:
<p>P = Passenger car tire size based on U.S. design standards "...blank..." = Passenger car tire based on European design standards LT = Light truck tire based on U.S. design standards T = Temporary spare tire 31 = Overall diameter in inches (in)</p>
215 = Section width in millimeters (mm)
<p>65 = Aspect ratio in percent (%) — Ratio of section height to section width of tire</p>
10.5 = Section width in inches (in)
<p>R = Construction code — "R" means radial construction —"D" means diagonal or bias construction</p>
15 = Rim diameter in inches (in)

EXAMPLE:**Service Description:**

95 = Load Index

— A numerical code associated with the maximum load a tire can carry

H = Speed Symbol

— A symbol indicating the range of speeds at which a tire can carry a load corresponding to its load index under certain operating conditions

— The maximum speed corresponding to the speed symbol should only be achieved under specified operating conditions (i.e., tire pressure, vehicle loading, road conditions, and posted speed limits)

Load Identification:

"...blank..." = Absence of any text on the sidewall of the tire indicates a Standard Load (SL) tire

Extra Load (XL) = Extra load (or reinforced) tire

Light Load = Light load tire

C, D, E = Load range associated with the maximum load a tire can carry at a specified pressure

Maximum Load — Maximum load indicates the maximum load this tire is designed to carry

Maximum Pressure — Maximum pressure indicates the maximum permissible cold tire inflation pressure for this tire

Tire Identification Number (TIN)

The TIN may be found on one or both sides of the tire, however, the date code may only be on one side. Tires with white sidewalls will have the full TIN, including the date code,

located on the white sidewall side of the tire. Look for the TIN on the outboard side of black sidewall tires as mounted on the vehicle. If the TIN is not found on the outboard side, then you will find it on the inboard side of the tire.

EXAMPLE:

DOT MA L9 ABCD 0301

DOT = Department of Transportation

— This symbol certifies that the tire is in compliance with the U.S. Department of Transportation tire safety standards and is approved for highway use

MA = Code representing the tire manufacturing location (two digits)

L9 = Code representing the tire size (two digits)

ABCD = Code used by the tire manufacturer (one to four digits)

03 = Number representing the week in which the tire was manufactured (two digits)

—03 means the 3rd week.

01 = Number representing the year in which the tire was manufactured (two digits)

—01 means the year 2001

— Prior to July 2000, tire manufacturers were only required to have one number to represent the year in which the tire was manufactured. Example: 031 could represent the 3rd week of 1981 or 1991

Tire Loading and Tire Pressure

Tire Placard Location

NOTE: The proper cold tire inflation pressure is listed on the driver's side B-Pillar.

Tire and Loading Information Placard

TIRE AND LOADING INFORMATION

SEATING CAPACITY - TOTAL 5 FRONT 2 REAR 3 ← 1

THE COMBINED WEIGHT OF OCCUPANTS AND CARGO SHOULD NEVER EXCEED XXX KG OR XXX LBS. ← 2

TIRE	FRONT	REAR	SPARE
ORIGINAL TIRE SIZE	P195/70R14	P195/70R14	T125/70D15 ← 3
COLD TIRE INFLATION PRESSURE	200kPa, 29PSI	200kPa, 29PSI	420kPa, 60PSI ← 4

SEE OWNER'S MANUAL FOR ADDITIONAL INFORMATION 4N109268

This placard tells you important information about the:

- 1) number of people that can be carried in the vehicle
- 2) total weight your vehicle can carry
- 3) tire size designed for your vehicle
- 4) cold tire inflation pressures for the front, rear, and spare tires.

Loading

The vehicle maximum load on the tire must not exceed the load carrying capacity of the tire on your vehicle. You will not exceed the tire's load carrying capacity if you adhere to the loading conditions, tire size, and cold tire inflation pressures specified on the Tire and Loading Information placard and in the "Vehicle Loading" section of this manual.

811b5a9a

Tire and Loading Information Placard

NOTE: Under a maximum loaded vehicle condition, gross axle weight ratings (GAWRs) for the front and rear axles must not be exceeded. For further information on GAWRs, vehicle loading, and trailer towing, refer to “Vehicle Loading” in this section.

To determine the maximum loading conditions of your vehicle, locate the statement “The combined weight of occupants and cargo should never exceed XXX lbs or XXX kg” on the Tire and Loading Information placard. The combined weight of occupants, cargo/luggage and trailer tongue weight (if applicable) should never exceed the weight referenced here.

Steps for Determining Correct Load Limit

1. Locate the statement “The combined weight of occupants and cargo should never exceed XXX lbs or XXX kg” on your vehicle’s placard.

2. Determine the combined weight of the driver and passengers that will be riding in your vehicle.

3. Subtract the combined weight of the driver and passengers from XXX lbs or XXX kg.

4. The resulting figure equals the available amount of cargo and luggage load capacity. For example, if “XXX” amount equals 1,400 lbs (635 kg) and there will be five 150 lb (68 kg) passengers in your vehicle, the amount of available cargo and luggage load capacity is 650 lbs (295 kg) (since $5 \times 150 = 750$, and $1400 - 750 = 650$ lbs [295 kg]).

5. Determine the combined weight of luggage and cargo being loaded on the vehicle. That weight may not safely exceed the available cargo and luggage load capacity calculated in step 4.

6. If your vehicle will be towing a trailer, load from your trailer will be transferred to your vehicle. Consult this manual to determine how this reduces the available cargo and luggage load capacity of your vehicle.

NOTE:

- The following table shows examples on how to calculate total load, cargo/luggage, and towing capacities of your vehicle with varying seating configurations and number and size of occupants. This table is for illustration purposes only and may not be accurate for the seating and load carry capacity of your vehicle.
- For the following example, the combined weight of occupants and cargo should never exceed 865 lbs (392 kg).

Occupants			Combined weight of occupants and cargo from Tire Placard	MINUS	Combined Occupant's weight	=	AVAILABLE Cargo/Luggage and Trailer Tongue Weight
TOTAL	FRONT	REAR					
EXAMPLE 1			865 lbs	minus	670 lbs	=	195 lbs
5	2	3					
EXAMPLE 2			865 lbs	minus	540 lbs	=	325 lbs
3	2	1					
EXAMPLE 3			865 lbs	minus	400 lbs	=	465 lbs
2	2	0					

Occupant 1: 200 lbs
 Occupant 2: 130 lbs
 Occupant 3: 160 lbs
 Occupant 4: 100 lbs
 Occupant 5: 80 lbs
 TOTAL WEIGHT: 670 lbs

Occupant 1: 210 lbs
 Occupant 2: 180 lbs
 Occupant 3: 150 lbs
 TOTAL WEIGHT: 540 lbs

Occupant 1: 200 lbs
 Occupant 2: 200 lbs
 TOTAL WEIGHT: 400 lbs

811a4d11

WARNING!

Overloading of your tires is dangerous. Overloading can cause tire failure, affect vehicle handling, and increase your stopping distance. Use tires of the recommended load capacity for your vehicle. Never overload them.

TIRES — GENERAL INFORMATION**Tire Pressure**

Proper tire inflation pressure is essential to the safe and satisfactory operation of your vehicle. Three primary areas are affected by improper tire pressure:

Safety**WARNING!**

- Improperly inflated tires are dangerous and can cause accidents.
- Underinflation increases tire flexing and can result in tire failure.
- Overinflation reduces a tire's ability to cushion shock. Objects on the road and chuckholes can cause damage that result in tire failure.
- Unequal tire pressures can cause steering problems. You could lose control of your vehicle.
- Overinflated or underinflated tires can affect vehicle handling and can fail suddenly, resulting in loss of vehicle control.

(Continued)

WARNING! (Continued)

- Unequal tire pressures from one side of the vehicle to the other can cause the vehicle to drift to the right or left.
- Always drive with each tire inflated to the recommended cold tire inflation pressure.

Economy

Improper inflation pressures can cause uneven wear patterns to develop across the tire tread. These abnormal wear patterns will reduce tread life resulting in a need for earlier tire replacement. Under-inflation also increases tire rolling resistance and results in higher fuel consumption.

Ride Comfort and Vehicle Stability

Proper tire inflation contributes to a comfortable ride. Over-inflation produces a jarring and uncomfortable ride.

Tire Inflation Pressures

The proper cold tire inflation pressure is listed on the driver's side "B" Pillar.

Some vehicles may have Supplemental Tire Pressure Information for vehicle loads that are less than the maximum loaded vehicle condition. These pressure conditions will be found in the "Supplemental Tire Pressure Information" section of this manual.

The pressure should be checked and adjusted as well as inspecting for signs of tire wear or visible damage at least once a month. Use a good quality pocket-type gauge to check tire pressure. DO NOT make a visual judgement when determining proper inflation. Radial tires may look properly inflated even when they are under-inflated.

CAUTION!

After inspecting or adjusting the tire pressure, always reinstall the valve stem cap (if equipped). This will prevent moisture and dirt from entering the valve stem, which could damage the valve stem.

Inflation pressures specified on the placard are always "cold tire inflation pressure." Cold tire inflation pressure is defined as the tire pressure after the vehicle has not been driven for at least three hours, or driven less than 1 mile (1.6 km) after a three hour period. The cold tire inflation pressure must not exceed the maximum inflation pressure molded into the tire sidewall.

Check tire pressures more often if subject to a wide range of outdoor temperatures, as tire pressures vary with temperature changes.

Tire pressures change by approximately 1 psi (7 kPa) per 12°F (7°C) of air temperature change. Keep this in mind when checking tire pressure inside a garage, especially in the Winter.

Example: If garage temperature = 68°F (20°C) and the outside temperature = 32°F (0°C) then the cold tire inflation pressure should be increased by 3 psi (21 kPa), which equals 1 psi (7 kPa) for every 12°F (7°C) for this outside temperature condition.

Tire pressure may increase from 2 to 6 psi (13 to 40 kPa) during operation. DO NOT reduce this normal pressure build up or your tire pressure will be too low.

Tire Pressures for High Speed Operation

The manufacturer advocates driving at safe speeds within posted speed limits. Where speed limits or conditions are such that the vehicle can be driven at high speeds, maintaining correct tire inflation pressure is very important. Increased tire pressure and reduced vehicle

loading may be required for high-speed vehicle operation. Refer to original equipment or an authorized tire dealer for recommended safe operating speeds, loading and cold tire inflation pressures.

WARNING!

High speed driving with your vehicle under maximum load is dangerous. The added strain on your tires could cause them to fail. You could have a serious accident. Do not drive a vehicle loaded to the maximum capacity at continuous speeds above 75 mph (120 km/h).

Radial Ply Tires**WARNING!**

Combining radial ply tires with other types of tires on your vehicle will cause your vehicle to handle poorly. The instability could cause an accident. Always use radial ply tires in sets of four (or six, in case of trucks with dual rear wheels). Never combine them with other types of tires.

Cuts and punctures in radial tires are repairable only in the tread area because of sidewall flexing. Consult your authorized tire dealer for radial tire repairs.

Tire Spinning

When stuck in mud, sand, snow, or ice conditions, do not spin your vehicle's wheels faster than 30 mph (48 km/h).

For additional information, refer to "Freeing A Stuck Vehicle" in Section 6.

WARNING!

Fast spinning tires can be dangerous. Forces generated by excessive wheel speeds may cause tire damage or failure. A tire could explode and injure someone. **DO NOT** spin your vehicle's wheels faster than 30 mph (48 km/h) or for more than 30 seconds continuously when you are stuck, and do not let anyone near a spinning wheel, no matter what the speed.

Tread Wear Indicators

Tread wear indicators are in the original equipment tires to help you in determining when your tires should be replaced.

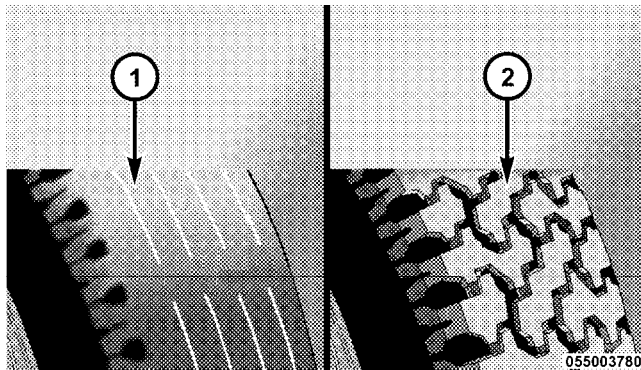

- 1 — Worn Tire
- 2 — New Tire

These indicators are molded into the bottom of the tread grooves. They will appear as bands when the tread depth becomes 1/16 in (2 mm). When the tread is worn to the tread wear indicators, the tire should be replaced.

Many states have laws requiring tire replacement at this point.

Life of Tire

The service life of a tire is dependent upon varying factors including, but not limited to:

- Driving style
- Tire pressure
- Distance driven

WARNING!

Tires and the spare tire should be replaced after six years, regardless of the remaining tread. Failure to follow this warning can result in sudden tire failure. You could lose control and have an accident resulting in serious injury or death.

Keep dismantled tires in a cool, dry place with as little exposure to light as possible. Protect tires from contact with oil, grease, and gasoline.

Replacement Tires

The tires on your new vehicle provide a balance of many characteristics. They should be inspected regularly for wear and correct cold tire inflation pressure. The manufacturer strongly recommends that you use tires equivalent to the originals in size, quality and performance when replacement is needed. (Refer to the paragraph on "Tread Wear Indicators"). Refer to the "Tire and Loading Information" placard for the size designation of your tire. The service description and load identification will be found on the original equipment tire. Failure to use equivalent replacement tires may adversely affect the safety, handling, and ride of your vehicle. We recommend that you contact your original equipment or an authorized tire dealer with any questions you may have on tire specifications or capability.

WARNING!

- **DO NOT use a tire, wheel size or rating other than that specified for your vehicle. Some combinations of unapproved tires and wheels may change suspension dimensions and performance characteristics, resulting in changes to steering, handling, and braking of your vehicle. This can cause unpredictable handling and stress to steering and suspension components. You could lose control and have an accident resulting in serious injury or death. Use only the tire and wheel sizes with load ratings approved for your vehicle.**
- **Never use a tire with a smaller load index or capacity, other than what was originally equipped on your vehicle. Using a tire with a smaller load index could result in tire overloading and failure. You could lose control and have an accident.**

(Continued)

WARNING! (Continued)

- Failure to equip your vehicle with tires having adequate speed capability can result in sudden tire failure and loss of vehicle control.

CAUTION!

Replacing original tires with tires of a different size may result in false speedometer and odometer readings.

Tire Storage

Tire storage is addressed in the Michelin Limited Tire Warranty Booklet.

Specific recommendations on guidelines for long term tire storage for this vehicle should be requested of the Michelin Tire Corporation 1-800-433-6838.

TIRE CHAINS

Due to limited clearance, tire chains are not recommended.

CAUTION!

Damage to the vehicle may result if tire chains are used.

SNOW TIRES

There are no snow tires that are compatible with the wheels on this vehicle.

TIRE ROTATION RECOMMENDATIONS

Tires on the front and rear axles of vehicles operate at different loads and perform different steering, driving, and braking functions. For these reasons, they wear at unequal rates, and tend to develop irregular wear patterns.

Rotate the tires “side-to-side” as shown in the diagram.

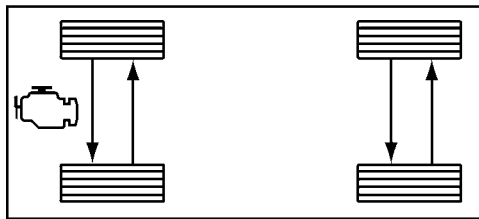

81f10b20

These effects can be reduced by timely rotation of tires. The benefits of rotation are especially worthwhile with aggressive tread designs such as those on all season type tires. Rotation will increase tread life, help to maintain mud, snow, and wet traction levels, and contribute to a smooth, quiet ride.

Refer to the “Maintenance Schedules” in Section 8 for the recommended tire rotation frequency for your type of driving. Remember, more frequent rotation is permissible if desired. Also, correct for anything causing rapid or unusual wear prior to performing the tire rotation.

NOTE: Each wheel on your vehicle contains a tire pressure sensor. The Tire Pressure Monitor System (TPMS) learns the location of each sensor through system programming. Although not required, the manufacturer recommends reprogramming the TPMS after rotating the tires so that the system can relearn each sensor’s location. See your authorized dealer for system reprogramming.

TIRE PRESSURE MONITOR SYSTEM (TPMS)

Low Tire Indicator

If tire pressure falls below 23 psi (159 kpa), the Low Tire Pressure Telltale in the Message Center will illuminate, a chime will sound, and the words LOW TIRE will flash slowly in the Liquid Crystal Display (LCD) panel in the bottom of the speedometer. If tire pressure falls below 18 psi (124 kpa), the Low Tire Pressure Telltale will illuminate, a chime will sound, and the words "FLAT TIRE" will flash rapidly in the display. You should obtain immediate service if the low tire indicator is activated.

NOTE: Each wheel on your vehicle contains a tire pressure sensor. The TPMS learns the location of each sensor through system programming. Although not required, the manufacturer recommends reprogramming the TPMS after rotating the tires so that the system can relearn each sensor's location. See your authorized dealer for system reprogramming.

CAUTION!

The Tire Pressure Monitor System (TPMS) has been optimized for the original equipment tires and wheels. The TPMS pressures have been established for the tire size equipped on your vehicle. Undesirable operation or sensor damage may result when using replacement equipment that is not of the same size, type, and/or style. Aftermarket wheels can cause sensor damage. Do not use aftermarket tire sealants or balance beads if your vehicle is equipped with the TPMS, as damage to the sensors may result.

WARNING!

Do not exceed 55 mph (88 km/h) if the LOW Tire indicator is activated. Vehicle handling and braking may be reduced. You could have an accident and be severely or fatally injured.

TPMS Malfunction Warning

Your vehicle has also been equipped with a TPMS malfunction indicator to indicate when the system is not operating properly. The TPMS malfunction indicator is combined with the low tire pressure telltale.

When the system detects a malfunction, the telltale will flash for approximately one minute and then remain continuously illuminated. This sequence will continue upon subsequent vehicle start-ups as long as the malfunction exists. When the malfunction indicator is illuminated, the system may not be able to detect or signal low tire pressure as intended.

TPMS malfunctions may occur for a variety of reasons, including the installation of replacement or alternate tires or wheels on the vehicle that prevent the TPMS from functioning properly. Always check the TPMS malfunction telltale after replacing one or more tires or wheels on

your vehicle to ensure that the replacement or alternate tires and wheels allow the TPMS to continue to function properly.

FUEL REQUIREMENTS

8.4L Engine



The 8.4L engine is designed to meet all emissions regulations and provide excellent fuel economy and performance when using high-quality premium unleaded gasoline with an octane rating of 91 or higher.

Light spark knock at low engine speeds is not harmful to your engine. However, continued heavy spark knock at high speeds can cause damage and immediate service is required.

Poor quality gasoline can cause problems such as hard starting, stalling, and hesitations. If you experience these symptoms, try another brand of “premium” gasoline before considering service for the vehicle.

Over 40 automobile manufacturers around the world have issued and endorsed consistent gasoline specifications (the World Wide Fuel Charter, WWFC) which define fuel properties necessary to deliver enhanced emissions, engine performance, and durability for your vehicle. The manufacturer recommends the use of gasolines that meet the WWFC specifications if they are available.

Reformulated Gasoline

Many areas of the country require the use of cleaner burning gasoline referred to as “Reformulated Gasoline.” Reformulated gasolines contain oxygenates, and are specifically blended to reduce vehicle emissions and improve air quality.

The manufacturer supports the use of reformulated gasolines. Properly blended reformulated gasolines will provide excellent performance and durability of engine and fuel system components.

Gasoline/Oxygenate Blends

Some fuel suppliers blend unleaded gasoline with oxygenates such as 10% ethanol, MTBE, and ETBE. Oxygenates are required in some areas of the country during the winter months to reduce carbon monoxide emissions. Fuels blended with these oxygenates may be used in your vehicle.

CAUTION!

DO NOT use gasolines containing Methanol or E85 Ethanol. Use of these blends may result in starting and driveability problems and may damage critical fuel system components.

Problems that result from using methanol/gasoline or E85 Ethanol blends are not the responsibility of the manufacturer. While MTBE is an oxygenate made from Methanol, it does not have the negative effects of Methanol.

E-85 Usage In Non-Flex Fuel Vehicles

Non-FFV vehicles are compatible with gasoline containing 10% ethanol (E10). Gasoline with higher ethanol content may void the vehicle's warranty.

If a Non-FFV vehicle is inadvertently fueled with E-85 fuel, the engine will have some or all of these symptoms:

- operate in a lean mode
- OBD II "Malfunction Indicator Light" on
- poor engine performance
- poor cold start and cold drivability
- increased risk for fuel system component corrosion

To fix a Non-FFV vehicle inadvertently fueled once with E-85 perform the following:

- drain the fuel tank (see your authorized dealer)
- change the engine oil and oil filter
- disconnect and reconnect the battery to reset the engine controller memory

More extensive repairs will be required for prolonged exposure to E-85 fuel.

MMT In Gasoline

MMT is a manganese containing metallic additive that is blended into some gasoline to increase the octane number. Gasolines blended with MMT offer no performance advantage beyond gasolines of the same octane number without MMT. Gasolines blended with MMT have shown to reduce spark plug life and reduce emission system performance in some vehicles. The manufacturer recommends using gasolines without MMT. Since the MMT

content of gasoline may not be indicated on the pump, you should ask your gasoline retailer if his/her gasoline contains MMT.

It is even more important to look for gasolines without MMT in Canada, because MMT can be used at levels higher than allowed in the United States. MMT is prohibited in Federal and California reformulated gasolines.

Materials Added to Fuel

All gasoline sold in the United States is required to contain effective detergent additives. Use of additional detergents or other additives is not needed under normal conditions and would result in additional cost. Therefore, you should not have to add anything to the fuel.

Fuel System Cautions

CAUTION!

Follow these guidelines to maintain your vehicle's performance:

- The use of leaded gas is prohibited by Federal law. Using leaded gasoline can impair engine performance, or damage the emission control system.
- An out-of-tune engine, or certain fuel or ignition malfunctions, can cause the catalytic converter to overheat. If you notice a pungent burning odor or some light smoke, your engine may be out-of-tune or malfunctioning and may require immediate service. Contact your authorized dealer for service assistance.

- The use of fuel additives, which are now being sold as octane enhancers, is not recommended. Most of these products contain high concentrations of methanol. Fuel system damage or vehicle performance problems resulting from the use of such fuels or additives are not the responsibility of the manufacturer.

NOTE: Intentional tampering with emissions control systems can result in civil penalties being assessed against you.

Carbon Monoxide Warnings

WARNING!

Carbon monoxide (CO) in exhaust gases is deadly. Follow the precautions below to prevent carbon monoxide poisoning:

- Do not inhale exhaust gases. They contain carbon monoxide, a colorless and odorless gas, which can kill.

Never run the engine in a closed area, such as a garage, and never sit in a parked vehicle with the engine running for an extended period. If the vehicle is stopped in an open area with the engine running for more than a short period, adjust the ventilation system to force fresh, outside air into the vehicle.

- Guard against carbon monoxide with proper maintenance. Have the exhaust system inspected every time the vehicle is raised. Have any abnormal conditions repaired promptly. Until repaired, drive with all side windows fully open.
- Keep the trunk closed when driving your vehicle to prevent carbon monoxide and other poisonous exhaust gases from entering the vehicle.

ADDING FUEL

Fuel Filler Cap (Gas Cap)

The gas cap is located behind the fuel filler door above the rear tire on the passenger side of the vehicle. To access the gas cap, grasp the finger pull (on the left side of the fuel filler door) and pull it open. The door will pivot toward the front of the vehicle.

NOTE:

- When the fuel nozzle “clicks” or shuts off, the fuel tank is full.
- The fuel tank filler tube has a restricting door about 2 inches (50 mm) inside the opening. If using a portable container to add fuel, it must have a flexible nozzle long enough to force open the restricting door.

CAUTION!

- Damage to the fuel system or emission control system could result from using an improper fuel tank filler tube cap (gas cap).
- A poorly fitting gas cap could let impurities into the fuel system.
- A poorly fitting gas cap may cause the Malfunction Indicator Light to turn on.
- To avoid fuel spillage and overfilling, do not “top off” the fuel tank after filling. When the fuel nozzle “clicks” or shuts off, the fuel tank is full.

WARNING!

- Never have any smoking materials lit in or near the vehicle when the gas cap is removed or the tank filled.
- Never add fuel to the vehicle when the engine is running.
- A fire may result if gasoline is pumped into a portable container that is inside of a vehicle. You could be burned. Always place gas containers on the ground while filling.

NOTE:

- Tighten the gas cap until you hear a “clicking” sound. This is an indication that the gas cap is tightened properly. The Malfunction Indicator Light in the instrument cluster may turn on if the gas cap is not secured properly. Make sure that the gas cap is tightened each time the vehicle is refueled.

- If the gas cap is lost or damaged, be sure the replacement cap is for use with this vehicle.

TRAILER TOWING

Trailer towing with this vehicle is not recommended.

RECREATIONAL TOWING (BEHIND MOTORHOME, ETC.)**Towing This Vehicle Behind Another Vehicle (Flat towing with all four wheels on the ground)**

Recreational towing for this vehicle is not recommended.

NOTE: If the vehicle requires towing, make sure all four wheels are off the ground.

GROUND CLEARANCE

The front and rear fascias and side sills ride low and ground clearance is limited.

CAUTION!

Damage to the front and rear fascias and side sills can occur if you disregard the low ground clearance in these areas of your vehicle. Pay close attention when parking to avoid running into parking curbs. Exercise caution when entering or exiting steep driveways, or when pulling off the road onto soft shoulders.

WHAT TO DO IN EMERGENCIES

CONTENTS

■ Hazard Warning Flasher	180	□ TIREFIT Kit Components And Operation	185
■ If Your Engine Overheats	180	□ Sealing a Tire With TIREFIT	186
■ TIREFIT Kit	181	■ Jump-Starting Procedures	192
□ TIREFIT Storage	182	■ Freeing A Stuck Vehicle	195
□ TIREFIT Usage Precautions.	182	■ Towing A Disabled Vehicle	196

HAZARD WARNING FLASHER

The Hazard Warning flasher switch is on the top of the steering column, just behind the steering wheel.

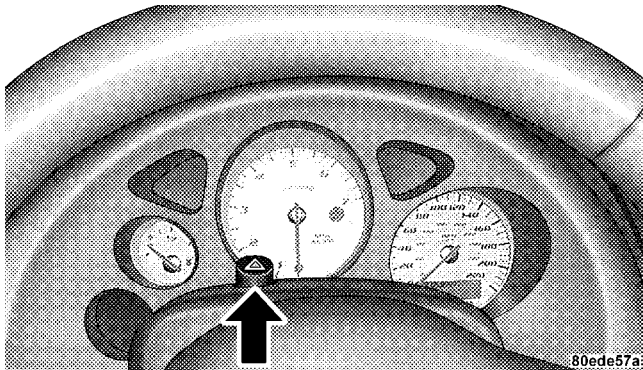

Hazard Warning Switch

Press the Hazard Warning flasher switch and all front and rear directional signals will flash. Press the switch a second time to turn the flashers off.

Do not use this emergency warning system when the vehicle is in motion. Use it when your vehicle is disabled and is creating a safety hazard for other motorists.

If it is necessary to leave the vehicle to go for service, the Hazard Warning flasher will continue to operate with the ignition key removed.

NOTE: With extended use, the Hazard Warning flasher may run down your battery.

IF YOUR ENGINE OVERHEATS

In any of the following situations, you can reduce the potential for overheating by taking the appropriate action.

- **On the highways** — Slow down and use the highest gear possible.
- **In city traffic** — While stopped, put the transmission in NEUTRAL, but do not increase engine idle speed.

- **In city traffic** — While moving, shift into the highest gear possible to reduce engine RPM.

NOTE: There are steps that you can take to slow down an impending overheat condition. If your air conditioner is on, turn it off. The air conditioning system adds heat to the cooling system and turning off the A/C removes this heat. You can also turn the temperature control to maximum heat, the mode control to floor, and the fan control to high. This allows the heater core to act as a supplement to the radiator and aids in removing heat from the cooling system.

WARNING!

A hot cooling system is dangerous. You or others could be badly burned by steam or boiling coolant. If your temperature gauge pointer is in the red area, turn off the engine immediately. You may want to call a service center for service. If you decide to look under the hood yourself, see Section 7 of this manual. Follow the warnings under the “Radiator Cap” paragraph.

TIREFIT KIT

Small punctures in the tire tread can be sealed with TIREFIT. Foreign objects (e.g., screws or nails) should not be removed from the tire. TIREFIT can be used in outside temperatures down to approximately -4°F (-20°C).

TIREFIT Storage

The TIREFIT kit is located in the trunk.

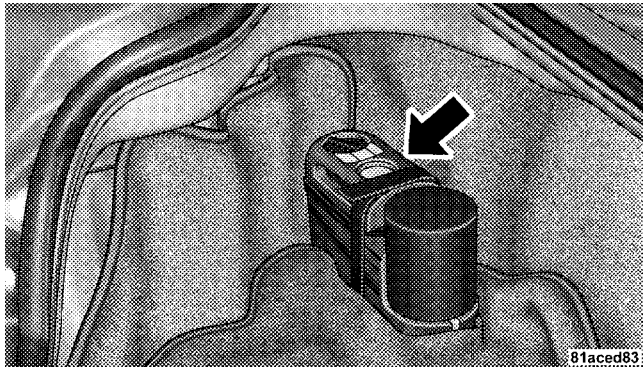

TIREFIT Location

TIREFIT Usage Precautions

NOTE:

- Replace the TIREFIT Sealant Bottle prior to the expiration date (printed on the bottle label) to assure optimum operation of the system.
- When the TIREFIT Sealant is in a liquid form, clean water, and a damp cloth will remove the material from the vehicle or tire and wheel components. Once the sealant dries, it can easily be peeled off and properly discarded.
- For optimum performance, make sure the valve stem on the wheel is free of debris before connecting the TIREFIT kit.
- You can use the TIREFIT air pump to inflate bicycle tires. The kit also comes with two needles located in the Accessory Storage Compartment 8 for inflating sport balls, rafts, or like inflatable items. However, use

only the Black Air Pump Hose 6 and make sure the Mode Select Knob 4 is in the Air Mode when inflating such items to avoid injecting sealant into them. The TIREFIT Sealant is only intended to seal small punctures in the tire tread of a tire on this vehicle.

WARNING!

- Do not attempt to seal a tire on the side of the vehicle close to traffic. Pull far enough off the road to avoid the danger of being hit when using the TIREFIT kit.
- Do not use TIREFIT or drive the vehicle under the following circumstances:
 - If the cut or puncture in the tire tread is approximately 0.24 in (6 mm) or larger.
 - If the tire has any sidewall damage.

(Continued)

WARNING! (Continued)

- If the tire has any damage from driving with extremely low tire pressure.
- If the tire has any damage from driving on a flat tire.
- If the wheel has any damage.
- If you are unsure of the condition of the tire or the wheel.
- Keep TIREFIT away from open flame or heat source.
- TIREFIT is not a permanent flat tire repair. Have the tire inspected and repaired or replaced after using TIREFIT. Do not exceed 55 mph (90 km/h) until having the tire repaired or replaced.
- A loose TIREFIT kit thrown forward in a collision or hard stop could endanger the occupants of the vehicle. Always stow the TIREFIT kit in the place provided.

(Continued)

WARNING! (Continued)

Failure to follow these warnings can result in injuries that are serious or fatal to you, your passengers, and others around you.

WARNING!

- Take care not to allow the contents of TIREFIT to come in contact with hair, eyes, or clothing. TIREFIT is harmful if inhaled, swallowed, or absorbed through the skin: It causes skin, eye, and respiratory irritation. Flush immediately with plenty of water if there is any contact with eyes or skin. Change clothing as soon as possible, if there is any contact with clothing.

(Continued)

WARNING! (Continued)

- TIREFIT Sealant solution contains latex. In case of allergic reaction or rash, consult a physician immediately. Keep TIREFIT out of reach of children. If swallowed, rinse mouth immediately with plenty of water and drink plenty of water. Do not induce vomiting! Consult a physician immediately.
- Use the gloves provided in the Accessory Storage Compartment 8 when operating the TIREFIT kit.

TIREFIT Kit Components and Operation

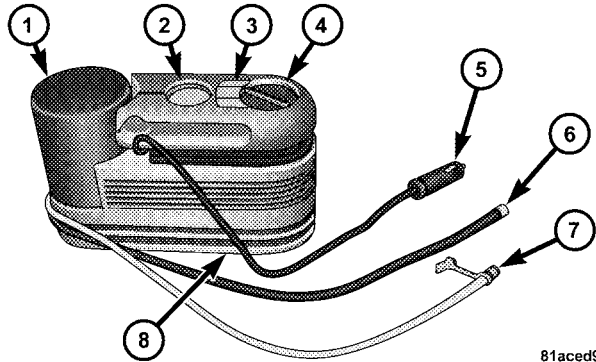

81aced9c

1. Sealant Bottle
2. Pressure Gauge
3. AIR PUMP POWER Button
4. Mode Select Knob

5. Power Plug and Cable
6. Air Pump Hose (Black)
7. Sealant Hose (Clear with Yellow Cap)
8. Accessory Storage Compartment

Using the Mode Select Knob and Hoses

Selecting Air Mode



Turn the Mode Select knob 4 to this position for air pump operation only. Use the Black Air Pump Hose 6 when selecting this mode.

6

Selecting Sealant/Air Mode



Turn the Mode Select knob 4 to this position to inject the TIREFIT Sealant and to inflate the tire. Use the Sealant Hose (Clear hose with the Yellow Cap) 7 when selecting this mode.

Using the Air Pump Power Button



Push and release the button 3 once to turn ON the TIREFIT kit. Push and release the button 3 again to turn OFF the TIREFIT kit.

Sealing a Tire with TIREFIT

A. Whenever You Stop to Use TIREFIT



1. Turn ON the vehicle's hazard warning flashers.
2. Verify that the valve stem (on the wheel with the deflated tire) is in a position that is near to the ground. This will allow the TIREFIT Hoses 6 and 7 to reach the valve stem and keep the TIREFIT kit flat on the ground. This will provide the best positioning of the kit when injecting the sealant into the deflated tire and running the air pump. Move the vehicle as necessary to place the valve stem in this position before proceeding.

3. Place the transmission in PARK (auto transmission) or in Gear (manual transmission) and turn OFF the ignition.
4. Set the parking brake.

B. Setting Up to Use TIREFIT

1. Remove the gloves from the Accessory Storage Compartment 8 and place them on your hands.



2. Turn the Mode Select knob 4 to the Sealant/Air Mode position.
3. Uncoil the Clear Sealant Hose 7 and then remove the Yellow Cap from the fitting at the end of the hose.
4. Place the TIREFIT kit flat on the ground next to the deflated tire.

5. Remove the cap from the valve stem and then screw the fitting at the end of the Sealant Hose 7 onto the valve stem.

6. Uncoil the Power Plug and Cable 5 and then insert the plug into the vehicle's power outlet.

NOTE: Do not remove foreign objects (e.g., screws or nails) from the tire.

C. Injecting TIREFIT Sealant into the Deflated Tire

1. Always start the engine before turning ON the TIREFIT kit.



2. After pressing the AIR PUMP POWER button 3, the air pump should start to inflate the tire and the sealant (white fluid) will flow from the Sealant Bottle 1 through the Sealant Hose 7 and into the tire. **NOTE:** Some sealant may leak out through the puncture in the tire.

3. If the sealant Does Not Flow Through the Clear Sealant Hose 7

- Press the AIR PUMP POWER button 3 to turn OFF the TIREFIT kit. Disconnect the Clear Sealant Hose 7 from the valve stem. Make sure the valve stem is free of debris. Reconnect the Clear Sealant Hose 7 to the valve stem. Press the AIR PUMP POWER button 3 to turn ON the TIREFIT kit.
- Turn the Mode Select knob to the Sealant/Air Mode.
- Connect the Power Plug 5 to a different power outlet in your vehicle or another vehicle, if available. Make sure the engine is running before turning ON the TIREFIT kit.
- The Sealant Bottle 1 may be empty due to previous use. Call for assistance.

D. After Injecting TIREFIT Sealant

1. Allow the air pump to inflate the tire to the pressure indicated on the tire pressure label on the driver-side latch pillar. Check the pressure in the tire by looking at the Pressure Gauge 2.

- If the tire inflates to at least 26 psi (1.8 bar) within 15 minutes, proceed to Step 2 of this procedure.
- If tire fails to inflate to 26 psi (1.8 bar) within 15 minutes, perform the procedure steps described under "G. Distributing TIREFIT Sealant to Better Enable Tire Inflation."



2. Press the AIR PUMP POWER button 3 to turn OFF the TIREFIT kit.

3. Remove the Speed Limit sticker from the top of the Sealant Bottle 1 and place the sticker on the steering wheel.

4. Disconnect the Clear Sealant Hose 7 from the valve stem, reinstall the Yellow Cap on the fitting at the end of the hose, and place the TIREFIT kit in the vehicle.

CAUTION!

Failure to reinstall the Yellow Cap on the fitting at the end of the Clear Sealant Hose 7 can result in sealant contacting your skin, clothing, and the vehicle interior. It can also result in sealant contacting internal TIREFIT kit components causing permanent damage to the kit.

E. Securing TIREFIT Sealant in the Tire

Drive the vehicle for approximately 5 mi (8 km) to ensure distribution of the TIREFIT Sealant within the tire.

WARNING!

TIREFIT is not a permanent flat tire repair. Have the tire inspected and repaired or replaced after using TIREFIT. Do not exceed 55 mph (90 km/h) until having the tire repaired or replaced. Failure to follow this warning can result in injuries that are serious or fatal to you, your passengers, and others around you.

F. After Securing TIREFIT Sealant in the Tire

1. Turn the Mode Select knob 4 to the Air Mode position.
2. Uncoil the Black Air Pump Hose 6 and connect it to the valve stem.
3. Check the pressure in the tire by reading the Pressure Gauge 2.

- If the pressure is less than 19 psi (1.3 bar), the tire is too badly damaged. Do not attempt to drive the vehicle further. Call for assistance.
- If the pressure is equal to or greater than 19 psi (1.3 bar), but less than the level indicated on the tire pressure label, proceed to Step 4 of this procedure.
- If the pressure is at the level indicated on the tire pressure label on the driver-side latch pillar, proceed to Step 5 of this procedure.

4. Inflate the tire to the pressure indicated on the tire pressure label on the driver-side latch pillar.
5. Disconnect the TIREFIT kit from the valve stem and then reinstall the cap on the valve stem.
6. Place the TIREFIT kit in its proper storage area in the vehicle.

7. Have the tire inspected and repaired or replaced at the earliest opportunity at an authorized dealer or tire service center.

8. Replace the Sealant Bottle 1 at your nearest authorized Mopar® parts dealership as soon as possible. Refer to “H. Sealant Bottle Replacement.”

G. Distributing TIREFIT Sealant to Better Enable Tire Inflation

NOTE: Use this procedure only if directed here from Step 1 of “D. After Injecting TIREFIT Sealant.”



1. Press the AIR PUMP POWER button 3 to turn OFF the TIREFIT kit. Then, disconnect the Clear Sealant Hose 7 from the valve stem, reinstall the Yellow Cap on the fitting at the end of the hose, and place the TIREFIT kit in the vehicle.

CAUTION!

Failure to reinstall the Yellow Cap on the fitting at the end of the Clear Sealant Hose 7 can result in sealant contacting your skin, clothing, and the vehicle interior. It can also result in sealant contacting internal TIREFIT kit components causing permanent damage to the kit.

2. Drive the vehicle forward approximately 30 to 50 ft (9 to 15 m) to distribute the sealant more evenly within the tire.

3. Return to Step 1 of “D. After Injecting TIREFIT Sealant” and attempt to inflate the tire. However, this time, if the tire fails to inflate to 26 psi (1.8 bar) within 15 minutes, the tire is too badly damaged. Do not attempt to drive the vehicle further. Call for assistance.

H. Sealant Bottle Replacement

1. Uncoil the Clear Sealant Hose 7.
2. Locate the rectangular SEALANT BOTTLE RELEASE button in the recessed area where you place your fingers to unlatch the hoses 6 and 7 from their storage area.
3. Use the Yellow Cap on end of the Clear Sealant Hose 7 to depress the SEALANT BOTTLE RELEASE button. The Sealant Bottle 1 will pop up. Remove the bottle and dispose of it accordingly.
4. Clean any remaining sealant from the TIREFIT housing.
5. Position the new Sealant Bottle 1 to the housing so that the Clear Sealant Hose 7 aligns with the hose slot in the front of the housing and the alignment keys on the bottom of the bottle align with the alignment slots in the housing. Then, press the bottle into the housing. An audible click will be heard, indicating the bottle is locked in place.
6. Verify the Yellow Cap is installed on the fitting at the end of the Clear Sealant Hose 7 and return the hose to its storage area.
7. Return the TIREFIT kit to its storage area in the

JUMP-STARTING PROCEDURES**WARNING!**

- Take care to avoid the radiator cooling fans whenever the hood is raised. They can start anytime the ignition switch is on. You can be hurt by the fans.
- Take care to avoid the accessory drive whenever the hood is raised. You can be hurt by the moving components.
- Do not attempt to push or tow your vehicle to get it started. Unburned fuel could enter the catalytic converter and once the engine has started, ignite and damage the converter and vehicle. If the vehicle has a discharged battery, booster cables may be used to obtain a start from a booster battery or the battery in another vehicle. This type of start can be dangerous if done improperly, so follow this procedure carefully.

(Continued)

WARNING! (Continued)

- Battery fluid is a corrosive acid solution; do not allow battery fluid to contact eyes, skin, or clothing. Don't lean over battery when attaching clamps or allow the clamps to touch each other. If acid splashes in eyes or on skin, flush contaminated area immediately with large quantities of water.
- A battery generates hydrogen gas, which is flammable and explosive. Keep flame or spark away from the vent holes.
- Do not use a booster battery or any other booster source with an output that exceeds 12-Volts.

NOTE: The battery is located underneath an access panel inside the rear compartment on the left side of the vehicle. A remote battery terminal is located in the engine compartment for jump-starting.

1. Wear eye protection and remove any metal jewelry such as watchbands or bracelets that might make an inadvertent electrical contact.
2. When boost is provided by a battery in another vehicle, park that vehicle within booster cable reach, but without allowing the vehicles touch one another.
3. Set the parking brake, place the transmission in NEUTRAL, and turn the ignition OFF on both vehicles.
4. Turn off the heater, radio, and all unnecessary electrical loads.
5. Remove the plastic cover from the remote jump-start positive post (+) in the engine compartment. Refer to the following illustration for remote jump-starting connections.

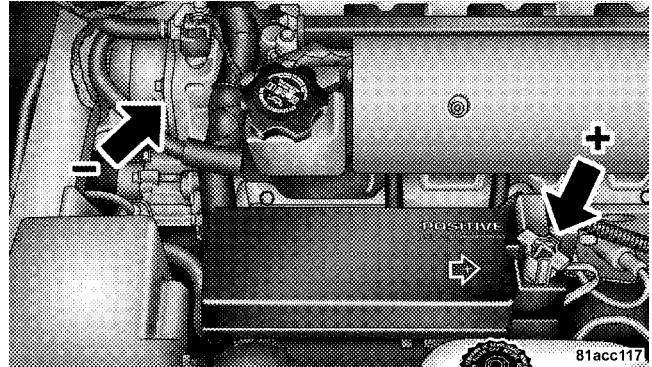

Remote Jump-Start Connections

6. **If you are jump-starting your vehicle**, connect one end of a jumper cable to the positive (+) terminal on the booster battery. Connect the other end of the same cable to the remote jump-start positive post (+).

7. If you are jump-starting another vehicle, connect one end of a jumper cable to the remote jump-start positive post (+). Connect the other end of the same cable to the positive (+) terminal of the discharged battery.

8. If you are jump-starting your vehicle, connect the other cable to the negative – terminal on the booster battery. Connect the other end of the same cable to the ear of the thermostat housing on the engine in your vehicle. Make sure you have a good contact.

9. If you are jump-starting another vehicle, connect the other cable to the ear of the thermostat housing on the engine in your vehicle. Connect the other end of the same cable to a good ground on the engine in the other vehicle. Make sure that you have a good contact.

WARNING!

- You should not try to start your vehicle by pushing or towing.
- Do not connect the cable to the negative post of the discharge battery. The resulting electrical spark could cause the battery to explode.
- During cold weather when temperatures are below freezing point, electrolyte in a discharged battery may freeze. Do not attempt jump-starting because the battery could rupture or explode. The battery temperature must be brought up above freezing point before attempting jump-start.

10. Start the engine in the vehicle that has the booster battery. Let the engine idle a few minutes.

11. Turn off the Vehicle Security Alarm System.

NOTE: The Vehicle Security Alarm System will prevent the engine from starting.

12. Start the engine in the vehicle with the discharged battery. If engine does not start in 15 seconds, stop cranking engine and allow starter to cool down before cranking again.

13. When removing the booster cables, reverse the above sequence exactly. Be careful of the moving belts and fans.

WARNING!

Any procedure other than above could result in:

- Personal injury caused by electrolyte squirting out the battery vent;
- Personal injury or property damage due to battery explosion;
- Damage to charging system of booster vehicle or of immobilized vehicle.

FREEING A STUCK VEHICLE

If your vehicle becomes stuck in mud, sand, or snow, it can often be moved by a rocking motion. Turn your steering wheel right and left to clear the area around the front wheels. Then shift back and forth between REVERSE and First gear. Usually the least accelerator pedal pressure to maintain the rocking motion without spinning the wheels is most effective.

CAUTION!

Racing the engine or spinning the wheels too fast may lead to transmission/axle overheating and failure. It can also damage the tires. Do not spin the wheels above 30 mph (48 km/h).

TOWING A DISABLED VEHICLE

Do not tow with sling type equipment. Only use flat bed equipment. Always comply with applicable state or local towing ordinances.

CAUTION!
Towing with equipment other than flat bed types may damage your vehicle.

MAINTAINING YOUR VEHICLE

CONTENTS

■ Engine Compartment — 8.4L	199	□ Engine Air Cleaner Filter	206
■ Onboard Diagnostic System (OBD II)	200	□ Maintenance-Free Battery	207
■ Emissions Inspection And Maintenance Programs	201	□ Battery Save Feature	210
■ Replacement Parts	202	□ Air Conditioner Maintenance	211
■ Dealer Service	203	□ Body Lubrication	212
■ Maintenance Procedures	203	□ Windshield Wiper Blades	213
□ Engine Oil	203	□ Adding Washer Fluid	213
□ Engine Oil Filter	206	□ Exhaust System	214
		□ Cooling System	216

□ Brake System	222	□ Auxiliary High Beam Headlight, Front Park/Turn Signal Light, Front Side Marker Light	237
□ Manual Transmission	224	□ High Intensity Discharge Headlights (HID) . .	238
□ Hydraulic Clutch	224	□ Front Fog Light	239
□ Rear Axle	226	□ Taillight, Tail/Stop Light, Rear Marker Light . .	240
□ Appearance Care And Protection From Corrosion	226	□ Taillight, Tail/Stop Light, Rear Marker Light (Coupe Models)	241
■ Fuses	230	□ Backup Light, Rear Turn Signal Light	242
□ Power Distribution Center	230	□ License Light	245
□ Mini-Power Distribution Center	233	■ Fluids And Capacities	246
■ Vehicle Storage	234	■ Fluids, Lubricants, And Genuine Parts	247
■ Replacement Bulbs	236	□ Engine	247
■ Bulb Replacement	237	□ Chassis	248

ENGINE COMPARTMENT — 8.4L

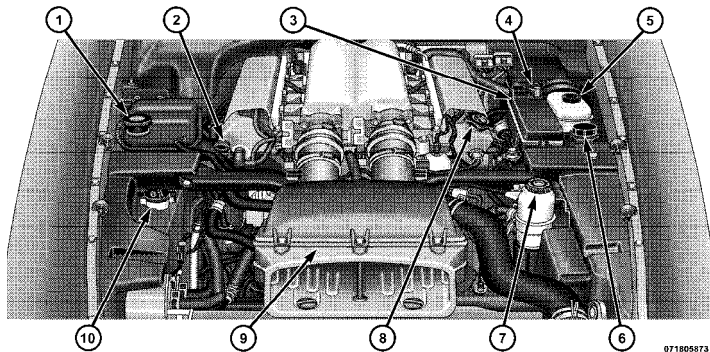

- 1 — Coolant Pressure Cap
- 2 — Engine Oil Dipstick
- 3 — Power Distribution Center
- 4 — Remote Jump Start Positive Battery Post
- 5 — Brake Fluid Reservoir

- 6 — Clutch Fluid Reservoir
- 7 — Power Steering Fluid Reservoir
- 8 — Engine Oil Fill
- 9 — Air Cleaner Filter
- 10 — Washer Fluid Reservoir

ONBOARD DIAGNOSTIC SYSTEM (OBD II)

To meet new government regulations and promote cleaner air, your vehicle is equipped with a sophisticated onboard diagnostic system called OBD II. This system monitors the performance of the emissions and engine control systems. When these systems are operating properly, your vehicle will provide excellent performance and fuel economy, as well as engine emissions well within current government regulations.

If any of these systems require service, the OBD II system will turn on the Malfunction Indicator Light. It will also store diagnostic codes and other information to assist your service technician in making repairs. Although your vehicle will usually be drivable and not need towing, see your authorized dealer for service as soon as possible.

CAUTION!

Prolonged driving with the light on could cause further damage to the emission control system. It could also affect fuel economy and driveability. The vehicle must be serviced before any state emissions tests can be performed.

If the light is flashing, severe catalytic converter damage and power loss will soon occur. Immediate service is required.

If the gas cap is not tightened properly, the light may come on. Be sure the gas cap is tightened every time you add fuel.

EMISSIONS INSPECTION AND MAINTENANCE PROGRAMS

In some localities, it may be a legal requirement to pass an inspection of your vehicle's emissions control system. Failure to pass could prevent vehicle registration.



For states that require an Inspection and Maintenance (I/M), this check verifies the Malfunction Indicator Light (MIL) is functioning and is not on when the engine is running, and that the OBD II system is ready for testing.

Normally, the OBD II system will be ready. The OBD II system may **not** be ready if your vehicle was recently serviced, recently had a dead battery or a battery replacement. If the OBD II system should be determined not ready for the I/M test, your vehicle may fail the test.

Your vehicle has a simple ignition key-actuated test, which you can use prior to going to the test station. To check if your vehicle's OBD II system is ready, you must do the following:

1. Insert your ignition key into the ignition switch.
2. Turn the ignition to the ON position, but do not crank or start the engine.
3. If you crank or start the engine, you will have to start this test over.
4. As soon as you turn your key to the ON position, you will see the MIL symbol come on as part of a normal bulb check.

5. Approximately 15 seconds later, one of two things will happen:

- a. The MIL will flash for about 10 seconds and then return to being fully illuminated until you turn OFF the ignition or start the engine. This means that your vehicle's OBD II system is **not ready** and you should **not** proceed to the I/M station.
- b. The MIL will not flash at all and will remain fully illuminated until you turn OFF the ignition or start the engine. This means that your vehicle's OBD II system is **ready** and you can proceed to the I/M station.

If your OBD II system is **not ready**, you should see your authorized dealer or repair facility. If your vehicle was recently serviced or had a battery failure or replacement, you may need to do nothing more than drive your vehicle as you normally would in order for your OBD II system to update. A recheck with the above test routine may then indicate that the system is now ready.

Regardless of whether your vehicle's OBD II system is ready or not, if the MIL is illuminated during normal vehicle operation you should have your vehicle serviced before going to the I/M station. The I/M station can fail your vehicle because the MIL is on with the engine running.

REPLACEMENT PARTS

Use of genuine MOPAR® parts for normal/scheduled maintenance and repairs is highly recommended to ensure the designed performance. Damage or failures caused by the use of non-MOPAR® parts for maintenance and repairs will not be covered by the manufacturer's warranty.

DEALER SERVICE

Your authorized dealer has the qualified service personnel, special tools, and equipment to perform all service operations in an expert manner. Service Manuals are available which include detailed service information for your vehicle. Refer to these manuals before attempting any procedure yourself.

NOTE: Intentional tampering with emissions control systems can result in civil penalties being assessed against you.

WARNING!

You can be badly injured working on or around a motor vehicle. Only do service work for which you have the knowledge and the proper equipment. If you have any doubt about your ability to perform a service job, take your vehicle to a competent mechanic.

MAINTENANCE PROCEDURES

The pages that follow contain the maintenance service recommendations by the engineers who designed your vehicle.

Besides the maintenance items for which there are fixed maintenance intervals, there are other items, which should operate satisfactorily without periodic maintenance. However, if a malfunction of these items does occur, it could adversely affect the engine or vehicle performance. These items should be inspected if a malfunction is observed or suspected.

Engine Oil

Checking Oil Level

To assure proper engine lubrication, the engine oil must be maintained at the correct level. Check the oil level at regular intervals, such as every fuel stop.

The best time to check the oil level is approximately five minutes after a fully warmed engine is turned off or before starting the engine after it has sat overnight.

Checking the oil while the vehicle is on level ground also will improve the accuracy of the oil level readings. Add oil only when the level is below the SAFE mark.

CAUTION!

Overfilling or underfilling will cause oil aeration or loss of oil pressure. This could damage your engine.

Change Engine Oil

Road conditions and your kind of driving affect the interval at which your oil should be changed. Check the following list to see if any apply to you.

- Day or night temperatures are below 32°F (0°C)
- Stop and go driving

- Extensive engine idling
- Driving in dusty conditions
- Short trip driving of less than 10 miles (16.2 km)
- More than 50% of your driving is at sustained high speeds during hot weather, above 90°F (32°C)

NOTE: If ANY of these apply to you, then change your engine oil every 3,000 miles (5 000 km) or three months, whichever comes first, and follow “Maintenance Schedule B.” Refer to Section 8 of this manual.

If none of these apply to you, then change your engine oil at every interval shown on “Maintenance Schedule A.” Refer to Section 8 of this manual.

NOTE: Under no circumstances should oil change intervals exceed 6,000 miles (10 000 km) or 6 months, whichever comes first.

Engine Oil Selection

For best performance and maximum protection under all types of operating conditions, the manufacturer only recommends full synthetic engine oils that meet the American Petroleum Institute (API) categories of SM or SM/CF, and meet the requirements of Chrysler Material Standard MS-10725.

The manufacturer recommends the use of a full synthetic engine oil, such as Mobil 1® SAE 0W-40 or equivalent.

Engine Oil Viscosity (SAE Grade)

SAE 0W-40 engine oil is preferred for use within the operating temperature shown in the engine oil viscosity chart. The proper SAE viscosity grade of engine oil should be selected based on the following recommendation and be within the operating temperature shown in the engine oil viscosity chart.

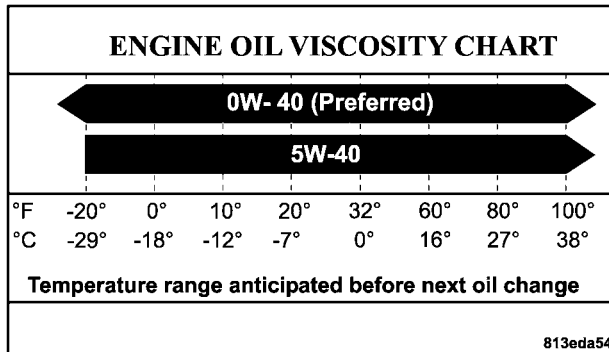

The engine oil filler cap also shows the recommended engine oil viscosity for your engine. For information on engine oil filler cap location, refer to “Engine Compartment” in this section.

Synthetic Engine Oils

You may use synthetic engine oils provided the recommended oil quality requirements are met, and the recommended maintenance intervals for oil and filter changes are followed.

Materials Added to Engine Oil

Do not add supplemental materials, other than leak detection dyes, to the engine oil. Engine oil is an engineered product and its performance may be impaired by supplemental additives.

Disposing of Used Engine Oil and Oil Filters

Care should be taken in disposing of used engine oil and oil filters from your vehicle. Used oil and oil filters, indiscriminately discarded, can present a problem to the environment. Contact your authorized dealer, service station, or governmental agency for advice on how and where used oil and oil filters can be safely discarded in your area.

Engine Oil Filter

The engine oil filter should be replaced with a new filter at every engine oil change.

Engine Oil Filter Selection

This manufacturer's engines have a full-flow type oil filter. Use a filter of this type for replacement. The quality of replacement filters varies considerably. Only high quality filters should be used to assure most efficient service. MOPAR® engine oil filters are a high quality oil filter and are recommended.

Engine Air Cleaner Filter

For normal driving conditions, inspect and replace the engine air cleaner filter at the intervals shown on "Maintenance Schedule A." For vehicles driven frequently in dusty or under severe conditions, inspect and replace the engine air cleaner filter at the intervals shown on "Maintenance Schedule B."

WARNING!

The air induction system (air cleaner, hoses, etc.) can provide a measure of protection in the case of engine backfire. Do not remove the air induction system (air cleaner, hoses, etc.) unless such removal is necessary for repair or maintenance. Make sure that no one is near the engine compartment before starting the vehicle with the air induction system (air cleaner, hoses, etc.) removed. Failure to do so can result in serious personal injury.

Engine Air Cleaner Filter Selection

The quality of replacement engine air cleaner filters varies considerably. Only high quality filters should be used to assure most efficient service. MOPAR® engine air cleaner filters are a high quality filter and are recommended.

Maintenance-Free Battery

The top of the maintenance-free battery is permanently sealed. You will never have to add water, nor is periodic maintenance required.

The battery is located underneath an access panel inside the rear compartment on the left side of the vehicle. A remote battery terminal is located in the engine compartment for jump-starting.

To gain access to the battery, remove the floor portion of the rear compartment carpet.

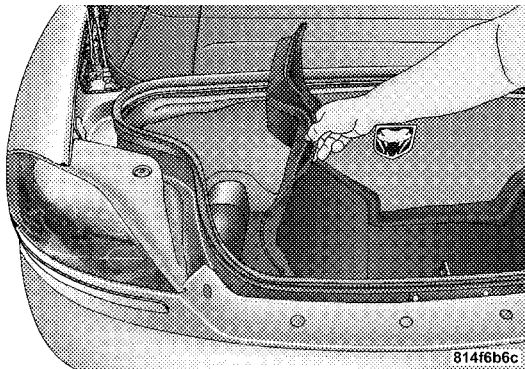

Accessing The Battery

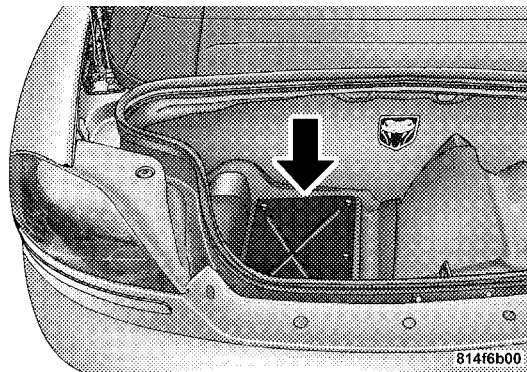

Battery Location

WARNING!

- Battery fluid is a corrosive acid solution and can burn or even blind you. Do not allow battery fluid to contact your eyes, skin, or clothing. Do not lean over a battery when attaching clamps. If acid splashes in eyes or on skin, flush the area immediately with large amounts of water.
- Battery gas is flammable and explosive. Keep flame or sparks away from the battery. Do not use a booster battery or any other booster source with an output greater than 12 Volts. Do not allow cable clamps to touch each other.
- Battery posts, terminals, and related accessories contain lead and lead compounds. Wash hands after handling.

CAUTION!

- It is essential when replacing the cables on the battery that the positive cable is attached to the positive post and the negative cable is attached to the negative post. Battery posts are marked positive (+) and negative (-) and identified on the battery case. Cable clamps should be tight on the terminal posts and free of corrosion.
- If a "fast charger" is used while battery is in vehicle, disconnect both vehicle battery cables before connecting the charger to battery. Do not use a "fast charger" to provide starting voltage.

Battery Save Feature

The Battery Save feature conserves battery power when storing the vehicle. It allows for up to three months of storage time without losing radio and engine controller memory. Using this feature is an alternative to disconnecting the battery.

NOTE: This vehicle is designed to sit in storage with a fully charged battery for up to 30 days. If you plan to store the vehicle longer than 30 days, we recommend doing one of the following:

- Disconnect the battery.
- Use the battery charger.
- Put the vehicle into Battery Save mode (3-month charge).

To Activate the Battery Save Feature

1. Insert the key into the ignition switch.

2. Cycle the ignition switch from OFF/LOCK to ACC four times. Leave the switch in the OFF/LOCK position after the fourth cycle.

3. Push the driver's POWER DOOR LOCK switch in the UP direction. A single chime will sound and the horn will chirp to indicate that the process has begun.

4. Remove the key from the ignition switch and exit the vehicle. The Battery Save Feature will be enabled 45 seconds after all doors are closed.

NOTE:

- Turning the ignition switch to the ON/RUN position at any time will cancel activation of the Battery Save Feature.
- The Remote Keyless Entry (RKE) and the exterior passenger door handle will not work when the Battery Save feature is enabled. Enter the vehicle by using the key to unlock the door manually and by using the exterior driver door handle to open the door.

- The Vehicle Security Alarm is disabled when the Battery Save Feature is enabled. Therefore, the vehicle is not protected when the Battery Save Feature is enabled.
- The exterior and interior lighting functions will not work when the Battery Save Feature is enabled.

To Deactivate the Battery Save Feature

1. Press the exterior driver's door handle once to wake up the vehicle. Then, press the handle again to open the door.

NOTE: If the door does not open (vehicle is armed), press the RKE UNLOCK button to unlock the vehicle.

2. Insert the key into the ignition switch.
3. Turn the ignition switch to the ON/RUN position. The Battery Save Feature will turn off.

NOTE: If the ignition switch is NOT turned to ON/RUN position, the Battery Save Feature will be enabled 45 seconds after the driver's door is closed.

Air Conditioner Maintenance

For best possible performance, your air conditioner should be checked and serviced by an authorized dealer at the start of each warm season. This service should include cleaning of the condenser fins and a performance test. Drive belt tension should also be checked at this time.

NOTE: If A/C performance seems less than normal, check the front of the A/C condenser (located in front of the radiator) for dirt and insect accumulation. Clean with a gentle water spray as required. Front end fascia protectors may reduce air flow to the condenser and radiator, reducing A/C and engine cooling performance.

WARNING!

- Use only refrigerants and compressor lubricants approved by the manufacturer for your air conditioning system. Some unapproved refrigerants are flammable and can explode, injuring you. Other unapproved refrigerants or lubricants can cause the system to fail, requiring costly repairs. Refer to Section 3 of the Warranty Information book for further warranty information.
- The air conditioning system contains refrigerant under high pressure. To avoid risk of personal injury or damage to the system, adding refrigerant or any repair requiring lines to be disconnected should be done by an experienced technician.

Refrigerant Recovery and Recycling

R-134a Air Conditioning Refrigerant is a hydrofluorocarbon (HFC) that is endorsed by the Environmental

Protection Agency and is an ozone-saving product. However, the manufacturer recommends that air conditioning service be performed by authorized dealers or other service facilities using recovery and recycling equipment.

NOTE: Use only manufacturer approved A/C System Sealers, Stop Leak Products, Seal Conditioners, Compressor Oil, and Refrigerants.

Body Lubrication

Locks and all body pivot points, including such items as seat tracks, door hinge pivot points and rollers, liftgate, tailgate, sliding doors and hood hinges, should be lubricated periodically with a lithium based grease such as MOPAR® Spray White Lube to assure quiet, easy operation and to protect against rust and wear. Prior to the application of any lubricant, the parts concerned should be wiped clean to remove dust and grit; after lubricating excess oil and grease should be removed. Particular

attention should also be given to hood latching components to insure proper function. When performing other underhood services, the hood latch, release mechanism and safety catch should be cleaned and lubricated.

The external lock cylinders should be lubricated twice a year, preferably in the Fall and Spring. Apply a small amount of a high quality lubricant such as MOPAR® Lock Cylinder Lubricant directly into the lock cylinder.

Windshield Wiper Blades

Clean the rubber edges of the wiper blades and the windshield periodically with a sponge or soft cloth and a mild nonabrasive cleaner. This will remove accumulations of salt or road film.

Operation of the wipers on dry glass for long periods may cause deterioration of the wiper blades. Always use washer fluid when using the wipers to remove salt or dirt from a dry windshield.

Avoid using the wiper blades to remove frost or ice from the windshield. Keep the blade rubber out of contact with petroleum products such as engine oil, gasoline, etc.

Adding Washer Fluid

The windshield washer fluid reservoir is located in the front of the engine compartment on the passenger side of the vehicle. Be sure to check the fluid level in the reservoir at regular intervals. Fill the reservoir with windshield washer solvent (not engine coolant (anti-freeze) and operate the system for a few seconds to flush out the residual water.

WARNING!

Commercially available windshield washer solvents are flammable. They could ignite and burn you. Care must be exercised when filling or working around the washer solution.

7

Exhaust System

The best protection against carbon monoxide entry into the vehicle body is a properly maintained engine exhaust system.

If you notice a change in the sound of the exhaust system; or if exhaust fumes can be detected inside the vehicle; or when the underside or side of the vehicle is damaged; have a competent technician inspect the complete exhaust system and adjacent body areas for broken, damaged, deteriorated, or mispositioned parts. Open seams or loose connections could permit exhaust fumes to seep into the passenger compartment. In addition, inspect the exhaust system each time the vehicle is raised for lubrication or oil change. Replace as required.

WARNING!

Exhaust gases can injure or kill. They contain carbon monoxide (CO) which is colorless and odorless. Breathing it can make you unconscious and can eventually poison you. To avoid breathing CO, refer to "Exhaust Gas" in the "Safety Tips" section of this manual.

The catalytic converter requires the use of unleaded fuel only. Leaded gasoline will destroy the effectiveness of the catalyst as an emission control device.

Under normal operating conditions, the catalytic converter will not require maintenance. However, it is important to keep the engine properly tuned to assure proper catalyst operation and prevent possible catalyst damage.

CAUTION!

Damage to the catalytic converter can result if your vehicle is not kept in proper operating condition. Have your vehicle serviced promptly in the event of engine malfunction, particularly when involving engine misfire or other apparent loss of performance. Continued operation of your vehicle with a severe malfunction could cause the converter to overheat, resulting in possible damage to the converter and the vehicle.

NOTE: Intentional tampering with emissions control systems can result in civil penalties being assessed against you.

WARNING!

A hot exhaust system can start a fire if you park over materials that can burn. Such materials might be grass or leaves coming in contact with your exhaust system. Do not park or operate your vehicle in areas where your exhaust system can contact anything that can burn.

In unusual situations involving grossly malfunctioning engine operation, a scorching odor may indicate severe and abnormal catalyst overheating. If this should occur, safely bring the vehicle to a complete stop, shut the engine off, and allow the vehicle to cool. Thereafter, obtain service, including a tune-up to manufacturer's specifications immediately.

To minimize the possibility of catalytic converter damage:

- Do not shut off the engine or interrupt the ignition when the transmission is in gear and the vehicle is in motion.
- Do not try to start the engine by pushing or towing the vehicle.
- Do not idle the engine with any spark plug wires disconnected or removed, such as when diagnostic testing, or for prolonged periods during very rough idling or malfunctioning operating conditions.

Cooling System

WARNING!

- **When working near the radiator cooling fans, disconnect each fan motor lead or turn the ignition switch to the OFF position. The fans are temperature controlled and can start any time the ignition switch is in the ON position.**
- **You or others could be badly burned by hot engine coolant (antifreeze) or steam from your radiator. If you see or hear steam coming from under the hood, do not open the hood until the radiator has had time to cool. Never try to open a cooling system pressure cap when the radiator is hot.**

Coolant Checks

Check engine coolant (antifreeze) protection every 12 months (before the onset of freezing weather, where applicable). If the engine coolant (antifreeze) is dirty or rusty in appearance, the system should be drained, flushed, and refilled with fresh engine coolant (antifreeze). Check the front of the A/C condenser/radiator for any accumulation of bugs, leaves, etc. If dirty, clean by gently spraying water from a garden hose vertically down the face of the condenser/radiator.

Check the coolant recovery bottle tubing for brittle rubber, cracking, tears, cuts, and tightness of the connection at the bottle and radiator. Inspect the entire system for leaks.

With the engine at normal operating temperature (but not running), check the cooling system pressure cap for proper vacuum sealing by draining a small amount of engine coolant (antifreeze) from the radiator drain cock.

If the cap is sealing properly, the engine coolant (antifreeze) will begin to drain from the coolant recovery bottle. **DO NOT REMOVE THE COOLANT PRESSURE CAP WHEN THE COOLING SYSTEM IS HOT.**

Cooling System — Drain, Flush, and Refill

If the engine coolant (antifreeze) is dirty or contains a considerable amount of sediment, clean and flush with a reliable cooling system cleaner. Follow with a thorough rinsing to remove all deposits and chemicals. Properly dispose of the old engine coolant (antifreeze).

Refer to the “Maintenance Schedules” in Section 8 for the proper maintenance intervals.

Selection of Coolant

Use only the manufacturer’s recommended engine coolant (antifreeze). Refer to “Fluids, Lubricants, and Genuine Parts” in this section for the correct fluid type.

CAUTION!

- Mixing of engine coolant (antifreeze) other than specified HOAT engine coolant (antifreeze), may result in engine damage and may decrease corrosion protection. If a non-HOAT engine coolant (antifreeze) is introduced into the cooling system in an emergency, it should be replaced with the specified engine coolant (antifreeze) as soon as possible.
- Do not use water alone or alcohol-based engine coolant (antifreeze) products. Do not use additional rust inhibitors or antirust products, as they may not be compatible with the radiator engine coolant (antifreeze) and may plug the radiator.

(Continued)

CAUTION! (Continued)

- This vehicle has not been designed for use with Propylene Glycol based engine coolant (antifreeze). Use of Propylene Glycol based engine coolant (antifreeze) is not recommended.

Adding Coolant

Your vehicle has been built with an improved engine coolant (antifreeze) that allows extended maintenance intervals. This engine coolant (antifreeze) can be used up to five years or 100,000 miles (160 000 km) before replacement. To prevent reducing this extended maintenance period, it is important that you use the same engine coolant (antifreeze) throughout the life of your vehicle. Please review these recommendations for using Hybrid Organic Additive Technology (HOAT) engine coolant (antifreeze).

When adding engine coolant (antifreeze):

- The manufacturer recommends using MOPAR® Antifreeze/Coolant 5 Year/100,000 Mile Formula HOAT (Hybrid Organic Additive Technology).
- Mix a minimum solution of 50% HOAT engine coolant (antifreeze) and distilled water. Use higher concentrations (not to exceed 70%) if temperatures below -34°F (-37°C) are anticipated.
- Use only high purity water such as distilled or deionized water when mixing the water/engine coolant (antifreeze) solution. The use of lower quality water will reduce the amount of corrosion protection in the engine cooling system.

Please note that it is the owner's responsibility to maintain the proper level of protection against freezing according to the temperatures occurring in the area where the vehicle is operated.

NOTE: Mixing engine coolant (antifreeze) types will decrease the life of the engine coolant (antifreeze) and will require more frequent engine coolant (antifreeze) changes.

Cooling System Pressure Cap

The cap must be fully tightened to prevent loss of engine coolant (antifreeze), and to insure that engine coolant (antifreeze) will return to the radiator from the coolant recovery bottle.

The cap should be inspected and cleaned if there is any accumulation of foreign material on the sealing surfaces.

WARNING!

- The warning words “DO NOT OPEN HOT” on the cooling system pressure cap are a safety precaution. Never add engine coolant (antifreeze) when the engine is overheated. Do not loosen or remove the cap to cool an overheated engine. Heat causes pressure to build up in the cooling system. To prevent scalding or injury, do not remove the pressure cap while the system is hot or under pressure.
- Do not use a pressure cap other than the one specified for your vehicle. Personal injury or engine damage may result.

Disposal of Used Coolant

Used ethylene glycol based engine coolant (antifreeze) is a regulated substance requiring proper disposal. Check with your local authorities to determine the disposal

rules for your community. To prevent ingestion by animals or children, do not store ethylene glycol based engine coolant (antifreeze) in open containers or allow it to remain in puddles on the ground. If ingested by a child, contact a physician immediately. Clean up any ground spills immediately.

Coolant Level

The coolant bottle provides a quick visual method for determining that the engine coolant (antifreeze) level is adequate. With the engine idling, and warm to normal operating temperature, the level of the engine coolant (antifreeze) in the bottle should be between the ranges indicated on the bottle.

The radiator normally remains completely full, so there is no need to remove the radiator cap unless checking for engine coolant (antifreeze) freeze point or replacing engine coolant (antifreeze). Advise your service attendant

of this. As long as the engine operating temperature is satisfactory, the coolant bottle need only be checked once a month.

When additional engine coolant (antifreeze) is needed to maintain the proper level, it should be added to the coolant bottle. Do not overfill.

Points to Remember

NOTE: When the vehicle is stopped after a few miles (kilometers) of operation, you may observe vapor coming from the front of the engine compartment. This is normally a result of moisture from rain, snow, or high humidity accumulating on the radiator and being vaporized when the thermostat opens, allowing hot engine coolant (antifreeze) to enter the radiator.

If an examination of your engine compartment shows no evidence of radiator or hose leaks, the vehicle may be safely driven. The vapor will soon dissipate.

- Do not overfill the coolant recovery bottle.
- Check engine coolant (antifreeze) freeze point in the coolant bottle. If engine coolant (antifreeze) needs to be added, contents of the coolant bottle also must be protected against freezing.
- If frequent engine coolant (antifreeze) additions are required, or if the level in the coolant recovery bottle does not drop when the engine cools, the cooling system should be pressure tested for leaks.
- Maintain engine coolant (antifreeze) concentration at 50% HOAT engine coolant (antifreeze) (minimum) and distilled water for proper corrosion protection of your engine, which contains aluminum components.
- Make sure that the radiator and coolant recovery bottle overflow hoses are not kinked or obstructed.

- Keep the front of the radiator clean. If your vehicle is equipped with air conditioning, keep the front of the condenser clean.
- Do not change the thermostat for Summer or Winter operation. If replacement is ever necessary, install ONLY the correct type thermostat. Other designs may result in unsatisfactory cooling performance, poor gas mileage, and increased emissions.

Brake System

In order to assure brake system performance, all brake system components should be inspected periodically. Refer to the "Maintenance Schedules" in Section 8 of this manual for the proper maintenance intervals.

WARNING!

Riding the brakes can lead to brake failure and possibly an accident. Driving with your foot resting or riding on the brake pedal can result in abnormally high brake temperatures, excessive lining wear, and possible brake damage. You would not have your full braking capacity in an emergency.

Master Cylinder - Brake Fluid Level Check

Check the fluid level in the master cylinder immediately if the brake system warning light indicates system failure.

Check the fluid level in the master cylinder when performing underhood services.

Clean the top of the master cylinder area before removing the cap. If necessary, add fluid to bring the fluid level up to the requirements described on the brake fluid reservoir.

Overfilling of fluid is not recommended because it may cause leaking in the system.

With disc brakes, fluid level can be expected to fall as the brake pads wear. However, low fluid level may be caused by a leak and a checkup may be needed.

Use only the manufacturer's recommended brake fluid. Refer to "Fluids, Lubricants, and Genuine Parts" in this section for the correct fluid type. Use of a brake fluid that may have a lower initial boiling point or unidentified as to specification, may result in sudden brake failure during hard prolonged braking.

WARNING!

Overfilling the brake fluid reservoir can result in spilling brake fluid on hot engine parts and the brake fluid catching fire.

Use only brake fluid that has been in a tightly closed container to avoid contamination from foreign matter.

CAUTION!

- **Do not allow petroleum base fluid to contaminate the brake fluid, all brake seal components could be damaged causing partial or complete brake failure.**
- **Brake fluid can damage the finish of your vehicle. Do not allow brake fluid to contact any painted surface.**

Change Brake Fluid

Brake fluid will tend to absorb moisture from the atmosphere over time. If the fluid becomes contaminated with water, brake performance will deteriorate. Therefore, the brake fluid must be changed at the intervals specified in "Maintenance Schedules" in Section 8 of this manual. See your authorized dealer for service.

Manual Transmission

Transmission Fluid Level Check

Check the fluid in the transmission when performing other underhood services.

Check the fluid level by removing the fill plug located on the left side of the transmission. The fluid level should be at the bottom of the fill hole. Add fluid, if necessary, to maintain the proper level. Refer to "Fluids, Lubricants, and Genuine Parts" in this section for the correct fluid type.

CAUTION!

Using a transmission fluid other than the manufacturer's recommended fluid may cause deterioration in transmission shift quality and/or damage to the transmission. Refer to "Fluids, Lubricants, and Genuine Parts" in this section for the correct fluid type.

Change Transmission Fluid

Change the fluid at the intervals specified in "Maintenance Schedules" in Section 8 of this manual. If contaminated with water, change the fluid immediately. See your authorized dealer for service.

Hydraulic Clutch

Master Cylinder — Clutch Fluid Level Check

Check the fluid in the clutch master cylinder when performing underhood services.

Clean the top of the master cylinder area before removing the cap. If necessary, add fluid to the reservoir.

Do Not Overfill. Overfilling can cause clutch release problems as the clutch wears. A low fluid level may indicate a leak, in which case, hydraulic clutch linkage replacement may be required. The fluid level in the reservoir will rise as the clutch wears - do not remove fluid.

Use only the manufacturer's recommended clutch fluid. Refer to "Fluids, Lubricants, and Genuine Parts" in this section for the correct fluid type.

WARNING!

Overfilling the clutch fluid reservoir can result in spilling clutch fluid on hot engine parts and the clutch fluid catching fire.

Use only clutch fluid that has been in a tightly closed container to avoid contamination from foreign matter.

CAUTION!

- **Do not allow petroleum base fluid to contaminate the clutch fluid, all clutch seal components could be damaged causing partial or complete clutch failure.**
- **Clutch fluid can damage the finish of your vehicle. Do not allow clutch fluid to contact any painted surface.**

Change Clutch Fluid

Clutch fluid will tend to absorb moisture from the atmosphere over time. If the fluid becomes contaminated with water, clutch performance will deteriorate. Therefore, the clutch fluid must be changed at the intervals specified in "Maintenance Schedules" in Section 8 of this manual. See your authorized dealer for service.

Rear Axle

Axle Lubricant Level Check

Check the exterior of the axle for evidence of gear oil leakage every 12 months or 6,000 miles (10 000 km). This check should be made with the vehicle level and supported by the suspension, with the vehicle on the ground or raised on an axle and wheel type hoist. The axle lubricant level should be between the bottom of the filler plug and a point approximately 3/8 in (9.5 mm) below the filler plug. If adding axle lubricant, use only the manufacturer's recommended axle lubricant. Refer to the "Fluids, Lubricants, and Genuine Parts" in this section for the correct fluid type.

NOTE: The Limited Slip Differential requires that a friction control additive be added when draining and refilling the axle lubricant.

Change Axle Lubricant

Drain and fill the axle at the intervals specified in "Maintenance Schedules" in Section 8 of this manual. Change the lubricant immediately if contaminated with water. See your authorized dealer for service.

Appearance Care And Protection From Corrosion

Protection of Body and Paint from Corrosion

Vehicle body care requirements vary according to geographic locations and usage. Chemicals that make roads passable in snow and ice, and those that are sprayed on trees and road surfaces during other seasons, are highly corrosive to the metal in your vehicle.

The following maintenance recommendations will enable you to obtain maximum benefit from the corrosion resistance built into your vehicle.

Washing

- Wash your vehicle regularly. Always wash your vehicle in the shade using MOPAR® Car Wash or a mild car wash soap, and rinse the panels completely with clear water.
- If insects, tar, or other similar deposits have accumulated on your vehicle, use MOPAR® Super Kleen Bug and Tar Remover to remove.
- Use MOPAR® Cleaner Wax to remove road film, stains, and to protect your paint finish. Take care never to scratch the paint.
- Avoid using abrasive compounds and power buffing that may diminish the gloss or thin out the paint finish.

CAUTION!

- Use of power washers exceeding 1,200 psi (8 274 kPa) can result in damage or removal of paint and decals.

Wheel and Wheel Trim Care

All wheels and wheel trim, especially aluminum and chrome-plated wheels should be cleaned regularly with a mild soap and water to prevent corrosion. To remove heavy soil, use MOPAR® Wheel Cleaner or select a nonabrasive, non-acidic cleaner. Do not use scouring pads, steel wool, a bristle brush or metal polishes. Only MOPAR® cleaners are recommended. Do not use oven cleaner. Avoid automatic car washes that use acidic solutions or harsh brushes that may damage the wheels' protective finish.

Convertible Top Care — Convertible Models Only

Use a mild detergent to clean the top. Avoid heavy scrubbing and rinse with plenty of clean water. Allow to dry thoroughly before storage.

Interior Care

Use MOPAR® Total Clean to clean fabric upholstery and carpeting.

Interior Trim should be cleaned starting with a damp cloth, a damp cloth with MOPAR® Total Clean, then MOPAR® Spot & Stain Remover, if absolutely necessary. Do not use harsh cleaners or Armorall. Use MOPAR® Total Clean to clean vinyl upholstery.

Leather or Vinyl Seat/Trim Care and Cleaning

Leather is best preserved by regular cleaning with a damp soft cloth. Small particles of dirt can act as an abrasive and damage the leather surface and should be removed immediately with a damp cloth. Stubborn soils can be removed easily with a soft cloth and MOPAR®

Total Clean or equivalent. Care should be taken to avoid soaking the leather with any liquid. Please do not use polishes, oils, cleaning fluids, solvents, detergents, or ammonia-based cleaners to clean the leather. Application of a leather conditioner is not required to maintain the original condition.

Glass Surfaces

All glass surfaces should be cleaned on a regular basis with MOPAR® Glass Cleaner or any commercial household-type glass cleaner. Never use an abrasive type cleaner. Use caution when cleaning inside rear windows equipped with electric defrosters. Do not use scrapers or other sharp instruments which may scratch the elements.

When cleaning the rearview mirror, spray cleaner on the towel or rag that you are using. Do not spray cleaner directly on the mirror.

Cleaning Plastic Instrument Cluster Lenses

The lenses in front of the instruments in this vehicle are molded in clear plastic. When cleaning the lenses, care must be taken to avoid scratching the plastic.

1. Clean with a wet soft rag. A mild soap solution may be used, but do not use high alcohol content or abrasive cleaners. If soap is used, wipe clean with a clean damp rag.
2. Dry with a soft tissue.

Seat Belt Maintenance

Do not bleach, dye or clean the belts with chemical solvents or abrasive cleaners. This will weaken the fabric. Sun damage will also weaken the fabric.

If the belts need cleaning, use MOPAR® Total Clean, a mild soap solution, or lukewarm water. Do not remove the belts from the vehicle to wash them.

Replace the belts if they appear frayed or worn or if the buckles do not work properly.

Dry with a soft tissue.

FUSES

Power Distribution Center

The Power Distribution Center is located in the engine compartment on the driver's side of the vehicle. This center contains fuses and relays.

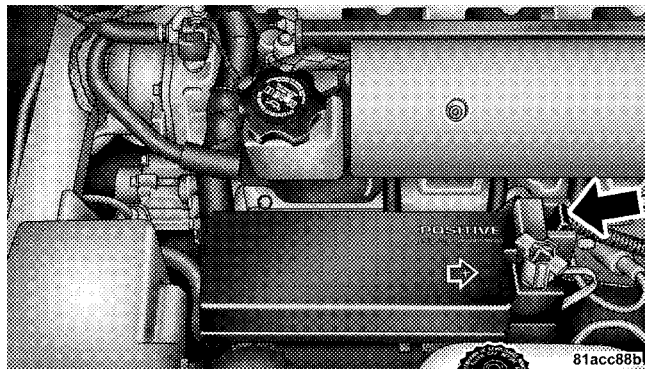

Power Distribution Center

Cavity	Cartridge Fuse	Mini-Fuse	Description
1	40 Amp Green	—	Blower Motor
2	40 Amp Green	—	Anti-Lock Brakes (ABS) Pump Feed/Starter
3	30 Amp Pink	—	Body Control Module (BCM) - Battery Feed
4	20 Amp Blue	—	Amplifier
5	30 Amp Pink	—	Ignition Switch Run/ Accessory Feed - Windows
6	40 Amp Green	—	Body Control Module (BCM) - Battery Feed
7	30 Amp Pink	—	Anti-Lock Brakes (ABS) Module
8	30 Amp Pink	—	Ignition Switch Run/ Accessory Feed

Cavity	Cartridge Fuse	Mini-Fuse	Description
9	40 Amp Green	—	Headlights
10	30 Amp Pink	—	Ignition Switch Run Feed
11	—	20 Amp Yellow	Auto Shutdown Relay (ASD)
12	—	20 Amp Yellow	Cigar Lighter
13	—	15 Amp Blue	Hazard Flasher
14	—	20 Amp Yellow	Auto Shutdown Relay (ASD)
15	—	20 Amp Yellow	Rear Window Defogger (EBL)
16, 17	—	20 Amp Yellow	Selectable Power Outlet

Cavity	Cartridge Fuse	Mini-Fuse	Description
18	—	15 Amp Blue	Ignition Off Draw (IOD)
19	—	15 Amp Blue	Horn
20	—	15 Amp Blue	Air Conditioning (A/C) Clutch Relay
21	—	15 Amp Blue	STOP LIGHT Switch
22	—	25 Amp Clear	Fuel Pump/Powertrain Control Module (PCM)
23, 24	—	10 Amp Red	Airbag
60, 61	—	15 Amp Blue	Ignition Run/Start Relay Feed
62, 63	—	15 Amp Blue	Gauges

Cavity	Cartridge Fuse	Mini-Fuse	Description
64, 65	—	10 Amp Red	Airbag
66, 67	—	20 Amp Yellow	WIPER Switch
68, 69	—	20 Amp Yellow	Left HID Headlight
70, 71	—	20 Amp Yellow	Right HID Headlight

CAUTION!

- When installing the Power Distribution Center cover, it is important to ensure the cover is properly positioned and fully latched. Failure to do so may allow water to get into the Power Distribution Center, and possibly result in an electrical system failure.
- When replacing a blown fuse, it is important to use only a fuse having the correct amperage rating. The use of a fuse with a rating other than indicated may result in a dangerous electrical system overload. If a properly rated fuse continues to blow, it indicates a problem in the circuit that must be corrected.

Mini-Power Distribution Center

The Mini-Power Distribution Center is located in the engine compartment on the passenger's side of the vehicle. This center contains radiator fan control relays and has two externally-mounted 40 Amp fuses for the radiator fans.

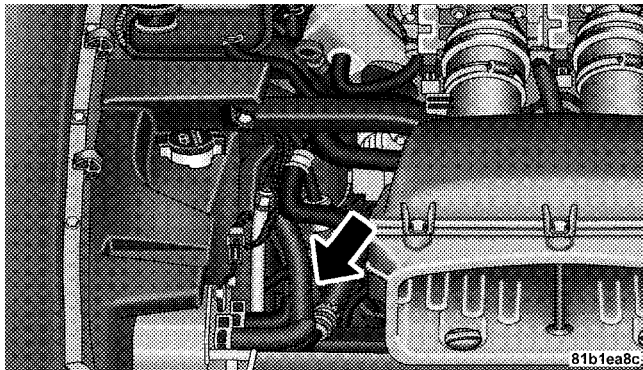

Mini-Power Distribution Center

CAUTION!

- When installing the Mini-Power Distribution Center cover, it is important to ensure the cover is properly positioned and fully latched. Failure to do so may allow water to get into the Power Distribution Center, and possibly result in an electrical system failure.
- When replacing a blown fuse, it is important to use only a fuse having the correct amperage rating. The use of a fuse with a rating other than indicated may result in a dangerous electrical system overload. If a properly rated fuse continues to blow, it indicates a problem in the circuit that must be corrected.

VEHICLE STORAGE

We recommend that you follow these guidelines for storing your vehicle for extended periods.

- Fill the fuel tank. This will prevent water condensation inside the tank. If you plan to store your vehicle more than two months, add an anti-oxidant fuel stabilizer to the fuel tank.
- Change the oil to remove any corrosive combustion related acids in the crankcase.
- Check that the radiator coolant level of protection is to at least -20°F (-29°C).
- Make sure that all tires are inflated to the optimum pressure.
- Wash and wax the vehicle to protect the finish.
- Store the vehicle in a dry, well-ventilated location.
- Move the wiper blades away from the windshield.
- Block the wheels. Do not apply the parking brake.
- Cut blocks of plywood about the same size of the tires. Cover each block with indoor/outdoor carpeting and place them between the tires and concrete. This will prevent tire flat spotting.
- For long-term storage, remove the tires and put the vehicle up on blocks. Stack the tires on plywood and cover with a tarp to prevent flat spotting.
- If the vehicle will be subjected to freezing temperatures, either remove the battery and store it in a dry, well ventilated area or connect a trickle charger (1.5 Amp) with automatic shutdown / overcharge protection to the battery. However, do not leave the trickle charger hooked up to the battery without being plugged in to a 110 Volt AC outlet, as this will result in further drain on the vehicle's battery. If the vehicle is not going to be driven in the next three weeks, perform the battery recharge procedure in the Service Manual.

Then, either disconnect the battery at the negative terminal or use the "Battery Save Feature" to conserve battery power. Refer to "Battery Save Feature" under "Maintenance Procedures" in this section for details.

NOTE: Disconnecting the battery causes the engine control system to lose memory of some "learned" functions. After reconnecting the battery, the engine may run rough until the control module "relearns" these functions. Using the Battery Save Feature will prevent the engine controller from losing its memory.

CAUTION!

Use care when disconnecting the remote positive cable. It is connected to the battery and can short out to any metal on the vehicle. Always tape or wrap the exposed cable end to prevent electrical shorts.

Check the battery every four to six weeks to ensure that the voltage is above 12.40 Volts. The voltage will drop more rapidly in hot temperatures. If battery voltage drops below 12.40 Volts, follow the battery recharge procedure in the Service Manual.

NOTE: To help prevent the battery from discharging during shorter periods of inactivity, perform the following:

1. Make sure that the trunk/liftgate, hood, doors, windows, and convertible top are completely closed.
2. Make sure that Remote Keyless Entry (RKE) transmitter is operating and that the battery is good.
3. Make sure that the HOOD, TRUNK/LIFTGATE, and DOOR switches are in adjustment. Perform the quick system check, which follows:

Use the remote transmitter to set the alarm. If the alarm SET light comes on and flashes, the system is operating

properly. If not, there is a problem with a switch or the system. See your authorized dealer for service.

- Cover the vehicle whenever possible to prevent accidental damage to the finish.

REPLACEMENT BULBS

LIGHT BULBS — Interior	Bulb Number
Message Center Indicators	103
Cluster	103
Gauge Pack	103
Heater Control	37
Interior Light	212-2
Courtesy Foot Well Lights	194
Cargo Light (Coupe Liftgate)	168

LIGHT BULBS — Exterior (Convertible Models)

Bulb Number

Low/High Beam High Intensity Discharge (HID) Headlight	Serviced at authorized dealer only
Auxiliary High Beam Headlight	(HB3A) 9005XS
Front Park/Turn Signal Light	3157AK
Fog Light	(H10 U) 9145
Front Side Marker Light	2886X
Center High Mounted Stop Light (CHMSL)	16 LED (not serviceable)
Tail/Stop Light	3157
Taillight	194
Rear Marker Light	194
Backup Light	3157
Rear Turn Signal Light	3457AK
License Light	168

LIGHT BULBS — Exterior (Coupe Models)

	Bulb Number
Low/High Beam High Intensity Discharge (HID) Headlight	Serviced at authorized dealer only
Auxiliary High Beam Headlight	(HB3A) 9005XS
Front Park/Turn Signal Light	3157AK
Fog Light	(H10 U) 9145
Front Side Marker Light	2886X
Center High Mounted Stop Light (CHMSL)	16 LED (not serviceable)
Tail/Stop/Turn Signal Light	3157
Rear Marker Light	194
Backup Light	3157
License Light	168

NOTE: Upon turning the High Intensity Discharge (HID) Headlights on, there is a blue hue to the lamps. This diminishes and becomes more white after approximately 10 seconds as the system charges.

BULB REPLACEMENT

Auxiliary High Beam Headlight, Front Park/Turn Signal Light, Front Side Marker Light

1. Remove the push pin from the upper outer corner of the splash shield and remove the splash shield.

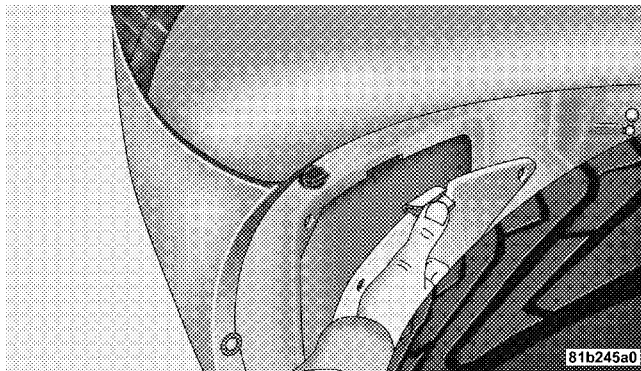

2. Turn the appropriate bulb and socket assembly counterclockwise, and then pull it out of the headlight assembly.

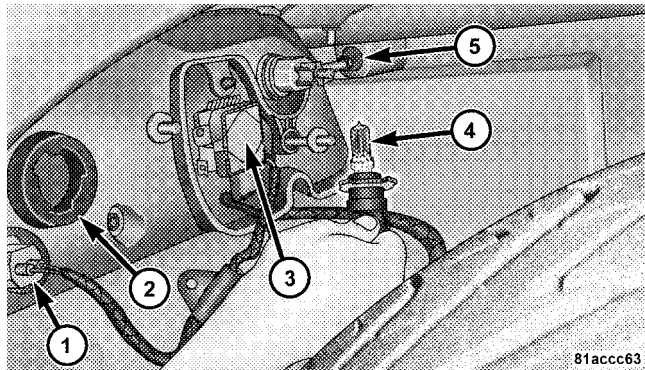

- 1 — Front Side Marker Light
- 2 — Front Park/Turn Signal Light
- 3 — Low/High Beam HID Headlight
- 4 — Auxiliary High Beam Headlight
- 5 — Headlight Adjustment — Aim Up and Down

3. Pull the bulb out of the socket assembly.

4. Push the replacement bulb into the socket assembly.

5. Reinstall the bulb and socket assembly into the headlight assembly, and then turn it clockwise.

6. Install the splash shield and push pin.

High Intensity Discharge Headlights (HID)

The headlights are a type of high voltage discharge tube. High voltage can remain in the circuit even with the HEADLIGHT switch off and the key removed. **Because of this, you should not attempt to service a headlight bulb yourself. If a headlight bulb fails, take your vehicle to an authorized dealer for service.**

WARNING!

A transient high tension occurs at the bulb sockets of High Intensity Discharge (HID) headlights when the HEADLIGHT switch is turned ON. It may cause serious electrical shock or electrocution if not serviced properly. See your authorized dealer for service.

NOTE:

- When the High Intensity Discharge Headlights (HID) are turned on, there is a blue hue to the lights. This diminishes and becomes more white after approximately 10 seconds as the system charges.
- If High Intensity Discharge (HID) lights are not working, cycle the HEADLIGHT switch four times to see if it will restrike.

Front Fog Light

1. Remove the push pin from the upper outer corner of the splash shield and remove the splash shield.

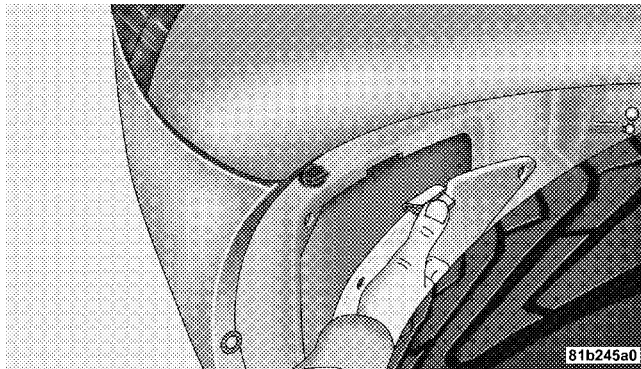

2. Turn the bulb and socket assembly counterclockwise, and then pull it out of the front fog light assembly.

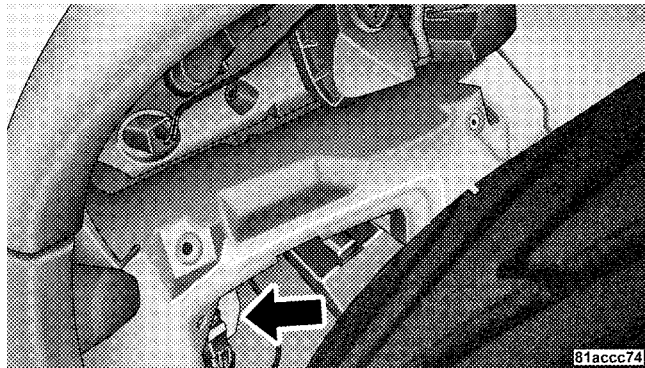

3. Pull the bulb out of the socket assembly.
4. Push the replacement bulb into the socket assembly.
5. Reinstall the bulb and socket assembly into the front fog light assembly, and then turn it clockwise.

6. Install the splash shield and push pin.

Taillight, Tail/Stop Light, Rear Marker Light

1. Open the trunk
2. Remove the two fasteners and then remove the access panel.



3. Turn the appropriate bulb and socket assembly counterclockwise, and then pull it out of the upper light assembly.

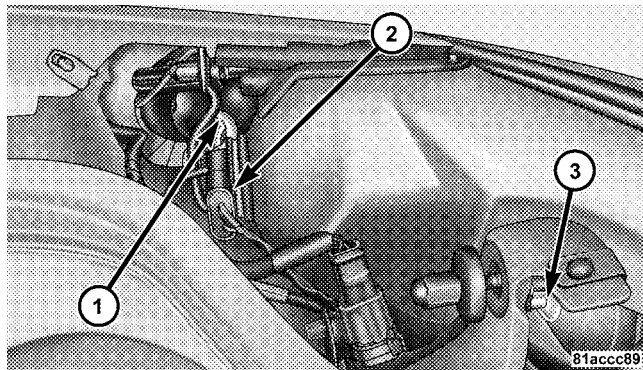

- 1 — Rear Marker Light
- 2 — Tail/Stop Light
- 3 — Taillight

4. Pull the bulb out of the socket assembly.

5. Push the replacement bulb into the socket assembly.

6. Reinstall the bulb and socket assembly into the upper light assembly, and then turn it clockwise.

7. Install the access panel and the two fasteners.

8. Close the trunk.

Taillight, Tail/Stop Light, Rear Marker Light (Coupe Models)

For bulb replacement, see your authorized dealer.

Backup Light, Rear Turn Signal Light

1. Open the trunk.
2. Remove the two fasteners and then remove the access panel.



3. Remove the three upper light assembly retaining nuts.

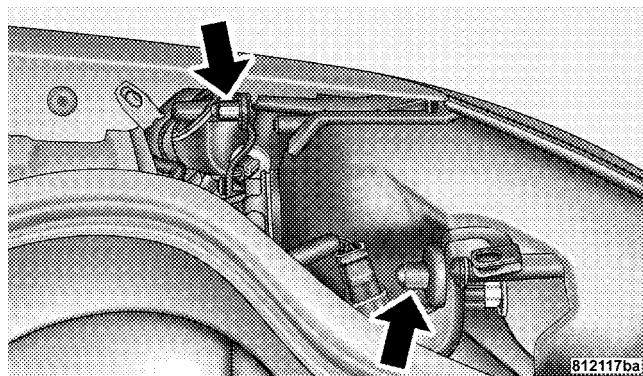

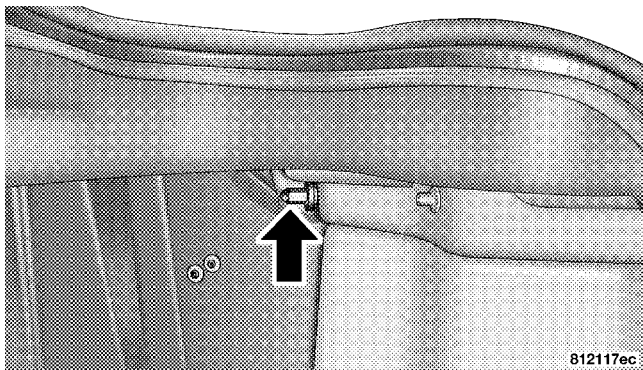

4. Remove the three bulb and socket assemblies from the upper light assembly by turning them counterclockwise and then pulling them out of the upper light assembly.

5. Remove the upper light assembly.

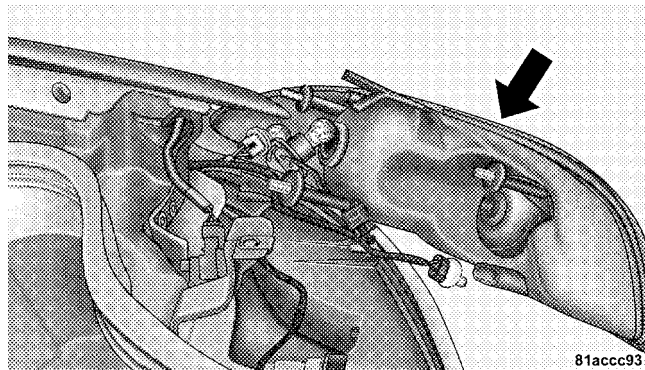

6. Turn the appropriate bulb and socket assembly counterclockwise, and then pull it out of the lower light assembly.

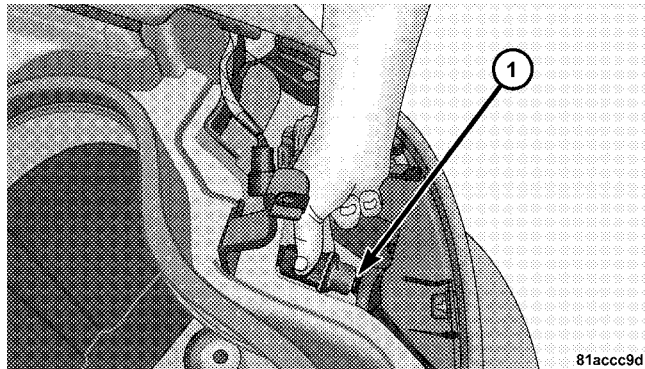

81acc9d

1 — Backup Light

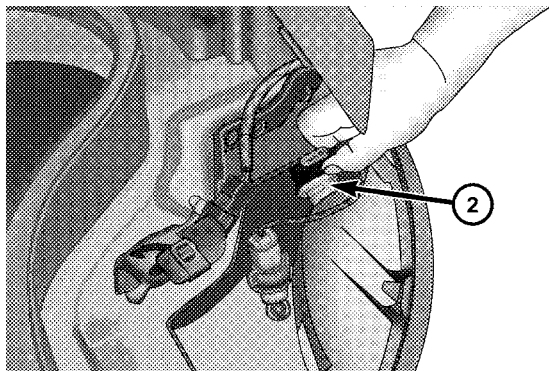

81acca3

2 — Rear Turn Signal Light

7. Pull the bulb out of the socket assembly.
8. Push the replacement bulb into the socket assembly.
9. Reinstall the bulb and socket assembly into the lower light assembly, and then turn it clockwise.

10. Reinstall the three bulb and socket assemblies into the upper light assembly, and turn them clockwise.
11. Reinstall the upper light assembly and the three retaining nuts.
12. Install the access panel and the two fasteners.
13. Close the trunk.

License Light

1. Open the trunk.
2. Turn the bulb and socket assembly counterclockwise, and then pull it out of the housing.

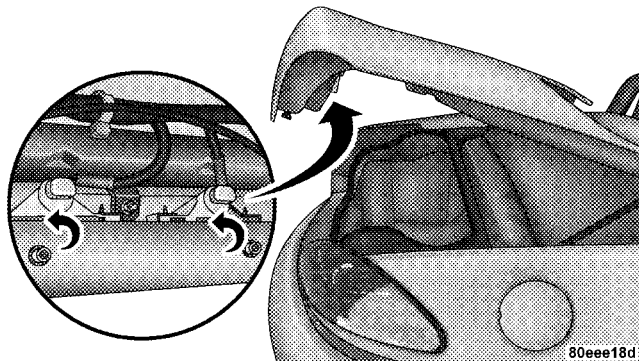

3. Pull the bulb out of the socket assembly.
4. Push the replacement bulb into the socket assembly.
5. Reinstall the bulb and socket assembly into the housing, and then turn it clockwise.
6. Close the trunk.

FLUIDS AND CAPACITIES

	U.S.	Metric
Fuel (Approximate)	16 Gallons	60.6 Liters
Engine Oil with Filter		
8.4 Liter Engine (SAE 0W-40, API Certified)	11 Quarts	10.4 Liters
Cooling System *		
8.4 Liter Engine (MOPAR® Engine Coolant/Antifreeze 5 Year/100,000 Mile Formula)	16 Quarts	15 Liters

* Includes heater and coolant recovery bottle filled to MAX level.

FLUIDS, LUBRICANTS, AND GENUINE PARTS

Engine

Component	Fluid, Lubricant, or Genuine Part
Engine Coolant	MOPAR® Antifreeze/Coolant 5 Year/100,000 Mile Formula HOAT (Hybrid Organic Additive Technology) or equivalent
Engine Oil	For best performance and maximum protection under all types of operating conditions, the manufacturer only recommends full synthetic engine oils that meet the American Petroleum Institute (API) categories of SM or SM/CF, and meet the requirements of Chrysler Material Standard MS-10725. The manufacturer recommends the use of a full synthetic engine oil, such as Mobil 1® SAE 0W-40 or equivalent. For additional information, refer to the “Engine Oil Selection” and “Engine Oil Viscosity (SAE Grade)” in the “Maintenance Procedures” section of this manual.
Engine Oil Filter	MOPAR® SRT Engine Oil Filter (P/N 05037836AA) or equivalent.
Spark Plugs	RE10PMC5 (Gap 0.050 in [1.27 mm])
Fuel Selection	Premium Unleaded 91 Octane Only or Higher

Chassis

Component	Fluid, Lubricant, or Genuine Part
Transmission	MOPAR® ATF+4 Automatic Transmission Fluid
Rear Axle	MOPAR® Synthetic Gear and Axle Lubricant SAE 75W-140 or equivalent, with Limited Slip Additive Friction Modifier
Brake Master Cylinder	MOPAR® Brake and Clutch Fluid DOT 4 Motor Vehicle or equivalent
Power Steering Reservoir	MOPAR® Power Steering Fluid + 4, MOPAR® ATF+4 Automatic Transmission Fluid

MAINTENANCE SCHEDULES

CONTENTS

<ul style="list-style-type: none"> ■ Emissions Control System Maintenance 250 ■ Maintenance Schedules 250 	<ul style="list-style-type: none"> □ Maintenance Schedule B 253 □ Maintenance Schedule A 263
---	--

EMISSIONS CONTROL SYSTEM MAINTENANCE

The Scheduled Maintenance services listed in **bold type** must be done at the times or mileages specified to ensure the continued proper functioning of the emissions control system. These and all other maintenance services included in this manual, should be done to provide best vehicle performance and reliability. More frequent maintenance may be needed for vehicles in severe operating conditions, such as dusty areas and very short trip driving.

Inspection and service should also be done anytime a malfunction is suspected.

NOTE: Maintenance, replacement or repair of the emissions control devices and systems on your vehicle may be performed by any automotive repair establishment or individual using any automotive part that has been certified pursuant to U.S. EPA or in the State of California, California Air Resources Board regulations.

MAINTENANCE SCHEDULES

There are two maintenance schedules that show the **required** service for your vehicle.

First is "Maintenance Schedule B." It is for vehicles that are operated under the conditions that are listed below and at the beginning of the schedule.

- Day or night temperatures are below 32°F (0°C).
- Stop and go driving.
- Extensive engine idling.
- Driving in dusty conditions.
- Short trips of less than 10 miles (16 km).
- More than 50% of your driving is at sustained high speeds during hot weather, above 90°F (32°C).

NOTE:

- If **ANY** of these apply to you then change your engine oil every 3,000 miles (5000 km) or three months, whichever comes first, and follow the maintenance recommendations in “Maintenance Schedule B” in this section.
- If **ANY** of these apply to you, then flush and replace the engine coolant every 102,000 miles (170 000 km) or 60 months, whichever comes first, and follow the maintenance recommendations in “Maintenance Schedule B” in this section.
- Most vehicles are operated under the conditions listed for “Maintenance Schedule B.”

Second is “Maintenance Schedule A.” It is for vehicles that are not operated under any of the conditions listed under “Maintenance Schedule B.”

Use the schedule that best describes your driving conditions. Where time and mileage are listed, follow the interval that occurs first.

NOTE: Under no circumstances should oil change intervals exceed 6,000 miles (10 000 km) or six months, whichever comes first.

CAUTION!

Failure to perform the required maintenance items may result in damage to the vehicle.

At Each Stop for Fuel

- Check the engine oil level about five minutes after a fully warmed engine is shut off. Checking the oil level while the vehicle is on level ground will improve the accuracy of the oil level reading. Add oil only when the level is at or below the ADD or MIN mark.
- Check the windshield washer solvent and add if required.

Once a Month

- Check tire pressure and look for unusual wear or damage.
- Inspect the battery, and clean and tighten the terminals as required.
- Check the fluid levels of the coolant reservoir, brake master cylinder, power steering, and transmission, and add as needed.

- Check all lights and all other electrical items for correct operation.

At Each Oil Change

- Change the engine oil filter.
- Inspect the exhaust system.

NOTE: Also, inspect the exhaust system if you notice a change in the sound of the exhaust system, or if the exhaust fumes can be detected inside the vehicle.

- Inspect the brake hoses.
- Inspect the suspension components.
- Lubricate door hinges and check springs.
- Check the engine coolant level, hoses, and clamps.
- Check power steering fluid level.

MAINTENANCE SCHEDULE B

Follow "Maintenance Schedule B" if you usually operate your vehicle under one or more of the following conditions.

- Day or night temperatures are below 32°F (0°C).
- Stop and go driving.
- Extensive engine idling.
- Driving in dusty conditions.
- Short trips of less than 10 miles (16 km).
- More than 50% of your driving is at sustained high speeds during hot weather, above 90°F (32°C).

NOTE:

- If **ANY** of these apply to you, then change your engine oil every 3,000 miles (5000 km) or three months, whichever comes first, and follow the maintenance recommendations in "Maintenance Schedule "B" in this section.
- If **ANY** of these apply to you, then flush and replace the engine coolant every 102,000 miles (170 000 km) or 60 months, whichever comes first, and follow the maintenance recommendations in "Maintenance Schedule B" in this section.

254 MAINTENANCE SCHEDULES

Miles (Kilometers)	3,000 (5 000)	6,000 (10 000)	9,000 (15 000)	12,000 (20 000)	15,000 (25 000)	18,000 (30 000)
Change engine oil and engine oil filter, if not replaced at 3 months.	X	X	X	X	X	X
Rotate the tires. ◇ ◇		X		X		X
Inspect and replace the air cleaner filter, if necessary.					X	
Inspect the transmission fluid.				X		
Inspect the brake linings.				X		
Change the rear axle fluid.				X		
Change the brake fluid.				X		
Lubricate the front and rear suspension ball joints.					X	

Miles (Kilometers)	21,000 (35 000)	24,000 (40 000)	27,000 (45 000)	30,000 (50 000)	33,000 (55 000)	36,000 (60 000)
Change engine oil and engine oil filter, if not replaced at 3 months.	X	X	X	X	X	X
Rotate the tires. ◇ ◇		X		X		X
Inspect and replace the air cleaner filter, if necessary.				X		
Inspect and replace the PCV valve, if necessary.				X		
Change the transmission fluid.		X				
Inspect the transmission fluid.						X
Inspect the brake linings.		X				X
Change the rear axle fluid.		X				X
Change the brake and clutch fluid.		X				
Change the brake fluid.						X
Lubricate the front and rear suspension ball joints.				X		

256 MAINTENANCE SCHEDULES

Miles (Kilometers)	39,000 (65 000)	42,000 (70 000)	45,000 (75 000)	48,000 (80 000)	51,000 (85 000)	54,000 (90 000)
Change engine oil and engine oil filter, if not replaced at 3 months.	X	X	X	X	X	X
Rotate the tires. ◇ ◇		X		X		X
Inspect and replace the engine air cleaner filter, if necessary.			X			
Inspect and replace the auto tension drive belt, if necessary.			X			
Change the transmission fluid.				X		
Inspect the brake linings.				X		
Change the rear axle fluid.				X		
Change the brake and clutch fluid.				X		
Lubricate the front and rear suspension ball joints.			X			

Miles (Kilometers)	57,000 (95 000)	60,000 (100 000)	63,000 (105 000)	66,000 (110 000)	69,000 (115 000)	72,000 (120 000)
Change engine oil and engine oil filter, if not replaced at 3 months.	X	X	X	X	X	X
Rotate the tires. ◇ ◇		X		X		X
Inspect and replace the air cleaner filter, if necessary.		X				
Inspect and replace the PCV valve, if necessary.		X				
Flush and replace engine coolant at 60 months, if not done at 102,000 miles.		X				
Inspect and replace the auto tension drive belt, if necessary. ‡		X				
Inspect the transmission fluid.		X				
Change the transmission fluid.						X
Inspect the brake linings.		X				X
Change the rear axle fluid.		X				X
Change the brake fluid.		X				
Change the brake and clutch fluid.						X
Lubricate the front and rear suspension ball joints.		X				

258 MAINTENANCE SCHEDULES

Miles (Kilometers)	75,000 (125 000)	78,000 (130 000)	81,000 (135 000)	84,000 (140 000)	87,000 (145 000)	90,000 (150 000)
Change engine oil and engine oil filter, if not replaced at 3 months.	X	X	X	X	X	X
Rotate the tires. ◇ ◇		X		X		X
Inspect and replace the air cleaner filter, if necessary.	X					X
Inspect and replace the PCV valve, if necessary.						X
Inspect and replace the auto tension drive belt, if necessary. ‡	X					X
Inspect the transmission fluid.				X		
Inspect the brake linings.				X		
Change the rear axle fluid.				X		
Change the brake fluid.				X		
Lubricate the front and rear suspension ball joints.	X					X

Miles (Kilometers)	93,000 (155 000)	96,000 (160 000)	99,000 (165 000)	102,000 (170 000)	105,000 (175 000)	108,000 (180 000)
Change engine oil and engine oil filter, if not replaced at 3 months.	X	X	X	X	X	X
Rotate the tires. ◇ ◇		X		X		X
Inspect and replace the engine air cleaner filter, if necessary.					X	
Replace the spark plugs.				X		
Replace the ignition cables.				X		
Flush and replace the engine coolant, if not replaced at 60 months.				X		
Inspect and replace the auto tension drive belt, if necessary. ‡					X	
Change the transmission fluid.		X				
Inspect the transmission fluid.						X
Inspect the brake linings.		X				X

260 MAINTENANCE SCHEDULES

Miles (Kilometers)	93,000 (155 000)	96,000 (160 000)	99,000 (165 000)	102,000 (170 000)	105,000 (175 000)	108,000 (180 000)
Change the rear axle fluid.		X				X
Change the brake and clutch fluid.		X				
Change the brake fluid.						X
Lubricate the front and rear suspension ball joints.					X	

Miles (Kilometers)	111,000 (185 000)	114,000 (190 000)	117,000 (195 000)	120,000 (200 000)
Change engine oil and engine oil filter, if not replaced at 3 months.	X	X	X	X
Rotate the tires. ◇ ◇		X		X
Inspect and replace the engine air cleaner filter, if necessary.				X
Inspect and replace the PCV valve, if necessary.				X
Flush and replace the engine coolant, if not replaced at 102,000 months.				X
Inspect and replace the auto tension drive belt, if necessary. ‡				X
Change the transmission fluid.				X
Inspect the brake linings.				X

262 MAINTENANCE SCHEDULES

Miles (Kilometers)	111,000 (185 000)	114,000 (190 000)	117,000 (195 000)	120,000 (200 000)
Change the rear axle fluid.				X
Change the brake and clutch fluid.				X
Lubricate the front and rear suspension ball joints.				X

‡ This maintenance is not required if previously replaced.

◇◇ Although not required, the manufacturer recommends reprogramming TPMS after rotating tires so system can relearn tire pressure sensor location. For more information refer to "Tire Pressure Monitor System (TPMS)" in Section 5 of this manual.

Inspection and service should also be performed anytime a malfunction is observed or suspected. Retain all receipts.

MAINTENANCE SCHEDULE A

Miles (Kilometers) [Months]	6,000 (10 000) [6]	12,000 (20 000) [12]	18,000 (30 000) [18]	24,000 (40 000) [24]	30,000 (50 000) [30]
Change engine oil and engine oil filter.	X	X	X	X	X
Rotate the tires. ◇ ◇	X	X	X	X	X
Inspect and replace the engine air cleaner filter, if necessary.					X
Inspect the transmission fluid.		X		X	
Inspect the brake linings.			X		
Change the rear axle fluid.			X		
Change the brake fluid.			X		
Lubricate the front and rear suspension ball joints.					X

264 MAINTENANCE SCHEDULES

Miles (Kilometers) [Months]	36,000 (60 000) [36]	42,000 (70 000) [42]	48,000 (80 000) [48]	54,000 (90 000) [54]	60,000 (100 000) [60]
Change engine oil and engine oil filter.	X	X	X	X	X
Rotate the tires. ◇ ◇	X	X	X	X	X
Inspect and replace the engine air cleaner filter, if necessary.					X
Inspect and replace the PCV valve, if necessary.					X
Flush and replace the engine coolant at 60 months, if not done at 102,000 miles.					X
Inspect and replace the auto tension drive belt, if necessary.					X
Change the transmission fluid.	X				
Inspect the transmission fluid.			X		X
Inspect the brake linings.	X			X	

Miles (Kilometers) [Months]	36,000 (60 000) [36]	42,000 (70 000) [42]	48,000 (80 000) [48]	54,000 (90 000) [54]	60,000 (100 000) [60]
Change the rear axle fluid.	X			X	
Change the brake and clutch fluid.	X				
Change the brake fluid.				X	
Lubricate the front and rear suspension ball joints.					X

266 MAINTENANCE SCHEDULES

Miles (Kilometers) [Months]	66,000 (110 000) [66]	72,000 (120 000) [72]	78,000 (130 000) [78]	84,000 (140 000) [84]	90,000 (150 000) [90]
Change engine oil and engine oil filter.	X	X	X	X	X
Rotate the tires. ◇ ◇	X	X	X	X	X
Inspect and replace the engine air cleaner filter, if necessary.					X
Inspect and replace the PCV valve, if necessary.					X
Inspect and replace the auto tension drive belt, if necessary. ‡		X		X	
Change the transmission fluid.		X			
Inspect the transmission fluid.				X	
Inspect the brake linings.		X			X
Change the rear axle fluid.		X			X
Change the brake and clutch fluid.		X			
Change the brake fluid.					X
Lubricate the front and rear suspension ball joints.					X

Miles (Kilometers) [Months]	96,000 (160 000) [96]	102,000 (170 000) [102]	108,000 (180 000) [108]	114,000 (190 000) [114]	120,000 (200 000) [120]
Change engine oil and engine oil filter.	X	X	X	X	X
Rotate the tires. ◇ ◇	X	X	X	X	X
Inspect and replace the engine air cleaner filter, if necessary.					X
Inspect and replace the PCV valve, if necessary.					X
Replace the spark plugs.		X			
Replace the ignition cables.		X			
Flush and replace the engine coolant, if not replaced at 60 months.		X			
Flush and replace the engine coolant, if not replaced at 102,000 miles.					X
Inspect and replace the auto tension drive belt, if necessary. ‡	X		X		X
Inspect the transmission fluid.	X				X
Change the transmission fluid.			X		

268 MAINTENANCE SCHEDULES

Miles (Kilometers) [Months]	96,000 (160 000) [96]	102,000 (170 000) [102]	108,000 (180 000) [108]	114,000 (190 000) [114]	120,000 (200 000) [120]
Inspect the brake linings.			X		
Change the rear axle fluid.			X		
Change the brake and clutch fluid.			X		
Lubricate the front and rear suspension ball joints.					X

‡ This maintenance is not required if previously replaced.

◇◇ Although not required, the manufacturer recommends reprogramming TPMS after rotating tires so system can relearn tire pressure sensor location. For more information, refer to "Tire Pressure Monitor System (TPMS)" in Section 5 of this manual.

Inspection and service should also be performed anytime a malfunction is observed or suspected. Retain all receipts.

WARNING!

You can be badly injured working on or around a motor vehicle. Do only the service work for which you have the knowledge and the right equipment. If you have any doubt about your ability to perform a service job, take your vehicle to a competent mechanic.

IF YOU NEED CONSUMER ASSISTANCE

CONTENTS

■ Suggestions For Obtaining Service For Your Vehicle	271	□ Customer Assistance For The Hearing Or Speech Impaired (TDD/TTY)	273
□ Prepare For The Appointment	271	□ Service Contract	273
□ Prepare A List	271	■ Warranty Information (U.S. Vehicles Only)	274
□ Be Reasonable With Requests	271	■ MOPAR® Parts	274
■ If You Need Assistance	271	■ Reporting Safety Defects	274
□ Chrysler LLC Customer Center	272	□ In The 50 United States And Washington, D.C.	274
□ Chrysler Canada Inc. Customer Center	272	□ In Canada	275
□ In Mexico Contact	272	■ Publication Order Forms	275

270 IF YOU NEED CONSUMER ASSISTANCE

■ Department Of Transportation Uniform Tire Quality Grades	276
□ Treadwear	277

□ Traction Grades	277
□ Temperature Grades	277

SUGGESTIONS FOR OBTAINING SERVICE FOR YOUR VEHICLE

Prepare For The Appointment

If you're having warranty work done, be sure to have the right papers with you. Take your warranty folder. All work to be performed may not be covered by the warranty. Discuss additional charges with the service manager. Keep a maintenance log of your vehicle's service history. This can often provide a clue to the current problem.

Prepare A List

Make a written list of your vehicle's problems or the specific work you want done. If you've had an accident or work done that is not on your maintenance log, let the service advisor know.

Be Reasonable With Requests

If you list a number of items and you must have your vehicle by the end of the day, discuss the situation with

the service advisor and list the items in order of priority. At many authorized dealers, you may obtain a rental vehicle at a minimal daily charge. If you need a rental, it is advisable to make these arrangements when you call for an appointment.

IF YOU NEED ASSISTANCE

The manufacturer and its authorized dealers are vitally interested in your satisfaction. We want you to be happy with our products and services.

Warranty service must be done by an authorized dealer. We strongly recommend that you take the vehicle to an authorized dealer. They know you and the vehicle best, and are most concerned that you get prompt and high quality service. The manufacturer's authorized dealers have the facilities, factory-trained technicians, special tools, and the latest information to ensure the vehicle is fixed correctly and in a timely manner.

This is why you should always talk to an authorized dealer's service manager first. Most matters can be resolved with this process.

- If for some reason you are still not satisfied, talk to the general manager or owner of the authorized dealership. They want to know if you need assistance.
- If an authorized dealership is unable to resolve the concern, you may contact the manufacturer's customer center.

Any communication to the manufacturer's customer center should include the following information:

- Owner's name and address
- Owner's telephone number (home and office)
- Authorized dealership name
- Vehicle Identification Number (VIN)
- Vehicle delivery date and mileage

Chrysler LLC Customer Center

P.O. Box 21-8004

Auburn Hills, MI 48321-8004

Phone: (800) 992-1997

Chrysler Canada Inc. Customer Center

P.O. Box 1621

Windsor, Ontario N9A 4H6

Phone: (800) 465-2001

In Mexico contact:

Av. Prolongacion Paseo de la Reforma, 1240

Sante Fe C.P. 05109

Mexico, D. F.

In Mexico City: 5081-7568

Outside Mexico City: 1-800-505-1300

Customer Assistance For The Hearing Or Speech Impaired (TDD/TTY)

To assist customers who have hearing difficulties, the manufacturer has installed special TDD (Telecommunication Devices for the Deaf) equipment at its customer center. Any hearing or speech impaired customer, who has access to a TDD or a conventional teletypewriter (TTY) in the United States, can communicate with the manufacturer by dialing 1-800-380-CHRY.

Service Contract

You may have purchased a service contract for a vehicle to help protect you from the high cost of unexpected repairs after the manufacturer's New Vehicle Limited Warranty expires. The manufacturer stands behind only the manufacturer's service contracts. If you purchased a manufacturer's service contract, you will receive Plan Provisions and an Owner Identification Card in the mail within three weeks of the vehicle delivery date. If you

have any questions about the service contract, call the manufacturer's Service Contract National Customer Hotline at 1-800-521-9922.

The manufacturer will not stand behind any service contract that is not the manufacturer's service contract. It is not responsible for any service contract other than the manufacturer's service contract. If you purchased a service contract that is not a manufacturer's service contract, and you require service after the manufacturer's New Vehicle Limited Warranty expires, please refer to the contract documents, and contact the person listed in those documents.

We appreciate that you have made a major investment when you purchased the vehicle. An authorized dealer has also made a major investment in facilities, tools, and training to assure that you are absolutely delighted with the ownership experience. You'll be pleased with their sincere efforts to resolve any warranty issues or related concerns.

WARNING!

Engine exhaust, some of its constituents, and certain vehicle components contain, or emit, chemicals known to the State of California to cause cancer and birth defects, or other reproductive harm. In addition, certain fluids contained in vehicles and certain products of component wear contain, or emit, chemicals known to the State of California to cause cancer and birth defects, or other reproductive harm.

WARRANTY INFORMATION (U.S. Vehicles Only)

See the Warranty Information Booklet for the terms and provisions of Chrysler Motors LLC warranties applicable to this vehicle.

MOPAR® PARTS

Mopar® fluids, lubricants, parts, and accessories are available from an authorized dealer. They will help keep the vehicle operating at its best.

REPORTING SAFETY DEFECTS**In The 50 United States And Washington, D.C.**

If you believe that your vehicle has a defect that could cause a crash or cause injury or death, you should immediately inform the National Highway Traffic Safety Administration (NHTSA) in addition to notifying the manufacturer.

If NHTSA receives similar complaints, it may open an investigation, and if it finds that a safety defect exists in a group of vehicles, it may order a recall and remedy campaign. However, NHTSA cannot become involved in individual problems between you, your authorized dealer, and the manufacturer.

To contact NHTSA, you may either call the Auto Safety Hotline toll free at 1-888-327-4236 (TTY: 1-800-424-9153), or go to <http://www.safercar.gov>; or write to: Administrator, NHTSA, 400 Seventh Street, SW., Washington, D.C. 20590. You can also obtain other information about motor vehicle safety from <http://www.safercar.gov>.

In Canada

If you believe that your vehicle has a safety defect, you should contact the Customer Service Department immediately. Canadian customers who wish to report a safety defect to the Canadian government should write to: Transport Canada, Motor Vehicle Defect Investigations and Recalls, 2780 Sheffield Road, Ottawa, Ontario K1B 3V9.

PUBLICATION ORDER FORMS

To order the following manuals, you may use either the website or the phone numbers listed below. Visa, Mastercard, American Express, and Discover orders are accepted. If you prefer mailing your payment, please call for an order form.

NOTE: A street address is required when ordering manuals (no P.O. Boxes).

- *Service Manuals*

These comprehensive Service Manuals provide the information that students and professional technicians need in diagnosing/troubleshooting, problem solving, maintaining, servicing, and repairing Chrysler LLC vehicles. A complete working knowledge of the vehicle, system, and/or components is written in straightforward language with illustrations, diagrams, and charts.

- *Diagnostic Procedure Manuals*

Diagnostic Procedure Manuals are filled with diagrams, charts and detailed illustrations. These practical manuals make it easy for students and technicians to find and fix problems on computer-controlled vehicle systems and features. They show exactly how to find and correct problems the first time, using step-by-step troubleshooting and drivability procedures, proven diagnostic tests and a complete list of all tools and equipment.

- *Owner's Manuals*

These Owner's Manuals have been prepared with the assistance of service and engineering specialists to acquaint you with specific Chrysler LLC vehicles. Included are starting, operating, emergency and maintenance procedures as well as specifications, capabilities and safety tips.

Call toll free at:

- 1-800-890-4038 (U.S.)
- 1-800-387-1143 (Canada)

Or

Visit us on the Worldwide Web at:

- www.techauthority.com

DEPARTMENT OF TRANSPORTATION UNIFORM TIRE QUALITY GRADES

The following tire grading categories were established by the National Highway Traffic Safety Administration. The specific grade rating assigned by the tire's manufacturer in each category is shown on the sidewall of the tires on your vehicle.

All passenger car tires must conform to Federal safety requirements in addition to these grades.

Treadwear

The Treadwear grade is a comparative rating, based on the wear rate of the tire when tested under controlled conditions on a specified government test course. For example, a tire graded 150 would wear one and one-half times as well on the government course as a tire graded 100. The relative performance of tires depends upon the actual conditions of their use, however, and may depart significantly from the norm due to variations in driving habits, service practices, and differences in road characteristics and climate.

Traction Grades

The Traction grades, from highest to lowest, are AA, A, B, and C. These grades represent the tire's ability to stop on wet pavement, as measured under controlled conditions on specified government test surfaces of asphalt and concrete. A tire marked C may have poor traction performance.

WARNING!

The traction grade assigned to this tire is based on straight-ahead braking traction tests, and does not include acceleration, cornering, hydroplaning, or peak traction characteristics.

Temperature Grades

The temperature grades are A (the highest), B, and C, representing the tire's resistance to the generation of heat and its ability to dissipate heat, when tested under controlled conditions on a specified indoor laboratory test wheel. Sustained high temperature can cause the material of the tire to degenerate and reduce tire life, and excessive temperature can lead to sudden tire failure. The grade C corresponds to a level of performance, which all passenger car tires must meet under the Federal Motor

Vehicle Safety Standard No. 109. Grades B and A represent higher levels of performance on the laboratory test wheel, than the minimum required by law.

WARNING!

The temperature grade for this tire is established for a tire that is properly inflated and not overloaded. Excessive speed, under-inflation, or excessive loading, either separately or in combination, can cause heat buildup and possible tire failure.

INDEX

- About Your Brakes 147
- ABS (Anti-Lock Brake System) 101,148
- Accessory Delay, Power 13,28
- Adding Engine Coolant (Antifreeze) 218
- Adding Fuel 175
- Adding Washer Fluid 213
- Adjustable Pedals 92
- Air Cleaner, Engine (Engine Air Cleaner Filter) . . . 206
- Air Conditioner Maintenance 211
- Air Conditioning 125,126,128,211
- Air Conditioning Controls 126
- Air Conditioning, Operating Tips 130
- Air Conditioning Refrigerant 211,212
- Air Conditioning System 126,128,211
- Air Pressure, Tires 105,161
- Airbag 42
- Airbag Deployment 46,51
- Airbag Light 46,47,53,61,103
- Airbag Maintenance 52
- Airbag On/Off Switch 54
- Alarm System (Security Alarm) 13
- Alterations/Modifications, Vehicle 7
- Antenna 124
- Antenna, Satellite Radio 124
- Antifreeze (Engine Coolant) 217,218,246
- Capacities 246
- Disposal 220
- Anti-Lock Brake System (ABS) 148
- Anti-Lock Warning Light 101,151
- Anti-Theft Security Alarm (Theft Alarm) 13
- Appearance Care 226
- Auto Down Power Windows 30
- Automatic Door Locks 27
- Battery 109,207
- Emergency Starting 192
- Jump Starting 192
- Keyless Transmitter Replacement (RKE) 23

Location	192,207	Caps, Filler	
Saving Feature (Protection)	210	Fuel	175
Storing Vehicle	210	Oil (Engine)	205
Belts, Seat	33,34	Power Steering	144
Body Mechanism Lubrication	212	Radiator (Coolant Pressure)	219
Boot, Convertible Top	69,74	Car Washes	227
B-Pillar Location	156	Carbon Monoxide Warning	60,174
Brake, Parking	145	CD (Compact Disc) Changer	116
Brake System	147,222	CD (Compact Disc) Player	111,115
Anti-Lock (ABS)	147,148	Cellular Phone	125
Fluid Check	222,248	Chains, Tire	167
Master Cylinder	222	Charging System Light	109
Warning Light	104	Chart, Tire Sizing	153
Break-In Recommendations, New Vehicle	59,147	Check Engine Light	
Bulb Replacement	237	(Malfunction Indicator Light)	201
Bulbs, Light	236	Checks, Safety	60
Capacities, Antifreeze (Engine Coolant)	246	Child Restraint	53,54,55,58
Capacities, Fluid	246	Child Restraint Tether Anchors	56
		Circuit Breakers	230

Clean Air Gasoline	171	Inspection	220
Climate Control	125	Points to Remember	221
Clock	110	Pressure Cap	219
Clutch Fluid	224	Radiator Cap	219
Compact Disc (CD) Maintenance	124	Selection of Coolant (Antifreeze)	217,246,247
Console	94	Customer Assistance	271
Console, Floor	94	Daytime Running Lights	84
Contract, Service	273	Dealer Service	203
Convertible	65	Defroster, Rear Window	95
Convertible Boot	69,74	Defroster, Windshield	61,128
Convertible Top	65,228	Delay (Intermittent) Wipers	90
Convertible Top Maintenance	228	Diagnostic System, Onboard	200
Coolant Pressure Cap (Radiator Cap)	219	Dimmer Control	88
Cooling System	216	Dimmer Switch, Headlight	86
Adding Coolant (Antifreeze)	218	Dipsticks	
Coolant Capacity	246	Power Steering	144
Coolant Level	217,220	Disposal	
Disposal of Used Coolant	220	Antifreeze (Engine Coolant)	220
Drain, Flush, and Refill	217		

Door Locks	25	Engine	199
Door Locks, Automatic	27	Air Cleaner	206
Doors	25	Break-In Recommendations	59
Driving		Checking Oil Level	203
On Slippery Surfaces	141	Compartment	199
Through Flowing, Rising, or Shallow		Coolant (Antifreeze)	217,247
Standing Water	142	Cooling	108,216
Electric Remote Mirrors	78	Exhaust Gas Caution	31,60,174
Electronic Throttle Control Warning Light	104	Fails to Start	136
Emergency Brake	145	Flooded, Starting	136
Emergency, In Case of		Fuel Requirements	170,246
Freeing Vehicle When Stuck	195	Oil	203,246,247
Hazard Warning Flasher	180	Oil Change Interval	204
Jump Starting	192	Oil Disposal	206
Overheating	180	Oil Filler Cap	205
Towing	196	Oil Filter	206
Emission Control System Maintenance	201,250	Oil Selection	205,246
		Overheating	108,180
		Engine Oil Viscosity	205,246

Engine Oil Viscosity Chart	205	Fluid Level Checks	
Ethanol	171	Brake	222,248
Exhaust Gas Caution	31,60,174,214	Capacities	246
Exhaust System	60,214	Clutch Fluid	224
Exterior Finish Care	227	Cooling System	217
Filters		Engine Oil	203
Air Cleaner	206	Manual Transmission	224,248
Engine Oil	206,247	Power Steering	144,248
Engine Oil Disposal	206	Fluids	247
Finish Care	227	Fluids, Lubricants and Genuine Parts	247
Flashers		Fog Lights	83,84,101
Hazard Warning	103,180	Four-Way Hazard Flasher	180
Turn Signal	85,103	Freeing A Stuck Vehicle	195
Flash-To-Pass	86	Fuel	170
Flooded Engine Starting	136	Adding	175
Floor Console	94	Clean Air	171
Fluid Capacities	246	Ethanol	171
Fluid Leaks	62	Filler Cap (Gas Cap)	175
		Gasoline	170

Gauge	109	Voltmeter	109
Methanol	171	General Information	24
Octane Rating	170,247	Glass Cleaning	228
Requirements	170,246	Ground Clearance	177
Tank Capacity	246	Hazard	
Fuel System Caution	175	Driving Through Flowing, Rising, or Shallow	
Fueling	175	Standing Water	142
Fuses	230	Hazard Warning Flasher	103,180
Gas Cap (Fuel Filler Cap)	175	Headlights	83,238
Gasoline, Clean Air	171	High Beam	86
Gasoline (Fuel)	170	High Beam/Low Beam Select Switch	86
Gasoline, Reformulated	171	Lights On Reminder	84
Gauges	107	Passing	86
Coolant Temperature	108	Switch	83
Fuel	109	Time Delay	83
Oil Pressure	108	Heater	125,126
Speedometer	100	High Beam Indicator	101
Tachometer	107	High Beam/Low Beam Select (Dimmer) Switch	86

Hood Release	81	Jump Starting	192
Hydraulic Clutch Fluid	224	Key-In Reminder	13
Ignition	12	Keyless Entry System	18
Key	12	Keys	12
Ignition Key Removal	12	Knee Bolster	42,43
Illuminated Entry	18	Lane Change and Turn Signals	85
Infant Restraint	53,54	Lap/Shoulder Belts	34
Inflation Pressure Tires	105	Latch Plate	35
Inside Rearview Mirror	77	Latches	62
Instrument Cluster	100	Hood	81
Instrument Panel and Controls	99	Lead Free Gasoline	170
Instrument Panel Lens Cleaning	229	Life of Tires	165
Interior Appearance Care	228	Liftgate	30
Interior Lighting	83,86	Lights	62,83
Interior Lights	86,88	Airbag	47,53,61,103
Intermittent Wipers (Delay Wipers)	90	Anti-Lock	101,151
Introduction	4	Anti-Lock Warning	101

Battery Saver	84,88	Interior	86,88
Brake Warning	104	Lights On Reminder	84
Bulb Replacement	236	Low Tire	105
Courtesy/Reading	87	Malfunction Indicator (Check Engine)	102
Daytime Running	84	Map Reading	87
Dimmer Switch, Headlight	86	Oil Pressure	109
Electronic Throttle Control Warning	104	Park	83
Engine Temperature Warning	108	Passing	86
Exterior Check	62	Reading	87
Fog	84,101	Seat Belt Reminder	107
Hazard Warning Flasher	103,180	Service	236,237
Headlight Switch	83	Service Engine Soon (Malfunction Indicator)	102
Headlights	83,238	Tire Pressure Monitoring (TPMS)	105,169
Headlights On Reminder	84	Turn Signal	85,103
High Beam	86,101	Voltage	109
High Beam Indicator	101	Loading Vehicle	
Illuminated Entry	18	Tires	156
Instrument Cluster	83	Locks	25
Intensity Control	88	Door	25

Power Door	26	Mirrors	77
Low Tire Indicator	169	Electric Remote	78
Low Tire Pressure System	169	Outside	77,78
Lubrication, Body	212	Rearview	77
Maintenance Free Battery	207	Modifications/Alterations, Vehicle	7
Maintenance Procedures	203	Monitor, Tire Pressure System	169
Maintenance Schedule	250	Mopar Parts	202,274
Light Duty Schedule "B"	253	MTBE/ETBE	171
Schedule "A"	263	Multi-Function Control Lever	83
Schedule "B"	253	New Vehicle Break-In Period	59
Malfunction Indicator Light (Check Engine)	102,201	Occupant Restraints	33
Manual, Service	275	Octane Rating, Gasoline (Fuel)	170
Manual Transmission	137	Odometer	100
Fluid Level Check	224,248	Trip	100
Lubricant Selection	248	Oil, Engine	203,246,247
Shift Speeds	139	Capacity	246
Message Center	101	Change Interval	204
Methanol	171		

Checking	203	Parking Brake	145
Dipstick	203	Parking On Hill	145
Disposal	206	Passing Light	86
Filter	206,247	Pedals, Adjustable	92
Filter Disposal	206	Pets	59
Materials Added to	206	Pets, Transporting	59
Pressure Gauge	108	Placard, Tire and Loading Information	156
Recommendation	205,246	Polishing and Waxing	227
Viscosity	205,246	Power	
Oil Filter, Selection	206	Accessory Delay	13,28
Onboard Diagnostic System	200,201	Brakes	147
Operator Manual (Owner's Manual)	4	Distribution Center (Fuses)	230
Outside Rearview Mirrors	77	Door Locks	26
Overheating, Engine	180	Mirrors	78
Owner's Manual (Operator Manual)	4,275	Steering	144
		Windows	28
Paint Care	226	Pregnant Women and Seat Belts	41
Paint Damage	226	Programming Transmitters	
Panic Alarm	21	(Remote Keyless Entry)	22

Radial Ply Tires	163	Replacement Parts	202
Radiator Cap (Coolant Pressure Cap)	219	Replacement Tires	166
Radio Antenna	124	Reporting Safety Defects	274
Radio Operation	125	Restraints, Child	53
Radio, Satellite	120	Restraints, Infant	54
Radio (Sound Systems)	111	Restraints, Occupant	33
Rear Axle (Differential)	226	Rocking Vehicle When Stuck	195
Rear Liftgate	30	Rotation, Tires	167
Rear Window Defroster	95	Safety Checks Inside Vehicle	61
Rear Window Features	95	Safety Checks Outside Vehicle	62
Rearview Mirrors	77	Safety Defects, Reporting	274
Reclining Front Seats	80	Safety, Exhaust Gas	31
Recreational Towing	176	Safety Information, Tire	151
Reformulated Gasoline	171	Safety Tips	60
Refrigerant	212	Satellite Radio	120
Reminder, Lights On	84	Satellite Radio Antenna	124
Reminder, Seat Belt	39,107	Schedule, Maintenance	250
Remote Keyless Entry (RKE)	18	Scheduled Maintenance	203
Remote Trunk Release	32		

Seat Belt Reminder	39,107	Service Engine Soon Light (Malfunction Indicator)	102
Seat Belts	33,34	Service Manuals	275
And Pregnant Women	41	Setting the Clock	110
Child Restraint	53,54,55,58	Shift Indicator Light	107,139
Extender	41	Shift Speeds	137,139
Inspection	61	Shift Speeds, Manual Transaxle	139
Maintenance	229	Shoulder Belts	34
Operating Instructions	35	Signals, Turn	85,103
Reminder	107	Slippery Surfaces, Driving On	141
Untwisting Procedure	39	Snow Chains (Tire Chains)	167
Seats	79	Snow Tires	167
Adjustment	79	Speedometer	100
Reclining	80	Starting	134
Security Alarm (Theft Alarm)	13	Emergency (Jump Starting)	192
Selection of Coolant (Antifreeze)	217,247	Engine Fails to Start	136
Selection of Oil	205	Starting and Operating	134
Service Assistance	271	Starting Procedures	134
Service Contract	273		

Steering		Tires	62,160,276
Power	144	Aging (Life of Tires)	165
Tilt Column	91	Air Pressure	160
Storage	234	Chains	167
Storage, Vehicle	129	General Information	160
Stuck, Freeing	195	High Speed	162
Supplemental Restraint System - Airbag	42	Inflation Pressures	161
Synthetic Engine Oil	206	Life of Tires	165
		Load Capacity	156
Tachometer	107	Pressure Monitor System (TPMS)	169
Temperature Gauge, Engine Coolant	108	Quality Grading	276
Theft Alarm (Security Alarm)	13	Radial	163
Theft System (Security Alarm)	13	Replacement	166
Tilt Steering Column	91	Rotation	167
Tire and Loading Information Placard	156	Safety	62,151,160
Tire Identification Number (TIN)	155	Sizes	153
Tire Markings	151	Snow Tires	167
Tire Safety Information	151	Spinning	164
TIREFIT	181	Storage	167

Tread Wear Indicators	164	Trunk Release Remote Control	32
Top Cover	69	Turn Signals	83,85,103
Towing	176,196	Uniform Tire Quality Grades	276
Disabled Vehicle	196	Unleaded Gasoline	170
Recreational	176	Untwisting Procedure, Seat Belt	39
Traction	141	Upholstery Care	228
Trailer Towing	176	Vehicle Identification Number (VIN)	6
Transmission	224	Vehicle Loading	156
Fluid	248	Vehicle Modifications/Alterations	7
Shifting	137,139	Vehicle Storage	129,234
Transmitter Battery Service (Remote Keyless Entry)	23	Vehicle Theft Alarm (Security Alarm)	13
Transmitter Programming (Remote Keyless Entry)	22	Vinyl Trim	228
Transmitter, Remote Keyless Entry (RKE)	18,23	Viscosity, Engine Oil	205,246
Transporting Pets	59	Voltmeter	109
Tread Wear Indicators	164	Warning Flasher, Hazard	180
Trip Odometer	100	Warnings and Cautions	6
Trunk Release, Emergency	33		

Warranty Information	274	Window Fogging	130
Washer, Adding Fluid	213	Windows	28
Washers, Windshield	89,91,213	Power	28
Washing Vehicle	227	Windshield Defroster	61,128
Water		Windshield Washers	89,91,213
Driving Through	142	Windshield Wiper Blades	213
Waxing and Polishing	227	Windshield Wipers	89
Wheel and Wheel Trim	227	Wiper Blade Replacement	213
Wheel and Wheel Trim Care	227	Wipers, Intermittent	90
Wind Buffeting	30		

INSTALLATION OF RADIO TRANSMITTING EQUIPMENT

Special design considerations are incorporated into this vehicle's electronic system to provide immunity to radio frequency signals. Mobile two-way radios and telephone equipment must be installed properly by trained personnel. The following must be observed during installation.

The positive power connection should be made directly to the battery and fused as close to the battery as possible. The negative power connection should be made to body sheet metal adjacent to the negative battery connection. This connection should not be fused.

Antennas for two-way radios should be mounted on the roof or the rear area of the vehicle. Care should be used in mounting antennas with magnet bases. Magnets may affect the accuracy or operation of the compass on vehicles so equipped.

The antenna cable should be as short as practical and routed away from the vehicle wiring when possible. Use only fully shielded coaxial cable.

Carefully match the antenna and cable to the radio to ensure a low Standing Wave Ratio (SWR).

Mobile radio equipment with output power greater than normal may require special precautions.

All installations should be checked for possible interference between the communications equipment and the vehicle's electronic systems.



Chrysler LLC
81-226-0905



First Edition

Download from www.somanuals.com. All Manuals Search And Download.

Printed in U.S.A.

Free Manuals Download Website

<http://myh66.com>

<http://usermanuals.us>

<http://www.somanuals.com>

<http://www.4manuals.cc>

<http://www.manual-lib.com>

<http://www.404manual.com>

<http://www.luxmanual.com>

<http://aubethermostatmanual.com>

Golf course search by state

<http://golfingnear.com>

Email search by domain

<http://emailbydomain.com>

Auto manuals search

<http://auto.somanuals.com>

TV manuals search

<http://tv.somanuals.com>