



**DODGE**

---

2009 **Aspen/Durango**

**OWNER'S MANUAL**

**Hybrid Supplement**

## VEHICLES SOLD IN CANADA

With respect to any Vehicles Sold in Canada, the name Chrysler LLC shall be deemed to be deleted and the name Chrysler Canada Inc. used in substitution therefor.

### DRIVING AND ALCOHOL

Drunken driving is one of the most frequent causes of accidents.

Your driving ability can be seriously impaired with blood alcohol levels far below the legal minimum. If you are drinking, don't drive. Ride with a designated non-drinking driver, call a cab, a friend, or use public transportation.

#### **WARNING!**

**Driving after drinking can lead to an accident. Your perceptions are less sharp, your reflexes are slower, and your judgment is impaired when you have been drinking. Never drink and then drive.**

This manual illustrates and describes the operation of features and equipment that are either standard or optional on this vehicle. This manual may also include a description of features and equipment that are no longer available or were not ordered on this vehicle. Please disregard any features and equipment described in this manual that are not on this vehicle.

Chrysler LLC reserves the right to make changes in design and specifications, and/or make additions to or improvements to its products without imposing any obligation upon itself to install them on products previously manufactured.

Copyright © 2008 Chrysler LLC



# TABLE OF CONTENTS

SECTION		PAGE
1	INTRODUCTION .....	3
2	THINGS TO KNOW BEFORE STARTING YOUR VEHICLE .....	5
3	UNDERSTANDING THE FEATURES OF YOUR VEHICLE .....	19
4	UNDERSTANDING YOUR INSTRUMENT PANEL .....	21
5	STARTING AND OPERATING .....	55
6	WHAT TO DO IN EMERGENCIES .....	67
7	MAINTAINING YOUR VEHICLE .....	87
8	MAINTENANCE SCHEDULES .....	113
9	INDEX .....	127



---

# INTRODUCTION

## CONTENTS

---

■ Introduction . . . . .	4
--------------------------	---

### **INTRODUCTION**

This booklet is a supplement to the Owner's Manual. This manual was prepared with the assistance of service and engineering specialists and is intended to aid the operators of Hybrid vehicles in understanding the operation and required maintenance procedures for such vehicles. This supplement applies to Hybrid vehicles only. You are urged to read this Owner's Manual carefully.

Following the instructions and recommendations provided herein will help assure safe and reliable operation of your vehicle. After you have read the Owner's Manual, it should be stored in the vehicle for convenient reference and remain with the vehicle when sold.

Copyright© 2008 Chrysler LLC

# THINGS TO KNOW BEFORE STARTING YOUR VEHICLE

## CONTENTS

---

■ A Word About Your Keys . . . . .	6	□ Hybrid System Components . . . . .	12
■ Hybrid System Operation . . . . .	7	□ High Voltage Battery . . . . .	14
□ Hybrid Operation . . . . .	7	□ Disposal Of High Voltage Battery . . . . .	15
□ Hybrid Vehicle Operating Characteristics . . . . .	10	□ High Voltage Battery Service Disconnect . . . . .	15
□ Driving To Achieve Maximum Fuel Economy . . . . .	11	□ Charge Assist — High Voltage Battery . . . . .	16
■ Important Hybrid System Information . . . . .	12	□ In The Event Of An Accident . . . . .	16

### A WORD ABOUT YOUR KEYS

It is not recommended to leave the ignition switch in the ACC position for extended periods of time. This will discharge the 12-Volt battery and may degrade the battery life and/or prevent the vehicle from starting. For information on using the vehicles accessories (radio, video system or power outlets) refer to "Electrical Power Outlets" in Section 3 of this supplement.

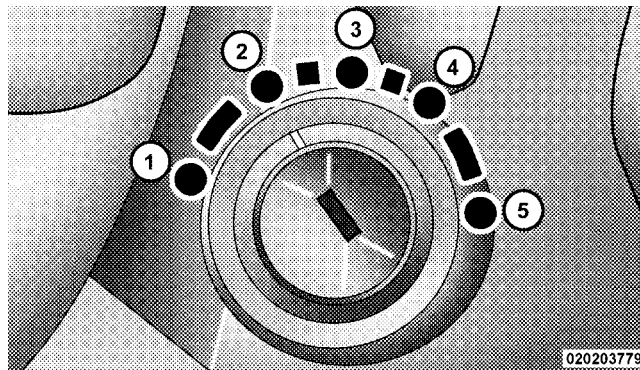

**Ignition Switch Positions**

- |          |            |
|----------|------------|
| 1 — ACC  | 4 — ON/RUN |
| 2 — LOCK | 5 — START  |
| 3 — OFF  |            |



## HYBRID SYSTEM OPERATION

Your Hybrid vehicle combines the power of a gasoline engine and electric motors to minimize fuel consumption and emissions. This vehicle requires no special fuels and never has to be plugged in to recharge. Understanding the unique characteristics of your vehicle will help ensure maximum performance and best fuel economy from your vehicle.

Your Hybrid vehicle is also equipped with two electrical voltage systems. A 12-Volt system which is used to power the conventional electrical system and a high voltage system which is used to power the motors in the 2-Mode Hybrid Transmission as well as other high voltage system components.

### Hybrid Operation

#### Shifting

You must press the brake pedal fully before shifting out of PARK. During this first brake application, the brake

system is undergoing a self-test function. The brake pedal travel will be longer than usual. This is normal. Press firmly on the brake to prevent rolling. Refer to “Regenerative Braking System” under “Hybrid Vehicle Unique Operating Characteristics” in this Section for further information.

#### Driving

When the “READY” light is illuminated the gas engine can shut off automatically to save on fuel, and start automatically to provide power when it is needed. While coasting at low speeds, coming to a stop or standing still, the gas engine will normally shut off and the vehicle will operate on electric power only. Conditions that may cause the gas engine to start up or remain running include:

- Moderate or rapid acceleration
- Vehicle speed

## 8 THINGS TO KNOW BEFORE STARTING YOUR VEHICLE

- Climbing a hill
- Charge level of high voltage battery
- Engine temperature, transmission temperature or coolant temperature
- Hybrid System malfunction (Hybrid service lamp on)
- Tow/Haul activated
- Hood is ajar
- Shift lever position 2 or 1

**NOTE:** The gas engine can also automatically shut off with the shift lever in PARK, REVERSE, DRIVE or NEUTRAL.

### **Stopping In Traffic With Auto Stop/Start Function**

The gas engine may shut off as you decelerate to a stop, this is normal and will conserve fuel at idle. Restarting the vehicle is not necessary.

When you desire to move forward with traffic flow, simply press the accelerator pedal and continue accelerating from idle up to your cruising speed. The gas engine will restart and shut down again automatically when commanded by the Hybrid System. Shutting down and restarting (cycling) of the gas engine during low speed traffic conditions less than 30 mph (48 km/h) is normal.

### **Re-Starting A Warm Engine**

Your Hybrid vehicle is equipped with "Silent Start" fuel saving technology. The decision to enable the gas engine on a restart is automatically determined by the Hybrid System.

Under certain conditions, the gas engine will not start (usually when restarting a warmed-up engine that has recently been parked) when the ignition key is inserted and turned to the START position. This is normal and is considered a "Silent Start". When the ignition key is released to the ON/RUN position you will observe the

green "READY" light illuminated in the instrument cluster, but, again, the gas engine is not running. When you experience a "Silent Start" leave the key in the ON/RUN position, then simply place your foot on the brake pedal, move the shift lever into REVERSE or DRIVE and press the accelerator pedal to drive the Hybrid vehicle in the electric mode.

### 2-Mode Hybrid Transmission Operation

The 2-Mode Hybrid Transmission combines two electric motors with four fixed gear ratios within a single transmission housing. The electric motors can be used for electric-only propulsion, boosting the internal combustion engine or providing regenerative braking.

The 2-Mode Hybrid Transmission will select one of the four fixed gear ratios, or operate as an electrically variable transmission (variable ratio or EVT) depending on driver input, vehicle speed and loading.

Unlike a conventional transmission, the 2-Mode Hybrid Transmission can propel the vehicle without the engine running during low speed, light load operation (electric only mode).

**NOTE:** Your Hybrid vehicle can be run through typical commercial car wash facilities. There are some precautions that you should keep in mind.

- When entering an automatic/conveyor style car wash facility, it is important that the driver follow the attendant's or posted instructions and that your shift lever is shifted to NEUTRAL when instructed.
- A Hybrid vehicle that is in REVERSE or DRIVE with the "READY" light illuminated and gas engine stopped, is NOT a substitute for the NEUTRAL position.

**CAUTION!**

**Car wash equipment damage, vehicle damage or a potential accident event could result if the car wash facility instructions for PARK, NEUTRAL, DRIVE and REVERSE are not followed.**

**Hybrid Vehicle Operating Characteristics**

Your Hybrid vehicle operates differently compared to a Non-Hybrid vehicle. The following is a description of the major differences:

**Regenerative Braking**

Your Hybrid vehicle has a Regenerative Braking System (RBS). The RBS increases the fuel economy of the vehicle, particularly in stop-and-go city traffic. The electric motors which propel the vehicle forward can operate as generators when braking. The RBS recharges the high voltage battery under certain braking conditions by recapturing energy that would otherwise be lost while

braking. The electric power that is generated goes back into the high voltage battery for later use, for example when acceleration is desired.

The RBS uses conventional hydraulic friction brakes, regenerative braking, or a combination to slow the vehicle. The Hybrid power gauge indicates the amount of regenerative braking. If the system detects slippery conditions while braking, mainly friction is used to slow the vehicle. The RBS can result in extended life of the hydraulic service brakes; however, all inspection, scheduled maintenance, and service intervals for the vehicle service brakes must be followed.

**NOTE:** Lighter brake pedal efforts and longer brake pedal travel are normal Hybrid brake operations during the first brake application. After start-up, during the first brake application, the brake system undergoes a self-test

function. The brake pedal has a lighter effort (longer travel) than during normal driving but provides full power assist.

### **Climate Control (HVAC System)**

Your Hybrid vehicle uses automatic temperature control (ATC) HVAC system with specialized components. This HVAC system utilizes a humidity sensor, cabin infrared (IR) sensor, sun sensor, and ambient temperature sensor to choose operation mode and control cabin comfort. Your Hybrid vehicle also uses a heater auxiliary pump to provide heat to the cabin while the vehicle is in electric mode. The electrically driven AC compressor is not connected to the engine like a standard gas vehicle. These components allow the control to operate the HVAC system in a very efficient manner to save fuel.

**NOTE:** It is recommended the vehicle be operated with the air conditioning (AC) on in high ambient temperatures as the high voltage battery is cooled by the cabin air.

### **Driving To Achieve Maximum Fuel Economy**

Your fuel economy should improve throughout your Hybrid vehicle's break-in period. As with any vehicle, fuel economy can be significantly impacted by your driving style and accessory usage. For best results, keep in mind the following:

#### **Tire Inflation**

Keep tires properly inflated and only use the recommended size. Refer to "Tire and Loading Information Placard" under "Tires Safety Information" in Section 5 of your Owner's Manual.

#### **Driving Style**

Aggressive driving increases the amount of energy required to move your vehicle. In general, better fuel economy is achieved with mild to moderate acceleration and deceleration.

## 12 THINGS TO KNOW BEFORE STARTING YOUR VEHICLE

Moderate braking is particularly important since it allows you to maximize the energy converted and stored from the vehicle's momentum by the Regenerative Braking System (RBS).

### *Additional Tips:*

- Observe posted speed limits.
- Do not carry extra loads, when it is not necessary.
- Perform all scheduled maintenance.

### **IMPORTANT HYBRID SYSTEM INFORMATION**

Before operating your new Hybrid vehicle, be sure to read the following information.

### **Hybrid System Components**

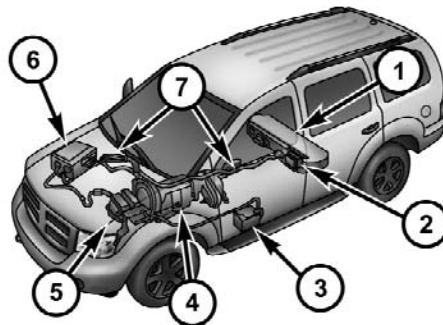

023106374

- |  |   |
|--|---|
| 1 — High Voltage Battery (located under the second row seat)   | 5 — Underhood Fuse Boxes and Integrated Power Module              |
| 2 — High Voltage Battery Service Disconnect                    | 6 — Traction Power Inverter Module (TPIM) (Hybrid Control Module) |
| 3 — 12-Volt Battery (located under drivers side running board) | 7 — High Voltage Cables (Orange Colored)                          |
| 4 — 2-Mode Hybrid Transmission                                 |   |

Additional Hybrid System electrical components:

- Electric Power Steering Pump (12-Volt)
- Electric A/C Compressor

### **WARNING!**

Your vehicle has both a high voltage DC and AC system as well as a 12-Volt system. DC and AC high voltage are both extremely dangerous and can cause severe burns, electric shock, serious injury or even death. In order to avoid personal injuries:

- **DO NOT TOUCH THE HIGH VOLTAGE CABLES (ORANGE COLORED) AND THEIR CONNECTORS.**
- **Do not drill or probe the HIGH VOLTAGE CABLES (ORANGE COLORED).**

*(Continued)*

### **WARNING! (Continued)**

- **Follow all Caution and Warning Labels attached to the high voltage (Hybrid System) components.**
- **Do not remove or replace any of the Hybrid System (high voltage) components. All replacement or repairs of Hybrid System components should be performed at an authorized dealer.**

### High Voltage Battery

Your Hybrid vehicle is equipped with a maintenance free Nickel Metal-Hydride (NiMH) battery rated at approximately 300-Volts. The high voltage battery is located under the second row seat.

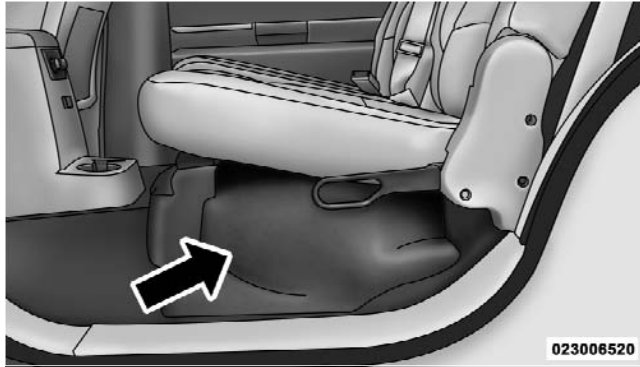

High Voltage Battery Location

The high voltage battery has an internal electric fan and an interior air inlet to keep the battery cool.

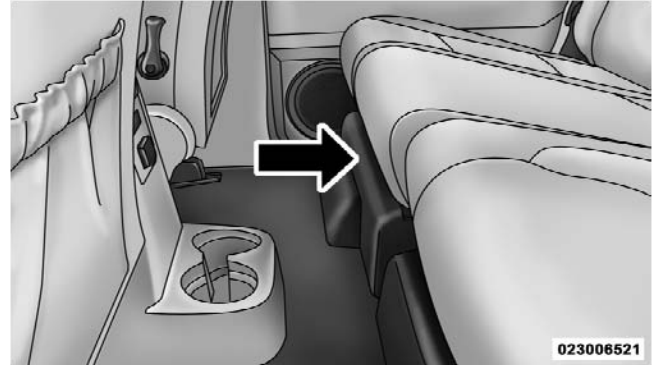

Air Inlet



**NOTE:**

- Be sure to keep the battery air inlet vent (located within the interior of the vehicle along the front of the second row seats) free from blockage to avoid overheating the high voltage battery.
- Stow all cargo, parcels, and luggage securely fastened in the rear of vehicle and not along the second row seat floor.

If your vehicle is parked for 2–3 months, the high voltage battery will discharge gradually. To keep the high voltage battery in good operating condition, drive the vehicle at least once every several months for a minimum of 30 minutes or 10 miles (16 km) or until the high voltage battery has been completely recharged. Refer to “Hybrid Gauge” and “Hybrid Energy Center” in Section 4 of this supplement for further information.

If the high voltage battery becomes fully discharged and the vehicle will not start, refer to “Jump-Starting Procedures” in Section 6 of this supplement. If the engine fails to start after following the appropriate “Jump-Starting Procedures” see your authorized dealer.

**Disposal of High Voltage Battery**

Your vehicle’s high voltage battery is designed to last the life of your vehicle. Should the battery require replacement, see your authorized dealer for information on the disposal of the high voltage battery, or on the internet at <http://www.high-voltage-battery-recycling.com>

**High Voltage Battery Service Disconnect**

The high voltage battery service disconnect is located behind a trim panel on the driver’s side second row seat. If your vehicle requires service see your authorized dealer.

**NOTE:** Always make sure the trim panel is securely attached at all times.

**WARNING!**

Never try to remove the high voltage service disconnect. The high voltage service disconnect is used when your vehicle requires service by a trained technician at an authorized dealer. Failure to follow this warning can cause severe burns or electrical shock that may result in serious injury or death.

**Charge Assist — High Voltage Battery**

The “Charge Assist” procedure allows you to charge the high voltage battery using the 12-Volt battery system. If the high voltage battery’s state of charge is too low and the engine will not crank, the MyGIG radio will display a “Charge Insufficient” message. For additional information, refer to the “Charge Assist Procedure — High Voltage Battery” in Section 6 of this supplement.

**In The Event Of An Accident**

If your Hybrid vehicle is involved in an accident, if possible, pull the vehicle off the road to a safe location, put the shift lever in PARK and remove the ignition key.

**NOTE:**

- If your vehicle is involved in an accident causing the airbags to deploy, your vehicle will not start. See your authorized dealer.
- If your vehicle needs to be towed, always use a flatbed truck. For additional information, refer to “Towing A Disabled Vehicle” in Section 6 of this supplement.

**WARNING!**

- In order to avoid personal injuries or death, DO NOT TOUCH ANY EXPOSED HIGH VOLTAGE WIRING (ORANGE COLORED) inside or outside of your vehicle, an electric shock may occur. NEVER TOUCH THE ELECTRIC WIRING.
- If fluid is leaking on the ground or leaks in some parts of the vehicle, never touch it because it may be Electrolyte (strong alkali) from the high voltage battery. If it gets on your skin or in your eyes, wash it off immediately with large amounts of water, and get immediate medical attention.
- If a vehicle fire occurs, extinguish it using a fire extinguisher that is used exclusively for electrical fires. Or use large amounts of water to prevent flammable gas from being generated from the batteries.



---

# UNDERSTANDING THE FEATURES OF YOUR VEHICLE

## CONTENTS

---

■ Electrical Power Outlets . . . . .	20
--------------------------------------	----

## ELECTRICAL POWER OUTLETS

Using the vehicles accessories (radio, video system or power outlets) can discharge the 12-Volt battery, degrade the battery life and/or prevent the vehicle from starting. It is recommended to limit the use of the ACC mode to approximately 15 minutes to avoid discharging the 12-Volt battery. Refer to "Electric Power Outlets" in Section 3 of the Owner's Manual for more information on using the Electrical Power Outlets.

### NOTE:

- If the voltage light (located in the instrument cluster) illuminates when using the accessories, the vehicle should be started and driven to recharge the 12-Volt battery. Refer to "Starting and Operating" in Section 5 of this Supplement for further information.
- All accessories connected to these outlets should be removed or turned off when the vehicle is not in use to protect the 12-Volt battery against discharge.

### CAUTION!

- Many accessories that can be plugged in draw power from the vehicle's 12-Volt battery, even when not in use (i.e., cellular phones, etc.). Eventually, if plugged in long enough, the vehicle's battery will discharge sufficiently to degrade battery life and/or prevent engine starting.
- Accessories that draw higher power (i.e., coolers, vacuum cleaners, lights, etc.) will discharge the 12-Volt battery even more quickly. Only use these intermittently and with greater caution.
- After the use of high power draw accessories or long periods of the vehicle not being started (with accessories still plugged in), the vehicle must be driven a sufficient length of time to allow the generator to recharge the vehicle's batteries.

# UNDERSTANDING YOUR INSTRUMENT PANEL

## CONTENTS

---

■ Hybrid Instrument Cluster . . . . .	22	□ Level Of Automatic Control . . . . .	44
■ Instrument Cluster Description . . . . .	23	□ Manual Control (ATC) . . . . .	44
■ Hybrid Gauge . . . . .	35	□ Rear Zone Climate Control . . . . .	48
■ Hybrid Energy Center . . . . .	36	□ Rear Rotary Temperature Control . . . . .	49
□ Hybrid System Operating Conditions . . . . .	36	□ Front Unit To Rear Unit Chart . . . . .	50
■ Climate Controls . . . . .	42	□ Operating Tips . . . . .	50
□ Automatic Temperature Control (ATC) . . . . .	42	□ Operating Tips Chart . . . . .	53
□ Automatic Control . . . . .	43		

## HYBRID INSTRUMENT CLUSTER

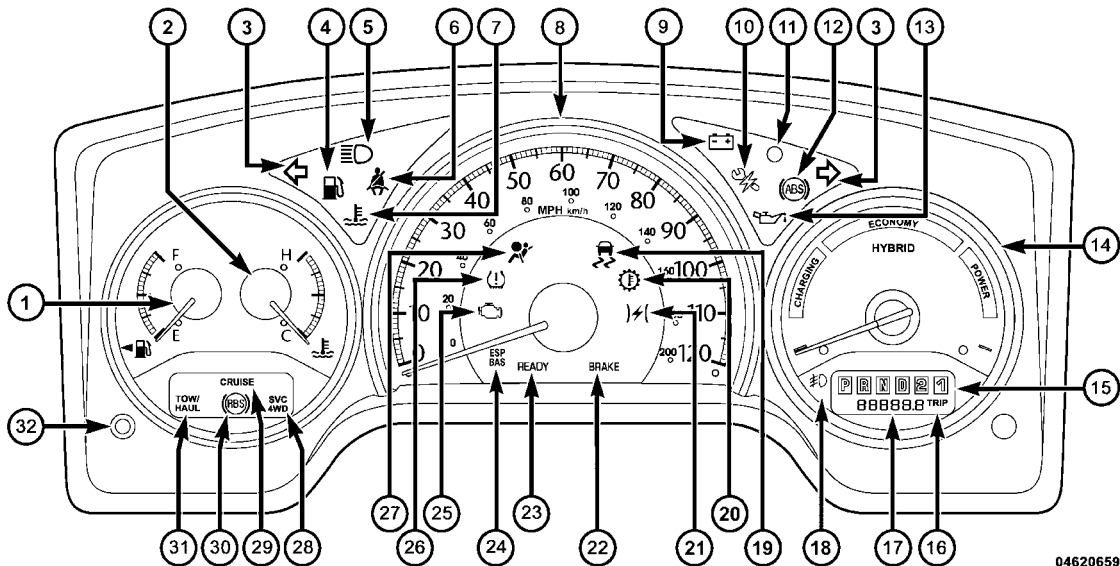

046206596



## INSTRUMENT CLUSTER DESCRIPTION

### 1. Fuel Gauge

The fuel gauge shows the level of fuel in the tank when ignition switch is in the ON position.

### 2. Temperature Gauge

The temperature gauge indicates engine coolant temperature. Any reading within the normal range indicates that the cooling system is operating satisfactory. The temperature gauge will likely indicate a high temperature when driving in hot weather, up mountain grades, in heavy traffic or when towing a trailer. If the temperature gauge rises to the "H" mark, stop the vehicle, and shift into NEUTRAL, press the TOW/HAUL button and increase engine speed for two to three minutes. If the temperature reading does not return to normal, see your authorized dealer for service immediately.

## CAUTION!

**Do not leave your vehicle unattended with the engine running as you would not be able to react to the temperature reading if the engine overheats.**

The temperature gauge will remain near its last reading when the ignition is turned OFF. It will return to a true reading when the engine is restarted.

**4**

### 3. Turn Signal Indicators

When a turn signal is activated, right-pointing or left-pointing arrows illuminate and flash to indicate the direction of the turn. These indicators also indicate proper operation of the front and rear turn signal lights. If either indicator flashes at a faster rate than normal, check for a defective bulb. If either indicator fails to light up when the multifunction lever is moved, check for a defective fuse or turn signal LED. A single chime is

activated when the left/right turn signal is left on with the engine RPM vehicle speed greater than 15 mph (24 km/h) for more than 1 mile (1 km).

#### 4. Low Fuel Light



This indicator illuminates when the fuel gauge reads 1/16 of a tank or less.

After the Low Fuel Warning Light turns on, some changes in driveability like reduced power and high idle may be experienced. When the vehicle completely runs out of fuel, the Hybrid System will turn off and the vehicle will stop running.

**NOTE:** The ignition must be OFF for a minimum of five minutes prior to restarting the engine once the vehicle has been refueled.

#### 5. High Beam Indicator



This indicator illuminates when the High beam headlights are on.

#### 6. Seat Belt Reminder Light



This light comes on for several seconds after the ignition is turned ON as a reminder to “buckle up.” This light will remain on as long as the seat belt remains unbuckled. If this light flashes, it indicates a fault in the airbag system. Have the system checked by your authorized dealer.

#### 7. Coolant Temperature Light



This light warns of an overheated engine condition. For a bulb check, this light will come on momentarily when the ignition is turned ON. If the light turns on while driving, stop the vehicle, shift into NEUTRAL, press the TOW/HAUL button and increase the engine speed for two to three minutes. If the temperature reading does not return to normal, see your authorized dealer for service immediately.

**CAUTION!**

Driving with a hot engine cooling system could damage your vehicle. If the temperature light is on, safely pull over and stop the vehicle. Press the TOW/HAUL button and idle the vehicle in NEUTRAL with the air conditioner turned off until the light turns off. If the light remains on, turn the engine off immediately and call for service.

**WARNING!**

A hot engine cooling system is dangerous. You or others could be badly burned by steam or boiling coolant. You may want to call a service center if your vehicle overheats. If you decide to look under the hood yourself, see Section 7 of your Owner's Manual. Follow the warnings under the "cooling system pressure cap" paragraph.

**8. Speedometer**

The speedometer shows the speed of the vehicle.

**9. Voltage Light**

This light should turn on momentarily as the engine is started. If the light stays on or turns on while driving, it indicates a problem with the 12-Volt electrical system. See your authorized dealer for service immediately.

**10. HEV Service Light**

This light indicates that the Hybrid System requires service. See your authorized dealer.

**11. Vehicle Security Light**

This light will flash rapidly for approximately 15 seconds when the Vehicle Security Alarm is arming. The light will flash at a slower speed continuously after the alarm is set.

The Vehicle Security Light will also illuminate for approximately three seconds when the ignition is first turned ON.

### 12. *Anti-Lock Brake (ABS) Warning Light*



This light monitors the Anti-Lock Brake System (ABS) which is described in the Owner's Manual. This light will come on when the ignition key is turned to the ON position and may stay on for approximately three seconds. If this light remains on or comes on during driving, it indicates that the Anti-Lock portion of the brake system is not functioning and that service is required. See your authorized dealer immediately. With the ABS malfunctioning, the Brake Assist System (BAS) and Electronic Stability Program (ESP) are also switched off. Both malfunction indicator lights illuminate with the engine running. If the charging voltage falls below 10-Volts, the malfunction indicator light illuminates and the ABS is switched off.

When the voltage is above this value again, the malfunction indicator light should go out and the ABS is operational. If the malfunction indicator light stays illuminated, have the system checked at your authorized dealer as soon as possible.

### 13. *Oil Pressure Warning Light*



This light indicates that the engine oil pressure has become too low. For a bulb check, this light will illuminate momentarily when the ignition is turned ON. If the light comes on while driving, stop the vehicle and shut off the engine as soon as possible. See your authorized dealer for service immediately.

### 14. *Hybrid Gauge*

This gauge indicates in what mode the vehicle is being operated. Refer to "Hybrid Gauge" under "Instrument Panel And Controls", in this Section of the supplement.

### 15. *Shift Lever Indicator*

The electronic shift lever indicator is self-contained within the instrument cluster. It displays the position of the transmission shift lever, and the relation of each position to all other positions. For a good signal the display will place a box around the selected transmission range (PRND21). If the PRND21 displays all characters boxed, have the system checked by an authorized dealer.

### 16. *Trip Odometer*

The trip odometer shows an individual trip mileage. To switch from odometer to trip odometer, press and release the trip odometer button.

To reset the trip odometer, display the trip odometer then push and hold the TRIP button until the display resets (approximately two seconds).

### *Engine Run Time*

Engine run time shows the elapsed time that the gasoline engine has run. While viewing the odometer reading

press and hold the TRIP button for approximately eight seconds and the engine run time will be displayed.

### *Vehicle Warning Messages*

For non-Electronic Vehicle Information Center (EVIC) equipped vehicles, when the appropriate conditions exist, messages such as “door ajar” (indicates that a door(s) may be ajar), “gASCAP” (which indicates that your gas cap is possibly loose or damaged), “CHANgE OIL” (indicates that the engine oil should be changed), “Lo-WASH” (low washer fluid), and “noFUSE” (indicates that the IOD fuse is removed from the Integrated Power Module), will display in the odometer.

**NOTE:** If the vehicle is equipped with an EVIC, most warnings will display in the EVIC. For additional information, refer to “Overhead Console With Electronic Vehicle Information Center (EVIC) — If Equipped” in Section 4 of the Owner’s Manual.

The outside temperature will display in the odometer for non-EVIC equipped vehicles. Pressing the trip odometer RESET button toggles the feature back to the odometer.

### *Change Oil Message*

Your vehicle is equipped with an engine oil change indicator system. The “Change Oil” message will flash in the instrument cluster odometer for approximately 12 seconds after a single chime has sounded to indicate the next scheduled oil change interval. The engine oil change indicator system is duty cycle based, which means the engine oil change interval may fluctuate dependent upon your personal driving style.

Unless reset, this message will continue to display each time you turn the ignition switch to the ON/RUN position. To turn off the message temporarily, press and release the Trip Odometer button on the instrument

cluster. To reset the oil change indicator system (after performing the scheduled maintenance) refer to the following procedure.

1. Turn the ignition switch to the ON position (**Do not start the engine**).
2. Fully press the accelerator pedal, slowly, three times within 10 seconds.
3. Turn the ignition switch to the OFF/LOCK position.

**NOTE:** If the indicator message illuminates when you start the vehicle, the oil change indicator system did not reset. If necessary repeat this procedure.

### *17. Odometer*

The odometer shows the total distance the vehicle has been driven.

U.S. Federal regulations require that upon transfer of vehicle ownership, the seller certify to the purchaser the correct mileage that the vehicle has been driven. Therefore, if the odometer reading is changed during repair or replacement, be sure to keep a record of the reading before and after the service so that the correct mileage can be determined.

### 18. Fog Light Indicator

 This light illuminates when the fog lights are on.

### 19. Electronic Stability Program (ESP) Indicator Light



The yellow ESP indicator light in the speedometer area illuminates with the key in the ignition switch turned to the ON/RUN position. It should go out with the engine running. The ESP/TCS indicator light starts to flash as soon as the tires lose traction and the ESP system becomes active. The ESP/TCS indicator light also flashes when TCS is active

as well as when the ABS is active. If the ESP/TCS indicator light begins to flash during acceleration, ease up on the accelerator and apply as little throttle as possible. Be sure to adapt your speed and driving to the prevailing road conditions. The ESP/TCS indicator light becomes illuminated when the ESP-OFF button has been pressed or ESP is only partially available, caused by lack of engine management or brake thermal model.

### 20. Transmission Temperature Indicator



This light indicates that there is excessive transmission fluid temperature that might occur with severe usage, such as trailer towing. If this light comes on, stop the vehicle, press the TOW/HAUL button, and run the engine at idle or faster with the transmission in NEUTRAL until the light goes off.

### 21. *Electronic Throttle Control (ETC)*



This light informs you of a problem with the Electronic Throttle Control (ETC) system. If a problem is detected, the light will come on while the engine is running. If the light remains on with the engine running your vehicle will usually be drivable, however, see your authorized dealer for service as soon as possible. If the light is flashing when the engine is running, immediate service is required and you may experience reduced performance, an elevated/rough idle or engine stall and your vehicle may require towing. The light will illuminate when the ignition is first turned ON and remain on for 15 seconds as a bulb check. If the light does not come on during starting, have the system checked by your authorized dealer.

### 22. *BRAKE Warning Light*

The red "BRAKE" warning light will illuminate when the ignition key is first turned ON, and stay on briefly as a bulb check. If the bulb does not illuminate on start-up,

have the bulb repaired promptly. If the light stays on, it may be an indication that the parking brake has not been released, or there is a low brake fluid level. If the light remains on when the parking brake has been disengaged, and the fluid level is at the full mark on the master cylinder reservoir, it indicates a possible brake hydraulic system malfunction or a problem with the brake booster. In this case, the light will remain on until the condition has been corrected. If the problem is related to the brake booster, the ABS pump will run when applying the brake.

If the parking brake is applied, the light will flash when the shift lever is out of PARK for automatic transmissions.

If the light comes on while driving, pull over immediately. Do not drive the vehicle. Have the vehicle towed to the nearest authorized dealer.

**If brake failure is indicated, immediate repair is necessary. Operating the vehicle in this condition is dangerous!**



### 23. *READY*

When the ignition key is turned to the START position, the “READY” lamp in the cluster will illuminate to indicate the Hybrid System has “started”. When the “READY” lamp is illuminated, your Hybrid vehicle can be driven under electric power even though the internal combustion engine may not be running.

### 24. *Electronic Stability Program (ESP) Indicator Light/Brake Assist System (BAS) Warning Light*

**ESP  
BAS** The malfunction lamp for the Electronic Stability Program (ESP) is combined with Brake Assist System (BAS). The yellow “ESP/BAS Warning Lamp” comes on when the ignition switch is turned to the ON position. They should go out with the engine running. If the “ESP/BAS Warning Lamp” comes on continuously with the engine running, a malfunction has been detected in either the ESP or the BAS system. If this light remains on after several ignition

cycles, and the vehicle has been driven several miles/kilometers at speeds greater than 30 mph (48 km/h), see an authorized dealer as soon as possible.

### 25. *Malfunction Indicator Light (MIL)*



The Malfunction Indicator Light (MIL) is part of an Onboard Diagnostic system (OBD II) which monitors the emissions and engine/hybrid control system. If the vehicle is ready for emissions testing the light will come on when the ignition is first turned ON and remain on, as a bulb check, until the engine is started. If the vehicle is not ready for emissions testing the light will come on when the ignition is first turned ON and remain on for 15 seconds, then blink for 10 seconds, and remain on until the vehicle is started. If the bulb does not come on during starting, have the condition investigated promptly.

If this light comes on and remains on while driving, it suggests a potential engine control problem and the need for system service. See your authorized dealer as soon as possible.

Although your vehicle will usually be drivable and not need towing, see your authorized dealer for service as soon as possible.

### CAUTION!

- **Prolonged driving with the MIL on could cause damage to the engine control system. It also could affect fuel economy and driveability.**
- **If the MIL is flashing, severe catalytic converter damage and power loss will soon occur. Immediate service is required. See your authorized dealer for service immediately.**

### 26. *Tire Pressure Monitoring Telltale Light*



Each tire, including the spare (if provided), should be checked monthly when cold and inflated to the inflation pressure recommended by the vehicle manufacturer on the vehicle placard or tire inflation pressure label. (If your vehicle has tires of a different size than the size indicated on the vehicle placard or tire inflation pressure label, you should determine the proper tire inflation pressure for those tires.)

As an added safety feature, your vehicle has been equipped with a Tire Pressure Monitoring System (TPMS) that illuminates a low tire pressure telltale when one or more of your tires are significantly under-inflated. Accordingly, when the low tire pressure telltale illuminates, you should stop and check your tires as soon as possible, and inflate them to the proper pressure. Driving on a significantly under-inflated tire causes the tire to overheat and can lead to tire failure. Under-inflation also

reduces fuel efficiency and tire tread life, and may affect the vehicle's handling and stopping ability.

Please note that the TPMS is not a substitute for proper tire maintenance, and it is the driver's responsibility to maintain correct tire pressure, even if under-inflation has not reached the level to trigger illumination of the TPMS low tire pressure telltale.

Your vehicle has also been equipped with a TPMS malfunction indicator to indicate when the system is not operating properly. The TPMS malfunction indicator is combined with the low tire pressure telltale. When the system detects a malfunction, the telltale will flash for

approximately one minute and then remain continuously illuminated. This sequence will continue upon subsequent vehicle start-ups as long as the malfunction exists. When the malfunction indicator is illuminated, the system may not be able to detect or signal low tire pressure as intended. TPMS malfunctions may occur for a variety of reasons, including the installation of replacement or alternate tires or wheels on the vehicle that prevent the TPMS from functioning properly. Always check the TPMS malfunction telltale after replacing one or more tires or wheels on your vehicle to ensure that the replacement or alternate tires and wheels allow the TPMS to continue to function properly.

**CAUTION!**

The TPMS has been optimized for the original equipment tires and wheels. TPMS pressures and warning have been established for the tire size equipped on your vehicle. Undesirable system operation or sensor damage may result when using replacement equipment that is not of the same size, type, and/or style. Aftermarket wheels can cause sensor damage. Do not use tire sealant from a can, or balance beads if your vehicle is equipped with a TPMS, as damage to the sensors may result.

**27. Airbag Warning Light**

This indicator illuminates and remains on for six to eight seconds when the ignition is first turned ON. If the light does not come on when the ignition is first turned ON, or the light stays on or comes on while driving, have the airbag system checked by an authorized dealer.

**28. SVC (Service) 4WD Indicator**

The SVC 4WD lights will come on when the ignition key is turned to the ON position and will stay on for two seconds. If the light stays on or comes on during driving, it means that the 4WD system is not functioning properly and that service is required. See your authorized dealer.

**29. Cruise Light (Electronic Speed Control)**

This indicator lights when the Electronic Speed Control system is turned on.

**30. Hybrid Regenerative Brake System Light**

This yellow light will illuminate for a few seconds when the ignition is turned to the ON position as a bulb check. If the light turns on and remains on while driving, it suggests that there is a potential problem with the Regenerative Brake System (RBS) and the need for system service. See your authorized dealer as soon as possible.

### 31. TOW/HAUL

The TOW/HAUL button is located at the end of the shift lever. This light will illuminate when the TOW/HAUL button has been selected. Refer to “When To Use TOW/HAUL Mode” under “2-Mode Hybrid Transmission Ranges” in Section 5 of this supplement for further information.

### 32. Odometer/Trip Odometer Button

Press this button to toggle between the odometer and the trip odometer display. Holding the button in resets the trip odometer reading.

## HYBRID GAUGE

The Hybrid Gauge, located on the instrument cluster, has three different zones to indicate how the vehicle is being operated in the sense of fuel savings.

**NOTE:** Driving with the gauge pointer in the 12 O'clock (ECONOMY) position is the optimal Hybrid location.

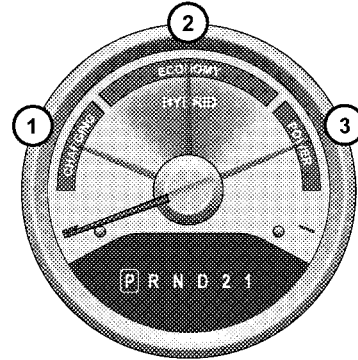

Hybrid Gauge

- 1 — CHARGING — Indicates that the high voltage battery is being charged during braking or certain driving conditions.
- 2 — ECONOMY — Indicates the HEV vehicle is being propelled forward in electric mode, Hybrid mode or Fuel Saver mode (MDS) which are the most fuel efficient modes of operation.
- 3 — POWER — indicates that the accelerator pedal is being applied for additional power which is not the most fuel efficient mode of operation.

## HYBRID ENERGY CENTER

### Hybrid System Operating Conditions

The Hybrid System performs various functions depending on the operating condition, such as starting the gas engine, when charging is required, etc.

The following Hybrid System information screens will be displayed on your vehicle's MyGIG radio based on the which mode the Hybrid System is operating in.

To access the Hybrid Energy Center press the "Menu" button on the radio screen then select "Hybrid Info".



System Ready

This screen will display when the vehicle has been started and the Hybrid System is active.

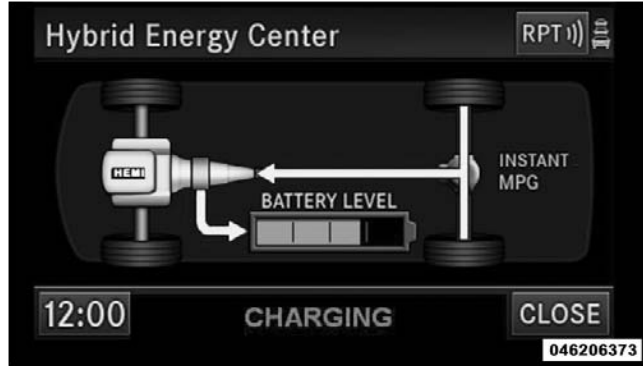

Charging — Engine Power

This display will appear when the vehicle is slowing down with the gasoline engine running and the high voltage battery is being charged. The engine will be illuminated on the radio screen.

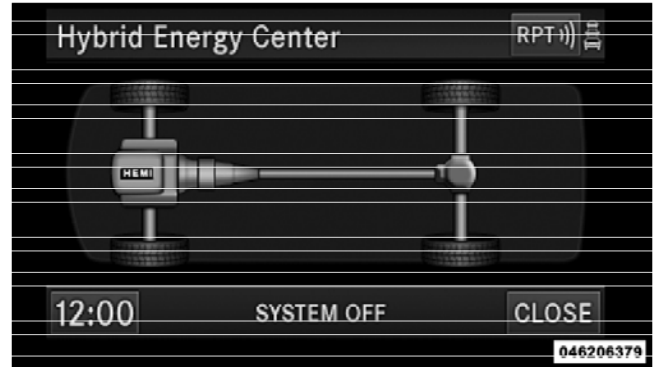

System Off

This display appears when the Hybrid system is off. The engine will not be illuminated on the radio screen.

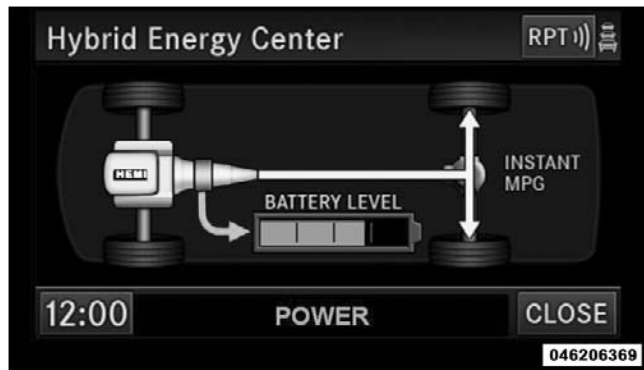

Engine Power

This display appears when the engine is at or near wide open throttle. The engine will be illuminated on the radio screen.

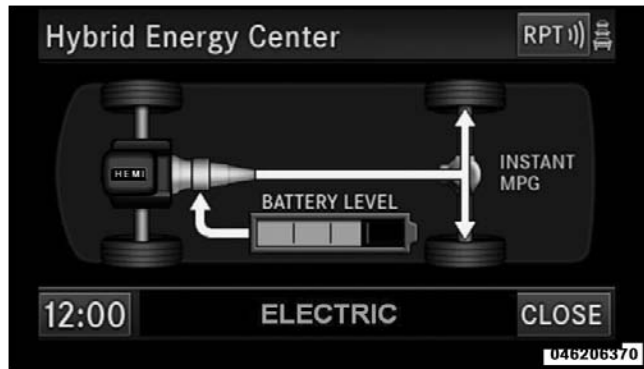

Battery Power



This display appears when the vehicle is driving in electric mode only. The engine will not be running or illuminated on the radio screen.

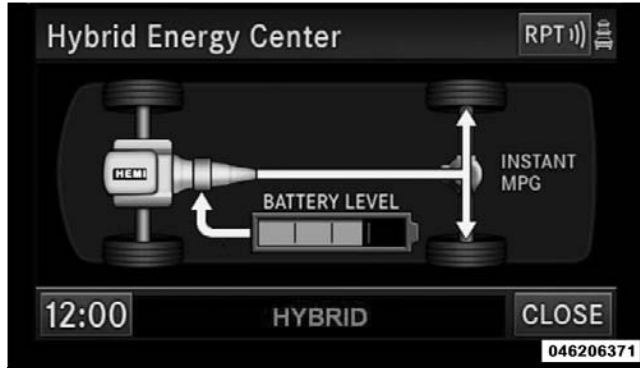

Engine And Battery Power

This display appears when the vehicle is driving in Hybrid mode (both the electric motors and gasoline engine running). The engine will be illuminated on the radio screen.

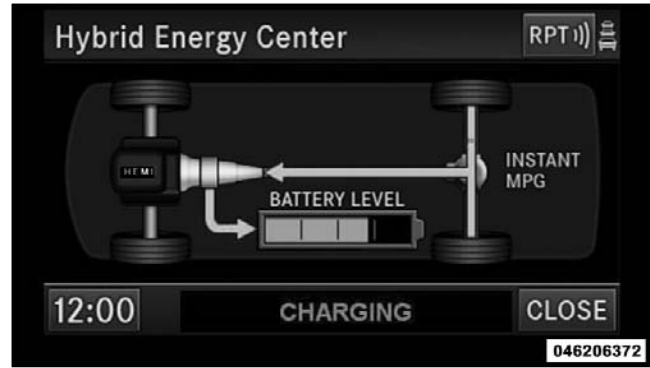

Charging Battery — Engine Off

This display appears when the high voltage battery is being charged during braking or coasting down and the engine is not running. The engine will not be illuminated on the radio screen.

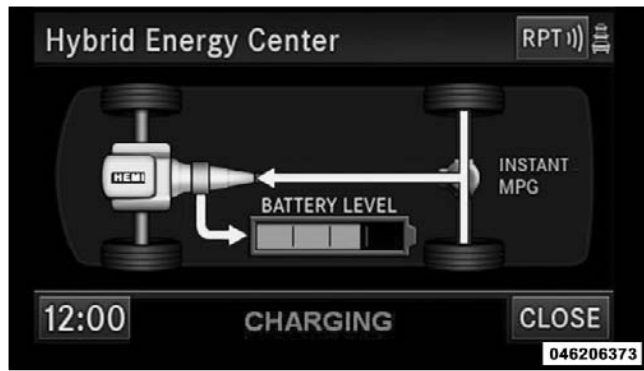

Charging Battery — Engine On

This display appears when the high voltage battery is being charged during braking or coasting down and the engine is running. The engine will be illuminated on the radio screen.

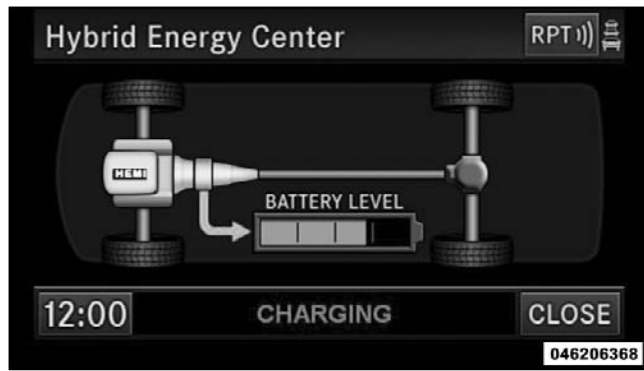

Charging — Engine Idling

This display appears when the engine is idling and the high voltage battery is charging. The engine will be illuminated on the radio screen.

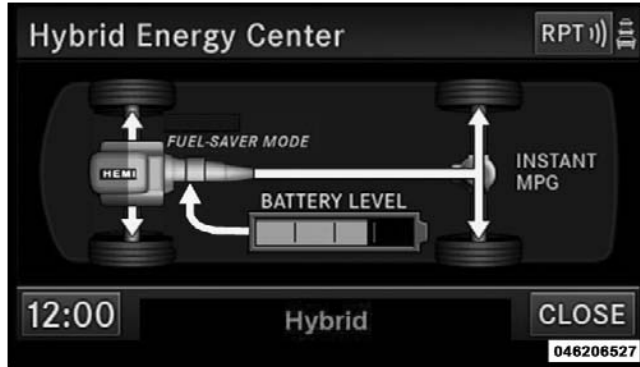

Fuel Saver Mode

This display appears when the vehicle is operating in Hybrid mode and the Multi-Displacement System (MDS) is active. Half of the engine will appear illuminated on the radio screen. Refer to “Multi-Displacement System (MDS)” in Section 5 of the Owner’s Manual for further information on MDS.

## CLIMATE CONTROLS

### Automatic Temperature Control (ATC)

The control can be turned on by pressing the power knob. When the control is turned on, it will be in the last mode prior to being turned off. Pressing the power knob a second time will turn off the control. The control can also be turned on by pressing any button and it will display the corresponding operation mode for that button.



819653f4

Automatic Temperature Control

## Automatic Control

The ATC system can maintain a steady comfort level in various weather conditions with a simple operation:

- Select your desired temperature setting by pressing the + or - side of the Temp rocker switches. A digital temperature setting for driver and passenger will be displayed. The ATC system uses an infrared sensor located in the overhead console to measure the temperature of the driver and passengers. Based on the sensor input, the system will automatically control comfort by varying the temperature, fan speed, and mode. This maintains a comfortable temperature, even under changing conditions. It is important that objects are not blocking the infrared sensor. It is also important that objects are not used that may scratch or damage it in any way.

The Hybrid vehicle also uses a humidity sensor to determine cabin comfort, improve system efficiency,

and reduce window fogging. This sensor is located behind the rearview mirror. Do not block airflow to the sensor. Use care not to spray the sensor with window cleaner.

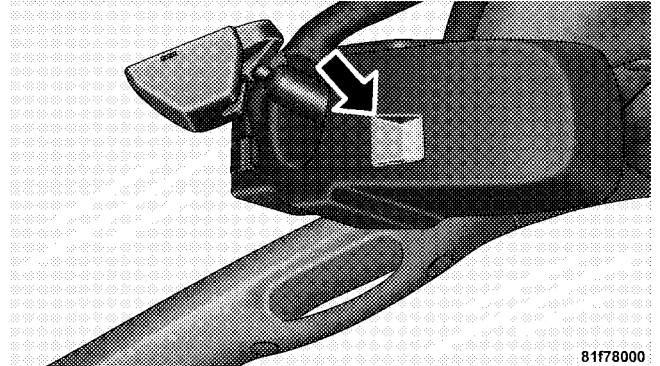

Humidity Sensor

### Level Of Automatic Control

72°F (22°C) is the recommended setting for maximum comfort for the average person, however, this may vary.

#### NOTE:

- The temperature setting can be adjusted at any time without affecting automatic control operation. It is not necessary to move the temperature setting for cold or hot vehicles. The system automatically adjusts the temperature, mode and fan speed to provide comfort as quickly as possible.
- In cold weather, the fan will not turn on in Auto mode until the engine coolant has warmed up sufficiently. This is indicated by the "WARM UP DELAY" message on the display.
- The temperature can be displayed in U.S. or Metric by selecting the U.S./METRIC Customer-Programmable feature. The mode will also be shown in the display

and will change as required during automatic operation. Refer to "Personal Setting (Customer-Programmable Features) under "Overhead Console With Electronic Vehicle Information Center (EVIC) — If Equipped" in Section 3 of the Owner's Manual.

- The system can be put into recirculate mode without affecting ATC operation. This will temporarily prevent outside air from entering the vehicle. Use this mode to block out any outside odors, smoke, or dust.

### Manual Control (ATC)

You may also choose to customize your comfort by selecting the fan speed and mode manually. Turning the fan speed knob or any mode button places the system into manual operation.

While in manual operation there are six fan speeds available and the choice of any mode. The airflow

temperature is adjusted automatically to maintain the desired comfort level. You can adjust the temperature by pressing the + or - Temp rocker switches.

### FAN Control

 Use this knob to regulate the amount of air delivered through the system in any mode you select. Rotation of the knob to increase (clockwise) or decrease (counterclockwise) fan speed.

### Air Conditioning Operation

 Press this button to enable the air conditioning system. Compressor operation is automatic when you press the AUTO button and no snowflake is shown. A snowflake indicates that the A/C system is enabled. The snowflake will not be displayed in AUTO mode even though the A/C system is enabled.

The compressor may operate at any temperature above 32°F (0°C).

### Recirculate Button

The Hybrid vehicle automatically uses a range of recirculation from all outside air to full recirculation (vehicle cabin air) to improve air conditioning efficiency. To request additional outside air push the recirculation button to turn the recirculation indicator on, then push the button again to cycle the indicator off. This will provide more fresh air to the cabin. Press the auto button to return to efficiency recirculation.



Press the RECIRC button to recirculate the air inside the vehicle. Outside air is temporarily prevented from entering the vehicle. Use this mode to block out any outside odors, smoke, dust or when rapid cooling of the interior is required.

Manual control of recirculation is possible only in Panel, Floor, and Bi-Level modes. It will not operate in Mix, or Defrost modes. The recirculation symbol will flash three times indicating recirculation is not available in these modes.

**NOTE:** If the interior of the windows begin to fog, press the RECIRCULATE button to return to outside air. Some conditions will cause captured interior air to fog windows when in recirculate mode. In the auto mode the humidity sensor may move the recirc setting to outside air to automatically clear the windows of fog.

### Panel

 Air flows through the outlets located in the instrument panel. These outlets can be adjusted to direct the airflow.

### Floor (Heat)

 Air flows primarily through the floor outlets located under the instrument panel. A small amount of air is directed through the defrost and side window demister outlets.

### Mix

 Outside air flows in equal proportions through the floor and defroster outlets.

### Bi-Level

 Air flows through the outlets located in the instrument panel and those located on the floor.

**NOTE:** There is a difference in temperature between the upper and lower outlets for added comfort. The warmer air goes to the floor outlets. This feature gives improved comfort during sunny but cool conditions.



## Defrost



Outside air is directed to the windshield through the defroster outlet located at the base of the windshield and side window demist outlets.

**NOTE:** The air conditioning compressor operates in both Mix and Defrost or a blend of these modes, even if the A/C snowflake button has not been pressed. This dehumidifies the air to help dry the windshield.

## Rear Temperature Control (ATC)

The REAR button cycles through the following modes:

### Rear Control From Front

This allows the driver or passenger to control the rear blower speeds rotating the Power/Fan knob and the rear temperature using the PASS/REAR Temp +/- rocker switch. While in this mode, pressing the POWER/FAN knob will turn the rear system off. Pressing the Power/Fan knob will turn the rear system back on.

**NOTE:** The display will show a "REAR" fan speed graph and a "REAR" digital temp setting.

## CONTROL IN REAR

This allows the passengers in the second row seats to control the blower speed and temperature by means of the rear control located in the rear of the center floor console as described under the "Rear Zone Climate Control."

**NOTE:** The front display will show "CONTROL IN REAR."

## REAR OFF

This turns the rear system off. The control will return to the front system display after approximately five seconds if no buttons are pushed while in one of the rear system displays. You may also return to the front system display sooner by pushing any button except the Power/Fan knob, the REAR button, or the driver/passenger Temp rocker buttons.

**NOTE:** The display will show "REAR OFF."

### AUTO REAR

This mode places the rear system in automatic temperature control. Rear temperature can be set as desired (72°F [22°C] recommended for average person) and will be displayed digitally on the front control when in rear mode.

### Rear Window Defrosting and Rear Window Washer/Wiper

Refer to “Rear Window Features” in Section 4 of the Owner’s Manual.

### Rear Zone Climate Control

Headliner air comes from the outlets in the headliner. Each of these outlets can be individually adjusted to direct the flow of air. Moving the air vane knobs on the outlets to one side will shut off the airflow.



Rear Outlets

The rear compartment control uses two rotary knobs: one for the temperature control and the other for the fan speed control. The mode for the rear air conditioning and heating system is always controlled by the front control unit. Fan and temperature can be controlled from the front control unit or the rear control unit.

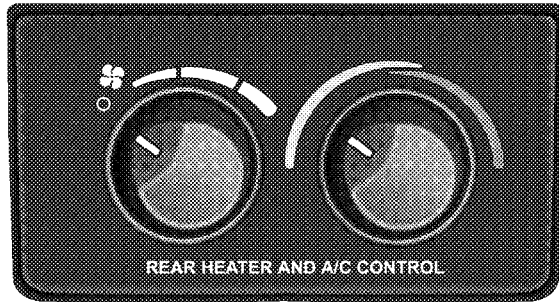

811aa87d

### Rear Compartment Controls

### Rear Rotary Blower Control

The second row seat occupants have control of the rear blower speed only when the front control unit is in the "CONTROL IN REAR" mode.

The rear blower switch has an OFF position and a range of blower speeds. Rotating the rear blower control clockwise will increase the blower speed.

4

### Rear Rotary Temperature Control

The second row seat occupants have control of the rear temperature only when the front control unit is in the "REAR CONTROL" position.

To change the temperature in the rear of the vehicle, rotate the temperature control knob to the right or left. The blue area indicates cooler temperatures while the red area indicates warmer temperatures.

**NOTE:** For best operation, make sure that ventilation grilles located in the rear storage area are not obstructed by stowed articles.

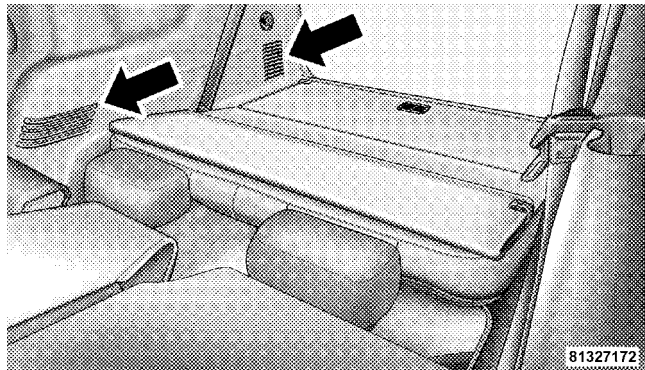

**Rear Storage Ventilation Grilles**

### Front Unit to Rear Unit Chart

If the Front Control is selected	Rear Airflow will come from
Panel	Headliner
Bi-Level	Headliner
Floor	Floor
Mix	Floor
Defrost	Floor

### Operating Tips

#### Fast Cooldown

It is recommended to use Auto mode to allow the control to make the mode and recirculation decisions for a fast cooldown. Drive with the windows down for the first few minutes to purge hot cabin air. To use manual mode follow the steps listed below for a fast cooldown.

For a fast cooldown, set the blower fan to the highest setting, set the mode control to the panel fresh position,

press the Snowflake button to turn on the air conditioning, and drive with the windows open for the first few minutes. Once the hot air has been expelled, close the windows and set the mode selector to the Recirculation panel or Recirculation Bi-level position. When a comfortable condition has been reached, choose a mode position and adjust the temperature control and blower speed as necessary to maintain comfort.

### **Window Fogging**

Windows will fog on the inside when the humidity inside the vehicle is high. This often occurs in mild or cool temperatures when it's rainy or humid. In most cases, turning on the air conditioning (pressing the snowflake button) will clear the fog. Adjust the temperature control, air direction and blower speed to maintain comfort. When the control is in Auto mode the humidity sensor will monitor cabin conditions and reduce interior fogging.

As the temperature gets colder it may be necessary to direct air onto the windshield by using Mix Mode position on the control. Adjust the temperature control and blower speed to maintain comfort. Interior fogging on the windshield can be quickly removed by selecting the defrost mode.

Regular cleaning of the inside of the windows with a non-filming cleaning solution (vinegar and water works very well) will help prevent contaminants (cigarette smoke, perfumes, etc.) from sticking to the windows. Contaminants increase the rate of window fogging.











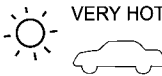

















### **Summer Operation**

Air conditioned vehicles must be protected with a high quality antifreeze coolant during Summer to provide proper corrosion protection and to raise the boiling point of the coolant for protection against overheating. A 50% concentration is recommended.

### **Winter Operation**

When operating the system during the Winter months, make sure the air intake, located directly in front of the windshield, is free of ice, slush, snow, or other obstructions. This will also prevent snow ingestion into the ducts.

## Operating Tips Chart

WEATHER	CONTROL SETTINGS
<p>HOT WEATHER AND VEHICLE INTERIOR IS VERY HOT</p> 	<p>Start the vehicle, open the windows and turn the blower control to the high position (use AUTO mode if equipped). Set Mode control at  or . Set Temperature control to full cold and press the  button on. After the hot air has been expelled, close the windows and set the Mode control to the  setting at either  or , or press the  button (if equipped). Once comfortable, choose a mode position and adjust temperature control and blower speed as necessary for comfort.</p>
<p>WARM WEATHER</p> 	<p>If sunny (use AUTO mode if equipped), set the Mode control at  and press the  button on. If cloudy or dark, set the Mode control at . No  is necessary.</p>
<p>COOL OR COLD HUMID CONDITIONS</p> 	<p>If sunny (use AUTO mode if equipped), set the Mode control at  or , then press the  button on. If cloudy or dark, set the Mode control at . No  is necessary.</p>
<p>COLD DRY CONDITIONS</p> 	<p>In cloudy or dark weather (use AUTO mode if equipped), set the Mode control at . If sunny, set the Mode control at  or , and for snowy or very cold weather requiring extra heat to the windshield, use .</p>
<p>WINDOW FOGGING</p> 	<p>In most cases turning on the Air-Conditioning (press the  button) will clear the fog. Adjust temperature control, air direction and blower speed to maintain comfort. As it gets colder, it may be necessary to direct air onto the windshield. If so, set the Mode control at  or  and adjust temperature control and blower speed to maintain comfort. Higher blower speeds will reduce fogging. If equipped with AUTO, you must manually press the Defrost button to clear fog. (Defrost mode is not a feature of the Automatic Temperature Control).</p> <p style="text-align: right;">819653ed</p>

## Operating Tips





# STARTING AND OPERATING

## CONTENTS

---

■ Starting Procedures . . . . .	56	□ MP 3010 “Active On Demand” Transfer Case . . . . .	62
□ Starting . . . . .	56	■ Power Steering . . . . .	63
■ 2-Mode Hybrid Transmission . . . . .	58	■ Electronic Brake Control System . . . . .	64
□ Brake/Transmission Interlock System . . . . .	58	□ Hill Start Assist (HSA) . . . . .	64
□ 2-Mode Hybrid Transmission Ranges . . . . .	58	■ Recreational Towing (Behind Motorhome, Etc.) . .	66
■ Four-Wheel Drive Operation . . . . .	62		

## STARTING PROCEDURES

Before starting your vehicle, adjust your seat, adjust both inside and outside mirrors, and fasten your seat belts.

**NOTE:** This vehicle is not compatible with any after-market remote starting systems. The installation of after-market remote starting systems is NOT recommended.

### WARNING!

- Never leave children alone in a vehicle. Leaving unattended children in a vehicle is dangerous for a number of reasons. A child or others could be seriously or fatally injured. Do not leave the key in the ignition. A child could operate power windows, other controls, or move the vehicle.
- Do not leave animals or children inside parked vehicles in hot weather; interior heat buildup may cause serious injury or death.

*(Continued)*

### WARNING! (Continued)

- Be sure to turn off the engine and remove the key from the ignition switch if you want to rest or sleep in your car. Accidents can be caused by inadvertently moving the shift lever. Accidents can also be caused by pressing the accelerator pedal. This may cause excessive heat in the exhaust system, resulting in overheating and vehicle fire, which may cause serious or fatal injuries.

### Starting

Normal starting of either a warm or cold engine is obtained without pumping or pressing the accelerator pedal.

Turn the key to the START position while your vehicle is in PARK. When the ignition key is turned to the START position, the "READY" light in the cluster will illuminate to indicate the Hybrid System has started. When the

“READY” light is illuminated, your Hybrid vehicle can be driven under electric power even though the internal combustion engine may not be running.

If the “READY” light fails to illuminate after you have followed the normal starting procedure contact your authorized dealer.

### **WARNING!**

- Never pour fuel or other flammable liquid into the throttle body air inlet opening in an attempt to start the vehicle. This could result in flash fire causing serious personal injury.

*(Continued)*

### **WARNING! (Continued)**

- Do not attempt to push or tow your vehicle to get it started. Vehicles equipped with an automatic transmission cannot be started this way. Unburned fuel could enter the catalytic converter and once the engine has started, ignite and damage the converter and vehicle. If the vehicle has a discharged battery, booster cables may be used to obtain a start from a booster battery or the battery in another vehicle. This type of start can be dangerous if done improperly. Refer to Section 6 of this supplement for proper jump-starting procedures and follow them carefully.

## 2-MODE HYBRID TRANSMISSION

The electronic PRND21 on the instrument cluster indicates the transmission range that has been selected. The shift lever is mounted on the right side of the steering column. To drive the vehicle, move the shift lever from PARK or NEUTRAL to the desired drive position. Pull the shift lever toward you when shifting into REVERSE, SECOND, FIRST or PARK, or when shifting out of PARK.

### Brake/Transmission Interlock System

This system prevents you from moving the shift lever out of PARK and into any range unless the brake pedal is pressed. This system is active only while the ignition switch is in the ON position. Always press the **brake pedal first**, before moving the shift lever out of PARK.

## 2-Mode Hybrid Transmission Ranges

### *PARK*

Supplements the parking brake by locking the transmission. The engine can be started in this range. Never use PARK while vehicle is in motion. Apply the parking brake when leaving the vehicle in this range. Always apply the parking brake first, then place the shift lever in the PARK position.

**NOTE:** DO NOT race the engine when shifting from PARK or NEUTRAL position into another range.

**WARNING!**

- Your vehicle could move and injure you and others if it is not completely in PARK. Check by trying to move the shift lever back and forth without first pulling the shift lever toward you, after you have set it in PARK. Make sure it is in PARK before leaving the vehicle.
- Never use PARK position on an automatic transmission as a substitute for the parking brake. Always apply the parking brake fully when parked to guard against vehicle movement and possible injury or damage.

*(Continued)*

**WARNING! (Continued)**

- It is dangerous to shift the shift lever out of PARK or NEUTRAL if the engine speed is higher than idle speed. If your foot is not firmly on the brake pedal, the vehicle could accelerate quickly forward or in reverse. You could lose control of the vehicle and hit someone or something. Only shift into gear when the engine is idling normally and when your right foot is firmly on the brake pedal.

**REVERSE**

Use this range only after the vehicle has come to a complete stop.

**NEUTRAL**

Shift to NEUTRAL when vehicle is standing for prolonged periods with engine running. Engine may be started in this range. Set the parking brake if you must leave the vehicle.

**NOTE:** Towing the vehicle (except as specified under "Towing A Disabled Vehicle"), coasting, or otherwise driving the vehicle while in NEUTRAL can cause severe transmission damage.

### **DRIVE**

For most city and highway driving. This is the preferred operating mode for this vehicle. The best fuel economy is achieved by operating the vehicle in DRIVE.

### **"2" SECOND**

For driving on mountain roads where more precise speed control is desirable. Use it also when climbing long grades, and for engine braking when descending moderately steep grades. To prevent excessive engine speed do not exceed 45 mph (72 km/h) in this range.

**NOTE:** When operating in "2" SECOND the gasoline engine will start and/or remain running.

### **"1" FIRST**

For driving up very steep hills and for engine braking at low speeds 25 mph (40 km/h) or less when going downhill. To prevent excessive engine speed do not exceed 25 mph (40 km/h) in this range.

**NOTE:** When operating in "1" FIRST the gasoline engine will start and/or remain running.

### **Drive Operation**

The 2-Mode Hybrid Transmission will select one of four fixed gear ratios to maximize fuel economy. However, the best fuel economy savings will be when the following is conditions are met:

- the shift lever is in DRIVE.
- the engine coolant has reached normal operating temperature.
- the TOW/HAUL switch has not been activated.

- the transmission has reached normal operating temperature.
- the high voltage battery has reached normal operating temperature.
- a sufficient state of charge in the high voltage battery.

**NOTE:**

- If the vehicle is started in extremely cold temperatures, the 2-Mode Hybrid Transmission will automatically select the most desirable gear for operation. Normal operation will resume when the transmission fluid temperature has risen to a suitable level.
- If the 2-Mode Hybrid Transmission temperature gets extremely hot, the transmission will automatically select the most desirable gear for operation. If the transmission temperature becomes hot enough, the TRANS TEMP light may illuminate until the transmission cools down. After cool down, the transmission will resume normal operation.

**When To Use TOW/HAUL Mode**

When driving in hilly areas, towing a trailer, carrying a heavy load, etc., and frequent transmission shifting occurs, press the TOW/HAUL switch.

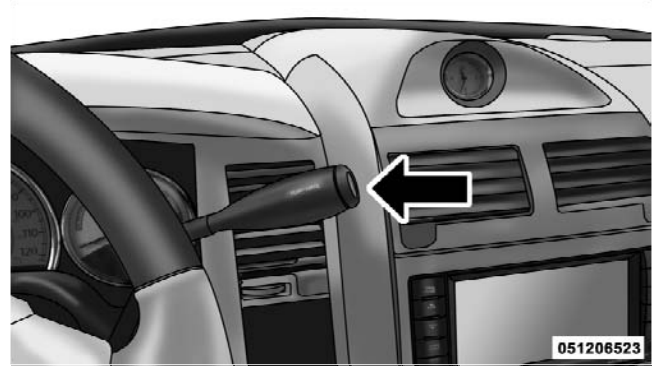

**TOW/HAUL Switch**

When operating in TOW/HAUL mode, the 2-Mode Hybrid Transmission will select gear ratios that maximize towing power, with less emphasis on fuel economy.

**NOTE:** Electric only mode and engine stop-start are disabled then TOW/HAUL is activated.

The TOW/HAUL light will illuminate in the instrument cluster to indicate when the switch has been activated. Pressing the switch a second time restores normal operation.

## **FOUR-WHEEL DRIVE OPERATION**

### **MP 3010 “Active On Demand” Transfer Case**

The MP 3010 is a single speed (4 HI range only) transfer case which provides convenient full-time four-wheel drive. No driver interaction is required.

Proper operation of four-wheel drive vehicles depends on tires of equal size, type and circumference on each wheel. Any difference in tire size can cause damage to the transfer case.

Because four-wheel drive provides improved traction, there is a tendency to exceed safe turning and stopping speeds. Do not go faster than road conditions permit.

This four-wheel drive (4WD) system allows the front and rear wheels to rotate at different speeds when required by the road condition or road surface.

The “SVC 4WD” warning light monitors the electric shift 4WD system. If this light remains on after engine start up or illuminates during driving, it means that the 4WD system is not functioning properly and that service is required. See your authorized dealer for immediate service.



**WARNING!**

Always engage the parking brake when powering down the vehicle if the "SVC 4WD" light is illuminated. Not engaging the parking brake may allow the vehicle to roll, which may cause personal injury.

**CAUTION!**

Operation in very high temperatures with a high level of steering activity may cause the electrically driven pump to reduce or stop assist in order to prevent damage to the system. Normal operation will resume once the system is allowed to cool.

**POWER STEERING**

Your vehicle is equipped with an electro-hydraulic power steering system that will give you good vehicle response and increased ease of maneuverability in tight spaces. The system will vary its assist to provide light efforts while parking and good feel while driving. If the electro-hydraulic power steering system experiences a fault that prevents it from providing power steering assist, the system will provide mechanical steering capability.

If for some reason the power assist is interrupted, it will still be possible to steer your vehicle. Under these conditions you will observe a substantial increase in steering effort, especially at very low vehicle speeds and during parking maneuvers.

**NOTE:** Increased noise levels at the end of the steering wheel travel are considered normal and does not indicate that there is a problem with the power steering system.

Upon initial start-up in cold weather, the power steering pump may make noise for a short period of time. This noise should be considered normal, and does not in any way damage the steering system.

**WARNING!**

**Continued operation with reduced power steering assist could pose a safety risk to yourself and others. Service should be obtained as soon as possible.**

**CAUTION!**

**Prolonged operation of the steering system at the end of the steering wheel travel will increase the steering fluid temperature and should be avoided when possible. Damage to the power steering pump may occur.**

**ELECTRONIC BRAKE CONTROL SYSTEM**

Your vehicle is equipped with an advanced electronic brake control system that includes Anti-Lock Brake System (ABS), Brake Assist System (BAS), Traction Control System (TCS), Electronic Roll Mitigation (ERM), Electronic Stability Program (ESP), Trailer Sway Control (TSC) and Hill Start Assist (HSA). All seven systems work together to enhance vehicle stability and control in various driving conditions, and are commonly referred to as ESP.

**Hill Start Assist (HSA)**

The HSA system is designed to assist the driver when starting a vehicle from a stop on a hill. HSA will maintain the level of brake pressure the driver applied for a short period of time after the driver takes their foot off of the brake pedal. If the driver does not apply the throttle during this short period of time, the system will release brake pressure and the vehicle will roll down the hill. The

system will release brake pressure in proportion to amount of throttle applied as the vehicle starts to move in the intended direction of travel.

### HSA Activation

The following must be met in order for HSA to activate:

- Vehicle must be stopped.
- Vehicle must be on a 8% grade or greater hill.
- Gear selection matches vehicle uphill direction (i.e., vehicle facing uphill is in forward gear; vehicle backing uphill is in REVERSE gear).

HSA will work in REVERSE and all forward gears when the activation requirements have been met. The system will not activate if the vehicle is placed in NEUTRAL or PARK.

### WARNING!

**There may be situations on minor hills (i.e., less than 8%), with a loaded vehicle, or while pulling a trailer, when the system will not activate and slight rolling may occur. This could cause a collision with another vehicle or object. Always remember the driver is responsible for braking the vehicle.**

### Towing with HSA

HSA will provide assistance when starting on a grade when pulling a trailer.

**WARNING!**

- If you use a trailer brake controller with your trailer, your trailer brakes may be activated and deactivated with the brake switch. If so, when the brake pedal is released there may not be enough brake pressure to hold the vehicle and trailer on a hill and this could cause a collision with another vehicle or object behind you. In order to avoid rolling down the hill while resuming acceleration, manually activate the trailer brake prior to releasing the brake pedal. Always remember the driver is responsible for braking the vehicle.

*(Continued)*

**WARNING! (Continued)**

- HSA is not a parking brake. If you stop the vehicle on a hill without putting the transmission in PARK and using the parking brake, it will roll down the hill and could cause a collision with another vehicle or object. Always remember to use the parking brake while parking on a hill, and that the driver is responsible for braking the vehicle.

**RECREATIONAL TOWING (BEHIND MOTORHOME, ETC.)****CAUTION!**

Your vehicle is equipped with an MP 3010 "Active On Demand" transfer case which has no NEUTRAL position and may NOT be used for recreational towing.

# WHAT TO DO IN EMERGENCIES

## CONTENTS

---

■ Jacking Instructions . . . . .	68	□ Charge Assist Procedure — High Voltage Battery . . . . .	77
□ Jack Location . . . . .	68	□ Jump-Starting — 12-Volt Battery . . . . .	84
□ Removing The Spare Tire . . . . .	69	■ Towing A Disabled Vehicle . . . . .	86
□ Tire Changing Procedure . . . . .	70	□ Four-Wheel Drive . . . . .	86
■ Jump-Starting Procedures . . . . .	77		

## JACKING INSTRUCTIONS

### WARNING!

- Being under a jacked-up vehicle is dangerous. The vehicle could slip off the jack and fall on you. You could be crushed. Never put any part of your body under a vehicle that is on a jack. Never start or run the engine while the vehicle is on a jack. If you need to get under a raised vehicle, take it to a service center where it can be raised on a lift.
- The jack is designed to use as a tool for changing tires only. The jack should not be used to lift the vehicle for service purposes. The vehicle should be jacked on a firm level surface only. Avoid ice or slippery areas.

### Jack Location

The scissor jack and tire changing tools are stowed in the rear cargo area.

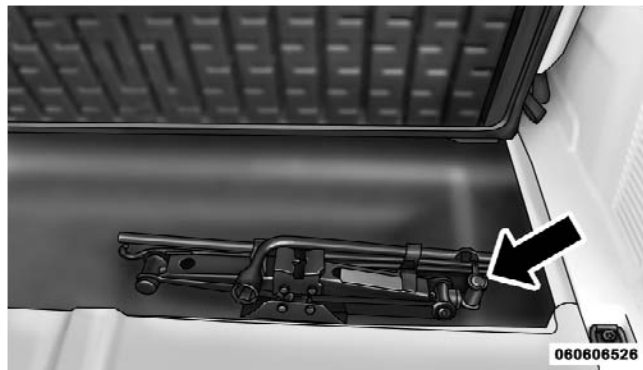

### Jack Location

The jack is secured in place with a winged stud and a fixed stud. It is very important to secure the jack tightly in place by engaging the slot in the base to the fixed stud under the middle seat. The winged stud inserts through the eyelet in the end of the jack's worm screw.

## Removing The Spare Tire

The spare tire on your vehicle is located underneath the vehicle in the rear.

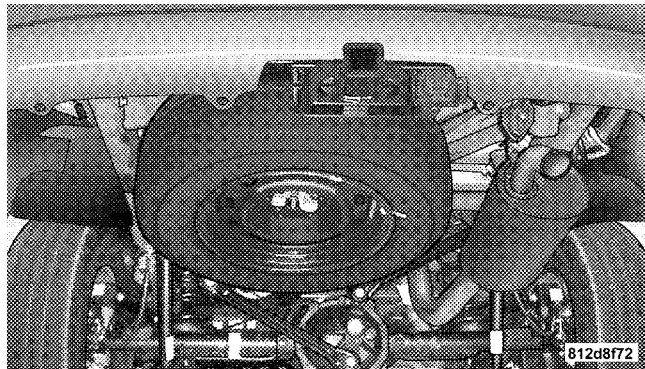

**Spare Tire Location**

Remove the spare tire before attempting to jack the vehicle.

1. Remove the rubber plug from the floor in the cargo area.

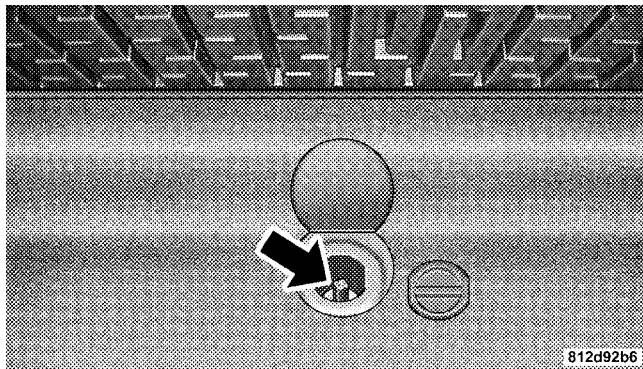

**Spare Tire Winch**

2. Engage the jack wrench extension to the spare tire winch through the hole in the floor.

3. Turn the wrench counterclockwise to lower the spare tire. Continue to turn the wrench until the spare tire can be pulled out from under the vehicle.

It is recommended that you stow the flat tire or spare to avoid tangling the loose cable.

### **CAUTION!**

The winch mechanism is designed for use with the jack extension tube only. Use of an air wrench or other power tools is not recommended and can damage the winch.

### **Tire Changing Procedure**

#### **WARNING!**

**Getting under a jacked-up vehicle is dangerous. The vehicle could slip off the jack and fall on you. You could be crushed. Never get any part of your body under a vehicle that is on a jack. Never start or run the engine while the vehicle is on a jack. If you need to get under a raised vehicle, take it to a service center where it can be raised on a lift.**

Do not raise this vehicle using a bumper jack. The scissor jack is designed as a tool for changing tires on this vehicle only. It is not recommended that the jack be used for service purposes or to lift more than one wheel at a time.



## Preparations

1. Park the vehicle on a firm level surface. Avoid ice or slippery areas.

### WARNING!

Do not attempt to change a tire on the side of the vehicle close to moving traffic. Pull far enough off the road to avoid the danger of being hit when operating the jack or changing the wheel.

2. Set the parking brake.

3. Place the shift lever in PARK (automatic transmission). On 4-wheel drive vehicles, shift the transfer case to the "4L" position.

4. Turn the ignition OFF.

5. Turn on the Hazard Warning flasher.



6. Block both the front and rear of the wheel diagonally opposite the jacking position. For example, if the right front wheel is being changed, block the left rear wheel.

**NOTE:** Passengers should not remain in the vehicle when the vehicle is being jacked.

## Instructions

**WARNING!**

Carefully follow these tire changing warnings to help prevent personal injury or damage to your vehicle:

- Always park on a firm, level surface as far from the edge of the roadway as possible before raising the vehicle.
- Block the wheel diagonally opposite the wheel to be raised.
- Set the parking brake firmly and set an automatic transmission in **PARK**; a manual transmission in **REVERSE**.
- Never start or run the engine with the vehicle on a jack.
- Do not let anyone sit in the vehicle when it is on a jack.

*(Continued)*

**WARNING! (Continued)**

- Do not get under the vehicle when it is on a jack.
- Only use the jack in the positions indicated and for lifting this vehicle during a tire change.
- If working on or near a roadway, be extremely careful of motor traffic.
- To assure that spare tires, flat or inflated are securely stowed, spares must be stowed with the valve stem facing the ground.
- Turn on the Hazard Warning flasher.



Jack Warning Label

1. Remove the spare wheel, jack, and tools from storage.

- Using the wheel wrench, loosen, but do not remove, the wheel nuts by turning them counterclockwise one turn while the wheel is still on the ground.
- When changing a front wheel, place the jack under the frame rail behind the wheel. Locate the jack as far forward as possible on the straight part of the frame (prior to inboard transition). Operate the jack using the jack drive tube and the wheel wrench; the tube extension may be used but is not required.

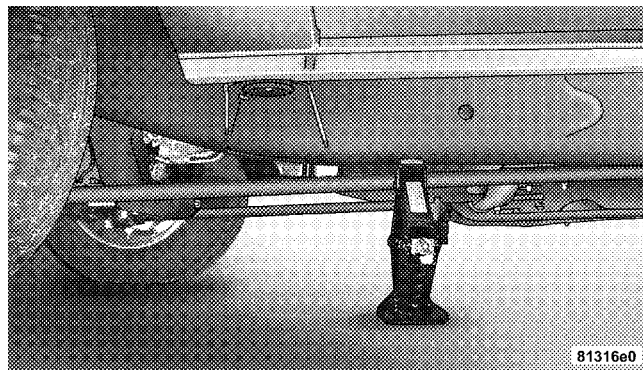

Front Jacking Location

When changing a rear wheel, assemble the jack drive tube to the jack and connect the drive tube to the extension tube. Place the jack under the axle as close to the tire as possible with the drive tubes extending to the rear. Connect the jack tube extension and wheel wrench.

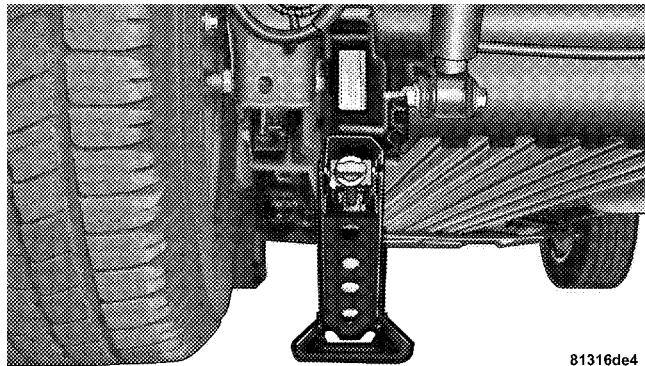

81316de4

**Left Rear Jacking Location**

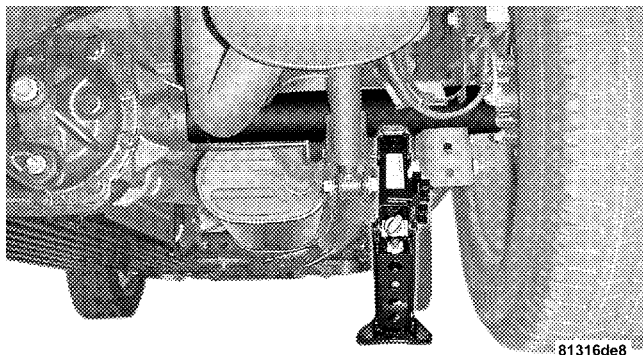

81316de8

**Right Rear Jacking Location**

Before raising the wheel off the ground, make sure that the jack will not damage surrounding truck parts and adjust the jack position as required.

4. Raise the vehicle by rotating the wheel wrench clockwise, until the wheel just clears the surface.

**WARNING!**

Raising the vehicle higher than necessary can make the vehicle unstable and cause an accident. It could slip off the jack and hurt someone near it. Raise the vehicle only enough to remove the tire.

5. Remove the wheel nuts and pull the wheel off. Install the spare wheel and wheel nuts with the cone shaped end of the nuts toward the wheel. Lightly tighten the nuts. To avoid risk of forcing the vehicle off the jack, do not fully tighten the nuts until the vehicle has been lowered.

**NOTE:** Do not oil wheel studs. For chrome wheels, do not substitute with chrome plated wheel nuts.

6. Using the wheel wrench, finish tightening the nuts in a crisscross pattern. Correct nut tightness is  $135 \pm 10$  ft lbs ( $183 \pm 14$  N·m) dynamic torque. If in doubt about the

correct tightness, have them checked with a torque wrench by your authorized dealer or at a service station.

**WARNING!**

A loose tire or jack thrown forward in a collision or hard stop could injure someone in the vehicle. Always stow the jack, tools and the extra tire and wheel in the places provided.

7. Remove wheel blocks. Do not install chrome or aluminum wheel center caps on the spare wheel. This may result in cap damage.

8. Lower the jack to its fully closed position. Stow the replaced tire, jack, and tools as previously described.

9. Adjust the tire pressure when possible.

**NOTE:** Do not oil wheel studs. For chrome wheels, do not substitute with chrome plated wheel nuts.

**WARNING!**

Carefully follow these tire changing warnings to help prevent personal injury or damage to your vehicle:

- Always park on a firm, level surface as far from the edge of the roadway as possible before raising the vehicle.
- Block the wheel diagonally opposite the wheel to be raised.
- Apply the parking brake firmly before jacking.
- Never start the engine with the vehicle on a jack.
- Do not let anyone sit in the vehicle when it is on a jack.
- Do not get under the vehicle when it is on a jack.
- Only use the jack in the positions indicated.

*(Continued)*

**WARNING! (Continued)**

- If working on or near a roadway, be extremely careful of motor traffic.
- To assure that spare tires, flat or inflated, are securely stowed, spares must be stowed with the valve stem facing the ground.

**To Stow The Flat Or Spare**

Turn the wheel so that the valve stem is downward. Slide the wheel retainer through the center of the wheel and position it properly across the wheel opening.

For convenience in checking the spare tire inflation, stow with the valve stem toward the rear of the vehicle.

Rotate the winch mechanism until the wheel is drawn into place against the underside of the vehicle. Continue to rotate until you feel the winch mechanism slip or click two times. It cannot be overtightened. Push against the tire several times to be sure it is firmly in place.

## JUMP-STARTING PROCEDURES

Your Hybrid vehicle is equipped with both a 12-Volt battery and a high voltage battery. Either battery may become discharged and cause a no crank condition as a result of low voltage.

If the 12-Volt battery's state of charge is too low and the engine will not crank, the 12-Volt battery light located in the cluster may illuminate. If this occurs refer to "Jump-Starting — 12-Volt Battery" in this Section.

If the high voltage battery's state of charge is too low and the engine will not crank, the Navigation radio will display a "Charge Insufficient" message. If this occurs refer to "Charge Assist Procedure — High Voltage Battery" in this Section.

## Charge Assist Procedure — High Voltage Battery

The "Charge Assist" procedure allows you to charge the high voltage battery using the 12-Volt battery system. The Navigation radio will guide you through the "Charge Assist" procedure.

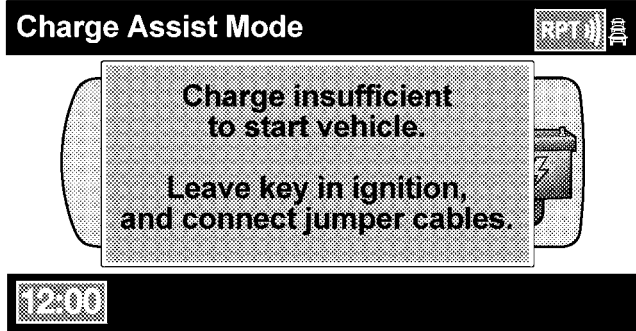

6

81f384ec

Charge Insufficient Message

This message indicates that the vehicle is in “Charge Assist” mode, and can be charged by following the “Charge Assist” procedure.

**NOTE:**

- Depending on the high voltage battery’s state of charge, it may take up to 60 minutes for the system to become adequately charged to start the engine.
- There are remote battery posts located under the hood that are used to assist in the “Charge Assist” procedure.
- A second running vehicle may be used in this “Charge Assist” procedure provided the generator output is a minimum of 125 amps.

**WARNING!**

- **A battery generates hydrogen gas which is flammable and explosive. Keep flame or spark away from the vent holes. DO NOT use a booster battery or any other booster source with a nominal voltage output that exceeds 12-Volts.**
- **Battery fluid is a corrosive acid solution; do not allow battery fluid to contact eyes, skin or clothing. If acid splashes in eyes or on skin, flush the contaminated area immediately with large quantities of water.**

**NOTE:**

- A 12-Volt battery charger with a minimum 30 Amp rating is the only type recommended to use when charging the high voltage battery. There are many types of these units available. Follow the manufacturer’s instructions for necessary precautions and operation.



- Depending on the condition of the second running vehicles alternator and the number of accessories operating on both vehicles, it could take up to 60 minutes to charge the high voltage battery. To minimize the charging time ensure that a minimum amount of accessories are being used.

Always wear eye protection and remove all metal jewelry such as watch bands or bracelets which might make an unintended electrical contact.

1. Turn OFF all unnecessary electrical loads such as the heater, radio, lights etc.
2. Set the parking brake, place the shift lever in PARK and turn the ignition to the ON/RUN position.
3. Place the battery charger within cable reach of the remote battery posts located under the hood.

4. Connect the positive cable clamp of the 12-Volt battery charger to the remote positive post located near the engine oil dipstick underhood.

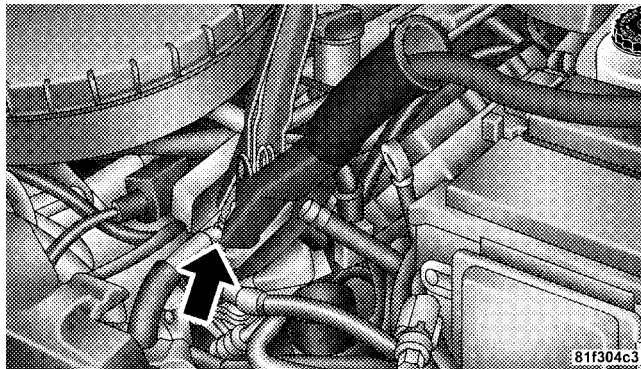

**Remote Positive Post**

5. Connect the negative cable clamp of the 12-Volt battery charger to the remote negative post located near the driver's side fender underhood.

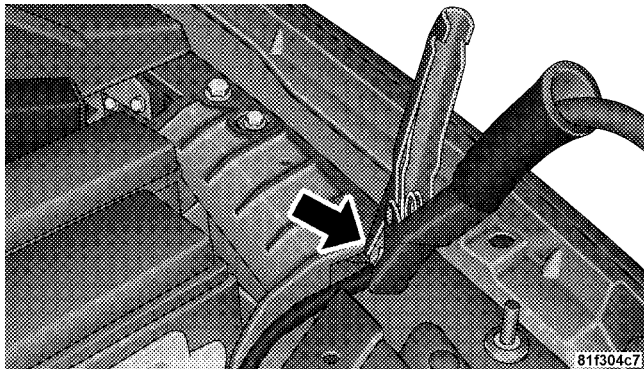

Negative Post

### WARNING!

During cold weather when temperatures are below freezing point, electrolyte in a discharged battery may freeze. Do not attempt jump-starting because the battery could rupture or explode. The battery temperature must be brought up above freezing point before attempting a jump-start.

6. Turn on the battery charger and allow the high voltage battery to charge.

**NOTE:** Depending on the type of battery charger you are using and the vehicle load, the charging current may vary. Do not allow the charging current to exceed 70 Amps. Follow the manufacturer's instructions for necessary precautions and operation.

**CAUTION!**

Charging the high voltage battery at a rate higher than 70 Amps could damage the 12-Volt battery.

7. If the 12-Volt battery charger has been properly connected and the system determines that the conditions are correct for charging, the Navigation radio will display a message "CHARGING in Progress".

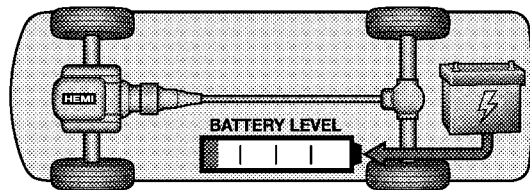
**Charge Assist Mode**

12:00

**CHARGING  
in Progress****DO NOT START VEHICLE!**

81f384f0

6

Charging In Progress

**CAUTION!**

Do not leave the vehicle unattended while charging the high voltage battery. The battery charger must be turned off once "Charge Assist" has been completed or damage to the 12-Volt battery can occur.

**NOTE:**

- To minimize the charging time, it is recommended to leave the key in the OFF position while in the "CHARGING in Progress" mode, however the key may be turned to the ON/RUN position to use an accessory.
- Do not use the accessory mode for a long period of time, since the charging system will not maintain either the 12-Volt or high voltage battery in this mode.

Allow the system to charge until the Navigation radio displays the "Attempt to start vehicle" message.

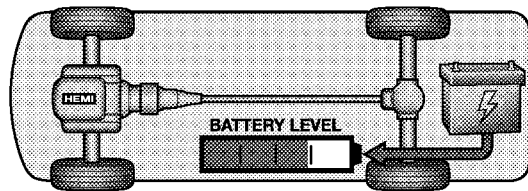
**Charge Assist Mode**

12:00

**CHARGE is  
Sufficient****Attempt to start vehicle...**

81f384f4

**Attempt To Start Message**

8. Attempt to start the vehicle, if the vehicle starts, leave it running and turn off the 12-Volt battery charger.
9. Remove the 12-Volt battery charger negative clamp.

**CAUTION!**

Be careful of the moving belt and fan blades.

10. Remove the 12-Volt battery charger positive clamp.

**NOTE:** Allow the vehicle to idle for a minimum of 10 minutes before attempting to drive.

**WARNING!**

Any procedure other than above could result in:

- Personal injury caused by electrolyte squirting out the battery vent.
- Personal injury or property damage due to battery explosion.
- Damage to charging system or immobilized vehicle.

**Charging Aborted**

If the "Charge Assist" procedure is interrupted, the Navigation radio will display "Charge Aborted".

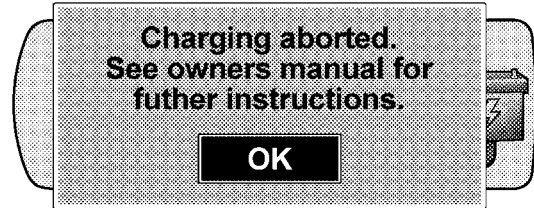
**Charge Assist Mode**

**CHARGING  
in Progress**

**DO NOT START VEHICLE!**

81f38502

Charging Aborted

“Charge Assist” can be aborted by the following items:

- The key is turned to the START position while the system is being charged.
- Incorrect installation of the 12-Volt battery charger.
- Poor cable clamp contact.
- The Hybrid Control Module determines conditions are not suitable for charging.

If the “Charge Aborted” message is displayed check the battery charger clamps, making sure there is a good connection. Check to see that the 12-Volt battery charger is turned on. Turn OFF the ignition, wait 10 to 15 seconds and turn the key to the START position. If the “Charge Aborted” message is still active have the vehicle towed to the nearest authorized dealer for service.

## Jump-Starting — 12-Volt Battery

### WARNING!

- **Battery fluid is a corrosive acid solution; do not allow battery fluid to contact eyes, skin or clothing. Don't lean over battery when attaching clamps or allow the clamps to touch each other. If acid splashes in eyes or on skin, flush the contaminated area immediately with large quantities of water.**
- **A battery generates hydrogen gas which is flammable and explosive. Keep flame or spark away from the vent holes. Do not use a booster battery or any other booster source with an output that exceeds 12-Volts.**

1. Wear eye protection and remove all metal jewelry such as watch bands or bracelets which might make an unintended electrical contact.

2. Park the booster vehicle within cable reach but without letting the vehicles touch. Set the parking brake, place the shift lever in PARK and turn the ignition OFF on both vehicles.
3. Turn OFF heater, radio and all unnecessary electrical loads.
4. Connect one end of a jumper cable to the positive terminal of the booster battery. Connect the other end of the same cable to the remote positive post.

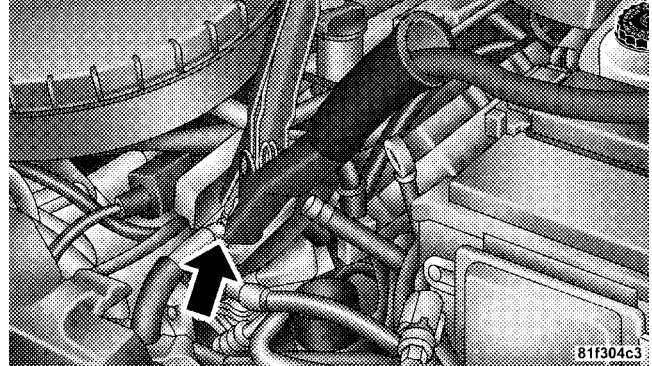

Remote Positive Post

**WARNING!**

Do not permit vehicles to touch each other as this could establish a ground connection and personal injury could result.

5. Connect the other cable, first to the negative terminal of the booster battery and then to the engine of the vehicle with the discharged battery. Make sure you have a good contact on the engine.

### WARNING!

- Do not connect the cable to the negative post of the discharge battery. The resulting electrical spark could cause the battery to explode.
- During cold weather when temperatures are below freezing point, electrolyte in a discharged battery may freeze. Do not attempt jump-starting because the battery could rupture or explode. The battery temperature must be brought up above freezing point before attempting a jump-start.

6. Start the engine in the vehicle which has the booster battery, let the engine idle a few minutes, then start the engine in the vehicle with the discharged battery.

7. When removing the jumper cables, reverse the above sequence exactly. Be careful of the moving belt and fan.

### WARNING!

Any procedure other than above could result in:

- Personal injury caused by electrolyte squirting out the battery vent.
- Personal injury or property damage due to battery explosion.
- Damage to charging system of booster vehicle or of immobilized vehicle.

## TOWING A DISABLED VEHICLE

### Four-Wheel Drive

The manufacturer requires towing your Hybrid with all four wheels **OFF** the ground using a flatbed.



# MAINTAINING YOUR VEHICLE

## CONTENTS

---

■ Engine Compartment — 5.7L HEMI V-8 . . . . .	88	□ Interior Fuses . . . . .	99
■ Maintenance Procedures . . . . .	89	□ Power Distribution Center . . . . .	101
□ Traction Power Inverter Module Cooling System . . . . .	89	□ Power Distribution Center 2 . . . . .	105
□ 2-Mode Hybrid Transmission . . . . .	95	□ Integrated Power Module . . . . .	106
□ Transfer Case (All Wheel Drive) . . . . .	96	■ Fluids And Capacities . . . . .	109
□ Axles . . . . .	96	■ Fluids, Lubricants And Genuine Parts . . . . .	110
□ Appearance Care And Protection From Corrosion . . . . .	97	□ Engine . . . . .	110
■ Fuses . . . . .	98	□ Chassis . . . . .	111

## ENGINE COMPARTMENT — 5.7L HEMI V-8

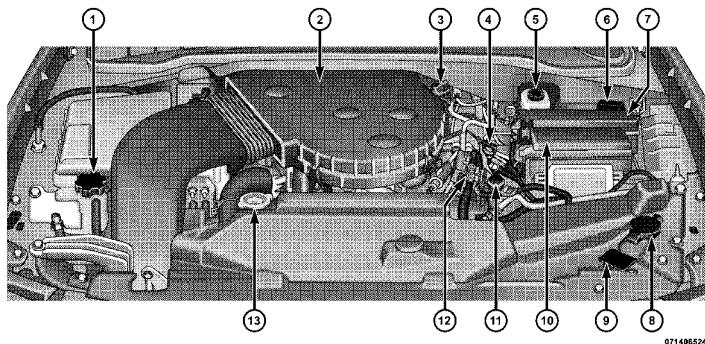

071406524

- 1 — Traction Power Inverter Module (TPIM) Coolant Bottle
- 2 — Air Cleaner Filter
- 3 — Engine Oil fill
- 4 — Engine Oil Dipstick
- 5 — Brake Fluid Reservoir
- 6 — Fuses (Power Distribution Center 2)
- 7 — Fuses (Power Distribution Center)

- 8 — Washer Fluid Bottle
- 9 — Engine Coolant Bottle
- 10 — Fuses (Integrated Power Module)
- 11 — Power Steering Fluid
- 12 — Remote Jump-Start Positive Battery Post
- 13 — Engine Coolant Pressure Cap

## MAINTENANCE PROCEDURES

### WARNING!

Your vehicle has both a high voltage DC and AC system as well as a 12-Volt system. DC and AC high voltage are both extremely dangerous and can cause severe burns, electric shock, serious injury or even death. In order to avoid personal injuries:

- **DO NOT TOUCH THE HIGH VOLTAGE CABLES (ORANGE COLORED) AND/OR THE CONNECTORS.**
- **Follow all Caution and Warning labels attached to the high voltage (Hybrid System) components.**
- **Do not remove or replace any of the Hybrid System components. All replacement or repairs of Hybrid System components should be performed by a factory-trained technician at an authorized dealer.**

The pages that follow contain the **required** maintenance services determined by the engineers who designed your vehicle.

Besides the maintenance items for which there are fixed maintenance intervals, there are other items that should operate satisfactorily without periodic maintenance. However, if a malfunction of these items does occur, it could adversely affect the engine or vehicle performance. These items should be inspected if a malfunction is observed or suspected.

### Traction Power Inverter Module Cooling System

The Traction Power Inverter Module (TPIM) cooling system is completely separate from the engine cooling system and is designed to remove heat away from the TPIM.

### Traction Power Inverter Module (TPIM) Cooling System – Coolant Level Check

Check the TPIM coolant (antifreeze) protection every 12 months (before the onset of freezing weather, where applicable).

Check the coolant bottle tubing for brittle rubber, cracking, tears, cuts and tightness of the connection at the bottle and radiator. Inspect the entire system for leaks.

**NOTE:** DO NOT REMOVE THE COOLANT PRESSURE CAP WHEN THE COOLING SYSTEM IS HOT.

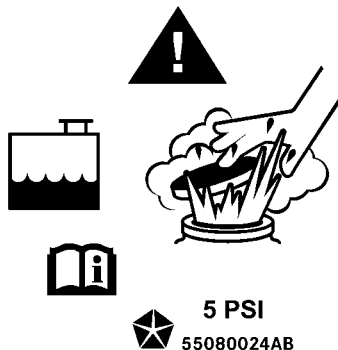

81eea14e

Cooling System Warning Label

**WARNING!**

- The warning graphic that appears on the cooling system pressure cap is a safety precaution for “DO NOT OPEN HOT”. Never add coolant (antifreeze) when the engine is overheated. Do not loosen or remove the cap to cool an overheated engine. Heat causes pressure to build up in the cooling system. To prevent scalding or injury, do not remove the pressure cap while the system is hot or under pressure.
- Do not use a pressure cap other than the one specified for your vehicle. Personal injury or engine damage may result.

Maintain coolant (antifreeze) concentration at a minimum of 50% MOPAR® Antifreeze/Coolant 5 Year/100,000 Mile Formula HOAT (Hybrid Organic Additive Technology) and distilled/deionized water for proper corrosion protection.

Check the coolant (antifreeze) level with the engine off. If the coolant (antifreeze) level is below the Cold Fill mark, add coolant until it reaches the MAX level mark.

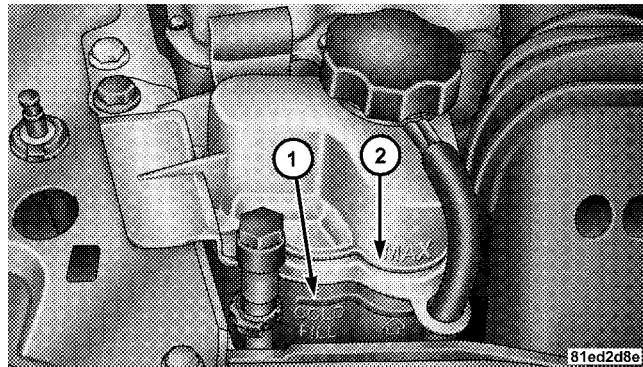

**TPIM Coolant Reservoir**

**TPIM Cooling System — Drain, Flush and Refill**  
Refer to “Maintenance Schedules” in Section 7 of this supplement for the proper maintenance intervals.

If the coolant (antifreeze) is dirty or contains a considerable amount of sediment, clean and flush with a reliable cooling system cleaner. Follow with a thorough rinsing to remove all deposits and chemicals. Properly dispose of old coolant (antifreeze) solution.

### Selection Of Coolant

Refer to “Fluids, Lubricants, and Genuine Parts” in this section for the correct fluid type.

#### CAUTION!

- **Mixing of coolant (antifreeze) other than specified HOAT TPIM coolant (antifreeze), may result in engine damage and may decrease corrosion protection. If a non-HOAT coolant (antifreeze) is introduced into the cooling system in an emergency, it should be replaced with the specified coolant (antifreeze) as soon as possible.**

*(Continued)*

#### CAUTION! (Continued)

- **Do not use plain water alone or alcohol-base coolant (antifreeze) products. Do not use additional rust inhibitors or antirust products, as they may not be compatible with the TPIM coolant and may plug the TPIM cooler.**
- **This vehicle has not been designed for use with Propylene Glycol based coolant (antifreeze). Use of Propylene Glycol based coolant (antifreeze) is not recommended.**

### Adding Coolant

Your vehicle has been built with an improved TPIM coolant (antifreeze) that allows extended maintenance intervals. This coolant (antifreeze) can be used up to 5 Years or 102,000 miles (170 000 km) before replacement. To prevent reducing this extended maintenance period, it is important that you use the same coolant (antifreeze) throughout the life of your vehicle.

Please review these recommendations for using Hybrid Organic Additive Technology (HOAT) coolant (antifreeze).

When adding coolant (antifreeze):

- The manufacturer recommends using MOPAR® Antifreeze/Coolant 5 Year/100,000 Mile Formula HOAT (Hybrid Organic Additive Technology).
- Mix a minimum solution of 50% HOAT coolant (antifreeze) and distilled water. Use higher concentrations (not to exceed 70%) if temperatures below  $-34^{\circ}\text{F}$  ( $-37^{\circ}\text{C}$ ) are anticipated.
- Use only high purity water such as distilled or deionized water when mixing the water/TPIM coolant (antifreeze) solution. The use of lower quality water will reduce the amount of corrosion protection in the engine cooling system.

Please note that it is the owner's responsibility to maintain the proper level of protection against freezing according to the temperatures occurring in the area where the vehicle is operated.

**NOTE:** Mixing coolant (antifreeze) types will decrease the life of the TPIM coolant (antifreeze) and will require more frequent coolant (antifreeze) changes.

#### **TPIM Cooling System Pressure Cap**

The cap must be fully tightened to prevent loss of coolant.

The cap should be inspected and cleaned if there is any accumulation of foreign material on the sealing surfaces.

### **Disposal of Used TPIM Coolant**

Used ethylene glycol based TPIM coolant (antifreeze) is a regulated substance requiring proper disposal. Check with your local authorities to determine the disposal rules for your community. To prevent ingestion by animals or children, do not store ethylene glycol based TPIM coolant (antifreeze) in open containers or allow it to remain in puddles on the ground. If ingested by a child, contact a physician immediately. Clean up any ground spills immediately.

### **TPIM Coolant Level**

The TPIM coolant bottle provides a quick visual method for determining that the coolant (antifreeze) level is adequate. With the engine cold, the level of the coolant (antifreeze) in the coolant recovery bottle should be between the ranges indicated on the bottle.

When additional coolant (antifreeze) is needed to maintain the proper level, it should be added to the coolant bottle. Do not overfill.

### **Points to Remember**

If an examination of your engine compartment shows no evidence of TPIM cooler or hose leaks, the vehicle may be safely driven.

- Do not overfill the coolant recovery bottle.
- Check coolant (antifreeze) freeze point in the coolant recovery bottle. If coolant (antifreeze) needs to be added, contents of coolant recovery bottle must also be protected against freezing.
- If frequent coolant (antifreeze) additions are required, or if the level in the coolant recovery bottle does not drop when the engine cools, the cooling system should be pressure tested for leaks.



- Maintain coolant (antifreeze) concentration at 50% HOAT coolant (antifreeze) (minimum) and distilled/deionized water for proper corrosion protection of your engine which contains aluminum components.
- Make sure that the TPIM cooler and coolant recovery bottle overflow hoses are not kinked or obstructed.
- Keep the front of the TPIM cooler clean. If your vehicle is equipped with air conditioning, keep the front of the condenser clean.

## 2-Mode Hybrid Transmission

### Fluid Level Check

**NOTE:** Your vehicle has a capped transmission fill tube. It is sealed and should not be tampered with. Your authorized dealer has the proper tools to ensure that the fluid level is set properly.

### Fluid And Filter Change

Refer to “Maintenance Schedules” in Section 7 of this supplement for the proper maintenance intervals.

### Selection of Lubricant

It is important that the proper lubricant is used in the transmission to assure optimum transmission performance. Use only the manufacturer’s recommended transmission fluid. Refer to “Fluids, Lubricants and Genuine Parts” in this section for the correct fluid type. It is important that the transmission fluid be maintained at the prescribed level using the recommended fluid.

### Special Additives

Automatic transmission fluid is an engineered product and its performance may be impaired by supplemental additives. Therefore, do not add any fluid additives to the transmission. The only exception to this policy is the

use of special dyes to aid in detecting fluid leaks. In addition, avoid using transmission sealers as they may adversely affect seals.

### **Transfer Case (All Wheel Drive)**

Inspect the transfer case for fluid leaks. If a fluid leak is evident the transfer case fluid level may be low. Have the transfer case serviced immediately.

#### **CAUTION!**

**Damage may result from operation of the vehicle with low transfer case fluid.**

### **Drain And Refill**

Refer to “Maintenance Schedules” in Section 7 of this supplement for the proper maintenance intervals.

### **Lubricant Selection**

Refer to “Fluids, Lubricants and Genuine Parts” in this section for the correct fluid type.

## **Axles**

### **Drain And Refill**

Refer to “Maintenance Schedules” in Section 7 of this supplement for the proper maintenance intervals.

### **Lubricant Selection**

Refer to “Fluids, Lubricants and Genuine Parts” in this section for the correct fluid type.

**NOTE:** The presence of water in the gear lubricant will result in corrosion and possible failure of differential components. Operation of the vehicle in water, as may be encountered in some off-highway types of service, will require draining and refilling the axle to avoid damage.

### **Rear Axle**

Rear Axle fluid level should be 1 1/8 in (28 mm) +/- 1/8 in (3 mm) below the fill hole. The total lubricant volume is 64 oz (1.9 L).

### Front Axle

Front axle fluid level should be 3/4 in (20 mm) +/- 1/8 in (3 mm) below the level of the fill hole. The total lubricant volume is 55 oz (1.6 L).

### Appearance Care and Protection From Corrosion

#### Washing

- Wash your vehicle regularly. Always wash your vehicle in the shade using a mild car wash soap, and rinse the panels completely with clear water.
- If insects, tar or other similar deposits have accumulated on your vehicle, wash it as soon as possible.
- Use MOPAR® Auto Polish to remove road film and stains and to polish your vehicle. Take care never to scratch the paint.

- Avoid using abrasive compounds and power buffing that may diminish the gloss or thin out the paint finish.

#### CAUTION!

**Do not use abrasive or strong cleaning materials such as steel wool or scouring powder, which will scratch metal and painted surfaces.**

**NOTE:** Your Hybrid vehicle can be run through typical commercial car wash facilities. There are some simple precautions that you should keep in mind.

- When entering an automatic/conveyor style car wash facility, it is important that the driver follow the attendant's or posted instructions and that your shift lever is shifted to NEUTRAL when instructed.

- A Hybrid vehicle that is in DRIVE with the “READY” light illuminated and gas engine stopped, is NOT a substitute for the NEUTRAL position. The vehicle can creep in DRIVE or REVERSE when the “READY” light is illuminated.

**CAUTION!**

Car wash equipment damage, vehicle damage or a potential accident event could result if the car wash facility instructions for PARK, NEUTRAL, DRIVE and REVERSE are not followed.

**FUSES****CAUTION!**

When replacing a blown fuse, it is important to use only a fuse having the correct amperage rating. The use of a fuse with a rating other than indicated may result in a dangerous electrical system overload. If a properly rated fuse continues to blow, it suggests a problem in the circuit that must be corrected.

**NOTE:** If you are leaving your vehicle dormant for longer than 21 days you may want to take steps to protect your battery. You may do this by disconnecting the 12-Volt battery or by disconnecting the two ignition-off draw (I.O.D.) fuses located in the auxiliary Power Distribution Center (PDC) in the engine compartment. The I.O.D. cavities include a snap-in retainer that allows the

fuse to be disconnected without removing it from the fuse block. Pressing the I.O.D. fuse back into the cavity reconnects it.

### Interior Fuses

The fuse block contains blade-type mini-fuses, relays, and circuit breakers for high-current circuits. It is located in the left kick panel. It is accessible through a snap-in cover.

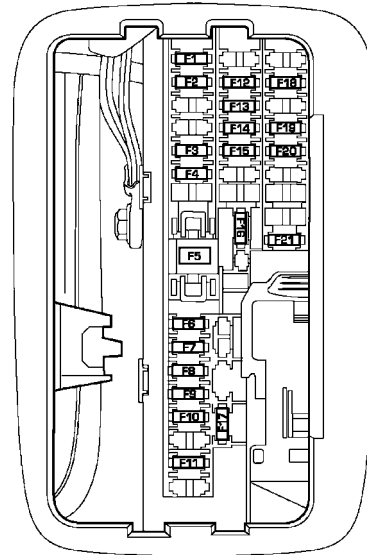

819625ae

Interior Fuse Location

Cavity	Mini-Fuse/ Color	Description
F1	15 Amp Blue	Mod_Clock;Analog/ Mod_Cluster;Illumination
F 2	10 Amp Red	Sunroof Power Feed
F3	10 Amp Red	HEV Assy Trans/DTCM/ ESP/ PCM/TPIM/Trans Pump Controller/HVAC AUX Pump/Power Steering Pump/Fuel Pump Relay
F4	10 Amp Red	Sw_Pwr_Mirror/ Mod_Window_FT_LT/ Mod_Window_FT_RT
F5	(2) 10 Amp Red	Airbags (two Fuses in Yellow Holder)
F6	2 Amp Clear	Low Current Ignition Switch

F7	25 Amp Natural	Radio Battery Feed
F8	10 Amp Red	Humidity Sensor/IR_AZC Driver Sensor/Inside Rear View Mirror/Driver Heated Seat/Passenger Heated Seat
F9	10 Amp Red	Module Video Screen
F10	Spare	Spare
F11	10 Amp Red	Heated Mirrors
F12	20 Amp Yellow	Cluster Battery Feed, Door Locks
F13	10 Amp Red	Rear HVAC Control Head/Rear HVAC Relay/ EBL Relay

F14	10 Amp Red	Clockspring/Stop Lamp Switch Relay/TPMS Tran- sponder
F15	15 Amp Blue	Compass/EVIC Module/ Wireless_SKREEM VTA/ HEV Diagnostic Port
F16	20 Amp Yel- low	Reconfigurable Power Outlets
F17	20 Amp Yel- low	Rear Park Assist
F18	20 Amp Yel- low	Cigar Lighter Ignition
F19	Spare Fuse	Spare Fuse
F20	15 Amp Blue	Heating & Air Condition- ing w/ATC Only Battery Feed
F21	25 Amp Natural	Amplifier Battery Feed

### Power Distribution Center

Your vehicle is equipped with an electrical power distribution center located in the left side of the engine compartment.

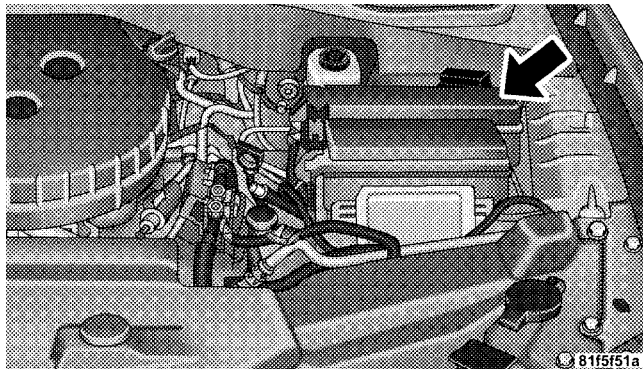

### Power Distribution Center

This center contains cartridge fuses, mini-fuses and relays. A description of each fuse and component may be

stamped on the inside cover, otherwise the cavity number of each fuse is stamped on the inside cover that corresponds to the following chart. These fuses and relays can be obtained from your authorized dealer.

Cavity	Cartridge Fuse/ Relay	Mini-Fuse	Description
1	Spare Fuse		N/A
2	30 Amp Pink		Front Wipers
3	40 Amp Green		Electric Brake Feed
4	50 Amp Red		Mini Fuses Section C Feed
5	40 Amp Green		Power Seats
6	30 Amp Pink		Run Remote Relay Feed

Cavity	Cartridge Fuse/ Relay	Mini-Fuse	Description
7	40 Amp Green		HVAC Blower Relay Feed
8	40 Amp Green		ACC Delay Relay Feed
9	30 Amp Pink		DTCM (Drivetrain Control Module)
10	30 Amp Pink		ASD Relay Feed
11	40 Amp Green		Power Liftgate
12	40 Amp Green		EBL/Power Outlets
13	30 Amp Pink		JB Feed Rear Blower
14	40 Amp Green		ABS/ESP Hydraulic Pump



Cavity	Cartridge Fuse/ Relay	Mini-Fuse	Description
15	60 Amp Yellow		JB Feed (Interior)
16		Spare	N/A
17		10 Amp Red	TPIM (Traction Power Inverter Module) Pump
18		20 Amp Yellow	Fuel Pump Relay Feed
19		20 Amp Yellow	HGM (Hybrid Gateway Module)
20		25 Amp Clear	Power Inverter
21		30 Amp Green	RBS (Regenerative Brake System) Module Feed
22		20 Amp Yellow	NGC (Next Generation Controller) Batt

Cavity	Cartridge Fuse/ Relay	Mini-Fuse	Description
23		20 Amp Yellow	Trailer Tow
24		Spare	N/A
25		15 Amp Blue	Stop Lamp Switch
26		Spare	N/A
27		20 Amp Yellow	Run/Start Relay Feed
28		Spare	N/A
29	Micro-Relay		Run Start
30	Micro-Relay		Run Remote
31	Spare Mini-Relay		N/A

Cavity	Cartridge Fuse/ Relay	Mini-Fuse	Description
32	Micro-Relay		Fuel Pump-2
33	Micro-Relay		Stop Lamp Switch
34	Spare Micro-Relay		N/A
35	Micro-Relay		Fuel Pump
36	Spare-Micro-Relay		N/A
37	Spare-Micro-Relay		N/A
38		20 Amp Yellow	BPCM Fan

Cavity	Cartridge Fuse/ Relay	Mini-Fuse	Description
39		10 Amp Red	BPCM Logic
40		20 Amp Yellow	ASSY TRANS
41		10 Amp Red	TPIM Pin 7/56
42		10 Amp Red	TPIM Pin 6/56
43		10 Amp Red	HVAC Pump
44	Mini-Relay		Blower Motor
45	Mini-Relay		ASD

## Power Distribution Center 2

Your vehicle is equipped with a second electrical power distribution center located in the left side of the engine compartment.

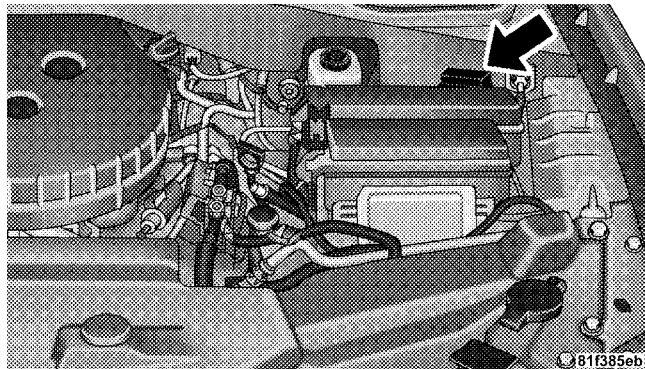

**Power Distribution Center 2**

This center contains maxi fuses and a relay. A description of each fuse and component may be stamped on the

inside cover, otherwise the cavity number of each fuse is stamped on the inside cover that corresponds to the following chart. These fuses and relays can be obtained from your authorized dealer.

Cavity	Cartridge Fuse/ Relay	Maxi-Fuse	Description
1	Solid State Relay		Electric Vacuum Pump
2		40 Amp Orange	Transmission Pump Control Module (TPCM)
3		25 Amp Circuit Breaker	Electric Vacuum Pump
4		80 Amp Natural	Electric Power Steering

## Integrated Power Module

An integrated power module is located in the left side of the engine compartment.

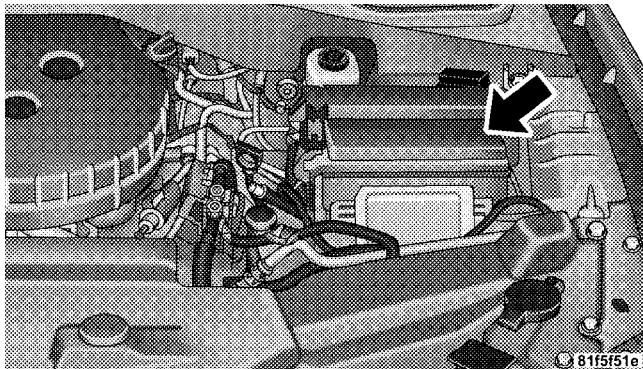

**Integrated Power Module**

This center contains cartridge fuses, mini-fuses and relays. A description of each fuse and component may be

stamped on the inside cover, otherwise the cavity number of each fuse is stamped on the inside cover that corresponds to the following chart.

Cavity	Cartridge Fuse/ Relay	Mini-Fuse	Description
1	Relay		Wiper On/Off Rly
2	Relay		Wiper Hi/Lo Rly
3	Relay		Horn Rly
4	Relay		Rear Wiper Rly
5	Relay		Lt Trailer-Tow Stop/ Turn Rly
6	Relay		Rt Trailer-Tow Stop/ Turn Rly
7	Relay		Park Lamps Rly
8		10 Amp Red	Lt Park Lamps

Cavity	Cartridge Fuse/ Relay	Mini-Fuse	Description
9		10 Amp Red	Trailer-Tow Park Lamps
10		10 Amp Red	Rt Park Lamps
11	Relay		Radiator Fan Hi Rly
12		20 Amp Yellow	Front Control Module (FCM) Batt #4
13		20 Amp Yellow	Front Control Module (FCM) Batt #2
14		Spare	Spare
15		20 Amp Yellow	Ft Fog Lamps
16		20 Amp Yellow	Horn

Cavity	Cartridge Fuse/ Relay	Mini-Fuse	Description
17		20 Amp Yellow	Rear Wiper
18		20 Amp Yellow	Front Control Module (FCM) Batt #1
19		20 Amp Yellow	Lt Trailer-Tow Stop/ Turn
20		20 Amp Yellow	Front Control Module (FCM) Batt #3
21		20 Amp Yellow	Rt Trailer-Tow Stop/ Turn
22	30 Amp Pink		Front Control Module (FCM) BATT # 5
23	40 Amp Green		Radiator Fan
24	Relay		Radiator Fan Lo Rly

Cavity	Cartridge Fuse/ Relay	Mini-Fuse	Description
25	Relay		Ft Fog Lamps Rly
26	Relay		Adjustable Pedal Rly
27		30 Amp Green	Ignition Off Draw (IOD) #1
28		30 Amp Green	Ignition Off Draw (IOD) #2

Cavity	Cartridge Fuse/ Relay	Mini-Fuse	Description
29			Spare
30			Spare

## FLUIDS AND CAPACITIES

	U.S.	Metric
<b>Fuel (Approximate)</b>	27 Gallons	102 Liters
<b>Engine Oil with Filter</b>		
SAE 5W-20, API Certified	7 Quarts	6.6 Liters
<b>Cooling System (Includes 2.1 Qts./2 L for Coolant Bottle)</b>		
5.7L with Rear Heat (MOPAR® Antifreeze/Coolant 5 Year/100,000 Mile Formula)	16.6 Quarts	15.8 Liters
TPIM Coolant System	2.3 Quarts	2.2 Liters

**NOTE:** All fluid capacities are approximate.

**FLUIDS, LUBRICANTS AND GENUINE PARTS****Engine**

<b>Component</b>	<b>Fluid, Lubricant, or Genuine Part</b>
TPIM Coolant	MOPAR® Antifreeze/Coolant 5 Year/100,000 Mile Formula HOAT (Hybrid Organic Additive Technology)
Engine Oil Filter	MOPAR® Engine Oil Filter (P/N 04884899AB) or equivalent.
Spark Plugs	PLZFR5B—13EG (Gap 0.050 in [1.3 mm])
Fuel Selection	87 Octane



## Chassis

Component	Fluid, Lubricant, or Genuine Part
2-Mode Hybrid Transmission	Dexron® VI Automatic Transmission Fluid
Transfer Case	MOPAR® ATF+4 Automatic Transmission Fluid
Front Axle	SAE 75W-90 Multi-Purpose Type, GL-5 Gear Lubricant or equivalent
Rear Axle	SAE 75W-90 Multi-Purpose Type, GL-5 Gear Lubricant or equivalent
Brake Master Cylinder	MOPAR® DOT 3 and SAE J1703 should be used or equivalent. If DOT 3 brake fluid is not available, then DOT 4 is acceptable. Use only recommended brake fluids.
Power Steering Reservoir	Pentosin CHF-11S Power Steering Fluid



---

# MAINTENANCE SCHEDULES

## CONTENTS

---

■ Maintenance Schedule . . . . .	114	□ Required Maintenance Intervals . . . . .	115
----------------------------------	-----	--	-----

## MAINTENANCE SCHEDULE

The oil change indicator system will remind you that it is time to take your vehicle in for scheduled maintenance.

On Electronic Vehicle Information Center (EVIC) equipped vehicle's "Oil Change Required" will be displayed in the EVIC and a single chime will sound, indicating that an oil change is necessary.

On non-EVIC equipped vehicle's "Change Oil" will flash in the instrument cluster odometer and a single chime will sound, indicating that an oil change is necessary.

Based on engine operation conditions the oil change indicator message will illuminate, this means that service is required for your vehicle. Have your vehicle serviced as soon as possible, within the next 500 miles (805 km).

### NOTE:

- The oil change indicator message will not monitor the time since the last oil change. Change your vehicle's

oil if it has been 6 months since your last oil change even if the oil change indicator message is NOT illuminated.

- Change your engine oil more often if you drive your vehicle off-road for an extended period of time.
- Under no circumstances should oil change intervals exceed 6,000 miles (10 000 km) or 6 months, whichever comes first.

Your authorized dealer will reset the oil change indicator message after completing the scheduled oil change. If this scheduled oil change is performed by someone other than your authorized dealer the message can be reset by referring to the steps described in "Oil Change Required — If Equipped" under "System Status (EVIC Displays)" of the Electronic Vehicle Information Center (EVIC) — If Equipped" in Section 4 of the Owner's Manual or under "Odometer/Trip Odometer" in the "Instrument Cluster Descriptions" section of this supplement.

*At Each Stop for Fuel*

- Check the engine oil level about five minutes after a fully warmed engine is shut off. Checking the oil level while the vehicle is on level ground will improve the accuracy of the oil level reading. Add oil only when the level is at or below the ADD or MIN mark.
- Check the windshield washer solvent and add if required.

*Once a Month*

- Check tire pressure and look for unusual wear or damage.
- Check the fluid levels of coolant reservoir, brake master cylinder, add as needed.
- Check all lights and other electrical items for correct operation.

*At Each Oil Change*

- Change the engine oil filter.
- Inspect the brake hoses and lines.

**CAUTION!**

**Failure to perform the required maintenance items may result in damage to the vehicle.**

**Required Maintenance Intervals**



**18,000 Miles (30,000 km) or  
18 Months Maintenance  
Service Schedule**

- Change the engine oil and engine oil filter.
- Rotate tires.
- Inspect the front and rear axle fluid; change if using your vehicle for police, taxi, fleet, off-road or frequent trailer towing.

\_\_\_\_\_  
Odometer Reading Date

\_\_\_\_\_  
Repair Order # Dealer Code

\_\_\_\_\_  
Signature Authorized Chrysler Dealer

**24,000 Miles (40,000 km) or  
24 Months Maintenance  
Service Schedule**

- Change the engine oil and engine oil filter.
- Rotate tires.
- If using your vehicle for any of the following: Dusty or off-road conditions. Inspect the engine air cleaner filter; replace if necessary.
- Inspect the brake linings; replace if necessary.
- Inspect the CV joints.
- Inspect exhaust system.
- Inspect the front suspension, tie rod ends and boot seals; replace if necessary.

\_\_\_\_\_  
Odometer Reading Date

\_\_\_\_\_  
Repair Order # Dealer Code

\_\_\_\_\_  
Signature Authorized Chrysler Dealer

**30,000 Miles (50,000 km) or  
30 Months Maintenance  
Service Schedule**

- Change the engine oil and engine oil filter.
- Rotate tires.
- Replace the engine air cleaner filter.
- Inspect the transfer case fluid.

\_\_\_\_\_  
Odometer Reading Date

\_\_\_\_\_  
Repair Order # Dealer Code

\_\_\_\_\_  
Signature Authorized Chrysler Dealer

### 36,000 Miles (60,000 km) or 36 Months Maintenance Service Schedule

- Change the engine oil and engine oil filter.
- Rotate tires.
- If using your vehicle for any of the following: Dusty or off-road conditions. Inspect the engine air cleaner filter; replace if necessary.
- Inspect the brake linings; replace if necessary.
- Inspect the front and rear axle fluid; change if using your vehicle for police, taxi, fleet, off-road or frequent trailer towing.

---

Odometer Reading Date

---

Repair Order # Dealer Code

---

Signature Authorized Chrysler Dealer

### 42,000 Miles (70,000 km) or 42 Months Maintenance Service Schedule

- Change the engine oil and engine oil filter.
- Rotate tires.

---

Odometer Reading Date

---

Repair Order # Dealer Code

---

Signature Authorized Chrysler Dealer

### 48,000 Miles (80,000 km) or 48 Months Maintenance Service Schedule

- Change the engine oil and engine oil filter.
- Rotate tires.
- If using your vehicle for any of the following: Dusty or off-road conditions. Inspect the engine air cleaner filter; replace if necessary.
- Inspect the brake linings; replace if necessary.
- Inspect the CV joints.
- Inspect exhaust system.
- Inspect the front suspension, tie rod ends and boot seals; replace if necessary.

---

Odometer Reading Date

---

Repair Order # Dealer Code

---

Signature Authorized Chrysler Dealer



**54,000 Miles (90,000 km) or 54 Months Maintenance Service Schedule**

- Change the engine oil and engine oil filter.
- Rotate tires.
- Inspect the front and rear axle fluid; change if using your vehicle for police, taxi, fleet, off-road or frequent trailer towing.

\_\_\_\_\_  
Odometer Reading Date

\_\_\_\_\_  
Repair Order # Dealer Code

\_\_\_\_\_  
Signature Authorized Chrysler Dealer

**60,000 Miles (100,000 km) or 60 Months Maintenance Service Schedule**

- Change the engine oil and engine oil filter.
- Rotate tires.
- Replace the engine air cleaner filter.
- Inspect the brake linings; replace if necessary.
- Change the automatic transmission fluid and filter if using your vehicle for any of the following: police, taxi, fleet or frequent trailer towing.
- Change the transfer case fluid if using your vehicle for any of the following: police, taxi, fleet, off-road or frequent trailer towing.
- Flush and replace the engine coolant at 60 months if not done at 102,000 miles (170 000 km).

\_\_\_\_\_  
Odometer Reading Date

\_\_\_\_\_  
Repair Order # Dealer Code

\_\_\_\_\_  
Signature Authorized Chrysler Dealer

### 66,000 Miles (110,000 km) or 66 Months Maintenance Service Schedule

- Change the engine oil and engine oil filter.
- Rotate tires.

\_\_\_\_\_  
Odometer Reading Date

\_\_\_\_\_  
Repair Order # Dealer Code

\_\_\_\_\_  
Signature Authorized Chrysler Dealer

### 72,000 Miles (120,000 km) or 72 Months Maintenance Service Schedule

- Change the engine oil and engine oil filter.
- Rotate tires.
- If using your vehicle for any of the following: Dusty or off-road conditions. Inspect the engine air cleaner filter; replace if necessary.
- Inspect the brake linings; replace if necessary.
- Inspect the CV joints.
- Inspect the front and rear axle fluid; change if using your vehicle for police, taxi, fleet, off-road or frequent trailer towing.
- Inspect exhaust system.
- Inspect the front suspension, tie rod ends and boot seals; replace if necessary.

\_\_\_\_\_  
Odometer Reading Date

\_\_\_\_\_  
Repair Order # Dealer Code

\_\_\_\_\_  
Signature Authorized Chrysler Dealer

**78,000 Miles (130,000 km) or  
78 Months Maintenance  
Service Schedule**

- Change the engine oil and engine oil filter.
- Rotate tires.

\_\_\_\_\_  
Odometer Reading Date

\_\_\_\_\_  
Repair Order # Dealer Code

\_\_\_\_\_  
Signature Authorized Chrysler Dealer

**84,000 Miles (140,000 km) or  
84 Months Maintenance  
Service Schedule**

- Change the engine oil and engine oil filter.
- Rotate tires.
- If using your vehicle for any of the following: Dusty or off-road conditions. Inspect the engine air cleaner filter; replace if necessary.
- Inspect the brake linings; replace if necessary.

\_\_\_\_\_  
Odometer Reading Date

\_\_\_\_\_  
Repair Order # Dealer Code

\_\_\_\_\_  
Signature Authorized Chrysler Dealer

**90,000 Miles (150,000 km) or  
90 Months Maintenance  
Service Schedule**

- Change the engine oil and engine oil filter.
- Rotate tires.
- Replace the engine air cleaner filter.
- Inspect and replace PCV valve if necessary.** †
- Inspect the transfer case fluid.
- Inspect the front and rear axle fluid; change if using your vehicle for police, taxi, fleet, off-road or frequent trailer towing.

\_\_\_\_\_  
Odometer Reading Date

\_\_\_\_\_  
Repair Order # Dealer Code

\_\_\_\_\_  
Signature Authorized Chrysler Dealer

### 96,000 Miles (160,000 km) or 96 Months Maintenance Service Schedule

- Change the engine oil and engine oil filter.
- Rotate tires.
- If using your vehicle for any of the following: Dusty or off-road conditions. Inspect the engine air cleaner filter; replace if necessary.
- Inspect the brake linings; replace if necessary.
- Inspect the CV joints.
- Inspect exhaust system.
- Inspect the front suspension, tie rod ends and boot seals; replace if necessary.

---

Odometer Reading Date

---

Repair Order # Dealer Code

---

Signature Authorized Chrysler Dealer

### 102,000 Miles (170,000 km) or 102 Months Maintenance Service Schedule

- Change the engine oil and engine oil filter.
- Rotate tires.
- Replace the spark plugs.**
- Flush and replace the engine coolant if not done at 60 months.
- Flush and replace the Traction Power Inverter Module (TPIM) coolant.

---

Odometer Reading Date

---

Repair Order # Dealer Code

---

Signature Authorized Chrysler Dealer

### 108,000 Miles (180,000 km) or 108 Months Maintenance Service Schedule

- Change the engine oil and engine oil filter.
- Rotate tires.
- If using your vehicle for any of the following: Dusty or off-road conditions. Inspect the engine air cleaner filter; replace if necessary.
- Inspect the brake linings; replace if necessary.
- Inspect the front and rear axle fluid; change if using your vehicle for police, taxi, fleet, off-road or frequent trailer towing.

---

Odometer Reading Date

---

Repair Order # Dealer Code

---

Signature Authorized Chrysler Dealer

**114,000 Miles (190,000 km) or  
114 Months Maintenance  
Service Schedule**

- Change the engine oil and engine oil filter.
- Rotate tires.

\_\_\_\_\_  
Odometer Reading Date

\_\_\_\_\_  
Repair Order # Dealer Code

\_\_\_\_\_  
Signature Authorized Chrysler Dealer

**120,000 Miles (200,000 km) or 120 Months Maintenance Service  
Schedule**

- Change the engine oil and engine oil filter.
- Rotate tires.
- Replace the engine air cleaner filter.
- Inspect the brake linings; replace if necessary.
- Inspect the CV joints.
- Inspect exhaust system.
- Inspect the front suspension, tie rod ends and boot seals; replace if necessary.
- Change the transfer case fluid if using your vehicle for any of the following: police, taxi, fleet, off-road or frequent trailer towing.
- Change the automatic transmission fluid and filter.
- Inspect water pump drive belt; replace if necessary.

\_\_\_\_\_  
Odometer Reading Date

\_\_\_\_\_  
Repair Order # Dealer Code

\_\_\_\_\_  
Signature Authorized Chrysler Dealer

### 126,000 Miles (210,000 km) or 126 Months Maintenance Service Schedule

- Change the engine oil and engine oil filter.
- Rotate tires.
- Inspect the front and rear axle fluid; change if using your vehicle for police, taxi, fleet, off-road or frequent trailer towing.

---

Odometer Reading Date

---

Repair Order # Dealer Code

---

Signature Authorized Chrysler Dealer

### 132,000 Miles (220,000 km) or 132 Months Maintenance Service Schedule

- Change the engine oil and engine oil filter.
- Rotate tires.
- If using your vehicle for any of the following: Dusty or off-road conditions. Inspect the engine air cleaner filter; replace if necessary.
- Inspect the brake linings; replace if necessary.

---

Odometer Reading Date

---

Repair Order # Dealer Code

---

Signature Authorized Chrysler Dealer

### 138,000 Miles (230,000 km) or 138 Months Maintenance Service Schedule

- Change the engine oil and engine oil filter.
- Rotate tires.

---

Odometer Reading Date

---

Repair Order # Dealer Code

---

Signature Authorized Chrysler Dealer

**144,000 Miles (240,000 km) or 144 Months Maintenance Service Schedule**

- Change the engine oil and engine oil filter.
- Rotate tires.
- If using your vehicle for any of the following: Dusty or off-road conditions. Inspect the engine air cleaner filter; replace if necessary.
- Inspect the brake linings; replace if necessary.
- Inspect the front and rear axle fluid; change if using your vehicle for police, taxi, fleet, off-road or frequent trailer towing.
- Inspect the CV joints.
- Inspect exhaust system.
- Inspect the front suspension, tie rod ends and boot seals; replace if necessary.

\_\_\_\_\_ Date

Odometer Reading

\_\_\_\_\_ Dealer Code

Repair Order #

\_\_\_\_\_

Signature Authorized Chrysler Dealer

**150,000 Miles (250,000 km) or 150 Months Maintenance Service Schedule**

- Change the engine oil and engine oil filter.
- Rotate tires.
- Replace the engine air cleaner filter.
- Inspect the transfer case fluid.

\_\_\_\_\_ Date

Odometer Reading

\_\_\_\_\_ Dealer Code

Repair Order #

\_\_\_\_\_

Signature Authorized Chrysler Dealer

† This maintenance is recommended by the manufacturer to the owner, but is not required to maintain emissions warranty.

**WARNING!**

You can be badly injured working on or around a motor vehicle. Do only that service work for which you have the knowledge and the right equipment. If you have any doubt about your ability to perform a service job, take your vehicle to a competent mechanic.



---

# INDEX

ABS (Anti-Lock Brake System) . . . . .	26	Axle Lubrication (Axle Fluid) . . . . .	96
Air Conditioning . . . . .	42	Battery . . . . .	88
Air Conditioning, Operating Tips . . . . .	50	Charging . . . . .	77
Air Filter . . . . .	88	Emergency Starting . . . . .	77
Airbag . . . . .	34	Gas Caution . . . . .	78,84
Alarm (Security Alarm) . . . . .	25	Hybrid (300V) . . . . .	14
Antifreeze (Engine Coolant) . . . . .	109	Brake Control System, Electronic . . . . .	64
Anti-Lock Warning Light . . . . .	26	Brake Fluid . . . . .	111
Anti-Theft System . . . . .	25	Brake System	
Appearance Care . . . . .	97	Regenerative . . . . .	10
Assist, Hill Start . . . . .	64	Warning Light . . . . .	26,30
Automatic Transaxle . . . . .	58	Brake/Transmission Interlock . . . . .	58
Automatic Transmission . . . . .	95	Capacities, Fluid . . . . .	109
Fluid and Filter Changes . . . . .	95	Car Washes . . . . .	97
Fluid Level Check . . . . .	95	Charging . . . . .	77
Fluid Type . . . . .	111	Circuit Breakers . . . . .	98
Gear Ranges . . . . .	58	Climate Control . . . . .	42
Special Additives . . . . .	95		
Axle Fluid . . . . .	111		

Climate Control, Rear Zone . . . . .	48	Emergency, In Case of	
Coolant Pressure Cap (Radiator Cap) . . . . .	88	Jacking . . . . .	70
Cooling System		Engine	
Coolant Capacity . . . . .	109	Compartment . . . . .	88
Selection of Coolant (Antifreeze) . . . . .	109,110	Coolant (Antifreeze) . . . . .	110
Temperature Gauge . . . . .	23	Fuel Requirements . . . . .	109
Defroster, Windshield . . . . .	46,47	Jump Starting . . . . .	77
Dimmer Switch, Headlight . . . . .	24	Oil . . . . .	109,110
Dipsticks		Oil Filler Cap . . . . .	88
Automatic Transmission . . . . .	95	Oil Selection . . . . .	109
Disabled Vehicle Towing . . . . .	86	Starting . . . . .	56
Disposal		Temperature Gauge . . . . .	23
Hybrid 300V Battery . . . . .	15	Filters	
Driving to Achieve Maximum Fuel Economy . . . . .	11	Engine Oil . . . . .	110
Electrical Power Outlets . . . . .	20	Flashers	
Electronic Brake Control System . . . . .	64	Turn Signal . . . . .	23
		Flat Tire Stowage . . . . .	69,76
		Fluid, Brake . . . . .	111

Fluid Capacities . . . . .	109	Odometer . . . . .	27,28
Fluid Level Checks		Speedometer . . . . .	25
Automatic Transmission . . . . .	95	Gear Ranges . . . . .	58
Transfer Case . . . . .	96	High Beam Indicator . . . . .	24
Fluids, Lubricants and Genuine Parts . . . . .	110	Hill Start Assist . . . . .	64
Four Wheel Drive . . . . .	62	Hybrid 300V Battery . . . . .	14
Operation . . . . .	62	Hybrid (300V) Battery Disposal . . . . .	15
Front Axle (Differential) . . . . .	97	Hybrid System . . . . .	7
Fuel		Important Information . . . . .	12
Gauge . . . . .	23	Hybrid System Operation . . . . .	7
Octane Rating . . . . .	110	Hybrid System Regenerative Brake System . . . . .	10
Requirements . . . . .	109	Ignition	
Tank Capacity . . . . .	109	Key . . . . .	6
Fuses . . . . .	98,99,101,105,106	Important Hybrid System Information . . . . .	12
Gas Gauge (Fuel Gauge) . . . . .	23	In the Event of an Accident . . . . .	16
Gauges		Instrument Cluster . . . . .	23
Coolant Temperature . . . . .	23	Integrated Power Module (Fuses) . . . . .	106
Fuel . . . . .	23		

Interior Fuses . . . . .	99	Low Fuel . . . . .	23,24
Introduction . . . . .	4	Malfunction Indicator (Check Engine) . . . . .	31
Jack Operation . . . . .	68,70	Seat Belt Reminder . . . . .	24
Jacking Instructions . . . . .	72	Tire Pressure Monitoring (TPMS) . . . . .	32
Jump Assist . . . . .	16,77	Warning (Instrument Cluster Description) . . . . .	23
Jump Assist Procedure . . . . .	16,77	Locks	
Jump Starting . . . . .	16	Keys . . . . .	6
Keys . . . . .	6	Lug Nuts . . . . .	75
Lane Change and Turn Signals . . . . .	23	Maintenance Procedures . . . . .	89
Lights		Maintenance Schedule . . . . .	114
Airbag . . . . .	34	Malfunction Indicator Light (Check Engine) . . . . .	31
Anti-Lock Warning . . . . .	26	Manual Transmission	
Brake Warning . . . . .	30	Lubricant Selection . . . . .	111
Cruise . . . . .	34	Oil Change Indicator . . . . .	28
Fog . . . . .	29	Oil Change Indicator, Reset . . . . .	28
Instrument Cluster . . . . .	23	Oil, Engine . . . . .	110
		Capacity . . . . .	109

Filter	110	Schedule, Maintenance	114
Recommendation	109	Seat Belts	
Viscosity	109	Reminder	24
Overdrive	27	Security Alarm (Theft Alarm)	25
Overheating, Engine	25	Selection of Coolant (Antifreeze)	110
Power		Service and Maintenance	89
Distribution Center (Fuses)	88,101,105	Shifting	
Outlet (Auxiliary Electrical Outlet)	20	Transfer Case	62
Steering	63	Signals, Turn	23
Steering Filler Cap	88	Speedometer	25
Power Steering Fluid	111	Starting	56
Preparation for Jacking	71	Emergency (Jump Starting)	16,77
Rear Axle (Differential)	96	Starting Procedures	56
Recreational Towing	66	Steering	
Regenerative Brake System	10	Power	63
Resetting Oil Change Indicator	28	Temperature Control, Automatic (ATC)	42
		Temperature Gauge, Engine Coolant	23

Tires			
Changing	68	Filter	95
Jacking	70	Fluid	111
Pressure Warning Light	32	Maintenance	95
Spare Tire	69	Trip Odometer	28
Wheel Mounting	70	Trip Odometer Reset Button	35
Wheel Nut Torque	75	Turn Signals	23
Towing	86	Underhood Fuses	101,105
Disabled Vehicle	86	Warning Lights (Instrument Cluster Description)	23
Recreational	66	Washer, Adding Fluid	88
Traction Control	29	Washing Vehicle	97
Transaxle	58	Wheel Changing	68
Automatic	58	Wheel Mounting	70
Operation	58	Wheel Nut Torque	75
Transfer Case	96	Window Fogging	51
Fluid	111	Windshield Defroster	46
Four-Wheel-Drive Operation	62	Windshield Washers	
Transmission	95	Fluid	88
Automatic	95		





## **INSTALLATION OF RADIO TRANSMITTING EQUIPMENT**

Special design considerations are incorporated into this vehicle's electronic system to provide immunity to radio frequency signals. Mobile two-way radios and telephone equipment must be installed properly by trained personnel. The following must be observed during installation.

The positive power connection should be made directly to the battery and fused as close to the battery as possible. The negative power connection should be made to body sheet metal adjacent to the negative battery connection. This connection should not be fused.

Antennas for two-way radios should be mounted on the roof or the rear area of the vehicle. Care should be used in mounting antennas with magnet bases. Magnets may affect the accuracy or operation of the compass on vehicles so equipped.

The antenna cable should be as short as practical and routed away from the vehicle wiring when possible. Use only fully shielded coaxial cable.

Carefully match the antenna and cable to the radio to ensure a low Standing Wave Ratio (SWR).

Mobile radio equipment with output power greater than normal may require special precautions.

All installations should be checked for possible interference between the communications equipment and the vehicle's electronic systems.



**Stick with the Specialists<sup>®</sup>**



Chrysler LLC

81-326-0937



Second Edition

Printed in U.S.A.

## Free Manuals Download Website

<http://myh66.com>

<http://usermanuals.us>

<http://www.somanuals.com>

<http://www.4manuals.cc>

<http://www.manual-lib.com>

<http://www.404manual.com>

<http://www.luxmanual.com>

<http://aubethermostatmanual.com>

Golf course search by state

<http://golfingnear.com>

Email search by domain

<http://emailbydomain.com>

Auto manuals search

<http://auto.somanuals.com>

TV manuals search

<http://tv.somanuals.com>