



DODGE

2008

OWNER'S MANUAL

Avenger

VEHICLES SOLD IN CANADA

With respect to any Vehicles Sold in Canada, the name Chrysler LLC shall be deemed to be deleted and the name Chrysler Canada Inc. used in substitution therefor.

DRIVING AND ALCOHOL

Drunken driving is one of the most frequent causes of accidents.

Your driving ability can be seriously impaired with blood alcohol levels far below the legal minimum. If you are drinking, don't drive. Ride with a designated non-drinking driver, call a cab, a friend, or use public transportation.

WARNING!

Driving after drinking can lead to an accident. Your perceptions are less sharp, your reflexes are slower, and your judgment is impaired when you have been drinking. Never drink and then drive.

This manual illustrates and describes the operation of features and equipment that are either standard or optional on this vehicle. This manual may also include a description of features and equipment that are no longer available or were not ordered on this vehicle. Please disregard any features and equipment described in this manual that are not on this vehicle.

Chrysler LLC reserves the right to make changes in design and specifications, and/or make additions to or improvements to its products without imposing any obligation upon itself to install them on products previously manufactured.

Copyright © 2007 Chrysler LLC



TABLE OF CONTENTS

SECTION		PAGE	
1	INTRODUCTION	3	1
2	THINGS TO KNOW BEFORE STARTING YOUR VEHICLE	9	2
3	UNDERSTANDING THE FEATURES OF YOUR VEHICLE	81	3
4	UNDERSTANDING YOUR INSTRUMENT PANEL	163	4
5	STARTING AND OPERATING	257	5
6	WHAT TO DO IN EMERGENCIES	347	6
7	MAINTAINING YOUR VEHICLE	365	7
8	MAINTENANCE SCHEDULES	425	8
9	IF YOU NEED CONSUMER ASSISTANCE	433	9
10	INDEX	443	10

INTRODUCTION

CONTENTS

■ Introduction	4	■ Vehicle Identification Number	6
■ How To Use This Manual	4	■ Vehicle Modifications/Alterations	7
■ Warnings And Cautions	6		

INTRODUCTION

This Owner's Manual has been prepared with the assistance of service and engineering specialists to acquaint you with the operation and maintenance of your vehicle. It is supplemented by a Warranty Information Booklet and various customer-oriented documents. You are urged to read these publications carefully. Following the instructions and recommendations in this manual will help assure safe and enjoyable operation of your vehicle.

NOTE: After you read the manual, it should be stored in the vehicle for convenient reference and remain with the vehicle when sold, so that the new owner will be aware of all safety warnings.

When it comes to service, remember that your authorized dealer knows your vehicle best, has the factory-trained technicians and genuine Mopar® parts, and is interested in your satisfaction.

HOW TO USE THIS MANUAL

Consult the table of contents to determine which section contains the information you desire.

The detailed index, at the rear of this manual, contains a complete listing of all subjects.

Consult the following table for a description of the symbols that may be used on your vehicle or throughout this owner manual:

											ESP BAS ELECTRONIC STABILITY PROGRAM / BRAKE ASSIST SYSTEM
											BRAKE BRAKE SYSTEM WARNING PARKING BRAKE
										AWD! ALL WHEEL DRIVE	(ABS) FAILURE OF ANTI-LOCK BRAKING SYSTEM
										4WD! FOUR WHEEL DRIVE	BRAKE BRAKE SYSTEM WARNING PARKING BRAKE
										WARNING TOW / HAUL	TOW/HAUL TOW / HAUL
										HAZARD HAZARD	4 LOW FOUR WHEEL DRIVE LOW
			SRS AIRBAG SUPPLEMENTAL RESTRAINT SYSTEM								8191e970

WARNINGS AND CAUTIONS

This manual contains **WARNINGS** against operating procedures that could result in an accident or bodily injury. It also contains **CAUTIONS** against procedures that could result in damage to your vehicle. If you do not read this entire manual you may miss important information. Observe all Warnings and Cautions.

VEHICLE IDENTIFICATION NUMBER

The Vehicle Identification Number (VIN) is found on the left front corner of the instrument panel, visible through the windshield. This number also appears on the vehicle registration and title.

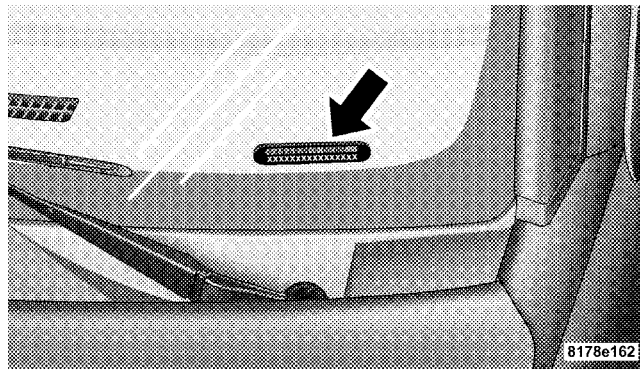

Vehicle Identification Number

VEHICLE MODIFICATIONS/ALTERATIONS

WARNING!

Any modifications or alterations to this vehicle could seriously affect its roadworthiness and safety and may lead to an accident resulting in serious injury or death.

THINGS TO KNOW BEFORE STARTING YOUR VEHICLE

CONTENTS

■ A Word About Your Keys	12	□ Rearming The System	18
□ Ignition Key Removal	12	□ To Arm The System	18
□ Key-In-Ignition Reminder	14	□ To Disarm The System	19
□ Locking Doors With The Key	14	■ Illuminated Entry System — If Equipped	20
■ Sentry Key®	14	■ Remote Keyless Entry — If Equipped	21
□ Replacement Keys	16	□ To Unlock The Doors	22
□ Customer Key Programming	16	□ To Lock The Doors	24
□ General Information	17	□ To Unlatch The Trunk	25
■ Security Alarm System — If Equipped	18		

10 THINGS TO KNOW BEFORE STARTING YOUR VEHICLE

□ Using The Express Down Windows Feature — If Equipped	25	□ Power Window Switches	35
□ Using The Panic Alarm	25	□ Auto Window Down — If Equipped	36
□ Programming Additional Transmitters	26	□ Auto Window Up — If Equipped	37
□ Battery Replacement	26	□ Reset Auto Up	37
□ General Information	27	□ Window Lockout Switch	38
■ Remote Start System — If Equipped	28	□ Wind Buffeting	38
□ How To Use Remote Start	29	■ Trunk Release	39
■ Door Locks	30	■ Trunk Safety Warning	39
□ Manual Door Locks	30	□ Trunk Internal Emergency Release	40
□ Power Door Locks	32	■ Occupant Restraints	40
□ “Child-Protection” Door Lock System (Rear Doors)	34	□ Lap/Shoulder Belts	42
■ Power Windows	35	□ Adjustable Upper Shoulder Belt Anchorage	47
		□ Rear Seat Belts	48

□ Seat Belt Pretensioners48
□ Enhanced Seat Belt Reminder System (BeltAlert®)48
□ BeltAlert® Programming49
□ Automatic Locking Mode50
□ Seat Belts And Pregnant Women50
□ Supplemental Restraint System (SRS) - Airbag .	.51
□ Airbag System Components52
□ Front Seat Airbag Features53
□ Airbag Deployment Sensors And Controls59

THINGS TO KNOW BEFORE STARTING YOUR VEHICLE 11

□ Event Data Recorder (EDR)65
□ Child Restraint67
■ Engine Break-In Recommendations78
■ Safety Tips78
□ Exhaust Gas78
□ Safety Checks You Should Make Inside The Vehicle79
□ Periodic Safety Checks You Should Make Outside The Vehicle80

A WORD ABOUT YOUR KEYS

The dealer that sold you your new vehicle has the key code numbers for your vehicle locks. These numbers can be used to order duplicate keys from your dealer. Ask your dealer for these numbers and keep them in a safe place.

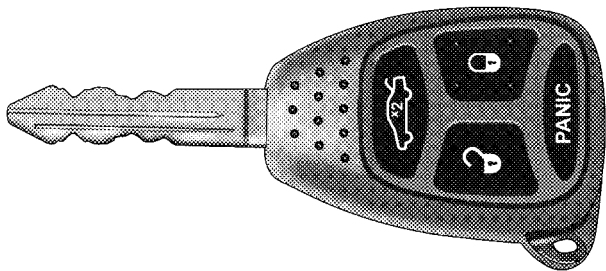

815afa1a

Vehicle Key

IGNITION KEY REMOVAL

Automatic Transaxle

Place the shift lever in PARK. Turn the ignition switch to the ACC position, push the key and cylinder inward, rotate the key to the LOCK position, and remove the key.

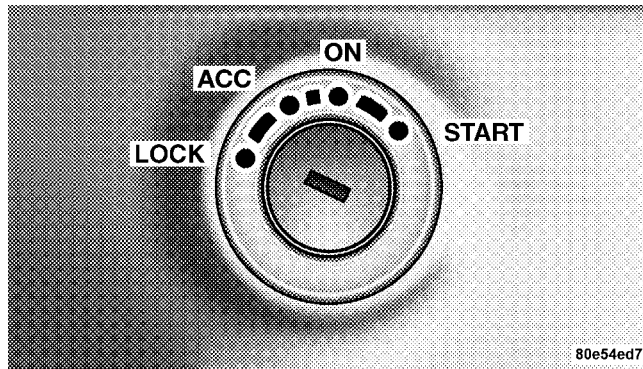

80e54ed7

Ignition Key Positions

NOTE:

- If you try to remove the key before you place the selector lever in PARK, the key may become trapped temporarily in the ignition switch lock cylinder. If this occurs, rotate the key to the right slightly, then remove the key as described. If a malfunction occurs, the system will trap the key in the ignition switch lock cylinder to warn you that this safety feature is inoperable. The engine can be started and stopped, but the key cannot be removed until you obtain service.
- For vehicles not equipped with the Electronic Vehicle Information Center (EVIC), the power window switches, radio, hands-free system (if equipped), and power outlets will remain active for approximately 45 seconds after the ignition switch is turned to the LOCK position. Opening either door will cancel this feature.
- For vehicles equipped with the Electronic Vehicle Information Center (EVIC), the power window

switches, radio, hands-free system (if equipped), and power outlets will remain active for up to 10 minutes after the ignition switch is turned to the LOCK position. Opening either door will cancel this feature. The time for this feature is programmable. For details, refer to “Key-Off Power Delay,” under “Personal Settings (Customer Programmable Features)” under “Electronic Vehicle Information Center (EVIC)” in Section 4 of this manual.

WARNING!

NEVER leave children alone in a vehicle. Leaving children in a vehicle unattended is dangerous for a number of reasons. A child or others could be seriously or fatally injured. Don't leave the keys in the ignition. A child could operate power windows, other controls, or move the vehicle

CAUTION!

An unlocked car is an invitation to thieves. Always remove key from the ignition and lock all doors when leaving the vehicle unattended.

KEY-IN-IGNITION REMINDER

Opening the driver's door when the key is in the ignition, sounds a signal to remind you to remove the key.

NOTE:

- The Key-In-Ignition reminder only sounds when the ignition key is placed in the LOCK or ACC position.
- With either front door open, and the key in the ignition, both the power door locks and Remote Keyless Entry (RKE) will not function.

LOCKING DOORS WITH THE KEY

There is only one external door lock cylinder which is located in the driver's door only.

You can insert the key with either side up. To lock the door, turn the key rearward, to unlock the door, turn the key forward. See Section 7 of this manual for door lock lubrication.

SENTRY KEY®

The Sentry Key® Immobilizer System prevents unauthorized vehicle operation by disabling the engine. The system does not need to be armed or activated. Operation is automatic, regardless of whether the vehicle is locked or unlocked.

The system uses ignition keys that have an embedded electronic chip (transponder) to prevent unauthorized vehicle operation. Therefore, only keys that are programmed to the vehicle can be used to start and operate

the vehicle. The system will shut the engine off in two seconds if someone uses an invalid key to try to start the engine.

NOTE: A key that has not been programmed is also considered an invalid key, even if it is cut to fit the ignition switch lock cylinder for that vehicle.

During normal operation, after turning on the ignition switch, the Vehicle Security Light will turn on for three seconds for a bulb check. If the light remains on after the bulb check, it indicates that there is a problem with the electronics. In addition, if the light begins to flash after the bulb check, it indicates that someone used an invalid key to try to start the engine. Either of these conditions will result in the engine being shut off after two seconds.

If the Vehicle Security Light turns on during normal vehicle operation (vehicle running for longer than 10

seconds), it indicates that there is a fault in the electronics. Should this occur, have the vehicle serviced as soon as possible.

NOTE:

- The Sentry Key® Immobilizer System is not compatible with some aftermarket remote starting systems. Use of these systems may result in vehicle starting problems and loss of security protection.
- Exxon/Mobil Speedpass™, additional Sentry Keys®, or any other transponder-equipped components on the same key chain will **not** cause a key-related (transponder) fault unless the additional part is **physically held against the ignition key** being used when starting the vehicle. Cell phones, pagers, or other RF electronics will not cause interference with this system.

All of the keys provided with your new vehicle have been programmed to the vehicle electronics.

Replacement Keys

NOTE: Only keys that are programmed to the vehicle electronics can be used to start and operate the vehicle. Once a Sentry Key® is programmed to a vehicle, it cannot be programmed to any other vehicle.

CAUTION!

Always remove the Sentry Keys® from the vehicle and lock all doors when leaving the vehicle unattended.

At the time of purchase, the original owner is provided with a four-digit Personal Identification Number (PIN). Keep the PIN in a secure location. This number is required for authorized dealer replacement of keys. Duplication of keys may be performed at an authorized dealer or by following the customer key programming

procedure. This procedure consists of programming a blank key to the vehicle electronics. A blank key is one that has never been programmed.

NOTE: When having the Sentry Key® Immobilizer System serviced, bring all vehicle keys with you to an authorized dealer.

Customer Key Programming

If you have two valid Sentry Keys®, you can program new Sentry Keys® to the system by performing the following procedure:

1. Cut the additional Sentry Key® Transponder blank(s) to match the ignition switch lock cylinder key code.
2. Insert the first valid key into the ignition switch. Turn the ignition switch to the ON position for at least three seconds, but no longer than 15 seconds. Then, turn the ignition switch to the LOCK position and remove the first key.

3. Insert the second valid key into the ignition switch. Turn the ignition switch to the ON position within 15 seconds. After 10 seconds, a chime will sound. In addition, the Vehicle Security Light will begin to flash. Turn the ignition switch to the LOCK position and remove the second key.

4. Insert a blank Sentry Key® into the ignition switch. Turn the ignition switch to the ON position within 60 seconds. After 10 seconds, a single chime will sound. In addition, the Vehicle Security Light will stop flashing. To indicate that programming is complete, the Vehicle Security Light will turn on again for three seconds and then turn off.

The new Sentry Key® is programmed. **The Remote Keyless Entry (RKE) transmitter will also be programmed during this procedure.**

Repeat this procedure to program up to eight keys. If you do not have a programmed Sentry Key®, contact your authorized dealer for details.

NOTE: If a programmed key is lost, see your authorized dealer to have all remaining keys erased from the system's memory. This will prevent the lost key from starting your vehicle. The remaining keys must then be reprogrammed. All vehicle keys must be taken to an authorized dealer at the time of service to be reprogrammed.

General Information

The Sentry Key® system complies with FCC rules Part 15 and with RSS-210 of Industry Canada. Operation is subject to the following conditions:

- This device may not cause harmful interference.

- This device must accept any interference that may be received, including interference that may cause undesired operation.

SECURITY ALARM SYSTEM — IF EQUIPPED

The Vehicle Security Alarm (VSA) system monitors the doors and trunk for unauthorized entry and ignition switch for unauthorized operation.

If something triggers the alarm, the system will signal for about 18 minutes. For the first 3 minutes, the horn will sound intermittently and the headlights, park lights, taillights and the Vehicle Security Light in the cluster will flash. Then the exterior lights will flash for another 15 minutes.

REARMING THE SYSTEM:

If something triggers the alarm, and no action is taken to disarm it, the system will turn off the horn after 3 minutes, turn off all of the visual signals after 15 minutes, and then the system will rearm itself.

TO ARM THE SYSTEM:

1. Remove the keys from the ignition switch and get out of the vehicle.
2. Lock the door using either the power door lock switch or the Keyless Entry Transmitter, and close all doors.
3. The Vehicle Security Light in the instrument cluster will flash rapidly for approximately 16 seconds. This shows that the system is arming. During this period, if a door is opened, the ignition switch is turned ON, or the power door locks are unlocked in any manner, the system

will automatically disarm. After 16 seconds, the Vehicle Security Light will flash slowly. This shows that the system is fully armed.

NOTE:

- During the 16 second arming period, if a door is opened or the ignition switch is turned ON, the system will automatically disarm.
- Once armed, the system disables the unlock switch on the driver door trim panel and passenger door trim panel, the trunk release button on the instrument panel, and the HomeLink®/Garage Door Opener (if equipped).

TO DISARM THE SYSTEM

Either press the UNLOCK button on the remote keyless entry transmitter or insert a valid sentry key into the ignition lock cylinder and turn the key to the ON/START position.

NOTE:

- The driver's door key cylinder and the trunk button on the keyless entry transmitter cannot arm or disarm the system.
- The system remains armed during trunk entry. Pressing the trunk button will not disarm the system. If someone enters the vehicle through the trunk and opens any door, the alarm will sound.
- When the system is armed, the interior power door lock switches will not unlock the doors.

The Vehicle Security Alarm system is designed to protect your vehicle; however, you can create conditions where the system will give you a false alarm. If one of the previously described arming sequences has occurred, the system will arm regardless of whether you are in the vehicle or not. If you remain in the vehicle and open a door, the alarm will sound. If this occurs, disarm the system.

If the alarm system is armed and the battery becomes disconnected the system will remain armed when the battery is reconnected. The exterior lights will flash, the horn will sound, and the ignition will not start the vehicle. If this occurs, disarm the system.

Tamper Alert

If the alarm was triggered, but the warning signals have timed out, the park and taillights flash three times (instead of the normal twice) when unlocking the vehicle with a valid Remote Keyless Entry (RKE) transmitter to alert the driver.

ILLUMINATED ENTRY SYSTEM — IF EQUIPPED

The courtesy/reading lights will turn on when you use the Remote Keyless Entry (RKE) transmitter or open either door.

This feature also turns on the approach lighting (if so equipped). For details, refer to “Illumination Approach,” under “Personal Settings (Customer Programmable Features),” under “Electronic Vehicle Information Center (EVIC)” in Section 4 of this manual.

The lights will fade to off after about 30 seconds or they will immediately fade to off once the ignition switch is turned on.

NOTE:

- The front courtesy overhead console and door courtesy lights do not turn on if the dimmer control is in the interior lights ON position (extreme top position).
- The illuminated entry system will not operate if the dimmer control is in the “defeat” position (extreme downward position).

REMOTE KEYLESS ENTRY — IF EQUIPPED

This system allows you to lock or unlock the doors, open the trunk, or activate the PANIC alarm from distances a maximum of 66 ft (20 m) using a hand-held radio transmitter. The transmitter need not be pointed at the vehicle to activate the system.

NOTE: The line of transmission must not be blocked with metal objects.

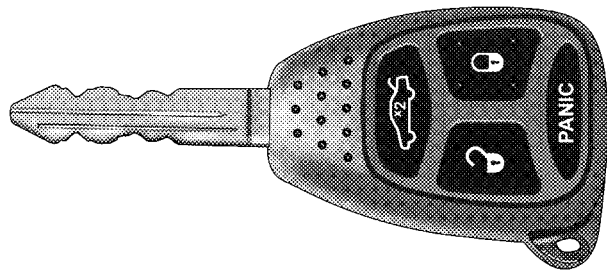

815afa1a

Vehicle Key

NOTE: Inserting the key into the ignition switch disables all buttons on the transmitter.

TO UNLOCK THE DOORS

Press and release the UNLOCK button on the transmitter once to unlock the driver's door, or twice to unlock all doors. The turn signal lights will flash to acknowledge the unlock signal. The illuminated entry system (if equipped) will also turn on.

Remote Key Unlock, Driver Door/All Doors First

This feature lets you program the system to unlock either the driver's door or all doors on the first press of the UNLOCK button on the transmitter. To change the current setting, proceed as follows:

- For vehicles equipped with the Electronic Vehicle Information Center (EVIC), refer to "Remote Key Unlock," under "Personal Settings (Customer Programmable Features)" under "Electronic Vehicle Information Center (EVIC)" in Section 4 of this manual for details.

- For vehicles not equipped with the EVIC, perform the following procedure:

1. Press and hold the LOCK button on a programmed transmitter for at least four seconds, but not longer than ten seconds. Then, press and hold the UNLOCK button while still holding the LOCK button.
2. Release both buttons at the same time.
3. Test the feature while outside of the vehicle, by pressing the LOCK/UNLOCK buttons on the transmitter with the ignition in the LOCK position, and the key removed.
4. Repeat these steps if you want to return this feature to its previous setting.

NOTE: Pressing the LOCK button on the transmitter while you are inside the vehicle will activate the Security

Alarm. Opening a door with the Security Alarm activated will cause the alarm to sound. Press the UNLOCK button to deactivate the Security Alarm.

Flash Lights With Lock

The feature will cause the turn signal lights to flash when the doors are locked or unlocked with the transmitter. This feature can be turned on or turned off. To change the current setting, proceed as follows:

- For vehicles equipped with the Electronic Vehicle Information Center (EVIC), refer to “Flash Lights with Lock,” under “Personal Settings (Customer Programmable Features)” under “Electronic Vehicle Information Center (EVIC)” in Section 4 of this manual for details.
- For vehicles not equipped with the EVIC, perform the following procedure:

1. Press and hold the UNLOCK button on a programmed transmitter for at least four seconds, but not longer than ten seconds. Then, press and hold the LOCK button while still holding the UNLOCK button.

2. Release both buttons at the same time.

3. Test the feature while outside of the vehicle, by pressing the LOCK/UNLOCK buttons on the transmitter with the ignition in the LOCK position, and the key removed.

4. Repeat these steps if you want to return this feature to its previous setting.

NOTE: Pressing the LOCK button on the transmitter while you are in the vehicle will activate the Security Alarm. Opening a door with the Security Alarm activated will cause the alarm to sound. Press the UNLOCK button to deactivate the Security Alarm.

Illuminated Approach — If Equipped

This feature activates the headlights for up to 90 seconds when the doors are unlocked with the transmitter. The time for this feature is programmable on vehicles equipped with EVIC. For details, refer to “Illuminated Approach,” under “Personal Settings (Customer Programmable Features),” under “Electronic Vehicle Information Center (EVIC)” in Section 4 of this manual.

TO LOCK THE DOORS

Press and release the LOCK button on the transmitter to lock all doors. The turn signal lights will flash and the horn will chirp once to acknowledge the lock signal.

Sound Horn with Lock

This feature will cause the horn to chirp when the doors are locked with the transmitter. This feature can be turned on or off. To change the current setting, proceed as follows:

- For vehicles equipped with EVIC, refer to “Sound Horn with Lock,” under “Personal Settings (Customer Programmable Features)” under “Electronic Vehicle Information Center (EVIC)” in Section 4 of this manual for details.
- For vehicles not equipped with the EVIC, perform the following steps:
 1. Press the LOCK button on a programmed transmitter for at least four seconds, but not longer than ten seconds. Then, press the PANIC button while still holding the LOCK button.
 2. Release both buttons at the same time.
 3. Test the feature while outside of the vehicle, by pressing the LOCK button on the transmitter with the ignition in the LOCK position, and the key removed.
 4. Repeat these steps if you want to return this feature to its previous setting.

NOTE: Pressing the LOCK button on the transmitter while you are in the vehicle will activate the Security Alarm. Opening a door with the Security Alarm activated will cause the alarm to sound. Press the UNLOCK button to deactivate the Security Alarm.

TO UNLATCH THE TRUNK

Press the TRUNK button on the transmitter two times to unlatch the trunk.

USING THE EXPRESS DOWN WINDOWS FEATURE — IF EQUIPPED

This feature allows you to remotely lower both front door windows at the same time. To use this feature, press and release the UNLOCK button on the transmitter and then immediately press and hold the UNLOCK button until the windows lower to the level desired or until they lower completely.

USING THE PANIC ALARM

To turn the PANIC alarm feature ON or OFF, press and hold the PANIC button on the transmitter for at least one second and release. When the PANIC alarm is on, the headlights and park lights will flash, the horn will pulse on and off, and the illuminated entry system (if equipped) will turn on.

The PANIC alarm will stay on for three minutes unless you turn it off by pressing the PANIC button a second time or if the vehicle speed is 5 mph (8 km/h) or greater.

NOTE: You may need to be close to the vehicle when using the transmitter to turn off the PANIC alarm due to the radio frequency noises emitted by the system.

PROGRAMMING ADDITIONAL TRANSMITTERS

Refer to SENTRY KEY® “Sentry Key® Programming.”

If you do not have a programmed transmitter, contact your authorized dealer for details.

BATTERY REPLACEMENT

The recommended replacement battery is CR2032.

NOTE: Perchlorate Material — special handling may apply. See www.dtsc.ca.gov/hazardouswaste/perchlorate.

1. With the transmitter buttons facing down, use a flat blade to pry the two halves of the transmitter apart. Make sure not to damage the seal during removal.

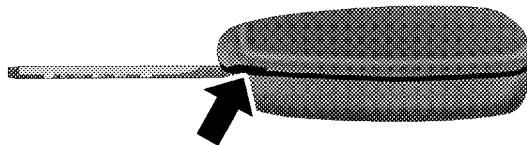

81182c72

Separating Transmitter Halves

2. Remove and replace the batteries. Avoid touching the new batteries with your fingers. Skin oils may cause battery deterioration. If you touch a battery, clean it with rubbing alcohol.
3. To assemble the transmitter case, snap the two halves together.

GENERAL INFORMATION

This device complies with part 15 of FCC rules and with RS-210 of Industry Canada. Operation is subject to the following conditions:

1. This device may not cause harmful interference.
2. This device must accept any interference that may be received including interference that may cause undesired operation.

NOTE: Changes or modifications not expressly approved by the party responsible for compliance could void the user's authority to operate the equipment.

If your Remote Lock Control fails to operate from a normal distance, check for these two conditions.

1. Weak batteries in the transmitter. The expected life of batteries is five years.
2. Closeness to a radio transmitter such as a radio station tower, airport transmitter, military base, and some mobile or CB radios.

REMOTE START SYSTEM — IF EQUIPPED

Remote start conveniently starts the engine from outside the vehicle by using the Remote Keyless Entry (RKE) key fob while maintaining security. The system has a targeted range of up to 328 ft (100 m). The vehicle must be locked, the deck lid and hood closed and the transmission gear selector lever in PARK in order to start the engine using the Remote Start button on the key fob.

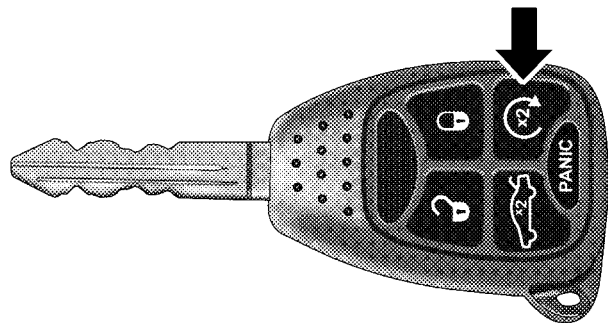

81db10a8

Remote Start

NOTE: Remote start requires automatic transaxle equipped vehicles.

HOW TO USE REMOTE START

All of the following conditions must be met before the engine will remote start:

- Shift the gear selector lever into PARK.
- Doors closed.
- Hood closed.
- Trunk closed.
- Hazard switch off.
- Brake switch inactive (brake pedal not pressed).
- Ignition key removed from ignition switch.
- Battery at an acceptable charge level.
- RKE PANIC button not pressed.

To Enter Remote Start Mode



Press and release the Remote Start button on the RKE transmitter twice. The engine will start and the vehicle will remain in the Remote Start mode for a 15-minute cycle.

NOTE:

- For security, power window operation is disabled when the vehicle is in the Remote Start mode.
- The engine can be started two consecutive times (two 15-minute cycles) with the RKE transmitter. However, the ignition switch must be cycled to the ON position before you can repeat the start sequence for a third cycle.

To Exit Remote Start Mode Without Driving The Vehicle

Allow the engine to run for the entire 15-minute cycle.

To Exit Remote Start Mode And Drive The Vehicle

Before the end of the 15-minute cycle, press and release the UNLOCK button on the RKE transmitter to unlock the doors and disarm the Vehicle Security Alarm (if equipped). Then, within 15 minutes, insert the key into the ignition switch and turn the switch to the ON position.

NOTE: The ignition switch must be in the ON position in order to drive the vehicle.

To Turn Off The Engine While In Remote Start Mode

Press and release the Remote Start button one time.

NOTE: To avoid inadvertent shut downs, the system will disable the one-time press of the Remote Start button for two seconds after receiving a valid remote start request.

DOOR LOCKS

MANUAL DOOR LOCKS

Use the manual door lock plunger to lock the doors from inside the vehicle. If the plunger is down when the door is closed, the door will lock. Therefore, make sure the keys are not inside the vehicle before closing the door.

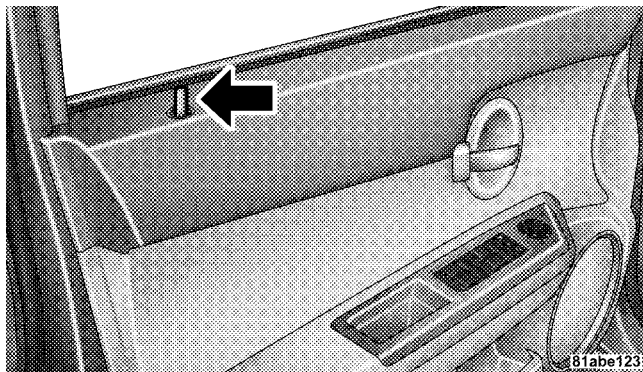

Manual Lock Plunger

WARNING!

- For personal security, and safety in the event of an accident, lock the vehicle doors as you drive as well as when you park and leave the vehicle.
- When leaving the vehicle always remove the key from the ignition lock, and lock your vehicle. Do not leave children unattended in the vehicle, or with access to an unlocked vehicle. Unsupervised use of vehicle equipment may cause severe personal injuries and death.
- Never leave children alone in a vehicle. Leaving children in a vehicle unattended is dangerous for a number of reasons. A child or others could be seriously or fatally injured. Don't leave the keys in the ignition. A child could operate power windows, other controls, or move the vehicle.

CAUTION!

An unlocked vehicle is an invitation to thieves. Always remove the key from the ignition and lock all of the doors when leaving the vehicle unattended.

POWER DOOR LOCKS

A door lock switch is located on the driver and passenger door panel. Press this switch to lock or unlock the doors.

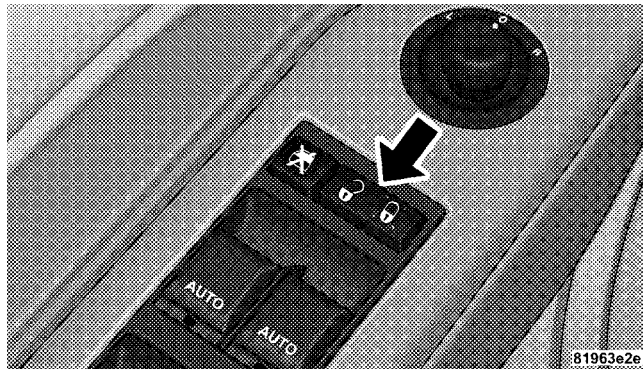

Power Door Lock Switch

Automatic Door Locks — If Equipped

The auto door lock feature can be enabled or disabled by your authorized dealer. See your dealer for programming.

Automatic Unlock Doors On Exit

The doors will unlock automatically on vehicles with power door locks if:

1. The Auto Unlock feature is enabled.
2. The transmission gear selector lever was in gear and the vehicle speed returned to 0 mph (0 km/h).
3. The transmission gear selector lever is in NEUTRAL or PARK.
4. The driver door is opened.
5. The doors were not previously unlocked.
6. The vehicle speed is 0 mph (0 km/h).

Automatic Unlock Doors On Exit Programming

The Auto Unlock on Exit feature can be enabled or disabled as follows:

- For vehicles equipped with the Electronic Vehicle Information Center (EVIC), refer to “Personal Settings (Customer Programmable Features)” under “Electronic Vehicle Information Center (EVIC)” in Section 4 of this manual for details.
- For vehicles not equipped with the EVIC, performing the following procedure:
 1. Close all doors and place the key in the ignition.

2. Cycle the ignition switch between LOCK and ON and then back to LOCK four times ending up in the LOCK position.

3. Depress the power door unlock switch to unlock the doors.

4. Repeat these steps if you want to return this feature to its previous setting.

NOTE: Use the Auto Unlock On Exit feature in accordance with local laws.

“CHILD-PROTECTION” DOOR LOCK SYSTEM (REAR DOORS)

The Rear Door Child-Protection Locks are located inside the rear edge of the door. Insert the tip of the ignition key or similar flat-bladed object into the lock and rotate approximately one—quarter turn to the lock or unlock position (as indicated by the stamped icons).

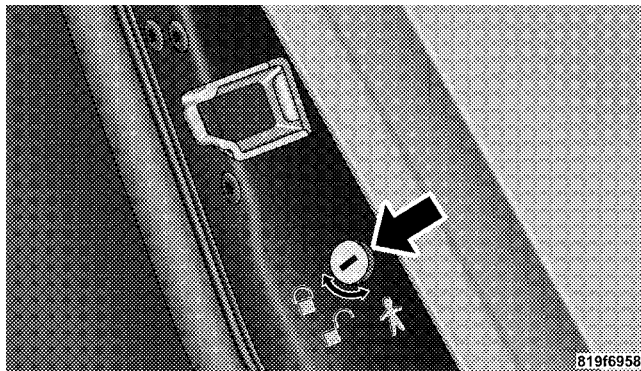

Child Lock Control

WARNING!

Avoid trapping anyone in a vehicle in a collision. Remember that the rear doors can only be opened from the outside when the child protection locks are engaged.

NOTE: For emergency exit with the system engaged, move the lock plunger up (unlocked position), roll down the window, and open the door with the outside door handle.

POWER WINDOWS

POWER WINDOW SWITCHES

The control on the driver's door has up-down switches that give you fingertip control of all four power windows.

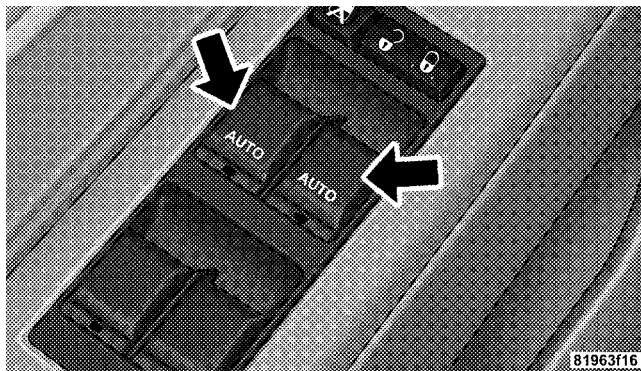

2

Auto Power Window Switch

There is a single window control on the passenger's door trim panel, which operates the passenger door window. The window controls will operate when the ignition switch is turned to the ON or ACC position, and when the accessory delay feature is active.

WARNING!

Never leave children in a vehicle, with the keys in the ignition switch. Occupants, particularly unattended children, can become entrapped by the windows while operating the power window switches. Such entrapment may result in serious injury or death.

AUTO WINDOW DOWN — IF EQUIPPED

The front window controls on the driver and passenger door trim panels have an Auto Down feature. These switches are labeled AUTO to indicate this capability. Push the window switch past the first detent, release, and the window will go down automatically.

To open the window part way, push the window switch to the first detent and release it when you want the window to stop.

To cancel the Auto Down movement, operate the switch either in the up or down direction and release the switch.

For vehicles not equipped with the Electronic Vehicle Information Center (EVIC), the power window switches will remain active for approximately 45 seconds after the ignition switch is turned to the LOCK position. Opening either door will cancel this feature.

For vehicles equipped with the Electronic Vehicle Information Center (EVIC), the power window switches will remain active for up to 10 minutes after the ignition switch is turned off. Opening either door will cancel this feature. The time for this feature is programmable. For details, refer to “Key-Off Power Delay,” under “Personal Settings (Customer Programmable Features)” under “Electronic Vehicle Information Center (EVIC)” in Section 4 of this manual.

AUTO WINDOW UP — IF EQUIPPED

Lift the window switch to the second detent, release, and the window will go up automatically.

To cancel the Auto Up movement, operate the switch either in the up or down direction and release the switch.

To close the window part way, lift the window switch to the first detent and release it when you want the window to stop.

NOTE: ANTI-PINCH PROTECTION

- If the window runs into an obstacle during auto-closure, it will reverse direction and then stop. Remove the obstacle and use the window switch again to close the window.
- Any impact due to rough road conditions may trigger the auto reverse function unexpectedly during auto-closure. If this happens, pull the switch lightly to the first detent and hold to close window manually.

WARNING!

When the window is almost closed, there is no anti-pinch protection. To avoid personal injury, be sure to clear your arms, hands, fingers and all objects from the window path before closing.

2

RESET AUTO UP

Any time the vehicle battery goes dead, the auto-up function will be disabled. To reactivate the auto-up feature, pull the window switch up to close the window completely and continue to hold the switch up for an additional two seconds after the window is closed.

WINDOW LOCKOUT SWITCH

The window lockout switch on the driver's door allows you to disable the window control on the other doors. To disable the window controls on the other doors, press the window lock button. To enable the window controls, press the window control button again.

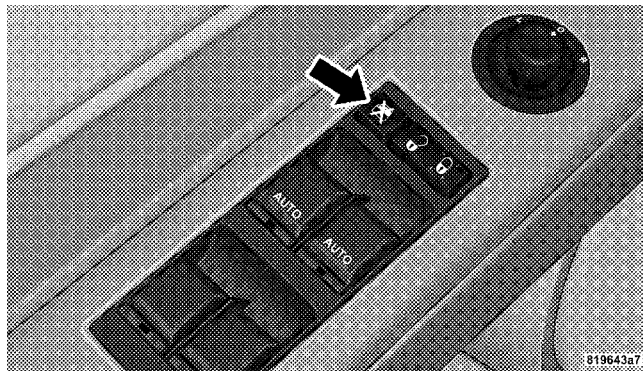

Window Lockout Switch

WIND BUFFETING

Wind buffeting can be described as the perception of pressure on the ears or a helicopter type sound in the ears. Your vehicle may exhibit wind buffeting with the windows down, or the sunroof (if equipped) in certain open or partially open positions. This is a normal occurrence and can be minimized. If the buffeting occurs with the rear windows open, then open the front and rear windows together to minimize the buffeting. If the buffeting occurs with the sunroof open, then adjust the sunroof opening to minimize the buffeting.

TRUNK RELEASE

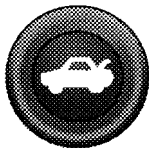

81ac2fd7

From inside the car the trunk lid can be released by depressing the Trunk Release Button located on the instrument panel to the left of the steering wheel. The transmission must be in Park before the switch will operate.

NOTE: The gear selector lever must be in PARK for this switch to operate.

To unlatch the trunk lid from outside the vehicle, press and release the TRUNK button on the Remote Keyless Entry (RKE) transmitter two times.

With the ignition ON, the word “deck” will display in place of the odometer display indicating that the trunk is open. The odometer display will reappear once the trunk is closed or if the trip button is depressed.

With the key in the lock position or with the key out, the word “deck” will display until the trunk is closed.

On EVIC equipped vehicles, the words “Trunk Ajar” will display.

TRUNK SAFETY WARNING

WARNING!

Do not allow children to have access to the trunk, either by climbing into the trunk from outside, or through the inside of the vehicle. Always close the trunk lid when your vehicle is unattended. Once in the trunk, young children may not be able to escape, even if they entered through the rear seat. If trapped in the trunk, children can die from suffocation or heat stroke.

TRUNK INTERNAL EMERGENCY RELEASE

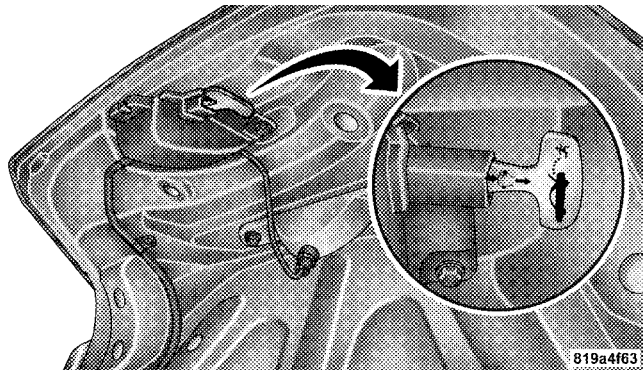

Interior Trunk Emergency Release

NOTE: As a security measure, a Trunk Internal Emergency Release lever is built into the trunk latching mechanism. In the event of an individual being locked inside the trunk, the trunk can be simply opened by pulling on the glow-in-the-dark handle attached to the trunk latching mechanism.

OCCUPANT RESTRAINTS

Some of the most important safety features in your vehicle are the restraint systems. The following safety features are standard on all vehicles:

- Three point lap and shoulder belts for all seating positions
- Pretensioning and load-limiting retractors for the front seat belts
- Advanced multistage driver and new active-vent front passenger airbags
- New active-vent front passenger airbags.
- Knee Bolsters/Blockers for front seat occupants
- An energy absorbing steering column and steering wheel

- Supplemental Side Airbag Inflatable Curtains (SABIC) that span the front and second rows for sedans — if equipped
- Supplemental seat side (Thorax) airbags — if equipped
- Front seat belt retractors incorporate pretensioners to enhance occupant protection by managing occupant energy during an impact event.
- All seat belt systems (except the driver's) include Automatic Locking Retractors (ALRs), which lock the seat belt webbing into position by extending the belt all the way out and then adjusting the belt to the desired length to restrain a child seat or secure a large item in a seat.

If you will be carrying children too small for adult-size seat belts, your seat belts or the LATCH feature also can be used to hold infant and child restraint systems.

NOTE: The front airbags have a multi stage inflator design. This allows the airbag to have different rates of inflation that are based on collision severity.

Please pay close attention to the information in this section. It tells you how to use your restraint system properly to keep you and your passengers as safe as possible.

WARNING!

In a collision, you and your passengers can suffer much greater injuries if you are not properly buckled up. You can strike the interior of your vehicle or other passengers, or you can be thrown out of the vehicle. Always be sure you and others in your vehicle are buckled up properly.

Buckle up even though you are an excellent driver, even on short trips. Someone on the road may be a poor driver and cause a collision that includes you. This can happen far away from home or on your own street.

Research has shown that seat belts save lives, and they can reduce the seriousness of injuries in a collision. Some of the worst injuries happen when people are thrown from the vehicle. Seat belts reduce the possibility of ejection and the risk of injury caused by striking the inside of the vehicle. **Everyone in a motor vehicle should be belted at all times.**

LAP/SHOULDER BELTS

All seating positions in your vehicle are equipped with Lap/Shoulder Belts.

The belt webbing retractor will lock only during very sudden stops or collisions. This feature allows the shoulder part of the belt to move freely with you under normal

conditions. But in a collision, the belt will lock and reduce your risk of striking the inside of the vehicle or being thrown out.

WARNING!

- **Be sure everyone in your vehicle is in a seat and using a seat belt properly.**
- **It is extremely dangerous to ride in a cargo area, inside or outside of a vehicle. In a collision, people riding in these areas are more likely to be seriously injured or killed.**
- **Wearing a seat belt incorrectly is dangerous. Seat belts are designed to go around the large bones of your body. These are the strongest parts of your body and can take the forces of a collision the best.**

WARNING!

- **Wearing your belt in the wrong place could make your injuries in a collision much worse. You might suffer internal injuries, or you could even slide out of part of the belt. Follow these instructions to wear your seat belt safely and to keep your passengers safe, too.**
- **Two people should never be belted into a single seat belt. People belted together can crash into one another in an accident, hurting one another badly. Never use a lap/shoulder belt or lap belt for more than one person, no matter what their size.**

Lap/Shoulder Belt Operating Instructions

1. Enter the vehicle and close the door. Sit back and adjust the seat.

2. The seat belt latch plate is above the back of the front seat, next to your arm. Grasp the latch plate and pull out the belt. Slide the latch plate up the webbing as far as necessary to allow the belt to go around your lap.



Pulling Out the Latch Plate

3. When the belt is long enough to fit, insert the latch plate into the buckle until you hear a “click.”

WARNING!

- A belt that is buckled into the wrong buckle will not protect you properly. The lap portion could ride too high on your body, possibly causing internal injuries. Always buckle your belt into the buckle nearest you.
- A belt that is too loose will not protect you as well. In a sudden stop, you could move too far forward, increasing the possibility of injury. Wear your seat belt snugly.

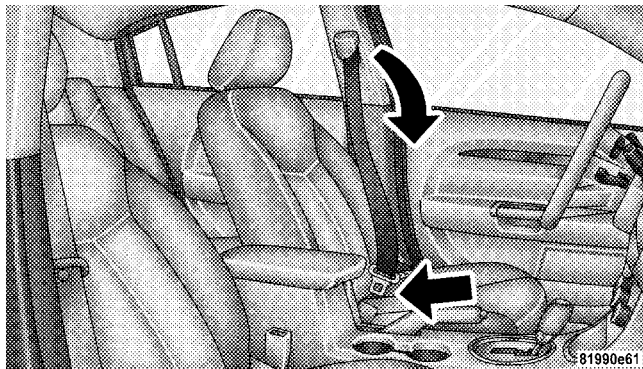

Inserting Latch Plate Into Buckle

WARNING!

- A belt that is worn under your arm is very dangerous. Your body could strike the inside surfaces of the vehicle in a collision, increasing head and neck injury. A belt worn under the arm can cause internal injuries. Ribs aren't as strong as shoulder bones. Wear the belt over your shoulder so that your strongest bones will take the force in a collision.
- A shoulder belt placed behind you will not protect you from injury during a collision. You are more likely to hit your head in a collision if you do not wear your shoulder belt. The lap and shoulder belt are meant to be used together.

4. Position the lap belt across your thighs, below your abdomen. To remove slack in the lap belt portion, pull up on the shoulder belt. To loosen the lap belt if it is too tight, tilt the latch plate and pull on the lap belt. A snug belt reduces the risk of sliding under the belt in a collision.

2



Positioning the Lap Belt

WARNING!

- **A lap belt worn too high can increase the risk of internal injury in a collision. The belt forces won't be at the strong hip and pelvic bones, but across your abdomen. Always wear the lap belt as low as possible and keep it snug.**
- **A twisted belt can't do its job as well. In a collision, it could even cut into you. Be sure the belt is straight. If you can't straighten a belt in your vehicle, take it to your dealer and have it fixed.**

5. Position the shoulder belt on your chest so that it is comfortable and not resting on your neck. The retractor will withdraw any slack in the belt.

6. To release the belt, push the red button on the buckle. The belt will automatically retract to its stowed position. If necessary, slide the latch plate down the webbing to allow the belt to retract fully.

WARNING!

A frayed or torn belt could rip apart in a collision and leave you with no protection. Inspect the belt system periodically, checking for cuts, frays, or loose parts. Damaged parts must be replaced immediately. Do not disassemble or modify the system. Seat belt assemblies must be replaced after a collision if they have been damaged (bent retractor, torn webbing, etc.).

Lap/Shoulder Belt Untwisting Procedure

Use the following procedure to untwist a twisted lap/shoulder belt.

1. Position the latch plate as close as possible to the anchor point.
2. At about 6 to 12 inches (15 to 30 cm) above the latch plate, grasp and twist the belt webbing 180° to create a fold that begins immediately above the latch plate.
3. Slide the latch plate upward over the folded webbing. The folded webbing must enter the slot at the top of the latch plate.
4. Continue to slide the latch plate up until it clears the folded webbing.

ADJUSTABLE UPPER SHOULDER BELT ANCHORAGE

In the front seat, the shoulder belt can be adjusted upward or downward to position the belt away from your neck. Push anchorage button to release the anchorage, and move it up or down to the position that serves you best.

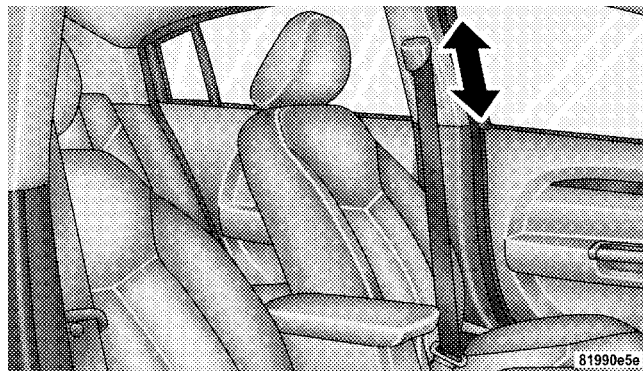

Adjustable Anchorage

As a guide, if you are shorter than average, you will prefer a lower position, and if you are taller than average, you'll prefer a higher position. When you release the anchorage, try to move it up or down to make sure that it is locked in position.

REAR SEAT BELTS

Three point belts are nonadjustable for outboard and center rear passengers on sedans. The center belt is mounted to the rear shelf panel and exits through a bezel in the panel.

SEAT BELT PRETENSIONERS

The seat belts for both front seating positions are equipped with pretensioning devices that are designed to remove slack from the seat belt in the event of a collision. These devices improve the performance of the seat belt by assuring that the belt is tight about the occupant early in a collision. Pretensioners work for all size occupants, including those in child restraints.

In addition, the front passenger seat belt includes a two-stage load-limiting feature to enhance occupant protection for the same reason.

NOTE: These devices are not a substitute for proper seat belt placement by the occupant. The seat belt still must be worn snugly and positioned properly.

The pretensioners are triggered by the Occupant Restraint Controller (ORC) (see Airbag Section). Like the front airbags, the pretensioners are single use items. After a collision that is severe enough to deploy the airbags and pretensioners, both must be replaced.

ENHANCED SEAT BELT REMINDER SYSTEM (BELTALERT®)

If the occupied driver's seat belt has not been buckled within 60 seconds of starting the vehicle and if the vehicle speed is greater than 5 mph (8 km/h), BeltAlert® will alert the driver to buckle their seat belt. The driver should also instruct all other occupants to buckle their seat belts. Once the warning is triggered, BeltAlert® will continue to chime and flash the Seat Belt Warning Light for 96 seconds or until the driver's seat belt is buckled.

BeltAlert® will be reactivated if the driver's seat belt is unbuckled for more than 10 seconds and the vehicle speed is greater than 5 mph (8 km/h).

BELTALERT® PROGRAMMING

BeltAlert® can be enabled or disabled by your authorized dealer or by following these steps:

NOTE: The following steps must occur within the first 60 seconds of the ignition switch being turned to the ON or START position. DaimlerChrysler does not recommend deactivating BeltAlert®.

1. Turn the ignition switch to the LOCK position and buckle the driver's seat belt.
2. Turn the ignition switch to the ON position and wait for the Seat Belt Warning Light to turn off.

3. Within 60 seconds of turning the ignition switch to the ON position, unbuckle and then re-buckle the driver's seat belt at least three times within 10 seconds, ending with the seat belt buckled.

NOTE: Watch for the Seat Belt Warning Light to turn on while unbuckling and off while re-buckling the seat belt. It may be necessary to retract the seat belt partially each time when unbuckling.

4. Turn the ignition switch to the LOCK position. A single chime will sound to signify that you have successfully completed the programming.

BeltAlert® can be reactivated by repeating this procedure.

NOTE: Although BeltAlert® has been deactivated, the Seat Belt Warning Light will continue to illuminate while the driver's seat belt remains unbuckled.

AUTOMATIC LOCKING MODE

In this mode, the shoulder belt is automatically pre-locked. However, the belt will still retract to remove any slack in the shoulder belt. The Automatic Locking Mode is available on all passenger-seating positions. Use the Automatic Locking Mode anytime a child safety seat is installed in a passenger seating position. Children 12 years old and under should be properly restrained in the rear seat whenever possible.

How To Engage The Automatic Locking Mode

1. Buckle the combination lap/shoulder belt.
2. Grasp the shoulder portion and pull downward until the entire belt is extracted.
3. Allow the belt to retract. As the belt retracts, you will hear a clicking sound. This indicates the safety belt is now in the Automatic Locking Mode.

How To Disengage The Automatic Locking Mode

Unbuckle the combination lap/shoulder belt and allow it to retract completely to disengage the Automatic Locking Mode and activate the vehicle sensitive (emergency) locking mode.

SEAT BELTS AND PREGNANT WOMEN

We recommend that pregnant women use the seat belts throughout their pregnancy. Keeping the mother safe is the best way to keep the baby safe.

Pregnant women should wear the lap part of the belt across the thighs and as snug across the hips as possible. Keep the belt low so that it does not come across the abdomen. That way the strong bones of the hips will take the force if there is a collision.

Seat Belt Extender

If a seat belt is too short, even when fully extended and when the adjustable upper shoulder belt anchorage (if equipped) is in its lowest position, your dealer can provide you with a seat belt extender. This extender should be used only if the existing belt is not long enough. When it is not required, remove the extender, and stow it.

WARNING!

Using a seat belt extender when not needed can increase the risk of injury in a collision. Only use when the lap belt is not long enough when it is worn low and snug, and in the recommended seating positions. Remove and store the extender when not needed.

SUPPLEMENTAL RESTRAINT SYSTEM (SRS) - AIRBAG

This vehicle has airbags for both the driver and front passenger as a supplement to the seat belt restraint systems. The driver's front airbag is mounted in the center of the steering wheel. The passenger's front airbag is mounted in the instrument panel, above the glove compartment. The words SRS AIRBAG are embossed on the airbag covers.

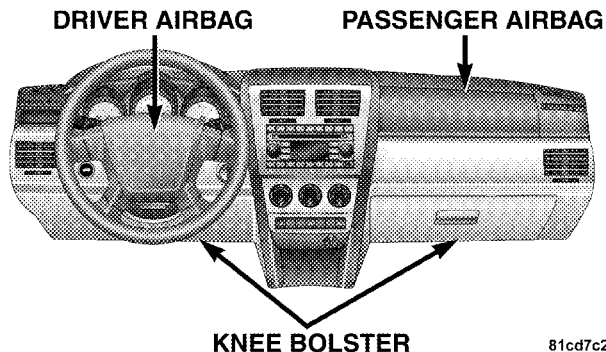

Front Airbag Components

NOTE: The front airbags are certified to the Federal regulations that allow less forceful deployment.

The front airbags have a multistage inflator design. This may allow the airbag to have different rates of inflation that are based on collision severity and occupant size.

This vehicle may also be equipped with window bags to protect the driver, front, and rear passengers sitting next to a window. If the vehicle is equipped with window bags, they are located above the side windows. Their covers are also labeled SRS AIRBAG.

NOTE: Airbag covers may not be obvious in the interior trim; but they will open to allow airbag deployment.

AIRBAG SYSTEM COMPONENTS

The airbag system consists of the following:

- Occupant Restraint Controller (ORC)
- Airbag Light
- Driver Airbag
- Front Passenger Airbag
- Supplemental Side Airbag Inflatable Curtains (SABIC)
— If Equipped

- Front Seat— side mounted (Thorax) Airbags — If Equipped
- Front Impact Sensors
- Side Impact Sensors (If Equipped)
- Steering Wheel and Column
- Instrument Panel
- Seat Belt Reminder Light
- Knee Impact Bolster
- Front Seat Belt Pretensioners

FRONT SEAT AIRBAG FEATURES

The front airbag system has dual-stage driver and front passenger airbags. This system provides output appropriate to the level of crash severity as determined by the Occupant Restraint Controller (ORC) and the impact sensors at the front of the car.

The first stage inflator is triggered immediately during an impact that requires airbag deployment. The timing of the second stage determines whether the output force is low, medium, or high. If a low output is sufficient to meet the need, the second stage is expended later in the crash event.

Driver Airbag Special Features

Driver airbag deployment and force level is controlled by the driver's seat position as well as impact severity. Use of special inflators, result in a very compact driver's side airbag.

In addition to the small size, the inflating gasses exit through strategically placed vents, which direct the gas away from the occupant.

Front Passenger Airbag Special Features

A new active venting front-passenger airbag is designed to reduce the risk of occupants who may be out of position by the use of active vents positioned on each side of the airbag.

Supplemental Front Seat-Mounted Thorax Side Airbags — If Equipped

Front seat mounted side (Thorax) airbags provide enhanced protection and work together with supplemental Side Airbag Inflatable Curtains (SABIC) to help protect an occupant during a side impact. The seat-mounted side airbag is marked with an airbag label sewn into the outboard side of the seat.

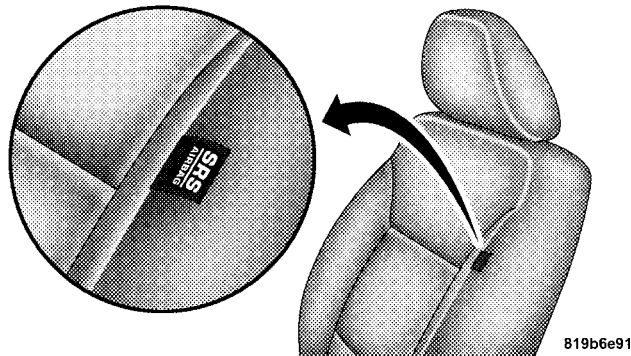

819b6e91

seat-mounted Side Airbag Label

When the bag deploys, it opens the seam between the front and side of the seat's trim cover. Each bag deploys independently, that is a left side impact deploys the left bag only and a right-side impact deploys only the right bag.

Supplemental Side Airbag Inflatable Curtain (SABIC) — If Equipped

Supplemental Side Airbag Inflatable Curtain (SABIC) Airbags offer side-impact protection to front and rear seat outboard occupants in addition to that provided by the body structure. Each airbag features inflated chambers place adjacent to the head of each outboard occupant that reduce the potential for side-impact head injuries. The curtains deploy downward, covering both windows on the impact side.

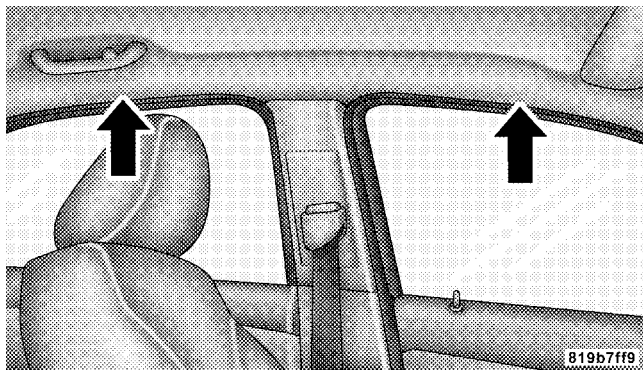

2

Side Airbag Inflatable Curtains (SABIC) Location

NOTE: Airbag covers may not be obvious in the interior trim; but they will open to allow airbag deployment.

The system includes sensors adjacent to both front and rear seat occupants that are calibrated to deploy the side bags during an impact severe enough to require airbag occupant protection.

WARNING!

- **Do not put anything on or around the airbag covers or attempt to open them manually. You may damage the airbags and you could be injured because the airbags are not there to protect you. These protective covers for the airbag cushions are designed to open only when the airbags are inflating.**
- **Do not use accessory seat covers or place objects between you and the side airbags; the performance could be adversely affected and/or objects could be pushed into you, causing serious injury.**

WARNING!

- **If your vehicle is equipped with left and right window bags, do not stack luggage or other cargo up high enough to block the location of the Side Airbag Inflatable Curtains (SABIC). The area where the side curtain airbag is located should remain free from any obstructions.**
- **Do not attach cup holders or any other objects on or around the door. The inflating side airbag could drive the object into occupants, causing serious injury.**

Airbags inflate in moderate to high speed impacts. Along with seat belts and pretensioners, front airbags, and side airbags work with the knee bolsters to provide improved protection for the driver and front passenger.

The seat belts are designed to protect you in many types of collisions. The front airbags deploy in moderate to severe frontal collisions. If your vehicle is equipped, the side airbag on the crash side of the vehicle is triggered in moderate to severe side collisions. In certain types of collisions, both the front and side airbags may be triggered. However, even in collisions where the airbags work, you need the seat belts to keep you in the right position for the airbags to protect you properly.

Here are some simple steps you can take to minimize the risk of harm from a deploying airbag.

1. Children 12 years old and under should always ride buckled up in a rear seat.

Infants in rear facing child restraints should **NEVER** ride in the front seat of a vehicle with a passenger front airbag. An airbag deployment can cause severe injury or death to infants in that position.

Children that are not big enough to wear the vehicle seat belt properly (see Section on Child Restraints) should be secured in the rear seat in child restraints or belt-positioning booster seats. Older children who do not use child restraints or belt-positioning booster seats should ride properly buckled up in the rear seat. Never allow children to slide the shoulder belt behind them or under their arm.

If a child from 1 to 12 years old must ride in the front passenger seat because the vehicle is crowded, move the seat as far back as possible, and use the proper child restraint. Refer to the section on Child Restraint.

You should read the instructions provided with your child restraint to make sure that you are using it properly.

2. All occupants should wear their lap and shoulder belts properly.

3. The driver and front passenger seats should be moved back as far as practical to allow the front airbags room to inflate.

4. If your vehicle has side airbags, do not lean against the door, airbags will inflate forcefully into the space between you and the door.

5. If the airbag system in this vehicle needs to be modified to accommodate a disabled person, contact the Customer Center. Phone numbers are provided under "If You Need Assistance" in Section 9 of this manual.

WARNING!

- Relying on the airbags alone could lead to more severe injuries in a collision. The airbags work with your seat belt to restrain you properly. In some collisions, the airbags won't deploy at all. Always wear your seat belts even though you have airbags.
- Being too close to the steering wheel or instrument panel during front airbag deployment could cause serious injury. Airbags need room to inflate. Sit back, comfortably extending your arms to reach the steering wheel or instrument panel.
- Side airbags also need room to inflate. Do not lean against the door. Sit upright in the center of the seat.

AIRBAG DEPLOYMENT SENSORS AND CONTROLS

Occupant Restraint Controller (ORC)

The **Occupant Restraint Controller System (ORC)** is part of a Federally regulated safety system required for this vehicle.

The ORC determines if a frontal collision is severe enough to require the airbags to inflate. Based on the sensor signals, a central electronic Occupant Restraint Controller (ORC) deploys the front airbags, side inflatable airbag curtains (if equipped), seat-mounted side (Thorax) airbags (if equipped), and front seat belt pretensioners as required for each type of impact.

The ORC monitors the readiness of the electronic parts of the system whenever the ignition switch is in the START or RUN positions. These include all of the items listed above except the steering wheel and column, instrument panel, and passenger knee bolsters. If the key is in the

OFF position, in the ACC position, or not in the ignition, the airbags are not on and will not inflate.

The ORC contains a backup power supply system that will deploy the airbags even if the battery loses power or it becomes disconnected prior to deployment.



Also, the ORC turns on the Airbag Warning Light in the instrument panel for 6 to 8 seconds for a self-check when the ignition is first turned on. After the self-check, the Airbag Warning Light will turn off. If the ORC detects a malfunction in any part of the system, it turns on the Airbag Warning Light either momentarily or continuously. A single chime will sound if the light comes on again after initial start up.

It also includes diagnostics that will illuminate the instrument cluster Airbag Warning Light if a malfunction is noted. The diagnostics also record the nature of the malfunction.

WARNING!

Ignoring the AIRBAG light in your instrument panel could mean you won't have the airbags to protect you in a collision. If the light does not come on, stays on after you start the vehicle, or if it comes on as you drive, have the airbag system checked right away.

Impact Sensors

Two sensors, located on the front body structure, trigger airbag deployment in direct frontal impacts and aid the Occupant Restraint Controller (ORC) in determining appropriate response to frontal impact events. Additional sensors in the ORC determine the level of airbag deployment and provide deployment verification.

Side Inflatable Curtain and Front Seat Mounted Airbags — If equipped

The Occupant Restraint Controller System (ORC) deploys the side inflatable curtain and seat mounted thorax side airbags during collision with other vehicles and during collisions where the impact is confined to a particular area of the vehicle — such as collisions with poles, trees or similar objects.

It will deploy the side inflatable curtains and front seat thorax mounted airbags only on the impact side of the vehicle.

The front driver and passenger seat contain inflatable side airbags to protect the occupant from impact injuries. Correctly functioning front passenger seat components are critical for the Occupant Restraint Controller System

(ORC) to properly classify the front passenger and calculate the proper airbag deployment. Do not make any modifications to the front passenger seat components, assembly, or to the seat cover.

The following requirements must be strictly adhered to:

- Do not make any modifications to the front passenger seat components, assembly, or to the seat cover in any way.
- Do not use prior or future model year seat covers not designated for the specific model being repaired. Always use the correct seat cover specified for the vehicle.
- Do not replace the seat cover with an aftermarket seat cover.
- Do not add a secondary seat cover other than those approved by DaimlerChrysler/Mopar.

- At no time should any supplemental restraint system (SRS) component or SRS related component or fastener be modified or replaced with any part except those which are approved by DaimlerChrysler/Mopar.

WARNING!

Unapproved modifications or service procedures to the front passenger seat assembly, its related components, or seat cover may inadvertently change the airbag deployment in case of a frontal crash. This could result in death or serious injury to the front seat passenger if the vehicle is involved in an accident. A modified vehicle may not comply with required Federal Motor Vehicle Safety Standards (FMVSS).

Enhanced Accident Response System

In the event of an impact that causes airbag deployment, with the vehicle stopped, and the vehicle communication network intact, and the power intact, the Enhanced Accident Response System performs the following functions:

- Cuts off fuel to the engine
- Flashes hazard lights
- Turns on the interior lights which remain on as long as the battery has power or until the ignition key is removed
- Unlocks the doors automatically

If A Deployment Occurs

The airbag systems are designed to deploy when the Occupant Restraint Controller (ORC) detect a moderate-to-severe collision, to help restrain the driver and front passenger, and then immediately deflate.

NOTE: A frontal collision that is not severe enough to need airbag protection will not activate the system. This does not mean something is wrong with the airbag system.

If you do have a collision, which deploys the airbags, any or all of the following may occur:

- The nylon airbag material may sometimes cause abrasions and/or skin reddening to the driver and front passenger as the airbags deploy and unfold. The abrasions are similar to friction rope burns or those you might get sliding along a carpet or gymnasium floor. They are not caused by contact with chemicals. They are not permanent and normally heal quickly. However, if you haven't healed significantly within a few days, or if you have any blistering, see your doctor immediately.
- As the airbags deflate, you may see some smoke-like particles. The particles are a normal by-product of the

process that generates the nontoxic gas used for airbag inflation. These airborne particles may irritate the skin, eyes, nose, or throat. If you have skin or eye irritation, rinse the area with cool water. For nose or throat irritation, move to fresh air. If the irritation continues, see your doctor. If these particles settle on your clothing, follow the garment manufacturer's instructions for cleaning.

- It is not advisable to drive your vehicle after the airbags have deployed. If you are involved in another collision, the airbags will not be in place to protect you.

WARNING!

Deployed airbags and seat belt pretensioners cannot protect you in another collision. Have the airbags, seat belt pretensioners, and the front passenger seat belt retractor assembly, replaced by an authorized dealer as soon as possible. Also, have the Occupant Restraint Controller System serviced as well.

2

Maintaining Your Airbag System

WARNING!

- **Modifications to any part of the airbag system could cause it to fail when you need it. You could be injured if the airbag system is not there to protect you. Do not modify the components or wiring, including adding any kind of badges or stickers to the steering wheel hub trim cover or the upper right side of the instrument panel. Do not modify the front bumper, vehicle body structure, or add aftermarket side steps or running boards.**
- **It is dangerous to try to repair any part of the airbag system yourself. Be sure to tell anyone who works on your vehicle that it has an airbag system.**

NOTE: Perchlorate Material — special handling may apply. See www.dtsc.ca.gov/hazardouswaste/perchlorate

WARNING!

Do not attempt to modify any part of your advanced airbag system. The airbag may inflate accidentally or may not function properly if modifications are made. Take your vehicle to an authorized dealer for any advanced airbag system service. If your seat including your trim cover and cushion needs to be serviced in any way (including removal or loosening/tightening of seat attachment bolts), take the vehicle to your authorized dealer. Only manufacturer approved seat accessories may be used. If it is necessary to modify an advanced airbag system for persons with disabilities, contact your authorized dealer.

Airbag Light



You will want to have the airbags ready to inflate for your protection in a collision. While the airbag system is designed to be maintenance free, if any of the following occurs, have an authorized dealer service the system immediately.

- The AIRBAG light does not come on during the 6 to 8 seconds when the ignition switch is first turned on.
- The light remains on after the 6 to 8 second interval.
- The light comes on and remains on while driving.

NOTE: If the speedometer, tachometer, or any engine related gauges are not working, the Occupant Restraint Controller (ORC) may also be disabled. The airbags may not be ready to inflate for your protection. Promptly check fuse block for blown fuses. Refer to the label located on the inside of the fuse block cover for the proper airbag fuses. See your dealer if the fuse is good.

EVENT DATA RECORDER (EDR)

In the event of an accident, your vehicle is designed to record up to 5 seconds of specific vehicle data parameters (see the following list) in an event data recorder prior to the moment of airbag deployment, or near deployment, and up to a quarter second of high-speed deceleration data during and/or after airbag deployment. EDR data are **ONLY** recorded if an airbag deploys, or nearly deploys, and are otherwise unavailable.

NOTE:

1. A near-deployment event occurs when the airbag sensor detects severe vehicle deceleration usually indicative of a crash, but not severe enough to warrant airbag deployment.
2. Under certain circumstances, EDR data may not be recorded (e.g., loss of battery power).

In conjunction with other data gathered during a complete accident investigation, the electronic data may be

used by DaimlerChrysler Corporation and others to learn more about the possible causes of crashes and associated injuries in order to assess and improve vehicle performance. In addition to crash investigations initiated by DaimlerChrysler Corporation, such investigations may be requested by customers, insurance carriers, government officials, and professional crash researchers, such as those associated with universities, and with hospital and insurance organizations.

In the event that an investigation is undertaken by DaimlerChrysler Corporation (regardless of initiative), the company or its designated representative will first obtain permission of the appropriate custodial entity for the vehicle (usually the vehicle owner or lessee) before accessing the electronic data stored, unless ordered to download data by a court with legal jurisdiction (i.e., pursuant to a warrant). A copy of the data will be provided to the custodial entity upon request. General data that does not identify particular vehicles or crashes

may be released for incorporation in aggregate crash databases, such as those maintained by the US government and various states. Data of a potentially sensitive nature, such as would identify a particular driver, vehicle, or crash, will be treated confidentially. Confidential data will not be disclosed by DaimlerChrysler Corporation to any third party except when:

1. Used for research purposes, such as to match data with a particular crash record in an aggregate database, provided confidentiality of personal data is thereafter preserved.
2. Used in defense of litigation involving a DaimlerChrysler Corporation product.
3. Requested by police under a legal warrant.
4. Otherwise required by law.

Data Parameters that May Be Recorded:

- Diagnostic trouble code(s) and warning light status for electronically-controlled safety systems, including the airbag system
- Airbag disable light status (if equipped)
- "Time" of airbag deployment (in terms of ignition cycles and vehicle mileage)
- Airbag deployment level (if applicable)
- Impact acceleration and angle
- Seatbelt status
- Brake status (service and parking brakes)
- Accelerator status (including vehicle speed)
- Engine control status (including engine speed)

- Transmission gear selection
- Cruise control status
- Traction/Stability Control status
- Tire Pressure Monitoring System status – If Equipped

CHILD RESTRAINT

Everyone in your vehicle needs to be buckled up at all times — babies and children, too. Every state in the United States and all Canadian provinces require that small children ride in proper restraint systems. This is the law, and you can be prosecuted for ignoring it.

Children 12 years and under should ride properly buckled up in a rear seat, if available. According to crash statistics, children are safer when properly restrained in the rear seats, rather than in the front.

WARNING!

In a collision, an unrestrained child, even a tiny baby, can become a missile inside the vehicle. The force required to hold even an infant on your lap could become so great that you could not hold the child, no matter how strong you are. The child and others could be badly injured. Any child riding in your vehicle should be in a proper restraint for the child's size.

There are different sizes and types of restraints for children from newborn size to the child almost large enough for an adult safety belt. Always check the child seat owner's manual to ensure you have the correct seat for your child. Use the restraint that is correct for your child.

Infants And Small Children

- Safety experts recommend that children ride rearward-facing in the vehicle until they are at least one year old and weigh at least 20 lbs (9 kg). Two types of child restraints can be used rearward-facing: infant carriers and "convertible" child seats. Both types of child restraints are held in the vehicle by the lap/shoulder belt or the LATCH child restraint anchorage system.
- The infant carrier is only used rearward-facing in the vehicle. It is recommended for children who weigh up to about 20 lbs (9 kg). "Convertible" child seats can be used either rearward-facing or forward-facing in the vehicle. Convertible child seats often have a higher weight limit in the rearward-facing direction than infant carriers do, so they can be used rearward-facing by children who weigh more than 20 lbs (9 kg) but are less than one year old.

- Rearward-facing child seats must **NEVER** be used in the front seat of a vehicle with a front passenger airbag. An airbag deployment could cause severe injury or death to infants in this position.

Older Children and Child Restraints

Children who weigh more than 20 lbs (9 kg) and who are older than one year can ride forward-facing in the vehicle. Forward-facing child seats and convertible child seats used in the forward-facing direction are for children who weigh 20 to 40 lbs (9 to 18 kg) and who are older than one year. These child seats are also held in the vehicle by the lap/shoulder belt or the LATCH child restraint anchorage system. Refer to “LATCH — Child Seat Anchorage System (Lower Anchors and Tether for Children)” in this section.

The belt-positioning booster seat is for children weighing more than 40 lbs (18 kg), but who are still too small to fit the vehicle’s seat belts properly. If the child cannot sit

with knees bent over the vehicle’s cushion while the child’s back is against the seatback, then the child should use a Belt Positioning Booster Seat. The child and booster seat are held in the vehicle by the lap/shoulder belt. (Some booster seats are equipped with a front shield and are held in the vehicle by the lap portion.)

2

WARNING!

- **Improper installation can lead to failure of an infant or child restraint. It could come loose in a collision. The child could be badly injured or killed. Follow the manufacturer’s directions exactly when installing an infant or child restraint.**
- **A rearward facing child restraint should only be used in a rear seat. A rearward facing child restraint in the front seat may be struck by a deploying passenger airbag which may cause severe or fatal injury to the infant.**

Here are some tips on getting the most out of your child restraints:

- Children who are large enough to wear the shoulder belt comfortably, and whose legs are long enough to bend over the front of the seat when their back is against the seatback, should use the lap/shoulder belt in a rear seat.
- Before buying any restraint system, make sure that it has a label certifying that it meets all applicable Safety Standards. We also recommend that you make sure that you can install the child restraint in the vehicle where you will use it, before you buy it.
- The restraint must be appropriate for your child's weight and height. Check the label on the restraint for weight and height limits.
- Carefully follow the instructions that come with the restraint. If you install the restraint improperly, it may not work when you need it.
- All passenger seating positions contain automatic locking retractors. However, any seat belt system will loosen with time, so check the belt occasionally and pull it tight if necessary.
- In the rear seat, you may have trouble tightening the lap/shoulder belt on the child restraint because the buckle or latch plate is too close to the belt path opening on the restraint. Disconnect the latch plate from the buckle and twist the short buckle end of the belt several times to shorten it. Insert the latch plate into the buckle with the release button facing out.
- If the belt still can't be tightened, or if by pulling and pushing on the restraint loosens the belt, disconnect the latch plate from the buckle, turn the latch plate

around, and insert the latch plate into the buckle again. If you still can't make the child restraint secure, try a different seating position.

- Buckle the child into the seat according to the child restraint manufacturer's directions.
- When your child restraint is not in use, secure it in the vehicle with the seat belt or remove it from the vehicle. Don't leave it loose in the vehicle. In a sudden stop or collision, it could strike the occupants or seat backs and cause serious personal injury.

NOTE: For additional information, refer online to www.seatcheck.org.

Lower Anchors and Tether for CHildren (LATCH)

Your vehicle is equipped with the child restraint anchorage system called LATCH, which stands for Lower Anchors and Tether for CHildren. The LATCH system provides for the installation of the child restraint without

using the vehicle seat belt. The outboard rear seating positions have lower anchorages that are capable of accommodating LATCH-compatible child seats having flexible, webbing-mounted lower attachments. Child seats with fixed lower attachments must be installed in the outboard positions only. Regardless of the specific type of lower attachment, **NEVER** install LATCH-compatible child seats such that two seats share a common lower anchorage. If you are installing LATCH-compatible child restraints in adjacent rear seating positions, you can use the LATCH anchors or the vehicle's seat belt for the outboard position, but you must use the vehicle's seat belt at the center position. If your child restraints are not LATCH-compatible, you can only install the child restraints using the vehicle's seat belts. Please refer to "Installing the Child Restraint System" for typical installation instructions.

Rear Seat LATCH Anchors

Child restraints systems having attachments designed to connect to the lower anchorages are now available. Child restraints having tether straps and hooks for connection to the top tether anchorage have been available for some time. In fact, many child restraint manufacturers will provide add-on tether strap kits for some of their older products. Tether anchorage kits are also available for most older vehicles.

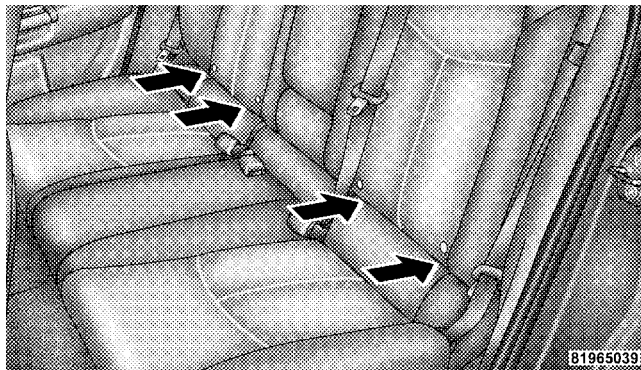

Rear Seat LATCH Anchors

Because the lower anchorages are to be introduced to passenger carrying vehicles over a period of years, child restraint systems having attachments for those anchorages will continue to have features for installation in vehicles using the lap or lap/shoulder belt. They will also

have tether straps, and you are urged to take advantage of all of the available attachments provided with your child restraint in any vehicle.

NOTE: When using the LATCH attaching system to install a child restraint, please ensure that all seat belts not being used for occupant restraints are stowed and out of reach of children. It is recommended that before installing the child restraint, buckle the seat belt so the seat belt is tucked behind the child restraint and out of reach. If the buckled seat belt interferes with the child restraint installation, instead of tucking the seat belt behind the child restraint, route the seat belt through the child restraint belt path and then buckle it. This should stow the seat belt out of the reach of an inquisitive child. Remind all children in the vehicle that the seat belts are not toys and should not be played with, and never leave your child unattended in the vehicle.

Installing the LATCH-Compatible Child Restraint System

We urge that you carefully follow the directions of the manufacturer when installing your child restraint. Not all child restraint systems will be installed as described here. Again, carefully follow the installation instructions that were provided with the child restraint system.



The rear seat lower anchorages are round bars, located at the rear of the seat cushion where it meets the seat back, and are just visible when you lean into the rear seat to install the child restraint. You will easily feel them if you run your finger along the intersection of the seatback and seat cushion surfaces.



In addition, there are tether strap anchorages behind each rear seating position located in the panel between the rear seat back and the rear

window. These tether strap anchorages are under a plastic cover with this symbol on it.

Many, but not all restraint systems will be equipped with separate straps on each side, with each having a hook or connector for attachment to the lower anchorage and a means of adjusting the tension in the strap. Forward-facing toddler restraints and some rear-facing infant restraints will also be equipped with a tether strap, a hook for attachment to the tether strap anchorage and a means of adjusting the tension of the strap.

You will first loosen the adjusters on the lower straps and on the tether strap so that you can more easily attach the hooks or connectors to the vehicle anchorages. Next, attach the lower hooks or connectors over the top of the seat cover material. Then rotate the tether anchorage cover directly behind the seat where you are placing the child restraint and attach the tether strap to the anchorage, being careful to route the tether strap to provide the

most direct path between the anchor and the child restraint. Finally, tighten all three straps as you push the child restraint rearward and downward into the seat, removing slack in the straps according to the child restraint manufacturer's instructions.

NOTE:

- Ensure that the tether strap does not slip into the opening between the seat backs as you remove slack in the strap.
- When using the LATCH attaching system to install a child restraint, please ensure that all seat belts not being used for occupant restraints are stowed and out of reach of children. It is recommended that before installing the child restraint, buckle the seat belt so the seat belt is tucked behind the child restraint and out of reach. If the buckled seat belt interferes with the child restraint installation, instead of tucking the seat belt behind the child restraint, route the seat belt through

the child restraint belt path and then buckle it. This should stow the seat belt out of the reach of an inquisitive child. Remind all children in the vehicle that the seat belts are not toys and should not be played with, and never leave your child unattended in the vehicle.

WARNING!

Improper installation of a child restraint to the LATCH anchorages can lead to failure of an infant or child restraint. The child could be badly injured or killed. Follow the manufacturer's directions exactly when installing an infant or child restraint.

Installing Child Restraint Tether Strap

1. Rotate the cover over the anchor directly behind the seat where you are placing the child restraint.

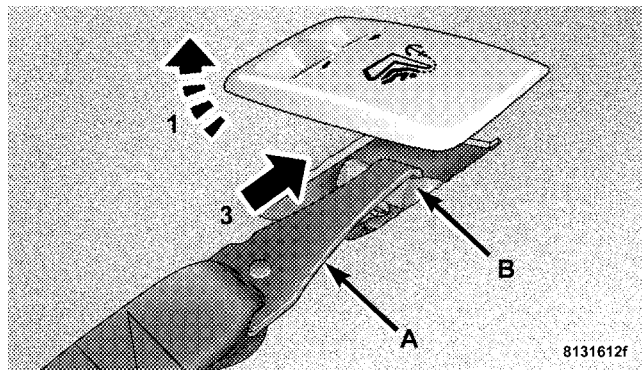

1— Cover
3— Attaching Strap

A—Tether Strap Hook
B—Tether Anchor

8131612f

2. Route the tether strap to provide the most direct path for the strap between the anchor and the child seat. If your vehicle is equipped with adjustable rear head restraints, raise the head restraint, and where possible, route the tether strap under the head restraint and

between the two posts. If not possible, lower the head restraint and pass the tether strap around the outboard side of the head restraint.

3. Attach the tether strap hook (A) of the child restraint to the anchor (B) and remove slack in the tether strap according to the child restraint manufacturer's instructions.

WARNING!

An incorrectly anchored tether strap could lead to increased head motion and possible injury to the child. Use only the anchor positions directly behind the child seat to secure a child restraint top tether strap.

Installing Child Restraints Using the Vehicle Seat belt

The passenger seat belts are equipped with Automatic Locking Retractors (ALRs), which are designed to keep the lap portion tight around the child restraint.

The seat belt must be in the Automatic Locking Mode in order to enable a child restraint to be tightly installed. Refer to "Automatic Locking Mode" in this section for details. A locking clip should not be necessary once the automatic locking feature is enabled. Position the shoulder and lap belt on the child restraint. The Automatic Locking Retractor (ALR) is activated by first attaching the child seat, then pulling all of the webbing out of the retractor, then allowing the webbing to retract. As the webbing retracts, you will hear a clicking sound. This indicates the safety belt is now in the Automatic Locking Mode. To release, simply unbuckle the seat belt by depressing the button, and allow the webbing to retract into the retractor.

In the rear seat, you may have trouble tightening the lap/shoulder belt on the child restraint because the buckle or latch plate is too close to the belt path opening on the restraint. Disconnect the latch plate from the buckle and twist the short buckle-end belt several times to shorten it. Insert the latch plate into the buckle with the release button facing out.

If the belt still can't be tightened, or if by pulling and pushing on the restraint loosens the belt, you may need to do something more. Disconnect the latch plate from the buckle, turn the buckle around, and insert the latch plate into the buckle again. If you still can't make the child restraint secure, try a different seating position.

Children Too Large For Booster Seats

Children who are large enough to wear the shoulder belt comfortably, and whose legs are long enough to bend

over the front of the seat when their back is against the seat back, should use the lap/shoulder belt in a rear seat. Make sure that:

- The child is upright in the seat.
- The lap portion should be low on the hips and as snug as possible.
- Check belt fit periodically. A child's squirming or slouching can move the belt out of position.
- If the shoulder belt contacts the face or neck, move the child closer to the center of the vehicle. Never allow a child to put the shoulder belt under an arm or behind their back.

Transporting Pets

Airbags deploying in the front seat could harm your pet. An unrestrained pet will be thrown about and possibly injured, or injure a passenger during panic braking or in a collision.

Pets should be restrained in the rear seat in pet harnesses or pet carriers that are secured by seat belts.

ENGINE BREAK-IN RECOMMENDATIONS

A long break-in period is not required for the engine in your vehicle.

Drive moderately during the first 300 mi (500 km). After the initial 60 mi (100 km), speeds up to 50 or 55 mph (80 or 90 km/h) are desirable.

While cruising, brief full-throttle acceleration, within the limits of local traffic laws, contributes to a good break-in. Wide-open throttle acceleration in low gear can be detrimental and should be avoided.

The engine oil installed in the engine at the factory is a high-quality energy-conserving type lubricant. Oil changes should be consistent with anticipated climate conditions under which vehicle operations will occur. For the recommended viscosity and quality grades, refer to

“Maintenance Procedures” in Section 7. **NON-DETERGENT OR STRAIGHT MINERAL OILS MUST NEVER BE USED.**

A new engine may consume some oil during its first few thousand miles (kilometers) of operation. This should be considered as a normal part of the break-in and not interpreted as an indication of difficulty.

SAFETY TIPS

Exhaust Gas

WARNING!

Exhaust gases can injure or kill. They contain carbon monoxide (CO) which is colorless and odorless. Breathing it can make you unconscious and can eventually poison you. To avoid breathing (CO) follow the safety tips below.

Do not run the engine in a closed garage or in confined areas any longer than needed to move your vehicle in or out of the area.

If it is necessary to sit in a parked vehicle with the engine running, adjust your heating or cooling controls to force outside air into the vehicle. Set the blower at high speed.

WARNING!

If you are required to drive with the deck lid open, make sure that all windows are closed, and the climate control blower switch is set at high speed. DO NOT use the recirculation mode.

Safety Checks You Should Make Inside The Vehicle

Seat Belts

Inspect the belt system periodically, checking for cuts, frays and loose parts. Damaged parts must be replaced immediately. Do not disassemble or modify the system.

Front seat belt assemblies must be replaced after a collision. Rear seat belt assemblies must be replaced after a collision if they have been damaged (bent retractor, torn webbing, etc.). If there is any question regarding belt or retractor condition, replace the belt.

Airbag Light

The light should come on and remain on for six to eight seconds as a bulb check when the ignition switch is first turned ON. If the LED is not lit during starting, have it checked. If the light stays on or comes on while driving, have the system checked by an authorized dealer.

Defroster

Check operation by selecting the defrost mode and place the blower control on high speed. You should be able to feel the air directed against the windshield.

NOTE: If the defrost feature is not functioning, the cause should be located and corrected immediately by an authorized service center. The windshield could fog up while driving and obscure your visibility.

Periodic Safety Checks You Should Make Outside The Vehicle

Tires

Examine tires for excessive tread wear or uneven wear patterns. Check for stones, nails, glass, or other objects lodged in the tread. Inspect tread and sidewall for cuts or cracks. Check wheel nuts for tightness, and tires (including spare) for proper pressure.

Lights

Have someone observe the operation of exterior lights while you work the controls. Check turn signal and high beam indicator lights on the instrument panel.

Fluid Leaks

Check area under vehicle after overnight parking for fuel, engine coolant, oil, or other fluid leaks. In addition, if gasoline fumes are detected or fuel, power steering fluid, transmission fluid, or brake fluid leaks are suspected, the cause should be located and corrected immediately.

UNDERSTANDING THE FEATURES OF YOUR VEHICLE

CONTENTS

■ Mirrors85	□ Phone Call Features98
□ Inside Day/Night Mirror — If Equipped85	□ UConnect® System Features	100
□ Automatic Dimming Mirror — If Equipped86	□ Advanced Phone Connectivity	105
□ Electric Remote-Control Mirrors86	□ Things You Should Know About Your UConnect® System	107
□ Adjusting Side View Mirrors87	□ General Information	115
□ Illuminated Vanity Mirrors — If Equipped88	■ Voice Recognition System — If Equipped	115
■ Hands-Free Communication (UConnect®) — If Equipped89	□ Voice Recognition System (VR) Operation	115
□ Operation91	□ Commands	116

- Voice Training 119
- Seats 120
 - Manual Front Seat Adjustments 120
 - Power Seats — If Equipped 123
 - Heated Seats — If Equipped 123
 - Fold-Flat Front Passenger Seat 124
 - Adjustable Head Restraints 125
 - Folding Rear Seat 126
 - Folding Rear Seat Center Armrest 127
- To Open And Close The Hood 127
- Lights 129
 - Map/Reading/Interior Lights 129
 - Multi-Function Control Lever 130
 - Headlights; Parking Lights; Instrument Lights . . 130
 - Automatic Headlight System — If Equipped . . 131
 - Headlight Time Delay 131
 - Passing Light / Flash-To-Pass 131
 - Daytime Running Lights (DRL) —
If Equipped 132
 - Lights On Reminder 132
 - Fog Lights — If Equipped 132
 - Turn Signals 133
 - Highbeam/Lowbeam Select Switch 134
- Windshield Wipers And Washers 134
 - Intermittent Wiper System 136
 - Mist Feature 137

- Headlights With Wipers Feature
(Available With Auto Headlights Only) 137
- Windshield Washers 138
- Adding Washer Fluid 138
- Tilt/Telescoping Steering Column 139
- Electronic Speed Control — If Equipped 140
 - To Activate 140
 - To Set Desired Speed 141
 - To Deactivate 141
 - To Resume Speed 141
 - To Vary Speed Setting 142
 - To Accelerate For Passing 142
- Garage Door Opener — If Equipped 143

- Programming HomeLink® 144
- Gate Operator/Canadian Programming 148
- Security 148
- Troubleshooting Tips 149
- General Information 149
- Power Sunroof — If Equipped 150
 - Sunroof Operation 151
 - Auto Sunroof Express With Anti-Pinch
Protection — If Equipped 151
 - Sunshade Operation 152
 - Wind Buffeting 152
 - Sunroof Maintenance 152
 - Ignition Off Operation 152

■ Electrical Power Outlets	153	■ Cup Holders	158
□ Electrical Outlet Use With Engine Off	154	□ Heated Or Cooled Cup Holder — If Equipped	158
■ Cigar Lighter And Ash Receiver — If Equipped . .	155	□ Rear Bottle Holders	159
□ Cupholder Ash Receiver — If Equipped	155	■ Storage	160
■ Console Features	156	□ Cargo Area	160
□ Dual Storage Bins	156	■ Beverage Cooler Storage Bin — If Equipped	161
□ Video Console — If Equipped	157		

MIRRORS

INSIDE DAY/NIGHT MIRROR — IF EQUIPPED

Adjust the mirror to center on the view through the rear window. A two-point pivot system allows for horizontal and vertical mirror adjustment.

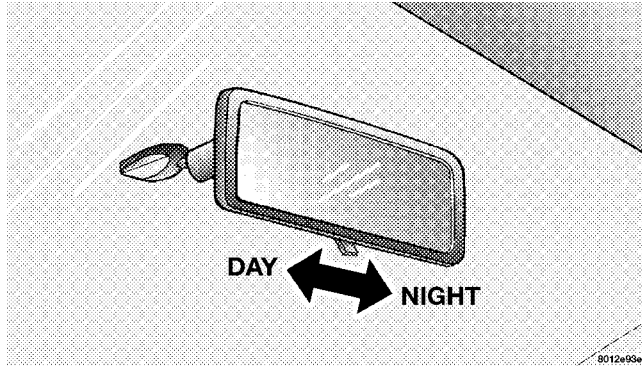

Adjusting Rear View Mirror

Annoying headlight glare can be reduced by moving the small control under the mirror to the night position (toward rear of vehicle). The mirror should be adjusted while set in the day position (toward windshield).

AUTOMATIC DIMMING MIRROR — IF EQUIPPED

This mirror will automatically adjust for annoying headlight glare from vehicles behind you. Push in the button on the face of the mirror to activate the dimming feature.

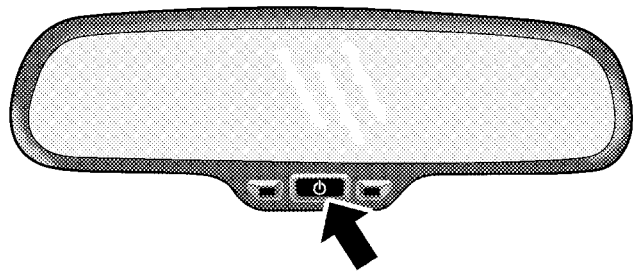

81f1be98

Automatic Dimming Mirror — If Equipped

CAUTION!

To avoid damage to the mirror during cleaning, never spray any cleaning solution directly onto the mirror. Apply the solution onto a clean cloth and wipe the mirror clean.

ELECTRIC REMOTE-CONTROL MIRRORS

Both of the outside mirrors can be adjusted by using the remote controls mounted on the driver's door panel.

A rotary knob selects the left mirror, right mirror, or off position.

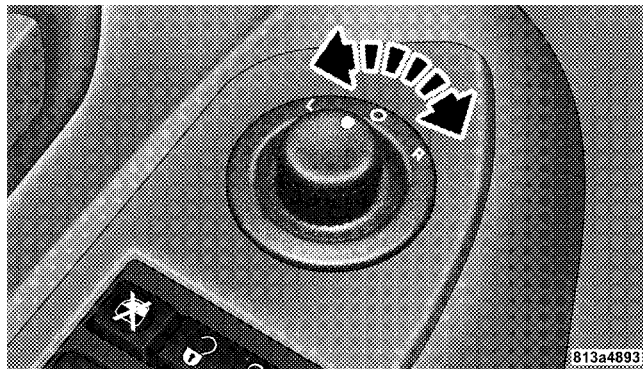

Power Mirror Adjust Switch

After selecting a mirror, move the knob in the same direction you want the mirror to move. When finished, return the knob to the center O (OFF) position to guard against accidentally moving a mirror position.

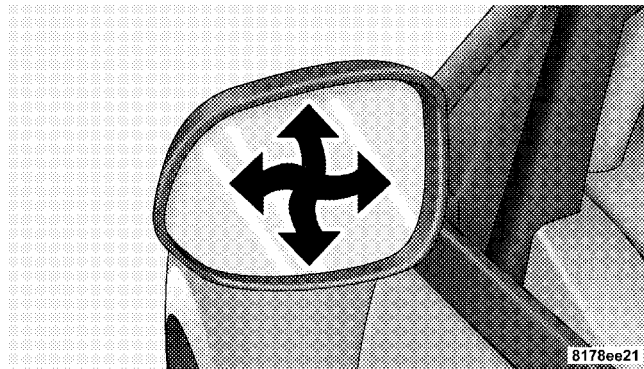

Mirror Directions

ADJUSTING SIDE VIEW MIRRORS

Outside Mirror — Driver's Side

Adjust the outside mirror to center on the adjacent lane of traffic, with a slight overlap of the view obtained on the inside mirror.

Outside Mirror — Passenger's Side

Adjust the convex outside mirror so you can just see the side of your vehicle in the part of the mirror closest to the vehicle.

WARNING!

Vehicles and other objects seen in the right side convex mirror will look smaller and farther away than they really are. Relying too much on your right side mirror could cause you to collide with another vehicle or other object. Use your inside mirror when judging the size or distance of a vehicle seen in this convex mirror.

ILLUMINATED VANITY MIRRORS — IF EQUIPPED

An illuminated vanity mirror is on each sun visor. To use the mirror, rotate the sun visor down and swing the mirror cover upward. The lights will turn on automatically. Closing the mirror cover turns off the lights.

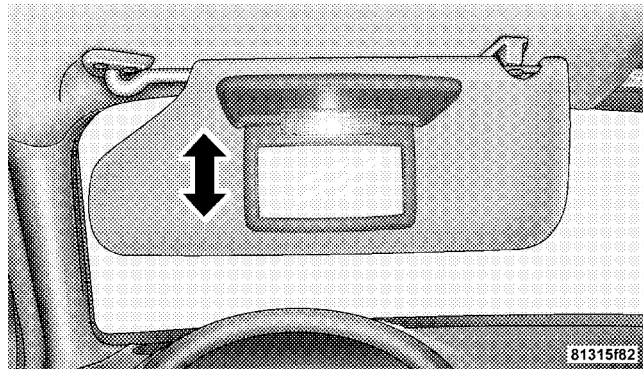

Illuminated Vanity Mirror

HANDS-FREE COMMUNICATION (UConnect®) — IF EQUIPPED

NOTE: The sales code RER, REN and REU radios contain an integrated Hands-Free Communication (UConnect®) system. Refer to your “Navigation User’s Manual” for UConnect® system operating instructions for these radios.

UConnect® is a voice-activated, hands-free, in-vehicle communications system. UConnect® allows you to dial a phone number with your cellular phone using simple voice commands (e.g., “Call” ... “Mike” ... “Work” or “Dial” ... “248-555-1212”). Your cellular phone’s audio is transmitted through your vehicle’s audio system; the system will automatically mute your radio when using the UConnect® system.

NOTE: The UConnect® system requires a cellular phone equipped with the Bluetooth® “Hands-Free Profile,” Version 0.96 or higher. See the UConnect® website for supported phones.

NOTE: For UConnect® customer support, visit the following websites:

- www.chrysler.com/uconnect
- www.dodge.com/uconnect
- www.jeep.com/uconnect
- or call 1-877-855-8400

UConnect® allows you to transfer calls between the system and your cellular phone as you enter or exit your vehicle and enables you to mute the system’s microphone for private conversation.

The UConnect® phonebook enables you to store up to 32 names, with four numbers per name. Each language has

a separate 32-name phonebook accessible only in that language. This system is driven through your Bluetooth® “Hands-Free profile” cellular phone. UConnect® features Bluetooth® technology - the global standard that enables different electronic devices to connect to each other without wires or a docking station, so UConnect® works no matter where you stow your cellular phone (be it your purse, pocket, or briefcase), as long as your phone is turned on and has been paired to the vehicle’s UConnect® system. The UConnect® system allows up to seven cellular phones to be linked to the system. Only one linked (or paired) cellular phone can be used with the system at a time. The system is available in English, Spanish, or French languages.

Phone Button



The rearview mirror contains the microphone for the system (depending on the type of mirror and radio equipped), and either the

radio or the mirror has the two control buttons (PHONE Button and VOICE RECOGNITION button) that will enable you to access the system.

Voice Recognition Button



Actual button location may vary with radio. The individual buttons are described in the “Operation” section.

The UConnect® system can be used with any Hands-Free Profile certified Bluetooth® cellular phone. See the UConnect® website for supported phones. If your cellular phone supports a different profile (e.g., Headset Profile) you may not be able to use any UConnect® features. Refer to your cellular service provider or the phone manufacturer for details.

The UConnect® system is fully integrated with the vehicle’s audio system. The volume of the UConnect® system

can be adjusted either from the radio volume control knob or from the steering wheel radio control (right switch), if so equipped.

The radio display will be used for visual prompts from the UConnect® system such as "CELL" or caller ID on certain radios.

Operation

Voice commands can be used to operate the UConnect® system and to navigate through the UConnect® menu structure. Voice commands are required after most UConnect® system prompts. You will be prompted for a specific command and then guided through the available options.

- Prior to giving a voice command, one must wait for the beep, which follows the "Ready" prompt or another prompt.

- For certain operations, compound commands can be used. For example, instead of saying "Setup" and then "Phone Pairing," the following compound command can be said: "Setup Phone Pairing."
- For each feature explanation in this section, only the combined form of the voice command is given. You can also break the commands into parts and say each part of the command when you are asked for it. For example, you can use the combined form voice command "Phonebook New Entry," or you can break the combined form command into two voice commands: "Phonebook" and "New Entry." Please remember, the UConnect® system works best when you talk in a normal conversational tone, as if speaking to someone sitting a few feet/meters away from you.

Voice Command Tree

Refer to "Voice Tree" in this section.

Help Command

If you need assistance at any prompt, or if you want to know your options at any prompt, say "Help" following the beep. The UConnect® system will play all the options at any prompt if you ask for help.

To activate the UConnect® system from idle, simply press the PHONE button and follow the audible prompts for directions. All UConnect® system sessions begin with a press of the PHONE button on the radio control head.

Cancel Command

At any prompt, after the beep, you can say "Cancel" and you will be returned to the main menu. However, in a few instances the system will take you back to the previous menu.

Pair (Link) UConnect® System to a Cellular Phone

To begin using your UConnect® system, you must pair your compatible Bluetooth® enabled cellular phone.

To complete the pairing process, you will need to reference your cellular phone Owner's Manual. The UConnect® website may also provide detailed instructions for pairing.

The following are general phone to UConnect® system pairing instructions:

- Press the PHONE button to begin.
- After the "Ready" prompt and the following beep, say "Setup Phone Pairing."
- When prompted, after the beep, say "Pair a Phone" and follow the audible prompts.
- You will be asked to say a four-digit Personal Identification Number (PIN), which you will later need to enter into your cellular phone. You can enter any four-digit PIN. You will not need to remember this PIN after the initial pairing process.

- For identification purposes, you will be prompted to give the UConnect® system a name for your cellular phone. Each cellular phone that is paired should be given a unique phone name.
- You will then be asked to give your cellular phone a priority level between 1 and 7, with 1 being the highest priority. You can pair up to seven cellular phones to your UConnect® system. However, at any given time, only one cellular phone can be in use, connected to your UConnect® system. The priority allows the UConnect® system to know which cellular phone to use if multiple cellular phones are in the vehicle at the same time. For example, if priority 3 and priority 5 phones are present in the vehicle, the UConnect® system will use the priority 3 cellular phone when you make a call. You can select to use a lower priority cellular phone at any time (refer to "Advanced Phone Connectivity" in this section).

Dial by Saying a Number

- Press the PHONE button to begin.
- After the "Ready" prompt and the following beep, say "Dial."
- The system will prompt you to say the number you want to call.
- For example, you can say "234-567-8901." The phone number that you enter must be of valid length and combination. Based on the country in which the vehicle was purchased, the UConnect® system limits the user from dialing an invalid combination of numbers. For example, in the U.S., 234-567-890 is nine digits long, which is not a valid U.S. phone number - the closest valid phone number has 10 digits.
- The UConnect® system will confirm the phone number and then dial. The number will appear in the display of certain radios.

Call by Saying a Name

- Press the PHONE button to begin.
- After the "Ready" prompt and the following beep, say "Call."
- The system will prompt you to say the name of the person you want to call.
- After the "Ready" prompt and the following beep, say the name of the person you want to call. For example, you can say "John Doe," where John Doe is a previously stored name entry in the UConnect® phonebook. To learn how to store a name in the phonebook, refer to "Add Names to Your UConnect® Phonebook," in this section.
- The UConnect® system will confirm the name and then dial the corresponding phone number, which may appear in the display of certain radios.

Add Names to Your UConnect® Phonebook

NOTE: Adding names to the phonebook is recommended when the vehicle is not in motion.

- Press the PHONE button to begin.
- After the "Ready" prompt and the following beep, say "Phonebook New Entry."
- When prompted, say the name of the new entry. Use of long names helps the voice recognition and it is recommended. For example, say "Robert Smith" or "Robert" instead of "Bob."
- When prompted, enter the number designation (e.g., "Home," "Work," "Mobile," or "Pager"). This will allow you to store multiple numbers for each phonebook entry, if desired.
- When prompted, recite the phone number for the phonebook entry that you are adding.

After you are finished adding an entry into the phonebook, you will be given the opportunity to add more phone numbers to the current entry or to return to the main menu.

The UConnect® system will allow you to enter up to 32 names in the phonebook with each name having up to four associated phone numbers and designations. Each language has a separate 32-name phonebook accessible only in that language.

Phonebook Download

UConnect® allows the user to download entries from their phone via Bluetooth®. To use this feature, press the PHONE button and say “Phonebook Download.” The system prompts, “Ready to accept “V” card entry via Bluetooth®...” The system is now ready to accept phonebook entries from your phone using the Bluetooth®

Object Exchange Profile (OBEX). Please see your phone Owner’s Manual for specific instructions on how to send these entries from your phone.

NOTE:

- The phone handset must support Bluetooth® OBEX transfers of phonebook entries to use this feature.
- Some phones cannot send phonebook entries if they are already connected to any system via Bluetooth®, and you may see a message on the phone display that the Bluetooth® link is busy. In this case, the user must first disconnect or drop the Bluetooth® connection to the UConnect® system, and then send the address book entry via Bluetooth®. Please see your phone Owner’s Manual for specific instructions on how to drop the Bluetooth® connection.
- If the phonebook entry is longer than 24 characters, it will only use the first 24 characters.

Edit Entries in the UConnect® Phonebook

NOTE: Editing names in the phonebook is recommended when the vehicle is not in motion.

- Press the PHONE button to begin.
- After the "Ready" prompt and the following beep, say "Phonebook Edit."
- You will then be asked for the name of the phonebook entry that you wish to edit.
- Next, choose the number designation (home, work, mobile, or pager) that you wish to edit.
- When prompted, recite the new phone number for the phonebook entry that you are editing.

After you are finished editing an entry in the phonebook, you will be given the opportunity to edit another entry in the phonebook, call the number you just edited, or return to the main menu.

"Phonebook Edit" can be used to add another phone number to a name entry that already exists in the phonebook. For example, the entry John Doe may have a mobile and a home number, but you can add "John Doe's" work number later using the "Phonebook Edit" feature.

Delete Entries in the UConnect® Phonebook

NOTE: Editing phonebook entries is recommended when the vehicle is not in motion.

- Press the PHONE button to begin.
- After the "Ready" prompt and the following beep, say "Phonebook Delete."
- After you enter the Phonebook Delete menu, you will then be asked for the name of the entry that you wish to delete. You can either say the name of a phonebook entry that you wish to delete or you can say "List Names" to hear a list of the entries in the phonebook

from which you choose. To select one of the entries from the list, press the "Voice Recognition" button while the UConnect® system is playing the desired entry and say "Delete."

- After you enter the name, the UConnect® system will ask you which designation you wish to delete: home, work, mobile, pager, or all. Say the designation you wish to delete.
- Note that only the phonebook entry in the current language is deleted.

Delete All Entries in the UConnect® Phonebook

- Press the PHONE button to begin.
- After the "Ready" prompt and the following beep, say "Phonebook Erase All."
- The UConnect® system will ask you to verify that you wish to delete all the entries from the phonebook.

- After confirmation, the phonebook entries will be deleted.
- Note that only the phonebook in the current language is deleted.

List All Names in the UConnect® Phonebook

- Press the PHONE button to begin.
- After the "Ready" prompt and the following beep, say "Phonebook List Names."
- The UConnect® system will play the names of all the phonebook entries.
- To call one of the names in the list, press the "Voice Recognition" button during the playing of the desired name, and say "Call."

NOTE: The user can also exercise "Edit" or "Delete" operations at this point.

- The UConnect® system will then prompt you as to the number designation you wish to call.
- The selected number will be dialed.

Phone Call Features

The following features can be accessed through the UConnect® system if the feature(s) are available on your cellular service plan. For example, if your cellular service plan provides three-way calling, this feature can be accessed through the UConnect® system. Check with your cellular service provider for the features that you have.

Answer or Reject an Incoming Call - No Call Currently in Progress

When you receive a call on your cellular phone, the UConnect® system will interrupt the vehicle audio system, if on, and will ask if you would like to answer the call. Press the PHONE button to accept the call. To reject

the call, press and hold the PHONE button until you hear a single beep, indicating that the incoming call was rejected.

Answer or Reject an Incoming Call - Call Currently in Progress

If a call is currently in progress and you have another incoming call, you will hear the same network tones for call waiting that you normally hear when using your cell phone. Press the PHONE button to place the current call on hold and answer the incoming call.

NOTE: The UConnect® system compatible phones in the market today do not support rejecting an incoming call when another call is in progress. Therefore, the user can only answer an incoming call or ignore it.

Making a Second Call While Current Call in Progress

To make a second call while you are currently on a call, press the “Voice Recognition” button and say “Dial” or

"Call" followed by the phone number or phonebook entry you wish to call. The first call will be on hold while the second call is in progress. To go back to the first call, refer to "Toggling Between Calls" in this section. To combine two calls, refer to "Conference Call" in this section.

Place/Retrieve a Call From Hold

To put a call on hold, press the PHONE button until you hear a single beep. This indicates that the call is on hold. To bring the call back from hold, press and hold the PHONE button until you hear a single beep.

Toggling Between Calls

If two calls are in progress (one active and one on hold), press the PHONE button until you hear a single beep, indicating that the active and hold status of the two calls have switched. Only one call can be placed on hold at one time.

Conference Call

When two calls are in progress (one active and one on hold), press and hold the PHONE button until you hear a double beep indicating that the two calls have been joined into one conference call.

Three-Way Calling

To initiate three-way calling, press the "Voice Recognition" button while a call is in progress, and make a second phone call, as described under "Making a Second Call While Current Call in Progress." After the second call has established, press and hold the PHONE button until you hear a double beep, indicating that the two calls have been joined into one conference call.

Call Termination

To end a call in progress, momentarily press the PHONE button. Only the active call(s) will be terminated and if there is a call on hold, it will become the new active call. If the active call is terminated by the far end, a call on

hold may not become active automatically. This is cell phone-dependent. To bring the call back from hold, press and hold the PHONE button until you hear a single beep.

Redial

- Press the PHONE button to begin.
- After the "Ready" prompt and the following beep, say "Redial."
- The UConnect® system will call the last number that was dialed from your cellular phone.

NOTE: This may not be the last number dialed from the UConnect® system.

Call Continuation

Call continuation is the progression of a phone call on the UConnect® system after the vehicle ignition key has been switched to OFF. Call continuation functionality available on the vehicle can be any one of three types:

- After the ignition key is switched to OFF, a call can continue on the UConnect® system either until the call ends, or until the vehicle battery condition dictates cessation of the call on the UConnect® system and transfer of the call to the mobile phone.
- After the ignition key is switched to OFF, a call can continue on the UConnect® system for a certain duration, after which the call is automatically transferred from the UConnect® system to the mobile phone.
- An active call is automatically transferred to the mobile phone after the ignition key is switched to OFF.

UConnect® System Features

Language Selection

To change the language that the UConnect® system is using:

- Press the PHONE button to begin.

- After the "Ready" prompt and the following beep, say the name of the language you wish to switch to English, Espanol, or Francais.
- Continue to follow the system prompts to complete language selection.

After selecting one of the languages, all prompts and voice commands will be in that language.

NOTE: After every UConnect® language change operation, only the language-specific 32-name phonebook is usable. The paired phone name is not language-specific and usable across all languages.

Emergency Assistance

If you are in an emergency and the mobile phone is reachable:

- Pick up the phone and manually dial the emergency number for your area.

If the phone is not reachable and the UConnect® system is operational, you may reach the emergency number as follows:

- Press the PHONE button to begin.
- After the "Ready" prompt and the following beep, say "Emergency" and the UConnect® system will instruct the paired cellular phone to call the emergency number. This feature is supported in the U.S., Canada, and Mexico.

NOTE: The emergency number dialed is based on the country where the vehicle is purchased (911 for the U.S. and Canada and 060 for Mexico). The number dialed may not be applicable with the available cellular service and area.

The UConnect® system does slightly lower your chances of successfully making a phone call as to that for the cell phone directly.

Your phone must be turned on and paired to the UConnect® system to allow use of this vehicle feature in emergency situations, when the cell phone has network coverage and stays paired to the UConnect® system.

Towing Assistance

If you need towing assistance:

- Press the PHONE button to begin.
- After the "Ready" prompt and the following beep, say "Towing Assistance."

NOTE: The Towing Assistance number dialed is based on the country where the vehicle is purchased (1-800-528-2069 for the U.S., 1-877-213-4525 for Canada, 55-14-3454 for Mexico City and 1-800-712-3040 for outside Mexico City in Mexico).

Please refer to the 24-Hour "Towing Assistance" coverage details in the Warranty Information Booklet and on the 24-Hour Towing Assistance Card.

Paging

To learn how to page, refer to "Working with Automated Systems." Paging works properly except for pagers of certain companies, which time out a little too soon to work properly with the UConnect® system.

Voice Mail Calling

To learn how to access your voice mail, refer to "Working with Automated Systems."

Working with Automated Systems

This method is used in instances where one generally has to press numbers on the cellular phone keypad while navigating through an automated telephone system.

You can use your UConnect® system to access a voice mail system or an automated service, such as a paging service or automated customer service line. Some services require immediate response selection. In some instances, that may be too quick for use of the UConnect® system.

When calling a number with your UConnect® system that normally requires you to enter in a touch-tone sequence on your cellular phone keypad, you can press the “Voice Recognition” button and say the sequence you wish to enter, followed by the word “Send.” For example, if required to enter your PIN followed with a pound, (3 7 4 6 #), you can press the “Voice Recognition” button and say, “3 7 4 6 # Send.” Saying a number, or sequence of numbers, followed by “Send,” is also to be used for navigating through an automated customer service center menu structure, and to leave a number on a pager.

You can also send stored UConnect® phonebook entries as tones for fast and easy access to voice mail and pager entries. To use this feature, dial the number you wish to call and then press the “Voice Recognition” button and say, “Send.” The system will prompt you to enter the name or number and say the name of the phonebook entry you wish to send. The UConnect® system will then

send the corresponding phone number associated with the phonebook entry, as tones over the phone.

NOTE:

- You may not hear all of the tones due to cellular phone network configurations; this is normal.
- Some paging and voice mail systems have system time out settings that are too short and may not allow the use of this feature.

Barge In - Overriding Prompts

The “Voice Recognition” button can be used when you wish to skip part of a prompt and issue your voice recognition command immediately. For example, if a prompt is asking “Would you like to pair a phone, clear a...,” you could press the “Voice Recognition” button and say, “Pair a Phone” to select that option without having to listen to the rest of the voice prompt.

Turning Confirmation Prompts On/Off

Turning confirmation prompts off will stop the system from confirming your choices (e.g., the UConnect® system will not repeat a phone number before you dial it).

- Press the PHONE button to begin.
- After the "Ready" prompt and the following beep, say "Setup Confirmations." The UConnect® system will play the current confirmation prompt status and you will be given the choice to change it.

Phone and Network Status Indicators

If available on the radio and/or on a premium display such as the instrument panel cluster, and supported by your cell phone, the UConnect® system will provide notification to inform you of your phone and network status when you are attempting to make a phone call using UConnect®. The status is given for roaming, network signal strength, phone battery strength, etc.

Dialing Using the Cellular Phone Keypad

You can dial a phone number with your cellular phone keypad and still use the UConnect® system (while dialing via the cell phone keypad, the user must exercise caution and take precautionary safety measures). By dialing a number with your paired Bluetooth® cellular phone, the audio will be played through your vehicle's audio system. The UConnect® system will work the same as if you dial the number using voice recognition.

NOTE: Certain brands of mobile phones do not send the dial ring to the UConnect® system to play it on the vehicle audio system, so you will not hear it. Under this situation, after successfully dialing a number the user may feel that the call did not go through even though the call is in progress. Once your call is answered, you will hear the audio.

Mute/Un-Mute (Mute Off)

When you mute the UConnect® system, you will still be able to hear the conversation coming from the other party, but the other party will not be able to hear you. In order to mute the UConnect® system:

- Press the “Voice Recognition” button.
- Following the beep, say “Mute.”

In order to un-mute the UConnect® system:

- Press the “Voice Recognition” button.
- Following the beep, say “Mute off.”

Advanced Phone Connectivity

Transfer Call to and from Cellular Phone

The UConnect® system allows ongoing calls to be transferred from your cellular phone to the UConnect® system without terminating the call. To transfer an ongoing call

from your UConnect® paired cellular phone to the UConnect® system or vice versa, press the “Voice Recognition” button and say “Transfer Call.”

Connect or Disconnect Link Between the UConnect® System and Cellular Phone

Your cellular phone can be paired with many different electronic devices, but can only be actively “connected” with one electronic device at a time.

If you would like to connect or disconnect the Bluetooth® connection between a UConnect® paired cellular phone and the UConnect® system, follow the instructions described in your cellular phone User’s Manual.

List Paired Cellular Phone Names

- Press the PHONE button to begin.
- After the “Ready” prompt and the following beep, say “Setup Phone Pairing.”

- When prompted, say "List Phones."
- The UConnect® system will play the phone names of all paired cellular phones in order from the highest to the lowest priority. To "select" or "delete" a paired phone being announced, press the "Voice Recognition" button and say "Select" or "Delete." Also, see the next two sections for an alternate way to "select" or "delete" a paired phone.

Select Another Cellular Phone

This feature allows you to select and start using another phone paired with the UConnect® system.

- Press the PHONE button to begin.
- After the "Ready" prompt and the following beep, say "Setup Select Phone" and follow the prompts.
- You can also press the "Voice Recognition" button at any time while the list is being played, and then choose the phone that you wish to select.

- The selected phone will be used for the next phone call. If the selected phone is not available, the UConnect® system will return to using the highest priority phone present in or near (approximately within 30 ft [9 m]) the vehicle.

Delete UConnect® Paired Cellular Phones

- Press the PHONE button to begin.
- After the "Ready" prompt and the following beep, say "Setup Phone Pairing."
- At the next prompt, say "Delete" and follow the prompts.
- You can also press the "Voice Recognition" button at any time while the list is being played, and then choose the phone you wish to delete.

Things You Should Know About Your UConnect® System

UConnect® Tutorial

To hear a brief tutorial of the system features, press the PHONE button and say “UConnect® Tutorial.”

Voice Training

For users experiencing difficulty with the system recognizing their voice commands or numbers, the UConnect® system Voice Training feature may be used. To enter this training mode, follow one of the two following procedures:

From outside the UConnect® mode (e.g., from radio mode):

- Press and hold the “Voice Recognition” button for five seconds until the session begins, or,
- Press the “Voice Recognition” button and say the “Setup, Voice Training” command.

Repeat the words and phrases when prompted by the UConnect® system. For best results, the Voice Training session should be completed when the vehicle is parked with the engine running, all windows closed, and the blower fan switched OFF.

This procedure may be repeated with a new user. The system will adapt to the last trained voice only.

To restore the Voice Recognition system to factory default settings, enter the Voice Training session via the above procedure and follow the prompts.

Voice Recognition (VR)

- For best performance, adjust the rearview mirror to provide at least ½ in (1 cm) gap between the overhead console (if equipped) and the mirror.
- Always wait for the beep before speaking.

- Speak normally, without pausing, just as you would speak to a person sitting a few feet/meters away from you.
- Make sure that no one other than you is speaking during a voice recognition period.
- Performance is maximized under:
 - low-to-medium blower setting,
 - low-to-medium vehicle speed,
 - low road noise,
 - smooth road surface,
 - fully closed windows,
 - dry weather condition.
- Even though the system is designed for users speaking in North American English, French, and Spanish accents, the system may not always work for some.
- When navigating through an automated system such as voice mail, or when sending a page, at the end of speaking the digit string, make sure to say "Send."
- Storing names in the phonebook when the vehicle is not in motion is recommended.
- It is not recommended to store similar sounding names in the UConnect® phonebook.
- The UConnect® phonebook nametag recognition rate is optimized for the person who stored the name in the phonebook.
- You can say "O" (letter "O") for "0" (zero). "800" must be spoken "eight-zero-zero."
- Even though international dialing for most number combinations is supported, some shortcut dialing number combinations may not be supported.

- In a convertible vehicle, system performance may be compromised with the convertible top down.

Far End Audio Performance

- Audio quality is maximized under:
 - low-to-medium blower setting,
 - low-to-medium vehicle speed,
 - low road noise,
 - smooth road surface,
 - fully closed windows,
 - dry weather conditions, and
 - operation from the driver's seat.
- Performance, such as audio clarity, echo, and loudness to a large degree rely on the phone and network, and not the UConnect® system.

- Echo at the far end can sometimes be reduced by lowering the in-vehicle audio volume.
- In a convertible vehicle, system performance may be compromised with the convertible top down.

Bluetooth® Communication Link

Cellular phones have been found to lose connection to the UConnect® system. When this happens, the connection can generally be re-established by switching the phone off/on. Your cell phone is recommended to remain in Bluetooth® ON mode.

Power-Up

After switching the ignition key from OFF to either ON or ACC position, or after a language change, you must wait at least five seconds prior to using the system.

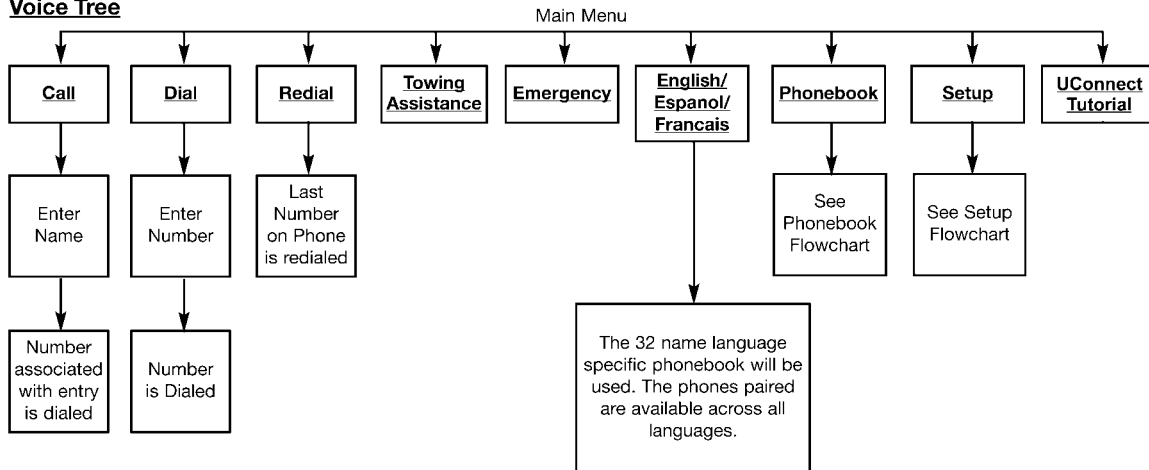
Voice Tree

Note: Available Voice commands are shown in bold face and are underlined.

81c6b7b

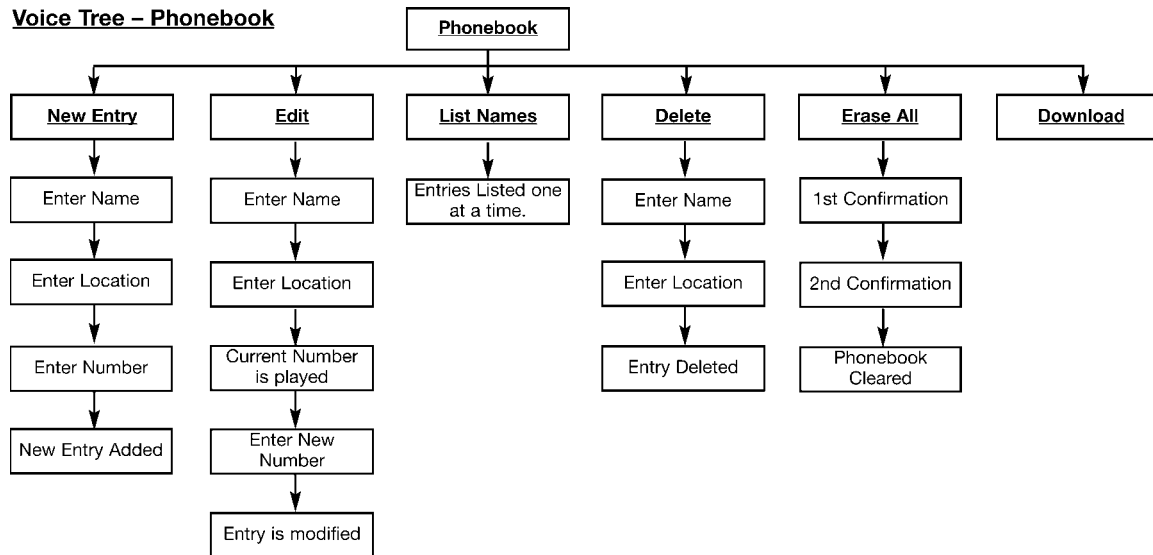
Voice Tree – Phonebook

Note: Available Voice commands are shown in bold face and are underlined.

81c6bf80

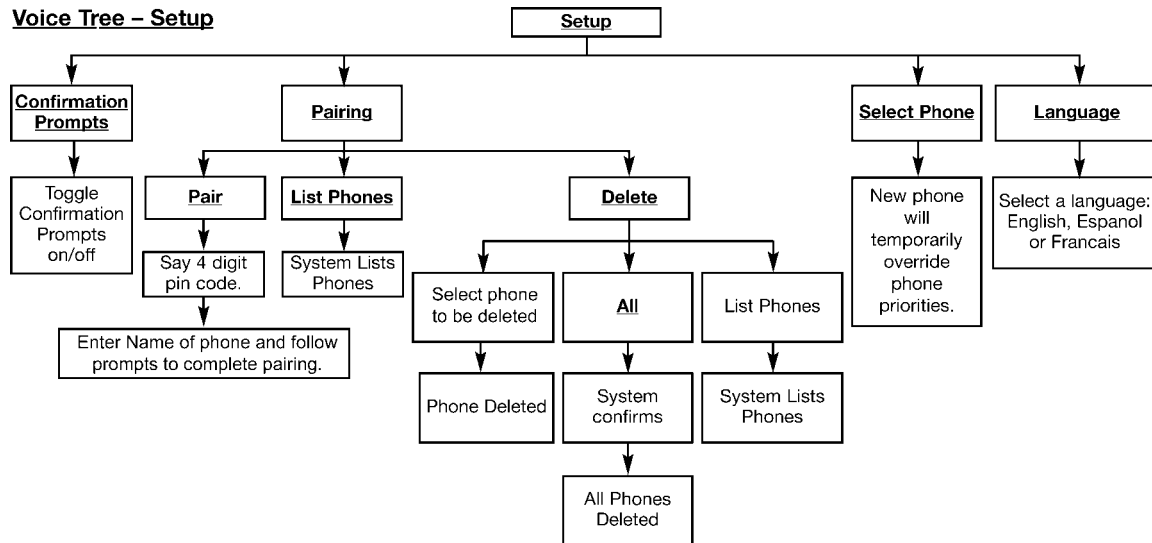
Voice Tree – Setup

Note: Available Voice commands are shown in bold face and are underlined.

819402e4

Voice Commands	
Primary	Alternate(s)
zero	
one	
two	
three	
four	
five	
six	
seven	
eight	
nine	
star (*)	
plus (+)	
pound (#)	
add location	
all	

Voice Commands	
Primary	Alternate(s)
call	
cancel	
confirmation prompts	
continue	
delete	
dial	
download	
edit	
emergency	
English	
erase all	
Espanol	
Francais	
help	
home	

Voice Commands	
Primary	Alternate(s)
language	
list names	
list phones	
mobile	
mute	
mute off	
new entry	
no	
pager	
pair a phone	
phone pairing	pairing
phonebook	phone book
previous	
record again	
redial	

Voice Commands	
Primary	Alternate(s)
return to main menu	return or main menu
select phone	select
send	
set up	phone settings or phone set up
towing assistance	
transfer call	
UConnect® Tutorial	
try again	
voice training	
work	
yes	

General Information

This device complies with Part 15 of the FCC rules and RSS 210 of Industry Canada. Operation is subject to the following conditions:

- This device may not cause harmful interference.
- This device must accept any interference received, including interference that may cause undesired operation.

VOICE RECOGNITION SYSTEM — IF EQUIPPED

Voice Recognition System (VR) Operation



This Voice Recognition System allows you to control your AM, FM radio, satellite radio, disc player, and a memo recorder.

NOTE: In a stressful situation, take care to speak into the Voice Interface System as calmly and normally as possible. The ability of the Voice Interface System to

recognize user voice commands may be negatively affected by rapid speaking or a raised voice level.

WARNING!

Any voice commanded system should be used only in safe driving conditions and all attention should be kept on the roadway ahead. Failure to do so may result in an accident causing serious injury or death.

3

When you press the VR hard-key, you will hear a beep. The beep is your signal to give a command.

NOTE: If you do not say a command within a few seconds, the system will present you with a list of options.

If you ever wish to interrupt the system while it lists options, press the VR hard-key, listen for the beep, and say your command.

Pressing the VR hard-key while the system is speaking is known as “barging in.” The system will be interrupted and you can add or change commands. This will become helpful once you start to learn the options.

NOTE: At any time, you can say the words CANCEL, HELP, or MAIN MENU.

These commands are universal and can be used from any menu. All other commands can be used depending upon the active application.

For example, if you are in the disc menu and you are listening to FM radio, you can speak commands from the disc menu or from the FM radio menu.

When using this system, you should speak clearly and at a normal speaking volume.

The system will best recognize your speech if the windows are closed, and the heater/air-conditioning fan is set to low.

At any point, if the system does not recognize one of your commands, you will be prompted to repeat it.

To hear the first available Menu, press the VR hard-key and say HELP or MAIN MENU.

Commands

The Voice Recognition System understands two types of commands. Global commands are available at all times. Local commands are available if the supported radio mode is active.

Changing the Volume

1. Start a dialogue by pressing the VR hard-key.
2. Say a command (e.g., HELP).
3. Use the ON/OFF VOLUME rotary knob to adjust the volume to a comfortable level while the voice recognition system is speaking. Please note the volume setting for VR is different then the audio system.

Main Menu

Start a dialogue by pressing the VR hard-key. You may say MAIN MENU to switch to the main menu.

In this mode, you can say the following commands:

- RADIO (to switch to the radio mode)
- DISC (to switch to the disc mode)
- MEMO (to switch to the memo recorder)

Radio AM (or Radio Long Wave or Radio Medium Wave - if equipped)

To switch to the AM band say AM or RADIO AM. In this mode, you may say the following commands:

- FREQUENCY (to change the frequency)
- NEXT STATION (to select the next station)

- PREVIOUS STATION (to select the previous station)
- RADIO MENU (to switch to the radio menu)
- MAIN MENU (to switch to the main menu)

Radio FM

To switch to the FM band say FM or RADIO FM. In this mode, you may say the following commands:

- FREQUENCY (to change the frequency)
- NEXT STATION (to select the next station)
- PREVIOUS STATION (to select the previous station)
- RADIO MENU (to switch to the radio menu)
- MAIN MENU (to switch to the main menu)

Satellite Radio

To switch to satellite radio mode say SAT or SATELLITE RADIO. In this mode, you may say the following commands:

- CHANNEL NUMBER (to change the channel by its spoken number)
- NEXT CHANNEL (to select the next channel)
- PREVIOUS CHANNEL (to select the previous channel)
- LIST CHANNEL (to hear a list of available channels)
- SELECT NAME (to say the name of a channel)
- RADIO MENU (to switch to the radio menu)
- MAIN MENU (to switch to the main menu)

Disc

To switch to the disc mode say DISC. In this mode, you may say the following commands:

- TRACK (#) (to change the track)
- NEXT TRACK (to play the next track)
- PREVIOUS TRACK (to play the previous track)
- MAIN MENU (to switch to the main menu)

Memo

To switch to the voice recorder mode say MEMO. In this mode, you may say the following commands:

- NEW MEMO (to record a new memo) — During the recording you may press the VR hard-key to stop recording. You continue by saying one of the following commands:
 - SAVE (to save the memo)

- CONTINUE (to continue recording)
- DELETE (to delete the recording)
- PLAY MEMOS (to play previously recorded memos)
 - During the playback you may press the VR hard-key to stop playing memos. You continue by saying one of the following commands:
 - REPEAT (to repeat a memo)
 - NEXT (to play the next memo)
 - PREVIOUS (to play the previous memo)
 - DELETE (to delete a memo)
- DELETE ALL (to delete all memos)

NOTE: Keep in mind that you have to press the VR hard-key first and wait for the beep, before speaking the “barge in” commands.

Voice Training

For users experiencing difficulty with the system recognizing their voice commands or numbers, the UConnect® system Voice Training feature may be used.

1. Press the VR hard-key, speak “System Setup” and once you are in that menu then speak “Voice Training.” This will train your own voice to the system and will improve recognition.
2. Repeat the words and phrases when prompted by the UConnect® System. For best results, the Voice Training session should be completed when the vehicle is parked, engine running, all windows closed, and the blower fan switched OFF. This procedure may be repeated with a new user. The system will adapt to the last trained voice only.

SEATS

Manual Front Seat Adjustments

Forward/Rearward

The adjusting bar is at the front of the seats, near the floor. Pull the bar up to move the seat to the desired position.

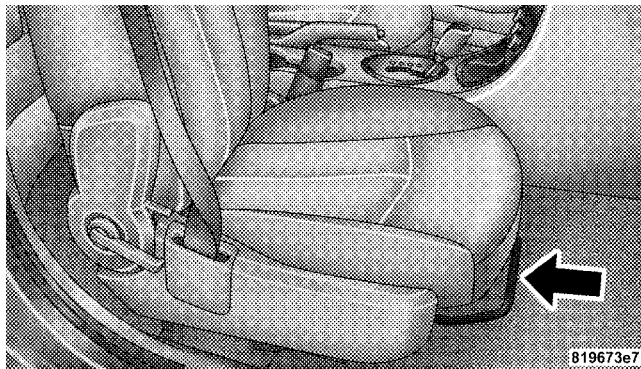

Manual Seat Adjusting Bar

After releasing the adjusting bar, apply forward and rearward body pressure to be sure the seat is latched.

Driver Seat Manual Height Adjuster — If Equipped

A lever style height adjustment feature enhances comfort for petite as well as tall drivers. A lever with a ratcheting mechanism, located on the outboard side of the seat, raises and lowers it. Total travel is 2.2 in. (56 mm).

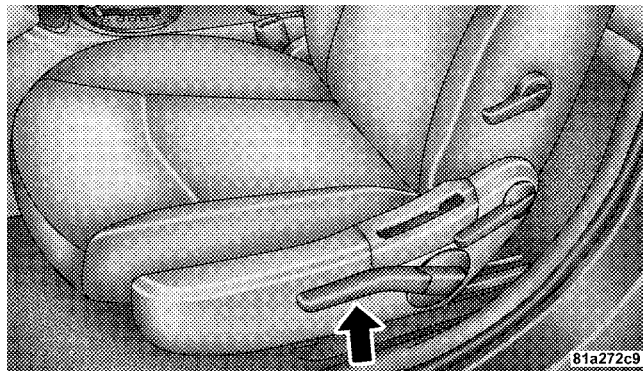

Manual Seat Height Adjustment Lever

Reclining Bucket Seats

The recliner control is on the side of the seat. To recline, lean forward slightly before lifting the lever, then lean back to the desired position and release the lever. Lean forward and lift the lever to return the seatback to its normal position.

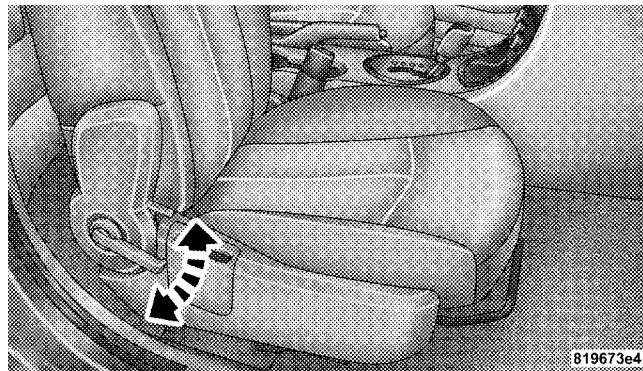

Seatback Adjustment

WARNING!

- **Adjusting a seat while the vehicle is moving is dangerous. The sudden movement of the seat could cause you to lose control. The seat belt might not be properly adjusted and you could be injured. Adjust the seat only while the vehicle is parked.**
- **Do not ride with the seatback reclined so that the shoulder belt is no longer resting against your chest. In a collision you could slide under the seat belt and be seriously or even fatally injured. Use the recliner only when the vehicle is parked.**

Lumbar Support — If Equipped

This feature allows you to increase or decrease the amount of lumbar support. The control lever is located on the outboard side of the driver's seatback. Turn the control lever downward to increase and upward to decrease the desired amount of lumbar support.

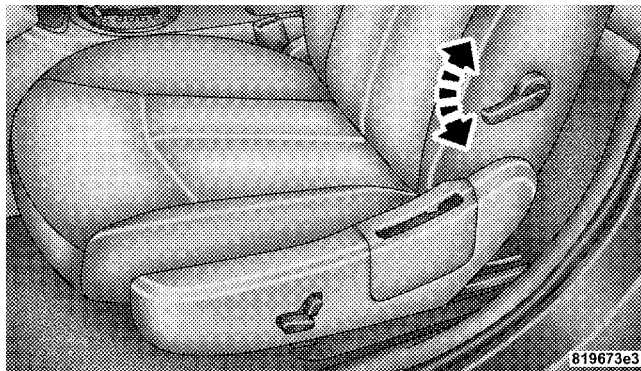
**Lumbar Support**

Power Seats — If Equipped

The power seat switches are on the outboard side of the seat near the floor. Use the front switch to move the seat up, down, forward, rearward, or to tilt the seat. The rear switch controls the seatback recliner.

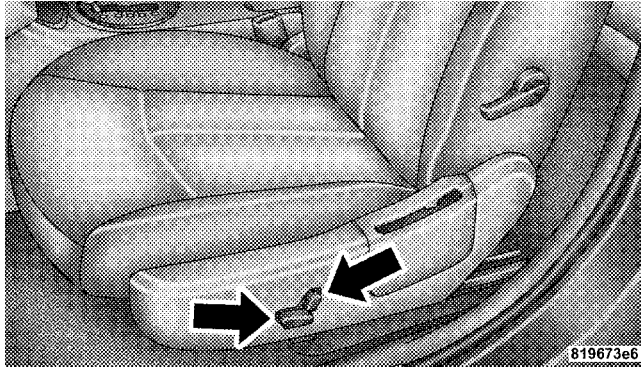

Power Seat Switches

CAUTION!

Do not place any article under a power seat as it may cause damage to the seat controls.

3

HEATED SEATS — IF EQUIPPED

WARNING!

Persons who are unable to feel pain to the skin because of advanced age, chronic illness, diabetes, spinal cord injury, medication, alcohol use, exhaustion or other physical condition must exercise care when using the seat heater. It may cause burns even at low temperatures, especially if used for long periods of time. Do not place anything on the seat that insulates against heat, such as a blanket or cushion. This may cause the seat heater to overheat.

This feature heats leather or cloth front driver and passenger seats. The controls for the heated seats are located in the center console below the climate controls. There are indicator lights in the switches, which indicate a low heat setting (one light lit) or high heat setting (two lights lit).

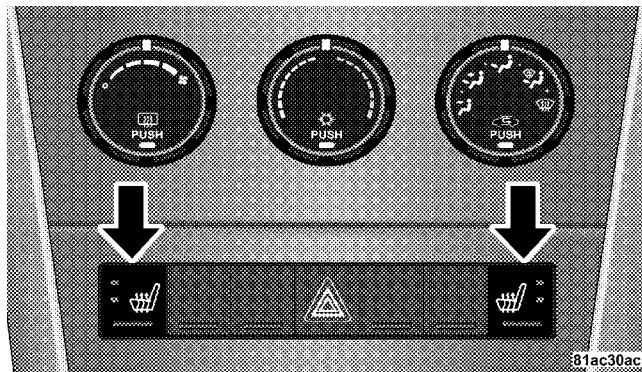

Heated Seat Switches

FOLD-FLAT FRONT PASSENGER SEAT

The recline handle on the front passenger seat also releases the seatback to fold forward.

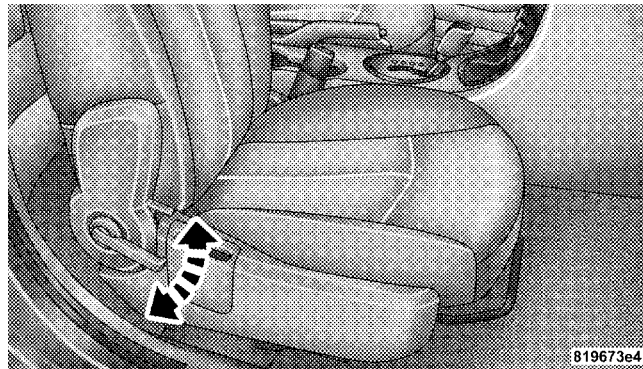

Seatback Adjustment

The hard seatback features a work surface and a molded rim for retaining items stored on the seat back panel.

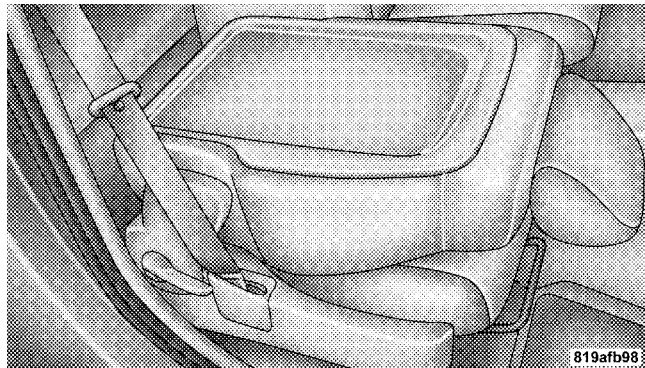

Fold Flat Front Passenger Seat

ADJUSTABLE HEAD RESTRAINTS

Head restraints can reduce the risk of whiplash injury in the event of impact from the rear. Adjust the restraints so that the upper edge is as high as practical. To raise, pull up on the head restraint. To lower, depress the button on the post guide and push down on the head restraint.

3

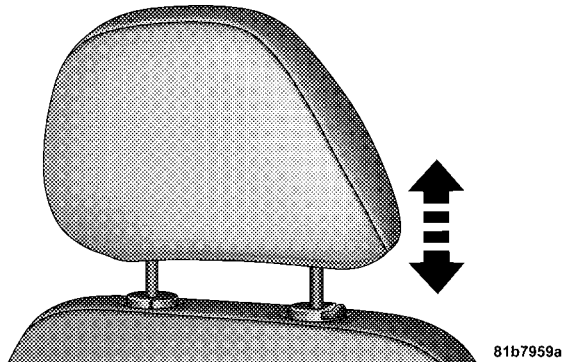

Adjustable Head Restraint

FOLDING REAR SEAT

To provide additional storage area, the rear seatback can be folded forward. Pull on the loops shown in the picture to fold down either or both seatbacks.

When returning the rear seat back to the upright position, be sure the seat back is latched.

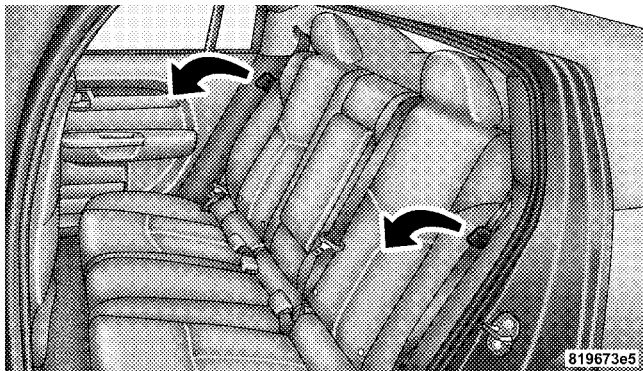

Folding Rear Seats

WARNING!

The rear cargo area of the vehicle (with the rear seatbacks in the locked-up or folded down position) should not be used as a play area by children. They could be seriously injured in an accident. Children should be seated and using the proper restraint system.

FOLDING REAR SEAT CENTER ARMREST

The rear seat is equipped with a folding armrest with cup holders.

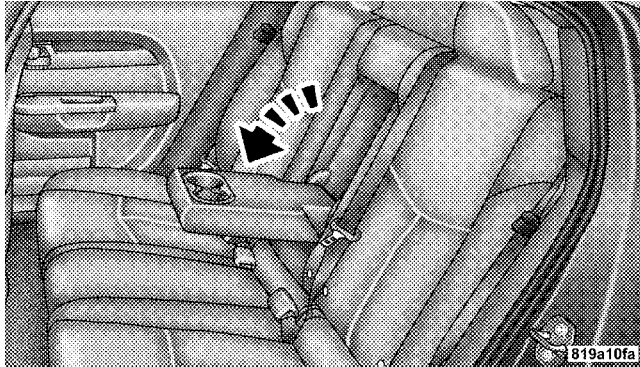

Folding Rear Seat Armrest

TO OPEN AND CLOSE THE HOOD

To open the hood, two latches must be released. First pull the hood release lever located under the left side of the instrument panel.

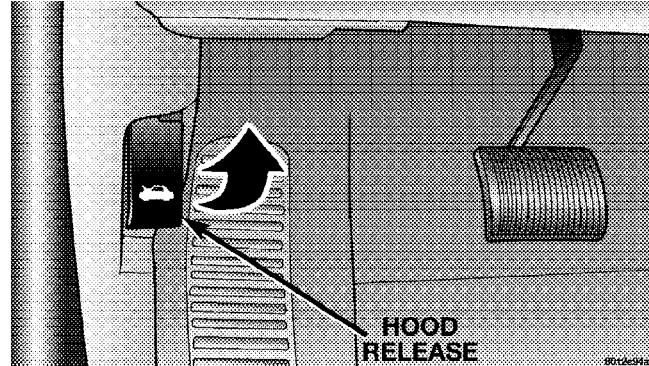

Hood Release Lever

Then lift the secondary latch located under the front edge of the hood, near the center and raise the hood.

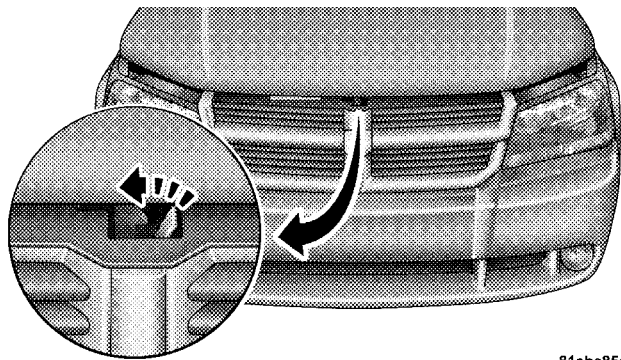

81abe85d

Hood Safety Catch

Use the hood prop rod to secure the hood in the open position. Place the upper end of the prop rod in the hole on the left underside of the hood.

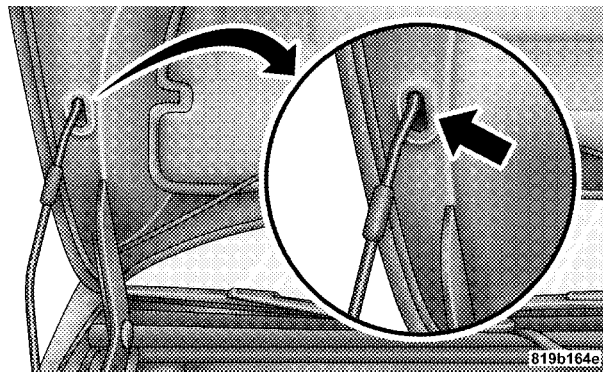

819b164e

Hood Prop Rod Hole Location

Before closing the hood, make sure to stow the prop rod in its proper location. To prevent possible damage, do not slam the hood to close it. Use a firm downward push at the center of the hood to ensure that both latches engage.

WARNING!

If the hood is not fully latched it could fly up when the vehicle is moving and block your forward vision. You could have a collision. Be sure all hood latches are fully latched before driving.

LIGHTS**MAP/READING/INTERIOR LIGHTS**

These lights are mounted between the sun visors above the rear view mirror. Each light is turned ON by pressing the button. Press the button a second time to turn the light OFF. The lights will remain on until the switch is pressed a second time, so be sure they have been turned off before leaving the vehicle. They will not turn off automatically. Interior lighting also comes on when a door is opened or the dimmer control is turned fully upward, past the second detent.

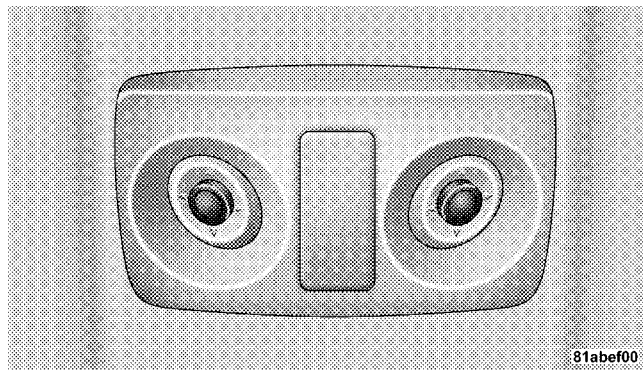
**Interior Dome Lamp**

There is a second light located midway back in the headliner.

To protect the battery, the interior lights will turn off automatically 10 minutes after the ignition switch is moved to the LOCK position. This will occur if the interior lights were switched on manually or are on

because a door is open. This includes the glove box light, but not the trunk light. To restore interior light operation, either turn the ignition switch ON or cycle the light switch.

MULTI-FUNCTION CONTROL LEVER

The Multi-Function Control Lever controls the operation of the headlights, parking lights, turn signals, headlight beam selection, instrument panel light dimming, interior lights, the passing lights, and fog lights. The lever is located on the left side of the steering column.

HEADLIGHTS; PARKING LIGHTS; INSTRUMENT LIGHTS

Turn the end of the Multi-Function Control Lever to the first detent for parking light operation. Turn to the second detent for headlight operation. Turn to the third detent "A" for "Auto" headlight operation (if equipped).

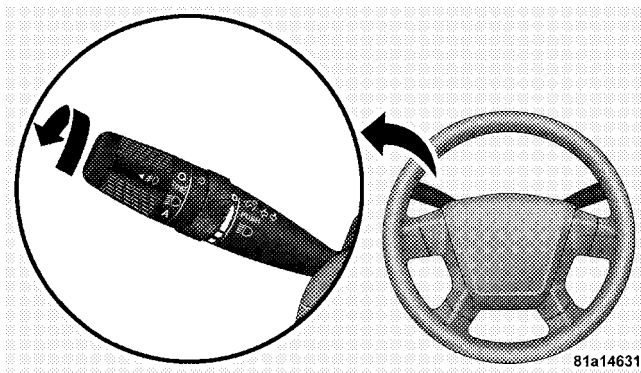

HEADLIGHT Switch

To change the brightness of the instrument panel lights, rotate the center portion of the Multi-Function Control Lever up or down.

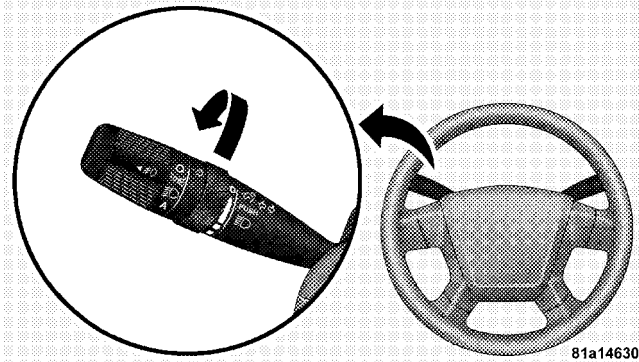

Dimmer Control

AUTOMATIC HEADLIGHT SYSTEM — IF EQUIPPED

Turning the end of the multi-function control lever to the third detent, “A” (Auto), will activate the automatic headlight system.

With the engine running and the multi-function control lever in the “A” (Auto) position, the headlights will turn on and turn off based on the surrounding light levels.

HEADLIGHT TIME DELAY

There is also a feature that delays turning off the vehicle lights for 30, 60, or 90 seconds after the ignition switch is turned OFF. To activate the headlight delay, the multi-function control lever must be rotated to the “Off” position after the ignition switch is turned OFF. Only the headlights will illuminate during this time. Refer to “EVIC- Customer Programmable Features” in Section 4 to turn this feature “On/Off” or set the time interval.

PASSING LIGHT / FLASH-TO-PASS

You can signal another vehicle with your headlights by lightly pulling the Multi-Function Control Lever toward you. This will cause the headlights to turn on at high beam and remain on until the lever is released.

NOTE: If the Multi-Function Control Lever is held in the flash to pass position for more than 15 seconds, the high beams will shut off. If this occurs, wait 30 seconds for the next flash to pass operation.

DAYTIME RUNNING LIGHTS (DRL) — IF EQUIPPED

The high beam lights will come on as Daytime Running Lights (DRL) at DRL intensity (lower), whenever the ignition is on, the engine is running, the headlight switch is off, the parking brake is off, the turn signal is off, and the gearshift lever is in any position except park.

NOTE: On this vehicle, the daytime running light will automatically turn off when the turn signal is in operation and automatically turn back on when the turn signal is not operating.

LIGHTS ON REMINDER

If the headlights or parking lights are on after the ignition is turned OFF, a chime will sound to alert the driver when the driver's door is opened.

FOG LIGHTS — IF EQUIPPED

 The front fog light switch is on the Multi-Function Control Lever. To activate the front fog lights, turn on the parking lights or the low beam headlights and pull out the end of the control lever.

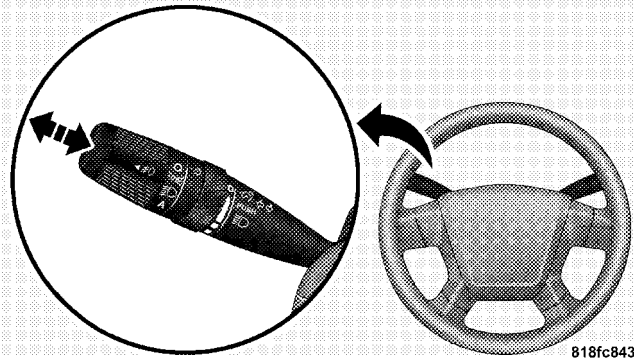

818fc843

Front Fog Light Control

NOTE: The front fog lights will only operate with the headlights on low beam. Selecting high beam headlights will turn off the front fog lights.

TURN SIGNALS

Move the Multi-Function Control Lever up or down and the arrows on each side of the instrument cluster flash to show proper operation of the front and rear turn signal lights. You can signal a lane change by moving the lever partially up or down without moving beyond the detent.

3

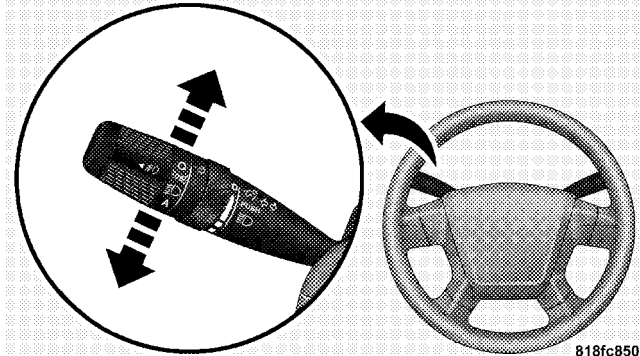

818fc850

Turn Signal Control

If either light remains on and does not flash, or there is a very fast flash rate, check for a defective outside light bulb. If an indicator fails to light when the lever is moved, it would suggest that the fuse or indicator bulb is defective.

HIGHBEAM/LOWBEAM SELECT SWITCH

Push the Multi-Function Control Lever away from you to switch the headlights to HIGH beam. Pull the Lever toward you, to switch the headlights back to Low beam.

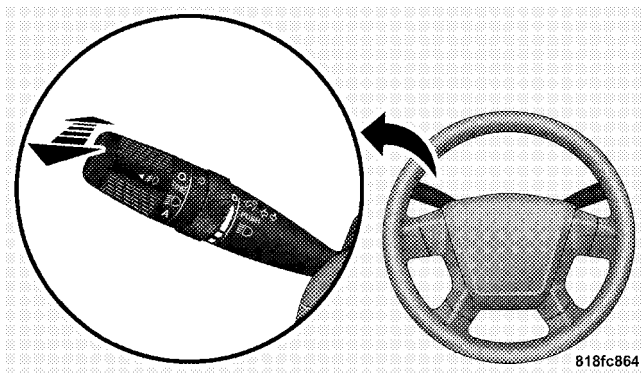

Highbeam Functions

WINDSHIELD WIPERS AND WASHERS



The wipers and washers are operated by a switch on the control lever. The lever is located on the right side of the steering column.

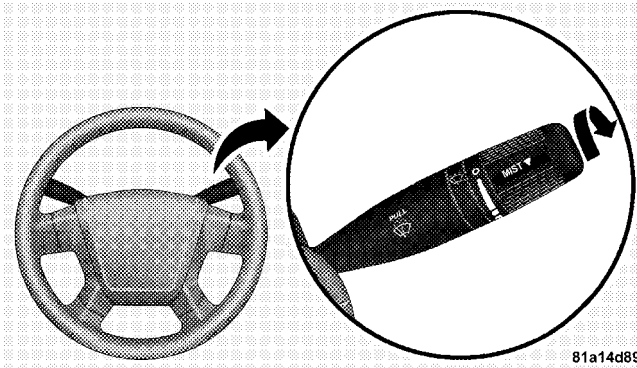

81a14d89

Windshield Wiper/Washer Lever

Rotate the end of the lever to the first detent past the intermittent settings for Low-speed wiper operation, or to the second detent past the intermittent settings for High-speed wiper operation.

NOTE: The wipers will automatically return to the PARK position if you turn off the ignition switch while they are operating. The wipers will resume operation when you turn the ignition switch to the ON position again.

CAUTION!

- Turn the windshield wipers off when driving through an automatic car wash. Damage to the windshield wipers may result if the wiper control is left in any position other than OFF.
- Always remove any buildup of snow that prevents the windshield wiper blades from returning to the OFF position. If the windshield wiper control is turned OFF and the blades cannot return to the OFF position, damage to the wiper motor may occur.

INTERMITTENT WIPER SYSTEM

Use the intermittent wiper system when weather conditions make a single wiping cycle with a variable pause between cycles desirable. Rotate the end of the Windshield Wiper/Washer Control Lever to the first detent, and then turn the end of the lever to select the desired delay interval. There are five delay settings, which allow you to regulate the wipe interval from a minimum of one cycle every second to a maximum of approximately 18 seconds between cycles.

For vehicles equipped with the Speed Sensitive Intermittent Wiper System, the wiper delay times depend on vehicle speed. If the vehicle is moving less than 10 mph (16 km/h), delay times will double.

WARNING!

Sudden loss of visibility through the windshield could lead to an accident. You might not see other vehicles or other obstacles. To avoid sudden icing of the windshield during freezing weather, warm the windshield with defroster before and during windshield washer use.

MIST FEATURE

Push down on the wiper control lever to activate a single wipe to clear the windshield of road mist or spray from a passing vehicle. As long as the lever is held down, the wipers will continue to operate.

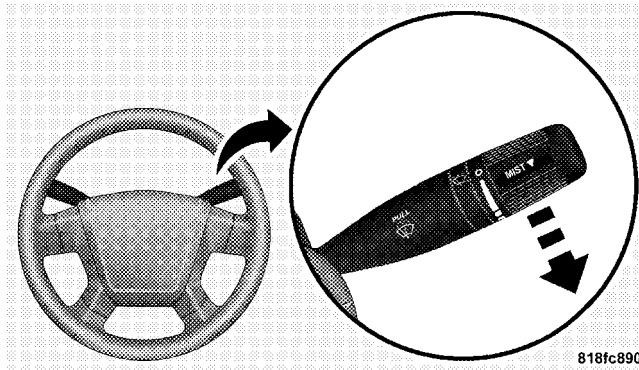

818fc890

Mist Control

HEADLIGHTS WITH WIPERS FEATURE (Available with Auto Headlights Only)

When this feature is active, the headlights will turn ON approximately 10 seconds after the wipers are turned on if the Multifunction Control Lever (on the left side of the steering column) is placed in the A AUTO position. In addition, the headlights will turn OFF when the wipers are turned off if they were turned on by this feature.

The Headlights with Wipers feature can be turned on or off through the Electronic Vehicle Information Center (EVIC) — if equipped. For details, refer to "Headlights with Wipers," under "Personal Settings (Customer Programmable Features)" under "Electronic Vehicle Information Center" in Section 4 of this manual.

WINDSHIELD WASHERS

To use the washer, pull the Windshield Wiper/Washer Control lever toward you and hold it for as long as washer spray is desired.

If you activate the washer while the wiper control is in the delay range, the wipers will operate in low speed for two wipe cycles after releasing the lever and then resume the intermittent interval previously selected.

If you activate the washer while the wiper control is in the OFF position, the wipers will operate for two wipe cycles and then turn OFF.

ADDING WASHER FLUID

The fluid reservoir for the windshield washers is located in the engine compartment. Be sure to check the fluid level in the reservoir at regular intervals. Fill the reservoir with windshield washer solvent (not radiator antifreeze) and operate the system for a few seconds to flush out the residual water. Refer to the appropriate engine diagram in Section 7 “Maintaining Your Vehicle” for the location of the reservoir.

WARNING!

Commercially available windshield washer solvents are flammable. They could ignite and burn you. Care must be exercised when filling or working around the washer solution.

TILT/TELESCOPING STEERING COLUMN

This feature allows you to tilt the steering column upward or downward. It also allows you to lengthen or shorten the steering column. The tilt/telescoping control handle is located below the steering wheel at the end of the steering column.

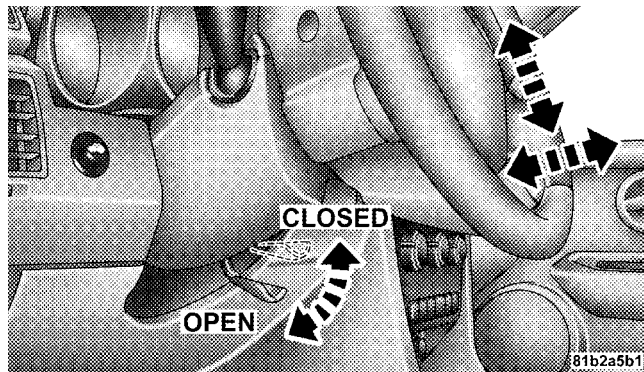

Tilt/Telescoping Steering Wheel

To unlock the steering column, pull the control handle outward. To tilt the steering column, move the steering wheel upward or downward as desired. To lengthen or shorten the steering column, pull the steering wheel outward or push it inward as desired. To lock the steering column in position, push the control handle inward until fully engaged.

WARNING!

Do not adjust the steering wheel while driving. The telescoping adjustment must be locked while driving. Adjusting the steering wheel while driving or driving without the telescoping adjustment locked could cause the driver to lose control of the vehicle.

ELECTRONIC SPEED CONTROL — IF EQUIPPED

When engaged, this device takes over the accelerator operation at speeds greater than 25 mph (40 km/h).

The Speed Control Lever is located on the right side of the steering wheel.

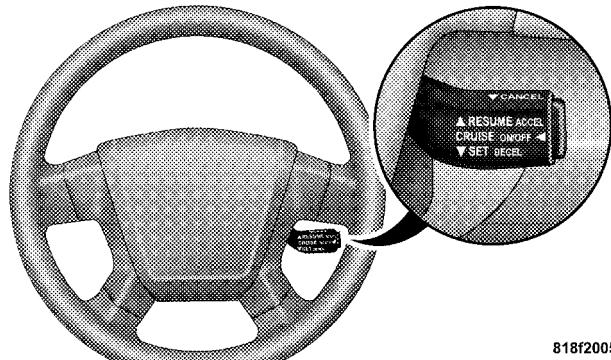

818f2005

Speed Control Location**To Activate:**

Push in and release the ON/OFF button located in the end of the Electronic Speed Control Lever. The Speed Control indicator in the instrument cluster will illuminate. To turn the system OFF, push in and release the ON/OFF button a second time. The Speed Control indicator will turn off. The system should be turned OFF when not in use.

NOTE: The Electronic Speed Control System will automatically turn itself off when the ignition key is turned to the LOCK position.

WARNING!

Leaving the Electronic Speed Control system on when not in use is dangerous. You could accidentally set the system or cause it to go faster than you want. You could lose control and have an accident. Always leave the system OFF when you are not using it.

To Set Desired Speed:

When the vehicle has reached the desired speed, push down on the lever and release SET DECEL. The vehicle will operate at the selected speed.

NOTE:

- The vehicle must be traveling at least 25 mph (40 km/h) for the speed control to set.

- The vehicle should be traveling at a steady speed and on level ground before pushing down the SET DECEL lever.

To Deactivate:

A soft tap on the brake pedal, pulling the speed control lever toward you CANCEL, or normal brake pressure while slowing the vehicle will deactivate speed control without erasing the set speed memory. Pushing in the ON/OFF button (in the end of the lever) or turning off the ignition switch erases the set speed memory.

To Resume Speed:

To resume a previously set speed, push upward on the RESUME ACCEL lever and release. Resume can be used at any speed above 20 mph (32 km/h).

To Vary Speed Setting:

When the speed control is ON, speed can be increased by pushing up and holding RESUME ACCEL. Release the lever when the desired speed is reached, and the new speed will be set.

Pushing up and quickly releasing the RESUME ACCEL lever will result in a 1 mph (2 km/h) speed increase. Each time the lever is pushed upwards and quickly released.

To decrease speed while speed control is ON, push down and hold SET DECEL. Release the lever when the desired speed is reached, and the new speed will be set.

Pushing down the SET DECEL button once will result in a 1 mph (2 km/h) speed decrease. Each time the button is pushed, speed decreases.

WARNING!

Speed Control can be dangerous where the system can't maintain a constant speed. Your vehicle could go too fast for the conditions, and you could lose control. An accident could be the result. Don't use Speed Control in heavy traffic or on roads that are winding, icy, snow-covered, or slippery.

To Accelerate For Passing:

Depress the accelerator as you would normally. When the pedal is released, the vehicle will return to the set speed.

Using Speed Control on Hills

NOTE: The speed control system maintains speed up and down hills. A slight speed change on moderate hills is normal.

On steep hills, a greater speed loss or gain may occur so it may be preferable to drive without speed control.

GARAGE DOOR OPENER — IF EQUIPPED

HomeLink® replaces up to three remote controls (hand-held transmitters) that operate devices such as garage door openers, motorized gates, lighting, or home security systems. The HomeLink® unit operates off your vehicle's battery.

The HomeLink® buttons that are located in the headliner or sun visor designate the three different HomeLink® channels.

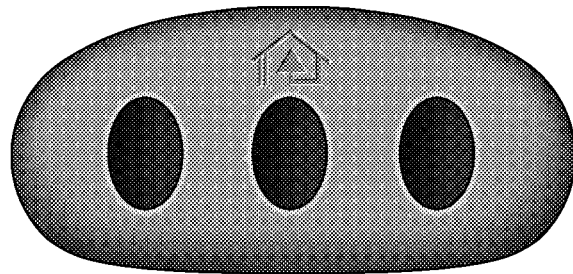

81cb44fe

HomeLink® Buttons

NOTE: HomeLink® is disabled when the Vehicle Security Alarm is active.

WARNING!

Your motorized door or gate will open and close while you are training the Universal Transceiver. Do not train the transceiver if people or pets are in the path of the door or gate. Only use this transceiver with a garage door opener that has a “stop and reverse” feature as required by Federal safety standards. This includes most garage door opener models manufactured after 1982. Do not use a garage door opener without these safety features. Call toll-free 1-800-355-3515 or, on the Internet at www.HomeLink.com for safety information or assistance.

WARNING!

Vehicle exhaust contains carbon monoxide, a dangerous gas. Do not run your vehicle in the garage while training the transceiver. Exhaust gas can cause serious injury or death.

PROGRAMMING HOMELINK®**Before You Begin**

If you have not trained any of the HomeLink® buttons, erase all channels before you begin training.

To do this, press and hold the two outside buttons for 20 seconds until the red indicator flashes.

It is recommended that a new battery be placed in the hand-held transmitter of the device being programmed to HomeLink® for more efficient training and accurate transmission of the radio-frequency signal.

Your vehicle should be parked outside of the garage when programming.

Begin Programming

1. Turn the ignition switch to the ON/RUN position.
2. Hold the battery side of the hand-held transmitter away from the HomeLink® button you wish to program.

Place the hand-held transmitter 1 to 3 in (3 to 8 cm) away from the HomeLink® button you wish to program while keeping the indicator light in view.

3. Simultaneously press and hold both the chosen HomeLink® button and the hand-held transmitter button until the HomeLink® indicator changes from a slow to a rapidly blinking light, then release both the HomeLink® and hand-held transmitter buttons.

Watch for the HomeLink® indicator to change flash rates. When it changes, it is programmed. It may take up to 30 seconds, or longer in rare cases. The garage door may open and close while you train.

NOTE: Some gate operators and garage door openers may require you to replace Step 3 with procedures noted in the “Gate Operator/Canadian Programming” section.

NOTE: After training a HomeLink® channel, if the garage door does not operate with HomeLink® and the garage door opener was manufactured after 1995, the garage door opener may have a rolling code. If so, proceed to Step 5 “Programming A Rolling Code System.”

4. Press and hold the just-trained HomeLink® button and observe the indicator light.

If the indicator light stays on constantly, programming is complete and the garage door (or device) should activate when the HomeLink® button is pressed.

If the indicator light blinks rapidly for two seconds, and then turns to a constant light, proceed to Step 5 “Programming A Rolling Code System.”

5. Programming A Rolling Code System

At the garage door opener motor (in the garage), locate the “Learn” or “Training” button.

This can usually be found where the hanging antenna wire is attached to the garage door opener motor (it is NOT the button normally used to open and close the door).

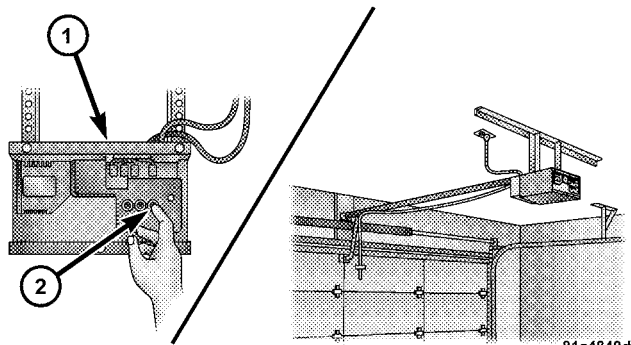

GARAGE DOOR OPENER TRAIN BUTTON

1 — Door Opener

2 — Training Button

6. Firmly press and release the “Learn” or “Training” button. The name and color of the button may vary by manufacturer.

NOTE: There are 30 seconds in which to initiate the next step after the “Learn” button has been pressed.

7. Return to the vehicle and press the programmed HomeLink® button twice (holding the button for two seconds each time). If the device is plugged in and activates, programming is complete.

If the device does not activate, press the button a third time (for two seconds) to complete the training.

If you have any problems, or require assistance, please call toll-free 1-800-355-3515 or, on the Internet at www.HomeLink.com for information or assistance.

To program the remaining two HomeLink® buttons, repeat each step for each remaining button. **DO NOT** erase the channels.

Using HomeLink®

To operate, simply press and release the programmed HomeLink® button. Activation will now occur for the trained device (i.e., garage door opener, gate operator, security system, entry door lock, home/office lighting, etc. The hand-held transmitter of the device may also be used at any time.

Reprogramming a Single Homelink® Button

To reprogram a channel that has been previously trained, follow these steps:

1. Turn the ignition switch to the ON/RUN position.
2. Press and hold the desired HomeLink® button until the indicator light begins to flash after 20 seconds. **Do not release the button.**
3. **Without releasing the button**, proceed with Programming Homelink® Step 2 and follow all remaining steps.

GATE OPERATOR/CANADIAN PROGRAMMING

Canadian radio frequency laws require transmitter signals to time-out (or quit) after several seconds of transmission – which may not be long enough for HomeLink® to pick up the signal during programming. Similar to this Canadian law, some U.S. gate operators are designed to time-out in the same manner.

It may be helpful to unplug the device during the cycling process to prevent possible overheating of the garage door or gate motor.

If you are having difficulties programming a garage door opener or a gate operator, replace “Programming HomeLink®” Step 3, with the following:

3. Continue to press and hold the HomeLink® button while you press and release - every two seconds (“cycle”) your hand-held transmitter until HomeLink®

has successfully accepted the frequency signal. The indicator light will flash slowly and then rapidly when fully trained.

If you unplugged the device for training, plug it back in at this time.

Then proceed with Step 4 under “Programming HomeLink®,” earlier in this section.

SECURITY

It is advised to erase all channels before you sell or turn in your vehicle.

To do this, press and hold the two outside buttons for 20 seconds until the red indicator flashes. Note that all channels will be erased. Individual channels cannot be erased.

The HomeLink® Universal Transceiver is disabled when the Vehicle Security Alarm is active.

TROUBLESHOOTING TIPS

If you are having trouble programming HomeLink®, here are some of the most common solutions:

- Replace the battery in the original transmitter.
- Press the “Learn” button on the Garage Door Opener to complete the training for a Rolling Code.
- Did you unplug the device for training, and remember to plug it back in?

If you have any problems, or require assistance, please call toll-free 1-800-355-3515 or, on the Internet at www.HomeLink.com for information or assistance.

GENERAL INFORMATION

This device complies with FCC rules Part 15 and Industry Canada RSS-210. Operation is subject to the following two conditions:

1. This device may not cause harmful interference.
2. This device must accept any interference that may be received including interference that may cause undesired operation.

NOTE: The transmitter has been tested and it complies with FCC and IC rules. Changes or modifications not expressly approved by the party responsible for compliance could void the user’s authority to operate the device.

The term IC before the certification/registration number only signifies that Industry Canada technical specifications were met.

POWER SUNROOF — IF EQUIPPED

The sunroof controls are mounted between the sun visors in the Dome/Reading Lamp.

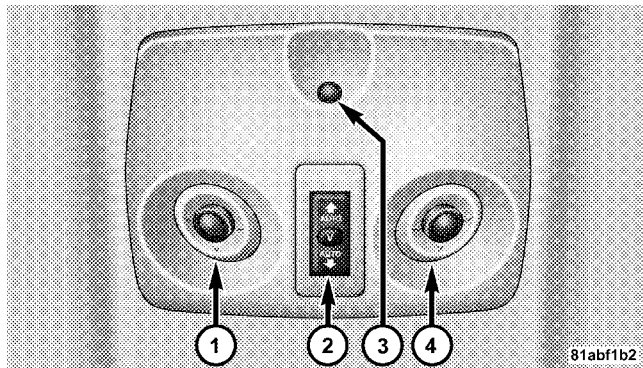

Power Sunroof Switch

- | | |
|--------------------------|------------------------------|
| 1 - Left Interior Light | 3 - ATC Sensor - If Equipped |
| 2 - Power Sunroof Switch | 4 - Right Interior Light |

WARNING!

- **Never leave children in a vehicle, with the keys in the ignition switch. Occupants, particularly unattended children, can become entrapped by the power sunroof while operating the power sunroof switch. Such entrapment may result in serious injury or death.**
- **In an accident, there is greater risk of being thrown from a vehicle with an open sunroof. You could also be seriously injured or killed. Always fasten your seat belt properly and make sure all passengers are properly secured too.**
- **Do not allow small children to operate the sunroof. Never allow fingers or other body parts, or any object to project through the sunroof opening. Injury may result.**

SUNROOF OPERATION

Opening Sunroof Manually

Press the switch rearward and hold, and the sunroof will open automatically from any position. The sunroof will open fully, then stop automatically. During this operation, any release of the sunroof switch will stop the sunroof.

Opening Sunroof - Express

Press the switch rearward and release, and the sunroof will open automatically from any position. The sunroof will open fully, then stop automatically. This is called Express Open. During Express Open operation, any movement of the sunroof switch will stop the sunroof.

Closing Sunroof Manually

To close the sunroof from an open or vent position, press and **hold** the switch forward. The sunroof will close fully and stop automatically. Release the switch to stop sunroof travel at any point.

Venting Sunroof - Express

Press and release the "V" button, and the sunroof will open to the vent position. This is called Express Vent.

Closing Sunroof - Express

Press the switch forward and release, and the sunroof will close automatically from any position. The sunroof will close fully, then stop automatically. This is called Express Close. During Express Close operation, any movement of the sunroof switch will stop the sunroof.

AUTO SUNROOF EXPRESS WITH ANTI-PINCH PROTECTION — IF EQUIPPED

During express closing, anytime an obstacle that restricts glass movement is detected, the motor will stop and reverse travel to avoid pinching the object.

SUNSHADE OPERATION

The sunshade can be opened manually. However, the sunshade will open automatically as the sunroof opens.

NOTE: The sunshade cannot be closed if the sunroof is open.

WIND BUFFETING

Wind buffeting can be described as the perception of pressure on the ears or a helicopter type sound in the ears. Your vehicle may exhibit wind buffeting with the windows down, or the sunroof (if so equipped) in certain open or partially open positions. This is a normal occurrence and can be minimized. If the buffeting occurs with the rear windows open, then open the front and rear windows together to minimize the buffeting. If the buffeting occurs with the sunroof open, adjust the sunroof opening to minimize the buffeting.

SUNROOF MAINTENANCE

Use only a non-abrasive cleaner and a soft cloth to clean the glass panel.

IGNITION OFF OPERATION

For vehicles not equipped with the Electronic Vehicle Information Center (EVIC), the power sunroof switch will remain active for 45 seconds after the ignition switch is turned off. Opening either front door will cancel this feature.

For vehicles equipped with the EVIC, the power sunroof switch will remain active for up to 10 minutes after the ignition switch is turned off. Opening either front door will cancel this feature. The time is programmable. For details, refer to “Key-Off Power Delay,” under “Personal Settings (Customer Programmable Features)” under “Electronic Vehicle Information Center (EVIC)” in Section 4 of this manual.

ELECTRICAL POWER OUTLETS

There are two 12-volt electrical outlets on this vehicle. Both of the outlets are protected by a fuse.

The instrument panel power outlet, located below the climate control knobs, has power available only when the ignition is on. This outlet will also operate a conventional cigar lighter unit.

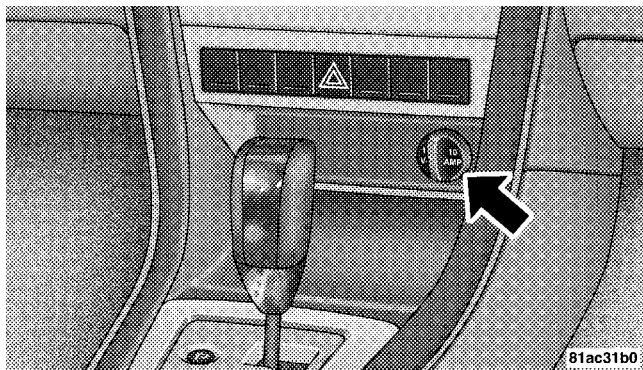

Instrument Panel Power Outlet

NOTE: If desired, the instrument panel power outlet can be converted by your authorized dealer to provide power with the ignition switch while in the LOCK position.

The center console power outlet is powered directly from the battery (power available at all times). Items plugged into this outlet may discharge the battery and/or prevent engine starting.

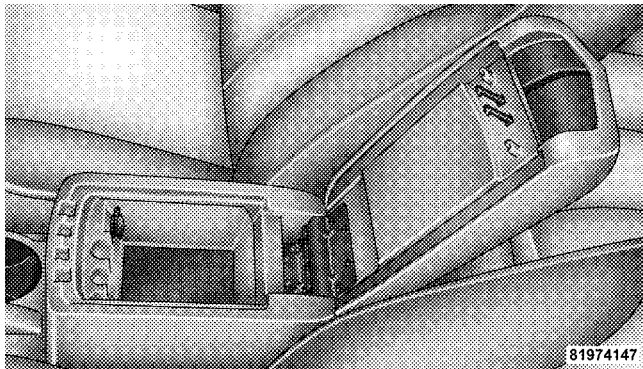

Console Interior

Electrical Outlet Use With Engine Off

CAUTION!

- Many accessories that can be plugged in draw power from the vehicle's battery, even when not in use (i.e. cellular phones, etc.). Eventually, if plugged in long enough, the vehicle's battery will discharge sufficiently to degrade battery life and/or prevent engine starting.
- Accessories that draw higher power (i.e. coolers, vacuum cleaners, lights, etc.) will degrade the battery even more quickly. Only use these intermittently and with greater caution.
- After the use of high power draw accessories, or long periods of the vehicle not being started (with accessories still plugged in), the vehicle must be driven a sufficient length of time to allow the generator to recharge the vehicle's battery.

CIGAR LIGHTER AND ASH RECEIVER — IF EQUIPPED

CUPHOLDER ASH RECEIVER — IF EQUIPPED

An optional ash receiver is available from your authorized dealer and will fit in the center console front cupholder.

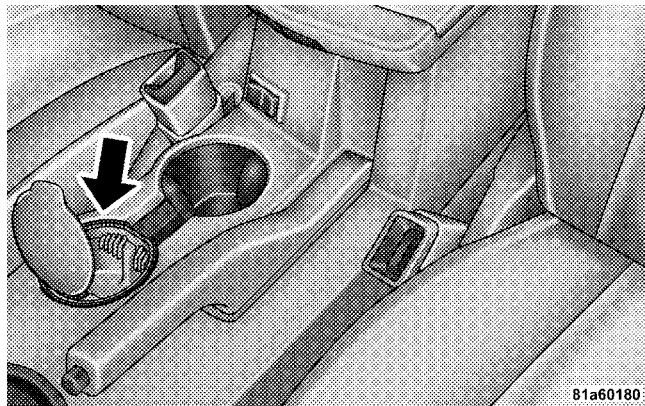

CAUTION!

For vehicles equipped with the heated and cooled cupholder, locate the cup holder ash receiver in the forward cupholder.

3

The optional ash receiver also comes with a cigar lighter. You may use the power outlet, located in the instrument panel below the climate control knobs, or in the bottom of the console compartment, for this cigar lighter.

CONSOLE FEATURES

The center console armrest slides forward from design position to provide added user comfort. Two cupholders can accommodate large sized fast food beverage containers, and 20 oz (500 ml) bottles. A one-piece cup holder insert for both cavities can easily be removed for cleaning.

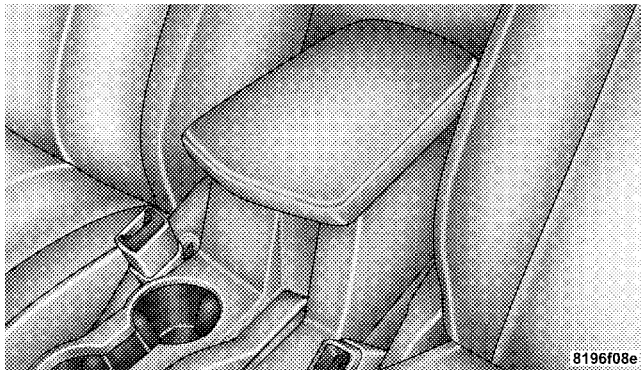

DUAL STORAGE BINS

Lifting a latch at the front of the hinged armrest provides access to these storage areas.

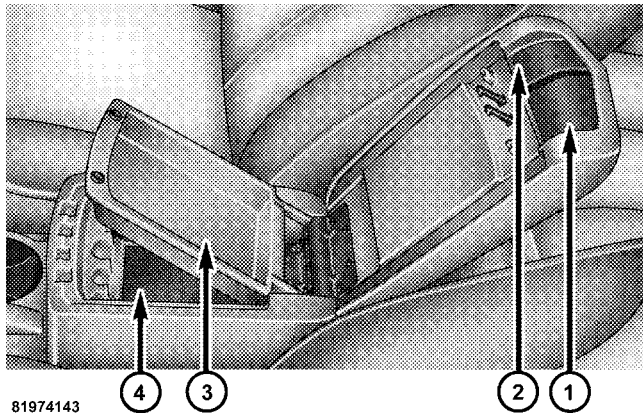

Console Compartment Features

- 1 — Release Top Compartment 3 — Top Compartment
2 — Release Bottom Compartment 4 — Bottom Compartment

1. The left latch opens to the top storage area.
2. The lower bin can be accessed directly, without first exposing the upper bin, by operating the right latch with the armrest down.
3. The first storage bin can be used to hold smaller items.
4. The lower storage bin includes a molded-in coin holder, room for CDs, DVDs, and a power outlet that allows a cell phone to recharge while concealed.

NOTE: A notch in the side of the console base under the armrest will also allow use of cell phone while still plugged into the power outlet and with the armrest latched down.

NOTE: The power outlet located inside the console can also energize the cigar lighter in the available Smoker's Package.

VIDEO CONSOLE — IF EQUIPPED

The optional VES™(Video Entertainment System) includes the following components:

- The screen for a rear seat DVD player is stored under the armrest.
- Remote Control

- Audio/Video RCA Jacks

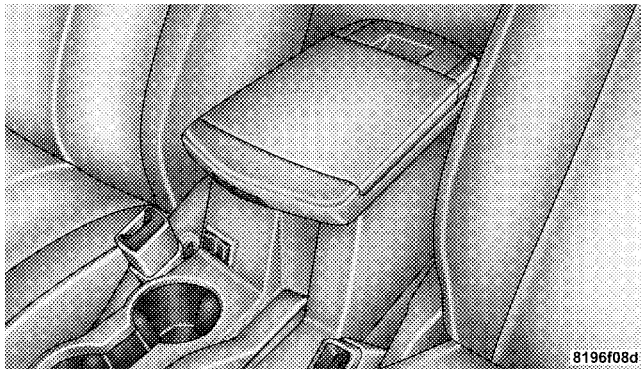

Video Console

See Section Four, “Video Entertainment System-If Equipped,” of this manual, for further information.

CUP HOLDERS

Heated or Cooled Cup Holder — If Equipped

With this feature the rear cavity of the cup holder can keep cool beverages cool, and hot beverages hot. The rear cup holder heats to 140°F (60°C) or cools to 35°F (1.6°C).

The switch is located on the front of the center console and has three positions: HEAT, OFF, COOL.

When the unit is on and the LED located between the cup holders is Red, the cup holder is being heated. When the LED is Blue, the cup holder is being cooled.

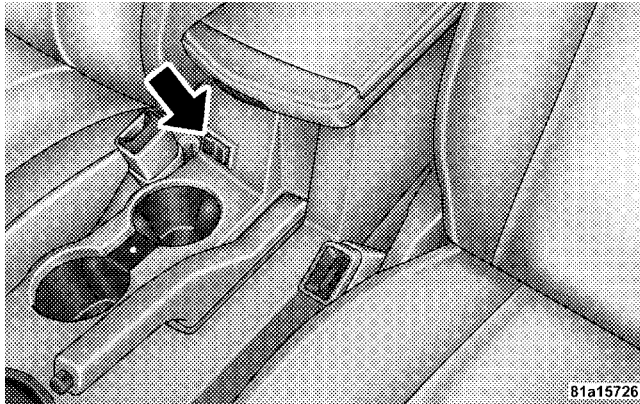

Heated or Cooled Cupholder

CAUTION!

Make sure the beverage container can withstand the temperatures shown above, when using the Cooled or Heated Cup Holder.

Rear Bottle Holders

There are built-in bottle holders located in both rear door trim panels.

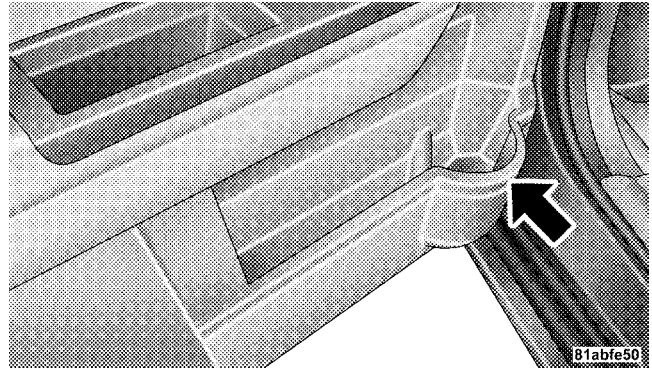

Rear Bottle Holder

WARNING!

If containers of hot liquid are placed in the bottle holder, they can spill when the door is closed, burning the occupants. Be careful when closing the doors to avoid injury.

STORAGE**CARGO AREA**

The 60/40 split-folding rear seat provides cargo-carrying versatility. The seatbacks fold down easily by pulling nylon tabs between the seatbacks and the bolsters. When the seats are folded down, they provide a continuous, nearly flat extension of the load floor.

When the seatback is folded to the upright position, make sure it is latched by strongly pulling on the top of the seatback above the seat strap.

WARNING!

- Be certain that the seatback is securely locked into position. If the seatback is not securely locked into position, the seat will not provide the proper stability for child seats and/or passengers. An improperly latched seat could cause serious injury.
- The cargo area in the rear of the vehicle (with the rear seatbacks in the locked-up or folded down position) should not be used as a play area by children when the vehicle is in motion. They could be seriously injured in an accident. Children should be seated and using the proper restraint system.
- To help protect against personal injury, passengers should not be seated in the rear cargo area. The rear cargo space is intended for load carrying purposes only, not for passengers, who should sit in seats and use seat belts.

WARNING!

- **The weight and position of cargo and passengers can change the vehicle center of gravity and vehicle handling. To avoid loss of control resulting in personal injury, follow these guidelines for loading your vehicle:**

- Always place cargo evenly on the cargo floor. Put heavier objects as low and as far forward as possible.
- Place as much cargo as possible in front of the rear axle. Too much weight or improperly placed weight over or behind the rear axle can cause the rear of the vehicle to sway.
- Do not pile luggage or cargo higher than the top of the seatback. This could impair visibility or become a dangerous projectile in a sudden stop or collision.

BEVERAGE COOLER STORAGE BIN — IF EQUIPPED

The Beverage Cooler Storage Bin is located in the top of the instrument panel on the passenger side. A recessed latch at the front releases the bin door and swings up for easy access.

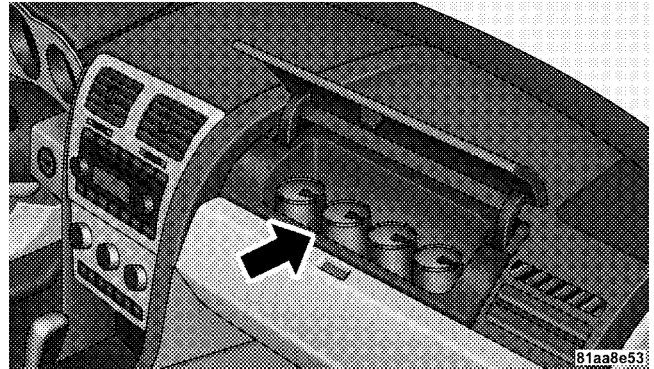
**Beverage Cooler**

The cooling bin will hold up to four, standing, 12 ounce, beverage cans. The cooler bin is also equipped with a soft molded liner that is removable for easy cleaning.

Inside the bin is a vent which, when opened, allows either air conditioned or fresh air to flow into the storage bin. Depending on ambient temperature and A/C setting, the bin can keep beverages cool.

For the Cooler Storage Bin to operate properly, door must remain closed while vehicle is in operation.

Shut off the beverage cooler when not in use, by closing the vent inside. This will prevent cool air from entering the passenger compartment when in heat mode.

NOTE: The use of the Beverage Cooler Storage Bin is for **non-perishable beverages only.**

The Glove Compartment is located beneath the beverage bin. The glove compartment door swings downward for easy access.

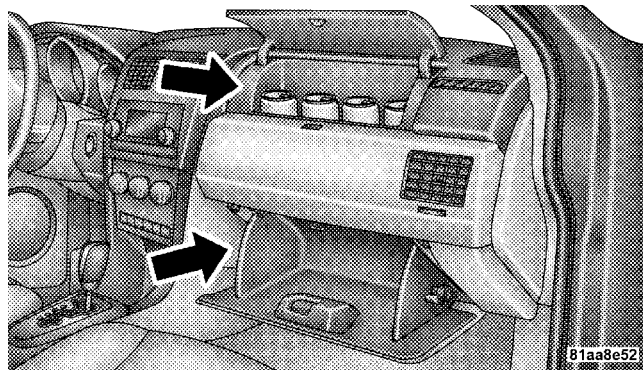

Glove Compartment Access

UNDERSTANDING YOUR INSTRUMENT PANEL

CONTENTS

■ Instrument Panel Features	167	□ Compass Display	186
■ Instrument Cluster — Base	168	□ EVIC Personal Settings (Customer Programmable Features)	188
■ Instrument Cluster — Premium	169	■ Radio General Information	191
■ Instrument Cluster Descriptions	170	□ Radio Broadcast Signals	191
■ Electronic Vehicle Information Center (EVIC) – If Equipped	181	□ Two Types Of Signals	191
□ EVIC Displays	183	■ Sales Code RES — AM/FM Stereo Radio With CD Player (MP3 AUX Jack)	192
□ Oil Change Required	184	□ Operating Instructions - Radio Mode	192
□ Trip Functions	184		

- Operation Instructions - CD Mode For CD And MP3 Audio Play 198
- Notes On Playing MP3 Files 200
- List Button (CD Mode For MP3 Play) 203
- Info Button (CD Mode For MP3 Play) 203
- Sales Code REQ — AM/FM Stereo Radio And 6-Disc CD/DVD Changer (MP3/WMA AUX Jack) 205
 - Operating Instructions - Radio Mode 205
 - Operation Instructions - (Disc Mode For CD And MP3/WMA Audio Play, DVD-Video) 213
 - Notes On Playing MP3/WMA Files 215
 - List Button (Disc Mode For MP3/WMA Play) 218
 - Info Button (Disc Mode For MP3/WMA Play) 218
- Sales Code REN — Multimedia System — If Equipped 220
 - Operating Instructions — Satellite Radio (If Equipped) 221
 - Operating Instructions — Voice Recognition System (VR) (If Equipped) 221
 - Operating Instructions — Hands-Free Communication (UConnect®) (If Equipped) 221
 - Clock Setting Procedure 221
- Sales Code RER — Multimedia System — If Equipped 223
 - Operating Instructions — Satellite Radio 224
 - Operating Instructions — Hands-Free Communication (UConnect®) (If Equipped) 224
 - Clock Setting Procedure 225

- Universal Consumer Interface (UCI) —
 - If Equipped227
 - Connecting The iPod® Device227
 - Controlling The iPod® Using Radio Buttons . . .228
 - Play Mode228
 - List Or Browse Mode230
- Satellite Radio — If Equipped
(REN/REQ/RER/RES/REU Radios Only)231
 - System Activation231
 - Electronic Serial Number/Sirius Identification
Number (ESN/SID)232
 - Selecting Satellite Mode233
 - Satellite Antenna233
 - Reception Quality233

- Operating Instructions - Satellite Mode233
- Operating Instructions - Hands-Free Phone
(If Equipped)236
- Operating Instructions - Video Entertainment
System (VES®) (If Equipped)236
- Remote Sound System Controls — If Equipped . .236
 - Operation With RES / REQ AM/FM Stereo
Radio With CD Player237
 - Operation With RER Multi-Media System238
- Video Entertainment System (VES)® —
If Equipped239
- Radio Operation And Cellular Phones241
- CD/DVD Maintenance241
- Climate Controls242

<input type="checkbox"/> Manual Air Conditioning And Heating System . . .	242	<input checked="" type="checkbox"/> Rear Window Features	256
<input type="checkbox"/> Automatic Temperature Control (ATC) — If Equipped	246	<input type="checkbox"/> Electric Rear Window Defroster — If Equipped	256
<input type="checkbox"/> Operating Tips	252		

INSTRUMENT PANEL FEATURES

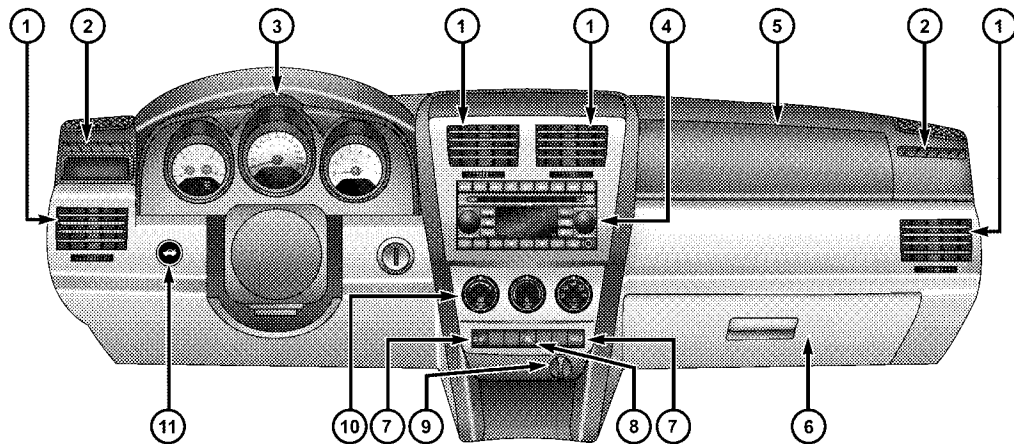

1. Air Outlets
 2. Side Window Demist Outlets
 3. Instrument Cluster

4. Radio
 5. Passenger Airbag
 6. Glove Box

7. Heated Seat Switch*
 8. Hazard Warning Flasher
 9. Power Supply

10. Climate Control
 11. Trunk Release

* If Equipped

81aa928b

Instrument Panel Features

INSTRUMENT CLUSTER — BASE

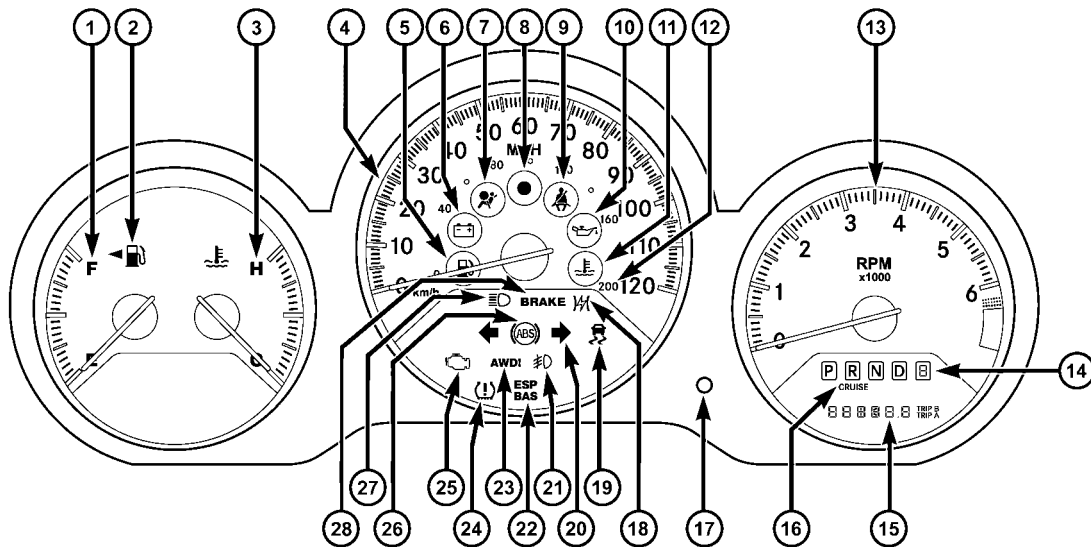

81aa929b

INSTRUMENT CLUSTER — PREMIUM

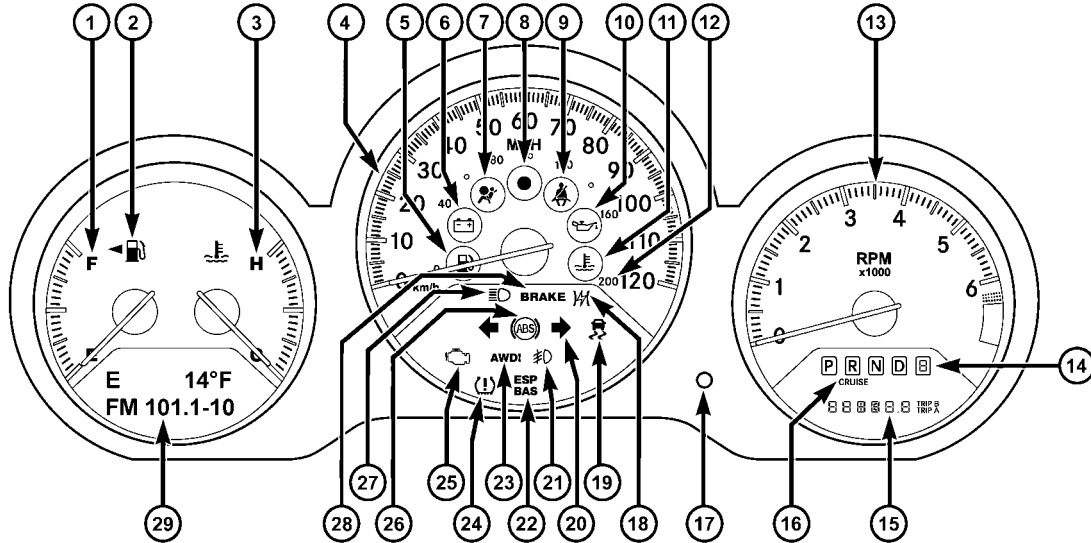

81aa92c3

INSTRUMENT CLUSTER DESCRIPTIONS

1. Fuel Gauge



When the ignition switch is in the ON position, the pointer will show the level of fuel remaining in the fuel tank.

2. Fuel Door Reminder



This is a reminder that the Fuel Filler Door is located on the left side of the vehicle.

3. Temperature Gauge



The temperature gauge shows engine coolant temperature. Any reading below the red area of the gauge shows that the engine cooling system is operating properly. The gauge pointer may show a higher than normal temperature when driving in hot weather, up mountain grades, in heavy stop and go traffic, or when towing a trailer.

If the pointer rises to the **H** (red) mark, the instrument cluster will sound a chime. Pull over and stop the vehicle. Idle the vehicle with the air conditioner turned off until the pointer drops back into the normal range. If the pointer remains on the **H** (red) mark, turn the engine off immediately and call for service.

There are steps that you can take to slow down an impending overheat condition. If your air conditioning is on, turn it off. The air conditioning system adds heat to the engine cooling system and turning off the A/C removes this heat. You can also turn the Temperature control to maximum heat, the Mode control to Floor and the Fan control to High. This allows the heater core to act as a supplement to the radiator and aids in removing heat from the engine cooling system.

4. Speedometer

Indicates vehicle speed in miles per hour — MPH.

5. Low Fuel Light



When the fuel level drops to 2 gallons, the fuel symbol will light and a single chime will sound.

6. Charging System Light



This light shows the status of the electrical charging system. The light should come on briefly when the ignition is first turned on and remain on briefly as a bulb check. If the light stays on or comes on while driving, turn off some of the vehicle's electrical devices, such as the Fog Lights or Rear Defroster. If the Charging System Light remains on, it means that the vehicle is experiencing a problem with the charging system. Obtain SERVICE IMMEDIATELY. See your authorized dealer.

7. Airbag Light



The light comes on and remains on for 6 to 8 seconds as a bulb check when the ignition switch is first turned ON. If the light does not

come on during starting, stays on, or comes on while driving, have the system checked by an authorized dealer.

8. Theft Alarm Light — If Equipped

This light will flash rapidly for several seconds when the alarm system is arming. The light will begin to flash slowly indicating that the system is armed.

9. Seat Belt Reminder Light



When the ignition switch is first turned ON, this light will come on for about six seconds. A chime will sound if you have not pulled the shoulder belt out of the retractor. This is a reminder to “buckle up”. If you do not buckle up, the light will remain on.

10. Oil Pressure Light



Shows low engine oil pressure. The light will come on and remain on when the ignition switch is turned from the OFF to the ON position, and the light

will turn off after the engine is started. If the bulb does not come on during starting, have the system checked by an authorized dealer.

If the light comes on and remains on while driving, stop the vehicle and shut off the engine. **DO NOT OPERATE THE VEHICLE UNTIL THE CAUSE IS CORRECTED.**

The light does not show the quantity of oil in the engine. This can be determined using the procedure shown in Section 7.

11. Engine Temperature Warning Light



This light warns of an overheated engine condition. If the engine is critically hot, a warning chime will sound 10 times. After the chime turns off, the engine will still be critically hot until the light goes out.

12. Speedometer

Indicates vehicle speed in kilometers per hour — Km/h.

13. Tachometer

The white area of the scale shows the permissible engine revolutions-per-minute (rpm x 1000) for each gear range. Before reaching the red area, ease up on the accelerator to prevent engine damage.

14. Transmission Range Indicator

This display indicator shows the automatic transaxle gear selection.

15. Odometer/Trip Odometer

The odometer shows the total distance the vehicle has been driven. U.S. federal regulations require that upon transfer of vehicle ownership, the seller certify to the purchaser the correct mileage that the vehicle has been driven. Therefore, if the odometer reading is changed during repair or replacement, be sure to keep a record of the reading before and after the service so that the correct mileage can be determined.

The two trip odometers show individual trip mileage. To switch from odometer to trip odometers, press and release the Trip Odometer button. To reset a trip odometer, display the desired trip odometer to be reset then push and hold the button until the display resets (approximately 2 seconds). Refer to “Trip Odometer Button” for additional information.

Vehicle Warning Messages

When the appropriate conditions exist, “DOOR AJAR,” “TRUNK AJAR,” or “gASCAP” will display in the odometer.

NOTE: If the instrument cluster is equipped with the optional Electronic Vehicle Information Center (EVIC), then all warnings including “DOOR AJAR” and “TRUNK AJAR” will only display in the EVIC. (Refer to “Electronic Vehicle Information Center (EVIC)” in this section for specific messages).

gASCAP

If the vehicle diagnostic system detects a leak or change in the evaporative system, or the fuel filler cap is loose, improperly installed, or damaged, the words “gASCAP” will display in the odometer. If this occurs, tighten the fuel filler cap properly and press the odometer reset button to turn off the “gASCAP” message. (Refer to “Onboard Diagnostic System — OBDII” in Section 7 of this manual for more information). If the problem continues, the message will appear the next time the vehicle is started. See your authorized dealer service center as soon as possible.

Change Oil

Your vehicle is equipped with an engine oil change indicator system. The “Change Oil” message will flash in the instrument cluster odometer for approximately 12 seconds after a single chime has sounded to indicate the next scheduled oil change interval. The engine oil change

indicator system is duty cycle based, which means the engine oil change interval may fluctuate dependent upon your personal driving style.

Unless reset, this message will continue to display each time you turn the ignition switch to the “ON” position. To turn off the message temporarily, press and release the Trip Odometer button on the instrument cluster. To reset the oil change indicator system (after performing the scheduled maintenance) perform the following procedure:

1. Turn the ignition switch to the “ON” position (Do not start the engine).
2. Fully depress the accelerator pedal slowly three times within 10 seconds.
3. Turn the ignition switch to the LOCK position.

NOTE: If the indicator message illuminates when you start the vehicle, the oil change indicator system did not reset. If necessary repeat this procedure.

16. Cruise Indicator — If Equipped

CRUISE This indicator shows that the Speed Control System is ON.

17. Odometer/Trip Odometer Reset Knob

Single Trip Odometer

Press and release this button to change the display from odometer to trip odometer. The word “Trip” displays to show that the odometer is in Trip Mode. Press and release the button again to change the display back to the odometer.

To reset the trip odometer, first set the display to Trip Mode. Then push and hold the button (approximately 2 seconds) until the display resets to 0. The odometer must be in Trip Mode to reset the trip odometer.

Dual Trip Odometer — If Equipped

Press and release this button to change the display from odometer to “Trip A.” Press and release it a second time to change the display to “Trip B.” Press and release it a third time to change the display back to the odometer.

To reset the trip odometer, first display the trip mileage that you want to reset, “Trip A” or “Trip B.” Then push and hold the button (approximately 2 seconds) until the display resets to 0. The odometer must be in Trip Mode to reset the trip odometer.

18. Electronic Throttle Control Indicator Light



This red illuminated light informs you of a problem with the Electronic Throttle Control system. If a problem is detected, the light will come on while the engine is running. If the light remains lit with the engine running your vehicle will usually be drivable and not need towing, however see your dealer for service as soon as possible.

If the light is flashing when the engine is running you may experience power loss, an elevated/rough idle, and increased brake pedal effort, and your vehicle may require towing. Immediate service is required.

The light will come on when the ignition switch is first turned on and remain on briefly as a bulb check. This is normal. If the light does not come on during starting, have the system checked by an authorized dealer.

19. Electronic Stability Program (ESP) Indicator Light/Traction Control System (TCS) Indicator Light — If Equipped



If this indicator light flashes during acceleration, apply as little throttle as possible. While driving, ease up on the accelerator. Adapt your speed and driving to the prevailing road conditions, and do not switch off the ESP, or TCS — if equipped.

20. Turn Signal Indicators

 The arrows will flash in unison with the exterior turn signal, when using the turn signal lever.

21. Front Fog Light Indicator — If Equipped

 This light shows when the front fog lights are ON.

22. Electronic Stability Program (ESP) Indicator Light

**ESP
BAS** The yellow ESP/BAS malfunction indicator light will turn on when the ignition switch is turned to the “ON” position. The light should go out with the engine running. If the light remains on after several ignition cycles, and you have driven the vehicle several miles at speeds greater than 30 mph (48 km/h), and the ESP is synchronized (refer to Synchronizing ESP), see your authorized dealer as soon as possible to have the problem diagnosed and corrected.

23. All Wheel Drive (AWD)

This indicator lights when AWD is selected.

AWD!**24. Tire Pressure Monitor Light**

 Each tire, including the spare (if provided), should be checked monthly when cold and inflated to the inflation pressure recommended by the vehicle manufacturer on the vehicle placard or tire inflation pressure label. (If your vehicle has tires of a different size than the size indicated on the vehicle placard or tire inflation pressure label, you should determine the proper tire inflation pressure for those tires.)

As an added safety feature, your vehicle has been equipped with a Tire Pressure Monitoring System (TPMS) that illuminates a low tire pressure telltale when one or more of your tires is significantly under-inflated.

Accordingly, when the low tire pressure telltale illuminates, you should stop and check your tires as soon as possible, and inflate them to the proper pressure. Driving on a significantly under-inflated tire causes the tire to overheat and can lead to tire failure. Under-inflation also reduces fuel efficiency and tire tread life, and may affect the vehicle's handling and stopping ability.

NOTE: Please note that the TPMS is not a substitute for proper tire maintenance, and it is the driver's responsibility to maintain correct tire pressure, even if under-inflation has not reached the level to trigger illumination of the TPMS low tire pressure telltale.

Your vehicle has also been equipped with a TPMS malfunction indicator to indicate when the system is not operating properly. The TPMS malfunction indicator is combined with the low tire pressure telltale. When the system detects a malfunction, the telltale will flash for approximately one minute and then remain continuously

illuminated. This sequence will continue upon subsequent vehicle start-ups as long as the malfunction exists. When the malfunction indicator is illuminated, the system may not be able to detect or signal low tire pressure as intended. TPMS malfunctions may occur for a variety of reasons, including the installation of replacement or alternate tires or wheels on the vehicle that prevent the TPMS from functioning properly. Always check the TPMS malfunction telltale after replacing one or more tires or wheels on your vehicle to ensure that the replacement or alternate tires and wheels allow the TPMS to continue to function properly.

CAUTION!

The TPMS has been optimized for the original equipment tires and wheels. TPMS pressures and warning have been established for the tire size equipped on your vehicle. Undesirable system operation or sensor damage may result when using replacement equipment that is not of the same size, type, and/or style. Aftermarket wheels can cause sensor damage. Do not use aftermarket tire sealants or balance beads if your vehicle is equipped with a TPMS, as damage to the sensors may result.

(Refer to “Tire Inflation Pressures” under “Tires — General Information” and to “Tire Pressure Monitor System (TPMS)” in Section 5 of this manual for more information).

25. Malfunction Indicator Light

This light is part of an onboard diagnostic system called OBD that monitors emissions, engine, and automatic transaxle control systems. The light will illuminate when the key is in the ON/RUN position before engine start. If the bulb does not come on when turning the key from LOCK/OFF to ON/RUN, have the condition checked promptly.

Certain conditions such as a loose or missing gas cap, poor fuel quality, etc. may illuminate the light after engine start. The vehicle should be serviced if the light stays on through several of your typical driving cycles. In most situations the vehicle will drive normally and will not require towing.

If the Malfunction Indicator Light flashes when the engine is running, serious conditions may exist that

could lead to immediate loss of power or severe catalytic converter damage. The vehicle should be serviced as soon as possible if this occurs.

26. *Anti-Lock Warning Light (ABS)*



This light monitors the ABS. This light will come on when the ignition key is turned to the ON position and may stay on for as long as four seconds.

If the ABS light remains on or comes on during driving, it indicates that the Anti-Lock portion of the brake system is not functioning and that service is required, however, the conventional brake system will continue to operate normally provided that the BRAKE warning light is not on.

If the ABS light is on, the brake system should be serviced as soon as possible to restore the benefit of Anti-Lock Brakes.

The ABS warning light should be checked frequently to assure that it is operating properly. Turn the ignition key to the on position, but do not start the vehicle. The light should come on. If the light does not come on, have the system checked by an authorized dealer.

27. *High Beam Indicator*



This light shows that the headlights are on high beam. Push the turn signal lever away from the steering wheel to switch the headlights from high or low beam.

28. *Brake System Warning Light*

BRAKE This light monitors various brake functions, including brake fluid level and parking brake application. If the brake light turns on, it may indicate that the parking brake is applied, that the brake fluid level is low, or that there is a problem with the anti-lock brake system (if equipped).

The dual brake system provides a reserve braking capacity in the event of a failure to a portion of the hydraulic system. Failure of either half of the dual brake system is indicated by the Brake Warning Light which will turn on when the brake fluid level in the master cylinder has dropped below a specified level.

The light will remain on until the cause is corrected.

NOTE: The light may flash momentarily during sharp cornering maneuvers which change fluid level conditions. The vehicle should have service performed, and the brake fluid level checked.

If brake failure is indicated, immediate repair is necessary.

WARNING!

Driving a vehicle with the brake light on is dangerous. Part of the brake system may have failed. It will take longer to stop the vehicle. You could have an accident. Have the vehicle checked immediately.

Vehicles equipped with Anti-Lock brakes (ABS), are also equipped with Electronic Brake Force Distribution (EBD). In the event of an EBD failure, the Brake Warning Light will turn on along with the ABS Light. Immediate repair to the ABS system is required.

The operation of the Brake Warning Light can be checked by turning the ignition switch from the LOCK position to the ON position. The light should illuminate for approximately two seconds. The light should then turn off unless

the parking brake is applied or a brake fault is detected. If the light does not illuminate, have the light inspected by an authorized dealer.

The light also will turn on when the parking brake is applied with the ignition switch in the ON position.

NOTE: This light shows only that the parking brake is applied. It does not show the degree of brake application.

29. Electronic Vehicle Information Center (EVIC)

Display—Premium Cluster Only

This display shows the EVIC messages when the appropriate conditions exist. Refer to “Electronic Vehicle Information Center (EVIC)” in this section for more information.

ELECTRONIC VEHICLE INFORMATION CENTER (EVIC) – IF EQUIPPED

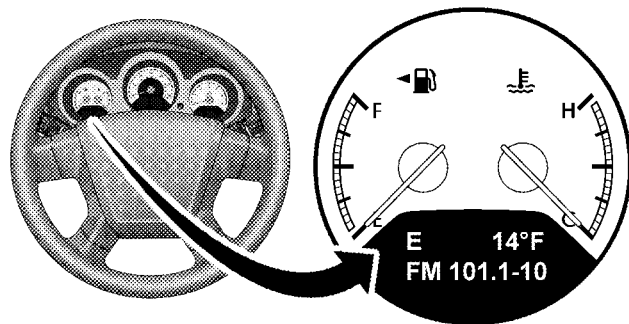

EVIC Display Location

819788c7

The Electronic Vehicle Information Center (EVIC) features a driver-interactive display. It is located in the lower left part of the cluster below the fuel and engine temperature gauges. The EVIC consists of the following:

- System status
- Vehicle information warning message displays
- Personal settings (customer programmable features)
- Compass heading display (N, S, E, W, NE, NW, SE, SW)
- Outside temperature display (°F or °C)
- Trip computer functions
- Audio mode displays – 12 preset Radio Stations or CD Title and Track number when playing
- Tire Pressure Monitor System (TPMS) displays (if equipped)

The system allows the driver to select information by pressing the following buttons on the instrument panel switch bank:



**MENU
Button**

Press and release the MENU button to advance the display to Trip Functions or Personal settings or to return to the default System status display.



**STEP
Button**

Press and release the STEP button to advance the display through the various Trip Functions or Personal settings.



**COM-
PASS
Button**

Press and release the COMPASS button to display the compass heading and the outside temperature.



Press and release the RESET button to accept a selection. The RESET button also resets various Trip Functions.

RESET Button

EVIC DISPLAYS

When the appropriate conditions exist, the Electronic Vehicle Information Center (EVIC) displays the following messages.

- Turn Signal On (with a continuous warning chime)
- Left Front Turn Signal Light Out (with a single chime)
- Left Rear Turn Signal Light Out (with a single chime)
- Right Front Turn Signal Light Out (with a single chime)
- Right Rear Turn Signal Light Out (with a single chime)
- RKE (Remote Keyless Entry) Battery Low (with a single chime)
- Personal Settings Not Available – Vehicle Not In PARK.
- Left/Right Door Ajar (one or more, with a single chime if speed is above 1 mph / 1 km h)
- Door(s) Ajar (with a single chime if vehicle is in motion)
- Trunk Ajar (with a single chime)
- Headlights On
- Key In Ignition
- Speed Too High (with a single chime)
- Oil Change Required (with a single chime)

OIL CHANGE REQUIRED

Your vehicle is equipped with an engine oil change indicator system. The Oil Change Required message will flash in the EVIC display for approximately 10 seconds after a single chime has sounded to indicate the next scheduled oil change interval. The engine oil change indicator system is duty cycle based, which means the engine oil change interval may fluctuate dependent upon your personal driving style.

Unless reset, this message will continue to display each time you turn the ignition switch to the ON/RUN position. To turn off the message temporarily, press and release the MENU button. To reset the oil change indicator system (after performing the scheduled maintenance) perform the following procedure:

1. Turn the ignition switch to the ON position (Do not start the engine).

2. Fully depress the accelerator pedal slowly three times within 10 seconds.
3. Turn the ignition switch to the LOCK position.

NOTE: If the indicator message illuminates when you start the vehicle, the oil change indicator system did not reset. If necessary repeat this procedure.

TRIP FUNCTIONS

Press and release the MENU button until one of the following Trip Functions displays in the EVIC:

- Average Fuel Economy
- Distance To Empty
- Elapsed Time
- Display Units of Measure in

Press and release the STEP button to advance the display through the Trip Functions.

To Reset The Display

Reset will only occur if a resettable function is currently displayed. Press and hold the RESET button once to clear the function currently displayed.

To reset all resettable functions, press and release the RESET button a second time within three seconds of resetting the currently displayed function (Reset ALL will display during this three second window).

The Trip Functions mode displays the following information:

- **Average Fuel Economy**

Shows the average fuel economy since the last reset. When the fuel economy is reset, the display will read, RESET or show dashes for two seconds. Then, the history information will be erased, and the averaging will continue from the last fuel average reading before the reset.

- **Distance To Empty (DTE)**

Shows the estimated distance that can be traveled with the fuel remaining in the tank. This estimated distance is determined by a weighted average of the instantaneous and average fuel economy, according to the current fuel tank level. DTE cannot be reset through the RESET button.

NOTE: Significant changes in driving style or vehicle loading will greatly affect the actual drivable distance of the vehicle, regardless of the DTE display value.

- When the DTE value is less than 30 mi (48 km) estimated driving distance, the DTE display will change to a text display of "LOW FUEL. This display will continue until the vehicle runs out of fuel. Adding a significant amount of fuel to the vehicle will turn off the LOW FUEL text and a new DTE value will display.

- **Elapsed Time**

Shows the total elapsed time of travel since the last reset. Elapsed time will increment when the ignition switch is in the ON or START position.

- **Display Units In:**

To make your selection, press and release the RESET button until U.S. or METRIC appears.

COMPASS DISPLAY



COM-
PASS
Button

The compass heading indicates the direction the vehicle is facing. Press and release the compass button to display one of eight compass heading and the outside temperature.

Automatic Compass Calibration

This compass is self-calibrating, which eliminates the need to calibrate the compass manually. When the vehicle is new, the compass may appear erratic and the

EVIC will flash the “CAL” indicator until the compass is calibrated. You may calibrate the compass by completing one or more 360 degree turns (in an area free from large metal or metallic objects) until the CAL indicator in the EVIC turns off. The compass will now function normally.

Manual Compass Calibration

If the compass appears erratic, inaccurate, or abnormal, you may wish to calibrate the compass manually. However, prior to calibrating the compass, make sure the proper Compass Variance value is selected (Refer to “Compass Variance” for additional information). Then continue to calibrate the compass as follows:

1. Start the engine. Leave the selector lever in PARK in order to enter the EVIC Programming Menus.
2. Press and release the MENU button until “Personal Settings” displays in the EVIC.
3. Press and release the STEP button until “Calibrate Compass Yes” displays in the EVIC.

4. Press and release the RESET button and the “CAL” indicator will quit flashing.

5. Drive the vehicle slowly, completing one or more circles (in an area free from large metal or metallic objects) until the “CAL” indicator turns off. The compass will now function normally.

Compass Variance

Compass Variance is the difference between magnetic North and Geographic North. In some areas of the country, the difference between magnetic and geographic North is great enough to cause the compass to give false readings. If this occurs, the compass variance must be set using the following procedure:

NOTE: Magnetic materials and cell phones should be kept away from the top of the Instrument Panel. This is where the compass sensor is located.

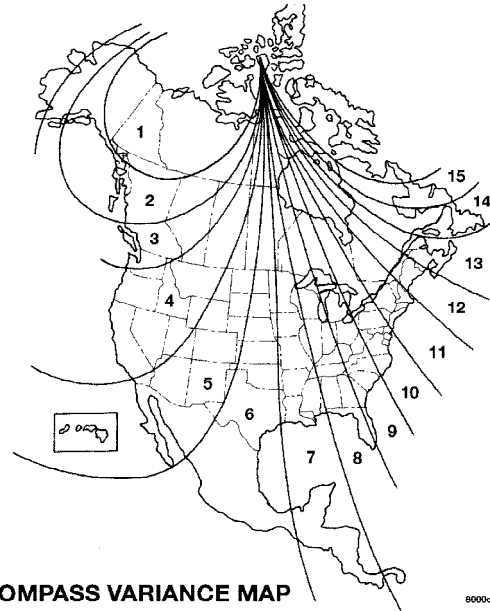

1. Turn the ignition switch to the ON position. Leave the selector lever in PARK.
2. Press and release the MENU button until “Personal Settings” displays in the EVIC.
3. Press and release the STEP button until “Compass Variance” and the current Variance Value displays in the EVIC.
4. Press and release the RESET button to increment the Variance Value by one, (one button press per update), until the proper variance zone is selected according to the map.
NOTE: The Variance Values will wrap around from 15 back to 1. The Default Variance is Zone 8.
5. Press and release the STEP button to exit. Press the STEP button if you wish to calibrate the compass manually (Refer to “Manual Compass Calibration” later in this section).

EVIC PERSONAL SETTINGS (CUSTOMER PROGRAMMABLE FEATURES)

Personal settings allows the driver to set and recall features when the automatic transaxle is in PARK.

Press and release the MENU button until “Personal Settings” displays in the EVIC.

Press and release the STEP button to display the following programmable features:

Language

When in this display you may select different languages for all display nomenclature, including the trip functions. Pressing the RESET button while in this display selects English, Espanol, or Francais depending on availability. As you continue, the displayed information will be shown in the selected language.

Auto Unlock on Exit

When ON is selected and the transaxle is in the PARK or NEUTRAL position, all doors will unlock when the driver's door is opened. To make your selection, press and hold the RESET button until ON or OFF appears.

Remote Key Unlock

When "Driver Door 1st Press" is selected, only the driver's door will unlock on the first press of the remote keyless entry unlock button. When Driver Door 1st Press is selected, you must press of the remote keyless entry unlock button twice to unlock the passenger's doors. When "All Doors 1st Press" is selected, all of the doors will unlock on the first press of the remote keyless entry unlock button. To make your selection, press and release the RESET button until "Driver Door 1st Press" or "All Doors 1st Press" appears.

Sound Horn with Lock

When ON is selected, a short horn sound will occur when the remote keyless entry LOCK button is pressed. This feature may be selected with or without the flash lights ON, LOCK/UNLOCK feature. To make your selection, press and release the RESET button until ON or OFF appears.

Flash Lights with Lock

When ON is selected, the front and rear turn signals will flash when the doors are locked or unlocked with the remote keyless entry transmitter. This feature may be selected with or without the Sound Horn on LOCK feature selected. To make your selection, press and release the RESET button until ON or OFF appears.

Headlights Off Delay

When this feature is selected, the driver can choose to have the headlights remain on for 0, 30, 60, or 90 seconds

when exiting the vehicle. To make your selection, press and hold the RESET button until 0, 30, 60, or 90 seconds appears.

Headlights With Wipers (Available with Auto Headlights Only)

When ON is selected, and the headlight switch is in the AUTO position, the headlights will turn on approximately 10 seconds after the wipers are turned on. The headlights will also turn off when the wipers are turned off if they were turned on by this feature. To make your selection, press and hold the RESET button until ON or OFF appears.

NOTE: Turning the headlights on during the daytime causes the instrument panel lights to dim. To increase the brightness, refer to “Lights” in Section 3 of this manual.

Key-Off Power Delay

When this feature is selected, the power window switches, radio, hands-free system (if equipped), and

power outlets will remain active for up to 10 minutes after the ignition switch is turned to the LOCK position. Opening a vehicle door will cancel this feature. To make your selection, press and hold the RESET button until Off, 45 sec., 5 min., or 10 min. appears.

Illumination Approach

When this feature is selected, the headlights will activate and remain on for up to 90 seconds when the doors are unlocked with the remote keyless entry transmitter. To make your selection, press and hold the RESET button until OFF, 30, 60, or 90 seconds appears.

Display Units in English or Metric

The EVIC and odometer can be changed between English and Metric units of measure. To make your selection, press and release the RESET button until U.S. or METRIC appears.

RADIO GENERAL INFORMATION

RADIO BROADCAST SIGNALS

The radio will provide excellent reception under most operating conditions. Like any system, however, automotive radios have performance limitations, due to mobile operation and natural phenomena, which might lead you to believe your sound system is malfunctioning. To help you understand and save you concern about these “apparent” malfunctions, you must understand a point or two about the transmission and reception of radio signals.

Electrical Disturbances

Radio waves may pick up electrical disturbances during transmission. They mainly affect the wave amplitude, and thus remain a part of the AM reception. They interfere very little with the frequency variations that carry the FM signal.

TWO TYPES OF SIGNALS

There are two basic types of radio signals: AM or Amplitude Modulation, in which the transmitted sound causes the amplitude, or height, of the radio waves to vary; and FM or Frequency Modulation, in which the frequency of the wave is varied to carry the sound.

AM Reception

AM sound is based on wave amplitude, so AM reception can be disrupted by such things as lightning, power lines and neon signs.

FM Reception

Because FM transmission is based on frequency variations, interference that consists of amplitude variations can be filtered out, leaving the reception relatively clear, which is the major feature of FM radio.

NOTE: The radio, steering wheel radio controls (if equipped), and six-disc CD/DVD changer (if equipped) will remain active for up to 10 minutes after the ignition switch has been turned OFF. Opening a vehicle front door will cancel this feature.

SALES CODE RES — AM/FM STEREO RADIO WITH CD PLAYER (MP3 AUX JACK)

NOTE: The radio sales code is located on the lower right side of your radio faceplate.

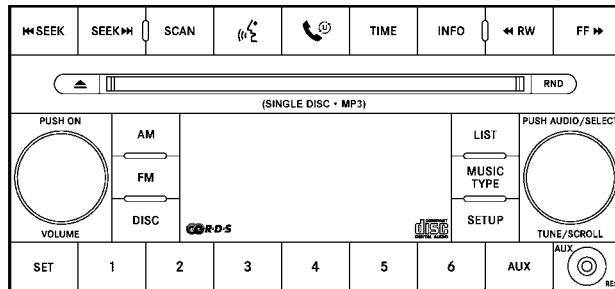

81c7c564

RES Radio (Non-Satellite Model Shown - With Satellite Similar)

Operating Instructions - Radio Mode

NOTE: The ignition switch must be in the ON or ACC position to operate the radio.

Power Switch/Volume Control (Rotary)

Push the On/Volume control knob to turn on the radio. Push the On/Volume control knob a second time to turn off the radio.

Electronic Volume Control

The electronic volume control turns continuously (360 degrees) in either direction without stopping. Turning the On/Volume control knob to the right increases the volume and to the left decreases it.

When the audio system is turned on, the sound will be set at the same volume level as last played.

SEEK Buttons

Press and release the SEEK buttons to search for the next listenable station in AM/FM mode. Press the right switch to seek up and the left switch to seek down. The radio will remain tuned to the new station until you make another selection. Holding either button will bypass stations without stopping until you release it.

SCAN Button

Pressing the SCAN button causes the tuner to search for the next listenable station in AM or FM frequencies, pausing for five seconds at each listenable station before continuing to the next. To stop the search, press the SCAN button a second time.

Voice Recognition System (Radio) — If Equipped

Refer to “Voice Recognition System (VR)” in Section 3.

Voice Recognition Button (UConnect® Hands-Free Phone) — If Equipped

Press this button to operate the Hands-Free Phone (UConnect®) feature (if equipped). Refer to “Hands-Free Communication (UConnect®)” in Section 3.

If your vehicle is not equipped with or this feature is not available on your vehicle, a “Not Equipped With UConnect” message will display on the radio screen.

Phone Button (UConnect® Hands-Free Phone) — If Equipped

Press this button to operate the Hands-Free Phone (UConnect®) feature (if equipped). Refer to “Hands-Free Communication (UConnect®)” in Section 3.

If your vehicle is not equipped with or this feature is not available on your vehicle, a “Not Equipped With UConnect” message will display on the radio screen.

TIME Button

Press the TIME button and the time of day will display. In AM or FM mode, pressing the TIME button will switch between the time and frequency displays.

Clock Setting Procedure

1. Press and hold the TIME button, until the hours blink.
2. Adjust the hours by turning the right side Tune/Scroll control knob.

3. After adjusting the hours, press the right side Tune/Scroll control knob to set the minutes. The minutes will begin to blink.

4. Adjust the minutes using the right side Tune/Scroll control knob. Press the Tune/Scroll control knob to save time change.

5. To exit, press any button/knob or wait five seconds.

The clock can also be set by pressing the SETUP button. For vehicles equipped with satellite radio, press the SETUP button, use the Tune/Scroll control to select SET CLOCK, and then follow the above procedure, starting at Step 2. For vehicles not equipped with satellite radio, press the SETUP button and then follow the above procedure, starting at Step 2.

INFO Button

Press the INFO button for an RDS station (one with call letters displayed). The radio will return a Radio Text message broadcast from an FM station (FM mode only).

RW/FF

Pressing the RW (Rewind) or FF (Fast Forward) buttons causes the tuner to search for the next frequency in the direction of the arrows. This feature operates in either AM or FM frequencies.

TUNE Control

Turn the rotary Tune/Scroll control knob clockwise to increase or counterclockwise to decrease the frequency.

Setting the Tone, Balance, and Fade

Push the rotary Tune/Scroll control knob and BASS will display. Turn the Tune/Scroll control knob to the right or left to increase or decrease the bass tones.

Push the rotary Tune/Scroll control knob a second time and MID will display. Turn the Tune/Scroll control knob to the right or left to increase or decrease the mid-range tones.

Push the rotary Tune/Scroll control knob a third time and TREBLE will display. Turn the Tune/Scroll control knob to the right or left to increase or decrease the treble tones.

Push the rotary Tune/Scroll control knob a fourth time and BALANCE will display. Turn the Tune/Scroll control knob to the right or left to adjust the sound level from the right or left side speakers.

Push the rotary Tune/Scroll control knob a fifth time and FADE will display. Turn the Tune/Scroll control knob to the left or right to adjust the sound level between the front and rear speakers.

Push the rotary Tune/Scroll control knob again to exit setting tone, balance, and fade.

MUSIC TYPE Button

Pressing this button once will turn on the Music Type mode for five seconds. Pressing the MUSIC TYPE button or turning the Tune/Scroll control knob within five seconds will allow the program format type to be selected. Many radio stations do not currently broadcast Music Type information.

Toggle the MUSIC TYPE button to select the following format types:

Program Type	16-Digit Character Display
No program type or undefined	None
Adult Hits	Adlt Hit
Classical	Classicl
Classic Rock	Cls Rock
College	College
Country	Country

Program Type	16-Digit Character Display
Foreign Language	Language
Information	Inform
Jazz	Jazz
News	News
Nostalgia	Nostalga
Oldies	Oldies
Personality	Persnlty
Public	Public
Rhythm and Blues	R & B
Religious Music	Rel Musc
Religious Talk	Rel Talk
Rock	Rock
Soft	Soft
Soft Rock	Soft Rck
Soft Rhythm and Blues	Soft R & B

Program Type	16-Digit Character Display
Sports	Sports
Talk	Talk
Top 40	Top 40
Weather	Weather

By pressing the SEEK button when the Music Type icon is displayed, the radio will be tuned to the next frequency station with the same selected Music Type name. The Music Type function only operates when in the FM mode.

If a preset button is activated while in the Music Type (Program Type) mode, the Music Type mode will be exited and the radio will tune to the preset station.

SETUP Button

Pressing the SETUP button allows you to select between the following items:

- **Set Clock** — Pressing the SELECT button will allow you to set the clock. Turn the Tune/Scroll control knob to adjust the hours and then press and turn the Tune/Scroll control knob to adjust the minutes. Press the Tune/Scroll control knob again to save changes.

AM and FM Buttons

Press the buttons to select AM or FM modes.

SET Button — To Set the Pushbutton Memory

When you are receiving a station that you wish to commit to pushbutton memory, press the SET button. The symbol SET 1 will now show in the display window. Select the button (1 to 6) you wish to lock onto this station and press and release that button. If a button is not selected within five seconds after pressing the SET button, the station will continue to play but will not be stored into pushbutton memory.

You may add a second station to each pushbutton by repeating the above procedure with this exception: Press

the SET button twice and SET 2 will show in the display window. Each button can be set for SET 1 and SET 2 in both AM and FM. This allows a total of 12 AM and 12 FM stations to be stored into pushbutton memory. The stations stored in SET 2 memory can be selected by pressing the pushbutton twice.

Every time a preset button is used, a corresponding button number will display.

Buttons 1 - 6

These buttons tune the radio to the stations that you commit to pushbutton memory (12 AM and 12 FM stations).

DISC Button

Pressing the DISC button will allow you to switch from AM/FM modes to Disc modes.

Operation Instructions - CD MODE for CD and MP3 Audio Play

NOTE: The ignition switch must be in the ON or ACC position to operate the radio.

NOTE: This radio is capable of playing compact discs (CD), recordable compact discs (CD-R), rewritable compact discs (CD-RW), compact discs with MP3 tracks and multisession compact discs with CD and MP3 tracks.

Inserting Compact Disc(s)

Gently insert one CD into the CD player with the CD label facing up. The CD will automatically be pulled into the CD player and the CD icon will illuminate on the radio display. If a CD does not go into the slot more than 1.0 in (2.5 cm), a disc may already be loaded and must be ejected before a new disc can be loaded.

If you insert a disc with the ignition ON and the radio ON, the unit will switch from radio to CD mode and

begin to play when you insert the disc. The display will show the disc number, the track number, and index time in minutes and seconds. Play will begin at the start of track 1.

CAUTION!

- **This CD player will accept 4-3/4 in (12 cm) discs only. The use of other sized discs may damage the CD player mechanism.**
- **Do not use adhesive labels. These labels can peel away and jam the player mechanism.**
- **RES is a single CD player. Do not attempt to insert a second CD if one is already loaded.**
- **Dual-media disc types (one side is a DVD, the other side is a CD) should not be used, and they can cause damage to the player.**

EJECT Button - Ejecting a CD

Press the EJECT button to eject the CD.



If you have ejected a disc and have not removed it within 10 seconds, it will be reloaded. If the CD is not removed, the radio will reinsert the CD but will not play it.

A disc can be ejected with the radio and ignition OFF.

NOTE: Ejecting with ignition OFF is not allowed on convertible or soft-top models (if equipped).

SEEK Button

Press the right SEEK button for the next selection on the CD. Press the left SEEK button to return to the beginning of the current selection, or return to the beginning of the previous selection if the CD is within the first second of

the current selection. Pressing and holding the SEEK button will allow faster scrolling through the tracks in CD, MP3 modes.

SCAN Button

Press the SCAN button to scan through each track on the CD currently playing.

TIME Button

Press this button to change the display from a large CD playing time display to a small CD playing time display.

RW/FF

Press the RW button to stop the CD at the beginning of the current CD track/title.

Press and hold FF (Fast Forward) and the CD player will begin to fast forward until FF is released or RW or another CD button is pressed. The RW (Reverse) button works in a similar manner.

AM or FM Button

Switches the AM or FM radio to the opposite radio mode.

RND Button (Random Play Button)

Press this button while the CD is playing to activate Random Play. This feature plays the selections on the compact disc in random order to provide an interesting change of pace.

Press the right SEEK button to move to the next randomly selected track.

Press the RND button a second time to stop Random Play.

Notes On Playing MP3 Files

The radio can play MP3 files; however, acceptable MP3 file recording media and formats are limited. When writing MP3 files, pay attention to the following restrictions.

Supported Media (Disc Types)

The MP3 file recording media supported by the radio are CDDA, CD-R, CD-RW, MP3, and CDDA+MP3.

Supported Medium Formats (File Systems)

The medium formats supported by the radio are ISO 9660 Level 1 and Level 2 and includes the Joliet extension. When reading discs recorded using formats other than ISO 9660 Level 1 and Level 2, the radio may fail to read files properly and may be unable to play the file normally. UDF and Apple HFS formats are not supported.

The radio uses the following limits for file systems:

- Maximum number of folder levels: 8
- Maximum number of files: 255
- Maximum number of folders. (The radio display of file names and folder names is limited. For large numbers of files and/or folders, the radio may be unable to display the file name and folder name and will assign

a number instead. With a maximum number of files, exceeding 20 folders will result in this display. With 200 files, exceeding 50 folders will result in this display.)

- Maximum number of characters in file/folder names:
 - Level 1: 12 (including a separator "." and a three-character extension)
 - Level 2: 31 (including a separator "." and a three-character extension)

Multisession disc formats are supported by the radio. Multisession discs may contain combinations of normal CD audio tracks and computer files (including MP3 files). Discs created with an option such as "keep disc open after writing" are most likely multisession discs. The use of multisession for CD audio or MP3 playback may result in longer disc loading times.

Supported MP3 File Formats

The radio will recognize only files with the *.MP3 extension as MP3 files. Non-MP3 files named with the *.MP3 extension may cause playback problems. The radio is designed to recognize the file as an invalid MP3 and will not play the file.

When using the MP3 encoder to compress audio data to an MP3 file, the bit rate and sampling frequencies in the following table are supported. In addition, variable bit rates (VBR) are also supported. The majority of MP3 files use a 44.1 kHz sampling rate and a 192, 160, 128, 96 or VBR bit rates.

MPEG Specification	Sampling Frequency (kHz)	Bit Rate (kbps)
MPEG-1 Audio Layer 3	48, 44.1, 32	320, 256, 224, 192, 160, 128, 112, 96, 80, 64, 56, 48, 40, 32
MPEG-2 Audio Layer 3	24, 22.05, 16	160, 128, 144, 112, 96, 80, 64, 56, 48, 40, 32, 24, 16, 8

ID3 Tag information for artist, song title, and album title are supported for version 1 ID3 tags. ID3 version 2 is not supported by the radios.

Playlist files are not supported. MP3 Pro files are not supported.

Playback of MP3 Files

When a medium containing MP3 data is loaded, the radio checks all files on the medium. If the medium contains a lot of folders or files, the radio will take more time to start playing the MP3 files.

Loading times for playback of MP3 files may be affected by the following:

- Media - CD-RW media may take longer to load than CD-R media
- Medium formats - Multisession discs may take longer to load than non-multisession discs
- Number of files and folders - Loading times will increase with more files and folders

To increase the speed of disc loading, it is recommended to use CD-R media and single-session discs. To create a single-session disc, enable the “Disc at Once” option before writing to the disc.

LIST Button (CD Mode for MP3 Play)

Pressing the LIST button will bring up a list of all folders on the disc. Scrolling up or down the list is done by turning the Tune/Scroll control knob. Selecting a folder by pressing the Tune/Scroll control knob will begin playing the files contained in that folder (or the next folder in sequence if the selection does not contain playable files).

The folder list will time out after five seconds.

INFO Button (CD Mode for MP3 Play)

Pressing the INFO button repeatedly will scroll through the following TAG information: Song Title, Artist, File Name, and Folder Name (if available).

Press the INFO button once more to return to “elapsed time” priority mode.

Press and hold the INFO button for three seconds or more and the radio will display song titles for each file.

Press and hold the INFO button again for three seconds to return to "elapsed time" display.

Operation Instructions - Auxiliary Mode

The auxiliary (AUX) jack is an audio input jack, which allows the user to plug in a portable device such as an MP3 player, or cassette player, and utilize the vehicle's audio system to amplify the source and play through the vehicle speakers.

Pressing the AUX button will change the mode to auxiliary device if the AUX jack is connected.

NOTE: The AUX device must be turned on and the device's volume set to proper level. If the AUX audio is not loud enough, turn the device's volume up. If the AUX audio sounds distorted, turn the device's volume down.

TIME Button (Auxiliary Mode)

Press this button to change the display to time of day. The time of day will display for five seconds (when ignition is OFF).

Operating Instructions - Hands-Free Phone (UConnect®) (If Equipped)

Refer to "Hands-Free Communication (UConnect®)" in Section 3.

Operating Instructions - Satellite Radio Mode (If Equipped)

Refer to "Satellite Radio" in this section.

Operating Instructions - Video Entertainment System (VES)® (If Equipped)

Refer to separate "Video Entertainment System (VES)® Guide."

SALES CODE REQ — AM/FM STEREO RADIO AND 6-DISC CD/DVD CHANGER (MP3/WMA AUX JACK)

NOTE: The radio sales code is located on the lower right side of your radio faceplate.

Operating Instructions - Radio Mode

NOTE: The ignition switch must be in the ON or ACC position to operate the radio.

Power Switch/Volume Control (Rotary)

Push the On/Volume control knob to turn on the radio. Press the control knob a second time to turn off the radio.

Electronic Volume Control

The electronic volume control turns continuously (360 degrees) in either direction without stopping. Turning the On/Volume control knob to the right increases the volume and to the left decreases it.

When the audio system is turned on, the sound will be set at the same volume level as last played.

SEEK Buttons

Press and release the SEEK buttons to search for the next listenable station in AM/FM mode. Press the right switch to seek up and the left switch to seek down. The radio will remain tuned to the new station until you make another selection. Holding either button will bypass stations without stopping until you release it.

SCAN Button

Pressing the SCAN button causes the tuner to search for the next listenable station, in AM, FM or Satellite (if equipped) frequencies, pausing for five seconds at each listenable station before continuing to the next. To stop the search, press the SCAN button a second time.

Voice Recognition Button (UConnect® Hands-Free Phone) — If Equipped

Press this button to operate the Hands-Free Phone (UConnect®) feature (if equipped). Refer to “Hands-Free Communication (UConnect®)” in Section 3.

If your vehicle is not equipped with or this feature is not available on your vehicle, a “Not Equipped With UConnect” message will display on the radio screen.

Phone Button (UConnect® Hands-Free Phone) — If Equipped

Press this button to operate the Hands-Free Phone (UConnect®) feature (if equipped). Refer to “Hands-Free Communication (UConnect®)” in Section 3.

If your vehicle is not equipped with or this feature is not available on your vehicle, a “Not Equipped With UConnect” message will display on the radio screen.

TIME Button

Press the TIME button and the time of day will display. In AM or FM mode, pressing the TIME button will switch between the time and frequency displays.

Clock Setting Procedure

1. Press and hold the TIME button until the hours blink.
2. Adjust the hours by turning the right side Tune/Scroll control knob.
3. After adjusting the hours, press the right side Tune/Scroll control knob to set the minutes. The minutes will begin to blink.
4. Adjust the minutes using the right side Tune/Scroll control knob. Press the Tune/Scroll control knob to save the time change.
5. To exit, press any button/knob or wait five seconds.

The clock can also be set by pressing the SETUP button and selecting the “SET HOME CLOCK” entry. Once in this display follow the above procedure, starting at Step 2.

INFO Button

Press the INFO button for an RDS station (one with call letters displayed). The radio will return a Radio Text message broadcast from an FM station (FM mode only).

RW/FF

Pressing the RW (Rewind) or FF (Fast Forward) buttons causes the tuner to search for the next frequency in the direction of the arrows. This feature operates in AM, FM or Satellite (if equipped) frequencies.

TUNE Control

Turn the rotary Tune/Scroll control knob clockwise to increase or counterclockwise to decrease the frequency.

Setting the Tone, Balance, and Fade

Push the rotary Tune/Scroll control knob and BASS will display. Turn the Tune/Scroll control knob to the right or left to increase or decrease the bass tones.

Push the rotary Tune/Scroll control knob a second time and MID will display. Turn the Tune/Scroll control knob to the right or left to increase or decrease the mid-range tones.

Push the rotary Tune/Scroll control knob a third time and TREBLE will display. Turn the Tune/Scroll control knob to the right or left to increase or decrease the treble tones.

Push the rotary Tune/Scroll control knob a fourth time and BALANCE will display. Turn the Tune/Scroll control knob to the right or left to adjust the sound level from the right or left side speakers.

Push the rotary Tune/Scroll control knob a fifth time and FADE will display. Turn the Tune/Scroll control knob to the left or right to adjust the sound level between the front and rear speakers.

Push the rotary Tune/Scroll control knob again to exit setting tone, balance, and fade.

MUSIC TYPE Button

Pressing this button once will turn on the Music Type mode for five seconds. Pressing the MUSIC TYPE button or turning the Tune/Scroll control knob within five seconds will allow the program format type to be selected. Many radio stations do not currently broadcast Music Type information.

Toggle the MUSIC TYPE button to select the following format types:

Program Type	16-Digit Character Display
No program type or undefined	None
Adult Hits	Adlt Hit
Classical	Classicl
Classic Rock	Cls Rock
College	College
Country	Country
Foreign Language	Language
Information	Inform
Jazz	Jazz
News	News
Nostalgia	Nostalga
Oldies	Oldies
Personality	Persnlty
Public	Public

Program Type	16-Digit Character Display
Rhythm and Blues	R & B
Religious Music	Rel Musc
Religious Talk	Rel Talk
Rock	Rock
Soft	Soft
Soft Rock	Soft Rck
Soft Rhythm and Blues	Soft R&B
Sports	Sports
Talk	Talk
Top 40	Top 40
Weather	Weather

By pressing the SEEK button when the Music Type icon is displayed, the radio will be tuned to the next frequency

station with the same selected Music Type name. The Music Type function only operates when in the FM mode.

If a preset button is activated while in the Music Type (Program Type) mode, the Music Type mode will be exited and the radio will tune to the preset station.

SETUP Button

Pressing the SETUP button allows you to select between the following items:

NOTE: Turn the Tune/Scroll control knob to scroll through the entries. Push the AUDIO/SELECT button to select an entry and make changes.

- **DVD Enter** - When the disc is in DVD Menu mode, selecting DVD Enter will allow you to play the current highlighted selection. Use the remote control to scroll up and down the menu (if equipped).



- **DISC Play/Pause** - You can toggle between playing the DVD and pausing the DVD by pushing the SELECT button (if equipped).
- **DVD Play Options** - Selecting the DVD Play Options will display the following:
 - Subtitle – Repeatedly pressing SELECT will switch subtitles to different subtitle languages that are available on the disc (if equipped).
 - Audio Stream – Repeatedly pressing SELECT will switch to different audio languages (if supported on the disc) (if equipped).
 - Angle – Repeatedly pressing SELECT will change the viewing angle if supported by the DVD disc (if equipped).

NOTE: The available selections for each of the above entries varies depending upon the disc.

NOTE: These selections can only be made while playing a DVD.

- **VES® Power** - Allows you to turn VES® on and off (if equipped).
- **VES® Lock** - Locks out rear VES® remote controls (if equipped).
- **VES® CH1/CH2** - Allows the user to change the mode of either the IR1 or IR2, wireless headphones by pressing the AUDIO/SELECT button (if equipped).
- **Set Home Clock** - Pressing the SELECT button allows you to set the clock. Turn the Tune/Scroll control knob to adjust the hours and then press and turn the Tune/Scroll control knob to adjust the minutes. Press the Tune/Scroll control knob again to save changes.
- **Player Defaults** - Selecting this item will allow the user to scroll through the following items, and set defaults according to customer preference.

Menu Language — If Equipped

Selecting this item will allow the user to choose the default startup DVD menu language (effective only if language supported by disc). If you want to select a language not listed, then scroll down and select "other." Enter the four-digit country code using the Tune/Scroll control knob to scroll up and down to select the number and then push to select.

Audio Language — If Equipped

Selecting this item allows you to choose a default audio language (effective only if the language is supported by the disc). You can select a language not listed by scrolling down and selecting "other." Enter the country code using the Tune/Scroll control knob to scroll up and down to select the number and then push to select.

Subtitle Language — If Equipped

Selecting this item allows you to choose a default subtitle language (effective only if the language is supported by the disc). You can select a language not listed by scrolling down and selecting "other." Enter the country code using the Tune/Scroll control knob to scroll up and down to select the number and then push to select.

Subtitles — If Equipped

Selecting this item allows you to choose between subtitle Off or On.

Audio DRC — If Equipped

Selecting this item allows you to limit maximum audio dynamic range. The default is set to "High," and under this setting, dialogues will play at 11 db higher than if the setting is "Normal."

Aspect Ratio — If Equipped

Selecting this item allows you to choose between wide screen, pan scan, and letter box.

AutoPlay — If Equipped

When this is set to On and a DVD video is inserted, it will bypass the DVD menu screen and automatically play the movie. In some rare cases, the DVD player may not auto-play the main title. In such cases, use the MENU button on the remote control to select desired title to play.

NOTE: The user will have to set these defaults before loading a disc. If changes are made to these settings after a disc is loaded, changes will not be effective. Also, the defaults are effective only if the disc supports the customer-preferred settings.

AM and FM Buttons

Press the buttons to select AM or FM Modes.

SET Button — To Set the Pushbutton Memory

When you are receiving a station that you wish to commit to pushbutton memory, press the SET button. The symbol SET 1 will now show in the display window. Select the button (1-6) you wish to lock onto this station and press and release that button. If a button is not selected within five seconds after pressing the SET button, the station will continue to play but will not be stored into pushbutton memory.

You may add a second station to each pushbutton by repeating the above procedure with this exception: Press the SET button twice and SET 2 will show in the display window. Each button can be set for SET 1 and SET 2 in both AM and FM. This allows a total of 12 AM, 12 FM, and 12 Satellite (if equipped) stations to be stored into pushbutton memory. The stations stored in SET 2 memory can be selected by pressing the pushbutton twice.

Every time a preset button is used, a corresponding button number will display.

Buttons 1 - 6

These buttons tune the radio to the stations that you commit to pushbutton memory {12 AM, 12 FM, and 12 Satellite (if equipped) stations}.

DISC Button

Pressing the DISC button will allow you to switch from AM/FM modes to Disc modes.

Operation Instructions - (DISC MODE for CD and MP3/WMA Audio Play, DVD-VIDEO)

The radio DVD player and many DVD discs are coded by geographic region. These region codes must match in order for the disc to play. If the region code for the DVD disc does not match the region code for the radio DVD player, it will not play the disc. Customers may take their vehicle to an authorized dealer to change the region code of the player a maximum of five times.

CAUTION!

The radio may shut down during extremely hot conditions. When this occurs, the radio will indicate "Disc Hot" and shut off until a safe temperature is reached. This shutdown is necessary to protect the optics of the DVD player and other radio internal components.

4

NOTE: The ignition switch must be in the ON or ACC position to operate the radio.

LOAD Button — Loading Compact Disc(s)

Press the LOAD button and the pushbutton with the corresponding number (1-6) where the CD is being loaded. The radio will display PLEASE WAIT and prompt when to INSERT DISC. After the radio displays "INSERT DISC," insert the CD into the player.

Radio display will show "LOADING DISC" when the disc is loading and "READING DISC" when the radio is reading the disc.

CAUTION!

This CD player will accept 4-3/4 in (12 cm) discs only. The use of other sized discs may damage the CD player mechanism.

Eject Button — Ejecting Compact Disc(s)



Press the EJECT button and the pushbutton with the corresponding number (1-6) where the CD was loaded and the disc will unload and move to the entrance for easy removal. Radio display will show "EJECTING DISC" when the disc is being ejected and prompt the user to remove the disc.

Press and hold the EJECT button for five seconds and all CDs will be ejected from the radio.

The disc can be ejected with the radio and ignition OFF.

SEEK Button (CD MODE)

Press the right SEEK button for the next selection on the CD. Press the left SEEK button to return to the beginning of the current selection, or return to the beginning of the previous selection if the CD is within the first second of the current selection. Pressing and holding the SEEK button will allow you to scroll through the tracks faster in CD, MP3/MWA modes.

SCAN Button (CD MODE)

Press the SCAN button to scan through each track on the CD currently playing.

TIME Button (CD MODE)

Press this button to change the display from a large CD playing time display to a small CD playing time display.

RW/FF (CD MODE)

Press and hold FF (Fast Forward) and the CD player will begin to fast forward until FF is released, or RW or another CD button is pressed. The RW (Rewind) button works in a similar manner.

AM or FM Button (CD MODE)

Switches the radio to the Radio mode.

Notes On Playing MP3/WMA Files

The radio can play MP3/WMA files; however, acceptable MP3/WMA file recording media and formats are limited. When writing MP3/WMA files, pay attention to the following restrictions.

Supported Media (Disc Types)

The MP3/WMA file recording media supported by the radio are CDDA, CD-R, CD-RW, MP3, WMA, DVD Video, DVD-R, DVD-RW, DVD+R, DVD+RW, and CDDA+MP3.

Supported Medium Formats (File Systems)

The medium formats supported by the radio are ISO 9660 Level 1 and Level 2 and includes the Joliet extension. When reading discs recorded using formats other than ISO 9660 Level 1 and Level 2, the radio may fail to read files properly and may be unable to play the file normally. UDF and Apple HFS formats are not supported.

The radio uses the following limits for file systems:

- Maximum number of directory levels: 8
- Maximum number of files: 255
- Maximum number of folders: 100
- Maximum number of characters in file/folder names:
 - Level 1: 12 (including a separator "." and a three-character extension)
 - Level 2: 31 (including a separator "." and a three-character extension)

Multisession disc formats are supported by the radio. Multisession discs may contain combinations of normal CD audio tracks and computer files (including MP3/WMA files). Discs created with an option such as "keep disc open after writing" are most likely multisession discs. The use of multisession for CD audio or MP3/WMA playback may result in longer disc loading times.

If a disc contains multi-formats, such as CD audio and MP3/WMA tracks, the radio will only play the MP3/WMA tracks on that disc.

Supported MP3/WMA File Formats

The radio will recognize only files with the *.MP3/WMA extension as MP3/WMA files. Non-MP3/WMA files named with the *.MP3/WMA extension may cause playback problems. The radio is designed to recognize the file as an invalid MP3/WMA and will not play the file.

When using the MP3/WMA encoder to compress audio data to an MP3/WMA file, the bit rate and sampling frequencies in the following table are supported. In addition, Variable Bit Rates (VBR) are also supported. The majority of MP3/WMA files use a 44.1 kHz sampling rate and a 192, 160, 128, 96 or VBR bit rates.

MP3 File Format

MPEG Specification	Sampling Frequency (kHz)	Bit Rate (kbps)
MPEG-1 Audio Layer 3	48, 44.1, 32	320, 256, 224, 192, 160, 128, 112, 96, 80, 64, 56, 48
MPEG-2 Audio Layer 3	24, 22.05, 16	160, 128, 144, 112, 96, 80, 64, 56, 48

WMA File Format

WMA Specification	Sampling Frequency (kHz)	Bit Rate (kbps)
WMA	44.1 and 48	48, 64, 96, 128, 160, 192 VBR

ID3 Tag information for artist, song title, and album title are supported for ID3 version 1 tags. ID3 version 2 is not supported by the radios.

Playlist files are not supported. MP3 Pro files are not supported.

Playback of MP3/WMA Files

When a medium containing MP3/WMA data is loaded, the radio checks all files on the medium. If the medium contains a lot of folders or files, the radio will take more time to start playing the MP3/WMA files.

Loading times for playback of MP3/WMA files may be affected by the following:

- Media - CD-RW media may take longer to load than CD-R media
- Medium formats - Multisession discs may take longer to load than non-multisession discs
- Number of files and folders - Loading times will increase with more files and folders

To increase the speed of disc loading, it is recommended to use CD-R media and single-session discs. To create a single-session disc, enable the “Disc at Once” option before writing to the disc.

LIST Button (DISC Mode for MP3/WMA Play)

Pressing the LIST button will bring up a list of all folders on the disc. Scrolling up or down the list is done by turning the Tune/Scroll control knob. Selecting a folder by pressing the Tune/Scroll control knob will begin playing the files contained in that folder (or the next folder in sequence if the selection does not contain playable files).

The folder list will time out after five seconds.

INFO Button (DISC Mode for MP3/WMA Play)

Pressing the INFO button repeatedly will scroll through the following TAG information: Song Title, Artist, File Name, and Folder Name (if available).

Press the INFO button once more to return to "elapsed time" priority mode.

Press and hold the INFO button for three seconds or more and radio will display song titles for each file.

Press and hold the INFO button again for three seconds to return to "elapsed time" display.

Operation Instructions - Auxiliary Mode

The auxiliary (AUX) jack is an audio input jack, which allows the user to plug in a portable device such as an MP3/WMA player, cassette player, or microphone and utilize the vehicle's audio system to amplify the source and play through the vehicle speakers.

Pressing the AUX button will change the mode to auxiliary device if the AUX jack is connected.

NOTE: The AUX device must be turned on and the device's volume set to the proper level. If the AUX audio is not loud enough, turn the device's volume up. If the AUX audio sounds distorted, turn the device's volume down.

SEEK Button (Auxiliary Mode)

No function.

SCAN Button (Auxiliary Mode)

No function.

EJECT Button (Auxiliary Mode)

No function.

**TIME Button (Auxiliary Mode)**

Press the TIME button to change the display from elapsed playing time to time of day. The time of day will display for five seconds.

RW/FF (Auxiliary Mode)

No function.

SET Button (Auxiliary Mode)

No function.

Operating Instructions — Voice Recognition System (VR) (If Equipped)

For the radio, refer to “Voice Recognition System (VR)” in Section 3.

For UConnect® “Voice Recognition System (VR)” refer to “Hands-Free Communication (UConnect®)” in Section 3.

Operating Instructions - Hands-Free Phone (UConnect®) — If Equipped

Refer to “Hands-Free Communication (UConnect®)” in Section 3.

Operating Instructions - Satellite Radio Mode (If Equipped)

Refer to “Satellite Radio” in this section.

Operating Instructions - Video Entertainment System (VES®) (If Equipped)

Refer to separate “Video Entertainment System (VES®) Guide.”

Dolby®

Manufactured under license from Dolby® Laboratories. "Dolby®" and the double-D symbol are trademarks of Dolby® Laboratories.

Macrovision

This product incorporates copyright protection technology that is protected by U.S. patents and other intellectual property rights. Use of this copyright protection technology must be authorized by Macrovision, and is intended for home and other limited viewing uses only, unless otherwise authorized by Macrovision. Reverse engineering or disassembly is prohibited

DTS™

"DTS™" and "DTS™ 2.0" are trademarks of Digital Theater Systems, Inc.

SALES CODE REN — MULTIMEDIA SYSTEM — IF EQUIPPED

NOTE: The sales code is located on the lower right side of the unit's faceplate.

The REN Multimedia system contains a radio, CD/DVD player, USB port, a 20-gigabyte hard drive (HDD), and a "JukeBox" (virtual CD changer). Sirius Satellite Radio is optional. The 6.5 in (16.5 cm) touch screen allows for easy menu selection.

A 20-gigabyte HDD allows uploads of music and photos from CDs or through the USB port. The Gracenote database finds the artist, track, and title for the music.

An auxiliary input jack permits passengers to listen to a portable MP3 player through the vehicle's speakers. For vehicles equipped with the Vehicle Entertainment System (VES)®, separate audio outputs allow passengers to listen to the vehicle speakers while different audio tracks play

through the system's wireless headphones. This means rear seat passengers can watch a DVD on the optional rear seat entertainment system, while the driver and front-seat passenger listen to the radio.

Other special features include direct tune, music type selections, easy store presets, backup camera display for vehicles equipped with a backup camera, and on some models, a dual display screen operation. Refer to your radio-specific user's manual for detailed operating instructions.

Operating Instructions — Satellite Radio (If Equipped)

Refer to your Radio-specific user's manual for detailed operating instructions.

Operating Instructions — Voice Recognition System (VR) (If Equipped)

For the radio, refer to "Voice Recognition System (VR)" in Section 3.

For Hands Free Phone Communication (UConnect®) "Voice Recognition System (VR)," refer to "Hands-Free Communication (UConnect®)" in Section 3.

Operating Instructions — Hands-Free Communication (UConnect®) (If Equipped)

Refer to "Hands-Free Communication (UConnect®)" in Section 3.

Clock Setting Procedure

Setting the Clock

1. Turn on the multimedia system.
2. Touch the screen where the time is displayed. The clock setting menu will appear on the screen.

3. To move the hour forward, touch the screen where the word “Hour” with the arrow pointing upward is displayed. To move the hour backward, touch the screen where the word “Hour” with the arrow pointing downward is displayed.

4. To move the minute forward, touch the screen where the word “Min” with the arrow pointing upward is displayed. To move the minute backward, touch the screen where the word “Min” with the arrow pointing downward is displayed.

5. To save the new time setting, touch the screen where the word “Save” is displayed.

Changing Daylight Savings Time

When selected, this feature will display the time of day in daylight savings time. Proceed as follows to change the current setting:

1. Turn on the multimedia system.

2. Touch the screen where the time is displayed. The clock setting menu will appear on the screen.

3. When this feature is on, a check mark will appear in the box next to the words “Daylight Savings.” Touch the screen where the words “Daylight Savings” are displayed to change the current setting.

Show Time if Radio is Off

When selected, this feature will display the time of day on the touch screen when the multimedia system is turned off. Proceed as follows to change the current setting:

1. Turn on the multimedia system.

2. Touch the screen where the time is displayed. The clock setting menu will appear on the screen.

3. When this feature is on, a check mark will appear in the box next to the words “Show Time if Radio is Off.”

Touch the screen where the words “Show Time if Radio is Off” are displayed to change the current setting.

Changing the Time Zone

1. Turn on the multimedia system.
2. Touch the screen where the time is displayed. The clock setting menu will appear on the screen.
3. Touch the screen where the words “Set Time Zone” are displayed. The time zone selection menu will appear on the screen.
4. Select a time zone by touching the screen where your selection appears. If you do not see a time zone that you want to select, touch the screen where the word “Page” is displayed to view additional time zones in the menu.
5. Touch the screen where the word “Save” is displayed.

SALES CODE RER — MULTIMEDIA SYSTEM — IF EQUIPPED

NOTE: The sales code is located on the lower right side of the unit’s faceplate.

The RER Multimedia system contains a radio, Sirius Satellite Radio player, navigation system, CD/DVD player, USB port, 20-gigabyte hard drive (HDD), and the UConnect® Hands-Free Bluetooth® cellular system.

NOTE: If your vehicle is not equipped with UConnect®, the unit will respond with a “Not Equipped With UConnect®” message when selecting controls related to this feature.

A 6.5 in (16.5 cm) touch screen allows easy menu selection, while the Advanced Voice Dialog System recognizes more than 1,000 words for audio, navigation, entertainment, and hands-free mobile phone use.

The satellite navigation capability combines a Global-Positioning System (GPS)-based navigation system with an integrated color screen to provide maps, turn identification, selection menus, and instructions for selecting a variety of destinations and routes.

A shared HDD for the navigation system, the database, and other radio features allows uploads of music and photos from CDs or through the USB port. The Gracenote database finds the artist, track, and title for the music.

An auxiliary input jack permits passengers to listen to a portable MP3 player through the vehicle's speakers. For vehicles equipped with the Vehicle Entertainment System (VES)[®], separate audio outputs allow passengers to listen to the vehicle speakers while different audio tracks play through the system's wireless headphones. This means rear-seat passengers can watch a DVD on the optional rear-seat entertainment system while the driver and front-seat passenger listen to the radio.

Other special features include direct tune, music type selections, traffic messaging (optional), easy store presets, parental lockout for VES[®] (if equipped), backup camera display for vehicles equipped with a backup camera, and on some models, a dual display screen operation. Refer to your "Navigation User's Manual" for detailed operating instructions.

Operating Instructions — Satellite Radio

Refer to your "Navigation User's Manual" for detailed operating instructions.

Operating Instructions — Hands-Free Communication (UConnect[®]) (If Equipped)

Refer to your "Navigation User's Manual" for detailed operating instructions.

Clock Setting Procedure

The GPS receiver in this system is synchronized to the time data being transmitted by the GPS satellites. The satellites' clock is Greenwich Mean Time (GMT). This is the worldwide standard for time. This makes the system's clock very accurate once the appropriate time zone and daylight savings information is set.

Changing the Time Zone

1. Turn on the multimedia system.
2. Touch the screen where the time is displayed. The clock setting menu will appear on the screen. If the words "Time: GPS Time" are displayed at the top of the screen, proceed to Step 4. Otherwise, proceed to Step 3.
3. If the words "Time: User Clock" are displayed at the top of the screen, touch the bottom of the screen where the words "User Clock" are displayed. The GPS time setting menu will appear on the screen.

4. Touch the screen where the words "Set Time Zone" are displayed. The time zone selection menu will appear on the screen.

5. Select a time zone by touching the screen where your selection appears. If you do not see a time zone that you want to select, touch the screen where the word "Page" is displayed to view additional time zones in the menu.

Changing Daylight Savings Time

When selected, this feature will display the time of day in daylight savings time. Proceed as follows to change the current setting:

1. Turn on the multimedia system.
2. Touch the screen where the time is displayed. The clock setting menu will appear on the screen.

3. When this feature is on, a check mark will appear in the box next to the words “Daylight Savings.” Touch the screen where the words “Daylight Savings” are displayed to change the current setting.

Setting the User Clock

If you wish to set the clock to a time different from the system clock, you can manually adjust the time by performing the following:

1. Turn on the multimedia system.
2. Touch the screen where the time is displayed. The clock setting menu will appear on the screen. If the words “Time: User Clock” are displayed at the top of the screen, proceed to Step 4. Otherwise, proceed to Step 3.
3. If the words “Time: GPS Time” are displayed at the top of the screen, touch the bottom of the screen where the words “GPS Time” are displayed. The user clock time setting menu will appear on the screen.

4. To move the hour forward, touch the screen where the word “Hour” with the arrow pointing upward is displayed. To move the hour backward, touch the screen where the word “Hour” with the arrow pointing downward is displayed.

5. To move the minute forward, touch the screen where the word “Min” with the arrow pointing upward is displayed. To move the minute backward, touch the screen where the word “Min” with the arrow pointing downward is displayed.

6. To save the new time setting, touch the screen where the word “Save” is displayed.

Show Time if Radio is Off

When selected, this feature will display the time of day on the touch screen when the system is turned off. Proceed as follows to change the current setting:

1. Turn on the multimedia system.

2. Touch the screen where the time is displayed. The clock setting menu will appear on the screen.
3. When this feature is on, a check mark will appear in the box next to the words “Show Time if Radio is Off.” Touch the screen where the words “Show Time if Radio is Off” are displayed to change the current setting.

UNIVERSAL CONSUMER INTERFACE (UCI) — IF EQUIPPED

NOTE: This section is for sales code RES/REL and REQ/RET radios only with UConnect®. For sales code REN/REZ touch screen radio and REU/REX/RE1 radio, refer to the separate User’s Manual.

This feature allows you to plug an iPod® mobile digital device into the vehicle’s sound system through a connector (UCI connector) using an optional connection cable (available through MOPAR®). See your authorized dealer for details.

Using this feature,

- the iPod® audio can be played on the vehicle’s sound system, providing metadata (Track Title, Artist, Album, etc.) information display on radio.
- the iPod® can be controlled using the radio buttons to Play, Browse and List the iPod® contents.
- the iPod® battery charges when plugged into the UCI connector.

Connecting The iPod® Device

Use the optional connection cable to connect an iPod® to the vehicle’s UCI connector (which is located in the glove box or center console on some vehicles. This location may vary with vehicle). Once the iPod® is connected and synchronized to the vehicle system (this may take a few seconds to connect), the vehicle brand logo appears on the iPod® display, and it starts charging and is ready for use by pressing radio switches as described below.

Controlling The iPod® Using Radio Buttons

To get into the UCI (iPod®) mode and access a connected iPod®, press the AUX button on the radio faceplate. Once in the UCI (iPod®) mode, the iPod® audio track (if available from iPod®) will start playing over the vehicle audio system.

Play Mode

When switched to UCI mode the iPod® will be in Play mode. In Play mode, you may use the following buttons on the radio faceplate to control the iPod® and display data:

Tune/Scroll Knob

Use the Tune/Scroll knob to go to the next or previous track.

The Tune/Scroll knob functions similar to the scroll wheel on the iPod® mobile digital device.

Turning it clockwise (forward) by one click while playing a track skips to the next track.

Turning it counterclockwise (backward) by one click during the first two seconds of the track will jump to the previous track in the list and turning this button at any other time in the track will jump to the beginning of the current track.

RW (Rewind) Button

Press and hold the RW button to move backward in the current track. Holding the RW button long enough will take you back to the beginning of the current track.

Pressing and releasing the RW button will go back five seconds of the current track.

FF (Fast Forward) Button

Press and hold the FF button to move forward in the current track.

Pressing and releasing the FF button will go forward five seconds of the current track.

SEEK Buttons

Use the SEEK buttons to move to the previous or the next track.

If the left (down) button is pressed during the first two seconds of the current track, it will go back to the previous track in the list; if you press this button at any other time in the current track it will go back to the beginning of the track.

If the right (up) button is pressed during Play mode, it will go to the next track in the list.

INFO Button

Press the INFO button while a track is playing to see the information (Track Title, Artist, Album, etc.) for that track. Each press of the INFO button will take you to the next screen of data for that track. Once you have seen all

of the screens, the last press of the INFO button will take you back to the Play mode screen on the radio.

REPEAT Button

Press the REPEAT button to repeat the current playing track.

SCAN Button

Pressing the SCAN button will play the first five seconds of each track in the current list and then forward to the next song. To stop the SCAN mode and start playing the desired track, press the SCAN button again.

During the SCAN mode, you can also press the SEEK button to the left or right to go to the previous or next tracks.

RND (Random) Button (RES/REL Radios Only)

Pressing the RND button will switch between the shuffle on and shuffle off modes of the iPod®. If the RND icon is showing on the radio display then the Shuffle mode is on.

List or Browse Mode

During Play mode, pressing any of the following buttons will take you to List mode. List mode enables you to scroll through the list of menus and tracks on the iPod® device.

Tune/Scroll Knob

In the List mode, the Tune/Scroll knob functions in a similar manner as the scroll wheel on the iPod®.

Turning the Tune/Scroll knob clockwise (forward) and counterclockwise (backward) scrolls through lists, displaying the track detail on the radio display. Once you have the track to be played highlighted on the radio display, press the Tune/Scroll knob to select and start playing the track. By turning the Tune/Scroll knob fast, you can jump through the list faster. During fast scroll, you may notice a slight delay in updating the information on the radio display.

During all List modes, the iPod® will display all lists in “wrap-around” mode. So if the track you wish to select is at the bottom of the list, you just turn the Tune/Scroll knob backward (counterclockwise) to get to the track faster.

Radio Preset Buttons

In the List mode, the radio preset buttons are used as shortcuts to the following lists on the iPod® device.

- 1 – Playlists
- 2 – Artists
- 3 – Albums
- 4 – Genres
- 5 – Audiobooks
- 6 – Podcasts

After pressing a preset button, you will see the list you are in on the top line and the first item in that list on the second line.

To exit the List mode without selecting a track, press the same preset button again to go back to Play mode.

LIST Button

Pressing the LIST button will take to the top level menu of the iPod®. This takes you to the same top level menu as on your iPod®. Turn the Tune/Scroll knob to list the top menu item you wish to select and then press the Tune/Scroll knob. This will take you to the next sub menu list item of the iPod® and you can follow the same steps to go to the desired track in that list. Not all iPod® sub menu levels are available on this system.

MUSIC TYPE Button

The MUSIC TYPE button is another shortcut button to the genre listing on your iPod®.

SATELLITE RADIO — IF EQUIPPED (REN/REQ/RER/RES/REU RADIOS ONLY)

Satellite radio uses direct satellite-to-receiver broadcasting technology to provide clear digital sound, coast to coast. The subscription service provider is Sirius Satellite Radio. This service offers over 130 channels of music, sports, news, entertainment, and programming for children, directly from its satellites and broadcasting studios.

NOTE: Sirius service is not available in Hawaii and has limited coverage in Alaska.

System Activation

Sirius Satellite Radio service is pre-activated, and you may begin listening immediately to the one year of audio service that is included with the factory-installed satellite radio system in your vehicle. Sirius will supply a welcome kit that contains general information, including how to setup your on-line listening account at no additional charge. For further information, call the toll-free

number 888-539-7474, or visit the Sirius web site at www.sirius.com, or at www.siriuscanada.ca for Canadian residents.

Electronic Serial Number/Sirius Identification Number (ESN/SID)

Please have the following information available when calling:

1. The Electronic Serial Number/Sirius Identification Number (ESN/SID).
2. Your Vehicle Identification Number.

To access the ESN/SID, refer to the following steps:

ESN/SID Access With REQ/RES Radios

With the ignition switch in the ON/RUN or ACC position and the radio on, press the SETUP button and scroll using the Tune/Scroll control knob until Sirius ID is selected. Press the Tune/Scroll control knob and the

Sirius ID number will display. The Sirius ID number display will time out in two minutes. Press any button on the radio to exit this screen.

ESN/SID Access With REN/RER Radios

While in SAT mode, press the MENU button on the radio faceplate.

Next, touch the SUBSCRIPTION tab on the touch screen. All the ESNs that apply to your vehicle will display.

ESN/SID Access With REU Radio

While in SAT mode, press the MENU button on the radio faceplate.

Next, turn the knob surrounding the joystick in the center of the radio to scroll to Subscription, and then press and release the joystick. All of the ESNs that apply to your vehicle will display.

Selecting Satellite Mode

Press the SAT button until "SAT" appears in the display. A CD may remain in the radio while in the Satellite radio mode.

Satellite Antenna

To ensure optimum reception, do not place items on the roof around the rooftop antenna location or strap items to the trunk lid around the trunk lid antenna (if equipped). Metal objects placed within the line of sight of the antenna will cause decreased performance. Larger luggage items such as bikes should be placed as far rearward as possible, within the loading design of the rack. Do not place items directly on or above the antenna.

Reception Quality

Satellite reception may be interrupted due to one of the following reasons:

- The vehicle is parked in an underground parking structure or under a physical obstacle.

- Dense tree coverage may interrupt reception in the form of short audio mutes.
- Driving under wide bridges or along tall buildings can cause intermittent reception.
- Placing objects over or too close to the antenna can cause signal blockage.

Operating Instructions - Satellite Mode

NOTE: The ignition switch must be in the ON or ACC position to operate the radio.

SEEK Buttons

Press and release the SEEK buttons to search for the next channel in Satellite mode. Press the right switch to seek up and the left switch to seek down. The radio will remain tuned to the new channel until you make another selection. Holding either button will bypass channels without stopping until you release it.

SCAN Button

Pressing the SCAN button causes the tuner to search for the next channel, pausing for eight seconds before continuing to the next. To stop the search, press the SCAN button a second time.

INFO Button — Except REU Radio

Pressing the INFO button will cycle the display information between Artist, Song Title, and Composer (if available). Also, pressing and holding the INFO button for an additional three seconds will make the radio display the Song Title all of the time (press and hold again to return to normal display).

INFO Button — REU Radio

Pressing the INFO button will display information about Artist, Song Title, and Composer (if available). Pressing the INFO button again will close the INFO screen.

RW/FF

Pressing the RW (Rewind) or FF (Fast Forward) buttons causes the tuner to search for the next channel in the direction of the arrows.

TUNE Control (Rotary)

Turn the rotary Tune/Scroll control knob clockwise to increase or counterclockwise to decrease the channel.

MUSIC TYPE Button — Except REU Radio

Pressing this button once will turn on the Music Type mode for five seconds. Pressing the MUSIC TYPE button or turning the Tune/Scroll control knob within five seconds will allow the program format type to be selected.

Toggle the MUSIC TYPE button again to select the music type.

By pressing the SEEK button when the Music Type function is active, the radio will be tuned to the next channel with the same selected Music Type name.

If a preset button is activated while in the Music Type (Program Type) mode, the Music Type mode will be exited and the radio will tune to the preset channel.

MUSIC TYPE Button — REU Radio

Pressing this button provides a MUSIC TYPES list from which you can make a selection. Once a selection is made, you can seek up, or down, or scan the channels and the radio will tune to the next station matching the selected format. There is no time-out for this screen. Pressing the MUSIC TYPE button again will close the MUSIC TYPE screen. Once closed, seek up, seek down, and scan will no longer be based on your selection.

SETUP Button

Pressing the SETUP button allows you to select the following items:

- Display Sirius ID number — Press the AUDIO/SELECT button to display the Sirius ID number. This number is used to activate, deactivate, or change the Sirius subscription.

SET Button – To Set the Pushbutton Memory

When you are receiving a channel that you wish to commit to pushbutton memory, press the SET button. The symbol SET 1 will now show in the display window. Select the button (1-6) you wish to lock onto this channel and press and release that button. If a button is not selected within five seconds after pressing the SET button, the channel will continue to play but will not be stored into pushbutton memory.

You may add a second channel to each pushbutton by repeating the above procedure with this exception: Press the SET button twice and SET 2 will show in the display window. Each button can be set for SET 1 and SET 2. This allows a total of 12 Satellite channels to be stored into pushbutton memory. The channels stored in SET 2 memory can be selected by pressing the pushbutton twice.

Every time a preset button is used, a corresponding button number will display.

Buttons 1 - 6

These buttons tune the radio to the channels that you commit to pushbutton memory (12 Satellite stations).

Operating Instructions - Hands-Free Phone (If Equipped)

Refer to “Hands-Free Communication (UConnect®)” in Section 3.

Operating Instructions - Video Entertainment System (VES®) (If Equipped)

Refer to separate “Video Entertainment System (VES®) Guide.”

REMOTE SOUND SYSTEM CONTROLS — IF EQUIPPED

The remote sound system controls are located on the rear surface of the steering wheel. The left- and right-hand controls are rocker-type switches with a push-button in the center of each switch. Reach behind the steering wheel to access the switches.

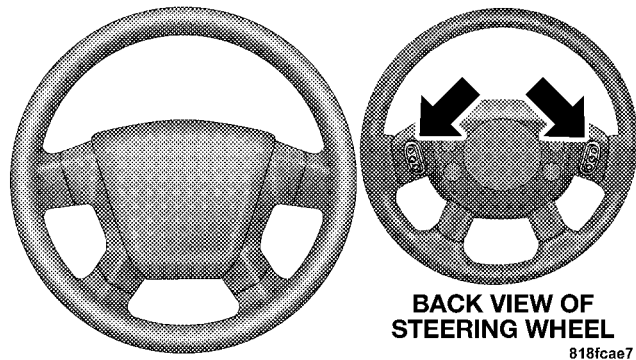

Remote Sound Controls

Operation with RES / REQ AM/FM Stereo Radio with CD Player

Right-Hand Switch Functions

- Press the top of the switch to increase the volume.
- Press the bottom of the switch to decrease the volume.

- Press the button in the center of the switch to select AM, FM, Satellite (SAT) - if equipped, or CD (DISC) mode.

Left-Hand Switch Functions for Radio Operation

- Press the top of the switch to SEEK the next listenable station up from the current setting.
- Press the bottom of the switch to SEEK the next listenable station down from the current setting.
- Press the button in the center of the switch to tune to the next preset that you have programmed.

Left-Hand Switch Functions for CD Player Operation

- Press the top of the switch once to listen to the next track on the CD.
- Press the bottom of the switch once either to listen to the beginning of the current track or to listen to the

beginning of the previous track if it is within one second after the current track begins to play.

- Press the switch up or down twice to listen to the second track on the CD, three times to listen to the third track, and so forth.
- Press the button located in the center of the control to change CDs on the 6-Disc in-dash CD changer radio. This button does not function for other radios.

Operation with RER Multi-Media System

Right-Hand Switch Functions

- Press the top of the switch to increase the volume.
- Press the bottom of the switch to decrease the volume.
- Press the button in the center of the switch to select AM, FM, Satellite (SAT), Hard Drive (HD), or CD (DISC) mode.

Left-Hand Switch Functions for Radio Operation

- Press the top of the switch to SEEK the next listenable station up from the current setting.
- Press the bottom of the switch to SEEK the next listenable station down from the current setting.
- Press the button in the center of the switch to go to the next preset that you have programmed.

Left-Hand Switch Functions for CD Player Operation

- Press the top of the switch once to listen to the next track on the CD.
- Press the bottom of the switch once either to listen to the beginning of the current track or to listen to the beginning of the previous track if it is within one second after the current track begins to play.

- Press the switch up or down twice to listen to the second track on the CD, three times to listen to the third track, and so forth.
- Press the button located in the center of the control to change CDs on the 6-Disc in-dash CD changer radio. This button does not function for other radios.

VIDEO ENTERTAINMENT SYSTEM (VES)[®] — IF EQUIPPED

The optional Video Entertainment System (VES)[®] includes the following components for rear seat entertainment:

- A diagonal 7 in (17.8 cm) Liquid Crystal Display (LCD) screen integrated into the center console armrest. The screen features brightness control for optimum daytime and nighttime viewing.

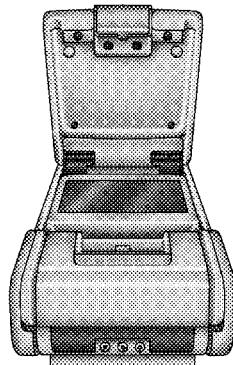

Opening the Rear Seat VES[®]

8199815e

- The LCD screen swings up from the rear of the armrest to allow the rear seat passenger(s) to view the display.

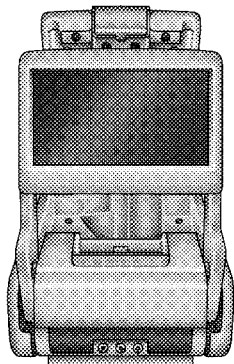

8199818b

VES® Video Screen

NOTE: Close the armrest after the LCD screen has been raised to its viewing position.

- The touch screen radio and DVD player controls allow front seat operation for easy setup in the case of younger rear seat passengers.
- A battery-powered infrared remote control snaps into a molded compartment in the center console armrest upper storage bin.

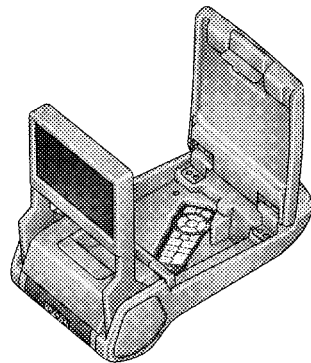

81abfb61

VES® Remote Control

- Two wireless infrared headsets allow rear seat passengers to listen to the same or individual audio sources.

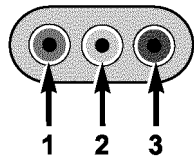

Audio/Video RCA Jacks (AUX Jacks) on the rear of the center console enable the monitor to display video directly from a video camera, connect video games for display on the screen, or play music directly from an MP3 player.

1. Video in (yellow)
2. Left audio in (white)
3. Right audio in (red)

NOTE: Refer to your “Vehicle Entertainment System (VES)[®] Users Manual” for detailed operating instructions.

RADIO OPERATION AND CELLULAR PHONES

Under certain conditions, the cellular phone being ON in your vehicle can cause erratic or noisy performance from your radio. This condition may be lessened or eliminated by relocating the cellular phone antenna. This condition is not harmful to the radio. If your radio performance does not satisfactorily “clear” by the repositioning of the antenna, it is recommended that the radio volume be turned down or off during cellular phone operation.

4

CD/DVD MAINTENANCE

To keep the CD/DVD discs in good condition, take the following precautions:

1. Handle the disc by its edge; avoid touching the surface.
2. If a disc is stained, clean the surface with a soft cloth, wiping from center to edge.

3. Do not apply paper, paper CD labels, or tape to the disc; avoid scratching a disc.
4. Do not use solvents such as benzine, thinner, cleaners, or antistatic sprays.
5. Store a disc in its case after playing.
6. Do not expose a disc to direct sunlight.
7. Do not store a disc where temperatures may become too high.
8. Do not play discs that are small in size or have irregular shapes.

CLIMATE CONTROLS

The Air Conditioning and Heating System is designed to make you comfortable in all types of weather.

Manual Air Conditioning and Heating System

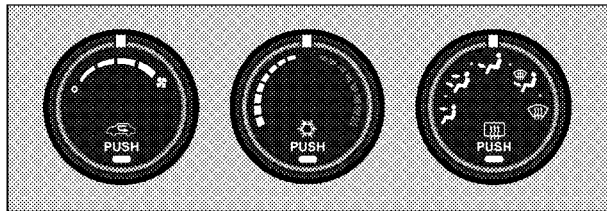

81c2cd2b

The Manual Temperature Controls consist of a series of outer rotary dials and inner pushbuttons.

Blower Control

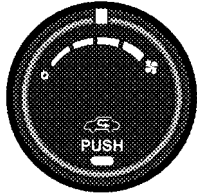

Use this control to regulate the amount of air forced through the ventilation system in any mode. The blower speed increases as you move the control to the right from the “0” (Off) position. There are four blower speeds.

Temperature Control

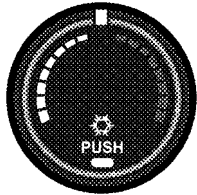

Use this control to regulate the temperature of the air inside the passenger compartment. The blue area of the scale indicates cooler temperatures while the red area indicates warmer temperatures.

NOTE: If your air conditioning performance seems lower than expected, check the front of the A/C condenser (located in front of the radiator) for an accumulation of dirt or insects. Clean with a gentle water spray from behind the radiator and through the condenser. Fabric front fascia protectors may reduce airflow to the condenser, reducing air conditioning performance.

Mode Control (Air Direction)

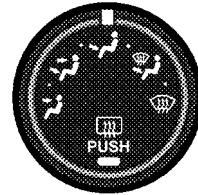

Use this control to choose from several patterns of air distribution. You can select either a primary mode as identified by the symbols on the control, or a blend of two of these modes. The closer the setting is to a particular symbol, the more air distribution you receive from that mode.

- **Panel**

 Air is directed through the outlets in the instrument panel. These outlets can be adjusted to direct airflow.

NOTE: The center instrument panel outlets can be aimed so that they are directed toward the rear seat passengers for maximum airflow to the rear.

- **Bi-Level**

 Air is directed through the panel and floor outlets.

NOTE: For all settings except full cold or full hot, there is a difference in temperature between the upper and lower outlets. The warmer air flows to the floor outlets. This feature gives improved comfort during sunny but cool conditions.

- **Floor**

 Air is directed through the floor outlets with a small amount flowing through the defrost and side window demist outlets.

- **Mix**

 Air is directed through the floor, defrost, and side window demist outlets. This setting works best in cold or snowy conditions that require extra heat to the windshield. This setting is good for maintaining comfort while reducing moisture on the windshield.

- **Defrost**

 Air is directed through the windshield and side window demist outlets. Use this mode with maximum blower and temperature settings for best windshield and side window defrosting.

NOTE: The air conditioning compressor operates in Mix and Defrost, or a blend of these modes, even if the Air Conditioning Snowflake button is not pressed. This dehumidifies the air to help dry the windshield. To improve fuel economy, use these modes only when necessary.

- **Recirculation Control**



Use this button to block the flow of outside air from coming into the passenger compartment. A light will illuminate when the system is in recirculation mode. Only use the recirculation mode as a temporary means to block out any outside odors, smoke, or dust, and to cool the interior rapidly upon initial start up in very hot or humid weather.

NOTE:

- Continuous use of the recirculation mode may make the inside air stuffy and window fogging may occur. Extended use of this mode is not recommended.

- The use of the recirculation mode in cold or damp weather will cause windows to fog on the inside, because of moisture build-up inside the vehicle. Select the Outside Air position for maximum defogging.
- The A/C will engage automatically to prevent fogging when the recirculation button is pressed and the mode control is set to panel or panel / floor.
- The A/C can be deselected manually without disturbing the mode control selection.

Air Conditioning Control



Use this button to engage the Air Conditioning. A light will illuminate when the Air Conditioning System is engaged

NOTE: The air conditioning compressor will not engage until the engine has been running for about 10 seconds.

- **MAX A/C**

For maximum cooling use the A/C and recirculation buttons at the same time.

- **Economy Mode**

If economy mode is desired, press the A/C button to turn off the indicator light and the A/C compressor. Then, move the temperature control to the desired temperature.

Automatic Temperature Control (ATC) — If Equipped

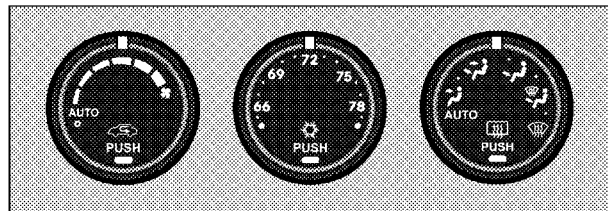

81c2cd46

Automatic Operation

The Infrared Climate Control System automatically maintains the climate in the cabin of the vehicle at the comfort levels desired by the driver and passenger. To accomplish this, the system gathers information from the

cabin infrared sensor mounted between the sun-visors and from various sensors located throughout the vehicle.

The controls on the climate control provide the system with operator input. Other sensors take account of vehicle speed, A/C pressure, outside temperature, and engine cooling temperature. Using all of these inputs, the system automatically adjusts airflow temperature, airflow distribution, airflow volume, and the amount of outside air recirculation. This maintains a comfortable temperature even under changing conditions.

Operation of the system is quite simple.

1. Turn the Mode Control knob (on the right) and the Blower Control knob (on the left) to AUTO.

NOTE: The AUTO position performs best for front seat occupants only.

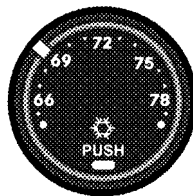

2. Dial in the temperature you would like the system to maintain by rotating the Temperature Control knob.

Once the comfort level is selected, the system will maintain that level automatically using the heating system. Should the desired comfort level require air conditioning, the system will automatically make the adjustment.

You will experience the greatest efficiency by simply allowing the system to function automatically. Selecting the "O" (Off) position on the blower control stops the system completely and closes the outside air intake.

72°F (22°C) is the recommended setting for maximum comfort for the average person; however, this may vary.

NOTE:

- The temperature setting can be adjusted at anytime without affecting automatic operation.
- Pressing the Air Conditioning Control button while in AUTO mode will cause the LED in the control button to flash three times and then turn off. This indicates that the system is in AUTO mode and requesting the air conditioning is not necessary.
- If your air conditioning performance seems lower than expected, check the front of the A/C condenser (located in front of the radiator) for an accumulation of dirt or insects. Clean with a gentle water spray from behind the radiator and through the condenser. Fabric front fascia protectors may reduce airflow to the condenser, reducing air conditioning performance.

Manual Operation

This system offers a full complement of manual override features, which consist of Blower Preferred Automatic, Mode Preferred Automatic, or Blower and Mode Preferred Automatic. This means the operator can override the blower, the mode, or both. There is a manual blower range for times when the AUTO setting is not desired. The blower can be set to any fixed blower speed by rotating the Blower Control knob (on the left).

NOTE: Please read the Automatic Temperature Control Operation Chart that follows for details.

Automatic Temperature Control Operation		The system will...				
Operation	How	Blower Control	Mode Control	Air Temperature Control	Air Recirculation Control	A/C Operation
Full Automatic Operation	Set blower knob to Auto. Set mode knob to Auto. Set temperature knobs for comfort.	Automatic	Automatic	Automatic	Automatic but can be overridden for 10 minutes at a time.	Automatic
Blower Preferred Automatic	Set blower knob to any desired airflow level other than Auto. Set mode knob to Auto. Set temperature knobs for comfort.	User selectable to any speed.	Automatic	Automatic	Automatic but can be overridden for 10 minutes at a time.	Automatic
Mode Preferred Automatic	Set mode knob to any desired air delivery point other than Auto. Set blower knob to Auto. Set temperature knobs for comfort.	Automatic	User selectable to any air delivery point.	Automatic	User selectable outside or recirculated.	User selectable A/C on or off.
Blower and Mode Preferred Automatic	Set blower knob to any desired airflow level other than Auto. Set mode knob to any desired air delivery point other than Auto. Set temperature knobs for comfort.	User selectable to any speed.	User selectable to any air delivery point.	Automatic	User selectable outside or recirculated.	User selectable A/C on or off.

The operator can override the AUTO mode setting to change airflow distribution by rotating the Mode Control knob (on the right) to one of the following positions.

- **Panel**

 Air is directed through the outlets in the instrument panel. These outlets can be adjusted to direct airflow.

NOTE: The center instrument panel outlets can be aimed so that they are directed toward the rear seat passengers for maximum airflow to the rear.

- **Bi-Level**

 Air is directed through the panel and floor outlets.

NOTE: For all settings except full cold or full hot, there is a difference in temperature between the upper and lower outlets. The warmer air flows to the floor outlets. This feature gives improved comfort during sunny but cool conditions.

- **Floor**

 Air is directed through the floor outlets with a small amount flowing through the defrost and side window demist outlets.

- **Mix**

 Air is directed through the floor, defrost, and side window demist outlets. This setting works best in cold or snowy conditions that require extra heat to the windshield. This setting is good for maintaining comfort while reducing moisture on the windshield.

- **Defrost**



Air is directed through the windshield and side window demist outlets. Use this mode with maximum blower and temperature settings for best windshield and side window defrosting.

- **Air Conditioner Control**



Press this button to turn on the air conditioning during manual operation only. When the air conditioning is turned on, cool dehumidified air will flow through the outlets selected with the Mode control dial. Press this button a second time to turn off the air conditioning. An LED in the button illuminates when manual compressor operation is selected.

- **Recirculation Control**



The system will automatically control recirculation. However, pressing the Recirculation Control button will temporarily put the

system in recirculation mode (ten minutes). This can be used when outside conditions such as smoke, odors, dust, or high humidity are present. Activating recirculation will cause the LED in the CONTROL button to illuminate. After ten minutes, the system will return to normal AUTO mode function and the LED will turn off.

NOTE:

- When the ignition switch is turned to the LOCK position, the recirculation feature will be cancelled.
- In cold weather, use of the Recirculation mode may lead to excessive window fogging. The Recirculation mode is not allowed in the floor, defrost, or defrost/floor mode in order to improve window clearing. Recirculation will be disabled automatically if these modes are selected.

- Extended use of recirculation may cause the windows to fog. If the interior of the windows begins to fog, press the RECIRCULATION button to return to outside air. Some temp/humidity conditions will cause captured interior air to condense on windows and hamper visibility. For this reason, the system will not allow Recirculation to be selected while in floor, defrost, or defrost/floor mode. Attempting to use the Recirculation while in these modes will cause the LED in the CONTROL button to blink and then turn off.
- Most of the time, when in Automatic Operation, you can temporarily put the system into Recirculation mode by pressing the RECIRCULATION button. However, under certain conditions, while in Automatic Mode, the system is blowing air out the defrost vents. When these conditions are present, and the RECIRCULATION button is pressed, the indicator will flash and then turn off. This tells you that you are unable to go into recirculation mode at this time. If you

would like the system to go into Recirculation mode, you must first move the Mode Knob to Panel, Panel/Floor and then press the RECIRCULATION button. This feature reduces the possibility of window fogging.

Operating Tips

NOTE: Refer to the chart at the end of this section for suggested control settings for various weather conditions.

Summer Operation

The engine cooling system in air-conditioned vehicles must be protected with a high-quality antifreeze coolant to provide proper corrosion protection and to protect against engine overheating. A 50% solution of ethylene glycol antifreeze coolant in water is recommended. Refer to “Maintenance Procedures” in Section 7 of this manual for proper coolant selection.

Winter Operation

Use of the air Recirculation mode during winter months is not recommended because it may cause window fogging.

Vacation Storage

Anytime you store your vehicle, or keep it out of service (i.e., vacation) for two weeks or more, run the air conditioning system at idle for about five minutes in the fresh air and high blower settings. This will ensure adequate system lubrication to minimize the possibility of compressor damage when the system is started again.

Window Fogging

Interior fogging on the windshield can be quickly removed by turning the mode selector to Defrost. The Defrost/Floor mode can be used to maintain a clear windshield and provide sufficient heating. If side window fogging becomes a problem, increase blower speed. Vehicle windows tend to fog on the inside in mild but rainy or humid weather.

NOTE: Recirculate without A/C should not be used for long periods as fogging may occur.

Side Window Demisters

A side window demister outlet is located at each end of the instrument panel. These non-adjustable outlets direct air toward the side windows when the system is in the Floor, Mix, or Defrost mode. The air is directed at the area of the windows through which you view the outside mirrors.











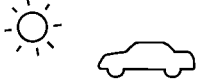







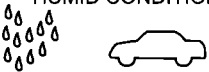

Outside Air Intake

Make sure the air intake, located directly in front of the windshield, is free of obstructions such as leaves. Leaves collected in the air intake may reduce airflow, and if they enter the plenum, they could plug the water drains. In winter months, make sure the air intake is clear of ice, slush, and snow.

A/C Air Filter — If Equipped

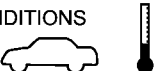
The A/C Air Filter will reduce, but not eliminate, diesel and agricultural smells. The filter acts on air coming from outside the vehicle and recirculated air within the passenger compartment. Refer to “Maintenance Procedures” in Section 7 of this manual for A/C Air Filter service information or see your authorized dealer for service. Refer to the “Maintenance Schedules” in Section 8 of this manual for filter service intervals.

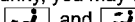
Control Setting Suggestions for Various Weather Conditions

WEATHER	CONTROL SETTINGS
<p>HOT WEATHER AND VEHICLE INTERIOR IS VERY HOT</p> 	<p>Open the windows, start the vehicle, press the  button to turn recirculate off. Set the Fan control to the high position (full clockwise) position. Press the  button. Set the Mode control at or between . Set the temperature control to full cool. After the hot air is pushed from the vehicle press the  button to turn recirculate on and roll up the windows. Once you are comfortable, press the  button to turn recirculate off and adjust the temperature control for comfort.</p>
<p>WARM WEATHER</p> 	<p>Press the  button to turn recirculate off. If it's sunny, set the Mode control at or near  and turn the air conditioning on. If it's cloudy or dark, set the Mode control at or near .</p>
<p>COOL OR COLD HUMID CONDITIONS</p> 	<p>Press the  button to turn recirculate off. If it's sunny, set the Mode control at or between  then turn the air conditioning on. If it's cloudy or dark, set the Mode control at or near  and turn the air conditioning on. If the windows begin to fog, set Mode control at or between  and .</p>
<p>COLD DRY CONDITIONS</p> 	<p>Set the Mode control at or near . If it is sunny, you may want more upper air. In this case, set the Mode control at or between . In very cold weather, if you need extra heat at the windshield, set the Mode control at or near the .</p>

REAR WINDOW FEATURES

Electric Rear Window Defroster — If Equipped



The electric Rear Window Defroster Control is located on the climate control. Press this button to turn on the rear window defroster and the heated side mirrors (if equipped). An LED in the button will illuminate when the rear window defroster is ON. The defroster automatically turns off after approximately 10 minutes of operation for the first push of the button, and will turn off after approximately five minutes for the second push of the button.

CAUTION!

To avoid damaging the electrical conductors of the rear window defroster, do not use scrapers, sharp instruments, or abrasive window cleaners on the interior surface of the window.

Labels can be peeled off after soaking with warm water.

STARTING AND OPERATING

CONTENTS

■ Starting Procedures	261	■ Engine Block Heater — If Equipped	266
□ Automatic Transaxle	261	■ Automatic Transaxle	267
□ Normal Starting	262	□ Brake/Transaxle Interlock System	269
□ Tip Start — Automatic Transaxle Only	262	□ Automatic Transaxle Ignition Interlock System	269
□ Extremely Cold Weather (Below -20°F Or -29°C)	263	□ 4 Speed / 6 Speed Automatic Transaxle / AutoStick® — If Equipped	270
□ If Engine Fails To Start	263	■ AutoStick® — If Equipped	274
□ After Starting	264	□ AutoStick® Operation	274
□ Remote Starting System — If Equipped	264	□ AutoStick® General Information	274
□ How To Use Remote Start	264		

■ All Wheel Drive — If Equipped	275	□ Traction	288
■ Parking Brake	276	■ Driving Through Water	289
■ Brake System	278	□ Flowing/Rising Water	289
□ Anit-Lock Brake System (ABS)	279	■ Tire Safety Information	291
■ Electronic Brake Control Systems – ABS/TCS/BAS/ESP	281	□ Tire Markings	291
□ Anti-Lock Brake System (ABS)	281	□ Tire Loading And Tire Pressure	295
□ Traction Control System (TCS)	282	■ Tires — General Information	299
□ Brake Assist System (BAS)	282	□ Tire Pressure	299
□ Electronic Stability Program (ESP)	283	□ Tire Inflation Pressures	300
■ Power Steering	287	□ Radial-Ply Tires	302
■ Driving On Slippery Surfaces	288	□ Compact Spare Tire — If Equipped	303
□ Acceleration	288	□ Limited Use Spare — If Equipped	304
		□ Tire Spinning	305

□ Tread Wear Indicators	306	□ 2.4L And 2.7L Engines	319
□ Life Of Tire	306	□ 3.5L Engine	320
□ Replacement Tires	307	□ Reformulated Gasoline	320
□ Alignment And Balance	308	□ Gasoline/Oxygenate Blends	321
■ Tire Chains	309	□ MMT In Gasoline	322
■ Snow Tires	309	□ Materials Added To Fuel	322
■ Tire Rotation Recommendations	309	□ Fuel System Cautions	322
■ Tire Pressure Monitor System (TPMS) —		□ Carbon Monoxide Warnings	323
If Equipped	310	■ Flexible Fuel— 2.7L Engines Only	
□ Base System — If Equipped	313	(Except California Emission States)	324
□ Premium System — If Equipped	315	□ E-85 General Information	324
□ General Information	319	□ Ethanol Fuel (E-85)	325
■ Fuel Requirements	319	□ Fuel Requirements	326

- Selection Of Engine Oil For Flexible Fuel Vehicles (E-85) And Gasoline Vehicles 326
- Starting 327
- Cruising Range 327
- Replacement Parts 327
- Maintenance 327
- Adding Fuel 328
 - Fuel Filler Cap (Gas Cap) 328
 - Loose Filler Cap Message 330
- Vehicle Loading 331
 - Vehicle Certification Label 331
 - Gross Vehicle Weight Rating (GVWR) 332
 - Gross Axle Weight Rating (GAWR) 332
 - Overloading 332
 - Loading 333
- Trailer Towing 334
 - Common Towing Definitions 334
 - Trailer Hitch Classifications 336
 - Trailer Towing Weights (Maximum Trailer Weight Ratings) 337
 - Trailer And Trailer Tongue Weight 338
 - Towing Requirements 339
 - Towing Tips 343
- Recreational Towing (Behind Motorhome, Etc.) . . 345
 - Towing This Vehicle Behind Another Vehicle (Flat Towing With All Four Wheels On The Ground) 345

STARTING PROCEDURES

Before starting your vehicle, adjust your seat, adjust both inside and outside mirrors, and fasten your seat belt. Make sure all occupants have securely fastened their seat belts.

WARNING!

Never leave children alone in a vehicle. Leaving children in a vehicle unattended is dangerous for a number of reasons. A child or others could be seriously or fatally injured. Don't leave the keys in the ignition. A child could operate power windows, other controls, or move the vehicle.

WARNING!

Be sure to turn off the engine and remove the key from the ignition switch if you want to rest or sleep in your car. Accidents can be caused by inadvertently moving the gear selection lever or by pressing the accelerator pedal. This may cause excessive heat in the exhaust system, resulting in overheating and vehicle fire which may cause serious or fatal injuries.

5

Automatic Transaxle

The gear selector must be in the PARK or NEUTRAL position before you can start the engine. Apply the brakes before shifting to any driving gear.

NOTE: You must press the brake pedal before shifting out of Park.

Normal Starting

Normal Starting of either a cold or a warm engine does not require pumping or depressing the accelerator pedal. Simply turn the ignition switch to the START position and release when the engine starts. If the engine fails to start within 15 seconds, turn the ignition switch to the LOCK position, wait 10 to 15 seconds, then repeat the normal starting procedure.

WARNING!

Do not attempt to push or tow your vehicle to get it started. Vehicles equipped with an automatic transaxle cannot be started this way. Unburned fuel could enter the catalytic converter and once the engine has started, ignite and damage the converter and vehicle. If the vehicle has a discharged battery, booster cables may be used to obtain a start from another vehicle. This type of start can be dangerous if done improperly, so follow the procedure carefully. See section 6 of this manual for jump starting instructions.

Tip Start — Automatic Transaxle Only

Do not press the accelerator. Turn the ignition key briefly to START position, and release it. The starter motor will continue to run, but will automatically disengage itself when the engine is running.

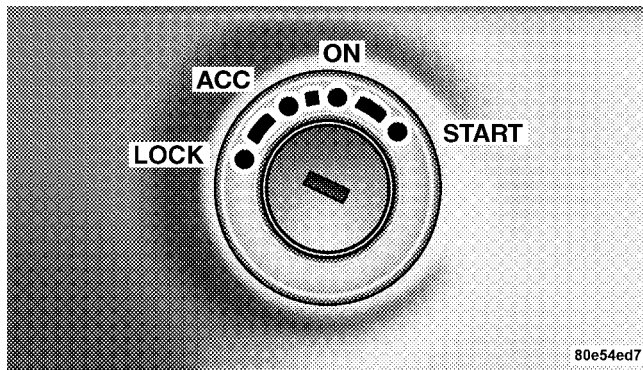

Ignition Key Position

Extremely Cold Weather (Below -20°F or -29°C)

To ensure reliable starting at these temperatures, use of an externally powered electric engine block heater (available from your authorized dealer) is recommended.

If Engine Fails To Start

If the engine fails to start after you have followed the NORMAL STARTING procedure, it may be flooded. Push the accelerator pedal all the way to the floor and hold it there. Crank the engine for no more than 15 seconds. This should clear any excess fuel in case the engine is flooded. Leave the ignition key in the ON position, release the accelerator pedal and repeat the NORMAL STARTING procedure.

WARNING!

Never pour fuel or other flammable liquid into the throttle body air inlet opening in an attempt to start the vehicle. This could result in flash fire causing serious personal injury.

CAUTION!

To prevent damage to the starter, do not crank the engine for more than 15 seconds at a time. Wait 10 to 15 seconds before trying again.

After Starting

The idle speed will automatically decrease as the engine warms up.

Remote Starting System — If Equipped

Remote start conveniently starts the engine from outside the vehicle by using the Remote Keyless Entry (RKE) key fob while maintaining security. The system has a targeted range of 328 ft (100 m). The vehicle must be locked, the deck lid and hood closed and the transmission in PARK in order to start the engine using the Remote Start button on the key fob.

NOTE: Remote start requires Automatic Transaxle equipped vehicles.

How To Use Remote Start

To enter the Remote Start mode, depress the Remote Start button twice on the key fob. The engine will start and the vehicle will remain in the remote start mode for a 15 minute cycle.

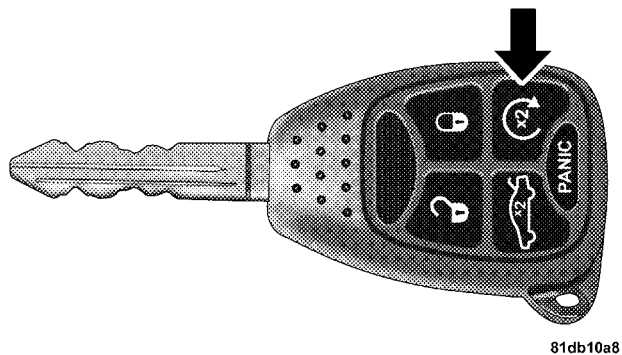

Remote Start



To exit the Remote Start mode, allow the engine to run the cycle or depress the unlock button to disarm the Vehicle Theft Security Alarm and within one minute insert the key

into the ignition and turn the ignition to the RUN position. The ignition must be in the RUN position in order to drive the vehicle.

NOTE: The engine can be started two consecutive times (two 15 minute cycles) by using the key fob. For a third cycle, the key must be cycled to the ignition RUN position and then repeat the start sequence.

To shut off the vehicle when it is in Remote Start mode, press the remote start button once. In order to avoid inadvertent shut downs, the one-time press to shut down the vehicle will be disabled for two seconds after receipt of a valid remote start request.

NOTE: When the vehicle is in the Remote Start mode, power window and sunroof operation are disabled for security.

The following conditions must be met before the engine will remote start:

- Automatic Transaxle in PARK
- All doors are closed
- Hood is closed
- Hazard Switch is off
- Brake Switch is inactive
- Key is not in the ignition
- Battery is at an acceptable charge level
- PANIC button on key fob is not depressed

ENGINE BLOCK HEATER — IF EQUIPPED

The engine block heater warms engine coolant and permits quicker starts in cold weather. Connect the cord to a standard 110-115 Volt AC electrical outlet with a grounded, three-wire extension cord.

The engine block heater cord is bundled under the hood between the headlight assembly and the Totally Integrated Power Module (Fuse Box) on the driver's side of the vehicle.

WARNING!

Remember to disconnect the cord before driving. Damage to the 110-115 Volt electrical cord could cause electrocution.

AUTOMATIC TRANSAXLE

CAUTION!

Damage to the transaxle may occur if the following precautions are not observed:

- Shift into **PARK** only after the vehicle has come to a complete stop.
- Shift into or out of **REVERSE** only after the vehicle has come to a complete stop and the engine is at idle speed.
- Do not shift from **REVERSE, PARK, or NEUTRAL** into any forward gear when the engine is above idle speed.
- Before shifting into any gear, make sure your foot is firmly on the brake pedal.

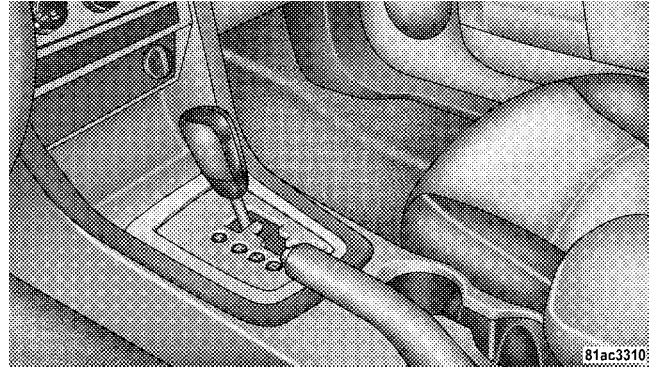

Gear Selector Lever

NOTE: You **MUST** press and hold the brake pedal down while shifting out of **PARK**.

WARNING!

It is dangerous to shift the gear selector lever out of PARK or NEUTRAL if the engine speed is higher than idle speed. If your foot is not firmly on the brake pedal, the vehicle could accelerate quickly forward or in reverse. You could lose control of the vehicle and hit someone or something. Only shift into gear when the engine is idling normally and when your right foot is firmly on the brake pedal.

WARNING!

Unintended movement of a vehicle could injure those in and near the vehicle. As with all vehicles, you should never exit a vehicle while the engine is running. Before exiting a vehicle, you should always shift the vehicle into PARK, remove the key from the ignition, and apply the parking brake. Once the key is removed from the ignition, the gear selector lever is locked in the PARK position, securing the vehicle against unwanted movement. Furthermore, you should never leave children unattended inside a vehicle.

Brake/Transaxle Interlock System

This system prevents you from moving the gear selector lever out of PARK and into any gear unless the brake pedal is pressed. This system is active only while the ignition switch is in the ON position. **Always press the brake pedal first, before moving the gear selector out of PARK.**

NOTE: If a malfunction occurs, the transaxle will not shift out of park. Battery power is required to release the brake/transaxle interlock system. However, there is an override system that allows you to shift out of Park in case of loss of power. To activate the override system:

- Firmly apply the parking brake
- Insert the ignition key and rotate it to the ON position
- Remove the cup holder liner

- Insert a key, screwdriver, or finger into the front hole then push and hold the manual override release lever forward.
- While holding the release lever forward, move the gear selector lever from PARK to NEUTRAL. Release the override

NOTE: If this occurs, even if the override is successful, it is recommended that you visit a dealer at your earliest possible convenience. Your dealer has diagnostic equipment to determine if the problem could recur.

Automatic Transaxle Ignition Interlock System

This system prevents the key from being removed unless the shift lever is in PARK. It also prevents shifting out of PARK unless the key is in the ON position and the brake pedal is applied.

NOTE: If a malfunction occurs, the system will trap the key in the ignition cylinder to warn you that this safety

feature is inoperable. The engine can be started and stopped, but the key cannot be removed until you obtain service.

4 Speed / 6 Speed Automatic Transaxle / AutoStick® — If Equipped

The electronically controlled transaxle provides a precise shift schedule. The transaxle electronics are self-calibrating; therefore, the first few shifts on a new vehicle may be somewhat abrupt. This is a normal condition, and precision shifts will develop within a few hundred miles.

Gear Ranges

PARK

Supplement to the parking brake by locking the transaxle. The engine can be started in this range. Never attempt to use PARK while vehicle is in motion. Apply parking brake when leaving vehicle in this range.

When parking on a flat surface, place the gear selector lever in the PARK position first, and then apply the parking brake.

When parking on a hill, it is important to set the parking brake before placing the gear selector lever in PARK, otherwise the load on the transaxle locking mechanism may make it difficult to move the selector out of PARK. As an added precaution, turn the front wheels toward the curb on a downhill grade and away from the curb on an uphill grade.

WARNING!

Never use PARK position on an Automatic Transaxle as a substitute for the parking brake. Always apply parking brake fully when parked to guard against vehicle movement and possible injury or damage.

CAUTION!

DO NOT race the engine when shifting from **PARK** or **NEUTRAL** positions into another gear range as this can damage the drivetrain.

REVERSE

Use this range for moving the vehicle rearward. Shift into this range only after the vehicle has come to a complete stop.

NEUTRAL

Engine may be started in this range.

WARNING!

Do not coast in **NEUTRAL** and never turn off the ignition to coast down a hill. These are unsafe practices that limit your response to changing traffic or road conditions. You might lose control of the vehicle and have an accident.

DRIVE — 6 Speed Transaxle

This range should be used for most city and highway driving, it provides the smoothest upshifts, downshifts, and best fuel economy. However, use the AutoStick® mode and select the “5” range when frequent transaxle shifting occurs while using the **DRIVE** range, such as when operating the vehicle under heavy loading conditions, (i.e. in hilly terrain, traveling into strong head winds or while towing heavy trailers). Under these

conditions, using the “5” range will improve performance and extend transaxle life by reducing excessive shifting and heat build-up.

OVERDRIVE— 4 Speed Transaxle

This range should be used for most city and highway driving, it provides the smoothest upshifts, downshifts, and best fuel economy. However, select the “3” DRIVE range when frequent transaxle shifting occurs while using the OVERDRIVE range, such as when operating the vehicle under heavy loading conditions, (i.e. in hilly terrain, traveling into strong head winds or while towing heavy trailers). Under these conditions, using the “3” DRIVE range will improve performance and extend transaxle life by reducing excessive shifting and heat build-up.

DRIVE — 4 Speed Transaxle

This range eliminates shifts into OVERDRIVE. The transaxle will operate normally in First, Second, and Third while in this range. The “3” DRIVE range should also be used when descending steep grades to prevent brake system distress.

NOTE: Using the “3” DRIVE range while operating the vehicle under heavy operating conditions will improve performance and extend transaxle life by reducing excessive shifting and heat build up.

LOW — 4 Speed Transaxle

This range should be used for engine braking when descending very steep grades. In this range, upshifts will occur only to prevent engine overspeed while downshifts occur earlier than other gear range selections.

CAUTION!

If the transaxle operating temperature exceeds acceptable limits, the vehicle computer will override OVERDRIVE and “3” DRIVE range by changing shift points. This is done to prevent transaxle damage due to overheating.

Reset Mode - Electronic Transaxle

The transaxle is monitored electronically for abnormal conditions. If a condition is detected that could cause damage, the transaxle automatically shifts into second gear. The transaxle remains in second gear (3rd gear with a six speed automatic) despite the forward gear selected. Park (P), Reverse (R), and Neutral (N) will continue to operate. This Reset feature allows the vehicle to be driven to a dealer for service without damaging the transaxle.

In the event that the problem has been momentary, the transaxle can be reset to regain all forward gears.

1. Stop the vehicle.
2. Shift into PARK.
3. Turn the ignition OFF, and then restart the engine.
4. Shift into the desired gear range and resume driving.

NOTE: Even if the transaxle can be reset, it is recommended that you visit a dealer at your earliest possible convenience. Your dealer has diagnostic equipment to determine if the problem could recur.

If the transaxle cannot be reset, dealer service is required.

AUTOSTICK® — IF EQUIPPED

AutoStick® is a driver-interactive transaxle that offers six manual ratio changes to provide you with more control. AutoStick® allows you to maximize engine braking, eliminate undesirable upshifts and downshifts, and improve overall vehicle performance. This system can also provide you with more control during passing, city driving, cold slippery conditions, mountain driving, trailer towing, and many other situations.

AutoStick® Operation

By placing the gear selector lever one shift-level below the DRIVE position, it can be moved from side to side. This allows the driver to select a higher or lower range of gears. Moving the selector lever to the Left (-) triggers a downshift and to the Right (+) an upshift. The gear position will display in the instrument cluster on the transaxle range indicator.

NOTE: In Autostick® mode, the transaxle will only shift up or down when the driver moves the selector lever to the Right (+) or Left (-).

AutoStick® is deactivated when the gear selector lever is shifted from the AutoStick (+/-) position into the DRIVE position.

AutoStick® General Information

- You can start out in first or second gear. The system will ignore attempts to upshift at too low of a vehicle speed.
- The transmission will automatically downshift to first gear when coming to a stop.
- Starting out in second gear is helpful in snowy or icy conditions.
- Avoid using speed control when Autostick® is engaged.

- The transaxle will automatically shift up when maximum engine speed is reached while Autostick® is engaged.
- Transaxle shifting will be more noticeable when Autostick® is engaged.
- If a downshift would cause the engine to over-speed, that shift will not occur until it is safe for the engine. The transaxle will stay in the manually selected gear.
- If the system detects powertrain overheating, the transaxle will revert to the automatic shift mode and remain in that mode until the powertrain cools off.
- If the system detects a problem, it will disable the AutoStick® mode and the transaxle will return to the automatic mode until the problem is corrected.

ALL WHEEL DRIVE — IF EQUIPPED

This feature provides full time, on-demand, All Wheel Drive (AWD). The system is automatic with no driver inputs or additional driving skills required. Under normal driving conditions, the front wheels provide most of the traction. If the front wheels begin to lose traction, power is shifted automatically to the rear wheels. The greater the front wheel traction loss, the greater the power transfer to the rear wheels.

Additionally, on dry pavement under heavy throttle input (where one may have no wheel spin), torque will be sent to the rear in a preemptive effort to improve vehicle launch and performance characteristics.

The system contributes to good fuel economy by operating only on demand, thereby minimizing power-robbing friction and inertia.

CAUTION!

All wheels must have the same size and type tires. Unequal tire sizes must not be used. Unequal tire size may cause failure of the power transfer unit.

PARKING BRAKE

When the parking brake is applied with the **BRAKE** ignition on, the Brake Light in the instrument cluster will come on.

NOTE:

- This light, when illuminated with parking brake application, shows only that the parking brake is on. It does not show the degree of brake application.

- If the light remains on with the parking brake released, a brake system malfunction is indicated. Have the brake system serviced by an authorized dealer immediately.
- If the parking brake is applied while the vehicle is moving, a chime will sound to alert the driver. The chime will sound up to 10 times or until the vehicle has returned to a stop.

Before leaving the vehicle, make sure that the parking brake is fully applied and the gear selector is in the PARK position.

To release the parking brake, slightly pull up the handle while pushing the lock button, and guide the lever downward to its stop. The brake warning light in the instrument cluster should go out.

NOTE: The parking brake lever will not release unless the lever is pulled up slightly past its applied position.

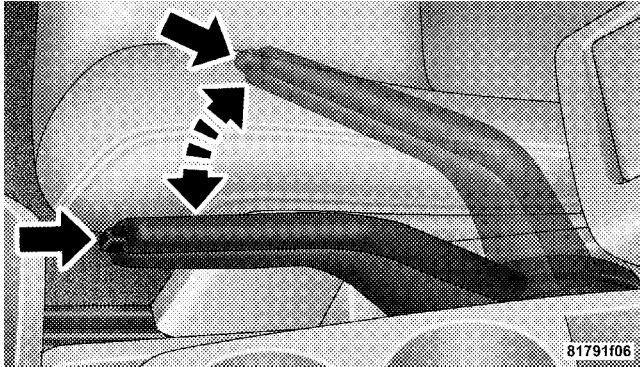

Parking Brake Lever

NOTE:

- When parking on a hill, it is important to set the parking brake **before** placing the gear selector in park, otherwise the load on the automatic transaxle locking mechanism may make it difficult to move the selector

out of park. As an added precaution, turn the front wheels toward the curb on a downhill grade and away from the curb on an uphill grade.

- You should always apply the parking brake before leaving the vehicle.

WARNING!

- **Never leave children alone in a vehicle. Leaving children in a vehicle unattended is dangerous for a number of reasons. A child or others could be injured. Don't leave the keys in the ignition. A child could operate power windows, other controls, or move the vehicle.**
- **Be sure the parking brake is fully disengaged before driving. Failure to do so can lead to brake failure and an accident.**

BRAKE SYSTEM

Your vehicle is equipped with power assisted brakes as standard equipment. In the event power assist is lost for any reason (i.e., repeated brake applications with the engine off) the brakes will still function. However, the effort required to brake the vehicle will be much greater than that required with the power system operating.

WARNING!

Riding the brakes can lead to brake failure and possibly an accident. Driving with your foot resting or riding on the brake pedal can result in abnormally high brake temperatures, excessive lining wear, and possible brake damage. You wouldn't have your full braking capacity in an emergency.



This light monitors various brake functions, including brake fluid level and parking brake application. If the brake light turns on, it may indicate that the parking brake is applied, that the brake fluid level is low, or that there is a problem with the anti-lock brake system.

WARNING!

Driving a vehicle with the brake light on is dangerous. A significant decrease in braking performance or vehicle stability during braking may occur. It will take you longer to stop the vehicle or will make your vehicle harder to control. You could have an accident. Have the vehicle checked immediately.

Anit-Lock Brake System (ABS)

The Anti-Lock Brake System provides increased vehicle stability and brake performance under most braking conditions. The system automatically “pumps” the brakes during severe braking conditions to prevent wheel lock-up.

WARNING!

Pumping of the Anti-Lock Brakes will diminish their effectiveness and may lead to an accident. Pumping makes the stopping distance longer. Just press firmly on your brake pedal when you need to slow down or stop.

WARNING!

- **Anti-lock system (ABS) cannot prevent the natural laws of physics from acting on the vehicle, nor can it increase braking or steering efficiency beyond that afforded by the condition of the vehicle brakes and tires or the traction afforded.**
- **The ABS cannot prevent accidents, including those resulting from excessive speed in turns, following another vehicle too closely, or hydroplaning. Only a safe, attentive, and skillful driver can prevent accidents.**
- **The capabilities of an ABS equipped vehicle must never be exploited in a reckless or dangerous manner, which could jeopardize the user’s safety or the safety of others.**



The ABS light monitors the Anti-Lock Brake System. The light will come on when the ignition switch is turned to the ON position and may stay on for as long as four seconds.

If the ABS light remains on or comes on while driving, it indicates that the Anti-Lock portion of the brake system is not functioning and that service is required. However, the conventional brake system will continue to operate normally if the BRAKE warning light is not on.

If the ABS light is on, the brake system should be serviced as soon as possible to restore the benefits of Anti-Lock brakes. If the ABS light does not come on when the ignition switch is turned to the ON position, have the bulb repaired as soon as possible.

If both the Brake Warning Light and the ABS Light remain on, the Anti-Lock brakes (ABS) and Electronic

Brake Force Distribution (EBD) systems are not functioning. Immediate repair to the ABS system is required. See your authorized Dealer Service Center.

When the vehicle is driven over 7 mph (11 km/h), you may also hear a slight clicking sound as well as some related motor noises. These noises are the system performing its self-check cycle to ensure that the ABS system is working properly. This self check occurs each time the vehicle is started and accelerated past 7 mph (11 km/h).

ABS is activated during braking under certain road or stopping conditions. ABS-inducing conditions can include ice, snow, gravel, bumps, railroad tracks, loose debris, or panic stops.

You also may experience the following when the brake system goes into Anti-lock:

- The ABS motor running (it may continue to run for a short time after the stop),

- the clicking sound of solenoid valves,
- brake pedal pulsations,
- and a slight drop or fall away of the brake pedal at the end of the stop.

These are all normal characteristics of ABS.

WARNING!

The Anti-Lock Brake System contains sophisticated electronic equipment that may be susceptible to interference caused by improperly installed or high output radio transmitting equipment. This interference can cause possible loss of anti-lock braking capability. Installation of such equipment should be performed by qualified professionals.

All vehicle wheels and tires must be the same size and type and tires must be properly inflated to produce accurate signals for the computer.

ELECTRONIC BRAKE CONTROL SYSTEMS – ABS/TCS/BAS/ESP

Your vehicle may be equipped with an optional advanced electronic brake control system that includes Anti-Lock Brake System (ABS), Traction Control System (TCS), Brake Assist System (BAS), and Electronic Stability Program (ESP). All systems work together to enhance vehicle stability and control in various driving conditions and are commonly referred to as ESP.

ANTI-LOCK BRAKE SYSTEM (ABS)

This system aids the driver in maintaining vehicle control under adverse braking conditions. The system controls hydraulic brake pressure to prevent wheel lock-up and

help avoid skidding on slippery surfaces during braking. Refer to “Anti-Lock Brake System” in this Section of the manual for more information about ABS.

TRACTION CONTROL SYSTEM (TCS)



This system monitors the amount of wheel spin of each of the driven wheels. If wheel spin is detected, brake pressure is applied to the slipping wheel(s) and engine power is reduced to provide enhanced acceleration and stability. A feature of the TCS system functions similar to a limited slip differential and controls the wheel spin across a driven axle. If one wheel on a driven axle is spinning faster than the other, the system will apply the brake of the spinning wheel. This will allow more engine torque to be applied to the wheel that is not spinning. This feature remains active even if TCS and ESP are in the “Partial Off” mode. Refer to “Electronic Stability Program (ESP)” in this Section of this manual.

BRAKE ASSIST SYSTEM (BAS)

The BAS is designed to optimize the vehicle’s braking capability during emergency braking maneuvers. The system detects an emergency braking situation by sensing the rate and amount of brake application and then applies optimum pressure to the brakes. This can help reduce braking distances. The BAS complements the Anti-Lock Brake System (ABS). Applying the brakes very quickly results in the best BAS assistance. To receive the benefit of the system, you must apply continuous braking pressure during the stopping sequence. Do not reduce brake pedal pressure unless braking is no longer desired. Once the brake pedal is released, the BAS is deactivated.

WARNING!

- **BAS cannot prevent the natural laws of physics from acting on the vehicle, nor can it increase braking efficiency beyond that afforded by the condition of the vehicle brakes and tires or the traction afforded.**
- **The BAS cannot prevent accidents, including those resulting from excessive speed in turns, following another vehicle too closely, or hydroplaning. Only a safe, attentive, and skillful driver can prevent accidents.**
- **The capabilities of a BAS-equipped vehicle must never be exploited in a reckless or dangerous manner, which could jeopardize the user's safety or the safety of others.**

ELECTRONIC STABILITY PROGRAM (ESP)

This system enhances directional control and stability of the vehicle under various driving conditions. ESP corrects for over/under steering of the vehicle by applying the brake of the appropriate wheel to assist in counteracting the over/under steer condition. Engine power may also be reduced to help the vehicle maintain the desired path. ESP uses sensors in the vehicle to determine the vehicle path intended by the driver and compares it to the actual path of the vehicle. When the actual path does not match the intended path, ESP applies the brake of the appropriate wheel to assist in counteracting the oversteer or understeer condition

- **Oversteer** - when the vehicle is turning more than appropriate for the steering wheel position.
- **Understeer** - when the vehicle is turning less than appropriate for the steering wheel position.

ESP/TCS Indicator Light

The “ESP/TCS Indicator Light, located in the instrument cluster, starts to flash as soon as the tires lose traction and the ESP system becomes active. The ESP/TCS Indicator Light also flashes when TCS is active. If the ESP/TCS Indicator Light begins to flash during acceleration, ease up on the accelerator and apply as little throttle as possible. Be sure to adapt your speed and driving to the prevailing road conditions.

WARNING!

- **Electronic Stability Program (ESP) cannot prevent the natural laws of physics from acting on the vehicle, nor can it increase the traction afforded by prevailing road conditions.**
- **ESP cannot prevent accidents, including those resulting from excessive speed in turns, driving on very slippery surfaces, or hydroplaning. Only a safe, attentive, and skillful driver can prevent accidents.**
- **The capabilities of an ESP-equipped vehicle must never be exploited in a reckless or dangerous manner, which could jeopardize the user’s safety or the safety of others.**

ESP Operating Modes

All ESP equipped vehicles can choose the following ESP operating modes:

ESP ON

This is the normal operating mode for ESP. Whenever the vehicle is started the ESP system will be in this mode. This mode should be used for almost all driving situations. ESP should only be turned to Partial Off for specific reasons as noted below.

PARTIAL ESP Mode

This mode is entered by momentarily depressing the ESP Control Switch. When in Partial Off mode, the TCS portion of ESP, except for the limited slip feature described in the TCS section, has been disabled and the ESP/TCS Indicator Light will be illuminated. All other stability features of ESP function normally, with the exception of engine power reduction. This mode is intended to be used if the vehicle is in deep snow, sand,

or gravel conditions and more wheel spin than ESP would normally allow is required to gain traction.

To turn ESP on again, momentarily depress the ESP Control Switch. This will restore the normal ESP On mode of operation.

WARNING!

In the Partial ESP mode, the engine torque reduction and stability features are desensitized. Therefore, the enhanced vehicle stability offered by ESP is unavailable.

5

NOTE: To improve the vehicle's traction when driving with snow chains, or starting off in deep snow, sand or gravel, it may be desirable to switch to the "Partial Off" mode by pressing the ESP switch. Once the situation requiring ESP to be switched to the "Partial Off" mode is

overcome, turn ESP on again by momentarily depressing the “ESP Control Switch.” This may be done while the vehicle is in motion.

ESP/BAS Warning Light and ESP/TCS Indicator Light

**ESP
BAS** The malfunction indicator for the ESP is combined with the BAS indicator. The yellow ESP/BAS Warning Light and the yellow ESP/TCS Indicator Light in the instrument cluster both come on when the ignition switch is turned to the ON position. They should both go out with the engine running. If the ESP/BAS Warning Light comes on continuously with the engine running, a malfunction has been detected in either the ESP or BAS system, or both. If this light remains on after several ignition cycles, and the vehicle has been driven several miles (kilometers) at speeds greater than 30 mph (48 km/h), see your authorized dealer as soon as possible to have the problem diagnosed and corrected.

NOTE:

- The ESP Indicator Light and the ESP/BAS Warning Light come on momentarily each time the ignition switch is turned ON.
- Each time the ignition is turned ON, the ESP System will be ON even if it was turned off previously.
- The ESP Control System will make buzzing or clicking sounds when it is active. This is normal; the sounds will stop when ESP becomes inactive following the maneuver that caused the ESP activation.

POWER STEERING

The standard power steering system will give you good vehicle response and increased ease of maneuverability in tight spaces. The system will provide mechanical steering capability if power assist is lost.

If for some reason the power assist is interrupted, it will still be possible to steer your vehicle. Under these conditions, you will observe a substantial increase in steering effort, especially at very low vehicle speeds and during parking maneuvers.

NOTE: Increased noise levels at the end of the steering wheel travel are considered normal and do not indicate that there is a problem with the power steering system.

Upon initial start-up in cold weather, the power steering pump may make noise for a short amount of time. This is due to the cold, thick fluid in the steering system. This noise should be considered normal, and it does not in any way damage the steering system.

WARNING!

Continued operation with reduced power steering assist could pose a safety risk to yourself and others. Service should be obtained as soon as possible.

CAUTION!

Prolonged operation of the steering system at the end of the steering wheel travel will increase the steering fluid temperature and it should be avoided when possible. Damage to the power steering pump may occur.

DRIVING ON SLIPPERY SURFACES

ACCELERATION

Rapid acceleration on snow covered, wet, or other slippery surfaces may cause the front wheels to pull erratically to the right or left. This phenomenon occurs when there is a difference in the surface traction under the front (driving) wheels.

WARNING!

Rapid acceleration on slippery surfaces is dangerous. Unequal traction can cause sudden pulling of the front wheels. You could lose control of the vehicle and possibly have an accident. Accelerate slowly and carefully whenever there is likely to be poor traction (ice, snow, wet, mud, loose sand, etc.).

TRACTION

When driving on wet or slushy roads, it is possible for a wedge of water to build up between the tire and road surface. This is hydroplaning and may cause partial or complete loss of vehicle control and stopping ability. To reduce this possibility, the following precautions should be observed:

1. Slow down during rainstorms or when roads are slushy.
2. Slow down if the road has standing water or puddles.
3. Replace the tires when tread wear indicators first become visible.
4. Keep the tires properly inflated.
5. Maintain enough distance between your vehicle and the vehicle in front of you to avoid a collision in a sudden stop.

DRIVING THROUGH WATER

Driving through water more than a few inches/centimeters deep will require extra caution to ensure safety and prevent damage to your vehicle.

Flowing/Rising Water

WARNING!

Do not drive on, or cross, a road or a path where water is flowing and/or rising (as in storm run-off). Flowing water can wear away the road or path's surface and cause your vehicle to sink into deeper water. Furthermore, flowing and/or rising water can carry your vehicle away swiftly. Failure to follow this warning may result in injuries that are serious or fatal to you, your passengers, and others around you.

Shallow Standing Water

Although your vehicle is capable of driving through shallow standing water, consider the following Caution and Warning before doing so.

CAUTION!

- Always check the depth of the standing water before driving through it. Never drive through standing water that is deeper than the bottom of the tire rims mounted on the vehicle.
- Determine the condition of the road or the path that is under water, and if there are any obstacles in the way, before driving through the standing water.
- Do not exceed 5 mph (8 km/h) when driving through standing water. This will minimize wave effects.

CAUTION!

- Driving through standing water may cause damage to your vehicle's drivetrain components. Always inspect your vehicle's fluids (i.e., engine oil, transmission, axle, etc.) for signs of contamination (i.e., fluid that is milky or foamy in appearance) after driving through standing water. Do not continue to operate the vehicle if any fluid appears contaminated, as this may result in further damage. Such damage is not covered by the New Vehicle Limited Warranty.
- Getting water inside your vehicle's engine can cause it to lock up and stall out, and cause serious internal damage to the engine. Such damage is not covered by the New Vehicle Limited Warranty.

WARNING!

- Driving through standing water limits your vehicle's traction capabilities. Do not exceed 5 mph (8 km/h) when driving through standing water.
- Driving through standing water limits your vehicle's braking capabilities, which increases stopping distances. Therefore, after driving through standing water, drive slowly and lightly press on the brake pedal several times to dry the brakes.
- Getting water inside your vehicle's engine can cause it to lock up and stall out, and leave you stranded.
- Failure to follow these warnings may result in injuries that are serious or fatal to you, your passengers, and others around you.

TIRE SAFETY INFORMATION

Tire Markings

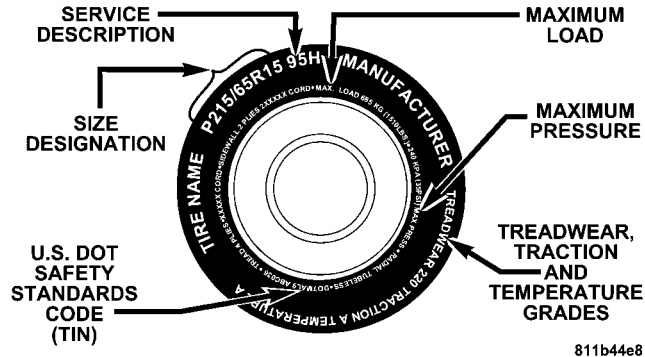

NOTE:

- P (Passenger) - Metric tire sizing is based on U.S. design standards. P-Metric tires have the letter "P" molded into the sidewall preceding the size designation. Example: P215/65R15 95H.

- European-Metric tire sizing is based on European design standards. Tires designed to this standard have the tire size molded into the sidewall beginning with the section width. The letter "P" is absent from this tire size designation. Example: 215/65R15 96H.
- LT (Light Truck) - Metric tire sizing is based on U.S. design standards. The size designation for LT-Metric tires is the same as for P-Metric tires except for the letters "LT" that are molded into the sidewall preceding the size designation. Example: LT235/85R16.
- Temporary spare tires are high-pressure compact spares designed for temporary emergency use only. Tires designed to this standard have the letter "T" molded into the sidewall preceding the size designation. Example: T145/80D18 103M.
- High flotation tire sizing is based on U.S. design standards, and it begins with the tire diameter molded into the sidewall. Example: 31x10.5 R15 LT.

Tire Sizing Chart

Tire Sizing Chart	
P	Passenger Car tire size based on U.S. design standards
"...blank..."	Passenger Car tire based on European design standards
LT	Light Truck tire based on U.S. design standards
T	Temporary spare tire
31	Overall diameter in inches (in)
215	Section width in millimeters (mm)
65	Aspect Ratio of section height to section width of tire, written in percent (%)
10.5	Section width in inches (in)
R	"R" means radial construction
	"D" means diagonal or bias construction
15	Rim diameter in inches (in)

Tire Sizing Chart	
95	Load Index (a numerical code associated with the maximum load a tire can carry)
H	A symbol indicating the range of speeds at which a tire can carry a load corresponding to its load index under certain operating conditions
	The maximum speed corresponding to the speed symbol should only be achieved under specified operating conditions (i.e., tire pressure, vehicle loading, road conditions, and posted speed limits)
"...blank..."	<ul style="list-style-type: none"> • Absence of any text on the sidewall of the tire indicates a Standard Load (SL) Tire • Extra Load (XL) = Extra load (or reinforced) tire • Light Load = Light load tire • C, D, E = Load range associated with the maximum load a tire can carry at a specified pressure
Maximum Load	Maximum load indicates the maximum load this tire is designed to carry
Maximum Pressure	Maximum pressure indicates the maximum permissible cold tire inflation pressure for this tire

Tire Identification Number (TIN)

The TIN may be found on one or both sides of the tire, however, the date code may only be on one side. Tires with white sidewalls will have the full TIN, including the date code,

located on the white sidewall side of the tire. Look for the TIN on the outboard side of black sidewall tires as mounted on the vehicle. If the TIN is not found on the outboard side, then you will find it on the inboard side of the tire.

Tire Identification Number	
EXAMPLE: DOT MA L9 ABCD 0301	
DOT	Department of Transportation — This symbol certifies that the tire is in compliance with the U.S. Department of Transportation tire safety standards, and is approved for highway use
MA	Code representing the tire manufacturing location (two digits)
L	Code representing the tire size (two digits)
ABCD	Code used by the tire manufacturer (one to four digits)
03	Two digit number representing the week in which the tire was manufactured (03 means the 3rd week)
01	Two digit number representing the year in which the tire was manufactured (01 means the year 2001) ¹
¹ Prior to July 2000, tire manufacturers were only required to have one number to represent the year in which the tire was manufactured. Example: 031 could represent the 3rd week of 1981 or 1991	

Tire Loading and Tire Pressure

Tire Placard Location

NOTE: The proper cold tire inflation pressure is listed on either the face of the driver's door or the driver's side B-Pillar.

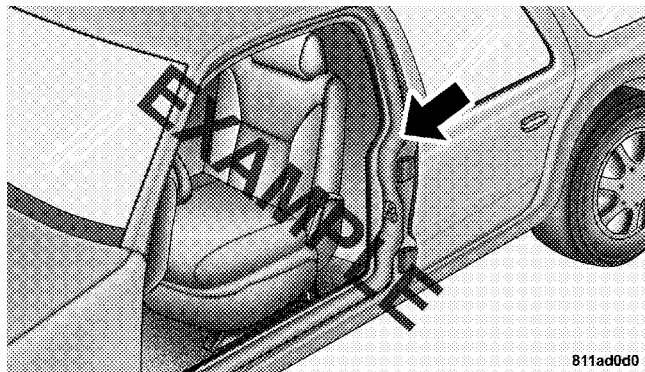

Tire Placard Location

Tire and Loading Information Placard

TIRE AND LOADING INFORMATION			
SEATING CAPACITY - TOTAL 5 FRONT 2 REAR 3			
THE COMBINED WEIGHT OF OCCUPANTS AND CARGO SHOULD NEVER EXCEED XXX KG OR XXX LBS.			
TIRE	FRONT	REAR	SPARE
ORIGINAL TIRE SIZE	P195/70R14	P195/70R14	T125/70D15
COLD TIRE INFLATION PRESSURE	200kPa, 29PSI	200kPa, 29PSI	420kPa, 60PSI
SEE OWNER'S MANUAL FOR ADDITIONAL INFORMATION			4N109268

811b5a9a

Tire and Loading Information Placard

This placard tells you important information about the:

- 1) number of people that can be carried in the vehicle
- 2) total weight your vehicle can carry
- 3) tire size designed for your vehicle
- 4) cold tire inflation pressures for the front, rear, and spare tires.

Loading

The vehicle maximum load on the tire must not exceed the load carrying capacity of the tire on your vehicle. You will not exceed the tire's load carrying capacity if you adhere to the loading conditions, tire size, and cold tire inflation pressures specified on the Tire and Loading Information placard and in the "Vehicle Loading" section of this manual.

NOTE: Under a maximum loaded vehicle condition, gross axle weight ratings (GAWRs) for the front and rear axles must not be exceeded. For further information on GAWRs, vehicle loading, and trailer towing, refer to "Vehicle Loading" in this section.

To determine the maximum loading conditions of your vehicle, locate the statement, "The combined weight of occupants and cargo should never exceed XXX kg or XXX lbs." on the Tire and Loading Information placard. The

combined weight of occupants, cargo/luggage and trailer tongue weight (if applicable) should never exceed the weight referenced here.

Steps for Determining Correct Load Limit

1. Locate the statement, "The combined weight of occupants and cargo should never exceed XXX kg or XXX lbs" on your vehicle's placard.
2. Determine the combined weight of the driver and passengers that will be riding in your vehicle.
3. Subtract the combined weight of the driver and passengers from XXX kg or XXX lbs.
4. The resulting figure equals the available amount of cargo and luggage load capacity. For example, if "XXX" amount equals 1,400 lbs (635 kg) and there will be five each 150 lb (68 kg) passengers in your vehicle, the

amount of available cargo and luggage load capacity is 650 lbs (295 kg) (since $5 \times 150 = 750$, and $1400 - 750 = 650$ lbs [295 kg]).

5. Determine the combined weight of luggage and cargo being loaded on the vehicle. That weight may not safely exceed the available cargo and luggage load capacity calculated in Step 4.

6. If your vehicle will be towing a trailer, load from your trailer will be transferred to your vehicle. Consult this manual to determine how this reduces the available cargo and luggage load capacity of your vehicle.

NOTE: The following table shows examples on how to calculate total load, cargo/luggage, and towing capacities of your vehicle with varying seating configurations and number and size of occupants. This table is for illustration purposes only and may not be accurate for the seating and load carrying capacity of your vehicle.

NOTE: For the following example, the combined weight of occupants and cargo should never exceed 865 lbs (392 kg).

Occupants			Combined weight of occupants and cargo from Tire Placard	MINUS	Combined Occupant's weight	=	AVAILABLE Cargo/Luggage and Trailer Tongue Weight
TOTAL	FRONT	REAR					
<u>EXAMPLE 1</u>			865 lbs	minus	670 lbs	=	195 lbs
5	2	3					
<u>EXAMPLE 2</u>			865 lbs	minus	540 lbs	=	325 lbs
3	2	1					
<u>EXAMPLE 3</u>			865 lbs	minus	400 lbs	=	465 lbs
2	2	0					

Occupant 1: 200 lbs
Occupant 2: 130 lbs
Occupant 3: 160 lbs
Occupant 4: 100 lbs
Occupant 5: 80 lbs
TOTAL WEIGHT: 670 lbs

Occupant 1: 210 lbs
Occupant 2: 180 lbs
Occupant 3: 150 lbs
TOTAL WEIGHT: 540 lbs

Occupant 1: 200 lbs
Occupant 2: 200 lbs
TOTAL WEIGHT: 400 lbs

811a4d11

WARNING!

Overloading of your tires is dangerous. Overloading can cause tire failure, affect vehicle handling, and increase your stopping distance. Use tires of the recommended load capacity for your vehicle. Never overload them.

TIRES — GENERAL INFORMATION**Tire Pressure**

Proper tire inflation pressure is essential to the safe and satisfactory operation of your vehicle. Three primary areas are affected by improper tire pressure:

1. Safety—**WARNING!**

- Improperly inflated tires are dangerous and can cause accidents.
- Under inflation increases tire flexing and can result in tire failure.
- Over inflation reduces a tire's ability to cushion shock. Objects on the road and chuckholes can cause damage that result in tire failure.
- Unequal tire pressures can cause steering problems. You could lose control of your vehicle.
- Over inflated or under inflated tires can affect vehicle handling and can fail suddenly, resulting in loss of vehicle control.
- Unequal tire pressures from one side of the vehicle to the other can cause the vehicle to drift to the right or left.
- Always drive with each tire inflated to the recommended cold tire inflation pressure.

2. *Economy*—

Improper inflation pressures can cause uneven wear patterns to develop across the tire tread. These abnormal wear patterns will reduce tread life resulting in a need for earlier tire replacement. Under inflation, also increases tire rolling resistance and results in higher fuel consumption.

3. *Ride Comfort and Vehicle Stability*—

Proper tire inflation contributes to a comfortable ride. Over inflation produces a jarring and uncomfortable ride.

Tire Inflation Pressures

The proper cold tire inflation pressure is listed either on the face of the driver's door or on the driver's side "B" pillar.

Some vehicles may have Supplemental Tire Pressure Information for vehicle loads that are less than the

maximum loaded vehicle condition. These pressure conditions will be found in the "Supplemental Tire Pressure Information" section of this manual.

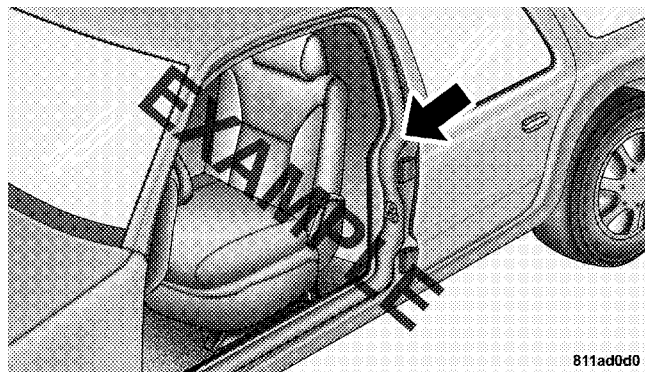

Tire Placard Location

The pressure should be checked and adjusted as well as inspecting for signs of tire wear or visible damage at least once a month. Use a good quality pocket-type gauge to

check tire pressure. Do not make a visual judgement when determining proper inflation. Radial tires may look properly inflated even when they are under inflated.

CAUTION!

After inspecting or adjusting the tire pressure, always reinstall the valve stem cap (if equipped). This will prevent moisture and dirt from entering the valve stem, which could damage the valve stem.

Inflation pressures specified on the placard are always “cold tire inflation pressure.” Cold tire inflation pressure is defined as the tire pressure after the vehicle has not been driven for at least 3 hours, or driven less than 1 mile (1 km) after a 3 hour period. The cold tire inflation pressure must not exceed the maximum inflation pressure molded into the tire sidewall.

Check tire pressures more often if subject to a wide range of outdoor temperatures, as tire pressures vary with temperature changes.

Tire pressures change by approximately 1 psi (7 kPa) per 12° F (7° C) of air temperature change. Keep this in mind when checking tire pressure inside a garage, especially in the winter.

Example: If garage temperature = 68° F (20° C) and the outside temperature = 32° F (0° C) then the cold tire inflation pressure should be increased by 3 psi (21 kPa), which equals 1 psi (7 kPa) for every 12° F (7° C) for this outside temperature condition.

Tire pressure may increase from 2 to 6 psi (13 to 40 kPa) during operation. DO NOT reduce this normal pressure build up or your tire pressure will be too low.

Tire Pressures for High Speed Operation

The manufacturer advocates driving at safe speeds within posted speed limits. Where speed limits or conditions are such that the vehicle can be driven at high speeds, maintaining correct tire inflation pressure is very important. Increased tire pressure and reduced vehicle loading may be required for high-speed vehicle operation. Refer to original equipment or an authorized tire dealer for recommended safe operating speeds, loading and cold tire inflation pressures.

WARNING!

High speed driving with your vehicle under maximum load is dangerous. The added strain on your tires could cause them to fail. You could have a serious accident. Don't drive a vehicle loaded to the maximum capacity at continuous speeds above 75 mph (120 km/h).

Radial-Ply Tires

WARNING!

Combining radial ply tires with other types of tires on your vehicle will cause your vehicle to handle poorly. The instability could cause an accident. Always use radial ply tires in sets of four (or 6, in case of trucks with dual rear wheels). Never combine them with other types of tires.

Cuts and punctures in radial tires are repairable only in the tread area because of sidewall flexing. Consult your authorized tire dealer for radial tire repairs.

Compact Spare Tire — If Equipped

The compact spare is for temporary emergency use with radial tires. It is engineered to be used on your style vehicle only. Since this tire has limited tread life, the original tire should be repaired (or replaced) and reinstalled at the first opportunity.

WARNING!

Temporary use spare tires are for emergency use only. With these tires, do not drive more than 50 mph (80 km/h). Temporary-use spare tires have limited tread life. When the tread is worn to the tread wear indicators, the temporary use spare tire needs to be replaced. Be sure to follow the warnings, which apply to your spare. Failure to do so could result in spare tire failure and loss of vehicle control.

CAUTION!

Prolonged use of limited use spare, or an incorrect tire size on either front wheel, may damage transaxle differential and result in loss of vehicle mobility.

Do not install a wheel cover or attempt to mount a conventional tire on the compact spare wheel, since the wheel is designed specifically for the compact spare.

Do not install more than one compact spare tire/wheel on the vehicle at any given time.

CAUTION!

Because of the reduced ground clearance, do not take your vehicle through an automatic car wash with the compact spare installed. Damage to the vehicle may result.

Limited Use Spare — If Equipped

The limited use spare tire is for temporary emergency use on your vehicle. This tire is identified by a limited use spare tire warning label located on the limited use spare tire and wheel assembly. This tire may look like the original equipped tire on the front or rear axle of your vehicle, but it is not. Installation of this limited use spare tire affects vehicle handling. Since it is not the same tire, replace (or repair) the original tire and reinstall on the vehicle at the first opportunity.

WARNING!

The limited use spare tires are for emergency use only. Installation of this limited use spare tire affects vehicle handling. With this tire, do not drive more than 50 mph (80 km/h). Keep inflated to the cold tire inflation pressure listed on either your tire placard or limited use spare tire and wheel assembly. Replace (or repair) the original tire at the first opportunity and reinstall it on your vehicle. Failure to do so could result in loss of vehicle control.

WARNING!

Prolonged use of limited use spare, or incorrect tire size of front wheel, may damage the transaxle differential and result in loss of vehicle mobility and could result in loss of vehicle control.

Tire Spinning

When stuck in mud, sand, snow, or ice conditions, do not spin your vehicle's wheels faster than 30 mph (48 km/h) or for longer than 30 seconds continuously without stopping when you are stuck.

Refer to "Freeing A Stuck Vehicle" in Section 6 of this manual for additional information.

WARNING!

Fast spinning tires can be dangerous. Forces generated by excessive wheel speeds may cause tire damage or failure. A tire could explode and injure someone. Do not spin your vehicle's wheels faster than 30 mph (48 km/h) or for more than 30 seconds continuously when you are stuck, and don't let anyone near a spinning wheel, no matter what the speed.

Tread Wear Indicators

Tread wear indicators are in the original equipment tires to help you in determining when your tires should be replaced.

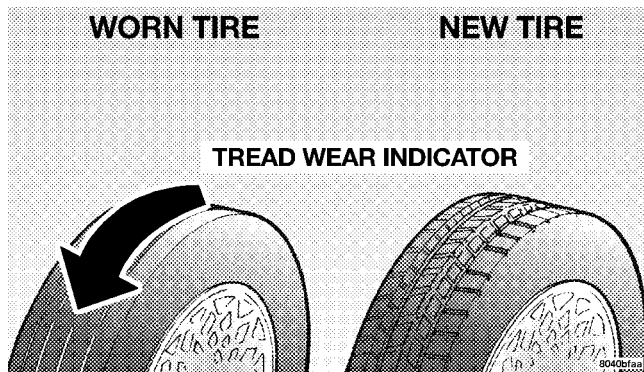

These indicators are molded into the bottom of the tread grooves. They will appear as bands when the tread depth

becomes approximately 1/16 in (2 mm). When the tread is worn to the tread wear indicators, the tire should be replaced.

Life of Tire

The service life of a tire is dependent upon varying factors including but not limited to:

- Driving style
- Tire pressure
- Distance driven

WARNING!

Tires and spare tire should be replaced after six years, regardless of the remaining tread. Failure to follow this warning can result in sudden tire failure. You could lose control and have an accident resulting in serious injury or death.

Keep dismantled tires in a cool, dry place with as little exposure to light as possible. Protect tires from contact with oil, grease, and gasoline.

Replacement Tires

The tires on your new vehicle provide a balance of many characteristics. They should be inspected regularly for wear and correct cold tire inflation pressure. The manufacturer strongly recommends that you use tires equivalent to the originals in size, quality and performance when replacement is needed (refer to the paragraph on “Tread Wear Indicators”). Refer to the “Tire and Loading Information” placard for the size designation of your tire. The service description and load identification will be found on the original equipment tire. Failure to use equivalent replacement tires may adversely affect the safety, handling, and ride of your vehicle. We recommend that you contact your original equipment or an authorized tire dealer with any questions you may have on tire specifications or capability.

WARNING!

Do not use a tire, wheel size or rating other than that specified for your vehicle. Some combinations of unapproved tires and wheels may change suspension dimensions and performance characteristics, resulting in changes to steering, handling, and braking of your vehicle. This can cause unpredictable handling and stress to steering and suspension components. You could lose control and have an accident resulting in serious injury or death. Use only the tire and wheel sizes with load ratings approved for your vehicle.

WARNING!

- **Never use a tire with a smaller load index or capacity, other than what was originally equipped on your vehicle. Using a tire with a smaller load index could result in tire overloading and failure. You could lose control and have an accident.**
- **Failure to equip your vehicle with tires having adequate speed capability can result in sudden tire failure and loss of vehicle control.**

CAUTION!

Replacing original tires with tires of a different size may result in false speedometer and odometer readings.

Alignment And Balance

Poor suspension alignment may result in:

- Fast tire wear.
- Uneven tire wear, such as feathering and one-sided wear.
- Vehicle pull to right or left.

Tires may also cause the vehicle to pull to the left or right. Alignment will not correct this condition. See your dealer for proper diagnosis.

Improper alignment will not cause vehicle vibration. Vibration may be a result of tire and wheel out-of-balance. Proper balancing will reduce vibration and avoid tire cupping and spotty wear.

TIRE CHAINS

Due to limited clearance, tire chains are not recommended.

CAUTION!

Damage to the vehicle may result if tire chains are used.

SNOW TIRES

Some areas of the country require the use of snow tires during Winter. Standard tires are of the all-season type and satisfy this requirement as indicated by the M+S designation on the tire sidewall.

If you need snow tires, select tires equivalent in size and type to the original equipment tires. Use snow tires only in sets of four; failure to do so may adversely affect the safety and handling of your vehicle.

Snow tires generally have lower speed ratings than what was originally equipped with your vehicle and should not be operated at sustained speeds over 75 mph (120 km/h).

TIRE ROTATION RECOMMENDATIONS

Tires on the front and rear axles of vehicles operate at different loads and perform different steering, driving, and braking functions. For these reasons, they wear at unequal rates and tend to develop irregular wear patterns. These effects can be reduced by timely rotation of tires. The benefits of rotation are especially worthwhile with aggressive tread designs such as those on all season type tires. Rotation will increase tread life, help to maintain mud, snow, and wet traction levels, and contribute to a smooth, quiet ride.

Follow the Maintenance Schedule in Section 8 for the recommended tire rotation frequency. Remember, more frequent rotation is permissible if desired. Also, correct for anything causing rapid or unusual wear prior to performing the tire rotation.

The suggested rotation method is the “forward-cross” shown in the following diagram.

TIRE ROTATION PATTERN

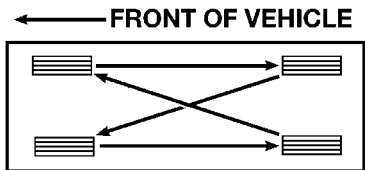

4 TIRE ROTATION

80ba79fe

TIRE PRESSURE MONITOR SYSTEM (TPMS) — IF EQUIPPED

- The Tire Pressure Monitor System (TPMS) will warn the driver of a low tire pressure based on the vehicle recommended cold placard pressure.
- The tire pressure will vary with temperature by about 1 psi (7 kPa) for every 12 F (7 C). This means that when the outside temperature decreases, the tire pressure will decrease. Tire pressure should always be set based on cold inflation tire pressure. This is defined as the tire pressure after the vehicle has not been driven for at least three hours, or driven less than 1 mi (1 km) after a three hour period. The cold tire inflation pressure must not exceed the maximum inflation pressure molded into the tire sidewall. Refer to the “Tires – General Information” in this section for information on how to properly inflate the vehicle’s tires. The tire

pressure will also increase as the vehicle is driven - this is normal and there should be no adjustment for this increased pressure.

- The TPM System will warn the driver of a low tire pressure if the tire pressure falls below the low-pressure warning limit for any reason, including low temperature effects and natural pressure loss through the tire.
- The TPM System will continue to warn the driver of low tire pressure as long as the condition exists, and will not turn off until the tire pressure is at or above the recommended cold placard pressure. Once the low tire pressure warning (Tire Pressure Monitoring Telltale Light) illuminates, you must increase the tire pressure to the recommended cold placard pressure in order for the Tire Pressure Monitoring Telltale Light to turn off. The system will automatically update and the Tire Pressure Monitoring Telltale Light will turn off

once the system receives the updated tire pressures. The vehicle may need to be driven for up to 10 minutes above 15 mph (25 km/h) in order for the TPMS to receive this information.

- For example, your vehicle may have a recommended cold (parked for more than three hours) placard pressure of 30 psi (207 kPa). If the ambient temperature is 68 F (20 C) and the measured tire pressure is 27 psi (186 kPa), a temperature drop to 20 F (-7 C) will decrease the tire pressure to approximately 23 psi (157 kPa). This tire pressure is sufficiently low enough to turn ON the Tire Pressure Monitoring Telltale Light. Driving the vehicle may cause the tire pressure to rise to approximately 27 psi (186 kPa), but the Tire Pressure Monitoring Telltale Light will still be ON. In this situation, the Tire Pressure Monitoring Telltale Light will turn OFF only after the tires are inflated to the vehicle's recommended cold placard pressure value.

CAUTION!

- **The TPMS has been optimized for the original equipment tires and wheels. TPMS pressures and warning have been established for the tire size equipped on your vehicle. Undesirable system operation or sensor damage may result when using replacement equipment that is not of the same size, type, and/or style. Aftermarket wheels can cause sensor damage. Do not use aftermarket tire sealants or balance beads if your vehicle is equipped with a TPMS, as damage to the sensors may result.**
- **After inspecting or adjusting the tire pressure, always reinstall the valve stem cap. This will prevent moisture and dirt from entering the valve stem, which could damage the Tire Pressure Monitoring Sensor.**

NOTE:

- The TPMS is not intended to replace normal tire care and maintenance, or to provide warning of a tire failure or condition.
- The TPMS should not be used as a tire pressure gauge while adjusting your tire pressure.
- Driving on a significantly under-inflated tire causes the tire to overheat and can lead to tire failure. Under-inflation also reduces fuel efficiency and tire tread life, and may affect the vehicle's handling and stopping ability.
- The TPMS is not a substitute for proper tire maintenance, and it is the driver's responsibility to maintain correct tire pressure using an accurate tire pressure gauge, even if under-inflation has not reached the level to trigger illumination of the Tire Pressure Monitoring Telltale light.

- Seasonal temperature changes will affect tire pressure, and the TPMS will monitor the actual tire pressure in the tire.

BASE SYSTEM — IF EQUIPPED

The Tire Pressure Monitor System (TPMS) uses wireless technology with wheel rim mounted electronic sensors to monitor tire pressure levels. Sensors, mounted to each wheel as part of the valve stem, transmit tire pressure readings to the Receiver Module.

NOTE: It is particularly important for you to check the tire pressure in all of the tires on your vehicle monthly and to maintain the proper pressure.

The TPMS consists of the following components:

- Receiver Module
- Four Tire Pressure Monitoring Sensors
- Tire Pressure Monitoring Telltale Light

Tire Pressure Monitoring Low Pressure Warnings



The Tire Pressure Monitoring Telltale Light will illuminate in the instrument cluster and a chime will sound when tire pressure is low in one or more of the four active road tires. Should this occur, you should stop as soon as possible, check the inflation pressure of each tire on your vehicle, and inflate each tire to the vehicle's recommended cold placard pressure value. Once the system receives the updated tire pressures, the system will automatically update and the Tire Pressure Monitoring Telltale Light will turn off. The vehicle may need to be driven for up to 10 minutes above 15 mph (25 km/h) in order for the TPMS to receive this information.

Check TPMS Warning

The Tire Pressure Monitoring Telltale Light will flash on and off for 75 seconds and then remain on solid when a system fault is detected. The system fault will also sound a chime. If the ignition key is cycled, this sequence will

repeat, providing the system fault still exists. The Tire Pressure Monitoring Telltale Light will turn off when the fault condition no longer exists. A system fault can occur due to any of the following:

1. Jamming due to electronic devices or driving next to facilities emitting the same Radio Frequencies as the TPM sensors.
2. Installing some form of aftermarket window tinting that affects radio wave signals.
3. Lots of snow or ice around the wheels or wheel housings.
4. Using tire chains on the vehicle.
5. Using wheels/tires not equipped with TPM sensors.

NOTE:

1. The compact spare tire (if so equipped) does not have a tire pressure monitoring sensor. Therefore, the TPMS will not monitor the pressure in the compact spare tire.

2. If you install the compact spare tire in place of a road tire that has a pressure below the low-pressure warning limit, upon the next ignition key cycle, a chime will sound and the TPM Telltale Light will turn ON.

3. After driving the vehicle for up to 10 minutes above 15 mph (25 km/h), the TPM Telltale Light will flash on and off for 75 seconds and then remain on solid.

4. For each subsequent ignition key cycle, a chime will sound and the TPM Telltale Light will flash on and off for 75 seconds and then remain on solid.

5. Once you repair or replace the original road tire, and reinstall it on the vehicle in place of the compact spare, the TPMS will update automatically and the TPM Telltale Light will turn OFF, as long no tire pressure is below the low-pressure warning limit in any of the four active road tires. The vehicle may need to be driven for up to 10 minutes above 15 mph (25 km/h) in order for the TPMS to receive this information.

PREMIUM SYSTEM — IF EQUIPPED

The Tire Pressure Monitor System (TPMS) uses wireless technology with wheel rim mounted electronic sensors to monitor tire pressure levels. Sensors, mounted to each wheel as part of the valve stem, transmit tire pressure readings to the Receiver Module.

NOTE: It is particularly important for you to check the tire pressure in all of the tires on your vehicle monthly and to maintain the proper pressure.

The TPMS consists of the following components:

- Receiver Module
- Four Tire Pressure Monitoring Sensors
- Three Trigger Modules (mounted in three of the four wheel-wells)
- Various Tire Pressure Monitoring System Messages, which display in the Electronic Vehicle Information Center (EVIC)
- Tire Pressure Monitoring Telltale Light

Tire Pressure Monitoring Low Pressure Warnings

 The Tire Pressure Monitoring Telltale Light will illuminate in the instrument cluster and a chime will sound when tire pressure is low in one or more of the four active road tires. In addition, the Electronic Vehicle Information Center (EVIC) will display a graphic showing the pressure values of each tire with the low tire pressure values flashing.

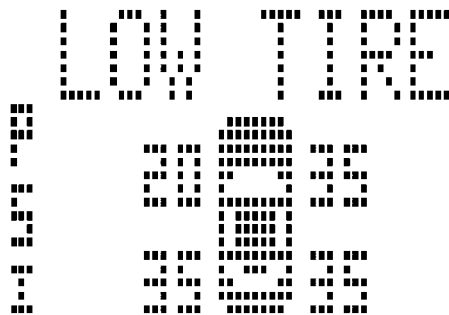

81826bed

Should this occur, you should stop as soon as possible, and inflate the tires with low pressure (those flashing in the EVIC graphic) to the vehicle's recommended cold placard pressure value. Once the system receives the updated tire pressures, the system will automatically update, the graphic display in the EVIC will stop flashing, and the Tire Pressure Monitoring Telltale Light will

turn off. The vehicle may need to be driven for up to 10 minutes above 15 mph (25 km/h) in order for the TPMS to receive this information.

Check TPMS Warning

When a system fault is detected, a chime will sound and the Tire Pressure Monitoring Telltale Light will flash on and off for 75 seconds and then remain on solid. In addition, the EVIC will display a "CHECK TPM SYSTEM" message for three seconds and then display dashes (- -) in place of the pressure value to indicate which sensor is not being received.

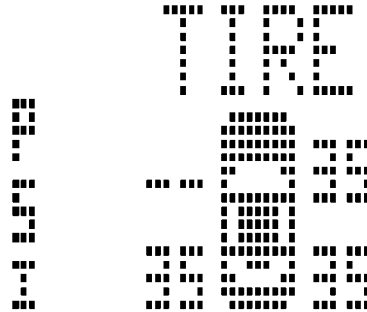

81826bd7

If the ignition key is cycled, this sequence will repeat, providing the system fault still exists. If the system fault no longer exists, the Tire Pressure Monitoring Telltale Light will no longer flash, and the "CHECK TPM SYSTEM" message will no longer display, and a pressure value will display in place of the dashes. A system fault can occur due to any of the following:

1. Jamming due to electronic devices or driving next to facilities emitting the same Radio Frequencies as the TPM sensors.
2. Installing some form of aftermarket window tinting that affects radio wave signals.
3. Lots of snow or ice around the wheels or wheel housings.
4. Using tire chains on the vehicle.
5. Using wheels/tires not equipped with TPM sensors.

NOTE:

1. The compact spare tire (if so equipped) does not have a tire pressure monitoring sensor. Therefore, the TPMS will not monitor the pressure in the compact spare tire.
2. If you install the compact spare tire in place of a road tire that has a pressure below the low-pressure warning limit, upon the next ignition key cycle, the TPM Telltale

Light will remain ON, a chime will sound, and the EVIC will still display a flashing pressure value in the graphic display.

3. After driving the vehicle for up to 10 minutes above 15 mph (25 km/h), the TPM Telltale Light will flash on and off for 75 seconds and then remain on solid. In addition, the EVIC will display a "CHECK TPM SYSTEM" message for three seconds and then display dashes (- -) in place of the pressure value.
4. For each subsequent ignition key cycle, a chime will sound, the TPM Telltale Light will flash on and off for 75 seconds and then remain on solid, and the EVIC will display a "CHECK TPM SYSTEM" message for three seconds and then display dashes (- -) in place of the pressure value.

5. Once you repair or replace the original road tire, and reinstall it on the vehicle in place of the compact spare, the TPMS will update automatically. In addition, the TPM Telltale Light will turn OFF and the graphic in the EVIC will display a new pressure value instead of dashes (- -), as long no tire pressure is below the low-pressure warning limit in any of the four active road tires. The vehicle may need to be driven for up to 10 minutes above 15 mph (25 km/h) in order for the TPMS to receive this information.

GENERAL INFORMATION

This device complies with part 15 of the FCC rules and RSS 210 of Industry Canada. Operation is subject to the following conditions:

- This device may not cause harmful interference.
- This device must accept any interference received, including interference that may cause undesired operation.

The tire pressure sensors are covered under one of the following licenses:

United States KR5S120123
Canada 2671-S120123

FUEL REQUIREMENTS

2.4L AND 2.7L ENGINES



2.4L and 2.7L engines are designed to meet all emission regulations and provide excellent fuel economy and performance when using high quality unleaded “regular” gasolines having an octane rating of 87.

The use of premium gasoline is not recommended. Under normal conditions, the use of premium gasoline will not provide a benefit over high quality unleaded “regular” gasolines, and in some circumstances may result in poorer performance.

3.5L ENGINE



800dfab6



800dfab7

The 3.5L engine is designed to meet all emissions regulations and provide satisfactory fuel economy and performance when using high-quality unleaded gasoline having an octane range of 87 to 89. The manufacturer recommends the use of 89 octane for optimum performance. The use of premium gasoline is not recommended. Under normal conditions, the use of premium gasoline will not provide a benefit over high quality unleaded “regular” and “mid-grade” gasolines, and in some circumstances may result in poorer performance.

Light spark knock at low engine speeds is not harmful to your engine. However, continued heavy spark knock at high speeds can cause damage and immediate service is required.

Poor quality gasoline can cause problems such as hard starting, stalling, and hesitations. If you experience these symptoms, try another brand of gasoline (with the appropriate octane rating for your engine) before considering service for the vehicle.

Over 40 automobile manufacturers around the world have issued and endorsed consistent gasoline specifications (the World Wide Fuel Charter, WWFC) which define fuel properties necessary to deliver enhanced emissions, engine performance, and durability for your vehicle. The manufacturer recommends the use of gasolines that meet the WWFC specifications if they are available.

REFORMULATED GASOLINE

Many areas of the country require the use of cleaner burning gasoline referred to as “Reformulated Gasoline.”

Reformulated gasolines contain oxygenates, and are specifically blended to reduce vehicle emissions and improve air quality.

The manufacturer supports the use of reformulated gasolines. Properly blended reformulated gasolines will provide excellent performance and durability of engine and fuel system components.

GASOLINE/OXYGENATE BLENDS

Some fuel suppliers blend unleaded gasoline with oxygenates such as 10% ethanol, MTBE, and ETBE. Oxygenates are required in some areas of the country during the winter months to reduce carbon monoxide emissions. Fuels blended with these oxygenates may be used in your vehicle.

CAUTION!

For vehicles equipped with a 2.4L or 3.5L engine, DO NOT use gasoline containing Methanol or E85 Ethanol. Use of these blends may result in starting and driveability problems and may damage critical fuel system components.

NOTE: The **2.7L engine** is now rated for E85 Ethanol use (**EXCEPT CALIFORNIA EMISSION STATES**). Only vehicles with the E-85 fuel filler door label can operate on E-85. For more information, see “Flexible Fuel” in this section.

Problems that result from using methanol/gasoline or E85 Ethanol blends are not the responsibility of the manufacturer. While MTBE is an oxygenate made from Methanol, it does not have the negative effects of Methanol.

MMT IN GASOLINE

MMT is a manganese containing metallic additive that is blended into some gasoline to increase octane. Gasoline blended with MMT provides no performance advantage beyond gasoline of the same octane number without MMT. Gasoline blended with MMT reduces spark plug life and reduces emission system performance in some vehicles. The manufacturer recommends that gasoline without MMT be used in your vehicle. The MMT content of gasoline may not be indicated on the gasoline pump, therefore, you should ask your gasoline retailer whether or not his/her gasoline contains MMT.

It is even more important to look for gasolines without MMT in Canada, because MMT can be used at levels higher than those allowed in the United States.

MMT is prohibited in Federal and California reformulated gasolines.

MATERIALS ADDED TO FUEL

All gasoline sold in the United States is required to contain effective detergent additives. Use of additional detergents or other additives is not needed under normal conditions and they would result in additional cost. Therefore, you should not have to add anything to the fuel.

FUEL SYSTEM CAUTIONS

CAUTION!

Follow these guidelines to maintain your vehicle's performance:

- The use of leaded gas is prohibited by Federal law. Using leaded gasoline can impair engine performance and damage the emission control system.

- An out-of-tune engine, or certain fuel or ignition malfunctions, can cause the catalytic converter to overheat. If you notice a pungent burning odor or some light smoke, your engine may be out of tune or malfunctioning and may require immediate service. Contact your authorized dealer for service assistance.
- The use of fuel additives, which are now being sold as octane enhancers, is not recommended. Most of these products contain high concentrations of methanol. Fuel system damage or vehicle performance problems resulting from the use of such fuels or additives is not the responsibility of the manufacturer.

NOTE: Intentional tampering with emissions control systems can result in civil penalties being assessed against you.

CARBON MONOXIDE WARNINGS

WARNING!

Carbon monoxide (CO) in exhaust gases is deadly. Follow the precautions below to prevent carbon monoxide poisoning:

- Do not inhale exhaust gases. They contain carbon monoxide, a colorless and odorless gas, which can kill. Never run the engine in a closed area, such as a garage, and never sit in a parked vehicle with the engine running for an extended period. If the vehicle is stopped in an open area with the engine running for more than a short period, adjust the ventilation system to force fresh, outside air into the vehicle.

5

- Guard against carbon monoxide with proper maintenance. Have the exhaust system inspected every time the vehicle is raised. Have any abnormal conditions repaired promptly. Until repaired, drive with all side windows fully open.
- Keep the trunk closed when driving your vehicle to prevent carbon monoxide and other poisonous exhaust gases from entering the vehicle.

FLEXIBLE FUEL— 2.7L ENGINES ONLY (EXCEPT CALIFORNIA EMISSION STATES)

E-85 GENERAL INFORMATION

The information in this section is for Flexible Fuel vehicles only. This section only covers those subjects that are unique to these vehicles. Please refer to the other sections of this manual for information on features that are common between Flexible Fuel and gasoline only powered vehicles.

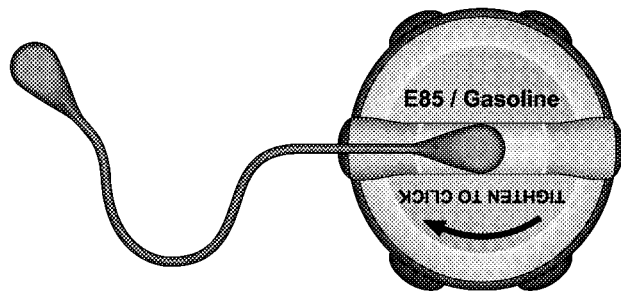

81ae46ab

E-85 Fuel Cap

CAUTION!

Only vehicles with the special E-85 fuel filler cap can operate on E-85.

Along with the special E-85 fuel filler cap, your vehicle may display a badge, which also indicates it can operate on E-85.



81ae46a9

E-85 Badge

ETHANOL FUEL (E-85)

E-85 is a mixture of approximately 85% fuel ethanol and 15% unleaded gasoline.

WARNING!

Ethanol vapors are extremely flammable and could cause serious personal injury. Never have any smoking materials lit in or near the vehicle when removing the fuel filler tube cap (gas cap) or filling the tank. Do not use E-85 as a cleaning agent and never use it near an open flame.

5

FUEL REQUIREMENTS

Your vehicle will operate on both unleaded gasoline with an octane rating of 87, or E-85 fuel, or any mixture of these two.

For best results, a refueling pattern that alternates between E-85 and unleaded gasoline should be avoided. When you do switch fuels, it is recommended that:

- you do not switch when the fuel gauge indicates less than $\frac{1}{4}$ full
- you do not add less than 5 gal (19 l) when refueling
- you operate the vehicle immediately after refueling for a period of at least five minutes

Observing these precautions will avoid possible hard starting and/or significant deterioration in driveability during warm up.

NOTE: When the ambient temperature is above 90°F (32°C), you may experience hard starting and rough idle following start up even if the above recommendations are followed.

SELECTION OF ENGINE OIL FOR FLEXIBLE FUEL VEHICLES (E-85) AND GASOLINE VEHICLES

FFV vehicles operated on E85 require specially formulated engine oils. These special requirements are included in Mopar® engine oils, and in equivalent oils meeting Chrysler Specification MS-6395. The manufacturer only recommends engine oils that are API Certified and meet the requirements of Material Standard MS-6395. MS-6395 contains additional requirements, developed during extensive fleet testing, to provide additional protection to the manufacturer's engines. Use Mopar® or an equivalent oil meeting the specification MS-6395.

NOTE: Your engine oil filler cap also describes the correct engine oil to use.

STARTING

The characteristics of E-85 fuel make it unsuitable for use when ambient temperatures fall below 0°F (-18°C). In the range of 0°F (-18°C) to 32°F (0°C), you may experience an increase in the time it takes for your engine to start, and a deterioration in driveability (sags and/or hesitations) until the engine is fully warmed up.

CRUISING RANGE

Because E-85 fuel contains less energy per gallon than gasoline, you will experience an increase in fuel consumption. You can expect your fuel economy and driving range to decrease by about 30% compared to gasoline operation.

REPLACEMENT PARTS

Many components in your Flexible Fuel Vehicle (FFV) are designed to be compatible with ethanol. Always be sure that your vehicle is serviced with correct ethanol compatible parts.

CAUTION!

Replacing fuel system components with non-ethanol compatible components can damage your vehicle.

MAINTENANCE

CAUTION!

Do not use ethanol mixture greater than 85% in your vehicle. It will cause difficulty in cold starting and may affect driveability.

ADDING FUEL

FUEL FILLER CAP (GAS CAP)



As a reminder, a fuel icon with an arrow indicating which side of the vehicle the fuel filler door is located on, is located in the instrument cluster.

The gas cap is behind the fuel filler door, on the left rear quarter panel of the vehicle. If the gas cap is lost or damaged, be sure the replacement cap is for use with this vehicle.

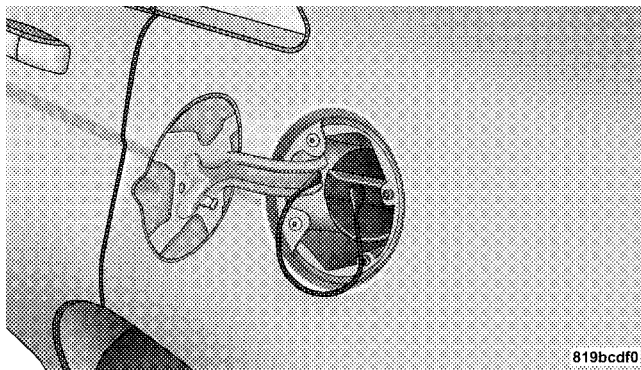

Fuel Filler Door

After removing the gas cap, place the gas cap tether cable over a hook on the inside of the fuel door. This keeps the gas cap suspended away from and protects the vehicle's surface.

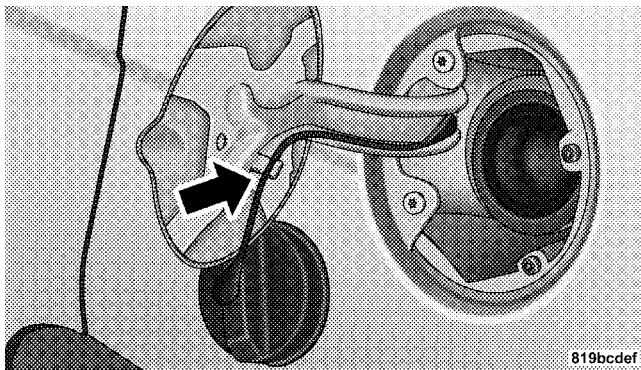

Fuel Filler Door Features

NOTE: If the gas cap is lost or damaged, be sure the replacement cap is for use with this vehicle.

CAUTION!

- Damage to the fuel system or emission control system could result from using an improper fuel tank filler tube cap (gas cap).
- A poorly fitting gas cap could let impurities into the fuel system and could cause the
- A poorly fitting gas cap may cause the Malfunction Indicator Light to turn on.
- To avoid fuel spillage and overfilling, do not “top off” the fuel tank after filling. When the fuel nozzle “clicks” or shuts off, the fuel tank is full.

WARNING!

- **Never have any smoking materials lit in or near the vehicle when the gas cap is removed or the tank filled.**
- **Never add fuel when the engine is running. This is in violation of most state and federal fire regulations and doing so will cause the malfunction indicator light to turn on.**
- **A fire may result if gasoline is pumped into a portable container that is inside of a vehicle. You could be burned. Always place gas containers on the ground while filling.**

NOTE:

- Tighten the gas cap until you hear a “clicking” sound. This is an indication that the gas cap is tightened properly. The Malfunction Indicator Light in the instrument cluster may turn on if the gas cap is not

secured properly. Make sure that the gas cap is tightened each time the vehicle is refueled.

- When the fuel nozzle “clicks” or shuts off, the fuel tank is full.

LOOSE FILLER CAP MESSAGE

If the vehicles diagnostic system determines that the fuel filler cap is loose, improperly installed, or damaged, a “gASCAP” message will be displayed in the instrument cluster. Tighten the gas cap until a “clicking” sound is heard. This is an indication that the gas cap is properly tightened. Press the trip odometer reset button to turn off the message. If the problem persists, the message will appear the next time the vehicle is started. This might indicate a damaged cap. If the problem is detected twice in a row, the system will turn on the Malfunction Indicator Light (MIL). Resolving the problem will turn the MIL light off.

VEHICLE LOADING

Vehicle Loading Capacities

Front Seat Occupants	2
Rear Seat Occupants	3
Luggage	13.0 cu. ft. (0.368 cu. M)

The load carrying capacity of your vehicle is shown on the “Vehicle Certification Label.” This information should be used for passenger and luggage loading as indicated.

Vehicle Curb Weight

2.4 L SE	3355 lbs (1522 kg)
2.4 L SXT	3405 lbs (1545 kg)
2.7 L SXT	3465 lbs (1572 kg)
3.5 L R/T	3568 lbs (1618 kg)
3.5 L R/T AWD	3738 lbs (1696 kg)

If the seatbacks are folded for carrying cargo, do not exceed the specified GVWR and GAWR.

Vehicle Certification Label

Your vehicle has a certification label attached to the rear of the driver’s door.

The label contains the following information:

- Name of manufacturer
- Month and year of manufacture
- Gross Vehicle Weight Rating (GVWR)
- Gross Axle Weight Rating (GAWR) front
- Gross Axle Weight Rating (GAWR) rear
- Vehicle Identification Number (VIN)
- Type of Vehicle
- Month Day and Hour of Manufacture (MDH)

The bar code allows a computer scanner to read the Vehicle Identification Number (VIN).

Gross Vehicle Weight Rating (GVWR)

The GVWR is the total allowable weight of your vehicle. This includes driver, passengers, and cargo. The total load must be limited so that you do not exceed the GVWR.

Gross Axle Weight Rating (GAWR)

The GAWR is the maximum capacity of the front and rear axles. Distribute the load over the front and rear axles evenly. Make sure that you do not exceed either front or rear GAWR.

WARNING!

Because the front wheels steer the vehicle, it is important that you do not exceed the maximum front or rear GAWR. A dangerous driving condition can result if either rating is exceeded. You could lose control of the vehicle and have an accident.

Overloading

The load carrying components (axle, springs, tires, wheels, etc.) of your vehicle will provide satisfactory service as long as you do not exceed the GVWR and front and rear GAWR.

The best way to figure out the total weight of your vehicle is to weigh it when it is fully loaded and ready for operation. Weigh it on a commercial scale to insure that it is not over the GVWR.

Figure out the weight on the front and rear of the vehicle separately. It is important that you distribute the load evenly over the front and rear axles.

Overloading can cause potential safety hazards and shorten useful service life. Heavier axles or suspension components do not necessarily increase the vehicle's GVWR.

Loading

To load your vehicle properly, first figure out its empty weight, axle by axle and side by side. Store heavier items down low and be sure you distribute their weight as evenly as possible. Stow all loose items securely before driving. If weighing the loaded vehicle shows that you have exceeded either GAWR, but the total load is within the specified GVWR, you must redistribute the weight. Improper weight distribution can have an adverse effect on the way your vehicle steers and handles and the way the brakes operate.

A loaded vehicle is shown in the illustration. Note that neither the GVWR nor the GAWR capacities have been exceeded.

Vehicle with a GVWR of 4480		
EXAMPLE ONLY	Front Axle	Rear Axle
Empty Weight	1853 lbs (841 kg)	1631 lbs (740 kg)
Load (Including driver, passengers, and cargo)	271 lbs (123 kg)	579 lbs (263 kg)
Total	2124 lbs (963 kg)	2210 lbs (1002 kg)
GAWR	2195 lbs (997 kg)	2285 lbs (1036 kg)

NOTE: Refer to the “Vehicle Certification Label” attached to the rear of the driver’s door for your vehicle’s GVWR and GAWR. This table is only an example.

TRAILER TOWING

In this section, you will find safety tips and information on limits to the type of towing you can reasonably do with your vehicle. Before towing a trailer, carefully review this information to tow your load as efficiently and safely as possible.

To maintain warranty coverage, follow the requirements and recommendations in this manual concerning vehicles used for trailer towing.

If you have any questions or concerns after reviewing this section, please consult your dealer for full details on the towing capabilities of the vehicle.

Common Towing Definitions

The following trailer towing related definitions will assist you in understanding the following information:

Gross Vehicle Weight Rating (GVWR)

The GVWR is the total allowable weight of your vehicle. This includes driver, passengers, cargo, and tongue weight. The total load must be limited so that you do not exceed the GVWR.

Gross Trailer Weight (GTW)

The GTW is the weight of the trailer plus the weight of all cargo, consumables and equipment (permanent or temporary) loaded in or on the trailer in its "loaded and ready for operation" condition. The recommended way to measure GTW is to put your fully loaded trailer on a vehicle scale. The entire weight of the trailer must be supported by the scale.

Gross Combination Weight Rating (GCWR)

The GCWR is the total permissible weight of your vehicle and trailer when weighed in combination. (Note that GCWR ratings include a 150 lbs (68 kg) allowance for the presence of a driver).

Gross Axle Weight Rating (GAWR)

The GAWR is the maximum capacity of the front and rear axles. Distribute the load over the front and rear axles evenly. Make sure that you do not exceed either front or rear GAWR.

WARNING!

It is important that you do not exceed the maximum front or rear GAWR. A dangerous driving condition can result if either rating is exceeded. You could lose control of the vehicle and have an accident.

Trailer Tongue Weight (TW)

Tongue Weight is the downward force exerted on the hitch ball by the trailer. In most cases it should not be less than or more than 10% of the trailer load. You must consider this as part of the load on your vehicle.

Frontal Area

Frontal Area is the maximum height and maximum width of the front of a trailer and its cargo.

Weight-Carrying Hitch

A weight-carrying hitch supports the trailer tongue weight, just as if it were luggage located at a hitch ball or some other connecting point of the truck. These kinds of hitches are the most popular on the market today and they're commonly used to tow small- and medium-sized trailers.

Trailer Hitch Classifications

The following chart provides the industry standard for the maximum trailer weight a given trailer hitch class can tow and should be used to assist you in selecting the correct trailer hitch for your intended towing condition.

Trailer Hitch Classification Definitions	
Class	Max. Trailer Hitch Industry Standards
Class I - Light Duty	2,000 lbs (907 kg)
Class II - Medium Duty	3,500 lbs (1587 kg)
Refer to the "Trailer Towing Weights (Maximum Trailer Weight Ratings)" chart for the Maximum Gross Trailer Weight (GTW) towable for your given drivetrain.	

All trailer hitches should be professionally installed on your vehicle.

Trailer Towing Weights (Maximum Trailer Weight Ratings)

The following chart provides the maximum trailer weight ratings towable for your given drivetrain.

Engine/Transaxle	Max. Frontal Area	Max. GTW (Gross Trailer Wt.)	Max. Trailer Tongue Wt. ¹
2.4L/Auto	See Note ²	1000 lbs (450 kg)	100 lbs (45 kg)
2.7L/Auto	See Note ²	1500 lbs (680 kg)	150 lbs (68 kg)
3.5L/Auto	22 Sq., Ft. (2.0 Sq. M)	2000 lbs (900 kg)	200 lbs (90 kg)
Refer to local laws for maximum trailer towing speeds.			

¹ The trailer tongue weight must be considered as part of the combined weight of occupants and cargo, and it should never exceed the weight referenced on the Tire and Loading Information placard. Refer to “Tire Safety Information” in Section 5 of this manual.

² Enclosed trailers or open utility trailers with front shields/guards are not recommended for use with all 4 cylinder and 2.7L engines with automatic transaxle. Please refer to the following website, <http://www-5.chrysler.com/searchapp/ui.jsp> or your authorized dealer for additional information.

CAUTION!

Towing a trailer with a larger than recommended frontal area could cause the engine to overheat or cause severe engine damage under extreme conditions.

Trailer and Trailer Tongue Weight

Always load a trailer with 60% to 65% of the weight in the front of the trailer. This places 10% of the Gross Trailer Weight (GTW) on the tow hitch of your vehicle. Loads balanced over the wheels or heavier in the rear can cause the trailer to sway **severely** side to side which will cause loss of control of vehicle and trailer. Failure to load trailers heavier in front is the cause of many trailer accidents.

Never exceed the maximum trailer tongue weight stamped on your bumper or trailer hitch.

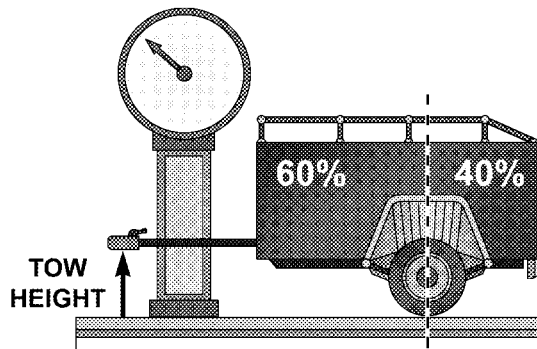

81546c40

Consider the following items when computing the weight on the rear axle of the vehicle:

- The trailer tongue weight of the trailer.
- The weight of any other type of cargo or equipment put in or on your vehicle.
- The weight of the driver and all passengers.

NOTE: Remember that everything put into or on the trailer adds to the load on your vehicle. Also, additional factory-installed options, or authorized dealer-installed options, must be considered as part of the total load on your vehicle. Refer to the Tire and Loading Information placard in the Tire Safety Information Section of this manual for the maximum combined weight of occupants and cargo for your vehicle.

CAUTION!

Incorrect trailer tongue weight could result in increased yaw or vehicle instability. A negative trailer tongue weight could unload the rear suspension of the tow vehicle decreasing vehicle stability. Negative trailer tongue weight could cause the trailer to squat and potentially become disengaged from the tow vehicle resulting in a runaway trailer condition.

Towing Requirements

To promote proper break-in of your new vehicle drivetrain components the following guidelines are recommended:

CAUTION!

- **Avoid towing a trailer for the first 500 mi (805 km) of vehicle operation. Doing so may damage your vehicle.**
- **During the first 500 mi (805 km) of trailer towing, limit your speed to 50 mph (80 km/h).**

Perform the maintenance listed in Section 8 of this manual. When towing a trailer, never exceed the GAWR, or GCWR, ratings.

WARNING!

Improper towing can lead to an injury accident. Follow these guidelines to make your trailer towing as safe as possible:

Make certain that the load is secured in the trailer and that it will not shift during travel. When trailering cargo that is not fully secured, dynamic load shifts can occur that may be difficult for the driver to control. You could lose control of your vehicle and have an accident.

- When hauling cargo, or towing a trailer, do not overload your vehicle or trailer. Overloading can cause a loss of control, poor performance, or damage to brakes, axle, engine, transaxle, steering, suspension, chassis structure, or tires.

- Safety chains must always be used between your vehicle and trailer. Always connect the chains to the frame or hook retainers of the vehicle hitch. Cross the chains under the trailer tongue and allow enough slack for turning corners.
- Vehicles with trailers should not be parked on a grade. When parking, apply the parking brake on the tow vehicle. Put the tow vehicle automatic transaxle in PARK. Always, block or "chock" the trailer wheels.
- GCWR must not be exceeded.
- **Total weight must be distributed between the tow vehicle and the trailer such that the following four ratings are not exceeded:**
 1. GVWR
 2. GTW
 3. GAWR

4. Trailer tongue weight rating for the trailer hitch utilized (This requirement may limit the ability to always achieve 10% of trailer tongue weight as a percentage of total trailer weight).

Towing Requirements — Tires

- Do not attempt to tow a trailer while using a compact spare tire.
- Proper tire inflation pressures are essential to the safe and satisfactory operation of your vehicle. Refer to the “Tires — General Information” in this section for information on tire pressures and for proper tire inflation procedures.
- Also, check the trailer tires for proper tire inflation pressures before trailer usage.
- Check for signs of tire wear or visible tire damage before towing a trailer. Refer to “Tires — General

Information” in this section for information on tread wear indicators and for proper inspection procedure.

- When replacing tires, refer to “Tires — General Information” in this section for information on replacement tires and for proper tire replacement procedures. Replacing tires with a higher load carrying capacity will not increase the vehicle’s GVWR and GAWR limits.

Towing Requirements — Trailer Brakes

- Do **not** interconnect the hydraulic brake system or vacuum system of your vehicle with that of the trailer. This could cause inadequate braking and possible personal injury.
- An electronically actuated trailer brake controller is required when towing a trailer with electronically actuated brakes. When towing a trailer equipped with a hydraulic surge actuated brake system, an electronic brake controller is not required.

- Trailer brakes are recommended for trailers over 1,000 lbs (450 kg) and required for trailers in excess of 2,000 lbs (907 kg).

CAUTION!

If the trailer weighs more than 1,000 lbs (450 kg) loaded, it should have its own brakes with adequate braking capacity. Failure to do this could lead to accelerated brake lining wear, higher brake pedal effort, and longer stopping distances.

WARNING!

Do not connect trailer brakes to your vehicle's hydraulic brake lines. It can overload your brake system and cause it to fail. You might not have brakes when you need them and could have an accident.

Towing any trailer will increase your stopping distance. When towing, you should allow for additional space between your vehicle and the vehicle in front of you. Failure to do so could result in an accident.

Towing Requirements — Trailer Lights and Wiring

Whenever you pull a trailer, regardless of the trailer size, stoplights and turn signals on the trailer are required for motoring safety.

Use a factory approved trailer harness and connector.

NOTE: Do not cut or splice wiring into the vehicles wiring harness.

The electrical connections are all complete to the vehicle, but you must mate the harness to a trailer connector.

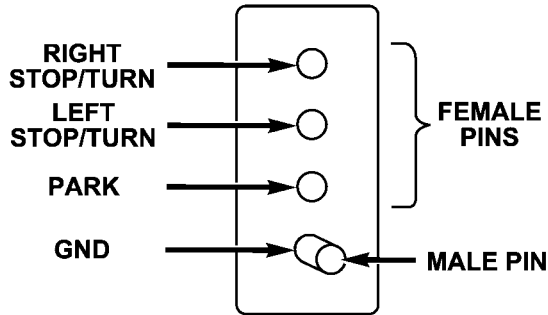

4-Pin Connector

813262be

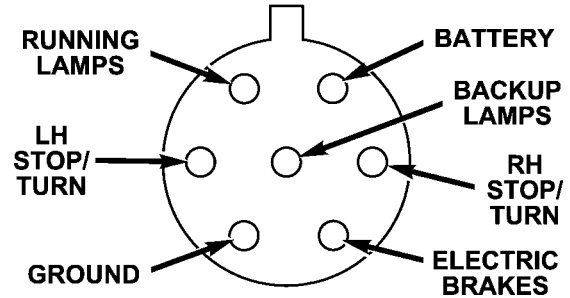

7-Pin Connector

812634c6

Towing Tips

Before setting out on a trip, practice turning, stopping, and backing the trailer in an area located away from heavy traffic.

Make sure all trailer and vehicle lights are working properly — including hazard flashers.

Automatic Transaxle

The DRIVE range can be selected when towing. However, if frequent shifting occurs while in this range, third gear for a four-speed automatic and the fifth gear for a six-speed AutoStick® should be selected.

NOTE: Using third or fifth instead of DRIVE while operating the vehicle under heavy operating conditions, will improve performance and extend transaxle life by reducing excessive shifting and heat build-up. This action will also provide better engine braking.

If you **REGULARLY TOW** a trailer for more than 45 minutes of continuous operation, then change the automatic transaxle fluid and filter according to the interval specified for “police, taxi, fleet, or frequent trailer towing” in the “Maintenance Schedule” in this manual.

NOTE: Check the four-speed automatic transaxle fluid level before towing. AutoStick® six—speed transmission

is sealed and the fluid level cannot be checked. See your authorized dealership service center for assistance.

Electronic Speed Control — (If Equipped)

- Don't use in hilly terrain or with heavy loads.
- When using the speed control, if you experience speed drops greater than 10 mph (16 km/h), disengage until you can get back to cruising speed.
- Use speed control in flat terrain and with light loads to maximize fuel efficiency.

Cooling System

To reduce potential for engine and transaxle overheating, take the following actions:

- **City Driving**

When stopped for short periods of time, put transaxle in neutral and increase engine idle speed.

- **Highway Driving**

Reduce speed.

- **Air Conditioning**

Turn off temporarily.

- Refer to Cooling System Operating information in the Maintenance section of this manual for more information.

If you have any questions or concerns after reviewing this section, please consult your authorized dealer to for full details on the towing capabilities of the vehicle.

RECREATIONAL TOWING (BEHIND MOTORHOME, ETC.)

Towing This Vehicle Behind Another Vehicle (Flat towing with all four wheels on the ground)

CAUTION!
DO NOT flat tow this vehicle. Damage to the drivetrain will result.

5

NOTE: If the vehicle requires towing make sure all four wheels are off the ground.

WHAT TO DO IN EMERGENCIES

CONTENTS

- Hazard Warning Flasher 348
- If Your Engine Overheats 348
 - Engine Oil Overheating (2.4L Engine Only) —
If Equipped 350
- Jacking And Tire Changing 350
 - Jack Location 351
 - Spare Tire Stowage 351
 - Preparations For Jacking 352
 - Jacking Instructions 352
- Jump-Starting Procedures Due To A Low Battery . . 358
- Freeing A Stuck Vehicle 361
- Towing A Disabled Vehicle 362
 - Towing With The Ignition Key 362
 - Towing Without The Ignition Key 363
 - Towing This Vehicle Behind Another Vehicle . . 363
 - Towing This Vehicle Behind Another Vehicle
With A Tow Dolly 363
 - Towing Without Power — Override Transaxle
Interlock System 364

HAZARD WARNING FLASHER



The flasher switch is located on the instrument panel, below the radio. Depress the switch and both cluster indicators and all front and rear directional signals will flash. Depress the switch again to turn Hazard Warning Flashers off.

Do not use this emergency warning system when the vehicle is in motion. Use it when your vehicle is disabled and it is creating a safety hazard for other motorists.

If it is necessary to leave the vehicle to go for service, the flasher system will continue to operate with the ignition key removed and the vehicle locked.

NOTE: With extended use, the flasher may wear down your battery.

IF YOUR ENGINE OVERHEATS

In any of the following situations, you can reduce the potential for overheating by taking the appropriate action.

- On the highways — Slow down.
- In city traffic — While stopped, put transaxle in NEUTRAL, but do not increase engine idle speed.

If the pointer rises to the **H** (red) mark, the instrument cluster will sound a chime. Pull over and stop the vehicle with the engine at idle, when safe. Turn off the air conditioning and wait until the pointer drops back into the normal range. If the pointer remains on the H (red) mark for more than a minute, turn the engine off immediately and call for service.

NOTE: There are steps that you can take to slow down an impending overheating condition. If your air conditioner is on, turn it off. The air conditioning system adds heat to the engine cooling system and turning off the A/C removes this heat. You can also turn the Temperature control to maximum heat, the Mode control to floor, and the fan control to High. This allows the heater core to act as a supplement to the radiator and aids in removing heat from the engine cooling system.

CAUTION!

Driving with a hot cooling system could damage your vehicle. If temperature gauge reads "H", pull over and stop the vehicle with the engine at idle, when safe. Turn the air conditioner off and wait until the pointer drops back into the normal range. After appropriate action has been taken, if the pointer remains on the "H", turn the engine off immediately, and call for service.

WARNING!

A hot engine cooling system is dangerous. You or others could be badly burned by steam or boiling coolant. You may want to call a service center if your vehicle overheats. If you decide to look under the hood yourself, refer to Section 7, Maintenance, of this manual. Follow the warnings under the Cooling System Pressure Cap paragraph.

**ENGINE OIL OVERHEATING (2.4L ENGINE ONLY)
— IF EQUIPPED**

During sustained high-speed driving or trailer tow up long grades on a hot day, the engine oil temperature may become too hot. If this happens, the “HOTOIL” message flashes in the odometer and the vehicle speed will be reduced to 53 mph (85 km/h) until the engine oil temperature is reduced.

NOTE: The vehicle speed is reduced to a maximum of 53 mph (85 km/h). You may of course, reduce your vehicle speed further if needed.

JACKING AND TIRE CHANGING**WARNING!**

- Getting under a jacked-up vehicle is dangerous. The vehicle could slip off the jack and fall on you. You could be crushed. Never get any part of your body under a vehicle that is on a jack. If you need to get under a raised vehicle, take it to a service center where it can be raised on a lift.
- The jack is designed to use as a tool for changing tires only. The jack should not be used to lift the vehicle for service purposes. The vehicle should be jacked on a firm level surface only. Avoid ice or slippery areas.

Jack Location

The jack and jack-handle are stowed under the load floor in the trunk.

Spare Tire Stowage

The compact spare tire is stowed under the load floor in the trunk.

Spare Tire Removal

Lift up the load floor cover and remove the hold down.

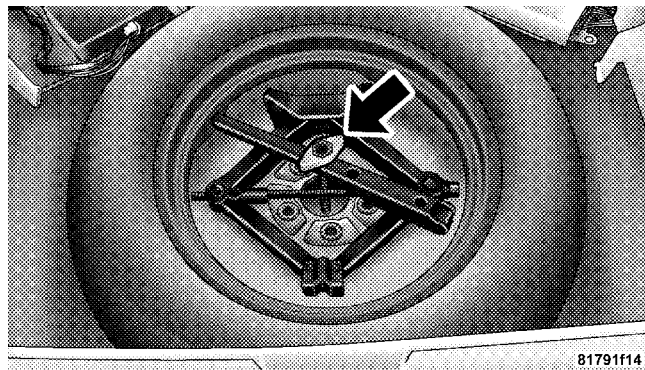

Spare Tire and Jack Stowage

Preparations For Jacking

Park the vehicle on a firm level surface, avoid ice or slippery areas, **set the parking brake** and place the gear selector in PARK (automatic transaxle) or REVERSE (manual transaxle). Turn OFF the ignition.

WARNING!

Do not attempt to change a tire on the side of the vehicle close to moving traffic. Pull far enough off the road to avoid the danger of being hit when operating the jack or changing the wheel.

- Turn on the Hazard Warning Flasher.

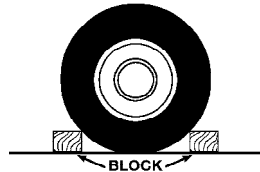

- Block both the front and rear of the wheel diagonally opposite the jacking position. For example, if changing the right front tire, block the left rear wheel.

- Passengers should not remain in the vehicle while the vehicle is being jacked.

Jacking Instructions



Jack Warning Label

WARNING!

Carefully follow these tire changing warnings to help prevent personal injury or damage to your vehicle:

- Always park on a firm, level surface as far from the edge of the roadway as possible before raising the vehicle.
- Block the wheel diagonally opposite the wheel to be raised.
- Set the parking brake firmly and set an automatic transmission in park; a manual transmission in reverse.
- Do not let anyone sit in the vehicle when it is on a jack.

1. Remove the scissors jack and lug wrench from the spare wheel as an assembly. Turn the jack screw to the left to loosen the lug wrench, and remove the wrench from the jack assembly.

NOTE: The Jack Handle attaches to the side of the jack with two attachment points. When the jack is partially expanded, the tension between the two attachment points holds the jack handle in place.

2. Loosen, but do not remove, the wheel nuts by turning them to the left one turn while the wheel is still on the ground.

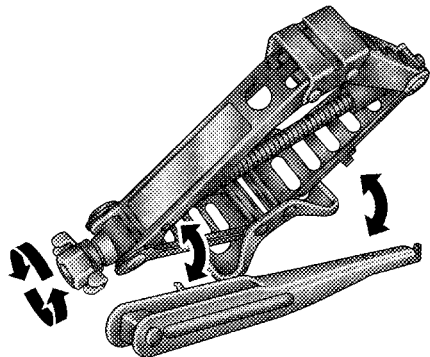

819b068d

Removing Jack Handle From Jack

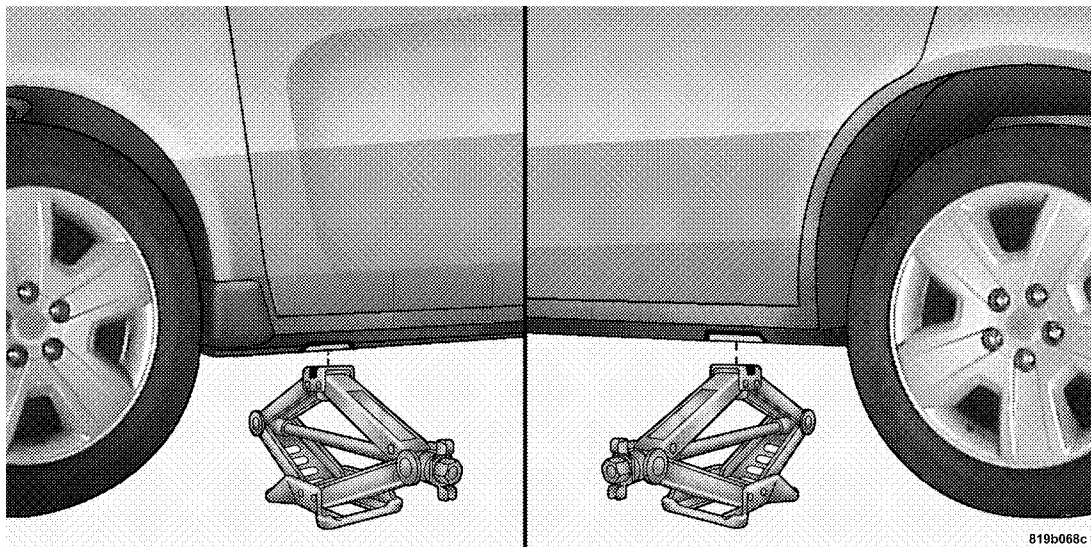

Jacking Locations

3. There are two front jacking locations and two rear jacking locations on each side of the body as shown.

CAUTION!

Do not attempt to raise the vehicle by jacking on locations other than those indicated in step 3.

4. Turn the jack screw to the left until the jack can be placed under the jacking location. Once the jack is positioned, turn the jack screw to the right until the jack head is properly engaged with the lift area closest to the wheel to be changed. Do not raise the vehicle until you are sure the jack is securely engaged.

WARNING!

Raising the vehicle higher than necessary can make the vehicle less stable. It could slip off the jack and hurt someone near it. Raise the vehicle only enough to remove the tire.

5. Raise the vehicle by turning the jack screw to the right, using the swivel wrench. Raise the vehicle only until the tire just clears the surface and enough clearance is obtained to install the spare tire. Minimum tire lift provides maximum stability.

6. Remove the wheel nuts, and pull the wheel and wheel covers (where applicable) off the hub. Install the spare wheel and wheel nuts with the cone shaped end of the nuts toward the wheel. Lightly tighten the nuts. To avoid the risk of forcing the vehicle off the jack, do not tighten the nuts fully until the vehicle has been lowered.

WARNING!

To avoid possible personal injury, handle the wheel covers with care to avoid contact with any sharp edges.

WARNING!

A loose tire or jack thrown forward in a collision or hard stop could endanger the occupants of the vehicle. Always stow the jack parts and the spare tire in the places provided.

7. Lower the vehicle by turning the jack screw to the left.

8. Finish tightening the nuts. Push down on the wrench while tightening the wheel nuts. Alternate nuts, until each nut has been tightened twice. Correct wheel nut torque is 100 ft. lbs (135 N·m). If you doubt that you have tightened the nuts correctly, have them checked with a torque wrench by your dealer or at a service station.

9. Remove the wheel blocks and lower the jack until it is free. Reassemble the lug wrench to the jack assembly and stow it in the spare tire area. Secure the assembly using the means provided.

10. Place the deflated (flat) tire in the cargo area and **have the tire repaired or replaced as soon as possible.**

WARNING!

A loose tire thrown forward in a collision or hard stop could injure the occupants in the vehicle. Have the deflated (flat) tire repaired or replaced immediately.

11. Check the tire pressure as soon as possible. Correct pressure as required.

JUMP-STARTING PROCEDURES DUE TO A LOW BATTERY

Jump-starting remote battery terminals are located under the hood.

The battery is stored between the left front headlight assembly and the left front wheel splash shield. Access is through the splash shield.

WARNING!

- Take care to avoid the radiator cooling fan whenever the hood is raised. It can start anytime the ignition switch is on. You can be hurt by the fan.
- Do not attempt to push or tow your vehicle to get it started. Vehicles equipped with an automatic transaxle cannot be started this way. Unburned fuel could enter the catalytic converter and once the engine has started, ignite and damage the converter and vehicle. If the vehicle has a discharged battery, booster cables may be used to obtain a start from another vehicle. This type of start can be dangerous if done improperly, so follow this procedure carefully.
- Do not use a booster battery or any other booster source with an output that exceeds 12 volts.
- During cold weather when temperatures are below freezing point, electrolyte in a discharged battery may freeze. Do not attempt jump-starting because the battery could rupture or explode. The battery temperature must be brought up above freezing point before attempting jump-start.

1. Wear eye protection and remove any metal jewelry such as watchbands or bracelets that might make an inadvertent electrical contact.
2. When boosting from a battery in another vehicle, park that vehicle within booster cable reach, but without allowing the vehicles to touch. Set parking brake, place automatic transaxle in PARK and turn ignition to LOCK for both vehicles.

WARNING!

Do not permit vehicles to touch each other as this could establish a ground connection and personal injury could result.

3. Turn off the heater, radio, and all unnecessary electrical loads.

4. Remove the protective cover over the remote jump-start positive battery post (+) in the engine compartment. Connect one end of the jumper cable to the positive battery post. Connect the other end of the same cable to the positive terminal of the booster battery. Refer to the following illustration for jump-starting connections.

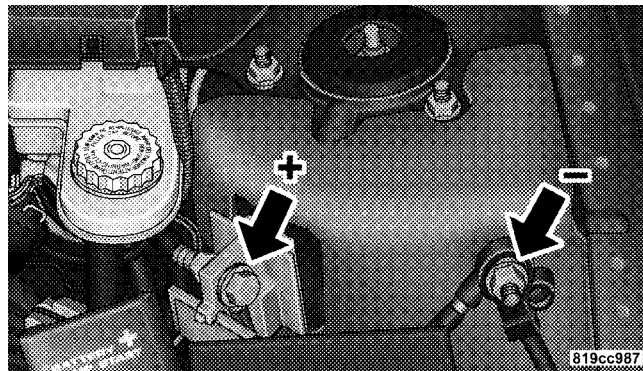
**Jump-Starting Location**

5. Connect the other cable, first to the negative terminal of the booster battery and **then to the engine ground (-) of the vehicle with the discharged battery.** Make sure you have a good contact on the engine ground. Refer to the following illustration for jump-starting connections.
6. If the vehicle is equipped with Sentry Key® Immobilizer, turn the ignition switch to the ON position for three seconds before moving the ignition switch to the START position.
7. Start the engine in the vehicle that has the booster battery, let the engine idle a few minutes, and then start the engine in the vehicle with the discharged battery.
8. When removing the jumper cables, reverse the sequence exactly. Be careful of the moving belts and fan.
9. Reinstall the protective cover over the remote jump-start positive battery post.

NOTE: Refer to “Maintenance Procedures” in Section 7 of this manual for information on accessing the battery for service or replacement.

WARNING!

Any procedure other than above could result in:

- 1. Personal injury caused by electrolyte squirting out the battery vent;**
- 2. Personal injury or property damage due to battery explosion;**
- 3. Damage to charging system of booster vehicle or of immobilized vehicle.**

FREEING A STUCK VEHICLE

If your vehicle becomes stuck in mud, sand, or snow, it can often be moved by a rocking motion. Turn your steering wheel right and left to clear the area around the front wheels. Then shift back and forth between Reverse and First gear. Usually the least accelerator pedal pressure to maintain the rocking motion without spinning the wheels is most effective.

NOTE:



If your vehicle is equipped with Traction Control, turn the system to Partial OFF before attempting to “rock” the vehicle. Refer to “Partial Off Mode” under “Electronic Stability Program (ESP)” in Section 5 of this manual.

WARNING!

Fast spinning tires can be dangerous. Forces generated by excessive wheel speeds may cause axle and tire damage or failure. A tire could explode and injure someone. Do not spin your vehicle’s wheels faster than 30 mph (48 km/h) or for longer than 30 seconds continuously without stopping when you are stuck, and don’t let anyone near a spinning wheel, no matter what the speed.

CAUTION!

Racing the engine or spinning the wheels too fast may lead to transaxle overheating and failure. It can also damage the tires. Do not spin the wheels above 30 mph (48 km/h). Do not spin the wheels continuously for more than 30 seconds.

TOWING A DISABLED VEHICLE**TOWING WITH THE IGNITION KEY****Front Wheel Drive**

Your vehicle may be towed (with all 4 wheels flat on the ground), under the following conditions: The gear selector must be in NEUTRAL, the distance to be traveled must not exceed 15 mi (25 km), and the towing speed must not exceed 25 mph (40 km/h). Exceeding these towing limits may cause a transaxle failure. If the transaxle is not operative, or if the

vehicle is to be towed more than 15 mi (25 km), the vehicle must be transported either with a flat bed truck or with the front wheels off the ground.

All Wheel Drive

Your All Wheel Drive vehicle must be transported on a flat bed truck.

CAUTION!

- **If the vehicle being towed requires steering, the ignition switch must be in the ON position, not in the LOCK or ACC position.**
- **Do not attempt to tow this vehicle from the front with sling type towing equipment. Damage to the front fascia will result.**
- **Do not push or tow this vehicle with another vehicle as damage to the bumper fascia and transaxle may result.**

If you must use the accessories (wipers, defrosters, etc.) while being towed, the key must be in the ON position, not the ACC position. Make certain the transaxle remains in NEUTRAL.

TOWING WITHOUT THE IGNITION KEY

Special care must be taken when the vehicle is towed with the ignition in the LOCK position. Flat bed towing is the preferred towing method. However, if a flat bed towing vehicle is not available, a wheel lift towing vehicle may be used. Furthermore, rear towing is not recommended with the front wheels on the ground, as transaxle damage can result. If rear towing is the only alternative, a front end dolly must be used. Proper towing equipment is necessary to prevent damage to the vehicle.

TOWING THIS VEHICLE BEHIND ANOTHER VEHICLE

Flat towing with all four wheels on the ground of vehicles equipped with an automatic transmission, is only permitted within the limitations described in this section.

TOWING THIS VEHICLE BEHIND ANOTHER VEHICLE WITH A TOW DOLLY

Rear towing is not recommended with the front wheels on the ground, as transaxle damage can result. If rear towing is the only alternative, a front end dolly must be used. Proper towing equipment is necessary to prevent damage to the vehicle.

TOWING WITHOUT POWER — OVERRIDE TRANSAXLE INTERLOCK SYSTEM

Special care must be taken when the vehicle is towed with the ignition in the LOCK position. A dolly should be used under the front wheels if the rear wheels are raised. Proper towing equipment is necessary to prevent damage to the vehicle.

Battery power is required to release the brake/transaxle interlock system. There is an override system that allows you to shift out of PARK in case of loss of power. To activate the override system:

- Firmly apply the parking brake.
- Insert the ignition key and rotate it to the ON position.
- Remove the cupholder liner.
- Insert a key, screwdriver, or similar object into the front hole then push and hold the manual override release lever forward.
- While holding the release lever forward, move the shift lever from PARK to NEUTRAL.
- Release the override.

MAINTAINING YOUR VEHICLE

CONTENTS

■ 2.4L Engine Compartment	368	■ Maintenance Procedures	374
■ 2.7L Engine Compartment	369	□ Engine Oil	374
■ 3.5L Engine Compartment	370	□ Engine Oil Filter	378
■ Onboard Diagnostic System — OBD II	371	□ Drive Belt	378
□ Loose Fuel Filler Cap Message	371	□ Spark Plugs	379
■ Emissions Inspection And Maintenance Programs	372	□ Engine Air Cleaner Filter	379
■ Replacement Parts	373	□ Catalytic Converter	379
■ Authorized Dealer Service	374	□ Maintenance-Free Battery	381
		□ Air Conditioner Maintenance	382

- A/C Air Filter — If Equipped 383
- Power Steering 385
- Front Suspension 385
- Steering Linkage 386
- Body Lubrication 386
- Windshield Wiper Blades 386
- Windshield Washers 387
- Exhaust System 387
- Cooling System 388
- Hoses And Vacuum/Vapor Harnesses 394
- Fuel System 394
- Brake System 394
- Automatic Transaxle 397
- Front And Rear Wheel Bearings 400
- Appearance Care And Protection From Corrosion 400
- Cleaning Center Console Cupholders 405
- Fuses — Totally Integrated Power Module (TIPM) 406
- Vehicle Storage 411
- Replacement Bulbs 411
- Bulb Replacement 412
 - Headlight Bulb Replacement 412
 - Fog Lights 415
 - Taillights, Rear Turn Signals And Backup Lights — Replacement 416
 - License Plate Light — Rear 418

□ Center High-Mounted Stop Light	418	■ Fluids, Lubricants, And Genuine Parts	422
■ Fluids And Capacities	420	□ Engine	422

2.4L ENGINE COMPARTMENT

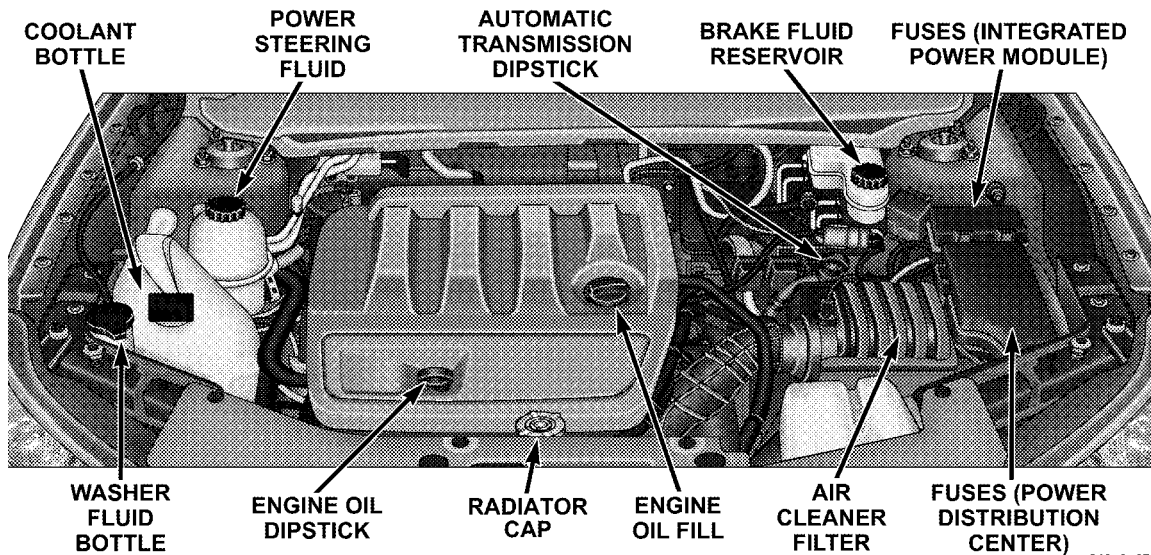

819c3c67

2.7L ENGINE COMPARTMENT

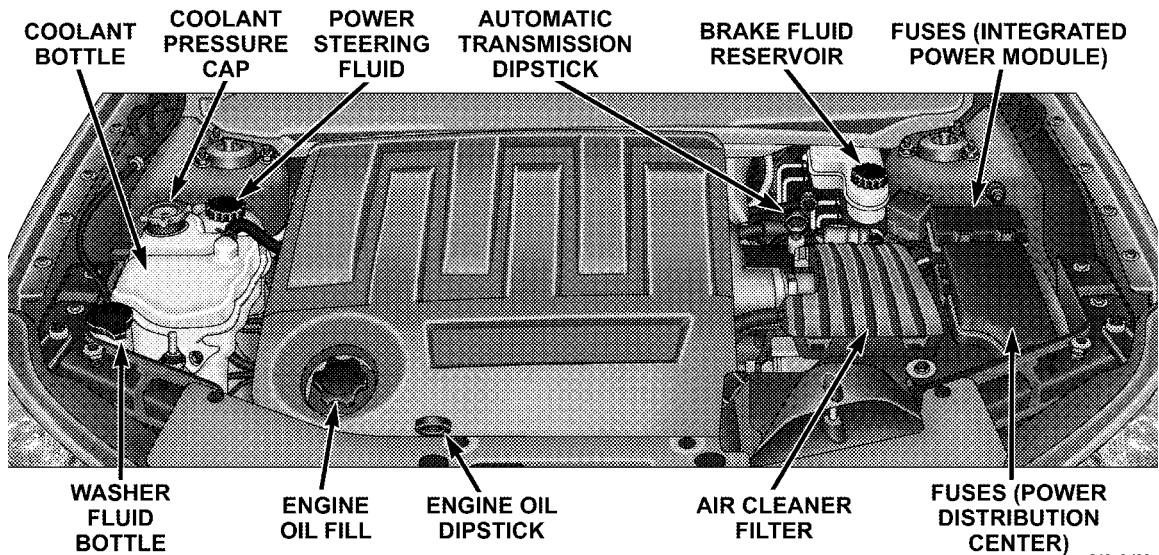

819c3d99

3.5L ENGINE COMPARTMENT

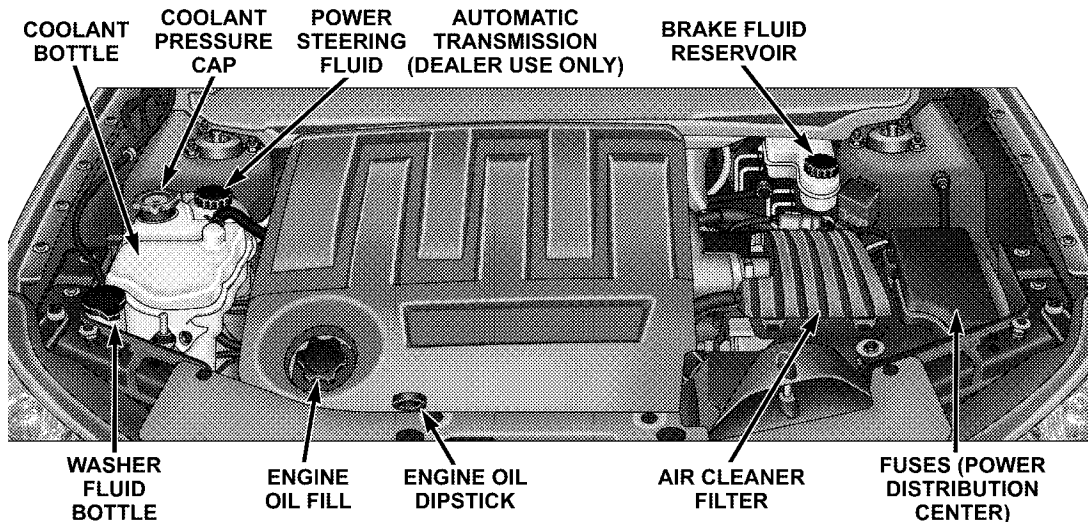

819c3f6a

3.5L Engine

ONBOARD DIAGNOSTIC SYSTEM — OBD II

Your vehicle is equipped with a sophisticated Onboard Diagnostic system called OBD II. This system monitors the performance of the emissions, engine, and automatic transaxle control systems. When these systems are operating properly, your vehicle will provide excellent performance and fuel economy, as well as maintaining engine emissions well within current government regulations.



If any of these systems require service, the OBD II system will turn on the Malfunction Indicator Light (MIL). It will also store diagnostic codes and other information to assist an authorized service technician in making repairs. Although your vehicle will usually be drivable and not need towing, see your authorized dealer for service as soon as possible.

CAUTION!

- **Prolonged driving with the MIL on could cause further damage to the emission control system. It could also affect fuel economy and drivability. The vehicle must be serviced before any emissions tests can be performed.**
- **If the MIL is flashing while the engine is running, severe catalytic converter damage and power loss will soon occur. Immediate service is required.**

LOOSE FUEL FILLER CAP MESSAGE

After fuel is added, the vehicle diagnostic system can determine if the fuel filler cap is possibly loose or improperly installed. A "gASCAP" message will be displayed in the instrument cluster. Tighten the gas cap until a "clicking" sound is heard. This is an indication that the gas cap is properly tightened. Press the Trip Odometer

RESET button to turn off the message. If the problem persists, the message will appear the next time the vehicle is started. This might indicate a damaged cap. If the problem is detected twice in a row, the system will turn on the MIL. Resolving the problem will turn the MIL light off.

EMISSIONS INSPECTION AND MAINTENANCE PROGRAMS

In some localities, it may be a legal requirement to pass an inspection of this vehicle's emissions control system. Failure to pass could prevent vehicle registration.



For states that require an Inspection and Maintenance (I/M), this check verifies the Malfunction Indicator Light (MIL) is functioning and is not on when the engine is running, and that the OBD II system is ready for testing.

Normally, the OBD II system will be ready. The OBD II system may **not** be ready if the vehicle was recently serviced, recently had a dead battery, or a battery replacement. If the OBD II system should be determined not ready for the I/M test, the vehicle may fail the test.

This vehicle has a simple ignition key-actuated test, which you can use prior to going to the test station. To check if this vehicle's OBD II system is ready, you must do the following:

1. Insert the ignition key into the ignition switch.
2. Turn the ignition to the ON position, but do not crank or start the engine.
3. If you crank or start the engine, you will have to start this test over.
4. As soon as you turn the ignition key to the ON position, you will see the MIL symbol come on as part of a normal bulb check.

5. Approximately 15 seconds later, one of two things will happen:

a. The MIL will flash for about 10 seconds and then return to being fully illuminated until you turn OFF the ignition key or start the engine. This means that the vehicle's OBD II system is **not ready** and you should **not** proceed to the I/M station.

b. The MIL will not flash at all and will remain fully illuminated until you turn OFF the ignition key or start the engine. This means that the vehicle's OBD II system is **ready**, and you can proceed to the I/M station.

If the OBD II system is **not ready**, you should see an authorized dealer or repair facility. If this vehicle was recently serviced or had a battery failure or replacement, you may need to do nothing more than drive the vehicle

as you normally would in order for the OBD II system to update. A recheck with the above test routine may then indicate that the system is now ready.

Regardless of whether the vehicle's OBD II system is ready or not ready, if the MIL is illuminated during normal vehicle operation, you should have the vehicle serviced before going to the I/M station. The I/M station can fail the vehicle because the MIL is on with the engine running.

REPLACEMENT PARTS

Use of genuine Mopar® parts for normal/scheduled maintenance and repairs is highly recommended to ensure the designed performance. Damage or failures caused by the use of non-Mopar® parts for maintenance and repairs will not be covered by the manufacturer's warranty.

AUTHORIZED DEALER SERVICE

Your authorized dealer has the qualified service personnel, special tools, and equipment to perform all service operations in an expert manner. Service manuals are available which include detailed service information for your vehicle. Refer to these service manuals before attempting any procedure yourself.

NOTE: Intentional tampering with emissions control systems can result in civil penalties being assessed against you.

WARNING!

You can be badly injured working on or around a motor vehicle. Only do service work for which you have the knowledge and the proper equipment. If you have any doubt about your ability to perform a service job, take your vehicle to a competent mechanic.

MAINTENANCE PROCEDURES

The pages that follow contain the **required** maintenance services determined by the engineers who designed your vehicle.

Besides the maintenance items for which there are fixed maintenance intervals, there are other items that should operate satisfactorily without periodic maintenance. However, if a malfunction of these items does occur, it could adversely affect the engine or vehicle performance. These items should be inspected if a malfunction is observed or suspected.

ENGINE OIL

Checking Oil Level

To assure proper engine lubrication, the engine oil must be maintained at the correct level. Check the oil level at regular intervals, such as every fuel stop.

The best time to check the engine oil level is about 5 minutes after a fully warmed engine is shut off. Do not check oil level before starting the engine after it has sat overnight. Checking engine oil level when the engine is cold will give you an incorrect reading.

Checking the oil while the vehicle is on level ground and only when the engine is hot, will improve the accuracy of the oil level readings. Maintain the oil level between the range markings on the dipstick. Either the range markings consist of a crosshatch zone marked **SAFE** or a crosshatch zone marked with **MIN** at the low end of the range and **MAX** at the high end of the range. Adding one quart of oil when the reading is at the low end of the range marking will raise the oil level to the high end of the range marking.

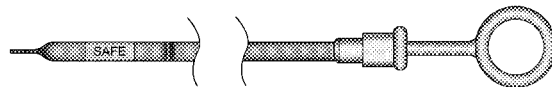

818168a4

Engine Oil Dipstick

CAUTION!

Do not overfill the engine. Overfilling the engine will cause oil aeration, which can lead to loss of oil pressure and an increase in oil temperature. This could damage your engine.

Change Engine Oil

The oil change indicator system will remind you that it is time to take your vehicle in for scheduled maintenance. Refer to “Maintenance Schedule” in Section 8 of this manual for information on this system.

NOTE: Under no circumstances should oil change intervals exceed 6,000 mi (10 000 km) or 6 months, whichever occurs first.

Engine Oil Selection

For best performance and maximum protection under all types of operating conditions, the manufacturer recommends engine oils that are API Certified and meet the requirements of DaimlerChrysler Material Standard MS-6395.

American Petroleum Institute (API) Engine Oil Identification Symbol

This symbol means that the oil has been certified by the American Petroleum Institute (API). The manufacturer only recommends API Certified engine oils.

Engine Oil Viscosity (SAE Grade) — 2.4L and 2.7L Engines

SAE 5W-20 engine oil is recommended for all operating temperatures. This engine oil improves low temperature starting and vehicle fuel economy. Your engine oil filler cap also shows the recommended engine oil viscosity for your vehicle.

The engine oil filler cap also shows the recommended engine oil viscosity for your engine. For information on engine oil filler cap location, refer to the “Engine Compartment” illustration in this section.

Lubricants which do not have both the engine oil certification mark and the correct SAE viscosity grade number should not be used.

Engine Oil Viscosity (SAE Grade) — 3.5L Engine

SAE 10W-30 engine oil is preferred for all operating temperatures. The engine oil filler cap also shows the recommended engine oil viscosity for your vehicle.

Lubricants which do not have both, the engine oil certification mark and the correct SAE viscosity grade number should not be used.

The engine oil filler cap also shows the recommended engine oil viscosity for your engine. For information on engine oil filler cap location, refer to the “Engine Compartment” illustration in this section.

Lubricants which do not have both, the engine oil certification mark and the correct SAE viscosity grade number should not be used.

Synthetic Engine Oils

You may use synthetic engine oils provided the recommended oil quality requirements are met, and the recommended maintenance intervals for oil and filter changes are followed.

Materials Added to Engine Oils

The manufacture strongly recommends against the addition of any additives (other than leak detection dyes) to the engine oil. Engine oil is an engineered product and it's performance may be impaired by supplemental additives.

Disposing of Used Engine Oil and Oil Filters

Care should be taken in disposing of used engine oil and oil filters from your vehicle. Used oil and oil filters, indiscriminately discarded, can present a problem to the environment. Contact your authorized dealer, service station, or governmental agency for advice on how and where used oil and oil filters can be safely discarded in your area.

ENGINE OIL FILTER

The engine oil filter should be replaced at every engine oil change.

Engine Oil Filter Selection

All of this manufacturer's engines have a full-flow type disposable oil filter. Use a filter of this type for replacement. The quality of replacement filters varies considerably. Only high quality filters should be used to assure most efficient service. Mopar® Engine Oil Filters are high quality oil filters and are recommended.

DRIVE BELT

At the mileage indicated in section 8: "Maintenance Schedule", replace the drive belt with a new drive belt.

NOTE: The belt must be routed correctly to ensure proper drive function.

SPARK PLUGS

Spark plugs must fire properly to assure engine performance and emission control. New plugs should be installed at the specified mileage. The entire set should be replaced if there is any malfunction due to a faulty spark plug. Refer to “Fluids, Lubricants, and Genuine Parts” in this section for the proper type of spark plug for use in your vehicle.

ENGINE AIR CLEANER FILTER

Refer to the “Maintenance Schedule” in Section 8 of this manual for engine air cleaner filter maintenance intervals.

NOTE: Be sure to follow the “dusty or off-road conditions” maintenance interval if applicable.

WARNING!

The air induction system (air cleaner, hoses, etc.) can provide a measure of protection in the case of engine backfire. Do not remove the air induction system (air cleaner, hoses, etc.) unless such removal is necessary for repair or maintenance. Make sure that no one is near the engine compartment before starting the vehicle with the air induction system (air cleaner, hoses, etc.) removed. Failure to do so can result in serious personal injury.

CATALYTIC CONVERTER

The catalytic converter requires the use of unleaded fuel only. Leaded gasoline will destroy the effectiveness of the catalyst as an emission control device.

Under normal operating conditions, the catalytic converter will not require maintenance. However, it is important to keep the engine properly tuned to assure proper catalyst operation and prevent possible catalyst damage.

CAUTION!

Damage to the catalytic converter can result if your vehicle is not kept in proper operating condition. In the event of engine malfunction, particularly involving engine misfire or other apparent loss of performance, have your vehicle serviced promptly. Continued operation of your vehicle with a severe malfunction could cause the converter to overheat, resulting in possible damage to the converter and the vehicle.

NOTE: Intentional tampering with emissions control systems can result in civil penalties being assessed against you.

WARNING!

A hot exhaust system can start a fire if you park over materials that can burn. Such materials might be grass or leaves coming into contact with your exhaust system. Do not park or operate your vehicle in areas where your exhaust system can contact anything that can burn.

In unusual situations involving grossly malfunctioning engine operation, a scorching odor may suggest severe and abnormal catalyst overheating. If this occurs, stop the vehicle, turn off the engine, and allow it to cool. Service, including a tune up to manufacturer's specifications, should be obtained immediately.

To minimize the possibility of catalyst damage:

- Do not shut off the engine or interrupt the ignition when the transaxle is in gear and the vehicle is in motion.
- Do not try to start the engine by pushing or towing the vehicle.
- Do not idle the engine with any ignition coil connectors disconnected for prolonged periods.

MAINTENANCE-FREE BATTERY

You will never have to add water, nor is periodic maintenance required.

NOTE: The battery is stored in a compartment behind the left front fender and is accessible without removing the tire and wheel. Remote battery terminals are located in the engine compartment for jump-starting.

To access the battery, turn the steering wheel fully to the right and remove the inner fender shield.

WARNING!

- **Battery fluid is a corrosive acid solution and can burn or even blind you. Don't allow battery fluid to contact your eyes, skin, or clothing. Don't lean over a battery when attaching clamps. If acid splashes in eyes or on skin, flush the area immediately with large amounts of water.**
- **Battery gas is flammable and explosive. Keep flame or sparks away from the battery. Don't use a booster battery or any other booster source with an output greater than 12 volts. Don't allow cable clamps to touch each other.**
- **Battery posts, terminals, and related accessories contain lead and lead compounds. Wash hands after handling.**

CAUTION!

- **It is essential when replacing the cables on the battery that the positive cable is attached to the positive post and the negative cable is attached to the negative post. Battery posts are marked positive (+) and negative (-) and identified on the battery case. Cable clamps should be tight on the terminal posts and free of corrosion. Apply grease to posts and clamps after tightening.**
- **If a “fast charger” is used while the battery is in the vehicle, disconnect both vehicle battery cables before connecting the charger to battery. Do not use a “fast charger” to provide starting voltage as battery damage can result.**

AIR CONDITIONER MAINTENANCE

For best possible performance, your air conditioner should be checked and serviced by an authorized dealer at the start of each warm season. This service should include cleaning of the condenser fins and a performance test. Drive belt tension should also be checked at this time.

WARNING!

- Use only refrigerants and compressor lubricants approved by the manufacturer for your air conditioning system. Some unapproved refrigerants are flammable and can explode, injuring you. Other unapproved refrigerants or lubricants can cause the system to fail, requiring costly repairs. Refer to Section 3 of the Warranty Information book for further warranty information.
- The air conditioning system contains refrigerant under high pressure. To avoid risk of personal injury or damage to the system, adding refrigerant or any repair requiring lines to be disconnected should be done by an experienced technician.

Refrigerant Recovery and Recycling

R-134a Air Conditioning Refrigerant is a hydrofluorocarbon (HFC) that is endorsed by the Environmental Protection Agency and is an ozone-saving product. However, the manufacturer recommends that air conditioning service be performed by authorized dealers or other service facilities using recovery and recycling equipment.

NOTE: Use only manufacturer approved A/C System Sealers, Stop Leak Products, Seal Conditioners, Compressor Oil, and Refrigerants.

A/C AIR FILTER — IF EQUIPPED

Refer to the “Maintenance Schedule” in Section 8 of this manual for A/C Air Filter service intervals.

WARNING!

Do not remove the A/C Air Filter while the blower is operating or personal injury may result.

The A/C Air Filter is located in the fresh air inlet behind the glove box. Perform the following procedure to replace the filter:

1. Open the glove box and remove all contents.
2. Push in on the sides of the glove box and pivot the glove box downward.
3. Disconnect the glove box door dampener from the slot on the side of the box. This is done by grasping the dampener connector (on the outside of the box) and the end of the connector pin (on the inside of the box) with your thumb and forefinger and pulling outward while lightly lifting upward on the door with your other hand. Once disconnected, the dampener will retract underneath the instrument panel if you release it.
4. Disengage the two retaining tabs that secure the filter cover to the HVAC housing and remove the cover.

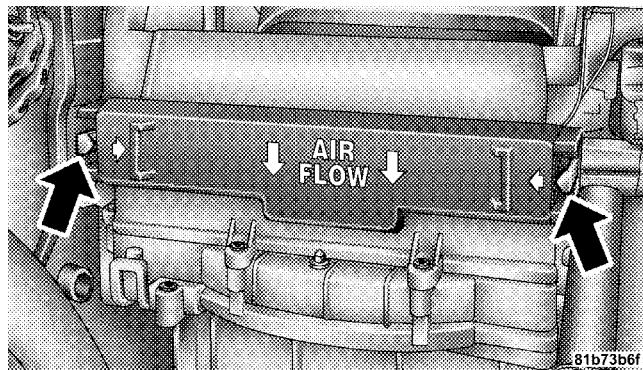

A/C Air Filter Replacement

5. Remove the A/C Air Filter by pulling it straight out of the housing.
6. Install the A/C Air Filter with the arrow on the filter pointing toward the floor. When installing the filter cover, make sure the retaining tabs fully engage the cover.

CAUTION!

The A/C Air Filter is labeled with an arrow to indicate airflow direction through the filter. Failure to install the filter properly will result in the need to replace it more often.

WARNING!

Fluid level should be checked on a level surface and with the engine off to prevent injury from moving parts and to ensure accurate fluid level reading. Do not overfill. Use only manufacturers recommended power steering fluid.

7. Reinstall the glove box door dampener and glove box.

POWER STEERING

Checking the power steering fluid level at a defined service interval is not required. The fluid should only be checked if a leak is suspected, abnormal noises are apparent, and/or the system is not functioning as anticipated. Coordinate inspection efforts through a certified DaimlerChrysler dealership.

If necessary, add fluid to restore to the proper indicated level. With a clean cloth, wipe any spilled fluid from all surfaces. Refer to “Fluids, Lubricants, and Genuine Parts” in this section for the correct fluid type.

FRONT SUSPENSION

There are two front suspension lower ball joints that are permanently lubricated. Inspect these ball joints when other maintenance is performed. A damaged seal and the corresponding potentially damaged ball joint must be replaced.

STEERING LINKAGE

The tie rod end ball joints should be inspected for external leakage and damage when other maintenance is performed.

BODY LUBRICATION

Locks and all body pivot points, including seat tracks, door hinges, trunk hinges, and hood hinges, should be lubricated periodically to assure quiet, easy operation and to protect against rust and wear. Prior to the application of any lubricant, the parts concerned should be wiped clean to remove dust and grit. After lubricating, excess oil and grease should be removed. Particular attention should also be given to hood latching components to ensure proper function. When performing other underhood services, the hood latch, release mechanism, and safety catch should be cleaned and lubricated.

The external lock cylinders should be lubricated twice a year, preferably in the fall and spring. Apply a small

amount of a high quality lubricant such as Mopar® Lock Cylinder Lubricant or equivalent directly into the lock cylinder.

WINDSHIELD WIPER BLADES

Clean the rubber edges of the wiper blades and the windshield periodically with a sponge or soft cloth and a mild non-abrasive cleaner or use the washer solvent. This will remove accumulations of salt, waxes, or road film and help reduce streaking and smearing.

Operation of the wipers on dry glass for long periods may cause deterioration of the wiper blades. Always use washer fluid when using the wipers to remove salt or dirt from a dry windshield.

Avoid using the wiper blades to remove frost or ice from the windshield. Make sure that they are not frozen to the glass before turning them on to avoid damaging the blade.

Keep the blade rubber out of contact with petroleum products such as engine oil, gasoline, etc.

NOTE: Always refer to the wiper blade packaging for specific installation instructions. Many wiper blade replacements fit multiple vehicles.

WINDSHIELD WASHERS

NOTE: Refer to the appropriate “Engine Compartment” diagram in Section 7 for the location of the windshield washer fluid reservoir.

The fluid reservoir for the windshield washers is located in the engine compartment. Be sure to check the fluid level in the reservoir at regular intervals. Fill the reservoir with windshield washer solvent (not radiator antifreeze) and operate the system for a few seconds to flush out the residual water.

WARNING!

Commercially available windshield washer solvents are flammable. They could ignite and burn you. Care must be exercised when filling or working around the washer solution.

EXHAUST SYSTEM

The best protection against carbon monoxide entry into the vehicle body is a properly maintained engine exhaust system.

If you notice a change in the sound of the exhaust system or if exhaust fumes can be detected inside the vehicle or when the underside or rear of the vehicle is damaged, have a competent technician inspect the complete exhaust system and adjacent body areas for broken, damaged, deteriorated, or mispositioned parts. Open seams or loose connections could permit exhaust fumes to seep

into the passenger compartment. In addition, inspect the exhaust system each time the vehicle is raised for an oil change or lubrication. Replace as required.

WARNING!

Exhaust gases can injure or kill. They contain carbon monoxide (CO) which is colorless and odorless. Breathing it can make you unconscious and can eventually poison you. To avoid breathing CO, refer to Exhaust Gas in the Safety Tips section of this manual.

COOLING SYSTEM

WARNING!

- **When working near the radiator cooling fan, disconnect the fan motor lead or turn the ignition switch to the LOCK position. The fan is temperature controlled and can start at anytime the ignition switch is in the ON position.**
- **You or others can be badly burned by hot coolant or steam from your radiator. If you see or hear steam coming from under the hood, don't open the hood until the radiator has had time to cool. Never try to open a cooling system pressure cap when the radiator is hot.**

Coolant Checks

Check engine coolant (antifreeze) protection every 12 months (before the onset of freezing weather, where applicable). If coolant is dirty or rusty in appearance, the system should be drained, flushed, and refilled with fresh coolant. Check the front of the A/C condenser for any accumulation of bugs, leaves, etc. If dirty, clean by gently spraying water from a garden hose vertically down the face of the condenser.

Check the coolant recovery bottle tubing for brittle rubber, cracking, tears, cuts, and tightness of the connection at the bottle and radiator. Inspect the entire system for leaks.

Cooling System — Drain, Flush, and Refill

The system should be drained, flushed, and refilled at the intervals shown in the “Maintenance Schedule” in Section 8 of this manual.

If the solution is dirty or contains a considerable amount of sediment, clean and flush with a reliable cooling system cleaner. Follow with a thorough rinsing to remove all deposits and chemicals. Properly dispose of old antifreeze solution.

Selection Of Coolant

Use only the manufacturer’s recommended coolant, refer to “Fluids, Lubricants, and Genuine Parts” for correct coolant type.

CAUTION!

- **Mixing of coolants other than specified HOAT engine coolants, may result in engine damage and may decrease corrosion protection. If a non-HOAT coolant is introduced into the cooling system in an emergency, it should be replaced with the specified coolant as soon as possible.**
- **Do not use plain water alone or alcohol-base engine coolant (antifreeze) products. Do not use additional rust inhibitors or antirust products, as they may not be compatible with the radiator engine coolant and may plug the radiator.**
- **This vehicle has not been designed for use with Propylene Glycol based coolants. Use of Propylene Glycol based coolants is not recommended.**

Adding Coolant

Your vehicle has been built with an improved engine coolant that allows extended maintenance intervals. This coolant can be used up to 5 Years or 100,000 mi (160 000 km) before replacement. To prevent reducing this extended maintenance period, it is important that you use the same coolant throughout the life of your vehicle. Please review these recommendations for using Hybrid Organic Additive Technology (HOAT) coolant.

When adding coolant:

- The manufacturer recommends using Mopar® Antifreeze/Coolant 5 Year/100,000 Mile Formula HOAT (Hybrid Organic Additive Technology).
- Mix a minimum solution of 50% HOAT engine coolant and distilled water. Use higher concentrations (not to exceed 70%) if temperatures below -34 F (-37 C) are anticipated.

- Use only high purity water such as distilled or deionized water when mixing the water/engine coolant solution. The use of lower quality water will reduce the amount of corrosion protection in the engine cooling system.

Please note that it is the owner's responsibility to maintain the proper level of protection against freezing according to the temperatures occurring in the area where the vehicle is operated.

NOTE: Mixing coolant types will decrease the life of the engine coolant and will require more frequent coolant changes.

Cooling System Pressure Cap

The cap must be fully tightened to prevent loss of coolant, and to ensure that coolant will return to the radiator from the coolant recovery bottle.

The cap should be inspected and cleaned if there is any accumulation of foreign material on the sealing surfaces.

WARNING!

- **The warning words "DO NOT OPEN HOT" on the cooling system pressure cap are a safety precaution. Never add coolant when the engine is overheated. Do not loosen or remove the cap to cool an overheated engine. Heat causes pressure to build up in the cooling system. To prevent scalding or injury, do not remove the pressure cap while the system is hot or under pressure.**
- **Do not use a pressure cap other than the one specified for your vehicle. Personal injury or engine damage may result.**

Disposal of Used Engine Coolant

Used ethylene glycol based engine coolant is a regulated substance requiring proper disposal. Check with your local authorities to determine the disposal rules for your community. To prevent ingestion by animals or children, do not store ethylene glycol based engine coolant in open containers or allow it to remain in puddles on the ground. If ingested by a child, contact a physician immediately. Clean up any ground spills immediately.

Coolant Level

4 Cylinder Engines — the coolant bottle provides a quick visual method for determining that the coolant level is adequate. With the engine idling and warm to normal operating temperature, the level of the coolant in the bottle should be between the “ADD” and “FULL” lines, shown on the bottle.

6 Cylinder Engines — the level of the coolant in the pressurized coolant bottle should be between the “COLD” and “FULL” range on the bottle when the engine is cold.

The radiator normally remains completely full, so there is no need to remove the radiator cap unless checking for coolant freeze point or replacing coolant. Advise your service attendant of this. As long as the engine operating temperature is satisfactory, the coolant bottle need only be checked once a month. When additional coolant is needed to maintain the proper level, it should be added to the coolant bottle. Do not overfill.

Points To Remember

NOTE: When the vehicle is stopped after a few miles (kilometers) of operation, you may observe vapor coming from the front of the engine compartment. This is normally a result of moisture from rain, snow, or high

humidity accumulating on the radiator and being vaporized when the thermostat opens, allowing hot coolant to enter the radiator.

If an examination of your engine compartment shows no evidence of radiator or hose leaks, the vehicle may be safely driven. The vapor will soon dissipate.

- Do not overfill the coolant recovery bottle.
- Check coolant freeze point in the radiator and in the coolant recovery bottle. If antifreeze needs to be added, contents of coolant recovery bottle must also be protected against freezing.
- If frequent coolant additions are required, or if the level in the coolant recovery bottle does not drop when the engine cools, the cooling system should be pressure tested for leaks.
- Maintain coolant concentration at 50% HOAT engine coolant (minimum) and distilled water for proper corrosion protection of your engine, which contains aluminum components.
- Make sure that the radiator and coolant recovery bottle overflow hoses are not kinked or obstructed.
- Keep the front of the radiator clean. If your vehicle is equipped with air conditioning, keep the front of the condenser clean, also.
- Do not change the thermostat for summer or winter operation. If replacement is ever necessary, install **ONLY** the correct type thermostat. Other designs may result in unsatisfactory coolant performance, poor gas mileage, and increased emissions.

HOSES AND VACUUM/VAPOR HARNESSSES

Inspect surfaces of hoses and nylon tubing for evidence of heat and mechanical damage. Hard or soft spots, brittle rubber, cracking, tears, cuts, abrasions, and excessive swelling indicate deterioration of the rubber

Pay particular attention to the hoses nearest to high heat sources such as the exhaust manifold. Inspect hose routing to be sure hoses do not touch any heat source or moving component that may cause heat damage or mechanical wear.

Ensure nylon tubing in these areas has not melted or collapsed

Inspect all hose connections such as clamps and couplings to make sure they are secure and no leaks are present.

Components should be replaced immediately if there is any evidence of degradation that could cause failure.

FUEL SYSTEM

Electronic Fuel Injection high-pressure fuel systems are designed with tubes and special connects, connections, and clamps which have unique material characteristics to provide adequate sealing and resist attack by deteriorated gasoline.

You are urged to use only the manufactures-specified tubes, connections and clamps, or their equivalent in material and specification, in any fuel system servicing.

BRAKE SYSTEM

In order to assure brake system performance, all brake system components should be inspected periodically. Suggested service intervals can be found in the "Maintenance Schedule" in this manual.

WARNING!

Riding the brakes can lead to brake failure and possibly an accident. Driving with your foot resting or riding on the brake pedal can result in abnormally high brake temperatures, excessive lining wear, and possible brake damage. You wouldn't have your full braking capacity in an emergency.

Brake And Power Steering Hoses

When servicing the vehicle for scheduled maintenance, inspect the surface of the hoses and nylon tubing for evidence of heat and mechanical damage. Hard and brittle rubber, cracking, tears, cuts, abrasions, and excessive swelling suggest deterioration of the rubber. Particular attention should be made to examining those hose surfaces nearest to high heat sources, such as the exhaust manifold.

Ensure nylon tubing in these areas has not melted or collapsed.

Inspect all hose clamps and couplings to make sure they are secure and no leaks are present.

NOTE:

- Often, fluids such as oil, power steering fluid, and brake fluid are used during assembly plant operations to ease the assembly of hoses to couplings. Therefore, oil wetness at the hose-coupling area is not necessarily an indication of leakage. Actual dripping of hot fluid when systems are under pressure (during vehicle operation) should be noted before a hose is replaced based on leakage.
- Inspect the brake hoses whenever the brake system is serviced and at every engine oil change. Inspect hydraulic brake hoses for surface cracking, scuffing, or worn spots. If there is any evidence of cracking, scuffing, or worn spots, the hose should be replaced

immediately! Eventual deterioration of the hose can take place resulting in a possibility of a burst failure.

WARNING!

Worn brake hoses can burst and cause brake failure. You could have an accident. If you see any signs of cracking, scuffing, or worn spots, have the brake hoses replaced immediately.

Master Cylinder - Brake Fluid Level Check

Check the fluid level in the master cylinder immediately if the brake system warning light indicates system failure.

Check the fluid level in the master cylinder when performing underhood services.

Clean the top of the master cylinder area before removing the cap. If necessary, add fluid to bring the fluid level up to the requirements described on the brake fluid reservoir.

Overfilling of fluid is not recommended because it may cause leaking in the system.

Fluid level can be expected to fall as the brake pads wear. Brake fluid level should be checked when pads are replaced. However, low fluid level may be caused by a leak and a checkup may be needed.

Use only manufacturers recommended brake fluid. Refer to "Fluids, Lubricants, and Genuine Parts" for the correct fluid type.

WARNING!

- **Overfilling the brake fluid reservoir can result in spilling brake fluid on hot engine parts and the brake fluid catching fire.**
- **Use of a brake fluid that has a lower initial boiling point than the recommended MOPAR® DOT 3 product or a brake fluid that is unidentified as to FMVSS specification may result in sudden brake failure during hard prolonged braking. You could have an accident.**

Use only brake fluid that has been in a tightly closed container to avoid contamination from foreign matter or moisture.

CAUTION!

Do not allow petroleum base fluid to contaminate the brake fluid, all brake seal components could be damaged causing partial or complete brake failure.

AUTOMATIC TRANSAXLE

The automatic transaxle and differential assembly are contained within a single housing.

The fluid level in the automatic transaxle should be checked whenever the vehicle is serviced. Operation with an improper fluid level will greatly reduce the life of the transaxle and the fluid.

Fluid Level Check — Vehicles with 3.5L Engine

The automatic transaxle has no dipstick and is dealer serviced only.

Fluid Level Check — Vehicles with 2.4L and 2.7L Engines

Use the following procedure to check the automatic transaxle fluid level properly:

1. Park the vehicle on level ground.
2. Run the engine at curb idle speed for a minimum of 60 seconds.
3. Apply the parking brake fully.
4. Place the gear selector momentarily in each gear position ending with the lever in PARK.
5. Wipe the area around the dipstick clean to eliminate the possibility of dirt entering the transaxle.
6. Remove the dipstick and determine if the fluid is hot or cold. Hot fluid is approximately 180 F (82 C), which is the normal operating temperature after the vehicle is

driven at least 15 mi (24 km). Hot fluid cannot be held comfortably between the fingertips. Cold fluid is at a temperature below 80 F (27 C).

7. Wipe the dipstick clean and reinsert until seated. Then, remove dipstick and note the reading.
 - a. If the fluid is hot, the reading should be in the crosshatched area marked "HOT" (between the upper two holes in the dipstick).
 - b. If the fluid is cold, the fluid level should be between the lower two holes in the area marked "COLD."

If the fluid level is low, add sufficient fluid through the filler (dipstick) tube to bring it to the proper level. Do not overfill.

CAUTION!

- **Using a transmission fluid other than the manufacturer's recommended fluid may cause deterioration in transmission shift quality and/or torque converter shudder. Using a transmission fluid other than that recommended by the manufacturer will result in more frequent fluid and filter changes. Refer to "Fluids, Lubricants, and Genuine Parts" for the correct fluid type.**
- **Dirt and water in the transaxle can cause serious damage. To prevent dirt and water from entering the transaxle after checking or replenishing fluid, make certain that the dipstick cap is re-seated properly.**

Transmission Fluid and Filter Changes

Change the automatic transaxle fluid and filter at the intervals shown in the "Maintenance Schedule" in this manual.

In addition, change the fluid and filter if the transaxle is disassembled for any reason.

Special Additives

Automatic Transmission Fluid (ATF) is an engineered product and its performance may be impaired by supplemental additives. Therefore, do not add any fluid additives to the transaxle. The only exception to this policy is the use of special dyes to aid in detecting fluid leaks. In addition, avoid using transmission sealers as they may adversely affect seals.

FRONT AND REAR WHEEL BEARINGS

Front and rear wheel bearings are permanently sealed. No regular maintenance is required for these components.

APPEARANCE CARE AND PROTECTION FROM CORROSION

Protection of Body and Paint from Corrosion

Vehicle body care requirements vary according to geographic locations and usage. Chemicals that make roads passable in snow and ice and those that are sprayed on trees and road surfaces during other seasons are highly corrosive to the metal in your vehicle. Outside parking, which exposes your vehicle to airborne contaminants, road surfaces on which the vehicle is operated, extreme hot or cold weather and other extreme conditions will have an adverse effect on paint, metal trim, and underbody protection.

The following maintenance recommendations will enable you to obtain maximum benefit from the corrosion resistance built into your vehicle.

What Causes Corrosion?

Corrosion is the result of deterioration or removal of paint and protective coatings from your vehicle.

The most common causes are:

- Road salt, dirt, and moisture accumulation.
- Stone and gravel impact.
- Insects, tree sap, and tar.
- Salt in the air near seacoast localities.
- Atmospheric fallout/industrial pollutants.

Washing

- Wash your vehicle regularly. Always wash your vehicle in the shade using Mopar® Car Wash or a mild car wash soap, and rinse the panels completely with clear water.
- If insects, tar, or other similar deposits have accumulated on your vehicle, use Mopar® Super Kleen Bug and Tar Remover to remove.
- Use Mopar® Cleaner Wax to remove road film, stains and to protect your paint finish. Take care never to scratch the paint.
- Avoid using abrasive compounds and power buffing that may diminish the gloss or thin out the paint finish.

CAUTION!

Do not use abrasive or strong cleaning materials such as steel wool or scouring powder, which will scratch metal and painted surfaces.

Special Care

- If you drive on salted or dusty roads or if you drive near the ocean, hose off the undercarriage at least once a month.
- It is important that the drain holes in the lower edges of the doors, rocker panels, and trunk be kept clear and open.
- If you detect any stone chips or scratches in the paint, touch them up immediately. The cost of such repairs is considered the responsibility of the owner.

- If your vehicle is damaged due to an accident or similar cause which destroys the paint and protective coating, have your vehicle repaired as soon as possible. The cost of such repairs is considered the responsibility of the owner.
- If you carry special cargo such as chemicals, fertilizers, de-icer salt, etc., be sure that such materials are well packaged and sealed.
- If a lot of driving is done on gravel roads, consider mud or stone shields behind each wheel.
- Use Mopar® touch up paint on scratches as soon as possible. Your authorized dealer has touch up paint to match the color of your vehicle.

Wheel and Wheel Trim Care

All wheels and wheel trim, especially aluminum and chrome plated wheels, should be cleaned regularly with a mild soap and water to prevent corrosion. To remove

heavy soil and/or excessive brake dust, use Mopar® Wheel Cleaner (05066247AB) or equivalent or select a nonabrasive, non-acidic cleaner. Do not use scouring pads, steel wool, a bristle brush, or metal polishes. Only Mopar® or equivalent is recommended. Do not use oven cleaner. Avoid automatic car washes that use acidic solutions or harsh brushes that may damage the wheels' protective finish.

Cleaning Headlights

Your vehicle has plastic headlights that are lighter and less susceptible to stone breakage than glass headlights.

Plastic is not as scratch resistant as glass and therefore different lens cleaning procedures must be followed.

To minimize the possibility of scratching the lenses and reducing light output, avoid wiping with a dry cloth. To remove road dirt, wash with a mild soap solution followed by rinsing.

Do not use abrasive cleaning components, solvents, steel wool or other aggressive material to clean the lenses.

Interior Care

Instrument Panel Cover

The instrument panel cover has a low glare surface, which minimizes reflections in the windshield. Do not use protectants or other products, which may cause undesirable reflections. Use soap and warm water to restore the low glare surface.

Cleaning Interior Trim

Interior Trim should be cleaned starting with a damp cloth, a damp cloth with Mopar® Total Clean, then Mopar® Spot & Stain Remover if absolutely necessary. Do not use harsh cleaners or Armorall. Use Mopar® Total Clean to clean vinyl upholstery

Cleaning Leather Upholstery

Mopar® Total Clean is specifically recommended for leather upholstery.

Your leather upholstery can be best preserved by regular cleaning with a damp soft cloth. Small particles of dirt can act as an abrasive and damage the leather upholstery and should be removed promptly with a damp cloth. Stubborn soils can be removed easily with a soft cloth and Mopar® Total Clean. Care should be taken to avoid soaking your leather upholstery with any liquid. Please do not use polishes, oils, cleaning fluids, solvents, detergents, or ammonia-based cleaners to clean your leather upholstery. Application of a leather conditioner is not required to maintain the original condition.

WARNING!

Do not use volatile solvents for cleaning purposes. Many are potentially flammable, and if used in closed areas they may cause respiratory harm.

YES Essentials® Fabric Cleaning Procedure – If Equipped

YES Essentials® seats may be cleaned in the following manner:

- Remove as much of the stain as possible by blotting with a clean, dry towel.
- Blot any remaining stain with a clean, damp towel.
- For tough stains, apply Mopar® Total Clean or a mild soap solution to a clean, damp cloth and remove stain. Use a fresh, damp towel to remove soap residue.

- For grease stains, apply Mopar® Multi-Purpose Cleaner to a clean, damp cloth and remove stain. Use a fresh, damp towel to remove soap residue.
- Do not use any solvents or protectants on Yes Essentials® products.

Glass Surfaces

All glass surfaces should be cleaned on a regular basis with Mopar® Glass Cleaner or any commercial household-type glass cleaner. Never use an abrasive type cleaner. Use caution when cleaning the inside rear window equipped with electric defrosters or the right rear quarter window equipped with the radio antenna. Do not use scrapers or other sharp instruments, which may scratch the elements.

When cleaning the rear view mirror, spray cleaner on the towel or rag that you are using. Do not spray cleaner directly on the mirror.

Cleaning Plastic Instrument Cluster Lenses

The lenses in front of the instruments in this vehicle are molded in clear plastic. When cleaning the lenses, care must be taken to avoid scratching the plastic.

1. Clean with a wet, soft rag. A mild soap solution may be used, but do not use high alcohol content or abrasive cleaners. If soap is used, wipe clean with a clean damp rag.
2. Dry with a soft tissue.

Seat Belt Maintenance

Do not bleach, dye, or clean the belts with chemical solvents or abrasive cleaners. This will weaken the fabric. Sun damage can also weaken the fabric.

If the belts need cleaning, use a mild soap solution or lukewarm water. Do not remove the belts from the car to wash them.

Replace the belts if they appear frayed or worn or if the buckles do not work properly.

Dry with a soft tissue.

CLEANING CENTER CONSOLE CUPHOLDERS

Removal

Grab the rubber portion of the cupholder and lift upward.

Cleaning

Soak the rubber cupholder liner in a mixture of medium hot tap water and one teaspoon of mild liquid dish soap. Let soak for approximately one hour. After one hour pull the liner from the water and dip it back into the water about six times. This will loosen any remaining debris. Rinse the liner thoroughly under warm running water. Shake the excess water from the liner and dry the outer surfaces with a clean soft cloth.

Installation

Align the liner in the cupholder and press down firmly.

FUSES — TOTALLY INTEGRATED POWER MODULE (TIPM)

The TIPM is located in the engine compartment near the air cleaner assembly. This center contains cartridge fuses and mini fuses. A label that identifies each component may be printed on the inside of the cover. Refer to the following chart for FUSES/TIPM location.

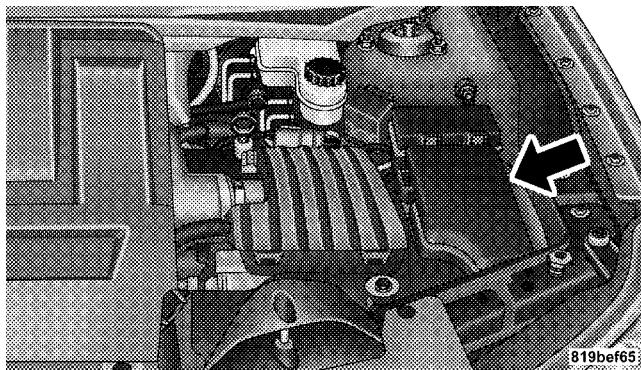

TIPM Fuse and Relay Center

Cavity	Cartridge Fuse	Mini Fuse	Description
1	40 Amp Green	—	—

Cavity	Cartridge Fuse	Mini Fuse	Description
2	—	20 Amp Yellow	—
3	—	10 Amp Red	Battery Feed — Center High Mounted Stop Light (CHMSL)/ Brake Switch
4	—	10 Amp Red	Battery Feed — Ignition Switch
5	—	20 Amp Yellow	Trailer Tow — If Equipped
6	—	10 Amp Red	Ignition Off Draw (IOD) — Power Mirror Switch/Climate Controls
7	—	30 Amp Green	Ignition Off Draw (IOD) Sense 1

Cavity	Cartridge Fuse	Mini Fuse	Description
8	—	30 Amp Green	Ignition Off Draw (IOD) Sense 2
9	40 Amp Green		Battery Feed — Power Seats - if equipped/PZEV Air Pump - if equipped
10	—	20 Amp Yellow	Battery Feed — Cabin Compartment Node (CCN)
11	—	15 Amp Lt Blue	Selectable Power Outlet
12	—	20 Amp Yellow	—
13	—	20 Amp Yellow	—

Cavity	Cartridge Fuse	Mini Fuse	Description
14	—	10 Amp Red	Ignition Off Draw (IOD) — Cabin Compartment Node (CCN)/ Interior Lighting
15	40 Amp Green	—	Battery Feed — Radiator Fan Relay
16	—	15 Amp Lt. Blue	IGN Run/ACC — Cigar Lighter/PWR Sunroof Mod
17	—	10 Amp Red	Ignition Off Draw (IOD) — Wireless Control Module (WCM)/Clock/Steering Control Module (SCM)

Cavity	Cartridge Fuse	Mini Fuse	Description
18	40 Amp Green	—	Battery Feed — Auto Shutdown (ASD) Relay
19	—	20 Amp Yellow	Ignition Off Draw (IOD) — Power Amp Feed 2 - if equipped
20	—	15 Amp Lt. Blue	Ignition Off Draw (IOD) — Radio
21	—	10 Amp Red	—
22	—	10 Amp Red	Ignition Run — Climate Controls/Hot Cupholder - if equipped
23	—	15 Amp Lt. Blue	Auto Shutdown (ASD) Relay Feed 3

Cavity	Cartridge Fuse	Mini Fuse	Description
24	—	25 Amp Clear	Battery Feed — PWR Sunroof Feed
25	—	10 Amp Red	Ignition Run — Heated Mirrors - If Equipped
26	—	15 Amp Lt. Blue	Auto Shutdown (ASD) Relay Feed 2
27	—	10 Amp Red	Ignition Run — Occupant Classification Module (OCM)/ Occupant Restraint Controller (ORC)

Cavity	Cartridge Fuse	Mini Fuse	Description
28	—	10 Amp Red	Ignition Run — Occupant Classification Module (OCM)/ Occupant Restraint Controller (ORC)
29	—	—	Hot Car (No Fuse Required)
30	—	20 Amp Yellow	Ignition Run — Heated Seats - If Equipped
31	—	10 Amp Red	—
32	30 Amp Pink	—	Auto Shutdown (ASD) Relay Feed 1

Cavity	Cartridge Fuse	Mini Fuse	Description
33	—	10 Amp Red	Battery Feed — Switch Bank/ Diagnostic Link Connector/ Powertrain Control Module (PCM)
34	30 Amp Pink	—	Battery Feed — Anti-Lock Brakes (ABS) Module - if equipped/Electronic Stability Program (ESP) Module - If Equipped

Cavity	Cartridge Fuse	Mini Fuse	Description
35	40 Amp Green	—	Battery Feed — Anti-Lock Brakes (ABS) Module - If Equipped/Electronic Stability Program (ESP) Module - If Equipped
36	30 Amp Pink	—	Battery Feed — Passenger Door Module (PDM)/Driver Door Module (DDM)
37	—	25 Amp Clear	—

CAUTION!

- When installing the Totally Integrated Power Module cover, it is important to ensure the cover is properly positioned and fully latched. Failure to do so may allow water to get into the Totally Integrated Power Module, and possibly result in an electrical system failure.
- When replacing a blown fuse, it is important to use only a fuse having the correct amperage rating. The use of a fuse with a rating other than indicated may result in a dangerous electrical system overload. If a properly rated fuse continues to blow, it indicates a problem in the circuit that must be corrected.

VEHICLE STORAGE

If you will not be using your vehicle for more than 21 days, you may want to take steps to preserve your battery.

- Disengage the mini-fuse in the Power Distribution Center labeled IOD (Ignition Off-Draw).
- Disconnect the negative cable from the battery.

REPLACEMENT BULBS

All the inside bulbs are brass or glass wedge base. Aluminum base bulbs are not approved and should not be used for replacement.

LIGHT BULBS — Interior

Bulb Number

Front Courtesy/Reading Lights	578/W5W
Center Courtesy/Reading Lights	578/W5W
Visor Vanity Lights	A6220
Glove Box Light	194
Shift Indicator Light	JKLE14140
Rear Compartment (Trunk) Light	579

NOTE: For lighted switches, see your authorized dealer for replacement instructions.

LIGHTS BULBS — Outside	Bulb No.
Low Beam Headlight	9006
High Beam Headlight.	9005
Front Park/Turn Signal/Side Marker Light . . .	3157AK
Front Fog Light	9145//H10
Center High Mounted Stop Light (CHMSL)	W16W (921)
Rear Tail/Stop.	3157K
Decklid Tail Light.	T3.25
Rear Turn Signal	3157AK
Backup Light.	3157K
License Light	168

BULB REPLACEMENT

Headlight Bulb Replacement

1. Raise the hood and locate the connector behind the headlamp.

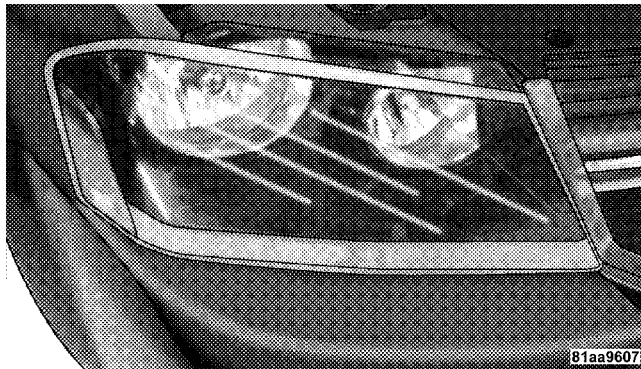

Headlight

2. Reach into engine compartment and from behind the lamp assembly and grasp the connector.

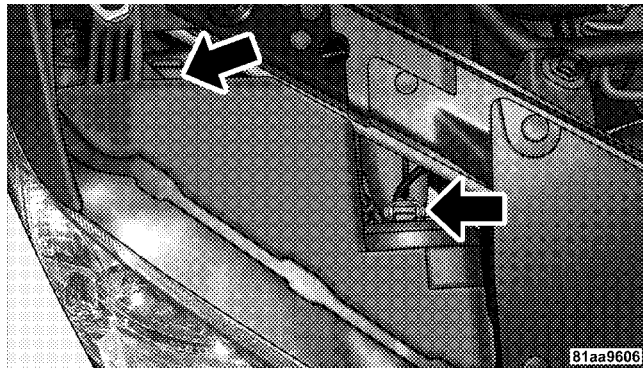

Headlight Housing - Rear View

3. Rotate bulb and connector $\frac{1}{4}$ turn and pull outward from assembly.

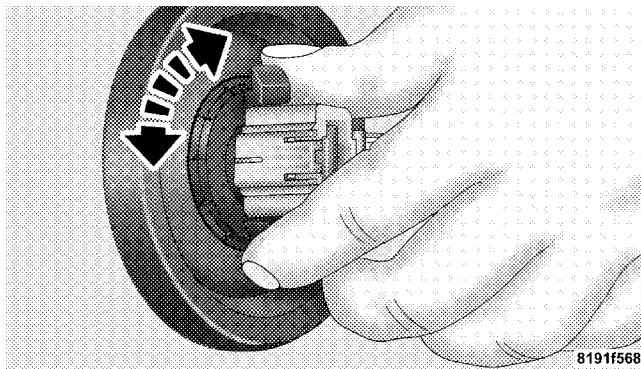

Twisting Bulb From Socket

CAUTION!

Do not touch the new bulb with your fingers. Oil contamination will severely shorten bulb life.

4. Pull the bulb out of the socket and replace the bulb.

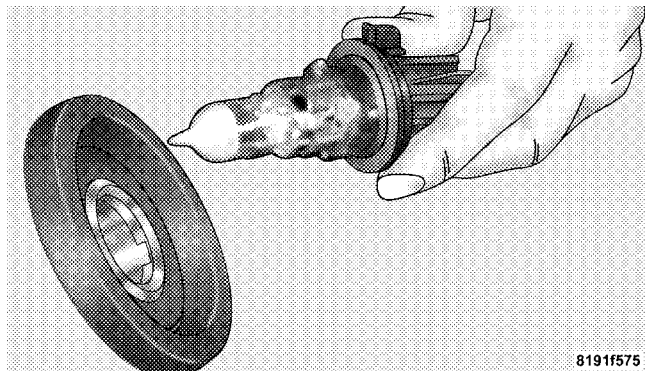

Removing Halogen Bulb From Assembly

5. If the bulb comes in contact with any oily surface, clean the bulb with rubbing alcohol.

6. Reinsert the bulb and socket assembly and rotate clockwise $\frac{1}{4}$ turn to secure.

Fog Lights

1. Access to the lights through the lower fascia cutout is limited.
2. We recommend you access the lights by turning the steering wheel to allow access and remove the inner fender shield.

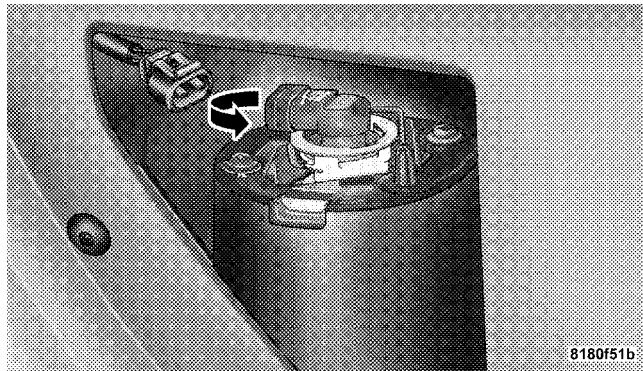

Fog Light and Connector

3. Rotate bulb and connector $\frac{1}{4}$ turn counterclockwise.
4. Pull bulb off of connector and replace with a new one.

CAUTION!

Do not touch the new bulb with your fingers. Oil contamination will severely shorten bulb life. If the bulb comes in contact with an oily surface, clean the bulb with rubbing alcohol.

Taillights, Rear Turn Signals And Backup Lights — Replacement

The turn signal, brake and taillights and backup lights are located in the rear corner body panel housing.

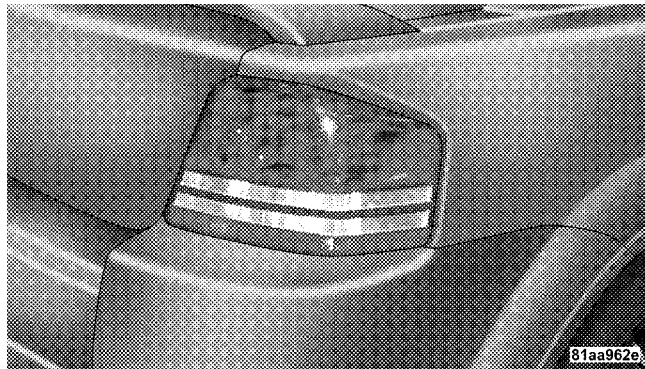

Rear Tail Light

Changing the Rear Corner Taillight Bulbs

1. Open the trunk and gently pull back the trunk liner behind the taillight.

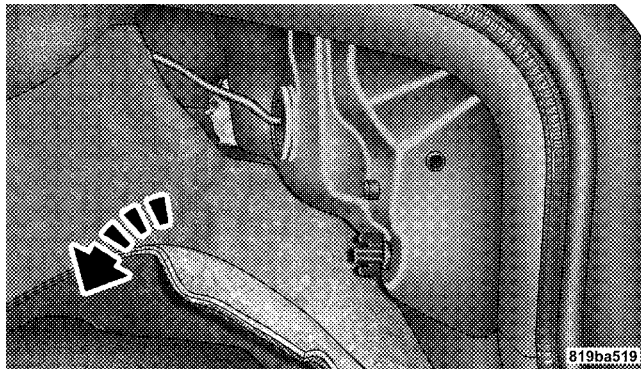

Pull Back Trunk Liner

2. Remove the two plastic wing nuts from the taillight housing.

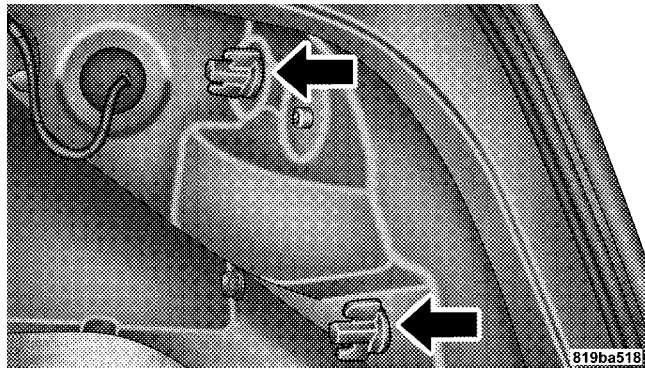

Location Plastic Wing Nuts

3. Grasp the taillight and pull firmly outward pushing gently on the studs from inside to disengage the light housing.

4. Twist and remove socket from light.
5. Remove bulb from socket and replace.

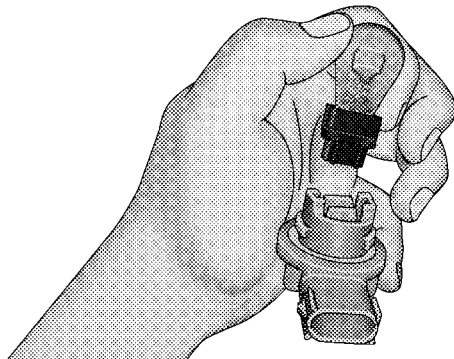

Changing Tail Light Bulb

81aa98c0

License Plate Light — Rear

1. Remove two retaining screws holding the light lens in place.

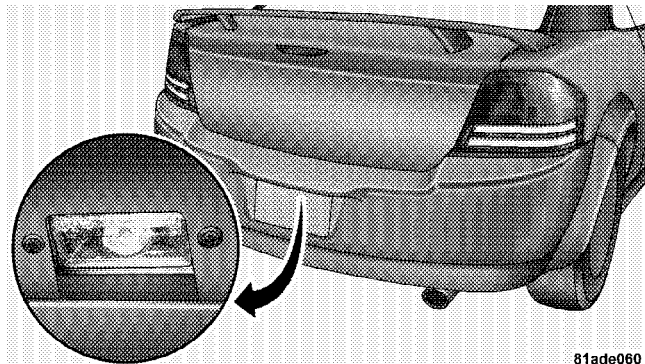

81ade060

Location and Removal of Rear License Light Assembly

2. Gently pry the light assembly loose.

3. Pull bulb from socket, replace and reattach the light assembly with the two retaining screws.

Center High-Mounted Stop Light

1. Open the trunk lid to find the centrally located high-mounted stop light.

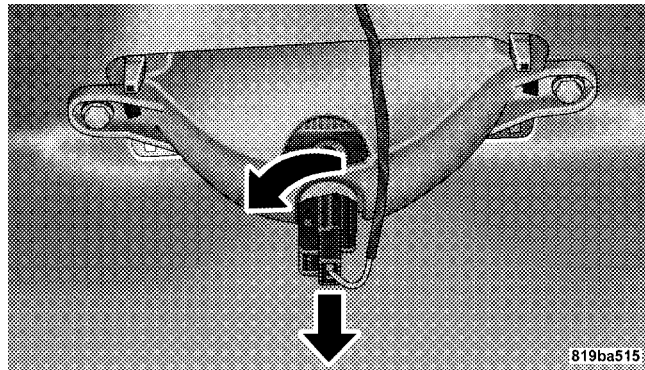

819ba515

High-mounted Stop Light Bulb Replacement

2. Twist and remove socket from the back of the light housing.

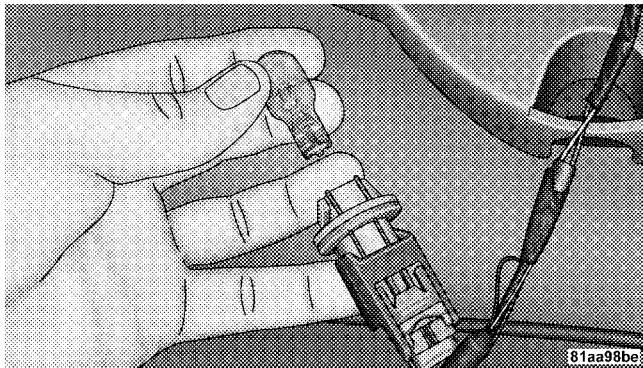

Changing High Mount Stop Light Bulb

3. Replace the bulb and reinstall the socket into the housing by locking it in place with a twist.

FLUIDS AND CAPACITIES

FLUIDS AND CAPACITIES		
Engine	U.S.	Metric
Fuel (approximate)		
All FWD Engines — (Except 2.4L PZEV)	16.9 Gals	64 L
3.5L Engine with AWD (All Wheel Drive)	17.3 Gals	65.5 L
2.4L PZEV (Partial Zero Emissions Vehicle)	18.4 Gals	69.7 L
Engine Oil with Filter		
2.4 Liter Engine (SAE 5W-20, API Certified)	4.5 Qts	4.26 L
2.7 Liter Engine (SAE 5W-20, API Certified)	5.5 Qts	5.2 L
3.5 Liter Engine (SAE 10W-30, API Certified)	5.5 Qts	5.2 L

FLUIDS AND CAPACITIES		
Engine	U.S.	Metric
Cooling System *		
2.4 Liter Engine (Mopar® Antifreeze/Coolant 5 Year/ 100,000 Mile Formula) or equivalent.	7.7 Qts	7.3 L
2.7 Liter Engine (Mopar® Antifreeze/Coolant 5 Year/ 100,000 Mile Formula) or equivalent.	9.8 Qts	9.3 L
3.5 Liter Engine (Mopar® Antifreeze/Coolant 5 Year/ 100,000 Mile Formula) or equivalent.	11.6 Qts	11.0 L
* Includes heater and coolant recovery bottle filled to MAX level.		

FLUIDS, LUBRICANTS, AND GENUINE PARTS**Engine**

Component	Fluids, Lubricants, and Genuine Parts
Engine Coolant	Mopar® Antifreeze/Coolant 5 Year/100,000 Mile Formula HOAT (Hybrid Organic Additive Technology) or equivalent
Engine Oil (2.4L, 2.7L)	Use API Certified engine oil. SAE 5W-20 is recommended. Refer to the engine oil fill cap for the correct SAE grade meeting DaimlerChrysler Material Standard MS-6395.
Engine Oil (3.5L)	Use API Certified engine oil. SAE 10W-30 is recommended. Refer to the engine oil viscosity chart for the correct SAE grade meeting DaimlerChrysler Material Standard MS-6395.
Oil Filter (2.4L)	Mopar® 04884900AB or equivalent.
Oil Filter (2.7L, 3.5L)	Mopar® 04884899AB or equivalent.
Spark Plugs (2.4L - EXCEPT PZEV*)	ZFR5F-11 (Gap.043 in [1.11 mm])
Spark Plugs (2.4L— with PZEV)	ZFR5AP (Gap.031 in [0.8 mm])

Component	Fluids, Lubricants, and Genuine Parts
Spark Plugs (2.7L)	RE14PMC5 (Gap.050 in [1.27 mm])
Spark Plugs (3.5L)	ZFR5LP-13G (Gap.050 in [1.27 mm])
Fuel Selection (2.4L, 2.7L)	87 Octane
Fuel Selection (2.7L - EXCEPT CALIFORNIA EMISSION STATES)	E-85 Ethanol
Fuel Selection (3.5L)	87 to 89 Octane
* PZEV = Partial Zero Emission Vehicle	

Chassis

Component	Fluids, Lubricants and Genuine Parts
Automatic Transaxle	Mopar® ATF+4 Automatic Transmission Fluid.
Brake Master Cylinder	Mopar® DOT 3 and SAE J1703 should be used. If DOT 3 brake fluid is not available, then DOT 4 is acceptable. Use only recommended brake fluids.
Power Steering Reservoir	Mopar® ATF+4 Automatic Transmission Fluid.

MAINTENANCE SCHEDULES

CONTENTS

<p>■ Emissions Control System Maintenance426</p> <p>■ Maintenance Schedule426</p>	<p>□ Required Maintenance Intervals429</p>
---	--

EMISSIONS CONTROL SYSTEM MAINTENANCE

The Scheduled Maintenance services listed in **bold type**, must be done at the times or mileages specified to ensure the continued proper functioning of the Emissions Control System. These, and all other maintenance services included in this manual, should be done to provide best vehicle performance and reliability. More frequent maintenance may be needed for vehicles in severe operating conditions, such as dusty areas and very short trip driving.

Inspection and service should also be done anytime a malfunction is suspected.

NOTE: Maintenance, replacement, or repair of the emissions control devices and systems on your vehicle may be performed by any automotive repair establishment or individual using any automotive part that has been certified pursuant to U.S. EPA or in the State of California, California Air Resources Board regulations.

MAINTENANCE SCHEDULE

The oil change indicator system will remind you that it is time to take your vehicle in for scheduled maintenance.

On Electronic Vehicle Information Center (EVIC) equipped vehicles, “Oil Change Required” will be displayed in the EVIC and a single chime will sound, indicating that an oil change is necessary.

On Non-EVIC equipped vehicles, “Change Oil” will flash in the instrument cluster odometer and a single chime will sound, indicating that an oil change is necessary.

Based on engine operation conditions, the oil change indicator message will illuminate which means service is required for your vehicle. Have your vehicle serviced as soon as possible, within the next 500 mi (805 km).

NOTE:

- The oil change indicator message will not monitor the time since the last oil change. Change your vehicle’s

oil if it has been six months since your last oil change even if the oil change indicator message is NOT illuminated.

- Change your engine oil more often if you drive your vehicle off-road for an extended period of time.
- Under no circumstances should oil change intervals exceed 6,000 mi (10 000 km) or six months, whichever comes first.

Your authorized dealer will reset the oil change indicator message after completing the scheduled oil change. If a scheduled oil change is performed by someone other than your authorized dealer, the message can be reset by referring to the steps described under “Oil Change Required” under “Electronic Vehicle Information Center (EVIC)” in Section 4 or under “Odometer/Trip Odometer” under “Instrument Cluster Descriptions” in Section 4.

At Each Stop for Fuel

- Check the engine oil level about five minutes after a fully warmed engine is shut off. Checking the oil level while the vehicle is on level ground will improve the accuracy of the oil level reading. Add oil only when the level is at or below the SAFE or MIN mark.
- Check the windshield washer solvent and add if required.

Once a Month

- Check tire pressure and look for unusual wear or damage.
- Inspect the battery and clean and tighten the terminals as required.
- Check the fluid levels of coolant reservoir, brake master cylinder, power steering, and automatic trans-axle, and add fluid as needed.

NOTE: Six-speed AutoStick® Transaxle, if equipped, is sealed therefore, checking the fluid level can only be done by a certified dealership service center.

- Check all lights and other electrical items for correct operation.

At Each Oil Change

- Change the engine oil filter.
- Inspect the brake hoses and lines.

CAUTION!

Failure to perform the required maintenance items may result in damage to the vehicle.

Required Maintenance Intervals

Maintenance Items	Perform Maintenance Every (Where time and mileage are listed, follow the interval that occurs first.)		
	Miles	Kilometers	or Months
Change the engine oil and engine oil filter.	6,000	10 000	6
Rotate the tires.	6,000	10 000	6
If using your vehicle in dusty or off-road conditions, inspect the engine air cleaner filter, and replace if necessary.	12,000	20 000	12
Inspect the brake linings, and replace if necessary.	12,000	20 000	12
Replace the air conditioning filter (if equipped).	12,000	20 000	12
Inspect the Constant Velocity (CV) joints. Perform the first inspection at 12,000 mi (20 000 km) or 12 months.	24,000	40 000	24
Inspect the exhaust system. Perform the first inspection at 12,000 mi (20 000 km) or 12 months.	24,000	40 000	24
Inspect the front suspension, tie rod ends and boot seals, and replace if necessary.	24,000	40 000	24
Replace the engine air cleaner filter.	30,000	50 000	30

430 MAINTENANCE SCHEDULES

Maintenance Items	Perform Maintenance Every (Where time and mileage are listed, follow the interval that occurs first.)		
	Miles	Kilometers	or Months
Replace the spark plugs on 2.4L engines (except PZEV* engine).	30,000	50 000	30
Inspect and adjust the power steering pump belt tension on 2.4L engines.	30,000	50 000	30
Inspect the generator belt on 2.4L engines, and replace if necessary.	30,000	50 000	30
Change the automatic transaxle fluid & filter if using your vehicle for any of the following: police, taxi, fleet, or frequent trailer towing.	60,000	100 000	60
Inspect and replace PCV valve if necessary. †	90,000	150 000	90
Flush and replace the engine coolant.	100,000	160 000	60
Replace the spark plugs on 2.4L PZEV*, 2.7L and 3.5L engines.	102,000	170 000	102
Replace the power steering pump belt on 2.4L engines.	102,000	170 000	102
Replace the generator belt on 2.4L engines.	102,000	170 000	102

Maintenance Items	Perform Maintenance Every (Where time and mileage are listed, follow the interval that occurs first.)		
	Miles	Kilometers	or Months
Replace the timing belt on 2.4L and 3.5L engines.	102,000	170 000	102
Change the automatic transaxle fluid & filter.	120,000	200 000	120
Replace the accessory drive belt on 2.7L engines.	120,000	200 000	120
*Partial Zero Emissions Vehicle			
† This maintenance is recommended by the manufacturer to the owner, but is not required to maintain emissions warranty.			

WARNING!

You can be badly injured working on or around a motor vehicle. Do only that service work for which you have the knowledge and the right equipment. If you have any doubt about your ability to perform a service job, take your vehicle to a competent mechanic.

IF YOU NEED CONSUMER ASSISTANCE

CONTENTS

■ Suggestions For Obtaining Service For Your Vehicle	435	□ Customer Assistance For The Hearing Or Speech Impaired (TDD/TTY)	437
□ Prepare For The Appointment	435	□ Service Contract	437
□ Prepare A List	435	■ Warranty Information (U.S. Vehicles Only)	438
□ Be Reasonable With Requests	435	■ MOPAR®Parts	439
■ If You Need Assistance	435	■ Reporting Safety Defects	439
□ Chrysler LLC Customer Center	436	□ In The 50 United States And Washington, D.C.	439
□ Chrysler Canada Inc. Customer Center	436	□ In Canada	439
□ In Mexico Contact	437	■ Publication Order Forms	440

■ Department Of Transportation Uniform Tire Quality Grades	441
□ Treadwear	441

□ Traction Grades	441
□ Temperature Grades	442

SUGGESTIONS FOR OBTAINING SERVICE FOR YOUR VEHICLE

Prepare For The Appointment

If you're having warranty work done, be sure to have the right papers with you. Take your warranty folder. All work to be performed may not be covered by the warranty. Discuss additional charges with the service manager. Keep a maintenance log of your vehicle's service history. This can often provide a clue to the current problem.

Prepare A List

Make a written list of your vehicle's problems or the specific work you want done. If you've had an accident or work done that is not on your maintenance log, let the service advisor know.

Be Reasonable With Requests

If you list a number of items and you must have your vehicle by the end of the day, discuss the situation with the service advisor and list the items in order of priority. At many authorized dealers, you may obtain a rental vehicle at a minimal daily charge. If you need a rental, it is advisable to make these arrangements when you call for an appointment.

IF YOU NEED ASSISTANCE

The manufacturer and its authorized dealers are vitally interested in your satisfaction. We want you to be happy with our products and services.

Warranty service must be done by an authorized dealer. We strongly recommend that you take the vehicle to an authorized selling dealer. They know you and the vehicle best, and are most concerned that you get prompt and

high quality service. The manufacturer's authorized dealers have the facilities, factory-trained technicians, special tools, and the latest information to ensure the vehicle is fixed correctly and in a timely manner.

This is why you should always talk to an authorized dealer's service manager first. Most matters can be resolved with this process.

- If for some reason you are still not satisfied, talk to the general manager or owner of the authorized dealership. They want to know if you need assistance.
- If an authorized dealership is unable to resolve the concern, you may contact the Manufacturer's Customer Center.

Any communication to the Manufacturer's Customer Center should include the following information:

- Owner's name and address
- Owner's telephone number (home and office)
- Authorized dealership name
- Vehicle Identification Number (VIN)
- Vehicle delivery date and mileage

Chrysler LLC Customer Center

P.O. Box 21-8004

Auburn Hills, MI 48321-8004

Phone: (800) 992-1997

Chrysler Canada Inc. Customer Center

P.O. Box 1621

Windsor, Ontario N9A 4H6

Phone: (800) 465-2001

In Mexico contact:

Av. Prolongacion Paseo de la Reforma, 1240

Sante Fe C.P. 05109

Mexico, D. F.

In Mexico City: 5081-4568

Outside Mexico City: 1-800-505-1300

Customer Assistance For The Hearing Or Speech Impaired (TDD/TTY)

To assist customers who have hearing difficulties, the manufacturer has installed special TDD (Telecommunication Devices for the Deaf) equipment at its Customer Center. Any hearing or speech impaired customer, who has access to a TDD or a conventional teletypewriter (TTY) in the United States, can communicate with the manufacturer by dialing 1-800-380-CHRY.

Service Contract

You may have purchased a service contract for an vehicle to help protect you from the high cost of unexpected repairs after the manufacturer's New Vehicle Limited Warranty expires. The manufacturer stands behind only the manufacturer's Service Contracts. If you purchased a manufacturer's Service Contract, you will receive Plan Provisions and an Owner Identification Card in the mail within three weeks of the vehicle delivery date. If you have any questions about the service contract, call the manufacturer's Service Contract National Customer Hotline at 1-800-521-9922.

The manufacturer will not stand behind any service contract that is not the manufacturer's Service Contract. It is not responsible for any service contract other than the manufacturer's Service Contract. If you purchased a service contract that is not a manufacturer's Service

Contract, and you require service after the manufacturer's New Vehicle Limited Warranty expires, please refer to the contract documents, and contact the person listed in those documents.

We appreciate that you have made a major investment when you purchased the vehicle. An authorized dealer has also made a major investment in facilities, tools, and training to assure that you are absolutely delighted with the ownership experience. You'll be pleased with their sincere efforts to resolve any warranty issues or related concerns.

WARNING!

Engine exhaust, some of its constituents, and certain vehicle components contain, or emit, chemicals known to the State of California to cause cancer and birth defects or other reproductive harm. In addition, certain fluids contained in vehicles and certain products of component wear contain, or emit, chemicals known to the State of California to cause cancer and birth defects or other reproductive harm.

WARRANTY INFORMATION (U.S. Vehicles Only)

See the Warranty Information Booklet for the terms and provisions of Chrysler LLC warranties applicable to this vehicle.

MOPAR® PARTS

Mopar® fluids, lubricants, parts, and accessories are available from your authorized dealer. They will help you keep your vehicle operating at its best.

REPORTING SAFETY DEFECTS

In The 50 United States And Washington, D.C.

If you believe that your vehicle has a defect that could cause a crash or cause injury or death, you should immediately inform the National Highway Traffic Safety Administration (NHTSA) in addition to notifying the manufacturer.

If NHTSA receives similar complaints, it may open an investigation, and if it finds that a safety defect exists in a group of vehicles, it may order a recall and remedy campaign. However, NHTSA cannot become involved in individual problems between you, your authorized dealer, and the manufacturer.

To contact NHTSA, you may either call the Auto Safety Hotline toll free at 1-888-327-4236 (TTY: 1-800-424-9153), or go to <http://www.safercar.gov>; or write to: Administrator, NHTSA, 400 Seventh Street, SW., Washington, D.C. 20590. You can also obtain other information about motor vehicle safety from <http://www.safercar.gov>.

In Canada

If you believe that your vehicle has a safety defect, you should contact the Customer Service Department immediately. Canadian customers who wish to report a safety defect to the Canadian government should write to: Transport Canada, Motor Vehicle Defect Investigations and Recalls, 2780 Sheffield Road, Ottawa, Ontario K1B 3V9.

PUBLICATION ORDER FORMS

To order the following manuals, you may use either the website or the phone numbers listed below. Visa, Mastercard, American Express, and Discover orders are accepted. If you prefer mailing your payment, please call for an order form.

NOTE: A street address is required when ordering manuals (no P.O. Boxes).

- *Service Manuals*

These comprehensive Service Manuals provide the information that students and professional technicians need in diagnosing/troubleshooting, problem solving, maintaining, servicing, and repairing Chrysler LLC vehicles. A complete working knowledge of the vehicle, system, and/or components is written in straightforward language with illustrations, diagrams, and charts.

- *Diagnostic Procedure Manuals*

Diagnostic Procedure Manuals are filled with diagrams, charts and detailed illustrations. These practical manuals make it easy for students and technicians to find and fix problems on computer-controlled vehicle systems and features. They show exactly how to find and correct problems the first time, using step-by-step troubleshooting and drivability procedures, proven diagnostic tests and a complete list of all tools and equipment.

- *Owner's Manuals*

These Owner's Manuals have been prepared with the assistance of service and engineering specialists to acquaint you with specific Chrysler LLC vehicles. Included are starting, operating, emergency and maintenance procedures as well as specifications, capabilities and safety tips.

Call toll free at:

- 1-800-890-4038 (U.S.)
- 1-800-387-1143 (Canada)

Or

Visit us on the Worldwide Web at:

- www.techauthority.com

**DEPARTMENT OF TRANSPORTATION UNIFORM
TIRE QUALITY GRADES**

The following tire grading categories were established by the National Highway Traffic Safety Administration. The specific grade rating assigned by the tire's manufacturer in each category is shown on the sidewall of the tires on your vehicle.

All passenger car tires must conform to Federal safety requirements in addition to these grades.

Treadwear

The Treadwear grade is a comparative rating, based on the wear rate of the tire when tested under controlled conditions on a specified government test course. For example, a tire graded 150 would wear one and one-half times as well on the government course as a tire graded 100. The relative performance of tires depends upon the actual conditions of their use, however, and may depart significantly from the norm due to variations in driving habits, service practices, and differences in road characteristics and climate.

Traction Grades

The Traction grades, from highest to lowest, are AA, A, B, and C. These grades represent the tire's ability to stop on wet pavement, as measured under controlled conditions on specified government test surfaces of asphalt and concrete. A tire marked C may have poor traction performance.

WARNING!

The traction grade assigned to this tire is based on straight-ahead braking traction tests, and does not include acceleration, cornering, hydroplaning, or peak traction characteristics.

Temperature Grades

The temperature grades are A (the highest), B, and C, representing the tire's resistance to the generation of heat and its ability to dissipate heat, when tested under controlled conditions on a specified indoor laboratory test wheel. Sustained high temperature can cause the material of the tire to degenerate and reduce tire life, and excessive temperature can lead to sudden tire failure. The grade C corresponds to a level of performance, which all passenger car tires must meet under the Federal Motor

Vehicle Safety Standard No. 109. Grades B and A represent higher levels of performance on the laboratory test wheel, than the minimum required by law.

WARNING!

The temperature grade for this tire is established for a tire that is properly inflated and not overloaded. Excessive speed, under-inflation, or excessive loading, either separately or in combination, can cause heat buildup and possible tire failure.

INDEX

ABS (Anti-Lock Brake System)	279	Airbag, Window (Side Curtain)	55,59,60
Adding Engine Coolant (Antifreeze)	390	Alarm System (Security Alarm)	18,171
Adding Fuel	328	Alignment and Balance	308
Adding Washer Fluid	138,387	All Wheel Drive (AWD)	275
Additives, Fuel	322	Alterations/Modifications, Vehicle	7
Air Cleaner, Engine (Engine Air Cleaner Filter) . . .	379	Antenna, Satellite Radio	233
Air Conditioner Maintenance	382	Antifreeze (Engine Coolant)	389,390,420
Air Conditioning	242	Disposal	392
Air Conditioning Controls	242	Anti-Lock Brake System (ABS)	279
Air Conditioning Filter	254,383	Anti-Lock Warning Light	279
Air Conditioning, Operating Tips	255	Anti-Theft Security Alarm (Theft Alarm)	18
Air Conditioning Refrigerant	382,383	Appearance Care	400
Air Conditioning System	242,246,382	Ashtray	155
Air Pressure, Tires	300	Assistance Towing	102
Airbag	51,60	Audio Systems (Radio)	220,223
Airbag Deployment	62	Auto Down Power Windows	36
Airbag Light	52,59,65,79,171	Auto Unlock, Doors	32
Airbag Maintenance	64	Auto Up Power Windows	37,151
Airbag, Side	54,59,60	Automatic Dimming Mirror	86

Automatic Door Locks	32	Location	381
Automatic Oil Change Indicator	173,184,426	Bearings	400
Automatic Temperature Control (ATC)	246	Belts, Drive	378
Automatic Transaxle	12,261,267,397	Beverage Cooler	161
Adding Fluid	397,398,424	Body Mechanism Lubrication	386
Filter	399	B-Pillar Location	295
Fluid and Filter Changes	399	Brake Assist System	282
Fluid Level Check	397,398	Brake, Parking	276
Interlock System	269	Brake System	278,394
Reset Mode	273	Anti-Lock (ABS)	279
Selection Of Lubricant	424	Fluid Check	396,424
Shifting	270	Hoses	395
Special Additives	399	Master Cylinder	396
Autostick	274	Parking	276
		Warning Light	179
Ball Joints	385	Brakes	278,394
Battery	381	Brake/Transmission Interlock	269
Gas Caution	381	Break-In Recommendations, New Vehicle	78
Keyless Transmitter Replacement (RKE)	26	Bulb Replacement	411,412

- Bulbs, Light 411
- Calibration, Compass 186
- Capacities, Antifreeze (Engine Coolant) 20
- Capacities, Fluid 420
- Caps, Filler
- Fuel 328
 - Oil (Engine) 368,369,370,377
 - Radiator (Coolant Pressure) 391
- Car Washes 401
- Carbon Monoxide Warning 323
- Cargo Area Features 160
- Cargo Compartment 160
- Cargo Load Floor 160
- Cargo (Vehicle Loading) 160
- Catalytic Converter 379
- Caution, Exhaust Gas 78
- CD (Compact Disc) Player 220,223
- CD (Compact Disc) Player Maintenance 241
- Cellular Phone 89,223,224,241
- Center High Mounted Stop Light 418
- Chains, Tire 309
- Changing A Flat Tire 350
- Chart, Tire Sizing 292
- Check Engine Light
(Malfunction Indicator Light) 372
- Child Restraint 67,69,73,76
- Child Restraint Tether Anchors 71,73
- Child Safety Locks 34
- Cigar Lighter 155
- Clean Air Gasoline 320
- Cleaning
- Wheels 402
 - Windshield Wiper Blades 386
- Climate Control 242
- Clock 194,206,221,225
- Coin Holder 156
- Compact Disc (CD) Maintenance 241

Compact Spare Tire	303	Drain, Flush, and Refill	389
Compass	186	Inspection	392
Compass Calibration	186	Points to Remember	392
Compass Variance	187	Pressure Cap	391
Computer, Trip/Travel	20,184	Radiator Cap	391
Connector		Selection of Coolant (Antifreeze)	389,420,422
UCI	227	Corrosion Protection	400
Universal Consumer Interface (UCI)	227	Crankcase Ventilation Module	20
Console	127,156	Cruise Light	174
Console, Floor	127,156	Cup Holder	127,158,405
Contract, Service	437	Customer Assistance	435
Converter, Catalytic	379	Customer Programmable Features	188
Coolant Pressure Cap (Radiator Cap)	391		
Cooler, Beverage	161	Data Recorder, Event	65
Cooling System	388	Dealer Service	374
Adding Coolant (Antifreeze)	390	Defroster, Rear Window	256
Coolant Capacity	420	Defroster, Windshield	80,244,250,251
Coolant Level	389,392	Delay (Intermittent) Wipers	136
Disposal of Used Coolant	392	Diagnostic System, Onboard	371

Digital Video Disc (DVD) Player	220,223	E-85 Fuel	324
Dimmer Switch, Headlight	134	Electric Rear Window Defrost	256
Dipsticks		Electric Remote Mirrors	86
Automatic Transaxle	397,398	Electrical Power Outlets	153
Oil (Engine)	374	Electronic Speed Control (Cruise Control)	140
Disabled Vehicle Towing	362	Electronic Stability Program (ESP)	283
Disposal		Electronic Vehicle Information Center (EVIC)	181
Antifreeze (Engine Coolant)	392	Emergency, In Case of	
Engine Oil	378	Jacking	350
Door Locks	30	Jump Starting	358
Door Locks, Automatic	32	Towing	362
Door Opener, Garage	143	Emergency Trunk Release	39,40
Drive Belts	378	Emission Control System Maintenance	372,426
Driving		Engine	78,368,369,370
On Slippery Surfaces	288	Air Cleaner	379
Through Flowing, Rising, or Shallow Standing		Block Heater	266
Water	289	Break-In Recommendations	78
DVD Player (Video Entertainment System)	239	Checking Oil Level	374
		Coolant (Antifreeze)	389,422

Cooling	388	Exhaust Gas Caution	78,323,388
Exhaust Gas Caution	323	Exhaust System	387
Fuel Requirements	319,420	Extender, Seat Belt	51
Jump Starting	358		
Oil	374,420,422	Fabric Care	403,404
Oil Change Interval	173,184,376,426	Filler Location Fuel	170,328
Oil Filler Cap	368,369,370,377	Filters	
Oil Filter	378	Air Cleaner	379
Oil Filter Disposal	378	Air Conditioning	254,383
Oil Selection	376,420	Automatic Transaxle	399
Oil Synthetic	377	Engine Oil	378,422
Operation	78	Engine Oil Disposal	378
Overheating	348	Flashers	348
Temperature Gauge	170	Hazard Warning	348
Engine Oil Viscosity	377	Turn Signal	416
Enhanced Accident Response Feature	62	Flash-To-Pass	131
Entry System, Illuminated	20	Flat Tire Stowage	357
Ethanol	321	Flexible Fuel Vehicles	324
Event Data Recorder	65	Cruising Range	327

Engine Oil	326	Freeing A Stuck Vehicle	361
Fuel Requirements	324,326	Front Wheel Bearings	400
Maintenance	324,327	Fuel	319
Replacement Parts	327	Adding	328
Starting	327	Additives	322
Flooded Engine Starting	263	Clean Air	320
Floor Console	156	Ethanol	321
Fluid Capacities	420	Filler Cap (Gas Cap)	170,328
Fluid Leaks	80	Filler Door (Gas Cap)	170
Fluid Level Checks		Gasoline	319
Automatic Transaxle	397,398	Gauge	170
Brake	396,424	Hoses	394
Cooling System	389	Light	171
Engine Oil	374	Materials Added	322
Power Steering	385,424	Methanol	321
Fluids	422	Octane Rating	319,422
Fluids, Lubricants and Genuine Parts	422	Requirements	319,420
Fog Lights	132,176,415	Tank Capacity	420
Folding Rear Seat	126,127	Fuel, Flexible	<i>See Flexible Fuel Vehicles</i>

Fuel System Caution	329	Gross Axle Weight Rating	332,335
Fueling	328	Gross Vehicle Weight Rating	332,334
Fuses	406	GVWR	332
Garage Door Opener (HomeLink®)	143	Hands-Free Phone (UConnect™)	89,223,224
Gas Cap (Fuel Filler Cap)	328,330,371	Hard Drive (HDD)	220,223
Gasoline, Clean Air	320	Hazard	
Gasoline (Fuel)	319	Driving Through Flowing, Rising, or Shallow	
Gasoline, Reformulated	320,321	Standing Water	289
Gauges		Hazard Warning Flasher	348
Coolant Temperature	170	Head Restraints	125
Fuel	170	Headlights	412
Odometer	172	Bulb Replacement	412
Tachometer	172	Cleaning	402
Gearshift	270	High Beam	134,179
General Information	17,115,319	High Beam/Low Beam Select Switch	134
General Maintenance	374	On With Wipers	137
Glass Cleaning	404	Passing	131
Glove Compartment	161	Switch	130

Heated Seats	123	Instrument Panel and Controls	167
Heater	242	Instrument Panel Cover	403
Heater, Engine Block	266	Instrument Panel Lens Cleaning	405
Hitches		Integrated Power Module (Fuses)	406
Trailer Towing	336	Interior Appearance Care	403
HomeLink® (Garage Door Opener) Transmitter . . .	143	Interior Lights	129
Hood Prop	128	Intermittent Wipers (Delay Wipers)	136
Hood Release	127	Introduction	4
Hoses	394		
		Jack Location	351
Ignition	12	Jack Operation	350,352
Key	12	Jacking Instructions	352
Ignition Key Removal	12	Jump Starting	358
Illuminated Entry	20		
Immobilizer (Sentry Key)	14	Key, Programming	16
Infant Restraint	67,68,69	Key, Replacement	16
Information Center, Vehicle	181	Key, Sentry (Immobilizer)	14
Inside Rearview Mirror	85	Key-In Reminder	14
Instrument Cluster	168,170	Keyless Entry System	21

Keyless Entry System (Sedan)	21	Dimmer Switch, Headlight	130
Keys	12	Electronic Stability Program (ESP) Indicator	284
Knee Bolster	51,53	Engine Temperature Warning	172
Lane Change and Turn Signals	176,416	Fog	132,176,415
Lap/Shoulder Belts	42	Headlight Switch	130
LATCH (Lower Anchors and Tether for CHildren)	73	Headlights	130
Latches		Headlights On With Wipers	137
Hood	127	High Beam Indicator	179
Lead Free Gasoline	319	Illuminated Entry	20
Life of Tires	306	Instrument Cluster	130
Light Bulbs	411	Interior	129
Lights	80,129	License	418
Airbag	52,65,79,171	Lights On Reminder	132
Back-Up	416	Low Fuel	171
Brake Warning	179	Malfunction Indicator (Check Engine)	178
Bulb Replacement	412	Map Reading	129
Center Mounted Stop	418	Oil Pressure	171
Daytime Running	132	Passing	131
		Seat Belt Reminder	171

Security Alarm (Theft Alarm)	18	Maintenance Free Battery	381
Theft Alarm (Security Alarm)	171	Maintenance, General	374
Tire Pressure Monitoring (TPMS)	310	Maintenance Procedures	374
Traction Control	284	Maintenance Schedule	426
Turn Signal	130,133,176,416	Malfunction Indicator Light (Check Engine) . .	178,372
Voltage	171	Manual, Service	440
Warning (Instrument Cluster Description)	170	Map/Reading Lights	129
Loading Vehicle	331,333	Master Cylinder (Brakes)	396
Capacities	333	Methanol	321
Tires	295	Mini-Trip Computer	184
Locks		Mirrors	85
Auto Unlock	32	Automatic Dimming	86
Child Protection	34	Electric Powered	86
Door	30	Outside	87
Power Door	32	Rearview	85
Low Tire Pressure System	310	Vanity	88
Lower Anchors and Tether for Children (LATCH) . .	73	Modifications/Alterations, Vehicle	7
Lubrication, Body	386	Monitor, Tire Pressure System	310
Lumbar Support	122	Mopar Parts	373,439

MP3 Player	220,223	Dipstick	374
MTBE/ETBE	321	Disposal	378
Multi-Function Control Lever	130	Filter	378,422
		Filter Disposal	378
Navigation Radio	223	Identification Logo	376
Navigation System	223	Materials Added to	378
New Vehicle Break-In Period	78	Recommendation	376,420
		Synthetic	377
Occupant Restraints	59,62	Viscosity	377,420
Occupant Restraints (Sedan)	40,54,55,59,60	Oil Filter, Change	378
Octane Rating, Gasoline (Fuel)	319	Oil Filter, Selection	378
Odometer	172	Oil Pressure Light	171
Trip	172,174	Onboard Diagnostic System	371,372
Oil Change Indicator	173,184,426	Opener, Garage Door (HomeLink®)	143
Oil Change Indicator, Reset	173,184	Operator Manual (Owner's Manual)	4
Oil, Engine	374,422	Overdrive	271,272
Capacity	420	Overheating, Engine	348
Change Interval	173,184,376,426	Owner's Manual (Operator Manual)	4,440
Checking	374		

Paint Care	400	Steering, Checking	385
Panic Alarm	25	Sunroof	150
Parking Brake	276	Windows	35
Passing Light	131	Power Steering Fluid	385
Personal Settings	188	Pregnant Women and Seat Belts	50
Pets	77	Preparation for Jacking	352
Phone, Cellular	89,223,224	Pretensioners	
Phone, Hands-Free (UConnect™)	89,223,224	Seat Belts	48
Placard, Tire and Loading Information	295	Programmable Electronic Features	188
Port		Programming Transmitters	
Universal Serial Bus (USB)	220,223	(Remote Keyless Entry)	26
USB	220,223	Radial Ply Tires	302
Power		Radiator Cap (Coolant Pressure Cap)	391
Distribution Center (Fuses)	406	Radio Broadcast Signals	191
Door Locks	32	Radio, Navigation	223
Mirrors	86	Radio Operation	221,224,241
Outlet (Auxiliary Electrical Outlet)	153	Radio Remote Controls	236
Seats	123	Radio, Satellite	220,221,223,224,231
Steering	287		

Radio (Sound Systems)	220,223	Remote Trunk Release	39
Rear Cup Holder	159	Replacement Bulbs	411
Rear Seat, Folding	126,127	Replacement Keys	16
Rear Wheel Bearings	400	Replacement Parts	373
Rear Window Defroster	256	Replacement Tires	307
Rear Window Features	256	Reporting Safety Defects	439
Rearview Mirrors	85	Resetting Oil Change Indicator	173,184
Recorder, Event Data	65	Restraint, Head	125
Recreational Towing	345,363	Restraints, Child	67
Reformulated Gasoline	320	Restraints, Infant	68
Refrigerant	383	Rotation, Tires	309
Reminder, Seat Belt	48,49		
Remote Control		Safety Checks Inside Vehicle	79
Door Locks	21	Safety Checks Outside Vehicle	80
Security Alarm	18	Safety Defects, Reporting	439
Remote Keyless Entry (RKE)	21	Safety Information, Tire	291
Remote Keyless Entry (Sedan)	21	Safety Tips	78
Remote Sound System (Radio) Controls	236	Satellite Radio	220,221,223,224,231
Remote Starting System	28	Satellite Radio Antenna	233

Schedule, Maintenance	426	Head Restraints	125
Seat Belt Maintenance	405	Heated	123
Seat Belt Reminder	48,49	Lumbar Support	122
Seat Belts		Power	123
Adjustable Shoulder Belt	47	Rear Folding	126,127
Adjustable Upper Shoulder Anchorage	47	Rear Folding (Sedan)	160
And Pregnant Women	50	Reclining	121
Child Restraint	67,76	Security Alarm (Theft Alarm)	18
Extender	51	Selection of Coolant (Antifreeze)	389,422
Front Seat	42,43	Selection of Oil	376
Operating Instructions	43	Sentry Key (Immobilizer)	14
Pretensioners	48	Sentry Key Programming	16
Rear Seat	42	Sentry Key Replacement	16
Reminder	171	Service Assistance	435
Untwisting Procedure	46	Service Contract	437
Seat Belts (Sedan)	40	Service Manuals	440
Seats	120	Setting the Clock	194,206,221,225
Adjustment	120	Settings, Personal	188
Cleaning	127,404	Shoulder Belts	42

Side Window Demisters (Defrosters)	253	Tilt Column	139
Signals, Turn	416	Wheel, Tilt	139
Slippery Surfaces, Driving On	288	Steering Wheel Mounted Sound System	
Snow Chains (Tire Chains)	309	Controls	236
Snow Tires	309	Storage	160,411
Sound Systems (Radio)	220,223	Storage, Vehicle	253
Spare Tire	303,304,351	Stuck, Freeing	361
Spark Plugs	379	Sun Roof	150
Specifications		Supplemental Restraint System - Airbag	51
Oil	376	Synthetic Engine Oil	377
Speed Control (Cruise Control)	140,174	System, Navigation	223
Speedometer	170,172	Tachometer	172
Speedometer and Odometer	168	Taillights	416
Starting	261	Telescoping Steering Column	139
Engine Fails to Start	263	Temperature Control, Automatic (ATC)	246
Starting Procedures	261	Temperature Gauge, Engine Coolant	170,349
Steering		Tether Anchor, Child Restraint	71
Linkage	386	Theft Alarm (Security Alarm)	18
Power	287,385		

Theft System (Security Alarm)	18	Jacking	350
Tilt Steering Column	139	Life of Tires	306
Time Delay, Headlight	131	Load Capacity	295,296
Tip Start	262	Pressure Monitor System (TPMS)	310
Tire and Loading Information Placard	295	Quality Grading	441
Tire Identification Number (TIN)	294	Radial	302
Tire Markings	291	Replacement	307
Tire Safety Information	291	Rotation	309
Tires	80,299,441	Safety	291,299
Aging (Life of Tires)	306	Sizes	292
Air Pressure	299	Snow Tires	309
Alignment	308	Spare Tire	351
Chains	309	Spinning	305
Changing	350	Tread Wear Indicators	306
Compact Spare	303	Tongue Weight/Trailer Weight	338
Flat Changing	357	Towing	334
General Information	299	24-Hour Towing Assistance	102
High Speed	302	Disabled Vehicle	362
Inflation Pressures	300	Guide	337

Recreational	345,363	Overdrive	271,272
Weight	337	Selection of Lubricant	424
Towing Assistance	102	Transmission	
Traction	288	Range Indicator	172
Trailer Towing	334	Transmitter Battery Service	
Cooling System Tips	344	(Remote Keyless Entry)	26
Hitches	336	Transmitter, Garage Door Opener (HomeLink®) . .	143
Minimum Requirements	339	Transmitter Programming	
Trailer and Tongue Weight	338	(Remote Keyless Entry)	26
Wiring	342	Transporting Pets	77
Trailer Towing Guide	337	Tread Wear Indicators	306
Trailer Weight	337	Trip Odometer	172
Transaxle	267	Trip Odometer Reset Button	174
Additives	399	Trunk Release, Emergency	39,40
Automatic	12,261,267,397	Trunk Release Remote Control	39
Autostick	274	Turn Signals	133,176,416
Filter	399	UCI Connector	227
Maintenance	397	UConnect™ (Hands-Free Phone)	89,223
Operation	267		

- Understanding Your Instrument Panel 167
Uniform Tire Quality Grades 441
Universal Consumer Interface (UCI) Connector . . . 227
Universal Serial Bus (USB) Port 220,223
Universal Transmitter 143
Unleaded Gasoline 319
Untwisting Procedure, Seat Belt 46
Upholstery Care 403
USB Port 220,223
- Vacuum/Vapor Harnesses 394
Vanity Mirrors 88
Variance, Compass 187
Vehicle Certification Label 331
Vehicle Identification Number (VIN) 6
Vehicle Loading 296,331,333
Vehicle Modifications/Alterations 7
Vehicle Storage 253,411
Vehicle Theft Alarm (Security Alarm) 18
- Video Entertainment System
(Rear Seat Video System) 239
Viscosity, Engine Oil 377
Voice Recognition System (VR) 115
- Warning Lights
(Instrument Cluster Description) 170
Warnings and Cautions 6
Warranty Information 438
Washer, Adding Fluid 138,387
Washers, Windshield 134,138,387
Washing Vehicle 401
Water
 Driving Through 289
Wheel Alignment and Balance 308
Wheel and Wheel Trim 402
Wheel and Wheel Trim Care 402
Wheel Bearings 400
Wind Buffeting 38,152

Window Fogging	253	Windshield Wiper Blades	386
Windows	35	Windshield Wipers	134
Power	35	Wiper Blade Replacement	386,387
Windshield Defroster	244,250,251	Wipers, Intermittent	136
Windshield Washers	134,138	YES Essentials® Fabric Cleaning Procedure	404
Fluid	387		

INSTALLATION OF RADIO TRANSMITTING EQUIPMENT

Special design considerations are incorporated into this vehicle's electronic system to provide immunity to radio frequency signals. Mobile two-way radios and telephone equipment must be installed properly by trained personnel. The following must be observed during installation.

The positive power connection should be made directly to the battery and fused as close to the battery as possible. The negative power connection should be made to body sheet metal adjacent to the negative battery connection. This connection should not be fused.

Antennas for two-way radios should be mounted on the roof or the rear area of the vehicle. Care should be used in mounting antennas with magnet bases. Magnets may affect the accuracy or operation of the compass on vehicles so equipped.

The antenna cable should be as short as practical and routed away from the vehicle wiring when possible. Use only fully shielded coaxial cable.

Carefully match the antenna and cable to the radio to ensure a low Standing Wave Ratio (SWR).

Mobile radio equipment with output power greater than normal may require special precautions.

All installations should be checked for possible interference between the communications equipment and the vehicle's electronic systems.



Stick with the Specialists™



DaimlerChrysler Corporation

81-226-0830

Third Edition

Download from www.somanuals.com. All Manuals Search And Download.

Printed in U.S.A.

Free Manuals Download Website

<http://myh66.com>

<http://usermanuals.us>

<http://www.somanuals.com>

<http://www.4manuals.cc>

<http://www.manual-lib.com>

<http://www.404manual.com>

<http://www.luxmanual.com>

<http://aubethermostatmanual.com>

Golf course search by state

<http://golfingnear.com>

Email search by domain

<http://emailbydomain.com>

Auto manuals search

<http://auto.somanuals.com>

TV manuals search

<http://tv.somanuals.com>