

# TABLE OF CONTENTS

SECTION		PAGE
1	INTRODUCTION .....	3
2	THINGS TO KNOW BEFORE STARTING YOUR VEHICLE .....	7
3	UNDERSTANDING THE FEATURES OF YOUR VEHICLE .....	47
4	UNDERSTANDING YOUR INSTRUMENT PANEL .....	77
5	STARTING AND OPERATING .....	137
6	WHAT TO DO IN EMERGENCIES .....	189
7	MAINTAINING YOUR VEHICLE .....	203
8	MAINTENANCE SCHEDULES .....	249
9	IF YOU NEED CONSUMER ASSISTANCE .....	269
10	INDEX .....	277



---

# INTRODUCTION

## CONTENTS

---

■ Introduction . . . . .	4	■ Vehicle Identification Number . . . . .	6
■ How To Use This Manual . . . . .	4	■ Vehicle Modifications / Alterations . . . . .	6
■ Warnings And Cautions . . . . .	6		

## 4 INTRODUCTION

### INTRODUCTION

This manual has been prepared with the assistance of service and engineering specialists to acquaint you with the operation and maintenance of your new vehicle. It is supplemented by a Warranty Information Booklet and various customer oriented documents. You are urged to read these publications carefully. Following the instructions and recommendations in this manual will help assure safe and enjoyable operation of your vehicle.

**NOTE:** After you read the manual, it should be stored in the vehicle for convenient reference and remain with the vehicle when sold, so that the new owner will be aware of all safety warnings.

When it comes to service, remember that your dealer knows your vehicle best, has the factory-trained technicians and genuine Mopar® parts, and is interested in your satisfaction.

### WARNING!







































































**Engine exhaust, some of its constituents, and certain vehicle components contain or emit chemicals known to the State of California to cause cancer and birth defects or other reproductive harm. In addition, certain fluids contained in vehicles and certain products of component wear contain or emit chemicals known to the State of California to cause cancer and birth defects or other reproductive harm.**

### HOW TO USE THIS MANUAL

Consult the table of contents to determine which section contains the information you desire.

The detailed index, at the rear of this manual, contains a complete listing of all subjects.

Consult the following table for a description of the symbols that may be used on your vehicle or throughout this owner's manual:

									
TURN SIGNALS	REAR WINDOW WIPER	WINDSHIELD WIPER INTERMITTENT	SUPPLEMENTAL RESTRAINT SYSTEM	HIGH BEAM	HORN	UPPER AIR OUTLET	HEATED SEAT LOW	DOOR LOCK	ADJUSTABLE PEDALS
									
FUEL	REAR WINDOW INTERMITTENT WIPER	WINDSHIELD WASHER	FAILURE OF ANTI-LOCK BRAKING SYSTEM	LOW BEAM	KEY ACTIVATE (POWER OUTLET)	UPPER AND LOWER AIR OUTLET	HEATED SEAT HIGH	WINDOW LIFT	TIRE PRESSURE MONITOR
									
FUEL FILL SIDE	REAR WINDOW WASHER	WINDSHIELD WASHER FLUID LEVEL	SEAT BELT	FRONT FOG LIGHT	HOOD RELEASE	LOWER AIR OUTLET	RECIRCULATION	CONVERTIBLE 4 WINDOW DOWN	VOICE RECOGNITION BUTTON
									
ENGINE OIL	REAR WINDOW DEFROST	WINDSHIELD, ELECTRICALLY HEATED	AIRBAG	EXTERIOR BULB FAILURE	LIFTGATE RELEASE AND LIFTGATE OPEN	DEFROST AND LOWER AIR OUTLET	VENTILATING FAN	POWER STEERING FLUID	UCONNECT™ BUTTON
									
BATTERY CHARGING	HEATED MIRROR	WINDSHIELD DEFROST	SIDE AIRBAG	DOME LIGHT	SLIDING DOOR	TRUNK / DECK RELEASE	AIR CONDITIONING	SEE OWNER'S MANUAL ISO	TRACTION CONTROL
									
ENGINE COOLANT TEMPERATURE	CHILD SEAT TETHER ANCHOR	WINDSHIELD WIPER AND WASHER	HAZARD	PARK LIGHTS	SLIDING DOOR	CONVERTIBLE TOP UP	EMERGENCY RELEASE HANDLE	INSTRUMENT PANEL ILLUMINATION	WARNING
									
MALFUNCTION INDICATOR LIGHT	LOWER ANCHORS AND TETHER FOR CHILDREN (LATCH)	ELECTRONIC SPEED CONTROL	WINDOW LOCK	LIGHTER	DOOR AJAR	CONVERTIBLE TOP DOWN	PASSENGER AIRBAG OFF	MASTER LIGHTING SWITCH	ESP BAS ELECTRONIC STABILITY PROGRAM / BRAKE ASSIST SYSTEM

**WARNINGS AND CAUTIONS**

This manual contains **WARNINGS** against operating procedures which could result in an accident or bodily injury. It also contains **CAUTIONS** against procedures which could result in damage to your vehicle. If you do not read this entire manual you may miss important information. Observe all Warnings and Cautions.

**VEHICLE IDENTIFICATION NUMBER**

The vehicle identification number (VIN) is on a stamped plate on the left front corner on the body of the vehicle, visible through the windshield. This number also appears on the Automobile Information Disclosure Label affixed to a window on your vehicle. Save this label as a convenient record of your vehicle identification number and optional equipment.

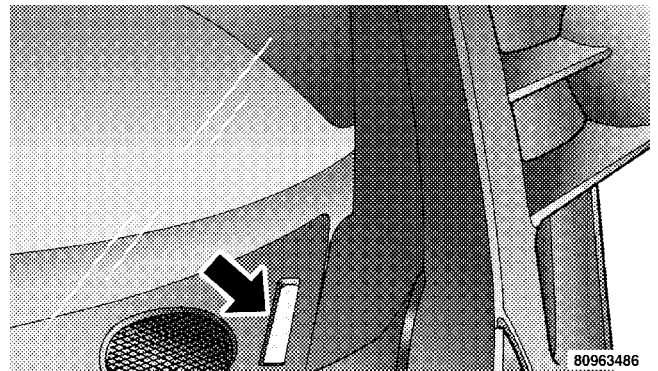

Vehicle Identification Number

**VEHICLE MODIFICATIONS / ALTERATIONS**

**WARNING!**

Any modifications or alterations to this vehicle could seriously affect its roadworthiness and safety and may lead to an accident resulting in serious injury or death.

---

# THINGS TO KNOW BEFORE STARTING YOUR VEHICLE

---

## CONTENTS

---

■ Sentry Key — If Equipped . . . . .	9	□ “Child Protection” Door Lock System (Rear Doors) . . . . .	14
□ Replacement Keys . . . . .	9	■ Remote Keyless Entry — If Equipped . . . . .	15
□ Customer Key Programming . . . . .	10	□ To Unlock The Doors . . . . .	15
□ General Information . . . . .	10	□ To Lock The Doors . . . . .	16
■ Illuminated Entry System . . . . .	11	□ To Unlock The Trunk . . . . .	16
■ Door Locks . . . . .	11	□ Panic Alarm . . . . .	17
□ Power Door Locks . . . . .	12	□ To Use The Panic Alarm . . . . .	17
□ Central Locking — If Equipped . . . . .	13	□ To Program Additional Transmitters . . . . .	17
□ Door Ajar Warning . . . . .	13	□ General Information . . . . .	17
□ Automatic (Rolling) Door Locks . . . . .	13	□ Transmitter Battery Service . . . . .	18
□ Automatic Unlock On Exit — Only Available If Automatic Door Locks Are Enabled . . . . .	14	■ Vehicle Theft Alarm . . . . .	19

## 8 THINGS TO KNOW BEFORE STARTING YOUR VEHICLE

□ Tamper Alert . . . . .	19	□ Seat Belts And Pregnant Women . . . . .	29
□ Security System Manual Override . . . . .	19	□ Seat Belt Extender . . . . .	29
■ Trunk Lock And Release . . . . .	20	□ Driver And Right Front Passenger Supplemental Restraint System (SRS) - Airbag . . . . .	30
■ Trunk Safety Warning . . . . .	20	■ Engine Break-In Recommendations . . . . .	44
□ Trunk Internal Emergency Release . . . . .	21	■ Safety Tips . . . . .	45
■ Windows . . . . .	21	□ Exhaust Gas . . . . .	45
□ Power Windows . . . . .	21	□ Safety Checks You Should Make Inside The Vehicle . . . . .	45
■ Occupant Restraints . . . . .	22	□ Periodic Safety Checks You Should Make Outside The Vehicle . . . . .	46
□ Lap/Shoulder Belts . . . . .	23		
□ Seat Belt Pretensioners . . . . .	27		
□ Enhanced Driver Seat Belt Reminder System (BeltAlert) . . . . .	28		



**SENTRY KEY — IF EQUIPPED**

With this system, an electronically coded ignition key sends a signal to the vehicle electronics. If the electronics recognizes the signal, the vehicle will start and continue to run. If the system does not recognize the signal the vehicle will start and run for 2 seconds then shut off. The system will allow the engine to be started and run (for 2 seconds) up to six times after which the starter motor will be disabled and the engine will not crank.

**NOTE:**

- The Sentry Key Immobilizer System is not compatible with remote starting systems. Use of these systems may result in vehicle starting problems and loss of security protection.
- Additional Sentry Keys or Mobil Speed Pass™ devices held too close to the ignition key when starting the vehicle may cause problems when attempting to start the vehicle. These devices cannot damage the Sentry Key System, but can cause a momentary problem when attempting to start the engine. If a problem

occurs, remove the Sentry Key from the key ring and restart the vehicle. Pagers, cell phones, walkmans, etc., have no effect on this system.

The Theft Alarm Light, located on the instrument cluster to the right of the fuel gauge, will illuminate for about 3 seconds when the ignition switch is first turned to the On position. If the vehicle electronics do not receive a valid signal from the ignition key, the theft alarm light will flash continuously to signal that the vehicle has been immobilized. If the Theft Alarm Light remains On during vehicle operation, it indicates a fault in the system electronics.

All of the keys provided with your new vehicle have been programmed to the vehicle electronics.

**Replacement Keys**

**NOTE:** Only keys that have been programmed to the vehicle electronics can be used to start the vehicle. Once a Sentry Key has been programmed to a vehicle, it can not be programmed to any other vehicle.

## 10 THINGS TO KNOW BEFORE STARTING YOUR VEHICLE

At the time of purchase, the original owner is provided with a four digit PIN number. This number is required for dealer replacement of keys. Duplication of keys may be performed at an authorized dealer or by using the Customer Key Programming procedure. This procedure consists of programming a blank key to the vehicle electronics. A blank key is one which has never been programmed.

**NOTE:** When having the Sentry Key System serviced, bring all vehicle keys to the dealer.

### Customer Key Programming

You can program new keys to the system if you have two valid keys by doing the following:

1. Insert the first valid key into the ignition and turn the ignition On for at least 3 seconds but no longer than 15 seconds.

Turn the ignition Off and remove the first key.

2. Insert the second valid key and switch the ignition On within 15 seconds. After ten seconds a chime will sound and the Theft Alarm Light will begin to flash.

Turn the ignition Off and remove the second key.

3. Insert a blank Sentry Key into the ignition and switch the ignition On within 60 seconds. After 10 seconds a single chime will sound. The Theft Alarm Light will stop flashing, turn on for 3 seconds; then turn off.

The new Sentry Key has been programmed. Repeat this process to program up to a total of 8 keys.

### General Information

The Sentry Key system complies with FCC rules part 15. Operation is subject to the following two conditions:

1. this device may not cause harmful interference
2. this device must accept any interference that may be received, including interference that may cause undesired operation

**ILLUMINATED ENTRY SYSTEM**

The interior lights will come on when you open any door, unlock the vehicle with the remote keyless entry (if so equipped) or central unlock (if so equipped). They will remain on for about 30 seconds after all doors are closed then fade to off.

The lights also will turn off if you turn on the ignition after you close all doors.

**DOOR LOCKS****WARNING!**

For personal security and safety in the event of an accident, lock the vehicle doors as you drive and when you park and leave the vehicle.

**WARNING!**

When leaving the vehicle always remove the key from the ignition lock, and lock your vehicle. Do not leave children unattended in the vehicle, or with access to an unlocked vehicle. Unsupervised use of vehicle equipment may cause severe personal injuries and death.

### Power Door Locks

There is a door lock switch on each front door trim panel located to the front of the door handle. Press this switch to lock or unlock the four doors.

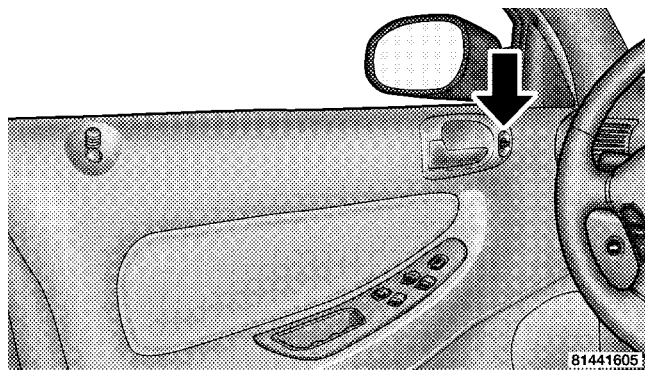

**Power Door Lock Switch**

If you press the door lock switch while the keys are in the ignition switch, and the driver's door is open, the doors will not lock.

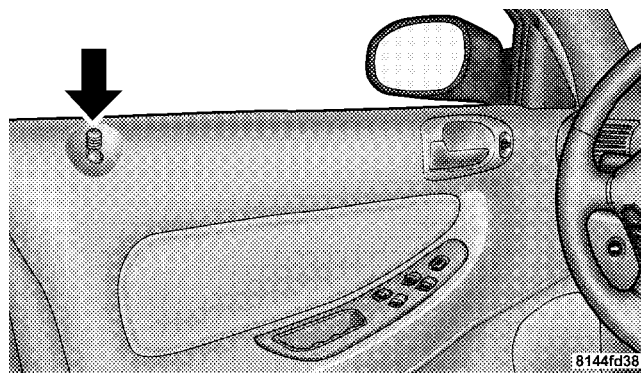

**Door Lock Plunger**

If the door lock plunger is down when you shut the door, the door will lock. Therefore, make sure that the keys are not inside the vehicle before closing the door.

The rear doors cannot be opened from inside the vehicle until you pull up the lock plungers.

**Central Locking — If Equipped**

All vehicle doors are locked with the first turn of the key to the LOCK position. The double activation feature requires you to turn the key in the cylinder lock two times within five seconds to UNLOCK all vehicle doors at once.

**Door Ajar Warning**

If you move the vehicle and a door is not completely closed, the word DOOR will replace the odometer display and a chime will sound once. The odometer display will reappear once the door is closed.

**Automatic (Rolling) Door Locks**

The doors will lock automatically, as programmed from the factory, if:

1. The transaxle is in gear,
2. All doors are closed,
3. Vehicle speed is above 15 mph (24 km/h),
4. The accelerator pedal is depressed.

The Automatic Door Locks can be disabled or re-enabled by performing the following procedure:

1. Close all doors and place the key in the ignition.
2. Cycle the ignition switch between OFF and ON/RUN and back to OFF 4 times ending up in the OFF position.

2

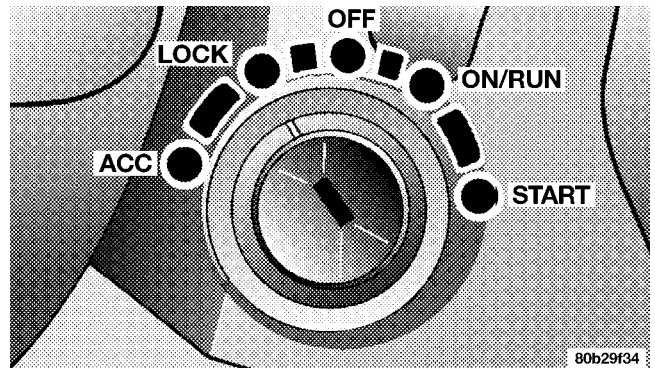

Ignition Key Position

## 14 THINGS TO KNOW BEFORE STARTING YOUR VEHICLE

3. Depress the power door lock switch to lock the doors.

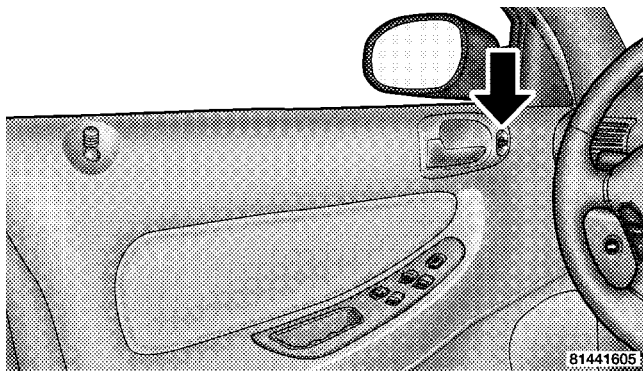

Power Door Lock Switch

4. A single chime will indicate the completion of the programming.

### **Automatic Unlock on Exit — Only Available if Automatic Door Locks are Enabled**

This feature will unlock all the doors when the driver's door is opened and the ignition switch is in the LOCK position. This function is disabled as delivered from the factory. Automatic Unlock on Exit can be enabled or disabled by performing the following procedure:

1. Close all doors and place the key in the ignition.

2. Cycle the ignition switch between OFF and ON/RUN and back to OFF 4 times ending up in the OFF position.

3. Depress the power door lock switch to unlock the doors.

4. A single chime will indicate the completion of the programming.

### **“Child Protection” Door Lock System (Rear Doors)**

To provide a safer environment for small children riding in the rear seat, the rear doors of your vehicle have the “child-protection” door lock system.

To use the system, open each rear door and use a key to move the control near the door latch UP to the “Engage” position as shown on the door label. When the system on a door is engaged, that door can be opened only by using the outside door handle. This will occur even though the inside door lock is in the unlocked position.

**WARNING!**

Avoid trapping anyone in the vehicle in a collision. Remember that the rear doors can only be opened from the outside when the child protection locks are engaged.

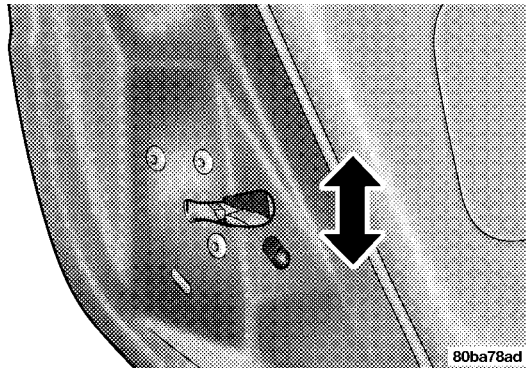

Child Lock Control

**NOTE:** For emergency exit with the system engaged, move the lock plunger up (unlocked position), lower the window and open the door with the outside door handle.

**REMOTE KEYLESS ENTRY — IF EQUIPPED**

This system allows you to lock or unlock the doors or open the trunk from distances up to 23 feet (7 meters) using a transmitter. You don't have to point the transmitter at the vehicle to activate the system.

2

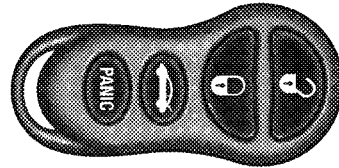

8091f2a0

Keyless Entry Transmitter

**To unlock the doors:**

Press and release the UNLOCK button once to unlock the driver's door. Press the button twice within 5 seconds to unlock all doors. If your vehicle is equipped with Illuminated Entry, the interior lights also come on and remain on for about 30 seconds, when you unlock the doors.

**NOTE:** The system may be programmed to unlock all the doors upon the first press of the Unlock button. To toggle between the first press unlock of the driver's door to unlock of all doors, perform the following procedure:

## 16 THINGS TO KNOW BEFORE STARTING YOUR VEHICLE

1. Press and hold the Unlock button on the transmitter.
2. Continue to hold the Unlock button, wait at least 4 but no longer than 10 seconds, then press the LOCK button.
3. Release both buttons.

The headlights will flash twice to acknowledge the unlock signal.

**NOTE:** The Lamp Flash can be enabled or disabled by performing the following procedure:

1. Press and hold the Lock button on the transmitter.
2. Continue to hold the Lock button, wait at least 4 but no longer than 10 seconds, then press the Trunk button.
3. Release both buttons.

### **To lock the doors:**

The horn will chirp and the headlamps will flash once to acknowledge the lock signal.

**NOTE:** The horn chirp can be enabled or disabled by the following procedure:

1. Press and hold the Lock button on the transmitter.
2. Continue to hold the Lock button, wait at least 4 but no longer than 10 seconds, then press the Unlock button.
3. Release both buttons.

### **To unlock the trunk:**

Press and hold the Trunk button on the transmitter to unlatch the trunk.

**NOTE:** The transmitter can be programmed to unlatch the trunk immediately upon activation of the Trunk button (without pressing and holding) by performing the following procedure:

1. Press and hold the Unlock button on the transmitter.



2. Continue to hold the Unlock button, wait at least 4 but no longer than 10 seconds, then press the Trunk button.

3. Release both buttons.

#### **Panic Alarm**

The panic mode unlocks the driver's door, turns on the interior lights, flashes the headlights, and sounds the horn for about 3 minutes or until the alarm is turned off.

#### **To use the Panic Alarm:**

Press and hold the Panic Button for at least 1 second to activate the panic alarm. Press and hold the panic button a second time or unlock the door with the key (if equipped with central locking) to deactivate the alarm. The alarm will also shut itself off after 3 minutes, or when the vehicle speed reaches 15 MPH (24 km/h).

#### **To Program Additional Transmitters:**

Up to 4 transmitters can be programmed to your vehicle. To program a transmitter, perform the following procedure:

1. With the vehicle in Park, turn the ignition switch to the ON/RUN position.

2. Using a currently programmed transmitter, press the Unlock button on the transmitter. Continue to hold the Unlock button, wait at least 4 but no longer than 10 seconds, then press and hold the Panic button for at least one second. Release both buttons simultaneously. You will hear a chime to signal that you can proceed with programming the new transmitter.

3. Press and release the Lock and Unlock buttons simultaneously, followed by a press and release of ANY button on each new transmitter to be programmed as well as the original transmitter. You will hear a chime when a transmitter has been successfully programmed. You will have 30 seconds to finish programming all new transmitters. A chime will sound when the 30 seconds is over or the ignition switch is turned to the LOCK position.

#### **General Information**

This transmitter complies with FCC rules part 15 and with RS-210 of Industry Canada. Operation is subject to the following two conditions:

1. This device may not cause harmful interference

## 18 THINGS TO KNOW BEFORE STARTING YOUR VEHICLE

2. This device must accept any interference that may be received, including interference that may cause undesired operation

If your Remote Lock Control fails to operate from a normal distance, check for these two conditions:

1. Weak batteries in transmitter. The expected life of batteries is from one to two years
2. Closeness to a radio transmitter such as a radio station tower, airport transmitter, and some mobile or CB radios.

### Transmitter Battery Service

The recommended replacement batteries are CR2016.

1. Pry the transmitter halves apart with a dime or similar object. Make sure not to damage the rubber gasket material during removal.

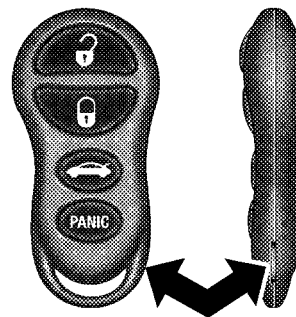

8091f2a8

### Separating Transmitter Halves

2. Remove and replace the batteries. Avoid touching the new batteries with your fingers. Skin oils may cause battery deterioration. If you touch the battery, clean it with rubbing alcohol.
3. Reassemble the transmitter case. Snap the halves together and test transmitter operation.

**VEHICLE THEFT ALARM**

The system monitors the doors, trunk, and ignition for unauthorized operation.

If something triggers the alarm, the system will signal for up to 18 minutes. For the first three minutes the horn will sound and the headlights and interior lights will flash. Then the horn will stop and if the source of the trigger is still present, the lights will continue to flash for another 15 minutes.

**NOTE:** The engine will not start until you disarm the system.

**To set the alarm:**

1. Remove the keys from the ignition switch and get out of the vehicle.
2. Lock the door using either the power door lock switch, the key, or the Keyless Entry Transmitter and close all doors.

3. The light in the instrument cluster will flash rapidly for 15 seconds. This shows that the system is arming. If the light comes on but does not flash, the system is still armed, but there is a problem in the trunk circuit. After 15 seconds the light will continue to flash slowly. This shows that the system is fully armed.

**To disarm the system:**

Unlock a front door using either the key or the Keyless Entry Transmitter.

**Tamper Alert**

If the horn sounds 3 times when you unlock a front door using either a key or the Keyless Entry Transmitter, the alarm had been triggered. Check the vehicle for tampering.

**Security System Manual Override**

The system will not arm if you lock the doors using the manual lock control.

### TRUNK LOCK AND RELEASE

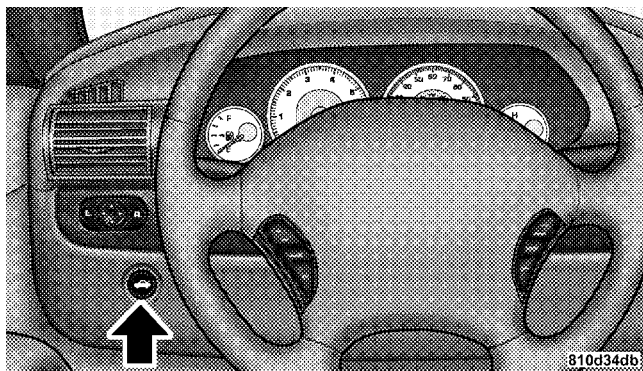

**Trunk Release Button**

Use the key or the Remote Keyless Entry Transmitter to open the trunk from outside the vehicle. From inside the car the trunk lid can be released by depressing the Trunk Release Button located on the instrument panel to the left of the steering wheel. The transmission must be in Park before the switch will operate. Vehicles with manual transmissions must be at zero mph for the switch to work.

With the ignition ON, the word “deck” will be displayed in place of the odometer display indicating that the trunk is open. The odometer display will reappear once the trunk is closed or if the trip button is depressed.

With the key in lock position or key out, the “deck” will be displayed until the trunk is closed.

### TRUNK SAFETY WARNING

#### **WARNING!**

Do not allow children to have access to the trunk, either by climbing into the trunk from outside, or through the inside of the vehicle. Always close the trunk lid when your vehicle is unattended. Once in the trunk, young children may not be able to escape, even if they entered through the rear seat. If trapped in the trunk, children can die from suffocation or heat stroke.

**Trunk Internal Emergency Release**

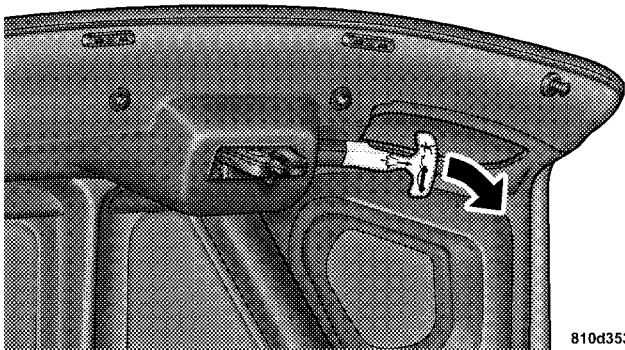

810d3531

**Emergency Release**

**NOTE:** As a security measure, a Trunk Internal Emergency Release lever is built into the trunk latching mechanism. In the event of an individual being locked inside the trunk, the trunk can be simply opened by pulling on the glow-in-the-dark handle attached to the trunk latching mechanism. See picture.

**WINDOWS**

**POWER WINDOWS**

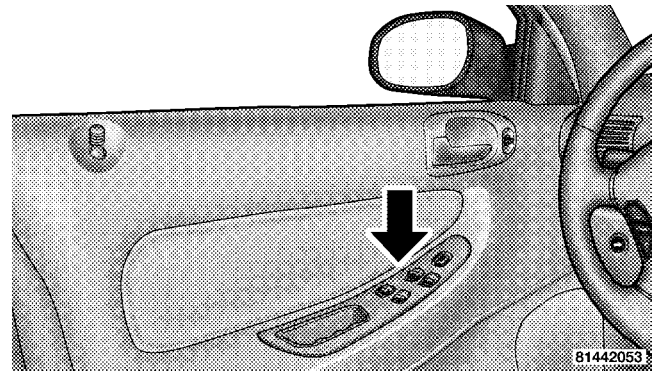

81442053

**Power Window Switches**

**WARNING!**

Never leave children in a vehicle, with the keys in the ignition switch. Occupants, particularly unattended children, can become entrapped by the power windows while operating the power window switch. Such entrapment may result in serious injury or death.

The window controls on the driver's door operate all windows.

The driver's window switch has an Auto Down feature. Press the window switch past the detent, release, and the window will go down automatically.

To open the window part way, pull the window switch part way and release it when you want the window to stop.

**Wind Buffeting**

Wind buffeting can be described as the perception of pressure on the ears or a helicopter type sound in the ears. Your vehicle may exhibit wind buffeting with the windows down, or in certain open or partially open positions. This is a normal occurrence and can be minimized. If the buffeting occurs with the rear windows open, open the front and rear windows together to minimize the buffeting.

**OCCUPANT RESTRAINTS**

Some of the most important safety features in your vehicle are the restraint systems. These include the front and rear seat belts for the driver and all passengers, front airbags for both the driver and front passenger and, if so equipped, left and right window bags for the driver and passengers seated next to a window. If you will be carrying children too small for adult-size belts, your seat belts also can be used to hold infant and child restraint systems.

Please pay close attention to the information in this section. It tells you how to use your restraint system properly to keep you and your passengers as safe as possible.

**WARNING!**

**In a collision, you and your passengers can suffer much greater injuries if you are not properly buckled up. You can strike the interior of your vehicle or other passengers, or you can be thrown out of the vehicle. Always be sure you and others in your vehicle are buckled up properly.**

Buckle up even though you are an excellent driver, even on short trips. Someone on the road may be a poor driver and cause a collision which includes you. This can happen far away from home or on your own street.

Research has shown that seat belts save lives, and they can reduce the seriousness of injuries in a collision. Some of the worst injuries happen when people are thrown from the vehicle. Seat belts reduce the possibility of ejection and the risk of injury caused by striking the inside of the vehicle. **Everyone** in a motor vehicle should be belted at all times.

**Lap/Shoulder Belts**

All seating positions in your vehicle are equipped with Lap/Shoulder Belts.

The belt webbing retractor is designed to lock during very sudden stops or impacts. This feature allows the shoulder part of the belt to move freely with you under normal conditions. But in a collision, the belt will lock and reduce your risk of striking the inside of the vehicle or being thrown out.

**WARNING!**

- Wearing a seat belt incorrectly is dangerous. Seat belts are designed to go around the large bones of your body. These are the strongest parts of your body and can take the forces of a collision the best. Wearing your belt in the wrong place could make your injuries in a collision much worse. You might suffer internal injuries, or you could even slide out of part of the belt. Follow these instructions to wear your seat belt safely and to keep your passengers safe, too.
- Two people should never be belted into a single seat belt. People belted together can crash into one another in an accident, hurting one another badly. Never use a lap/shoulder belt or a lap belt for more than one person, no matter what their size.

**Lap/Shoulder Belt Operating Instructions**

1. Enter the vehicle and close the door. Sit back and adjust the front seat.

2. The seat belt latch plate is above the back of your seat. Grasp the latch plate and pull out the belt. Slide the latch plate up the webbing as far as necessary to make the belt go around your lap.

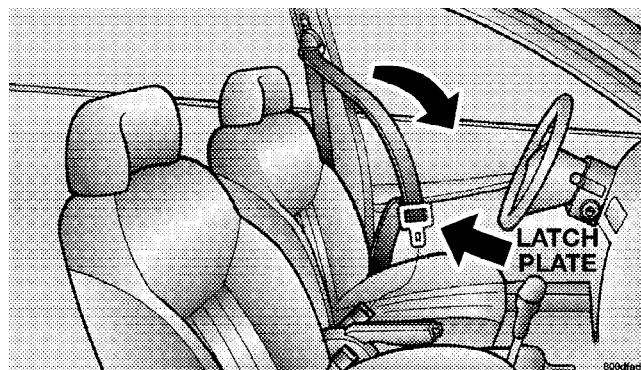

3. When the belt is long enough to fit, insert the latch plate into the buckle until you hear a "click."



**WARNING!**

- A belt that is buckled into the wrong buckle will not protect you properly. The lap portion could ride too high on your body, possibly causing internal injuries. Always buckle your belt into the buckle nearest you.
- A belt that is too loose will not protect you as well. In a sudden stop you could move too far forward, increasing the possibility of injury. Wear your seat belt snugly.
- A belt that is worn under your arm is very dangerous. Your body could strike the inside surfaces of the vehicle in a collision, increasing head and neck injury. A belt worn under the arm can cause internal injuries. Ribs aren't as strong as shoulder bones. Wear the belt over your shoulder so that your strongest bones will take the force in a collision.
- A shoulder belt placed behind you will not protect you from injury during a collision. You are more likely to hit your head in a collision if you do not wear your shoulder belt. The lap and shoulder belt are meant to be used together.

4. Position the lap belt across your thighs, below your abdomen. To remove slack in the lap belt portion, pull up a bit on the shoulder belt. To loosen the lap belt if it is too tight, tilt the latch plate and pull on the lap belt. A snug belt reduces the risk of sliding under the belt in a collision.

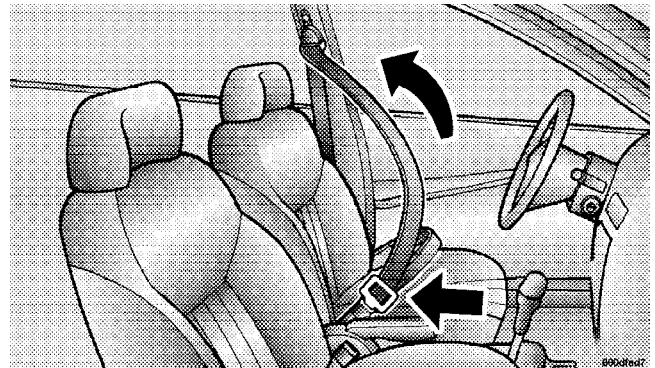

**WARNING!**

- A lap belt worn too high can increase the risk of internal injury in a collision. The belt forces won't be at the strong hip and pelvic bones, but across your abdomen. Always wear the lap belt as low as possible and keep it snug.
- A twisted belt can't do its job as well. In a collision it could even cut into you. Be sure the belt is straight. If you can't straighten a belt in your vehicle, take it to your dealer and have it fixed.

5. Position the shoulder belt on your chest so that it is comfortable and not resting on your neck. The retractor will withdraw any slack in the belt.

6. To release the belt, push the red button on the buckle. The belt will automatically retract to its stowed position. If necessary, slide the latch plate down the webbing to allow the belt to retract fully.

**WARNING!**

A frayed or torn belt could rip apart in a collision and leave you with no protection. Inspect the belt system periodically, checking for cuts, frays, or loose parts. Damaged parts must be replaced immediately. Do not disassemble or modify the system. Seat belt assemblies must be replaced after a collision if they have been damaged (bent retractor, torn webbing, etc.).

**Adjustable Upper Shoulder Belt Anchorage**

In the driver and front passenger seats, the shoulder belt can be adjusted upward or downward to position the belt away from your neck. Push the lever above the webbing upward to release the anchorage, and then move it up or down to the position that serves you best.

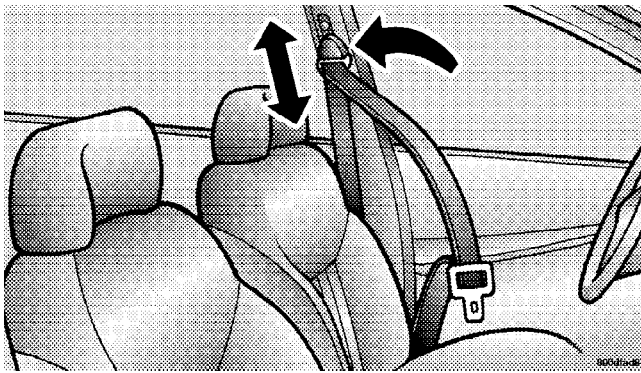

As a guide, if you are shorter than average, you will prefer a lower position, and if you are taller than average, you'll prefer a higher position. When you release the anchorage, try to move it up or down to make sure that it is locked in position.

In the rear seat, move toward the center of the seat to position the belt away from your neck.

### Seat Belt Pretensioners

The seat belts for both front seating positions are equipped with pretensioning devices that are designed to remove any slack from the seat belts in the event of a collision. These devices improve the performance of the seat belt system by assuring that the belt is tight about the occupant early in a collision. Pretensioners work for all size occupants, including those in child restraints.

**NOTE:** These devices are not a substitute for proper seat belt placement by the occupant. The seat belt still must be worn snugly and positioned properly.

The pretensioners are triggered by the front airbag control module (see Airbag Section). Like the front airbags, the pretensioners are single use items. After a collision that is severe enough to deploy the airbags and pretensioners, both must be replaced.

**Enhanced Driver Seat Belt Reminder System (BeltAlert)**

If the driver's seat belt has not been buckled within 60 seconds of starting the vehicle and if the vehicle speed is greater than 5 mph (8 km/h), the Enhanced Warning System (BeltAlert) will alert the driver to buckle their seat belt. The driver should also instruct all other occupants to buckle their seat belts. Once the warning is triggered, the Enhanced Warning System (BeltAlert) will continue to chime and flash the Seat Belt Warning Light for 96 seconds or until the driver's seat belt is buckled or the vehicle speed is below 5 mph (8 km/h). The Enhanced Warning System (BeltAlert) will be reactivated if the driver's seat belt is unbuckled for more than 10 seconds and the vehicle speed is greater than 5 mph (8 km/h).

The Enhanced Warning System (BeltAlert) can be enabled or disabled by your authorized dealer or by following these steps:

**NOTE:** The following steps must occur within the first 60 seconds of the ignition switch being turned to the ON or START position. DaimlerChrysler does not recommend deactivating the Enhanced Warning System (BeltAlert).

1. Turn the ignition switch to the OFF position and buckle the driver's seat belt.
2. Start the engine and wait for the Seat Belt Warning Light to turn off.
3. Within 60 seconds of starting the vehicle, unbuckle and then re-buckle the driver's seat belt at least three times within 10 seconds, ending with the seat belt buckled.

**NOTE:** Watch for the Seat Belt Warning Light to turn on while unbuckling and off while re-buckling the seat belt. It may be necessary to retract the seat belt.

4. Turn off the engine. A single chime will sound to signify that you have successfully completed the programming.

The Enhanced Warning System (BeltAlert) can be reactivated by repeating this procedure.

**NOTE:** Although the Enhanced Warning System (BeltAlert) has been deactivated, the Seat Belt Warning Light will continue to illuminate while the driver's seat belt remains unbuckled.

#### **Seat Belts and Pregnant Women**

We recommend that pregnant women use the seat belts throughout their pregnancy. Keeping the mother safe is the best way to keep the baby safe.

Pregnant women should wear the lap part of the belt across the thighs and as snug across the hips as possible. Keep the belt low so that it does not come across the abdomen. That way the strong bones of the hips will take the force if there is a collision.

#### **Seat Belt Extender**

If a seat belt is too short, even when fully extended and when the adjustable upper shoulder belt anchorage (if so equipped) is in its lowest position, your dealer can provide you with a seat belt extender. This extender should be used only if the existing belt is not long enough. When it is not required, remove the extender and store it.

2

#### **WARNING!**

Using a seat belt extender when not needed can increase the risk of injury in a collision. Only use when the seat belt is not long enough when it is worn low and snug, and in the recommended seating positions. Remove and store the extender when not needed.

**Driver and Right Front Passenger Supplemental Restraint System (SRS) - Airbag**

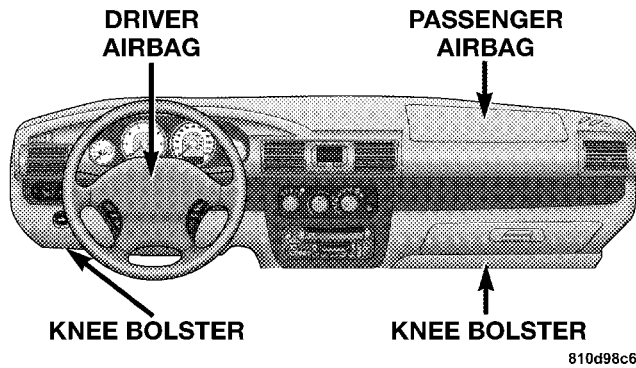

**Front Airbag Components**

This vehicle has front airbags for both the driver and front passenger as a supplement to the seat belt restraint systems. The driver's airbag is mounted in the center of the steering wheel. The passenger's front airbag is mounted in the instrument panel, above the glove compartment. The words SRS AIRBAG are embossed on the airbag covers.

This vehicle may also be equipped with left and right window bags to protect the driver and passengers sitting next to a window. If the vehicle is equipped with window bags, they are located above the side windows. Their covers are also labeled SRS AIRBAG.

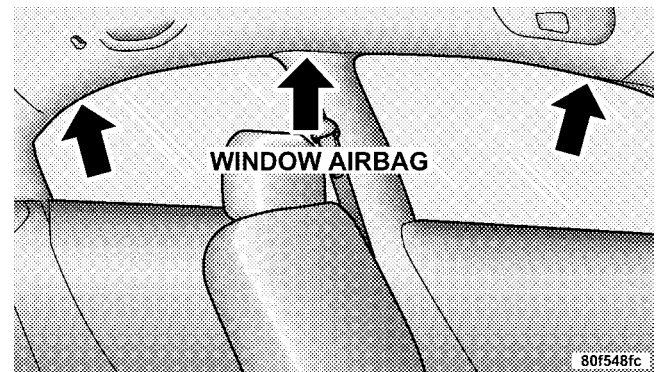

**Window Airbag**

**NOTE:** Airbag covers may not be obvious in the interior trim; but they will open to allow airbag deployment.

**WARNING!**

- Do not put anything on or around the front airbag covers or attempt to manually open them. You may damage the airbags and you could be injured because the airbags are not there to protect you. These protective covers for the airbag cushions are designed to open only when the airbags are inflating.
- If your vehicle is equipped with left and right window bags, do not stack luggage or other cargo up high enough to block the location of the window bag. The area where the window bag is located should remain free from any obstructions.
- If your vehicle is equipped with left and right window bags, do not have any accessory items installed which will alter the roof, including adding a sunroof to your vehicle. Do not add roof racks that require permanent attachments (bolts or screws) for installation on the vehicle roof. Do not drill into the roof of the vehicle for any reason.
- Do not drill, cut or tamper with the knee bolster in any way.
- Do not mount any accessories to the knee bolster such as alarm lights, stereos, citizens band radios etc.

Airbags inflate in moderate to high speed impacts. Along with the seat belts, front airbags work with the instrument panel knee bolsters to provide improved protection for the driver and front passenger. Left and right window airbags also work with seat belts to improve occupant protection.

The seat belts are designed to protect you in many types of collisions. The front airbags deploy only in moderate to severe frontal collisions. If your vehicle is so equipped, the window bag on the crash side of the vehicle is triggered in moderate to severe side collisions. In certain types of collisions where the airbags deploy, you need the seat belts to keep you in the right position for the airbags to protect you properly.

Here are some simple steps you can take to minimize the risk of harm from a deploying airbag.

1. Children 12 years old and under should ride buckled up in the rear seat. Infants in rear-facing child restraints should **NEVER** ride in the front seat of a vehicle with a passenger front airbag. An airbag deployment could cause severe injury or death to infants in that position.

### 32 THINGS TO KNOW BEFORE STARTING YOUR VEHICLE

Children that are not big enough to properly wear the vehicle seat belt (see section on "Child Restraint") should be secured in the rear seat in child restraints or belt-positioning booster seats.

Older children who do not use child restraints or belt-positioning booster seats should ride properly buckled up in the rear seat. Never allow children to slide the shoulder belt behind them or under their arm.

If a child from 1 to 12 years old must ride in the front passenger seat because the vehicle is crowded, move the seat as far back as possible, and use the proper child restraint. See the section on "Child Restraint".

2. You should read the instructions provided with your child restraint to make sure that you are using it properly.
3. All occupants should use their seat belts properly.
4. The driver and front passenger seats should be moved back as far as practical to allow the airbags time to inflate.
5. If your vehicle has left and right window bags, do not lean against the door, airbags will inflate forcefully into the space between you and the door.

#### WARNING!

- Relying on the airbags alone could lead to more severe injuries in a collision. The airbags work with your seat belt to restrain you properly. In some collisions the airbags won't deploy at all. Always wear your seat belts even though you have airbags.
- Being too close to the steering wheel or instrument panel during airbag deployment could cause serious injury. Airbags need room to inflate. Sit back, comfortably extending your arms to reach the steering wheel or instrument panel.
- If the vehicle has left and right window bags, they also need room to inflate. Do not lean against the door or window. Sit upright in the center of the seat.

#### Airbag System Components

The front airbag system consists of the following:

- Airbag Control Module



- AIRBAG Readiness Light
- Driver Airbag
- Passenger Airbag
- Steering Wheel and Column
- Instrument Panel
- Interconnecting Wiring
- Knee Impact Bolsters
- Left and Right Window Bags Above Side Windows — If Equipped
- Left and Right Side Impact Sensors — If Equipped
- Driver and Front Passenger Seat Belt Pretensioners

**How The Airbag System Works**

- The airbag control module determines if a frontal collision is severe enough to require the airbags to inflate. The control module receives the level of collision severity, determines the proper level of airbag to be deployed. The frontal airbag inflators are designed to provide three different rates of air bag inflation.

- The airbag control module will not detect rollover or rear collisions.
  - The airbag control module also monitors the readiness of the electronic parts of the system whenever the ignition switch is in the START or RUN positions. These include all of the items listed above except the knee bolster, the instrument panel, and the steering wheel and column. If the key is in the “off” position, in the ACC position, or not in the ignition, the airbags are not on and will not inflate.
- AIR BAG**
- The airbag control module also turns on the AIRBAG light in the instrument panel for 6 to 8 seconds when the ignition is first turned on, then turns the light off. If it detects a malfunction in any part of the system, it turns on the light either momentarily or continuously.

**WARNING!**

Ignoring the AIRBAG light in your instrument panel could mean you won't have the airbags to protect you in a collision. If the light does not come on, stays on after you start the vehicle, or if it comes on as you drive, have the airbag system checked right away.

- When the airbag control module detects a collision requiring the airbags, it signals the inflator units. A large quantity of nontoxic gas is generated to inflate the airbags. Three levels of airbag inflation rates are possible. These rates are determined by the airbag control module based on collision severity. The airbag covers separate and fold out of the way as the airbags inflate to their full size. The airbags fully inflate in about 60 milliseconds. This is only about half of the time it takes you to blink your eyes. The airbags then quickly deflate while helping to restrain the driver and front passenger. The driver's front airbag gas is vented through a vent hole in the rear of the airbag. The passenger's front airbag gas is vented through vent

holes in the sides of the airbag. In this way the airbags do not interfere with your control of the vehicle.

- The Knee Impact Bolsters help protect the knees and position you for the best interaction with the front airbag.

**If A Deployment Occurs**

The airbag system is designed to deploy when the airbag control module detects a moderate-to-severe collision, to help restrain the driver and front passenger, and then to immediately deflate.

**NOTE:** A collision that is not severe enough to need airbag protection will not activate the system. This does not mean something is wrong with the airbag system.

If you do have a collision which deploys the airbags, any or all of the following may occur:

- The nylon airbag material may sometimes cause abrasions and/or skin reddening to the driver and right front passenger as the airbags deploy and unfold. The abrasions are similar to friction rope burns or those you might get sliding along a carpet or gymnasium floor. They are not caused by contact with chemicals.

They are not permanent and normally heal quickly. However, if you haven't healed significantly within a few days, or if you have any blistering, see your doctor immediately.

- As the airbags deflate you may see some smoke-like particles. The particles are a normal by-product of the process that generates the nontoxic gas used for airbag inflation. These airborne particles may irritate the skin, eyes, nose, or throat. If you have skin or eye irritation, rinse the area with cool water. For nose or throat irritation, move to fresh air. If the irritation continues, see your doctor. If these particles settle on your clothing, follow the garment manufacturer's instructions for cleaning.
- It is not advisable to drive your vehicle after the airbags have been deployed. If you are involved in another collision, the airbags will not be in place to protect you.

### WARNING!

Deployed airbags can't protect you in another collision. Have the airbags replaced by an authorized dealer as soon as possible.

2

#### Side Airbag System

The airbag control module determines if a side collision is severe enough to require the airbag to inflate. The control module receives the level of collision severity from the side impact sensors. The airbag control module will not detect rollover or rear impacts.

The side impact SRS Airbags are designed to activate only in certain side collisions. When the airbag control module detects a collision requiring the window bags to inflate, it signals the inflators on the crash side of the vehicle. A quantity of nontoxic gas is generated to inflate the window bag. The inflating window bag pushes the outside edge of the headliner out of the way and inflates (in about the same time it takes to blink your eyes) with enough force to injure you if you are not belted and seated properly, or if items are positioned in the area

where the window bag inflates. This especially applies to children. The window bag is only about 3 ½ inches (8 ¾ cm) thick when it is inflated.

#### Maintaining Your Airbag System

##### **WARNING!**

- Modifications to any part of the airbag system could cause it to fail when you need it. You could be injured because the airbags are not there to protect you. Do not modify the components or wiring, including adding any kind of badges or stickers to the steering wheel hub trim cover or the upper right side of the instrument panel. Do not modify the front bumper, vehicle body structure, or frame.
- You need proper knee impact protection in a collision. Do not mount or locate any aftermarket equipment on or behind the knee impact bolster.
- It is dangerous to try to repair any part of the airbag system yourself. Be sure to tell anyone who works on your vehicle that it has airbags.

#### Airbag Light

You will want to have the airbags ready for your protection in an impact. While the airbag system is designed to be maintenance free, if any of the following occurs, have an authorized dealer service the system promptly:

- The AIRBAG light does not come on or flickers during the 6 to 8 seconds when the ignition switch is first turned on.
- The light remains on or flickers after the 6 to 8 second interval.
- The light flickers or comes on and remains on while driving.

#### Child Restraint

Everyone in your vehicle needs to be buckled up all the time, babies and children, too. Every state in the United States and all Canadian provinces require that small children ride in proper restraint systems. This is the law, and you can be prosecuted for ignoring it.

Children 12 years and under should ride properly buckled up in a rear seat, if available. According to crash statistics, children are safer when properly restrained in the rear seats rather than in the front.

#### **WARNING!**

**In a collision, an unrestrained child, even a tiny baby, can become a missile inside the vehicle. The force required to hold even an infant on your lap could become so great that you could not hold the child, no matter how strong you are. The child and others could be badly injured. Any child riding in your vehicle should be in a proper restraint for the child's size.**

There are different sizes and types of restraints for children from newborn size to the child almost large enough for an adult safety belt. Always check the child seat Owner's Manual to ensure you have the right seat for your child. Use the restraint that is correct for your child:

#### **Infants and Child Restraints**

- Safety experts recommend that children ride rearward-facing in the vehicle until they are at least one year old **and** weigh at least 9 kg (20 lbs). Two types of child restraints can be used rearward-facing: infant carriers and "convertible" child seats.
- The infant carrier is only used rearward-facing in the vehicle. It is recommended for children who weigh up to about 20 lbs (9 kg). "Convertible" child seats can be used either rearward-facing or forward-facing in the vehicle. Convertible child seats often have a higher weight limit in the rearward-facing direction than infant carriers do, so they can be used rearward-facing by children who weigh more than 20 lbs (9 kg) but are less than one year old. Both types of child restraints are held in the vehicle by the lap/shoulder belt or the LATCH child restraint anchorage system. (See the LATCH — Child Seat Anchorage System section.)

- Rearward-facing child seats must **NEVER** be used in the front seat of a vehicle with the front passenger airbag unless the airbag is turned off. An airbag deployment could cause severe injury or death to infants in this position.

**WARNING!**

- **Improper installation can lead to failure of an infant or child restraint. It could come loose in a collision. The child could be badly injured or killed. Follow the manufacturer's directions exactly when installing an infant or child restraint.**
- **A rearward facing child restraint should only be used in a rear seat. A rearward facing child restraint in the front seat may be struck by a deploying passenger airbag which may cause severe or fatal injury to the infant.**

**Here are some tips on getting the most out of your child restraint:**

- Before buying any restraint system, make sure that it has a label certifying that it meets all applicable Safety Standards. We also recommend that you make sure that you can install the child restraint in the vehicle where you will use it before you buy it.
- The restraint must be appropriate for your child's weight and height. Check the label on the restraint for weight and height limits.
- Carefully follow the instructions that come with the restraint. If you install the restraint improperly, it may not work when you need it.
- Buckle the child into the seat according to the child restraint manufacturer's directions.
- When your child restraint is not in use, secure it in the vehicle with the seat belt or remove it from the vehicle. Do not leave it loose in the vehicle. In a sudden stop or collision, it could strike the occupants or seat backs and cause serious personal injury.

**NOTE:** For additional information refer to [www.seatcheck.org](http://www.seatcheck.org) or call 1-866-SEATCHECK.

#### Older Children and Child Restraints

Children who weigh more than 20 lbs (9 kg) and who are older than one year can ride forward-facing in the vehicle. Forward-facing child seats and convertible child seats used in the forward-facing direction are for children who weigh 20 to 40 lbs (9 to 18 kg) and who are older than one year. These child seats are also held in the vehicle by the lap/shoulder belt or the LATCH child restraint anchorage system. (See the LATCH — Child Seat Anchorage System Section.)

The belt-positioning booster seat is for children weighing more than 40 lbs (18 kg), but who are still too small to fit the vehicle's seat belts properly. If the child cannot sit with knees bent over the vehicle's seat cushion while the child's back is against the seat back, they should use a belt-positioning booster seat. The child and belt-positioning booster seat are held in the vehicle by the lap/shoulder belt.

#### Children Too Large For Booster Seats

Children who are large enough to wear the shoulder belt comfortably, and whose legs are long enough to bend over the front of the seat when their back is against the seat back, should use the lap/shoulder belt in a rear seat.

- Make sure that the child is upright in the seat.
- The lap portion should be low on the hips and as snug as possible.
- Check belt fit periodically. A child's squirming or slouching can move the belt out of position.
- If the shoulder belt contacts the face or neck, move the child closer to the center of the vehicle. Never allow a child to put the shoulder belt under an arm or behind their back.

#### LATCH — Child Seat Anchorage System (Lower Anchors and Tether for Children)

Your vehicle's rear seat is equipped with the child restraint anchorage system called LATCH. The LATCH system provides for the installation of the child restraint without using the vehicle's seat belts, instead securing

#### 40 THINGS TO KNOW BEFORE STARTING YOUR VEHICLE

the child restraint using lower anchorages and upper tether straps from the child restraint to the vehicle structure.

LATCH-compatible child restraint systems are now available. However, because the lower anchorages are to be introduced over a period of years, child restraint systems having attachments for those anchorages will continue to also have features for installation using the vehicle's seat belts. Child restraints having tether straps and hooks for connection to the top tether anchorages have been available for some time. For some older child restraints, many child restraint manufacturers offer add-on tether strap kits or retro-fit kits. You are urged to take advantage of all the available attachments provided with your child restraint in any vehicle.

All three rear seating positions have lower anchorages that are capable of accommodating LATCH-compatible child seats having flexible, webbing-mounted lower attachments. Child seats with fixed lower attachments must be installed in the outboard positions only. Regardless of the specific type of lower attachment, **NEVER** install LATCH-compatible child seats such that two seats

share a common lower anchorage. If you are installing LATCH-compatible child restraints in adjacent rear seating positions, you can use the LATCH anchors or the vehicle's seat belt for the outboard position, but you must use the vehicle's seat belt at the center position. If your child restraints are not LATCH-compatible, you can only install the child restraints using the vehicle's seat belts. Please refer to the next section for typical installation instructions.

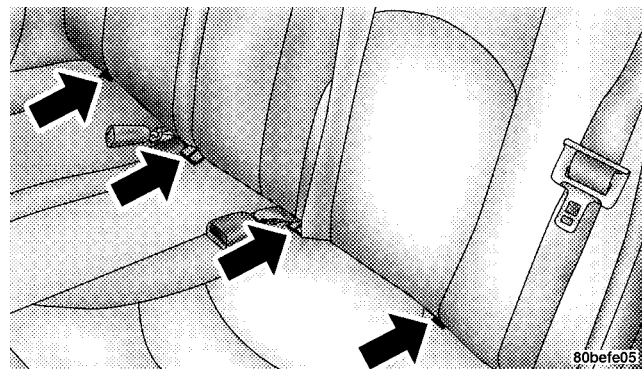

LATCH



### Installing the LATCH-Compatible Child Restraint System

We urge that you carefully follow the directions of the manufacturer when installing your child restraint. Not all child restraint systems will be installed as described here. Again, carefully follow the installation instructions that were provided with the child restraint system.

The rear seat lower anchorages are round bars, located at the rear of the seat cushion where it meets the seat back, and are just visible when you lean into the rear seat to install the child restraint. You will easily feel them if you run your finger along the intersection of the seatback and seat cushion surfaces.



In addition, there are tether strap anchorages behind each rear seating position located in the panel between the rear seat back and the rear window. These tether strap anchorages are under a hinged plastic cover with this symbol on it.

Many, but not all restraint systems will be equipped with separate straps on each side, with each having a hook or connector for attachment to the lower anchorage and a

means of adjusting the tension in the strap. Forward-facing toddler restraints and some rear-facing infant restraints will also be equipped with a tether strap, a hook for attachment to the tether strap anchorage and a means of adjusting the tension of the strap.

You will first loosen the adjusters on the lower straps and on the tether strap so that you can more easily attach the hooks or connectors to the vehicle anchorages. Next attach the lower hooks or connectors over the top of the anchorage bars, pushing aside the seat cover material. Then rotate the tether anchorage cover directly behind the seat where you are placing the child restraint and attach the tether strap to the anchorage, being careful to route the tether strap to provide the most direct path between the anchor and the child restraint. If your vehicle is equipped with adjustable rear head restraints, raise the head restraint and, where possible, route the tether strap under the head restraint and between the two posts. If not possible, lower the head restraint and route the tether strap around the outboard side of the head restraint. Finally, tighten all three straps as you push the

## 42 THINGS TO KNOW BEFORE STARTING YOUR VEHICLE

child restraint rearward and downward into the seat, removing slack in the straps according to the child restraint manufacturer's instructions.

**NOTE:** When using the LATCH attaching system to install a child restraint, please ensure that all seat belts not being used for occupant restraints are stowed and out of reach of children. It is recommended that before installing the child restraint buckle the seat belt so the seat belt is tucked behind the child restraint and out of reach. If the buckled seat belt interferes with the child restraint installation, instead of tucking the seat belt behind the child restraint, route the seat belt through the child restraint belt path and then buckle it. This should stow the seat belt out of the reach of an inquisitive child. Remind all children in the vehicle that the seat belts are not toys and should not be played with, and never leave your child unattended in the vehicle.

### **WARNING!**

**Improper installation of a child restraint to the LATCH anchorages can lead to failure of an infant or child restraint. The child could be badly injured or killed. Follow the manufacturer's directions exactly when installing an infant or child restraint.**

#### **Installing Child Restraints Using the Vehicle Seat belt**

The passenger seat belts are equipped with cinching latch plates which are designed to keep the lap portion tight around the child restraint so that it is not necessary to use a locking clip. Pulling up on the shoulder portion of the lap/shoulder belt will tighten the belt. The cinching latch plate will keep the belt tight, however, any seat belt system will loosen with time, so check the belt occasionally and pull it tight if necessary.

In the rear seat, you may have trouble tightening the lap/shoulder belt on the child restraint because the buckle or latch plate is too close to the belt path opening on the restraint. Disconnect the latch plate from the buckle and twist the short buckle-end belt several times to shorten it. Insert the latch plate into the buckle with the release button facing out.

If the belt still can't be tightened, or if by pulling and pushing on the restraint loosens the belt, you may need to do something more. Disconnect the latch plate from the buckle, turn the buckle around, and insert the latch plate into the buckle again. If you still can't make the child restraint secure, try a different seating position.

#### *Child restraint tether strap attachment*

1. Rotate the cover over the anchor directly behind the seat where you are placing the child restraint.

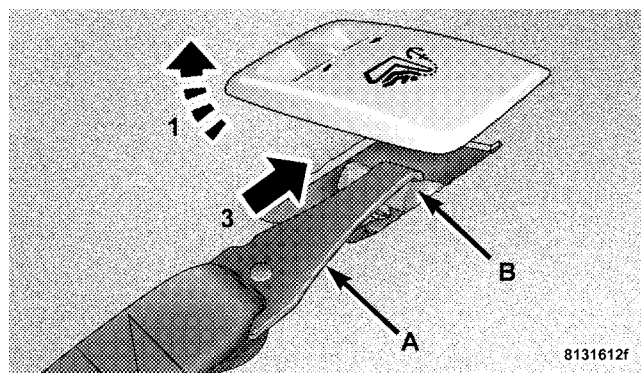

#### **Tether Strap Mounting**

2. Route the tether strap to provide the most direct path for the strap between the anchor and the child seat. If your vehicle is equipped with adjustable rear head restraints, raise the head restraint and, where possible, route the tether strap under the head restraint and between the two posts. If not possible, lower the head restraint and pass the tether strap around the outboard side of the head restraint.

3. Attach the tether strap hook (A) of the child restraint to the anchor (B) and remove slack in the tether strap according to the child restraint manufacturer's instructions.

**WARNING!**

**An incorrectly anchored tether strap could lead to increased head motion and possible injury to the child. Use only the anchor positions directly behind the child seat to secure a child restraint top tether strap.**

**Transporting Pets**

Airbags deploying in the front seat could harm your pet. An unrestrained pet will be thrown about and possibly injured, or injure a passenger during panic braking or in a collision.

Pets should be restrained in the rear seat in pet harnesses or pet carriers that are secured by seat belts.

**ENGINE BREAK-IN RECOMMENDATIONS**

The engine in your new vehicle does not require a long break-in period.

Drive moderately during the first 300 miles (500 km). After the initial 60 miles (100 km), speeds up to 50 or 55 mph (80 or 90 km/h) are desirable.

While cruising, brief full-throttle acceleration, within the limits of local traffic laws, contributes to a good break-in.

Wide open throttle acceleration in low gear can be detrimental and should be avoided.

The crankcase oil installed in the engine at the factory is a high quality energy conserving type lubricant. Oil changes should be consistent with expected climate conditions under which vehicle operations will occur. The recommended viscosity and quality grades are in Section 7 of this manual.

Do not use non-detergent or straight mineral oils.

A new engine may consume some oil during its first few thousand miles of operation. This is a normal part of the break-in and not an indication of a problem.

**SAFETY TIPS****Exhaust Gas****WARNING!**

Exhaust gases can injure or kill. They contain carbon monoxide (CO) which is colorless and odorless. Breathing it can make you unconscious and can eventually poison you. To avoid breathing (CO) follow the safety tips below.

- Do not run the engine in a closed garage or in confined areas any longer than needed to move your vehicle in or out of the area.
- If it is necessary to sit in a parked vehicle with the engine running, adjust your heating or cooling controls to force outside air into the vehicle. Set the blower at high speed.

- To avoid drawing exhaust gases into the vehicle, close the trunk while driving. However, if for some reason it must remain open, close all windows. Adjust the heating or cooling system to force outside air into the vehicle. Set the blower at high speed.

**2****Safety Checks You Should Make Inside the Vehicle****Seat Belts**

Inspect the belt system periodically, checking for cuts, frays and loose parts. Damaged parts must be replaced immediately. Do not disassemble or modify the system.

Safety belt assemblies must be replaced after a collision if they have been damaged (bent retractor, torn webbing, etc.). If there is any question regarding belt or retractor condition, replace the belt.

### Airbag Light

**AIR BAG** The light should come on and remain on for 6 to 8 seconds as a bulb check when the ignition switch is first turned ON. If the bulb is not lit during starting, have it replaced. If the light stays on or comes on while driving, have the system checked by an authorized dealer.

### Defrosters

Check operation by selecting the defrost mode and place the blower control on high speed. You should be able to feel the air directed against the windshield.

### Periodic Safety Checks You Should Make Outside the Vehicle

#### Tires

Examine tires for excessive tread wear or uneven wear patterns. Check for stones, nails, glass, or other objects lodged in the tread. Inspect for tread cuts or sidewall cracks. Check wheel nuts for tightness, and tires (including spare) for proper pressure.

### Lights

Have someone observe the operation of exterior lights while you work the controls. Check turn signal and high beam indicator lights on the instrument panel.

### Fluid Leaks

Check area under vehicle after overnight parking for fuel, water, oil, or other fluid leaks. Also, if gasoline fumes are present, the cause should be corrected immediately.

---

# UNDERSTANDING THE FEATURES OF YOUR VEHICLE

## CONTENTS

---

■ Console Features . . . . .	50	□ Manual Front Seat Adjustments . . . . .	54
□ Console Features — Without Heated Seats . . . . .	50	□ Power Seats — If Equipped . . . . .	56
□ Console Features — With Heated Seats . . . . .	51	□ Adjustable Head Restraints . . . . .	56
■ Mirrors . . . . .	52	□ Folding Rear Seat . . . . .	57
□ Inside Day/Night Mirror— If Equipped . . . . .	52	■ To Open And Close The Hood . . . . .	58
□ Automatic Dimming Mirror— If Equipped . . . . .	52	■ Lights . . . . .	59
□ Electric Remote-Control Mirrors — If Equipped . . . . .	53	□ Interior Lights . . . . .	59
□ Outside Mirror — Driver’s Side . . . . .	53	□ Front Map/Reading Lights — If Equipped . . . . .	60
□ Outside Mirror — Passenger’s Side . . . . .	54	□ Multi-Function Control Lever . . . . .	61
□ Illuminated Vanity Mirrors — If Equipped . . . . .	54	□ Headlights, Parking Lights, Instrument Panel Lights . . . . .	61
■ Seats . . . . .	54	□ Automatic Headlights—If Equipped . . . . .	62

#### 48 UNDERSTANDING THE FEATURES OF YOUR VEHICLE

□ Daytime Running Lights (Canada Only) . . . . .	.62	□ To Resume Speed . . . . .	.67
□ Lights-On Reminder . . . . .	.62	□ To Vary The Speed Setting . . . . .	.67
□ Fog Lights — If Equipped . . . . .	.62	□ To Accelerate For Passing . . . . .	.67
□ Turn Signals . . . . .	.62	□ Using Speed Control On Hills . . . . .	.67
□ Headlight Beam Select Switch . . . . .	.63	■ Garage Door Opener — If Equipped . . . . .	.69
□ Flash To Pass . . . . .	.63	□ Programming The Universal Transceiver . . . . .	.69
□ Headlight Time Delay . . . . .	.63	□ “Rolling Code” Programming . . . . .	.71
■ Windshield Wipers And Washers . . . . .	.63	□ Canadian Programming/Gate Programming . . . . .	.72
□ Mist . . . . .	.64	□ Operation . . . . .	.73
□ Speed Sensitive Intermittent Wiper System . . . . .	.64	□ Reprogramming A Single Button . . . . .	.73
■ Tilt Steering Column . . . . .	.64	□ Security . . . . .	.73
■ Traction Control— If Equipped . . . . .	.65	■ Power Sunroof — If Equipped . . . . .	.74
■ Electronic Speed Control— If Equipped . . . . .	.66	□ Opening Sunroof - Manual . . . . .	.75
□ To Activate . . . . .	.66	□ Opening Sunroof - Express . . . . .	.75
□ To Set At A Desired Speed . . . . .	.66	□ Closing Sunroof - Manual . . . . .	.75
□ To Deactivate . . . . .	.67	□ Venting Sunroof - Express . . . . .	.75



**UNDERSTANDING THE FEATURES OF YOUR VEHICLE 49**

- Sunshade Operation . . . . .75
- Wind Buffeting . . . . .75
- Sunroof Maintenance . . . . .75
- Sunroof Fully Closed . . . . .76
- Electrical Power Outlet . . . . .76

## CONSOLE FEATURES

### Console Features — Without Heated Seats

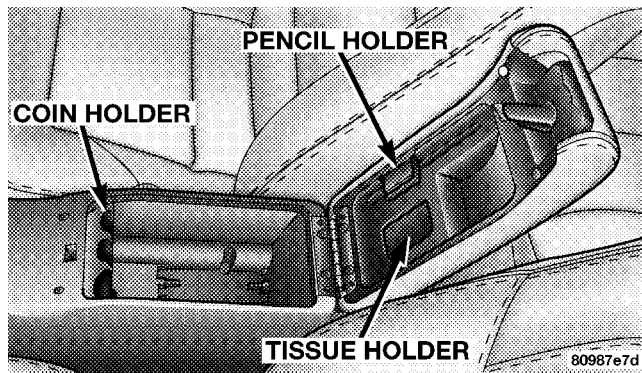

Console

The front console has two cup holders in the front and a storage bin. An optional removable ashtray may be located in the driver's side cup holder.

The center console/armrest has a pencil /tire gage holder and a tissue holder mounted on the underside of the cover. The bottom of the console bin also has built in holders for compact discs or cassette tapes. There are also two cup holders for rear seat passengers located directly in the back of the center console.

Two coin holders are located toward the front of the inside of the console bin. The right side coin holder can accommodate dimes, nickels or pennies, while the left side coin holder can hold quarters, dimes, nickels, or pennies. Both can also accommodate various combinations of different types of coins, including some international currencies. The slot on the far left side is not for coins, but for an optional power outlet, if so equipped.

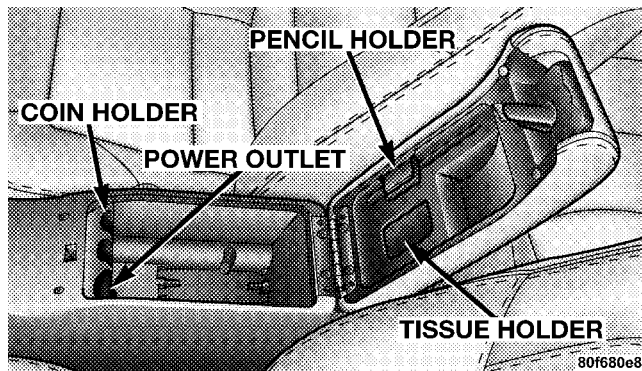
**Console Features — With Heated Seats**

Console

The front console has two cup holders. An optional removable ashtray may be located in the driver's side cup holder.

The center console/armrest has a pencil /tire gage holder and a tissue holder mounted on the underside of the cover. The bottom of the console bin also has built in holders for compact discs or cassette tapes. The power outlet is also mounted inside the center console (if equipped). There are also two cup holders for rear seat passengers and a rear courtesy lamp located directly in back of the center console.

Two coin holders are located toward the front of the inside of the console bin. The right side coin holder can accommodate dimes, nickels or pennies, while the left side coin holder can hold quarters, dimes, nickels, or pennies. Both can also accommodate various combinations of different types of coins, including some international currencies.

## MIRRORS

### Inside Day/Night Mirror— If Equipped

Adjust the mirror to center on the view through the rear window. A two point pivot system allows for horizontal and vertical mirror adjustment.

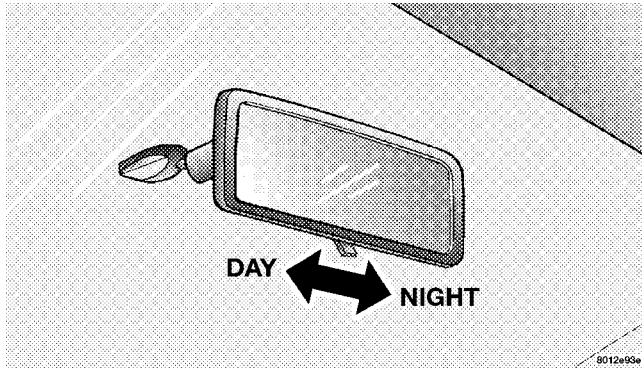

#### Adjusting Rearview Mirror

Annoying headlight glare can be reduced by moving the small control under the mirror to the night position (toward rear of vehicle). The mirror should be adjusted while set in the day position (toward windshield).

### Automatic Dimming Mirror— If Equipped

This mirror will automatically adjust for annoying headlight glare from vehicles behind you. Push in the button on the face of the mirror to activate the dimming feature.

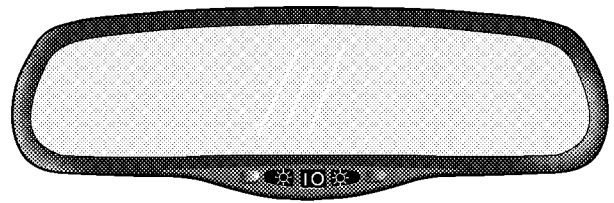

80a334c6

Automatic Dimming Mirror

**CAUTION!**

To avoid damage to the mirror during cleaning, never spray any cleaning solution directly onto the mirror. Apply the solution onto a clean cloth and wipe the mirror clean.

**Electric Remote-Control Mirrors— If Equipped**

Both of the outside mirrors can be adjusted by using the remote controls mounted on the instrument panel to the left of the steering wheel.

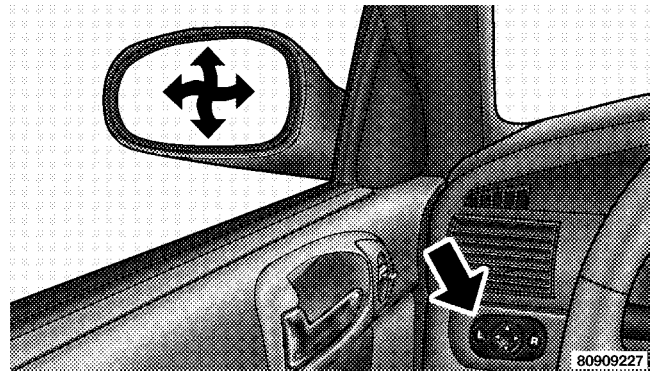
**Power Mirror Controls**

**NOTE:** Place the mirror selector switch in the center (neutral) position to prevent accidental movement of the mirrors.

**Outside Mirror — Driver's Side**

Adjust the outside mirror to center on the adjacent lane of traffic, with a slight overlap of the view obtained on the inside mirror.

**Outside Mirror — Passenger's Side**

Adjust the convex outside mirror so you can just see the side of your vehicle in the part of the mirror closest to the vehicle.

**WARNING!**

Vehicles and other objects seen in the right side convex mirror will look smaller and farther away than they really are. Relying too much on your right side mirror could cause you to collide with another vehicle or other object. Use your inside mirror when judging the size or distance of a vehicle seen in this convex mirror.

**Illuminated Vanity Mirrors — If Equipped**

An illuminated vanity mirror is on each sun visor. To use the mirror, rotate the sun visor down and swing the mirror cover upward. The lights will turn on automatically. Closing the mirror cover turns off the lights.

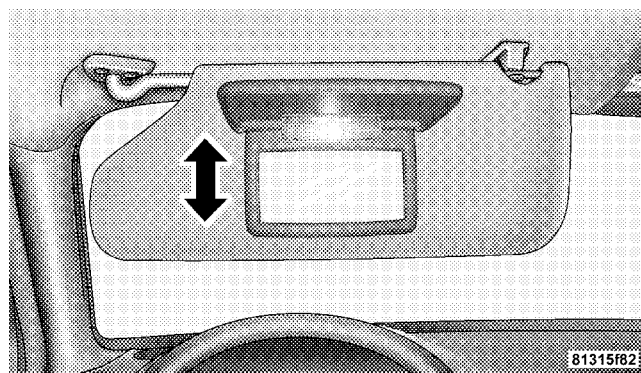

Illuminated Vanity Mirror

**SEATS****Manual Front Seat Adjustments****Forward/Rearward**

The adjusting bar is at the front of the seats, near the floor. Pull the bar up to move the seat to the desired position.

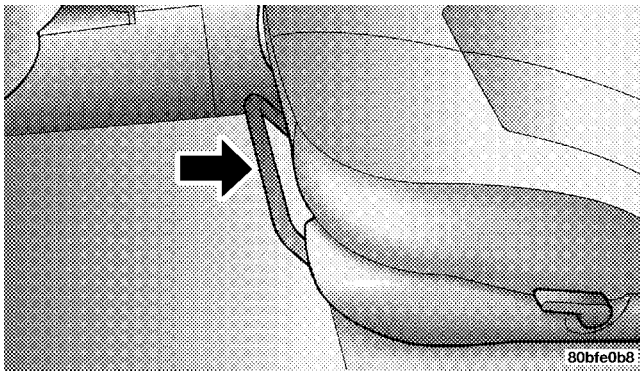

**Manual Seat Adjuster**

After releasing the adjusting bar, apply forward and rearward body pressure to be sure the seat is latched.

### **Reclining Bucket Seats**

The recliner control is on the side of the seat. To recline, lean forward slightly before lifting the lever, then lean back to the desired position and release the lever. Lean forward and lift the lever to return the seatback to its normal position.

### **WARNING!**

- Adjusting a seat while the vehicle is moving is dangerous. The sudden movement of the seat could cause you to lose control. The seat belt might not be properly adjusted and you could be injured. Adjust the seat only while the vehicle is parked.
- Do not ride with the seatback reclined so that the shoulder belt is no longer resting against your chest. In a collision you could slide under the seat belt and be seriously or even fatally injured. Use the recliner only when the vehicle is parked.

**3**

### **Lumbar Support — If Equipped**

This feature allows you to increase or decrease the amount of lumbar support. The control lever is located on the inboard side of the driver's seatback. Turn the control lever forward to increase and rearward to decrease the desired amount of lumbar support.

**Power Seats — If Equipped**

The power seat switches are on the outboard side of the seat near the floor. Use the front switch to move the seat up, down, forward, rearward, or to tilt the seat. The rear switch controls the seatback recliner.

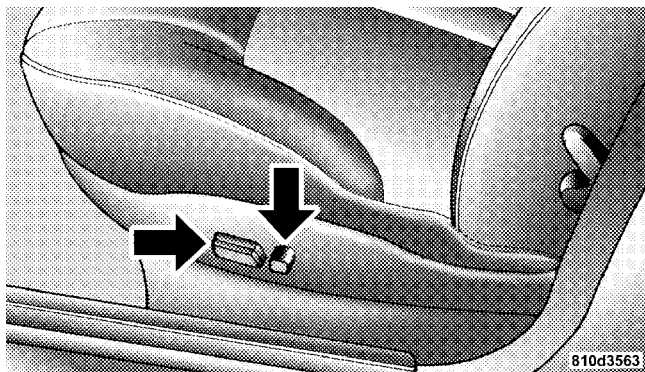

Power Seat Switches

**CAUTION!**

Do not place any article under a power seat as it may cause damage to the seat controls.

**Adjustable Head Restraints**

Head restraints can reduce the risk of whiplash injury in the event of impact from the rear. Adjust the restraints so that the upper edge is as high as practical. To raise, pull up on the head restraint. To lower, depress the button on the post guide and push down on the head restraint.



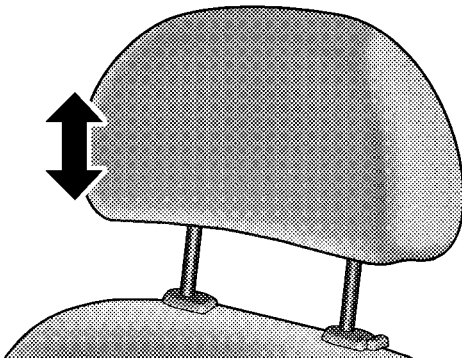

80928dbb

**Adjustable Head Restraint**

**Folding Rear Seat**

To provide additional storage area, the rear seatback can be folded forward. Pull on the loops shown in the picture to fold down either or both seatbacks.

When returning the rear seat back to the upright position be sure the seat back is latched.

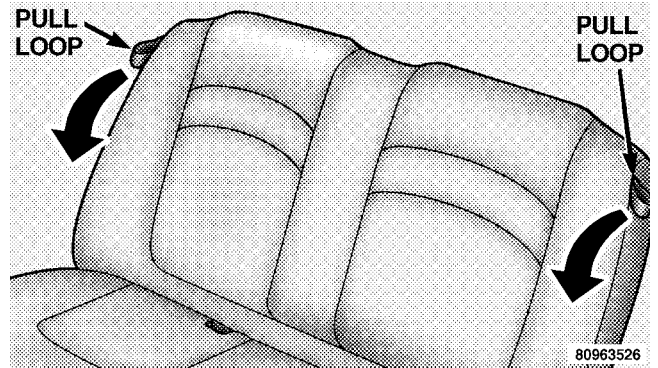

80963526

**Folding Rear Seats**

**WARNING!**

The cargo area in the rear of the vehicle (with the rear seatbacks in the locked-up or folded down position) should not be used as a play area by children when the vehicle is in motion. They could be seriously injured in an accident. Children should be seated and using the proper restraint system.

### TO OPEN AND CLOSE THE HOOD

To open the hood, two latches must be released. First pull the hood release lever located under the left side of the instrument panel.

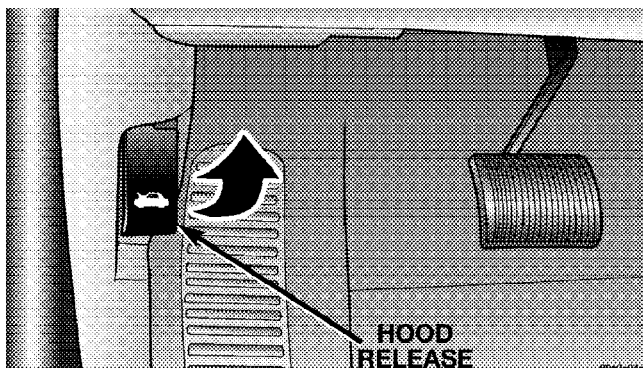

**Hood Release Lever**

Then lift the secondary latch located under the front edge of the hood, near the center and raise the hood.

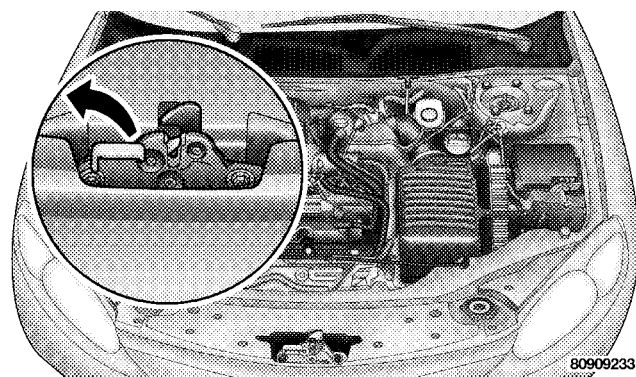

**Hood Safety Catch**

Use the hood prop rod to secure the hood in the open position. Place the upper end of the prop rod in the hole marked "prop" on the underside of the hood.

To prevent possible damage, do not slam the hood to close it. Use a firm downward push at the center of the hood to ensure that both latches engage.

**WARNING!**

If the hood is not fully latched it could fly up when the vehicle is moving and block your forward vision. You could have a collision. Be sure all hood latches are fully latched before driving.

**LIGHTS**

**Interior Lights**

The map/courtesy lights come on when a door is opened and the panel lamp dimmer switch (located on the turn signal control stalk) is in any detent except fully counter-clockwise (dome lamp ON position) or fully clockwise (dome lamp OFF position). Rotating the panel dimmer switch fully counter-clockwise will turn on the lights. Turn the panel dimmer switch fully clockwise to prevent the lights from coming on when a door is opened.

**NOTE:** The interior lights have a “fade to off” feature. When the lights are turned off, they gradually “fade” off.

**Dimmer Control**

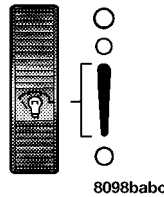

With the parking lights or headlights on, rotating the dimmer control for the interior lights on the Multi-Function Control Lever upward will increase the brightness of the instrument panel lights.

**Dome Light Position**

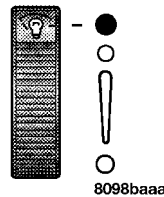

Rotate the dimmer control completely upward to the second detent to turn on the interior lights. The interior lights will remain on when the dimmer control is in this position.

**Interior Light Defeat (OFF)**

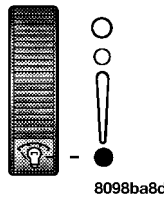

Rotate the dimmer control to the extreme bottom full-circle position. The interior lights will remain off when the doors are open.

**Daytime Mode (Daytime Brightness Feature)**

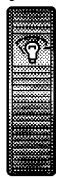

8098ba89

○ Rotate the dimmer control to the first detent (full-circle). This feature brightens the odometer and radio display when the parking lights or headlights are on during daylight conditions.

**Front Map/Reading Lights — If Equipped**

These lights are mounted between the sun visors. Each light has a push-on push-off switch.

**NOTE:** The lights will remain on until the switch is pressed a second time, so be sure that they have been turned off before leaving the vehicle.

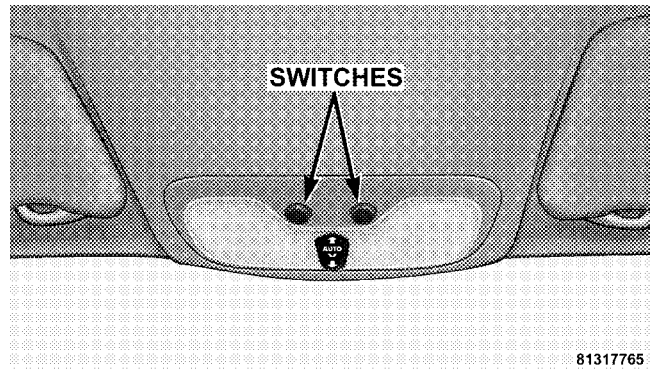

81317765

**Front Map/Reading Light Switches**

**Multi-Function Control Lever**

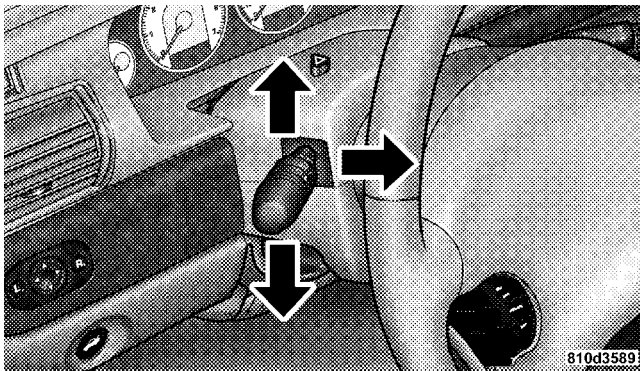

**Multi-Function Lever**

The Multi-Function lever controls the operation of the headlights, turn signals, headlight beam select switch, instrument panel light dimming, courtesy lights, passing lights, dome light and fog lights.

**Headlights, Parking Lights, Instrument Panel Lights**

Turn the end of the control lever to the first detent for parking light operation. Turn to the second detent for headlight operation.

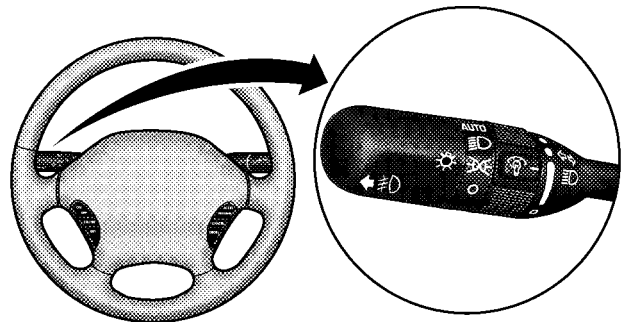

812a6c8f

**Multi-Function Lever**

To change the brightness of the instrument panel lights, turn the center portion of the lever up or down. Turning the dimmer control to the full up position also turns on the courtesy lights. Turning the dimmer control to the full down position prevents the courtesy lights from coming on when a door is opened.

**Automatic Headlights—If Equipped**

This system automatically turns your headlights on at a preset level of outdoor lighting. Turn the end of the control lever to the third detent to turn the system on. When the system is on, the headlight delay feature is also on. This means that your headlights will stay on for about 90 seconds after you turn the ignition switch off. To turn the Automatic system off, turn the control lever clockwise, to the off position.

**NOTE:** The engine must be running before the headlights will come on in the automatic mode.

**NOTE:** The Automatic Headlight System will turn on the headlights if it detects that the windshield wipers have been in operation for more than 10 seconds.

**Daytime Running Lights (Canada Only)**

The headlights come on at a low intensity level whenever the ignition switch is turned on. The lights remain on until the ignition switch is turned OFF or the parking brake is engaged. The headlight switch must be used for normal night time driving.

**Lights-on Reminder**

If the headlights or parking lights are on after the ignition is turned off, a chime will sound when the driver's door is opened.

**Fog Lights — If Equipped**

 The fog light switch is in the multi-function lever. To activate the fog lights, turn on the low beam headlights and pull out the end of the control lever. A light in the instrument cluster shows when the fog lights are on.

**NOTE:** The switch will turn on the fog lights only if the low beam headlights are on. Turning on the high beam headlights turns off the fog lights.

**Turn Signals**

Move the turn signal lever up or down and the arrows in the instrument cluster flash to show proper operation of the front and rear turn signal lights. You can signal a lane change by moving the lever partially up or down.

**Headlight Beam Select Switch**

Pull the turn signal lever towards you to switch the headlights to HIGH beam. Pull the turn signal lever a second time to switch the headlights to LOW beam.

**Flash to Pass**

You can signal another vehicle with your headlights by lightly pulling the turn signal lever toward the steering wheel. This will cause the headlights to turn on at high beam and remain on until the lever is released.

**Headlight Time Delay**

This feature provides the safety of headlight illumination for about 90 seconds when leaving your vehicle in an unlighted area.

To activate the delay, turn off the ignition while the headlights are still on. Then turn off the headlights. The delay interval begins when the ignition is turned off.

If the headlights are turned off before the ignition, they will turn off in the normal manner.

**WINDSHIELD WIPERS AND WASHERS**

The wipers and washers are operated by a switch in the right side control lever. Turn the end of the control lever to select the desired wiper speed.

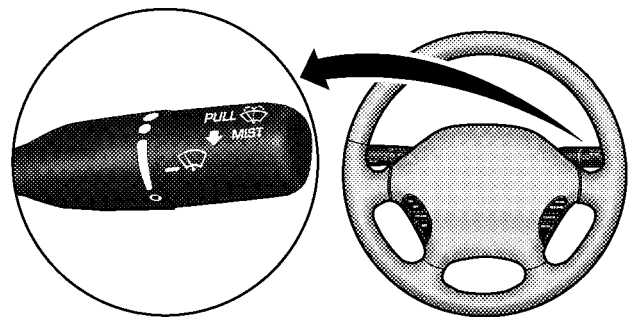

80925f8e

**Windshield Wiper/Washer Control**

**NOTE:** Always remove any build-up of snow that prevents the windshield wiper blades from returning to the OFF position. If the windshield wiper switch is turned OFF and the blades cannot return to the OFF position, damage to the wiper motor may occur.

To use the washer, pull the lever toward you and hold while spray is desired. If the lever is pulled while in the delay range, the wiper will operate for several cycles after the lever is released, and then resume the intermittent interval previously selected.

If the lever is pulled while in the OFF position, the wipers will operate for several cycles, then turn OFF.

**WARNING!**

Sudden loss of visibility through the windshield could lead to an accident. You might not see other vehicles or other obstacles. To avoid sudden icing of the windshield during freezing weather, warm the windshield with defroster before and during windshield washer use.

**Mist**

Use this feature when weather conditions make occasional usage of the wipers necessary. Pull down and release the control lever for a single wiping cycle.

**Speed Sensitive Intermittent Wiper System**

Use the intermittent wiper when weather conditions make a single wiping cycle, with a variable pause between cycles, desirable. Turn the lever to the delay position, then select the delay interval. The delay can be regulated from a maximum of approximately 18 seconds between cycles, to a cycle every 1/2 second.

**NOTE:** The wiper delay times depend on vehicle speed. If the vehicle is moving less than 16 km/h (10 mph), delay times will be doubled.

**TILT STEERING COLUMN**

To tilt the column, push down on the lever below the turn signal control and move the wheel up or down, as desired. Push the lever back up to lock the column firmly in place.



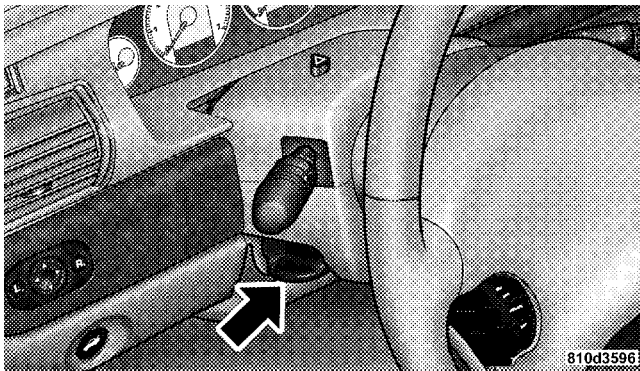

Tilt Steering Column Control

**WARNING!**

Tilting the steering column while the vehicle is moving is dangerous. Without a stable steering column, you could lose control of the vehicle and have an accident. Adjust the column only while the vehicle is stopped. Be sure it is locked before driving.

**TRACTION CONTROL— IF EQUIPPED**



To turn the Traction Control System Off, press the switch located on the top of the steering column, to the right of the hazard switch, until the Traction Control indicator in the instrument cluster lights up.

**3**

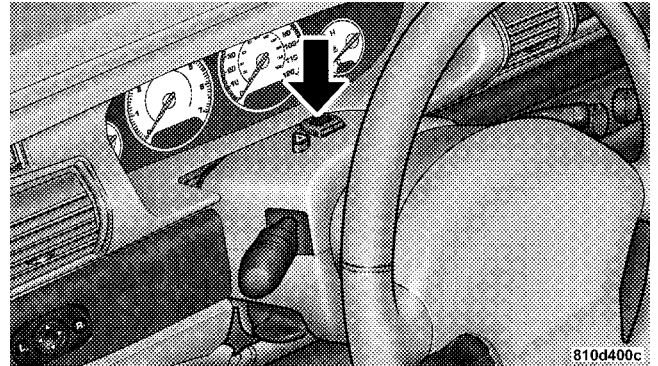

Traction Control Switch

To turn the Traction Control System On, press the switch until the Traction Control indicator in the instrument cluster turns off.

**NOTE:** The Traction Control System is enabled each time the ignition switch is turned On. This will occur even if you used the switch to turn the system off before powering down or turning the ignition to Lock.

#### **ELECTRONIC SPEED CONTROL— IF EQUIPPED**

When engaged, this device will control the throttle operation to maintain a constant vehicle speed between 30 mph (48 km/h) and 85 mph (137 km/h). The controls are on the steering wheel.

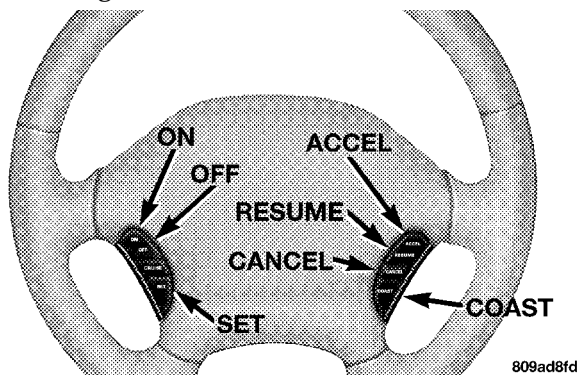

Speed Control Switches

#### **To Activate:**

Press the ON/OFF switch to turn the speed control system ON. To turn the system OFF, press the ON/OFF switch again. The system should be turned OFF when not in use. The CRUISE Indicator in the instrument cluster will light up when the Speed Control is ON.

**NOTE:** You must press the ON button to activate the system each time the engine is started.

#### **WARNING!**

Leaving the Electronic Speed Control system ON when not in use is dangerous. You could accidentally set the system or cause it to go faster than you want. You could lose control and have an accident. Always leave the system OFF when you aren't using it.

#### **To Set At A Desired Speed:**

When the vehicle has reached the desired speed and the system is ON, press and release the SET button. Release the accelerator and the vehicle will operate at the selected speed. The speed control is now Engaged.

**To Deactivate:**

A soft tap on the brake pedal, pushing the CANCEL button, or normal brake or clutch pressure will deactivate speed control without erasing the memory. Pushing the ON/OFF button or turning off the ignition turns the speed control system off and erases the memory.

**To Resume Speed:**

To resume a previously set speed, push and release the RESUME/ACCEL button. Resume can be used at any speed above 25 mph (40 km/h).

**To Vary The Speed Setting:**

When the speed control is Engaged (actively controlling to a SET speed), speed can be increased by pressing and holding the RESUME/ACCEL button. When the button is released, a new set speed will be established.

Tapping the RESUME/ACCEL button once will result in a 2 mph (3 km/h) increase in the SET speed. Each time the button is tapped, the SET speed increases. For example tapping the button three times will increase speed by 6 mph (10 km/h), etc.

To decrease speed while speed control is Engaged, press and hold the COAST button. Releasing the button when the desired speed is reached, will establish a new SET speed.

Tapping the COAST button once will result in a 1 mph (1.6 km/h) decrease in the SET speed. Each time the button is tapped, the SET speed decreases. For example, tapping the button three times will decrease speed by 3 mph (5 km/h).

**To Accelerate For Passing:**

**NOTE:** If the set speed is exceeded by 20 mph (32 km/h) or more during the acceleration, the set speed will have to manually re-engaged.

Depress the accelerator as you would normally. When the pedal is released, the vehicle will return to the SET speed.

**Using Speed Control On Hills**

Vehicles with automatic transmissions are equipped with Interactive Speed Control. This feature operates when travelling up or down hills with the Speed Control engaged and the driver's foot off of the accelerator.

**When Climbing A Hill**

If vehicle speed drops 3 mph (5 km/h) below the Speed Control set speed, the transaxle will downshift to third gear. Under severe conditions the transaxle may downshift again to second gear. The transaxle will upshift to fourth gear after the vehicle has reached the top of the hill.

**When Descending A Hill**

If vehicle speed rises 3 mph (5 km/h) over the Speed Control set speed, the transaxle will downshift to third gear. This provides engine braking to keep vehicle speed under control. The transaxle will not downshift below third gear to control vehicle overspeed. The transaxle will upshift to fourth gear after the vehicle has reached the bottom of the hill.

**NOTE:** On very steep hills, a greater speed loss or gain may occur. It may be preferable to drive without Speed Control.

**Rolling Hills**

The transaxle may downshift into third gear and remain there as the vehicle travels over rolling hills. The transaxle will upshift into fourth gear when the road flattens out.

The transaxle will resume its normal shift schedule if you depress the accelerator pedal during any of the above conditions.

**WARNING!**

**Speed Control can be dangerous where the system can't maintain a constant speed. Your vehicle could go too fast for the conditions, and you could lose control. An accident could be the result. Don't use Speed Control in heavy traffic or on roads that are winding, icy, snow-covered, or slippery.**

**GARAGE DOOR OPENER — IF EQUIPPED**

The HomeLink® Universal Transceiver replaces up to three remote controls (hand held transmitters) that operate devices such as garage door openers, motorized gates, or home lighting. It triggers these devices at the push of a button. The Universal Transceiver operates off your vehicle's battery and charging system; no batteries are needed.

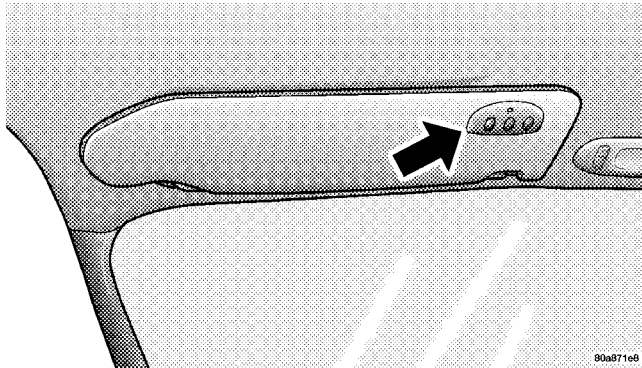

**Homelink Buttons**

For additional information on HomeLink®, call 1-800-355-3515, or on the internet at [www.homelink.com](http://www.homelink.com).

**WARNING!**

A moving garage door can cause injury to people and pets in the path of the door. People or pets could be seriously or fatally injured. Only use this transceiver with a garage door opener that has a "stop and reverse" feature as required by federal safety standards. This includes most garage door opener models manufactured after 1982. Do not use a garage door opener without these safety features it could cause injury or death. Call toll-free 1-800-355-3515 or, on the Internet at [www.homelink.com](http://www.homelink.com) for safety information or assistance.

**Programming The Universal Transceiver**

For best results, install a new battery in the hand held transmitter before programming. If your garage door opener (located in the garage) is equipped with an antenna, make sure that the antenna is hanging straight down.

1. Turn off the engine.

**WARNING!**

Vehicle exhaust contains carbon monoxide, a dangerous gas. Do not run the vehicle's exhaust while training the transceiver. Exhaust gas can cause serious injury or death.

**WARNING!**

Your motorized door or gate will open and close while you are training the Universal Transceiver. Do not train the transceiver if people or pets are in the path of the door or gate. A moving door or gate can cause serious injury or death to people and pets or damage to objects.

2. Erase the factory test codes by pressing the two outside buttons. Release the buttons when the light in the Universal Transceiver begins to flash (about 20 seconds).

**NOTE:** Step 2 does not have to be followed to program additional hand held transmitters.

3. Choose one of the three Universal Transceiver buttons to program. Place the hand held controller one to three inches from the Universal Transceiver while keeping its indicator light in view.

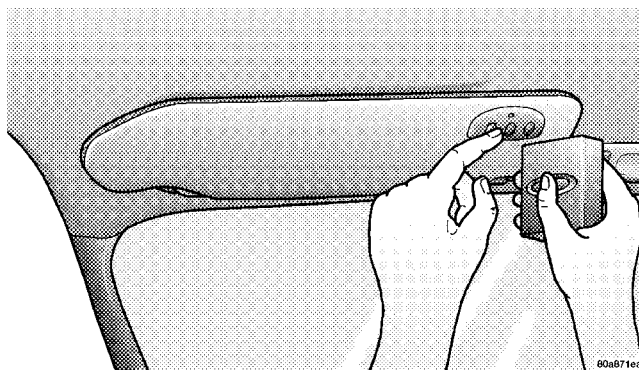
**Programming Universal Transceiver**

4. Using both hands, press the hand held transmitter button and the desired Universal Transceiver button. Do not release the buttons until step 5 has been completed.

**NOTE:** Some entry gates and garage door openers may require you to replace step 4 with the procedures listed under Canadian Programming.

5. The indicator light in the Universal Transceiver will begin to flash, first slowly and then rapidly. The rapid flashing indicates successful programming. If after 90 seconds the indicator light does not flash rapidly or goes out, return to step 1 and repeat the procedure. To train the other buttons, repeat steps 3 and 4. Be sure to keep your hand held transmitters in case you need to retrain the Universal Transceiver.

**NOTE:** If you do not successfully program the Universal Transceiver to learn the signal of your hand held transmitter, refer to the Rolling Code Paragraph, or call toll free for customer assistance at 1-800-355-3515, or on the internet at [www.homelink.com](http://www.homelink.com).

### **“Rolling Code” Programming**

**NOTE:** If your hand held transmitter appears to program the Universal Transceiver, but your garage door or other device does not operate, and your device was manufactured after 1996, your garage door opener or other device may have a “Rolling Code” system.

On garage door openers with the “Rolling Code” feature, the transmitter code changes after each use to prevent the copying of your code.

To check if your device is protected by a “Rolling Code” system:

- Check the owner’s manual for the device for mention of “Rolling Codes”.
- Press and hold the programmed button on the Universal Transceiver. If the Universal Transceiver indicator light flashes rapidly and then stays on after 2 seconds, the device has the “Rolling Code” feature.

To train a garage door opener (or other rolling code equipped devices) with the rolling code feature, follow these instructions **after** completing the **Programming** portion of this text:

**NOTE:** The assistance of a second person may make the following programming procedure quicker and easier.

1. Locate the training button on the garage door motor head unit. The exact location and color of the button may vary by garage door opener manufacturer. If you have difficulty in locating the training button, check your garage door opener manual, or call 1-800-355-3515 or, on the Internet, at [www.homelink.com](http://www.homelink.com).

2. Press and hold the training button on the garage door opener head unit. This will activate the "training" light.

**NOTE:** After completing step 2, you have 30 seconds to start step 3.

3. Return to the Universal Transceiver in the vehicle and firmly press and release the garage door button. Press and release the button a second time to complete the training process. Some garage door openers may require you to do this procedure a third time to complete the training.

Your garage door opener should now recognize your Universal Transceiver. The remaining two buttons may now be programmed if this has not previously been done. Refer to the Programming instructions. You may use either your Universal Transceiver or your original hand-held transmitter to open your garage door.

#### **Canadian Programming/Gate Programming**

Canadian frequency laws, and the technology of some entry gates, require you to press and release the hand held transmitter button every two seconds during programming

Continue to press and hold the Universal Transceiver button while you press and release the hand held transmitter button until the frequency signal has been learned. The Universal Transceiver light will flash slowly and then rapidly when the programming is successful.

**NOTE:** When programming such a garage door opener or gate, unplug the device to prevent possible damage to the garage door or gate motor.



### Operation

Press and hold the desired button on the Universal Transceiver until the garage door or other device begins to operate. The light in the display shows that the signal is being transmitted. The hand held transmitter may also be used at any time.

### Reprogramming A Single Button

1. Press and hold the Universal Transceiver button to be reprogrammed. Do not release until step 4 has been completed.
2. When the indicator light begins to flash slowly (after 20 seconds) position the hand held transmitter one to three inches away from the button to be trained.
3. Press and hold the hand held transmitter button.
4. The Universal Transceiver indicator light will begin to flash, first slowly, then rapidly. When the indicator lights begin to flash rapidly, release both buttons.

### Security

If you sell your vehicle, be sure to erase the frequencies.

To erase all of the previously trained frequencies, hold down both outside buttons until the green light begins to flash.

This device complies with part 15 of FCC rules and with RS-210 of Industry Canada. Operation is subject to the following conditions:

1. This device may not cause harmful interference.
2. This device must accept any interference that may be received including interference that may cause undesired operation.

**NOTE:** Changes or modifications not expressly approved by the party responsible for compliance could void the user's authority to operate the equipment.

HomeLink® is a trademark owned by Johnson Controls, Inc.

### POWER SUNROOF — IF EQUIPPED

The sunroof controls are mounted between the sun visors on the overhead console.

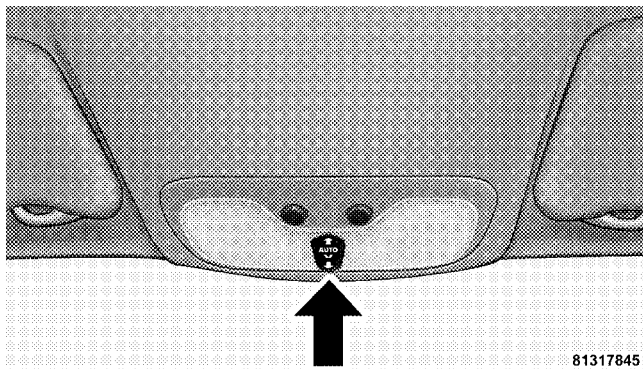

Power Sunroof Controls

### WARNING!

- Never leave children in a vehicle, with the keys in the ignition switch. Occupants, particularly unattended children, can become entrapped by the power sunroof while operating the power sunroof switch. Such entrapment may result in serious injury or death.
- In an accident, there is greater risk of being thrown from a vehicle with an open sunroof. You could also be seriously injured or killed. Always fasten your seat belt properly and make sure all passengers are properly secured too.
- Do not allow small children to operate the sunroof. Never allow fingers or other body parts, or any object to project through the sunroof opening. Injury may result.

**Opening Sunroof - Manual**

Press the switch rearward and hold, and the sunroof will open automatically from any position. The sunroof will open fully, then stop automatically. During this operation, any release of the sunroof switch will stop the sunroof.

**Opening Sunroof - Express**

Press the switch rearward and release, and the sunroof will open automatically from any position. The sunroof will open fully, then stop automatically. This is called Express Open. During Express Open operation, any movement of the sunroof switch will stop the sunroof.

**Closing Sunroof - Manual**

To Close the sunroof from an open or vent position, press and hold the switch forward. The sunroof will close fully and stop automatically. Release the switch to stop sunroof travel at any point.

**Venting Sunroof - Express**

Press and release the "V" button, and the sunroof will open to the vent position. This is called Express Vent.

**Sunshade Operation**

The sunshade can be opened manually. However, the sunshade will open automatically as the sunroof opens.

**NOTE:** The sunshade cannot be closed if the sunroof is open.

**Wind Buffeting**

Wind buffeting can be described as the perception of pressure on the ears or a helicopter type sound in the ears. Your vehicle may exhibit wind buffeting with the windows down, or the sunroof (if so equipped) in certain open or partially open positions. This is a normal occurrence and can be minimized. If the buffeting occurs with the rear windows open, open the front and rear windows together to minimize the buffeting. If the buffeting occurs with the sunroof open, adjust the sunroof opening to minimize the buffeting.

**Sunroof Maintenance**

Use only a non abrasive cleaner and a soft cloth to clean the glass panel.

**Sunroof Fully Closed**

Press and hold the switch forward until the sunroof stops completely to ensure that the sunroof is fully closed.

**ELECTRICAL POWER OUTLET**

The power outlet is located in the lower center of your instrument panel. If your vehicle is equipped with heated seats, a second power outlet is located inside the center console. All accessories connected to any outlet should be removed or turned off when the vehicle is not in use.

**CAUTION!****Electrical Outlet Use With Engine Off**

- Many accessories that can be plugged in draw power from the vehicle's battery, even when not in use (i.e., cellular phones, etc.). Eventually, if plugged in long enough, the vehicle's battery will discharge sufficiently to degrade battery life and/or prevent engine starting.
- Accessories that draw higher power (i.e., coolers, vacuum cleaners, lights, etc.) will degrade the battery even more quickly. Only use these intermittently and with greater caution.
- After the use of high power draw accessories, or long periods of the vehicle not being started (with accessories still plugged in), the vehicle must be driven a sufficient length of time to allow the alternator to recharge the vehicle's battery.
- Power outlets are designed for accessory plugs only. Do not hang any type of accessory or accessory bracket from the plug. Improper use of the power outlet can cause damage.

---

# UNDERSTANDING YOUR INSTRUMENT PANEL

## CONTENTS

---

■ Instruments And Controls . . . . .	.81	■ Radio General Information . . . . .	.93
■ Instrument Cluster . . . . .	.82	□ Radio Broadcast Signals . . . . .	.93
■ Instrument Cluster Description . . . . .	.83	□ Two Types Of Signals . . . . .	.93
■ Compass, Temperature, And Trip Computer Display — If Equipped . . . . .	.89	□ Electrical Disturbances . . . . .	.93
□ Control Buttons . . . . .	.89	□ AM Reception . . . . .	.93
□ Trip Conditions . . . . .	.90	□ FM Reception . . . . .	.93
□ Compass Temperature Display . . . . .	.90	■ Sales Code RAZ—AM/ FM Stereo Radio With Cassette Tape Player, CD Player And CD Changer Controls . . . . .	.94
■ Cigar Lighter/Ashtray . . . . .	.92	□ Operating Instructions — Radio . . . . .	.94
■ Electronic Digital Clock . . . . .	.92	□ Power Switch, Volume Control . . . . .	.94
□ To Set The Clock . . . . .	.93	□ Seek Button (Radio Mode) . . . . .	.94

## 78 UNDERSTANDING YOUR INSTRUMENT PANEL

□ Tuning . . . . .	.94	□ Changing Tape Direction . . . . .	.98
□ Radio Data System (RDS) . . . . .	.95	□ Metal Tape Selection . . . . .	.98
□ PTY (Program Type) Button . . . . .	.95	□ Pinch Roller Release . . . . .	.98
□ Balance . . . . .	.96	□ Noise Reduction . . . . .	.99
□ Fade . . . . .	.96	□ Operating Instructions — CD Player . . . . .	.99
□ Tone Control . . . . .	.96	□ Inserting The Compact Disc . . . . .	.99
□ AM/FM Selection . . . . .	.97	□ Seek Button . . . . .	100
□ Scan Button . . . . .	.97	□ EJT CD (Eject) Button . . . . .	100
□ To Set The Radio Push-Button Memory . . . . .	.97	□ FF/Tune/RW . . . . .	100
□ To Change From Clock To Radio Mode . . . . .	.97	□ Program Button 4 (Random Play) . . . . .	100
□ Operating Instructions — Tape Player . . . . .	.97	□ Mode . . . . .	100
□ Seek Button . . . . .	.98	□ Tape CD Button . . . . .	101
□ Fast Forward (FF) . . . . .	.98	□ Time Button . . . . .	101
□ Rewind (RW) . . . . .	.98	□ Scan Button . . . . .	101
□ Tape Eject . . . . .	.98	□ CD Changer Control Capability — If Equipped . . . . .	101
□ Scan Button . . . . .	.98		

<ul style="list-style-type: none"> <li>■ Sales Code RBB—AM/FM Stereo Radio With Cassette Tape Player And CD Changer Capability . . . . . 103                     <ul style="list-style-type: none"> <li>□ Radio Operation . . . . . 103</li> <li>□ Mode Button . . . . . 105</li> <li>□ Scan Button (Radio Mode) . . . . . 105</li> <li>□ Cassette Player Features . . . . . 105</li> <li>□ CD Changer Control Capability — If Equipped . . . . . 106</li> </ul> </li> <li>■ Sales Code RBK—AM/ FM Stereo Radio With CD Player And CD Changer Controls . . . 108                     <ul style="list-style-type: none"> <li>□ Radio Operation . . . . . 108</li> <li>□ CD Player Operation . . . . . 110</li> <li>□ CD Changer Control Capability — If Equipped . . . . . 111</li> </ul> </li> <li>■ 6 Disc CD Changer — If Equipped . . . . . 113                     <ul style="list-style-type: none"> <li>□ Loading The CD Changer . . . . . 113</li> </ul> </li> </ul>	<ul style="list-style-type: none"> <li>□ Playing Discs . . . . . 114</li> <li>□ Seek Button . . . . . 114</li> <li>□ FF/Tune/RW . . . . . 114</li> <li>□ Mode Button . . . . . 114</li> <li>□ Program Button 1 . . . . . 114</li> <li>□ Program Button 4 (Random Play) . . . . . 114</li> <li>□ Program Button 5 . . . . . 115</li> <li>□ Time Button . . . . . 115</li> <li>□ Changing Modes . . . . . 115</li> <li>□ Removing Discs From The CD Changer . . . . . 115</li> <li>□ CD Changer Operation With The Changer Off . . . . . 115</li> <li>■ Satellite Radio — If Equipped . . . . . 115                     <ul style="list-style-type: none"> <li>□ System Activation . . . . . 116</li> <li>□ Electronic Serial Number/Sirius Identification Number (ENS/SID) . . . . . 116</li> </ul> </li> </ul>
---	--

## 80 UNDERSTANDING YOUR INSTRUMENT PANEL

- Selecting Satellite Mode In RBB, RAH And RBK Radios . . . . . 116
- Selecting Satellite Mode In RBP, RBU, RAZ, RB1 And RBQ Radios . . . . . 117
- Selecting a Channel . . . . . 117
- Storing And Selecting Pre-Set Channels . . . . . 117
- Using The PTY (Program Type) Button (If Equipped) . . . . . 118
- PTY Button "Scan" . . . . . 118
- PTY Button "Seek" . . . . . 118
- Satellite Antenna . . . . . 118
- Reception Quality . . . . . 118
- Remote Sound System Controls — If Equipped . . . . . 119
- Radio Operation . . . . . 119
- Tape Player . . . . . 119
- CD Player — Single Disc In Radio . . . . . 120
- CD Player — 6 Disc CD Changer . . . . . 120
- Cassette Tape And Player Maintenance . . . . . 120
- Compact Disc Maintenance . . . . . 121
- Radio Operation And Cellular Phones . . . . . 122
- Climate Controls . . . . . 122
- Automatic Temperature Control (ATC) — If Equipped . . . . . 122
- Manual Air Conditioning/Heater Control — If Equipped . . . . . 129



**INSTRUMENTS AND CONTROLS**

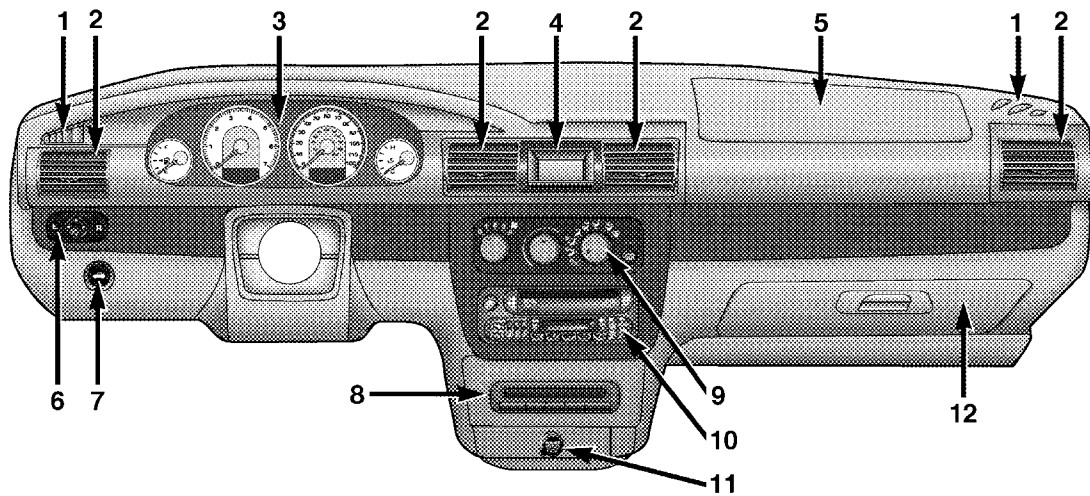

- |                                     |  |                    |
|-------------------------------------|--|--------------------|
| 1. Side Window Demist Outlet        | 5. Passenger Airbag                      | 9. Climate Control |
| 2. Air Outlet                       | 6. Electric Remote-Control Mirror Switch | 10. Radio          |
| 3. Instrument Cluster               | 7. Remote Trunk Release Button           | 11. Power Source   |
| 4. Storage Tray or Travel Computer* | 8. Storage Tray or CD Changer*           | 12. Storage Bin    |
|                                     |  | *Optional          |

810d35bc

**INSTRUMENT CLUSTER**

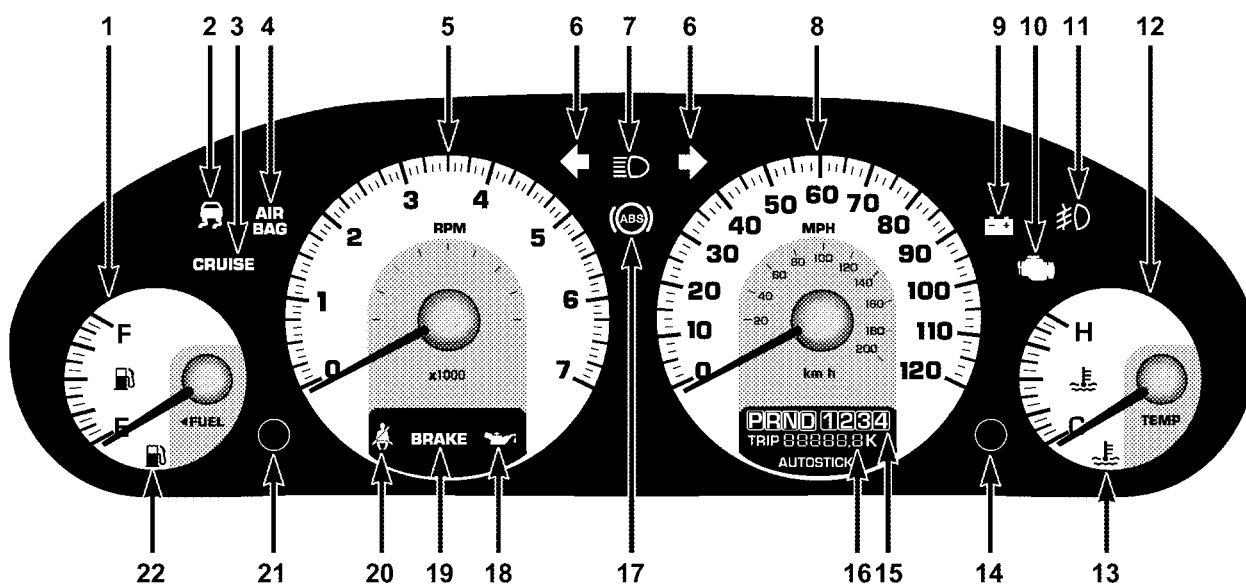

810a1f5b

**INSTRUMENT CLUSTER DESCRIPTION****1. Fuel Gauge**

When the ignition key is in the ON position, the pointer will show the level of fuel remaining in the fuel tank.

**2. Traction Control — If Equipped**

This display indicator illuminates momentarily as a bulb check when the ignition switch is first turned ON. The indicator will blink during an active traction event, but will remain solid when the system is deactivated or if a system malfunction occurs.

The Traction Control indicator will turn ON if:

- The Traction Control system is in use.
- The Traction Control switch has been used to turn the system OFF.

- There is an Anti-Lock Brake system malfunction or Traction Control system malfunction.
- The system has been deactivated to prevent damage to the brake system due to overheated brake temperatures.

**NOTE:** Extended heavy use of Traction Control may cause the system to deactivate and turn on the Traction Control indicator. This is to prevent overheating of the brake system and is a normal condition. The system will remain disabled for about 4 minutes until the brakes have cooled. The system will automatically reactivate and turn off the Traction Control indicator.

**3. Cruise Light — If Equipped**

This light shows that the Speed Control System is ON. This light will also illuminate for a 5-second bulb check when the ignition switch is first turned to the ON position. (See page 66 for more information.)

**4. Airbag Light**

**AIR BAG** The light comes on and remains on for 6 to 8 seconds as a bulb check when the ignition switch is first turned ON. If the bulb does not come on during starting, have the bulb replaced. If the light stays on, or comes on while driving, have the system checked by an authorized dealer. (See page 36 for more information.)

**5. Tachometer**

The red area of the scale shows the maximum permissible engine revolutions-per-minute (rpm x 1000) for each gear range. Before reaching the red area (over 6,500 rpm), ease up on the accelerator to prevent engine over speed.

**6. Turn Signal Indicators**

The arrows will flash in unison with the exterior turn signal, when using the turn signal lever.

**7. High Beam Indicator**

 This light shows that the headlights are on high beam. Pull the turn signal lever toward the steering wheel to switch the headlights from high or low beam.

**8. Speedometer**

Shows the vehicle speed in miles-per-hour and kilometers-per-hour.

**9. Charging System Light**

 This light shows the status of the electrical charging system. The light should come on briefly when the ignition is first turned on and remain on briefly as a bulb check. If the light stays on or comes on while driving, turn off some of the vehicle's electrical devices, such as the Fog Lights or Rear Defroster. If the Charging System Light remains on, it means that the vehicle is experiencing a problem with the charging system. Obtain SERVICE IMMEDIATELY. See your local authorized dealer.

**10. Malfunction Indicator Light**

 This light is part of an onboard diagnostic system called OBD that monitors engine and automatic transmission control systems. The light will illuminate as long as the key is in the ON position, prior to engine start up. Approximately 15 seconds later the MIL may blink for 10 seconds then

resume to full illumination. (See “EMISSIONS INSPECTION AND MAINTENANCE PROGRAMS” in the “MAINTAINING YOUR VEHICLE” section of your Owner Manual for more details). If the bulb does not come on when turning the key from OFF to ON, have the condition checked promptly.

Certain conditions such as a loose or missing gas cap or poor fuel quality may illuminate the light after engine start. The vehicle should be serviced if the light stays on through several of your typical driving cycles. In most situations the vehicle will drive normally and will not require towing.

The Malfunction Indicator Light flashes to alert to serious conditions that could lead to immediate loss of power or severe catalytic converter damage. The vehicle should be serviced as soon as possible if this occurs. (See page 207 for more information.)

#### 11. Fog Light Indicator — If Equipped

 This light shows when the fog lights are ON. (See page 62 for more information.)

#### 12. Temperature Gauge



The temperature gauge shows engine coolant temperature. Any reading within the normal range (approximately mid point on the scale) shows that the cooling system is operating properly. The gauge pointer may show a higher than normal temperature when driving in hot weather, up mountain grades, in heavy stop and go traffic, or when towing a trailer.

If the pointer rises to the “H” mark, stop the vehicle and turn off the engine until the problem is corrected.

There are steps that you can take to slow down an impending overheat condition. If your air conditioning is on, turn it off. The air conditioning system adds heat to the cooling system and turning off the A/C removes this heat. You can also turn the Temperature control to maximum heat, the Mode control to Floor and the Fan control to High. This allows the heater core to act as a supplement to the radiator and aids in removing heat from the cooling system.

### 13. Engine Temperature Warning Light



This light warns of an overheated engine coolant condition.

### 14. Trip Odometer Button

Press and release this button to change the display from odometer to trip odometer. The word TRIP will appear when in the trip odometer mode. To reset the trip odometer, press and hold the button for at least 1/2 second.

### 15. Transmission Range Indicator

This indicator illuminates to show the automatic transmission gear selection.

An optional *AutoStick Gear Indicator* displays the current transaxle gear when in AutoStick mode.

### 16. Odometer/Trip Odometer

The odometer shows the total distance the vehicle has been driven.

U.S. federal regulations require that upon transfer of vehicle ownership, the seller certify to the purchaser the correct mileage that the vehicle has been driven. Therefore, if the odometer reading is changed, during repair or replacement, be sure to keep a record of the reading before and after the service so that the correct mileage can be determined.

The trip odometer shows individual trip mileage. To switch from odometer to trip odometer, press and release the Trip Odometer button. Press and release the Trip button a second time to return to the odometer. While in trip mode, press and hold the button for at least 1/2 second to reset the trip odometer.

### Door, Deck or Trunk Ajar Warnings

If you move the vehicle and a door is not completely closed, the word DOOR will replace the odometer display and a chime will sound once. The odometer display will reappear when the door is closed. If the trunk is not completely closed, the word DECK will replace the odometer display. The odometer display will reappear when the trunk is closed.

**17. Anti-Lock Warning Light — If Equipped**

 This light monitors the Anti-Lock Brake System described elsewhere in this manual. This light will come on when the ignition key is turned to the RUN position and may stay on for several seconds. If the light does not come on, have the system checked by an authorized dealer. The warning light should be checked frequently to assure that it is operating properly.

If the ABS light remains on or comes on during driving, it indicates that the Anti-Lock portion of the brake system is not functioning and that service is required, however, the conventional brake system will continue to operate normally provided that the BRAKE warning light is not on.

**18. Oil Pressure Light**

 Shows low engine oil pressure. The light will come on and remain on briefly when the ignition is turned on as a bulb check. If the bulb does not come on during starting, have the bulb repaired promptly.

If the light comes on and remains on while driving, stop the vehicle and shut off the engine. Do not operate the vehicle until the cause is corrected.

The light does not show the quantity of oil in the engine. This can be determined using the procedure shown in Section 7. (See page 210 for more information.)

**19. Brake System Warning Light**

This light monitors both the brake fluid level and the parking brake. If the light comes on, it indicates either that the parking brake is on or there is a low fluid level in the brake master cylinder. On vehicles equipped with Anti-lock brakes (ABS), the brake light may also indicate reduced braking performance.

If the parking brake is off and the light remains on, have the brake system inspected as soon as possible.

**WARNING!**

Driving a vehicle with the brake light on is dangerous. A significant decrease in braking performance may occur. It will take you longer to stop the vehicle. You could have an accident. Have the vehicle checked immediately.

The warning light should be checked frequently to assure that it is operating properly. Turn the ignition key to the RUN position. (Refer to "A Word About Your Keys, Ignition Key Removal" in this manual for an illustration of the ignition positions.) The light should come on. If the light does not come on, have the system checked by an authorized dealer.

The light will also come on when the parking brake is applied with the ignition in the RUN position.

**NOTE:** This light shows only that the parking brake is on. It does not show the degree of brake application.

In an ABS equipped vehicle, the Brake System Warning light will come on if the ABS light is not functioning or if the ABS system is not communicating.

**20. Seat Belt Reminder Light**

When the ignition switch is first turned ON, this light will turn on for 5 to 8 seconds as a bulb check. During the bulb check, if the driver's seat belt is unbuckled, a chime will sound. After the bulb check or when driving, if the driver seat belt remains unbuckled, the Seat Belt Warning Light will flash or remain on continuously. Refer to "Enhanced Driver Seat Belt Reminder System (BeltAlert™)" in the Occupant Restraints section for more information.

**21. Theft Alarm Light — If Equipped**

The light in the instrument cluster will flash rapidly for 15 seconds. This shows that the system is arming. If the light comes on but does not flash, the system is still armed, but there is a problem in the trunk circuit. After 15 seconds the light will continue to flash slowly. This shows that the system is fully armed.

**22. Low Fuel Light**

When the fuel level drops to about 2 ½ gallons (9 ½ liters), the fuel symbol will light and remain lit until fuel is added.



### COMPASS, TEMPERATURE, AND TRIP COMPUTER DISPLAY — IF EQUIPPED

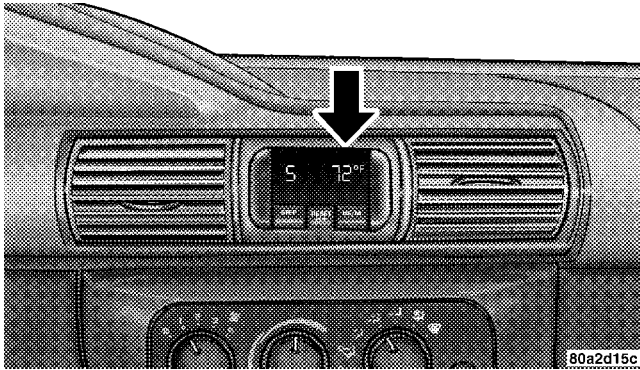

Trip Computer Display

This feature allows you to choose between a compass / temperature display and one of five trip conditions being monitored.

#### Control Buttons

##### Step Button

Use this button to choose or cycle through the five trip conditions.

##### Reset

The following trip conditions can be reset:

- AVG ECO (changes to present fuel economy)
- ODO
- ET

To reset only the trip condition currently displayed, press and release the STEP and US/M buttons simultaneously until a chime sounds. To reset all trip conditions, hold down the STEP and US/M buttons simultaneously (about 2 seconds) until a second chime sounds and then release the buttons.

**NOTE:** The screen must display one of the trip conditions above in order to reset either (or all) of these conditions.

##### US / M Button

Use this button to change the display from U.S. to metric measurement units.

### Trip Conditions

#### Average Fuel Economy (AVG ECO)

This display shows the average fuel economy since the last reset.

#### Estimated Range (DTE)

This display shows the estimated distance that can be traveled with the fuel remaining in the tank. This estimated distance is based on the most recent trip information: (Average Fuel Economy) x (Fuel Remaining)

This display cannot be reset.

#### Present Fuel Economy (ECO)

This display shows fuel economy for the last few seconds.

This display cannot be reset.

#### Trip Odometer (ODO)

This display shows the distance traveled since the last reset.

#### Elapsed Time (ET)

This display shows the accumulated ignition ON time since the last reset.

### Compass Temperature Display

This display provides the outside temperature and one of eight compass readings to indicate the direction the vehicle is facing.

#### WARNING!

Even if the display still reads a few degrees above 32°F ( 0°C), the road surface may be icy, particularly in woods or on bridges. Drive carefully under such conditions to prevent an accident and possible personal injury or property damage.

### Compass Calibration

The Automatic Compass Calibration feature eliminates the need for the operator intervention under normal conditions. If the CAL indicator is lit, the compass needs to be calibrated. A good calibration requires a level surface and an environment free of large metal objects such as large buildings, bridges, underground cables, railroad tracks, etc.

### Automatic Compass Calibration

The self-calibrating feature of the compass eliminates the need to calibrate the compass for normal conditions. During a short initial period, the compass may appear erratic and the CAL symbol will appear on the display. After the vehicle has completed at least one complete circle in an area free from large metal objects, calibration will be complete when the CAL symbol is extinguished.

After initial calibration, the compass will continue to automatically update this calibration whenever the vehicle is in motion.

### Manual Compass Calibration

Compass calibration can also be requested. To manually calibrate the compass, use the STEP button to step to the compass/ temperature display and then hold down both the STEP and US/M buttons simultaneously until the CAL symbol is displayed. Release the buttons once the CAL symbol appears. Manual compass calibration has been initiated at this point. Drive the vehicle in circles in an area free from large metal objects until the CAL symbol is extinguished.

When the CAL indicator goes off, the compass is calibrated and should display correct headings. Verify proper calibration by checking North (N), South (S), East (E), and West (W). If the compass does not appear accurate, repeat the calibration procedure in another area.

### Compass Variance

Variance is the difference between magnetic North and geographic North. For proper compass function, the correct variance zone must be set.

### Setting the Compass Variance

Refer to the variance map for the correct compass variance zone. To check the variance zone, the ignition must be on and the compass / temperature displayed. Hold down both the US / M and STEP buttons simultaneously until the VAR symbol is lit and then immediately release both buttons. The current variance zone will now be displayed. To change the zone, press the STEP button until the correct zone is displayed. Wait for about 5 seconds. The trip computer will store this variance in memory and the compass will resume normal operation.

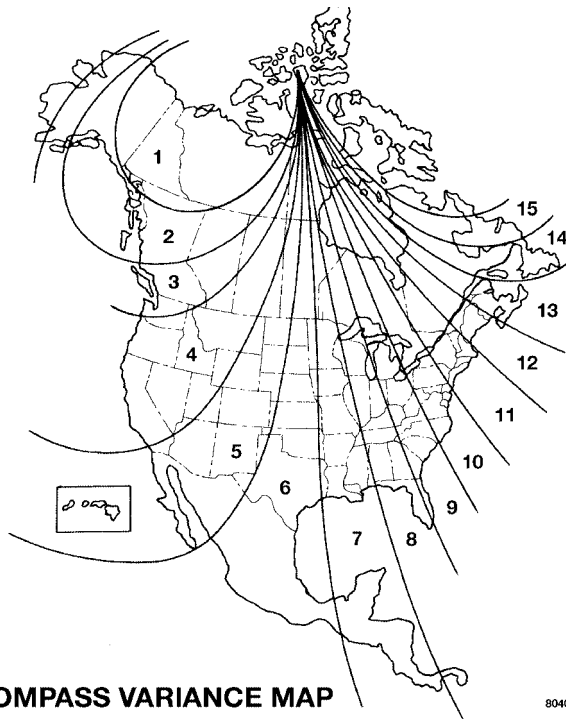

COMPASS VARIANCE MAP

8040b/197

### Outside Temperature

If the outside temperature is more than 131°F (55°C), the display will show 131°F. When the outside temperature is less than -40°F (-40°C), the display will show -40°F/C.

### CIGAR LIGHTER/ASHTRAY

For a nominal charge your dealer can provide a “smoker’s” package. This package consists of a cigar lighter and an ashtray that utilizes one of the cup holders.

### ELECTRONIC DIGITAL CLOCK

The clock and radio each use the display panel built into the radio. A digital readout indicates the time in hours and minutes whenever the ignition switch is in the ON or ACC position. Whenever the radio is turned on, it first comes up on either tape, cd or radio, whichever was previously on, and will revert back to Time/Clock after a few seconds. If Time/Clock was not previously selected, the display will revert back to whichever was previously on after a few seconds, whether it was tape, cd or radio.

When the ignition switch is in the OFF position, pressing the Time button will cause the radio to display time for several seconds, then turn off.

**To Set The Clock:**

1. Use a ballpoint pen or similar object to press the hour (H) or minute (M) buttons on the radio, The time setting will increase each time you press the button.
2. Press any other button to exit from the clock setting mode. Or, it will exit the mode automatically if left alone for 5 or 6 seconds.

**RADIO GENERAL INFORMATION****Radio Broadcast Signals**

Your new radio will provide excellent reception under most operating conditions. Like any system, however, car radios have performance limitations, due to mobile operation and natural phenomena, which might lead you to believe your sound system is malfunctioning. To help you understand and save you concern about these “apparent” malfunctions, you must understand a point or two about the transmission and reception of radio signals.

**Two Types of Signals**

There are two basic types of radio signals... AM or Amplitude Modulation, in which the transmitted sound causes the amplitude, or height, of the radio waves to vary... and FM or Frequency Modulation, in which the frequency of the wave is varied to carry the sound.

**Electrical Disturbances**

Radio waves may pick up electrical disturbances during transmission. They mainly affect the wave amplitude, and thus remain a part of the AM reception. They interfere very little with the frequency variations that carry the FM signal.

**AM Reception**

AM sound is based on wave amplitude, so AM reception can be disrupted by such things as lightning, power lines and neon signs.

**FM Reception**

Because FM transmission is based on frequency variations, interference that consists of amplitude variations can be filtered out, leaving the reception relatively clear, which is the major feature of FM radio.

### SALES CODE RAZ—AM/ FM STEREO RADIO WITH CASSETTE TAPE PLAYER, CD PLAYER AND CD CHANGER CONTROLS

**NOTE:** The radio sales code is located on the lower left side of your radio faceplate.

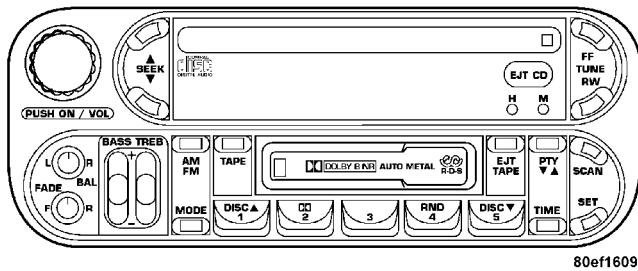

RAZ Radio

#### Operating Instructions — Radio

**NOTE:** Power to operate the radio is controlled by the ignition switch. It must be in the ON or ACC position to operate the radio.

#### Power Switch, Volume Control

Press the ON/VOL control to turn the radio on. Turn the volume control clockwise to increase the volume. The volume will be displayed and continuously updated while the button is pressed.

#### Seek Button (Radio Mode)

Press and release the Seek button to search for the next station in either the AM or FM mode. Press the top of the button to seek up and the bottom to seek down. Holding the button will by pass stations until you release the button.

#### Tuning

Press the TUNE control up or down to increase or decrease the frequency. If you press and hold the button, the radio will continue to tune until you release the button. The frequency will be displayed and continuously updated while the button is pressed.

**Radio Data System (RDS)**

The Radio Data System allows radio broadcasting stations to send data signals on a subcarrier frequency which is added to the stereo signal. RDS was developed to give FM receivers user-friendly features, such as Program Service name (PS) and Program Type (PTY). Program Service name is typically used by the broadcaster to display the station's name or call letters, for example "WNIC". Typically these are 8 characters in length and are displayed by the radio for those stations which are broadcasting this information. PTY (Program Type) is used to characterize the station's program material, for example "Rock Music".

**PTY (Program Type) Button**

Pressing this button once will turn on the PTY mode for 5 seconds. If no action is taken during the 5 second time out the PTY icon will turn off. Pressing the PTY button within 5 seconds will allow the program format type to be selected. Many radio stations do not currently broadcast PTY information.

Toggle the PTY button to select the following format types:

Program Type	Radio Display
Adult Hits	Adlt Hit
Classical	Classicl
Classic Rock	Cls Rock
College	College
Country	Country
Information	Inform
Jazz	Jazz
Foreign Language	Language
News	News
Nostalgia	Nostalga
Oldies	Oldies
Personality	Persnlty
Public	Public
Rhythm and Blues	R & B
Religious Music	Rel Musc
Religious Talk	Rel Talk
Rock	Rock

Program Type	Radio Display
Soft	Soft
Soft Rock	Soft Rck
Soft Rhythm and Blues	Soft R&B
Sports	Sports
Talk	Talk
Top 40	Top 40
Weather	Weather

By pressing the SEEK button when the PTY icon is displayed, the radio will be tuned to the next frequency station with the same selected PTY name. The PTY function only operates when in the FM mode.

The radio display will flash "SEEK" and the selected PTY program type when searching for the next PTY station. If no station is found with the selected PTY program type, the radio will return to the last preset station.

If a preset button is activated while in the PTY (Program Type) mode, the PTY mode will be exited and the radio will tune to the preset station.

Pressing PTY, then SCAN will scan the FM Band and stop at all RDS stations. Each RDS station will be played for a 5 second scan once around the FM Band and stop at the last station. The PTY icon will then turn off.

#### **Balance**

The Balance control adjusts the left-to-right speaker balance. Push in the button and it will pop out. Adjust the balance and push the button back in. The balance will be displayed and continuously updated while the button is turned.

#### **Fade**

The Fade control provides for balance between the front and rear speakers. Push in the button and it will pop out. Adjust the balance and push the button back in. The fade will be displayed and continuously updated while the button is turned.

#### **Tone Control**

Slide the Bass and/or Treble controls up or down to adjust the sound for the desired tone. The treble, and bass will be displayed and continuously updated while the slide is moved.



**AM/FM Selection**

Press the AM/FM button to change from AM to FM. The operating mode will be displayed next to the station frequency. The display will show ST when a stereo station is received.

**Scan Button**

Pressing the SCAN button causes the tuner to search for the next station, in either AM or FM, pausing for 5 seconds at each listenable station before continuing to the next.

Pressing the AM/FM button continues the search in the alternate frequency band.

To stop the search, press SCAN a second time.

**To Set The Radio Push-button Memory**

When you are receiving a station that you wish to commit to push-button memory, press the SET button. SET 1 will show in the display window. Select the push-button you wish to lock onto this station and press and release that button. If a station is not selected within

5 seconds after pressing the SET button, the station will continue to play but will not be locked into push-button memory.

You may add a second station to each push-button by repeating the above procedure with this exception: Press the SET button twice and SET 2 will show in the display window. Each button can be set for SET 1 and SET 2 in both AM and FM. This allows a total of 10 AM and 10 FM stations to be locked into memory. You can recall the stations stored in SET 2 memory by pressing the push-button twice.

**To Change From Clock To Radio Mode**

Press the Time button to change the display between radio frequency and time.

**Operating Instructions — Tape Player**

Insert the cassette with the exposed tape side toward the right and the mechanical action of the player will gently pull the cassette into the play position.

**NOTE:** When subjected to extremely cold temperatures, the tape mechanism may require a few minutes to warm up for proper operation. Sometimes poor playback may

be experienced due to a defective cassette tape. Clean and demagnetize the tape heads at least twice a year.

**Seek Button**

Press the SEEK button up for the next selection on the tape and down to return to the beginning of the current selection.

Press the SEEK button up or down to move the track number to skip forward or backward 1 to 6 selections. Press the SEEK button once to move 1 selection, twice to move 2 selections, etc.

**Fast Forward (FF)**

Press the FF button up momentarily to advance the tape in the direction that it is playing. The tape will advance until the button is pressed again or the end of the tape is reached. At the end of the tape, the tape will play in the opposite direction.

**Rewind (RW)**

Press the RW button momentarily to reverse the tape direction. The tape will reverse until the button is pressed again or until the end of the tape is reached. At the end of the tape, the tape will play in the opposite direction.

**Tape Eject**

Press the EJT Tape button and the cassette will disengage and eject from the radio.

**Scan Button**

Press this button to play 10 seconds of each selection. Press the scan button a second time to cancel the feature.

**Changing Tape Direction**

If you wish to change the direction of tape travel (side being played), press the PTY button. The lighted arrow in the display window will show the new direction.

**Metal Tape Selection**

If a standard metal tape is inserted into the player, the player will automatically select the correct equalization and the 70 symbol will appear in the display window.

**Pinch Roller Release**

If ignition power or the radio ON/OFF switch are turned off, the pinch roller will automatically retract to protect the tape from any damage. When power is restored to the tape player, the pinch roller will automatically reengage and the tape will resume play.

**Noise Reduction**

The Dolby Noise Reduction System\* is on whenever the tape player is on, but may be switched off.

To turn off the Dolby Noise reduction System: Press the Dolby button (button 2) after you insert the tape. The NR light in the display will go off when the Dolby System is off. The Dolby System is automatically reactivated each time a tape is inserted.

\* "Dolby" noise reduction manufactured under license from Dolby Laboratories Licensing Corporation. Dolby and the double-D symbol are trademarks of Dolby Laboratories Licensing Corporation.

**Operating Instructions — CD Player**

**NOTE:** The ignition switch must be in the ON or ACC position and the volume control ON before the CD player will operate.

**CAUTION!**

This CD player will accept 4 ¾ inch (12 cm) discs only. The use of other sized discs may damage the CD player mechanism.

**Inserting The Compact Disc**

The CD player contained within the radio is not a multi-disc changer, and will only accept one CD. Gently insert one CD into the CD player with the CD label facing up. The CD will automatically be pulled into the CD Player.

If the volume control is ON, the unit will switch from radio to CD mode and begin to play. The display will show the track number and index time in minutes and seconds. Play will begin at the start of track one.

**NOTE:**

- You may eject a disc with the radio OFF. The ignition switch must be in the ON or ACC position to insert a disc with the radio OFF.

- If you insert a disc with the ignition ON and the radio OFF, the CD will automatically be pulled into the CD Player and the display will show the time of day. If you insert a disc with the ignition OFF, the display will show the time of day for about 5 seconds, then go out.

**Seek Button**

Press the top of the SEEK button for the next selection on the CD. Press the bottom of the button to return to the beginning of the current selection, or return to the beginning of the previous selection if the CD is within the first 10 seconds of the current selection.

**EJT CD (Eject) Button**

Press this button and the disc will unload and move to the entrance for easy removal. The unit will switch to the radio mode.

If you do not remove the disc within 15 seconds, it will be reloaded. The radio mode will continue to appear.

The disc can be ejected with the radio OFF.

**FF/TUNE/RW**

Press FF (Fast Forward) and the CD player will begin to fast forward until FF is released. The RW (Reverse) button works in a similar manner.

**Program Button 4 (Random Play)**

Press this button while the CD is playing to activate Random Play. This feature plays the tracks on the selected disc in random order to provide an interesting change of pace.

Press the SEEK button to move to the next randomly selected track.

Press TUNE FF to fast forward through the tracks. Press the FF button a second time to stop the fast forward feature. If TUNE RW is pressed, the current track will reverse to the beginning of the track and begin playing.

Press button 4 a second time to stop Random Play.

**MODE**

Press the MODE button to select between the tape player, CD player, or satellite radio (if equipped).

To select Satellite Radio (if equipped), press the MODE button until the word SIRIUS appears. The following will be displayed in this order: After three seconds, the current channel name and number will be displayed for five seconds. The current program type and channel number will then be displayed for five seconds. The current channel name and number will then be displayed until an action occurs. A CD or tape may remain in the player while in the Satellite Radio mode.

**Tape CD Button**

Press this button to select between CD player and Tape player.

**Time Button**

Press this button to change the display from elapsed CD playing time to time of day.

**Scan Button**

Press this button to play the first 10 seconds of each track. To stop the scan function, press the button a second time.

**CD Changer Control Capability — If Equipped**

This radio is compatible with a remote mounted CD changer available through Mopar Accessories. The following instructions are for the radio controls that operate this CD changer.

**Mode Button**

To activate the CD changer, press the MODE button until CD information appears on the display.

**Disc Up/Program Button 1**

Press the DISC up (button 1) button to play the next available disc.

**Disc Down/Program Button 5**

Press the DISC down (button 5) button to play the previous disc.

**Seek Button**

Press the SEEK up or down to select another track on the same disc. A SEEK symbol will appear on the display.

**Fast Forward And Rewind Buttons**

Press and hold the FF button for fast forward. Press and hold the RW button for fast reverse.

The audio output can be heard when fast forward and fast reverse are activated.

**Random Play (RND)**

Press the Random button to play the tracks on the selected disc in random order for an interesting change of pace.

Random can be cancelled by pressing the button a second time or by ejecting the CD from the changer.

**CD Diagnostic Indicators**

When driving over a very rough road, the CD player may skip momentarily. Skipping will not damage the disc or the player, and play will resume automatically.

As a safeguard and to protect your CD player, one of the following warning symbols may appear on your display.

A CD HOT symbol indicates the player is too hot.

CD HOT will pause the operation. Play can be resumed when the operating temperature is corrected or another MODE is selected.

An ERR symbol will appear on the display if the laser is unable to read the Disc data for the following reasons:

- Excessive vibration
- Disc inserted upside down
- Damaged disc
- Water condensation on optics

**SALES CODE RBB—AM/FM STEREO RADIO WITH CASSETTE TAPE PLAYER AND CD CHANGER CAPABILITY**

**NOTE:** The radio sales code is located on the lower left side of your radio faceplate.

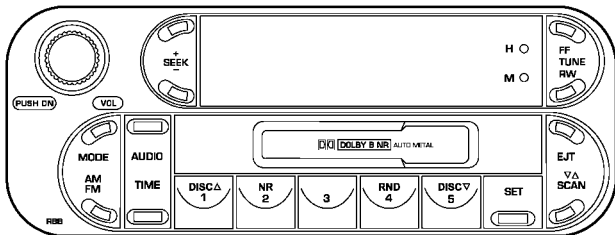

**RBB Radio**

813eb6b2

**Radio Operation**

**Power/Volume Control**

Press the ON/VOL control to turn the radio on. Turn the volume control clockwise to increase the volume.

**NOTE:** Power to operate the radio is supplied through the ignition switch. It must be in the ON or ACC position to operate the radio.

**Electronic Volume Control**

The electronic volume control turns continuously (360 degrees) in either direction without stopping. Turning the volume control to the right increases the volume and to the left decreases it.

When the audio system is turned on, the sound will be set at the same volume level as last played.

For your convenience, the volume can be turned down, but not up, when the audio system is off and the ignition is ON.

**Seek**

Press and release the SEEK button to search for the next station in either the AM or FM mode. Press the top of the button to seek up and the bottom to seek down. The radio will remain tuned to the new station until you make another selection. Holding the button will bypass stations without stopping until you release it.

**Tune**

Press the TUNE control up or down to increase or decrease the frequency. If the button is pushed and held, the radio will continue to tune until the button is released. The frequency will be displayed and continuously updated while the button is pushed.

**To Set The Push-Button Memory**

When you are receiving a station that you wish to commit to push-button memory, press the SET button. The symbol SET 1 will now show in the display window. Select the "1-5" button you wish to lock onto this station and press and release that button. If a button is not selected within 5 seconds after pressing the SET button, the station will continue to play but will not be locked into push-button memory.

You may add a second station to each push-button by repeating the above procedure with this exception: Press the SET button twice and SET 2 will show in the display window. Each button can be set for SET 1 and SET 2 in both AM and FM. This allows a total of 10 AM and 10 FM stations to be locked into push-button memory. The stations stored in SET 2 memory can be selected by pressing the push-button twice.

Every time a preset button is used a corresponding button number will be displayed.

**Audio**

The audio button controls the BASS, TREBLE, BALANCE, and FADE.

Press the AUDIO button and BASS will be displayed. Press the SEEK + or SEEK - to increase or decrease the Bass tones.

Press the AUDIO button a second time and TREB will be displayed. Press the SEEK + or SEEK - to increase or decrease the Treble tones.



Press the AUDIO button a third time and BAL will be displayed. Press the SEEK + or SEEK - to adjust the sound level from the right or left side speakers.

Press the AUDIO button a fourth time and FADE will be displayed. Press the SEEK + or SEEK - to adjust the sound level between the front and rear speakers.

Press the AUDIO button again or wait 5 seconds to exit setting tone, balance, and fade.

#### **AM/FM Selection**

Press the AM/FM button to change from AM to FM. The operating mode will be displayed next to the station frequency. The display will show ST when a stereo station is received in the FM mode.

#### **Mode Button**

Press the MODE button to select between the cassette tape player, CD changer, or the Satellite Radio (if equipped). When the Satellite Radio (if equipped) is selected "SAT" will appear in your radio display.

A CD or tape may remain in the player while in the Satellite or radio mode.

#### **SCAN Button (Radio Mode)**

Pressing the SCAN button causes the tuner to search for the next listenable station, in either AM, FM or Satellite (if equipped) frequencies, pausing for 5 seconds at each listenable station before continuing to the next. To stop the search, press SCAN a second time.

#### **Cassette Player Features**

With ignition OFF and the sound system OFF, you can eject the tape cassette by pushing the EJECT button.

You can turn the tape player ON by inserting a cassette or activating the MODE button (with a cassette in the radio), but only when the ignition and radio are on.

Each time a cassette is inserted the tape player will begin playing on the side of the cassette that is facing up in the player.

#### **Music Search**

Pressing the SEEK button while playing a tape will start the Music Search mode. Press the SEEK button up for the next selection on the tape and down to return to the beginning of the current selection, or return to the

beginning of the previous selection if the tape is within the first 5 seconds of the current selection.

The SEEK symbol appears on the display when Music Search is in operation. Music Search shuts off automatically when a selection has been located.

#### **Selective Music Search**

Press the SEEK button up or down to move the track number to skip forward or backward 1 to 7 selections. Press the SEEK button once to move 1 selection, twice to move 2 selections, etc.

#### **Fast Forward And Rewind Buttons**

Pressing the TUNE button up or down momentarily activates Fast Forward or Rewind and makes the directional arrows appear on the display.

To stop Fast Forward or Rewind, press the TUNE button again.

#### **Time Button**

Press the time button to toggle between station frequency and time of day.

#### **SCAN Button (Cassette Mode)**

Pressing this button while playing a cassette tape will change the side of the tape being played.

#### **NR (Noise Reduction)**

Pushing the Number 2 Pre-set button when a tape is playing deactivates the Dolby Noise Reduction System\*. When Dolby is ON, the NR symbol appears on the display. Each time a tape is inserted the Dolby will turn ON.

\* "Dolby" noise reduction manufactured under license from Dolby Laboratories Licensing Corporation. Dolby and the double-D symbol are trademarks of Dolby Laboratories Licensing Corporation.

#### **CD Changer Control Capability — If Equipped**

This radio is compatible with a remote mounted CD changer available through Mopar Accessories. The following instructions are for the radio controls that operate this CD changer.

#### **Mode Button**

To activate the CD changer, press the MODE button until CD information appears on the display.

**Push-Button**

While the CD changer is playing, press the NUMBER 1 push-button or the NUMBER 5 push-button to select a disc numbered higher or lower than the one currently being played.

**Seek Button**

Press the SEEK up or down to select another track on the same disc. A SEEK symbol will appear on the display.

**Fast Forward And Rewind Buttons**

Press and hold the FF button for fast forward. Press and hold the RW button for fast reverse.

The audio output can be heard when fast forward and fast reverse are activated.

**Random Play (RND)**

Press the Random button to play the tracks on the selected disc in random order for an interesting change of pace.

Random can be cancelled by pressing the button a second time or by ejecting the CD from the changer.

**SCAN Button (CD Mode)**

Press this button to play the first 10 seconds of each track. To stop the scan function, press the button a second time.

**Operating Instructions - Satellite Radio Mode (If Equipped)**

Refer to the Satellite Radio section of the Owner's Manual.

**CD Diagnostic Indicators**

When driving over a very rough road, the CD player may skip momentarily. Skipping will not damage the disc or the player, and play will resume automatically.

As a safeguard and to protect your CD player, one of the following warning symbols may appear on your display.

A CD HOT symbol indicates the player is too hot.

CD HOT will pause the operation. Play can be resumed when the operating temperature is corrected or another MODE is selected.

An ERR symbol will appear on the display if the laser is unable to read the Disc data for the following reasons:

- Excessive vibration

- Disc inserted upside down
- Damaged disc
- Water condensation on optics

### SALES CODE RBK—AM/ FM STEREO RADIO WITH CD PLAYER AND CD CHANGER CONTROLS

**NOTE:** The radio sales code is located on the lower left side of your radio faceplate.

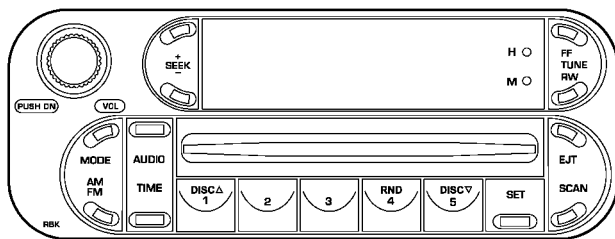

813ebac3

**RBK Radio**

### Radio Operation

#### Power/Volume Control

Press the ON/VOL control to turn the radio on. Turn the volume control clockwise to increase the volume.

**NOTE:** Power to operate the radio is supplied through the ignition switch. It must be in the ON or ACC position to operate the radio.

#### Seek

Press and release the SEEK button to search for the next station in either the AM or FM mode. Press the top of the button to seek up or the bottom to seek down. The radio will remain tuned to the new station until you make another selection. Holding the button in will bypass stations without stopping until you release it.

#### Tune

Press the TUNE control up or down to increase or decrease the frequency. If you press and hold the button, the radio will continue to tune until you release the button. The frequency will be displayed and continuously updated while the button is pressed.

### To Set The Radio Push-Button Memory

When you are receiving a station that you wish to commit to push-button memory, press the SET button. SET 1 will show in the display window. Select the "1-5" button you wish to lock onto this station and press and release that button. If a button is not selected within 5 seconds after pressing the SET button, the station will continue to play but will not be locked into push-button memory.

You may add a second station to each push-button by repeating the above procedure with this exception: Press the SET button twice and SET 2 will show in the display window. Each button can be set for SET 1 and SET 2 in both AM and FM. This allows a total of 10 AM and 10 FM stations to be locked into push-button memory. The stations stored in SET 2 memory can be selected by pressing the push-button twice. Every time a preset button is used a corresponding button number will be displayed.

### Audio

The audio button controls the BASS, TREBLE, BALANCE, and FADE.

Press the AUDIO button and BASS will be displayed. Press the SEEK + or SEEK - to increase or decrease the Bass tones.

Press the AUDIO button a second time and TREB will be displayed. Press the SEEK + or SEEK - to increase or decrease the Treble tones.

Press the AUDIO button a third time and BAL will be displayed. Press the SEEK + or SEEK - to adjust the sound level from the right or left side speakers.

Press the AUDIO button a fourth time and FADE will be displayed. Press the SEEK + or SEEK - to adjust the sound level between the front and rear speakers.

Press the AUDIO button again or wait 5 seconds to exit setting tone, balance, and fade.

### AM/FM Selection

Press the AM/FM button to change from AM to FM. The operating mode will be displayed next to the station frequency. The display will show ST when a stereo station is received.

**Time**

Press the TIME button to change the display between radio frequency and time.

**General Information**

This radio complies with Part 15 of FCC rules and with RSS-210 of Industry Canada. Operation is subject to the following conditions:

1. This device may not cause harmful interference,
2. This device must accept any interference received, including interference that may cause undesired operation.

**NOTE:** Changes or modifications not expressly approved by the party responsible for compliance could void the user's authority to operate the equipment.

**CD Player Operation**

**NOTE:** The ignition switch must be in the ON or ACC position and the volume control ON before the CD player will operate.

**Inserting The Compact Disc****CAUTION!**

This CD player will accept 4 ¾ inch (12 cm) discs only. The use of other sized discs may damage the CD player mechanism.

You may either insert or eject a disc with the radio OFF.

If you insert a disc with the ignition ON and the radio OFF, the display will show the time of day.

If the power is ON, the unit will switch from radio to CD mode and begin to play when you insert the disc. The display will show the track number and index time in minutes and seconds. Play will begin at the start of track one.

**Seek**

Press the top of the SEEK button for the next selection on the CD. Press the bottom of the button to return to the

beginning of the current selection, or return to the beginning of the previous selection if the CD is within the first second of the current selection.

#### **EJT — Eject**

Press the EJT button and the disc will unload and move to the entrance for easy removal. The unit will switch to the radio mode.

If you do not remove the disc within 15 seconds, it will be reloaded. The unit will continue in radio mode.

The disc can be ejected with the radio and ignition OFF (except on convertibles).

#### **FF/TUNE/RW**

Press FF (Fast Forward) and the CD player will begin to fast forward until FF is released. The RW (Reverse) button works in a similar manner.

#### **Random Play — RND/Program Button 4**

Press the RND (button 4) button while the CD is playing to activate Random Play. This feature plays the tracks on the selected disc in random order to provide an interesting change of pace.

Press the SEEK button to move to the next randomly selected track.

Press the RND (button 4) button a second time to stop Random Play.

#### **Mode**

Press the MODE button repeatedly to select between the CD player, the optional remote CD changer and the Satellite Radio (if equipped). When Satellite Radio (if equipped) is selected "SAT" will appear in your radio display.

A CD or tape may remain in the player while in the Satellite mode.

#### **Time**

Press the TIME button to change the display from elapsed CD playing time to time of day.

#### **CD Changer Control Capability — If Equipped**

This radio is compatible with a remote mounted CD changer available through Mopar Accessories. The following instructions are for the radio controls that operate this CD changer.

**Mode Button**

To activate the CD changer, press the MODE button until CD information appears on the display.

**Disc Up/Program Button 1**

Press the DISC up (button 1) button to play the next available disc.

**Disc Down/Program Button 5**

Press the DISC down (button 5) button to play the previous disc.

**Seek Button**

Press the SEEK up or down to select another track on the same disc. A SEEK symbol will appear on the display.

**Fast Forward And Rewind Buttons**

Press and hold the FF button for fast forward. Press and hold the RW button for fast reverse.

The audio output can be heard when fast forward and fast reverse are activated.

**Random Play (RND)**

Press the Random button to play the tracks on the selected disc in random order for an interesting change of pace.

Random can be cancelled by pressing the button a second time or by ejecting the CD from the changer.

**Operating Instructions - Satellite Radio Mode (If Equipped)**

Refer to the Satellite Radio section of the Owner's Manual.

**CD Diagnostic Indicators**

When driving over a very rough road, the CD player may skip momentarily. Skipping will not damage the disc or the player, and play will resume automatically.

As a safeguard and to protect your CD player, one of the following warning symbols may appear on your display.

A CD HOT symbol indicates the player is too hot.

CD HOT will pause the operation. Play can be resumed when the operating temperature is corrected or another MODE is selected.



An ERR symbol will appear on the display if the laser is unable to read the Disc data for the following reasons:

- Excessive vibration
- Disc inserted upside down
- Damaged disc
- Water condensation on optics

#### 6 DISC CD CHANGER — IF EQUIPPED

The CD changer is located below the radio in the instrument panel. The changer plays only 4 ¾ inch (12 cm) discs. The changer holds up to 6 discs. Each disc is loaded and ejected through a single slot in front of the changer. Each disc has a numbered button with an amber light above it which, when illuminated, indicates that a disc is loaded in that particular chamber.

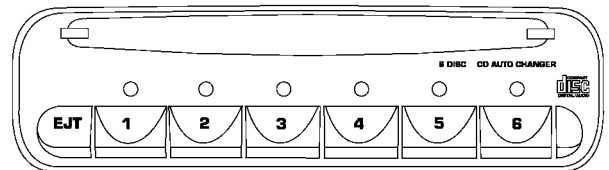

80ef1625

4

#### 6 Disc CD Changer

##### Loading the CD Changer

When inserting the first CD into the changer if the radio is on, wait until the single slot is illuminated on both sides and simply insert the first disc.

To insert additional CDs into the changer, the instructions follow:

1. Select and press any numbered button without an illuminated light above it.

2. Insert the CD while the light above the chosen button is flashing and the two lights on either side of the slot are illuminated.
3. Upon insertion, the CD will begin to play, and both the button light and the lights in the corner of the loading slot will illuminate.
4. Repeat the process for loading any additional CDs. The CD player will stop while additional CDs are loaded.

#### **Playing Discs**

The radio will show the CD number, the CD track number, and the Track Time Elapsed while the radio is in the CD mode. If more than one CD is loaded in the changer, the changer will automatically play the next disc after playing the last track of the current disc.

#### **Seek Button**

Press the top of this button on the radio once to play the next track. Press the bottom of the button once to return to the beginning of the current track. Press the bottom of the button twice to play the previous track.

#### **FF/TUNE/RW**

Press the FF (fast forward) button and the CD player will fast forward through the tracks until the button is released. Press the RW (rewind) button and the CD player will reverse through the tracks until the button is released.

#### **Mode Button**

Press this button to toggle between radio and cd modes.

#### **Program Button 1**

Press this button to play the next available disc.

#### **Program Button 4 (Random Play)**

Press this button while the CD is playing to activate Random Play. This feature plays the selections on the current compact disc in random order to provide an interesting change of pace. The CD changer stays in the random play mode when changing to the next disc.

**NOTE:** The changer will not random play between discs.

Press the top of the Seek button once to move to the next randomly selected track. Press the bottom of the Seek button to go back to the beginning of the track.

Press button 4 a second time to stop random play.

**Program Button 5**

Press this button to play the previous disc.

**Time Button**

Press this button to switch between time of day and CD track time.

**Changing Modes**

While in the radio mode, if a cassette is loaded, press the Mode button to switch to the tape mode. If a CD is loaded, press the Mode button to select the CD mode. If neither a tape nor CD is loaded, the radio will ignore the command.

- Inserting either a tape or CD automatically starts that mode of play.
- Pressing the AM/FM button while in the tape or CD mode will select the radio mode.
- If in the CD mode and the last CD is ejected, the radio will tune to the last station selected.

**Removing Discs from the CD Changer**

If there is a single CD in the changer, press the EJT button and the CD will eject. If the CD is not removed within 15 seconds, it will automatically reload into the CD changer. To eject additional CDs from the changer, first select the numbered button where the CD is located and then press the EJT button.

**CD Changer Operation with the Changer Off**

The CD changer is able to load and eject discs with the ignition power off. However, while the ignition is off, one of the six numbered buttons must be pressed first.

**SATELLITE RADIO — IF EQUIPPED**

Satellite radio uses direct satellite to receiver broadcasting technology to provide clear digital sound, coast to coast. The subscription service provider is Sirius™ Satellite Radio. This service offers up to 100 channels of music, sports, news, entertainment, and programming for children, directly from its satellites and broadcasting studios.

**System Activation**

To activate your Sirius Satellite Radio service, call the toll-free number 888-539-7474, or visit the Sirius web site at [www.sirius.com](http://www.sirius.com). Please have the following information available when activating your system:

1. The Electronic Serial Number/Sirius Identification Number (ESN/SID).
2. Credit card information.
3. Your Vehicle Identification Number.

**Electronic Serial Number/Sirius Identification Number (ESN/SID)**

The Electronic Serial Number/Sirius Identification Number is needed to activate your Sirius Satellite Radio system. To access the ESN/SID, refer to the following steps:

**ESN/SID Access With RBB, RAH and RBK Radios**

With the ignition switch in the ACCESSORY position and the radio OFF, press the Tape Eject or CD Eject (depending on the radio type) and Time buttons simultaneously for 3 seconds. The first four digits of the twelve-digit ESN/SID number will be displayed. Press the SEEK UP

button to display the next four digits. Continue to press the SEEK UP button until all twelve ESN/SID digits have been displayed. The SEEK DOWN will page down until the first four digits are displayed. The radio will exit the ESN/SID mode when any other button is pushed, the ignition is turned OFF, or 5 minutes has passed since any button was pushed.

**ESN/SID Access With RBP, RBU, RAZ, RB1 and RBQ Radios**

With the ignition switch in the ACCESSORY position and the radio OFF, press the CD Eject and TIME buttons simultaneously for 3 seconds. All twelve ESN/SID numbers will be displayed. The radio will exit the ESN/SID mode when any other button is pushed, the ignition is turned OFF, or 5 minutes has passed since any button was pushed.

**Selecting Satellite Mode in RBB, RAH and RBK Radios**

Press the MODE button repeatedly until "S A" appears in the display. A CD or tape may remain in the radio while in the Satellite radio mode.

**Selecting Satellite Mode in RBP, RBU, RAZ, RB1 and RBQ Radios**

Press the MODE button repeatedly until the word "SIRIUS" appears in the display. These radios will also display the following:

- After 3 seconds, the current channel name and channel number will be displayed for 5 seconds.
- The current program type and channel number will then be displayed for 5 seconds.
- The current channel number will then be displayed until an action occurs.

A CD or tape may remain in the radio while in the Satellite radio mode.

**Selecting a Channel**

Press and release the SEEK or TUNE buttons to search for the next channel. Press the top of the button to search up and the bottom of the button to search down. Holding the TUNE button causes the radio to bypass channels until the button is released.

Press and release the SCAN button (if equipped) to automatically change channels every 7 seconds. The radio will pause on each channel for 7 seconds before moving on to the next channel. The word "SCAN" will appear in the display between each channel change. Press the SCAN button a second time to stop the search.

**NOTE:** Channels that may contain objectionable content can be blocked. Contact Sirius Customer Care at 888-539-7474 to discuss options for channel blocking or unblocking. Please have your ESN/SID information available.

**Storing and Selecting Pre-Set Channels**

In addition to the 10 AM and 10 FM pre-set stations, you may also commit 10 satellite stations to push button memory. These satellite channel pre-set stations will not erase any AM or FM pre-set memory stations. Follow the memory pre-set procedures that apply to your radio.

**Using the PTY (Program Type) Button (If Equipped)**

Follow the PTY button instructions that apply to your radio.

**PTY Button "SCAN"**

When the desired program type is obtained, press the "SCAN" button within five seconds. The radio will play 7 seconds of the selected channel before moving to the next channel of the selected program type. Press the "SCAN" button a second time to stop the search.

**NOTE:** Pressing the "SEEK" or "SCAN" button while performing a music type scan will change the channel by one and stop the search. Pressing a pre-set memory button during a music type scan, will call up the memory channel and stop the search.

**PTY Button "SEEK"**

When the desired program is obtained, press the "SEEK" button within five seconds. The channel will change to the next channel that matches the program type selected.

**Satellite Antenna**

To ensure optimum reception, do not place items on the roof around the rooftop antenna location or strap items to the trunk lid around the trunk lid antenna (if equipped). Metal objects placed within the line of sight of the antenna will cause decreased performance. Larger luggage items such as bikes should be placed as far rearward as possible, within the loading design of the rack. Do not place items directly on or above the antenna.

**Reception Quality**

Satellite reception may be interrupted due to one of the following reasons.

- The vehicle is parked in an underground parking structure or under a physical obstacle.
- Dense tree coverage may interrupt reception in the form of short audio mutes.
- Driving under wide bridges or along tall buildings can cause intermittent reception.
- Placing objects over or too close to the antenna can cause signal blockage.

### REMOTE SOUND SYSTEM CONTROLS — IF EQUIPPED

The remote sound system controls are located on the rear surface of the steering wheel. Reach behind the wheel to access the switches.

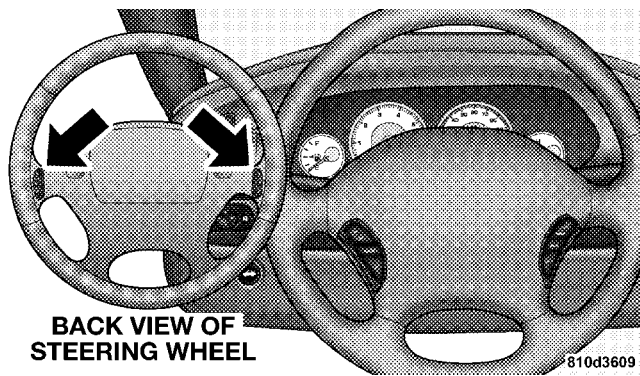

Remote Sound System Controls

The right hand control is a rocker type switch with a push-button in the center and controls the volume and mode of the sound system. Pressing the top of the rocker switch will increase the volume and pressing the bottom of the rocker switch will decrease the volume.

Pressing the center button will make the radio switch between the various modes available (AM/FM/TAPE/CD, Etc.).

The left hand control is a rocker type switch with a push-button in the center. The function of the left hand control is different depending on which mode you are in.

The following describes the left hand control operation in each mode.

#### Radio Operation

Pressing the top of the switch will "Seek" up for the next listenable station and pressing the bottom of the switch will "Seek" down for the next listenable station.

The button located in the center of the left hand control will tune to the next preset station that you have programmed in the radio preset push-button.

#### Tape Player

Pressing the top of the switch once will go to the next selection on the cassette. Pressing the bottom of the switch once will go to the beginning of the current selection or to the beginning of the previous selection if it is within the first 5 seconds of the current selection.

If you press the switch up or down twice it plays the second selection, three times, it will play the third, etc.

The button in the center of the left hand switch has no function in this mode.

#### **CD Player — Single Disc in Radio**

Pressing the top of the switch once will go to the next track on the CD. Pressing the bottom of the switch once will go to the beginning of the current track or to the beginning of the previous track if it is within one second after the current track begins to play.

If you press the switch up or down twice it plays the second track, three times, it will play the third, etc.

The button in the center of the left hand switch has no function in this mode.

#### **CD Player — 6 Disc CD Changer**

Pressing the top of the switch once will go to the next track on the CD. Pressing the bottom of the switch once will go to the beginning of the current track or to the beginning of the previous track if it is within one second after the current track begins to play.

If you press the switch up or down twice it plays the second track, three times, it will play the third, etc.

The button in the center of the left hand switch will cause the CD changer to play the next available disc.

#### **CASSETTE TAPE AND PLAYER MAINTENANCE**

To keep the cassette tapes and player in good condition, take the following precautions:

1. Do not use cassette tapes longer than C-90; otherwise, sound quality and tape durability will be greatly diminished.
2. Keep the cassette tape in its case to protect from slackness and dust when it is not in use.
3. Keep the cassette tape away from direct sunlight, heat and magnetic fields such as the radio speakers.
4. Before inserting a tape, make sure that the label is tightly secured to the cassette.
5. A loose tape should not be inserted into the radio.



Maintain your cassette tape player. The head and capstan shaft in the cassette player can pick up dirt or tape deposits each time a cassette is played. The result of deposits on the capstan shaft may cause the tape to wrap around and become lodged in the tape transport. The other adverse condition is low or "muddy" sound from one or both channels, as if the treble tone control were turned all the way down. To prevent this, you should periodically clean the head with a commercially available WET cleaning cassette.

As preventive maintenance, clean the head about every 30 hours of use. If you wait until the head becomes very dirty (noticeably poor sound), it may not be possible to remove all deposits with a simple WET cleaning cassette.

### COMPACT DISC MAINTENANCE

To keep the compact discs in good condition, take the following precautions:

1. Handle the disc by its edge or center; avoid touching the surface.
2. If the disc is stained, clean the surface with a soft cloth, wiping from center to edge.
3. Do not apply paper or tape to the disc; avoid scratching the disc.
4. Do not use solvents such as benzine, thinner, cleaners, or antistatic sprays.
5. Store the disc in its case after playing.
6. Do not expose the disc to direct sunlight.
7. Do not store the disc where temperatures may become too high.

**NOTE:** If you experience difficulty in playing a particular disc, it may be damaged, oversized, or have theft protection encoding. Try a known good disc before considering disc player service. You may have a problem with CD-R (recordable) and CD-RW (recordable and writable) disks.

### RADIO OPERATION AND CELLULAR PHONES

Under certain conditions, the operation of a cellular phone in your vehicle can cause erratic or noisy performance from your radio. This condition may be lessened or eliminated by relocating the cellular phone antenna. This condition is not harmful to the radio. If your radio performance does not satisfactorily “clear” by the repositioning of the cellular antenna, it is recommended that the radio volume be turned down or off during cellular phone operation.

### CLIMATE CONTROLS

#### Automatic Temperature Control (ATC) — If Equipped

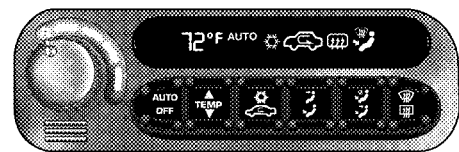

80f5fea7

#### Automatic Temperature Controls

The ATC system can maintain a steady comfort level in various weather conditions with a simple two step operation. Press the AUTO button and select your comfort setting. The system will automatically control comfort by varying temperature, fan speed, and Mode.

You also may choose to customize your comfort by selecting the fan speed and Mode. This will place the system into manual operation

**Interior ATC Sensors**

There are two interior sensors in the vehicle. The Sun Sensor is mounted in the center of the instrument panel near the windshield glass. The In-Car Temperature Sensor is mounted behind the ATC control panel. These sensors transmit data on sun strength and vehicle interior temperatures to enhance system performance.

**CAUTION!**

**Do not cover either sensor with any foreign material as improper operation of the system will result.**

**Level Of Automatic Control**

72°F (22°C) is the recommended setting for maximum comfort for the average person, however, this may vary.

**NOTE:** The temperature setting can be adjusted at any time without affecting automatic control operation.

The control also will show what Mode the system is in by the figure shown in the display.

**NOTE:** The Mode can change when the system is in the Auto Mode. This will be indicated in changes in the display window. This shows automatic changes in air direction.

**Fan Control**

 Use this control to regulate the amount of air forced through the system in any mode you select. Turn the control clockwise to increase fan speed.

In ambient temperatures below 21°C (70°F), fan operation is delayed when the engine is first started. The fan will automatically start when the engine coolant is warm enough to heat the air. This feature can be defeated by turning the fan control.

**NOTE:** While in Automatic Temperature Control, changing the fan control position will switch control back into manual control.

**AUTO Control**

Press the top of the button to turn the ATC system On. Press the lower portion of the button to turn the entire system Off.

**Comfort Control**

Use this control to regulate the comfort inside the passenger compartment. Press the top of the switch to raise the temperature selection and the bottom of the switch to lower it. The comfort setting range is from Low, 60, 61,.....to 89,90, Hi, for automatic temperature control. You can select a very hot or cold comfort setting by holding the comfort control until it reaches its highest or lowest levels.

The system adjusts to bring the interior temperature to the desired comfort level. All comfort settings are automatic; even Hi and Low.

**NOTE:** You can change the display from U.S. to metric units by pressing the Mix and Panel mode buttons simultaneously or by pressing the English/Metric button on the overhead console.

**Air Conditioning Button**

Press this button to turn on the air conditioning compressor. A snowflake symbol in the display shows that the compressor is on. Compressor operation is automatic when you press the Auto button.

The compressor can operate at any temperature above 32°F (0°C).

With the compressor off and the temperature set at Lo, air entering the vehicle will be slightly warmer than the air outside the vehicle.

**NOTE:** The compressor will not engage until the engine has been running for several seconds. Slight changes in engine speed or power may be noticed when the compressor is on. This is a normal occurrence since the compressor will cycle on and off to maintain comfort and improve fuel economy.

**Recirculate Button**

Press this button to recirculate the air inside the vehicle. Outside air is prevented from entering the vehicle. Recirculation is automatically controlled when the system is in Auto Mode. Use this mode to temporarily block out any outside odors, smoke, or dust.

Manual control of Recirculation is possible only in Panel, Floor, and Bi-Level modes. It will not operate in Mix, or Defrost modes.

**NOTE:** The Recirc button light will blink if you try to use it in the Mix or Defrost modes.

#### **Air Direction Buttons (Mode)**

These buttons allow you to select from five air distribution patterns. These buttons should be used only when you can not achieve comfort or visibility in Auto operation. A symbol in the display window will show which mode is operating.

##### *Panel*

 Air is directed through the outlets in the instrument panel. These outlets can be adjusted to direct air flow. This mode is not recommended when heat is required.

##### *Floor*

 Air is directed through the floor outlets with a lesser amount through the Defrost and side window demist outlets. This mode is recommended when heat is desired.

##### *Mix*

 Air is directed through the floor, defrost, and side window demist outlets. Use this setting in cold or snowy conditions that require extra heat at the windshield. This setting is good for maintaining comfort while reducing moisture on the windshield. The compressor is on in this mode.

##### *Bi-Level*

 Air is directed through both the panel and floor outlets. This mode is not recommended when heat is required in very cold temperatures.

**NOTE:** There is a varying difference in temperature between the upper and lower outlets for added comfort. The warmer air goes to the floor outlets. This feature provides improved comfort during sunny but cool conditions.

### Windshield Defrost



Air is directed through the defrost outlets and side window demist outlets. A small amount of air also is directed through the floor outlets. Use this mode with maximum fan and comfort level settings for best windshield and side window defrosting. The defrost symbol will glow in amber to show that the defroster is on.

**NOTE:** The air conditioning compressor is on in this mode. This dehumidifies the air to help dry the windshield. To improve fuel economy, leave in the defrost mode only when necessary.

### Rear Window Defroster



Press the button once to turn on the Rear Window Defroster and a second time to turn it off. An indicator light in the control shows that the defroster is on.

**NOTE:** The defroster turns off automatically after 15 minutes of operation. Each later activation will allow 7 1/2 minutes of operation.

### CAUTION!

To avoid damaging the electrical conductors, do not use scrapers, sharp instruments, or abrasive window cleaners on the interior surface of the rear window. Labels can be peeled off by soaking with warm water.

### Window Fogging

In mild but rainy or humid weather, your windows may fog up on the inside. You can remove this fog by pressing the Defrost button. The Mix mode can be used to maintain a clear windshield and provide sufficient heating. If side window fogging becomes a problem, increase blower speed. The compressor will remain on during these conditions.

**NOTE:** Do not use the recirculated air mode under these conditions as window fogging may occur.

**Hot Weather Automatic Recirculation**

The system will automatically recirculate the air inside the vehicle when the interior is very warm. This will provide maximum cooling. The system will also occasionally return to REC on hot, humid or very hot, dry days to maintain occupant comfort.

**Side Window Demisters**

Side window demisters are located on the instrument panel. These non adjustable outlets direct air toward the side windows in any mode except Panel or Panel Recirculation. The air is directed toward the area of the side windows through which you view the outside rearview mirrors.

**Rear Seat Outlets**















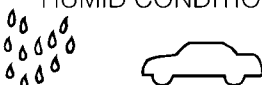

These outlets are located under the front seats and direct warm air to the rear seat passengers. Air is directed through these outlets when you select either the Floor, Bi-Level, or Mix modes.

**Outside Air Intake**

Make sure that the air intake directly in front of the windshield is free of obstructions. Leaves, snow, etc., could block air flow into the vehicle.

**NOTE:** If you cannot get comfortable in the AUTO mode by adjusting the comfort set point up or down please refer to the Operating Tips chart (for ATC only) at the end of this section for suggested control settings in different weather conditions.

Operating Tips (ATC only)

WEATHER	CONTROL SETTINGS
<p>HOT WEATHER AND VEHICLE INTERIOR IS VERY HOT</p> 	<p>Open the windows, start the vehicle, set the Mode control to Panel  or Bi-Level , and turn on A/C. Set the Fan control to the High position (full clockwise). Set the temperature control to Lo. After the hot air is flushed from the vehicle, set the Mode control to Recirculate  with A/C on and roll up the windows. Once you are comfortable, set the Mode control to Panel  or Bi-Level  with A/C on.</p>
<p>WARM WEATHER</p> 	<p>If it's sunny, set the Mode control to Panel  and turn on A/C. If it's cloudy or dark, set the Mode control to Bi-Level  with A/C on. Adjust Temperature control for comfort.</p>
<p>COOL OR COLD HUMID CONDITIONS</p> 	<p>Set the Mode control to Mix  or Defrost . Set the Fan Control to the High position (full clockwise). Adjust Fan and Temperature control for comfort if windows are clear.</p>
<p>COLD DRY CONDITIONS</p> 	<p>Set the Mode control to Floor . If it's sunny, you may want more upper air. In this case, set the Mode control to Bi-Level . In very cold weather, if you need extra heat at the windshield, set the Mode control to Mix  or Defrost  as needed. Adjust Fan and Temperature control for comfort.</p>

8147ca17



**NOTE:** If the system is in the AUTO mode and the fan control is already rotated fully clockwise or fully counterclockwise, the control may have to be rotated to the middle and then to the desired fan setting for manual adjustment of fan speed.

**Manual Air Conditioning/Heater Control — If Equipped**

The Air Conditioning System allows you to balance the temperature, amount, and direction of air circulating throughout the vehicle.

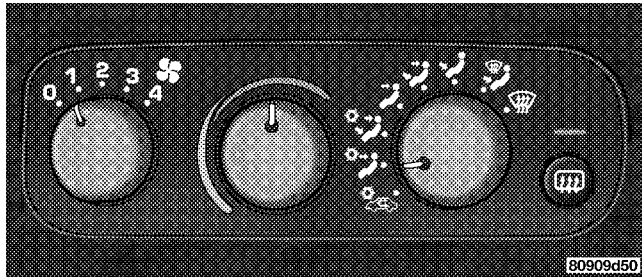

Manual Air Conditioning and Heating Controls

The air conditioning system of your vehicle contains R-134a, a refrigerant that does not deplete the ozone layer in the upper atmosphere.

The controls are as follows:

**Fan and Air Conditioning Control**

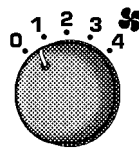

80909dad

Use this control to regulate the amount of air forced through the system in any mode you select. The 0 Setting represents OFF and the 4 Setting is the greatest amount of air flow.

4

**Air Conditioning Operation**

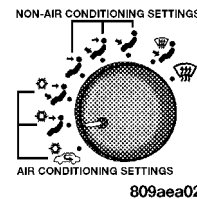

809aea02

To turn on the Air Conditioning, choose the direction of the air through the outlets by selecting between the Air Conditioning Recirculation, Panel-Air Conditioning, or Bi-Level Air Conditioning modes on the Mode Control. Air Conditioning modes are indicated by the snowflake symbol shown above in illustration. Adjust the Temperature and Fan Controls.

Slight changes in engine speed or power may be noticed when the air conditioning compressor is on. This is a normal occurrence as the compressor will cycle on and off to maintain comfort and increase fuel economy.

**NOTE:** If your air conditioning performance seems lower than expected, check the front of the air conditioning condenser for an accumulation of dirt or insects. The air conditioning condenser is located in front of the radiator. Clean with a gentle water spray from behind the radiator and through the condenser. Fabric front fascia protectors may reduce air flow to the condenser, reducing air conditioning performance.

#### Temperature Control

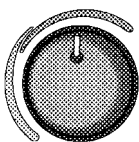

8091f160

Use this control to regulate the temperature of the air inside the passenger compartment. The blue area of the scale indicates cooler temperatures while the red area indicates warmer temperatures.

#### Mode Control



80909dd2

The mode control allows you to choose from several patterns of air distribution.

- **Recirculation — Air Conditioning**



Recirculated interior air is cooled and sent through the instrument panel vents. Upon initial start up of the vehicle in very hot or humid weather, open windows and put in outside air modes to flush hot/humid air out. Then turn on the Recirculation mode to cool the vehicle interior rapidly. The Recirculation mode can also be used to temporarily block out any outside odors, smoke, or dust.

**NOTE:** Continuous use of the Recirculation mode may make the inside air stuffy and under mild, humid conditions cause windows to fog. Use of this mode for longer than 15 minutes is not recommended.

- *Panel — Air Conditioning*



Outside air flows through the air conditioning system and then through the outlets located in the instrument panel.

- *Bi-Level — Air Conditioning*



Outside air flows through the air conditioning system and then through the outlets located in both the instrument panel and floor outlets.

- *Panel*



Air is directed through the outlets in the instrument panel. These outlets can be adjusted to direct air flow.

- *Bi-Level*



Air is directed through the instrument panel and floor outlets.

**NOTE:** There is a difference in temperature between the upper and lower outlets for added comfort. The warmer air goes to the floor outlets. This feature gives improved comfort during sunny but cool conditions.

- *Floor*



Air is directed through the floor outlets with a lesser amount through the defrost and side window demist outlets.

- *Mix*



Air is directed through the floor, defrost and side window demist outlets. This setting works best in cold or snowy conditions that require extra heat at the windshield. This setting is good for maintaining comfort while reducing moisture on the windshield.

- *Defrost*



Air is directed through the windshield and side window demist outlets. Use this mode with maximum fan and temperature settings for best windshield and side window defrosting.

**NOTE:** The air conditioning compressor operates in both Mix and Defrost modes even if the Air Conditioning is not selected. This dehumidifies the air to help dry the windshield.

### Rear Seat Outlets

These outlets are located under the front seats and direct warm air to the rear seat passengers. Air is directed through these outlets when you select either the Floor, Bi-Level, or Mix modes.

### Rear Window Defroster



The Rear Window Defroster button is located to the right of the Mode Control. Press this button once to turn on the Rear Window Defrost and a second time to turn them off. A light above the button shows that the defroster is on.

**NOTE:** The defroster turns off automatically after 15 minutes of operation. Each later activation will allow 10 minutes of operation.

### Side Window Demisters

A side window demister outlet is at each end of the instrument panel. These non-adjustable outlets direct air toward the side windows when the system is in either the FLOOR, MIX, or DEFROST modes. A small amount of air is directed to the side window demisters in BI-LEVEL mode as well. The air is directed at the area of the windows through which you view the outside mirrors.

### Windshield and Side Window Fogging



Interior fogging on the windshield can be quickly removed by using the defrost position on the mode control.



Your side windows may fog on the inside in mild rainy or humid weather. To clear the windows, select the Panel-Air Conditioning mode on the Mode Control. Point the panel outlets toward the side windows.

**NOTE:** Do not use the recirculation mode as it will not clear windows under these conditions.

#### **Summer Operation**











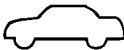





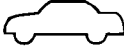

Air conditioned vehicles must be protected with a high-quality antifreeze coolant to provide proper corrosion protection and to raise the boiling point of the coolant for protection against overheating. A 50 % concentration is recommended.

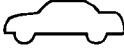
#### **Winter Operation**

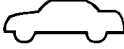
The blower air will heat faster in cold weather if you use only the low blower speeds for the first 10 minutes of operation. During engine warm up in cold weather, use the Defrost mode to direct any cold air away from vehicle occupants. Use of the Recirculate-Air Conditioning Mode during winter months is not recommended due to the possibility of window fogging.

**NOTE:** See Operating Tips chart (for Manual A/C Control) at the end of this section for suggested control settings in different weather conditions.

**Operating Tips (Manual A/C Control Only)**

WEATHER	CONTROL SETTINGS
<p>HOT WEATHER AND VEHICLE INTERIOR IS VERY HOT</p>  	<p>Open the windows, start the vehicle, and set the Mode control at Panel A/C  or Bi-Level A/C . Set the Fan control to the High position (full clockwise). Set the temperature control to full cool (counter-clockwise). After the hot air is flushed from the vehicle, turn the Mode control to Recirculate A/C  and roll up the windows. Once you are comfortable, place the Mode control at Panel A/C  or Bi-Level A/C .</p>
<p>WARM WEATHER</p>  	<p>If it's sunny, set the Mode control at Panel A/C . If it's cloudy or dark, set the Mode control at Bi-Level A/C . Adjust Temperature control for comfort.</p>
<p>COOL OR COLD HUMID CONDITIONS</p>  	<p>Set the Mode control at Mix  or Defrost . Set the Fan Control to the High position (full clockwise). Adjust Fan and Temperature control for comfort if windows are clear.</p>
<p>COLD DRY CONDITIONS</p>  	<p>Set the Mode control at Floor . If it's sunny, you may want more upper air. In this case, set the Mode control at Bi-Level . In very cold weather, if you need extra heat at the windshield, set the Mode control at Mix  or Defrost  as needed. Adjust Fan and Temperature control for comfort.</p>

81085e42

**Outside Air Intake**

Make sure the air intake, directly in front of the windshield, is free of ice, slush, snow or other obstructions such as leaves. Leaves collected in the air-intake plenum may reduce air flow and plug the plenum water drains.

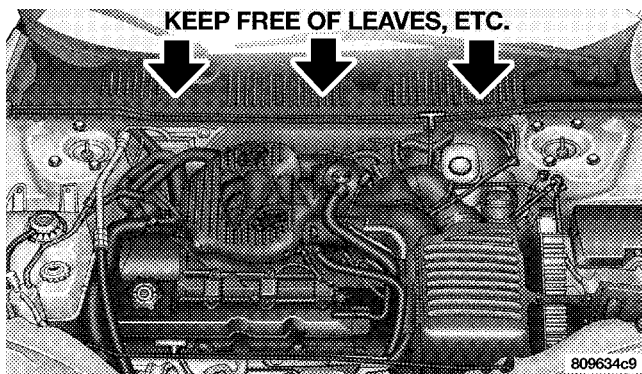

Air Intake





---

# STARTING AND OPERATING

## CONTENTS

---

■ Starting Procedures . . . . .	140	□ Automatic Transaxle Ignition Interlock System . . . . .	144
□ Automatic Transaxle . . . . .	140	□ Four Speed Automatic Transaxle . . . . .	145
□ Manual Transaxle . . . . .	140	□ Reset Mode . . . . .	145
□ Normal Starting . . . . .	140	□ Gear Ranges For Four Speed Automatic Transaxle . . . . .	145
□ Extreme Cold Weather (Below -20°F Or -29°C) . . . . .	141	■ Parking Brake . . . . .	147
□ If Engine Fails To Start . . . . .	142	■ Brake System . . . . .	149
□ After Starting . . . . .	142	□ Anti-Lock Brake System (ABS) — If Equipped . . . . .	149
■ Battery And Engine Block Heaters — If Equipped . . . . .	142	■ Power Steering . . . . .	150
■ Automatic Transaxle . . . . .	143	■ Traction Control — If Equipped . . . . .	150
□ Brake/Transmission Interlock . . . . .	143		

- Tire Safety Information . . . . .152
  - Tire Markings . . . . .152
  - Tire Identification Number (TIN) . . . . .154
  - Tire Loading And Tire Pressure . . . . .156
- Tires—General Information . . . . .160
  - Tire Pressure . . . . .160
  - Tire Inflation Pressures . . . . .161
  - Radial-Ply Tires . . . . .163
  - Compact Spare Tire — If Equipped . . . . .163
  - Limited Use Spare — If Equipped . . . . .164
  - Tire Spinning . . . . .164
  - Tread Wear Indicators . . . . .165
  - Life Of Tire . . . . .166
  - Replacement Tires . . . . .166
  - Alignment And Balance . . . . .167
- Tire Chains . . . . .168
- Snow Tires . . . . .168
- Tire Rotation Recommendations . . . . .168
- AutoStick — If Equipped . . . . .169
  - AutoStick Operation . . . . .170
  - AutoStick General Information . . . . .170
- Fuel Requirements . . . . .171
  - Spark Knock . . . . .171
  - Reformulated Gasoline . . . . .172
  - Gasoline/Oxygenate Blends . . . . .172
  - MMT In Gasoline . . . . .173
  - Materials Added To Fuel . . . . .173
  - Fuel System Cautions . . . . .173
  - Carbon Monoxide Warnings . . . . .174
- Flexible Fuel— (Fleet Vehicles Only) . . . . .175
  - E-85 General Information . . . . .175
  - Ethanol Fuel (E-85) . . . . .175

□ Fuel Requirements . . . . .	175	■ Vehicle Loading . . . . .	178
□ Selection Of Engine Oil For Flexible Fuel Vehicles (E-85) And Gasoline Vehicles . . . . .	176	■ Trailer Towing . . . . .	178
□ Starting . . . . .	176	□ Common Towing Definitions . . . . .	178
□ Cruising Range . . . . .	176	□ Trailer Hitch Classification . . . . .	180
□ Replacement Parts . . . . .	176	□ Trailer Towing Weights (Maximum Trailer Weight Ratings) . . . . .	181
□ Maintenance . . . . .	176	□ Trailer And Tongue Weight . . . . .	181
■ Adding Fuel . . . . .	177	□ Towing Requirements . . . . .	182
□ Fuel Filler Cap (Gas Cap) . . . . .	177	□ Towing Tips . . . . .	186

**STARTING PROCEDURES**

Before starting your vehicle, adjust your seat, adjust both inside and outside mirrors, and fasten your seat belts.

**CAUTION!**

Long periods of engine idling, especially at high engine speeds can cause excessive exhaust temperatures which can damage your vehicle. Do not leave your vehicle unattended with the engine running.

**WARNING!**

Do not leave children or animals inside parked vehicles in hot weather. Interior heat build up may cause serious injury or death.

**Automatic Transaxle**

The gear selector must be in the NEUTRAL or PARK position before you can start the engine. Apply the brakes before shifting to any driving gear.

**Manual Transaxle**

Fully apply the parking brake, press the clutch pedal to the floor and place the gear selector in NEUTRAL before starting the engine.

**Normal Starting**

Normal Starting of either a cold or a warm engine does not require pumping or depressing the accelerator pedal. Simply turn the key to the "START" position and release when the engine starts. If the engine has not started within 3 seconds, slightly depress the accelerator pedal while continuing to crank. If the engine fails to start within 15 seconds, turn the key to the "OFF" position, wait 10 to 15 seconds, then repeat the normal starting procedure.

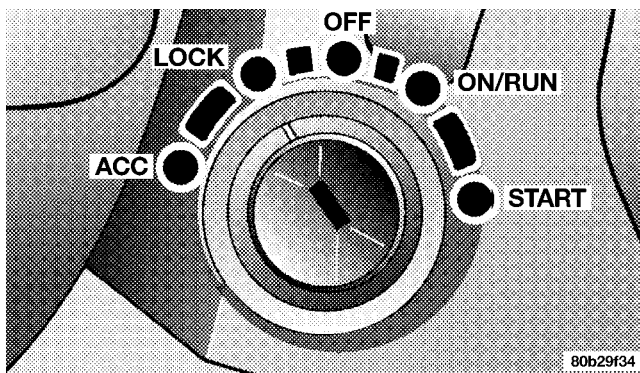

Ignition Key Positions

**WARNING!**

Never pour fuel or other flammable liquid into the throttle body air inlet opening in an attempt to start the vehicle. This could result in flash fire causing serious personal injury.

**CAUTION!**

Do not attempt to push or tow your vehicle to get it started. Vehicles equipped with an automatic trans-axle cannot be started this way. Unburned fuel could enter the catalytic converter and once the engine has started, ignite and damage the converter and vehicle. If the vehicle has a discharged battery, booster cables may be used to obtain a start from another vehicle. This type of start can be dangerous if done improperly, so follow the procedure carefully. See section 6 of this manual for jump starting instructions.

**Extreme Cold Weather (below -20°F or -29°C)**

To insure reliable starting at these temperatures, use of an externally powered electric engine block heater and battery blanket heater package (available from your dealer) is recommended.

**If Engine Fails to Start**

If the engine fails to start after you have followed the "NORMAL STARTING" or "EXTREME COLD WEATHER" procedures, it may be flooded. Push the accelerator pedal all the way to the floor and hold it there while cranking the engine. This should clear any excess fuel in case the engine is flooded.

**CAUTION!**

To prevent damage to the starter, do not crank the engine for more than 15 seconds at a time. Wait 10 to 15 seconds before trying again.

If the engine has been flooded, it may start to run, but not have enough power to continue running when the key is released. If this occurs, continue cranking with the accelerator pedal pushed all the way to the floor. Release the accelerator pedal and the key once the engine is running smoothly.

If the engine shows no sign of starting after two 15 second periods of cranking with the accelerator pedal held to the floor, the "NORMAL STARTING" or "EXTREME COLD WEATHER" procedure should be repeated.

**After Starting**

The idle speed will automatically decrease as the engine warms up. At cooler ambient temperatures, the idle speed for the 2.7L engine may increase during extended idles for improved heater performance.

**BATTERY AND ENGINE BLOCK HEATERS — If EQUIPPED**

The engine block heater warms engine coolant and permits quicker starts in cold weather. Connect the cord to a standard 110-115 volt AC electrical outlet with a grounded, three wire extension cord. The engine block heater cord is found under the hood near the air cleaner housing.

**WARNING!**

Remember to disconnect the cord before driving. Damage to the 110-115 volt AC electrical cord could cause electrocution.

Use the heater when temperatures below 0°F (-18°C) are expected to last for several days.

**AUTOMATIC TRANSAXLE****Brake/Transmission Interlock**

This interlock system prevents you from moving the gear selector out of the Park position unless the brake pedal is pressed. The system is active when the ignition switch is in the RUN position.

**WARNING!**

Unintended movement of a vehicle could injure those in and near the vehicle. As with all vehicles, you should never exit a vehicle while the engine is running. Before exiting a vehicle you should shift the transmission into Park, remove the key from the ignition, and apply the park brake. Once the key is removed from the ignition the transmission shift lever is locked in the Park position, securing the vehicle against unwanted movement. Furthermore, you should never leave children unattended inside a vehicle. The following indicators should be used to ensure that you have engaged the transmission shift lever into the "Park" position:

- When shifting into Park, depress the button on the shift lever and firmly move the lever all the way forward until it stops.
- Look at the shift indicator window on the console to ensure it is in the "P" position.
- When engaged in Park you will not be able to move the shifter rearward without depressing the shift lever button.

**CAUTION!**

Damage to the transaxle may occur if the following precautions are not observed:

- Shift into PARK only after the vehicle has come to a complete stop.
- Shift into or out of REVERSE only after the vehicle has come to a complete stop and the engine is at idle speed.
- Do not shift from REVERSE, PARK, or NEUTRAL into any forward gear when the engine is above idle speed.
- Before shifting into any gear, make sure your foot is firmly on the brake pedal.

**WARNING!**

It is dangerous to shift the selector lever out of "P" or "N" if the engine speed is higher than idle speed. If your foot is not firmly on the brake pedal, the vehicle could accelerate quickly forward or in reverse. You could lose control of the vehicle and hit someone or something. Only shift into gear when the engine is idling normally and when your right foot is firmly on the brake pedal.

**Automatic Transaxle Ignition Interlock System**

This system prevents the key from being removed unless the shift lever is in PARK and the shift knob push-button is out. It also prevents shifting out of PARK unless the key is in the OFF or RUN positions.

**NOTE:** If a malfunction occurs, the system may trap the key in the ignition cylinder to warn you that this safety feature is inoperable. The engine can be started and stopped but the key cannot be removed until you obtain service.



### Four Speed Automatic Transaxle

The electronically controlled transaxle provides a precise shift schedule. The transaxle electronics are self calibrating; therefore, the first few shifts on a new vehicle may be somewhat abrupt. This is a normal condition, and precision shifts will develop within a few shift cycles.

#### Reset Mode

The transaxle is monitored electronically for abnormal conditions. If a condition is detected that could cause damage, the transaxle shifts automatically into second gear. The transaxle remains in second gear despite the forward gear selected. Park (P), Reverse (R), and Neutral (N) will continue to operate. This Reset feature allows the vehicle to be driven to a dealer for service without damaging the transaxle.

In the event that the problem has been momentary, the transaxle can be reset to regain all forward gears.

Stop the vehicle and shift into Park (P).

Turn the Key to LOCK then restart the engine.

Shift into D and resume driving.

**NOTE:** Even if the transaxle can be reset, it is recommended that you visit a dealer at your earliest possible convenience. Your dealer has diagnostic equipment to determine if the problem could recur.

If the transaxle cannot be reset, dealer service is required.

### Gear Ranges For Four Speed Automatic Transaxle

DO NOT race the engine when shifting from PARK or NEUTRAL positions into another gear range.

**NOTE:** If the key is in the RUN position, you must press the brake pedal to shift out of the "P" Park position.

#### "P" Park

Supplements parking by locking the transaxle. Engine can be started in this range. Never attempt to use PARK while vehicle is in motion.

Apply parking brake when leaving the vehicle in this range.

**WARNING!**

Your vehicle could move and injure you and others if it is not completely in P (Park). Check by trying to move the gearshift lever back and forth without depressing the shift button after you have set it in P. Make sure it is in Park before leaving the vehicle.

**WARNING!**

Never use the Park position as a substitute for the parking brake. Always apply the parking brake fully when parked to guard against vehicle movement and possible injury or damage.

**"R" Reverse**

Shift into this range only after the vehicle has come to a complete stop.

**"N" Neutral**

Engine may be started in this range.

**"D" Overdrive**

This range should be used for most city and highway driving. It provides smoothest up shifts and down shifts and best fuel economy.

When frequent transaxle shifting occurs while using the Overdrive range, such as when operating the vehicle under heavy loading conditions (in hilly terrain, traveling into strong head winds, or while towing heavy trailers), use the "3" range.

**"3" Drive**

This range eliminates shifts into Overdrive. The transaxle will operate normally in first and second while in this range.

A delayed shift from second to third will occur at speeds of about 31 to 38 mph (50 to 60 km/h) and low levels of accelerator pedal travel. An early down-shift from third to second will occur at a speed of about 34 to 30 mph (54 to 48 km/h). This is done to provide second gear engine braking at speeds less than 30 mph (48 km/h).

**NOTE:** Using the “3” range while operating the vehicle under heavy operating conditions will improve performance, fuel economy, and extend transaxle life by reducing excessive shifting and heat build up.

Use the “3” range when descending steep grades to prevent brake system distress.

#### “L” Low

This range should be used for maximum engine braking when descending steep grades. In this range, up shifts will occur only to prevent engine over speed while down shifts occur as early as possible.

#### WARNING!

Never use Park position on an automatic transmission as a substitute for the parking brake. Always apply parking brake fully when parked to guard against vehicle movement and possible injury or damage.

#### PARKING BRAKE

When the parking brake is applied with the **BRAKE** ignition on, the brake light in the instrument cluster will come on.

**NOTE:** This light only shows that the parking brake is on. It does not show the degree of brake application.

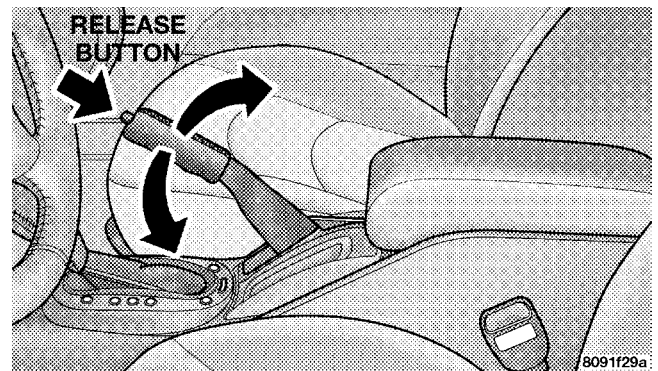

Parking Brake

Before leaving the vehicle, make sure that the parking brake is set. To set the parking brake, pull up firmly on the lever. Also place the gear selector in the Park position

for automatic transaxle vehicles, or reverse for vehicles with manual transaxle. To release the parking brake, apply the brake pedal and pull up on the parking brake lever. Push the release button and lower the lever fully.

When parking on a hill, it is important to set the parking brake before placing the gear selector in Park, otherwise the load on the transaxle locking mechanism may make it difficult to move the selector out of Park. As an added precaution, turn the front wheels toward the curb on a downhill grade and away from the curb on a uphill grade.

You should always apply the parking brake before leaving the vehicle.

**WARNING!**

- Leaving children in a vehicle unattended is dangerous for a number of reasons. A child or others could be injured. Children should be warned not to touch the parking brake or the gear selector. Don't leave the keys in the ignition. A child could operate power windows, other controls, or move the vehicle.
- Be sure the parking brake is fully disengaged before driving; failure to do so can lead to brake failure and an accident.

**BRAKE SYSTEM**

Your vehicle is equipped with power assisted brakes as standard equipment. In the event power assist is lost for any reason (for example, repeated brake applications with the engine off), the brakes will still function. The effort required to brake the vehicle will be much greater than that required with the power system operating.

**WARNING!**

**Riding the brakes can lead to brake failure and possibly an accident. Driving with your foot resting or riding on the brake pedal can result in abnormally high brake temperatures, excessive lining wear, and possible brake damage. You wouldn't have your full braking capacity in an emergency.**

If either of the two hydraulic systems lose normal capability, the remaining system will still function with some loss of overall braking effectiveness. This will be evident by increased pedal travel during application and greater pedal force required to slow or stop.

**Anti-Lock Brake System (ABS) — If Equipped**

The ABS gives increased vehicle stability and brake performance under most braking conditions. The system automatically “pumps” the brakes during severe braking conditions to prevent wheel lock-up.

All vehicle wheels and tires must be the same size and tires must be properly inflated to produce accurate signals for the ABS computer. However, the system will compensate when the compact spare is in use.

During stops where ABS is activated, a vibration of the brake pedal may be felt and associated system noises may be heard.

**WARNING!**

**Pumping of the brake pedal will diminish the effectiveness of Anti-lock brakes and may lead to an accident. Pumping makes the stopping distance longer. Just press firmly on your brake pedal when you need to slow down or stop.**

**WARNING!**

- Anti-lock system (ABS) cannot prevent the natural laws of physics from acting on the vehicle, nor can it increase braking or steering efficiency beyond that afforded by the condition of the vehicle brakes and tires or the traction afforded.
- The ABS cannot prevent accidents, including those resulting from excessive speed in turns, following another vehicle too closely, or hydroplaning. Only a safe, attentive, and skillful driver can prevent accidents.
- The capabilities of an ABS equipped vehicle must never be exploited in a reckless or dangerous manner which could jeopardize the user's safety or the safety of others.

**POWER STEERING**

The power assisted steering system of your vehicle provides mechanical steering capability in the event power assist is lost.

If for some reason the hydraulic pressure is interrupted, it will still be possible to steer your vehicle. Under these conditions you will observe a substantial increase in steering effort.

**TRACTION CONTROL — IF EQUIPPED**

The Traction Control System will improve acceleration and steering on slippery surfaces by reducing tire spin. The system reduces wheel slip and maintains traction at the driving (front) wheels by engaging the brake on the wheel that is losing traction. When this occurs the traction control indicator light located in the instrument cluster will flash. The system operates at speeds below 35 mph (56 km/h).

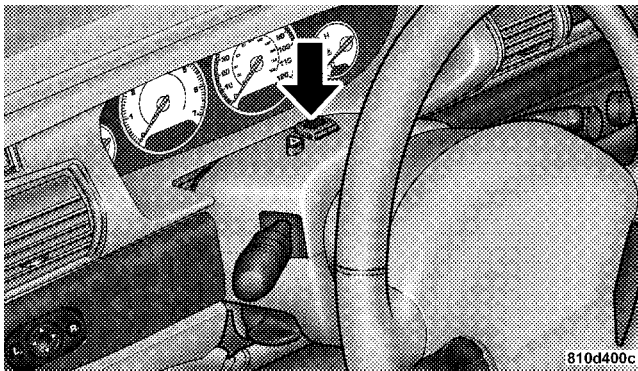

#### Traction Control Switch

A push-button located on the top of the steering column turns the Traction Control System ON or OFF.

The system is always in the “ON” mode unless:

- The traction control switch has been used to turn the system off;

- There is a Anti-Lock Brake System malfunction;
- There is a Traction Control System malfunction;
- The system has been automatically deactivated to prevent damage to the brake system due to overheated brake temperatures.

**NOTE:** Extended heavy use of Traction Control may cause the system to deactivate and turn on the traction control light located in the instrument cluster.

This is to prevent overheating of the brake system and is a normal condition. The system will remain disabled for about 4 minutes until the brakes have cooled. The system will automatically reactivate and turn off the traction control light.

If your vehicle becomes stuck in mud, ice, or snow, turn the Traction Control System Off before attempting to “rock” the vehicle free.

## TIRE SAFETY INFORMATION

### Tire Markings

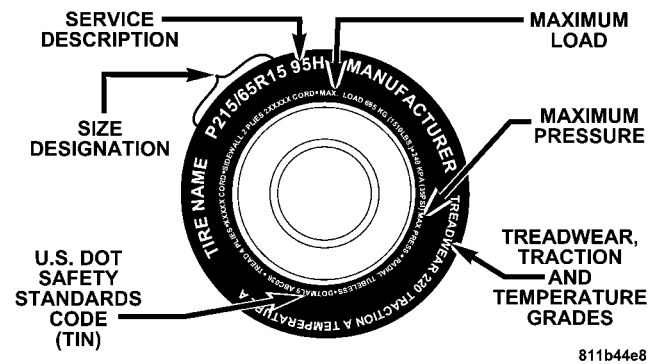

#### NOTE:

- P (Passenger)-Metric tire sizing is based on U.S. design standards. P-Metric tires have the letter "P" molded into the sidewall preceding the size designation. Example: P215/65R15 95H.

- European Metric tire sizing is based on European design standards. Tires designed to this standard have the tire size molded into the sidewall beginning with the section width. The letter "P" is absent from this tire size designation. Example: 215/65R15 96H
- LT (Light Truck)-Metric tire sizing is based on U.S. design standards. The size designation for LT-Metric tires is the same as for P-Metric tires except for the letters "LT" that are molded into the sidewall preceding the size designation. Example: LT235/85R16.
- Temporary Spare tires are high pressure compact spares designed for temporary emergency use only. Tires designed to this standard have the letter "T" molded into the sidewall preceding the size designation. Example: T145/80D18 103M.
- High Flotation tire sizing is based on U.S. design standards and begins with the tire diameter molded into the sidewall. Example: 31x10.5 R15 LT.



## Tire Sizing Chart

EXAMPLE:	
<b>Size Designation:</b>	<p>P = Passenger car tire size based on U.S. design standards</p> <p>"...blank..." = Passenger car tire based on European design standards</p> <p>LT = Light Truck tire based on U.S. design standards</p> <p>T = Temporary Spare tire</p> <p>31 = Overall Diameter in Inches (in)</p>
	215 = Section Width in Millimeters (mm)
	<p>65 = Aspect Ratio in Percent (%)</p> <p style="padding-left: 40px;">—Ratio of section height to section width of tire.</p>
	10.5 = Section Width in Inches (in)
	<p>R = Construction Code</p> <p style="padding-left: 40px;">—"R" means Radial Construction.</p> <p style="padding-left: 40px;">—"D" means Diagonal or Bias Construction.</p>
	15 = Rim Diameter in Inches (in)
<b>Service Description:</b>	<p>95 = Load Index</p> <p style="padding-left: 40px;">—A numerical code associated with the maximum load a tire can carry.</p>

<b>EXAMPLE:</b>	
<b>H = Speed Symbol</b>	<p>—A symbol indicating the range of speeds at which a tire can carry a load corresponding to its load index under certain operating conditions.</p> <p>—The maximum speed corresponding to the Speed Symbol should only be achieved under specified operating conditions. (i.e. tire pressure, vehicle loading, road conditions and posted speed limits).</p>
<b>Load Identification:</b>	
	"...blank..." = Absence of any text on sidewall of the tire indicates a Standard Load (SL) Tire
	<b>Extra Load (XL)</b> = Extra Load (or Reinforced) Tire
	<b>Light Load</b> = Light Load Tire
	<b>C,D,E</b> = Load range associated with the maximum load a tire can carry at a specified pressure
<b>Maximum Load</b> — Maximum Load indicates the maximum load this tire is designed to carry.	
<b>Maximum Pressure</b> — Maximum Pressure indicates the maximum permissible cold tire inflation pressure for this tire.	

**Tire Identification Number (TIN)**

The TIN may be found on one or both sides of the tire however the date code may only be on one side. Tires with white sidewalls will have the full TIN including date code located on the white sidewall side of the tire.

Look for the TIN on the outboard side of black sidewall tires as mounted on the vehicle. If the TIN is not found on the outboard side then you will find it on the inboard side of the tire.

<b>EXAMPLE:</b>
<b>DOT MA L9 ABCD 0301</b>
<b>DOT</b> = Department of Transportation —This symbol certifies that the tire is in compliance with the U.S. Department of Transportation tire safety standards, and is approved for highway use.
<b>MA</b> = Code representing the tire manufacturing location. (2 digits)
<b>L9</b> = Code representing the tire size. (2 digits)
<b>ABCD</b> = Code used by tire manufacturer. (1 to 4 digits)
<b>03</b> = Number representing the week in which the tire was manufactured. (2 digits) —03 means the 3rd week.
<b>01</b> = Number representing the year in which the tire was manufactured. (2 digits) —01 means the year 2001. —Prior to July 2000, tire manufacturers were only required to have 1 number to represent the year in which the tire was manufactured. Example: 031 could represent the 3rd week of 1981 or 1991.

### Tire Loading and Tire Pressure

#### Tire Placard Location

**NOTE:** The proper cold tire inflation pressure is listed on either the face of the driver's door or the driver's side "B" pillar.

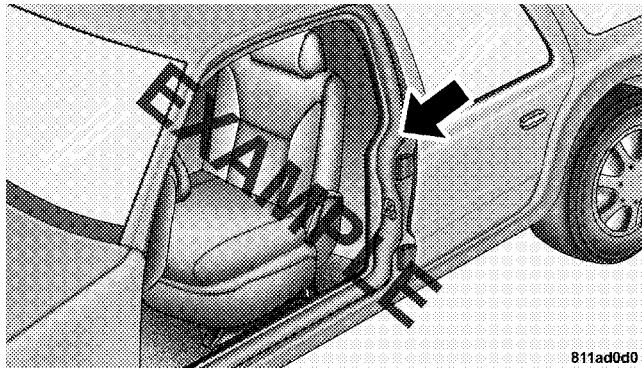

Tire Placard Location

### Tire and Loading Information Placard

**TIRE AND LOADING INFORMATION**

SEATING CAPACITY - TOTAL 5 FRONT 2 REAR 3

THE COMBINED WEIGHT OF OCCUPANTS AND CARGO SHOULD NEVER EXCEED XXX KG OR XXX LBS

TIRE	FRONT	REAR	SPARE
ORIGINAL TIRE SIZE	P195/70R14	P195/70R14	T125/70D15
COLD TIRE INFLATION PRESSURE	200kPa, 29PSI	200kPa, 29PSI	420kPa, 60PSI

SEE OWNER'S MANUAL FOR ADDITIONAL INFORMATION

4N109268

811b5a9a

#### Tire and Loading Information

This placard tells you important information about the:

- 1) number of people that can be carried in the vehicle
- 2) the total weight your vehicle can carry
- 3) the tire size designed for your vehicle
- 4) the cold tire inflation pressures for the front, rear and spare tires.

### Loading

The vehicle maximum load on the tire must not exceed the load carrying capacity of the tire on your vehicle. You will not exceed the tire's load carrying capacity if you adhere to the loading conditions, tire size, and cold tire inflation pressures specified on the "Tire and Loading Information" placard and in the "Vehicle Loading" section of this manual.

**NOTE:** Under a maximum loaded vehicle condition, gross axle weight ratings (GAWR's) for the front and rear axles must not be exceeded. For further information on GAWR's, vehicle loading, and trailer towing, refer to the "Vehicle Loading" section of this manual.

To determine the maximum loading conditions of your vehicle, locate the statement "The combined weight of occupants and cargo should never exceed XXX kg or XXX lbs." on the Tire and Loading Information placard. The combined weight of occupants, cargo/luggage and trailer tongue weight (if applicable) should never exceed the weight referenced here.

### *Steps for Determining Correct Load Limit*

1. Locate the statement "The combined weight of occupants and cargo should never exceed XXX pounds" on your vehicle's placard.
2. Determine the combined weight of the driver and passengers that will be riding in your vehicle.
3. Subtract the combined weight of the driver and passengers from XXX kilograms or XXX pounds.
4. The resulting figure equals the available amount of cargo and luggage load capacity. For example, if "XXX" amount equals 1400 lbs. and there will be five 150 lb. passengers in your vehicle, the amount of available cargo and luggage load capacity is 650 lb. (since  $5 \times 150 = 750$ , and  $1400 - 750 = 650$  lb.)
5. Determine the combined weight of luggage and cargo being loaded on the vehicle. That weight may not safely exceed the available cargo and luggage load capacity calculated in Step 4.

6. If your vehicle will be towing a trailer, load from your trailer will be transferred to your vehicle. Consult this manual to determine how this reduces the available cargo and luggage load capacity of your vehicle.

**NOTE:** The following table shows examples on how to calculate total load, cargo/luggage and towing capacities of your vehicle with varying seating configurations and

number and size of occupants. This table is for illustration purposes only and may not be accurate for the seating and load carry capacity of your vehicle.

**NOTE:** For the following example the combined weight of occupants and cargo should never exceed 865 lbs. (392 Kg).

Occupants			Combined weight of occupants and cargo from Tire Placard	MINUS	Combined Occupant's weight	=	AVAILABLE Cargo/Luggage and Trailer Tongue Weight
TOTAL	FRONT	REAR					
<b>EXAMPLE 1</b>			865 lbs	minus	670 lbs	=	195 lbs
5	2	3					
<b>EXAMPLE 2</b>			865 lbs	minus	540 lbs	=	325 lbs
3	2	1					
<b>EXAMPLE 3</b>			865 lbs	minus	400 lbs	=	465 lbs
2	2	0					

EXAMPLE

**WARNING!**

Overloading of your tires is dangerous. Overloading can cause tire failure, affect vehicle handling, and increase your stopping distance. Use tires of the recommended load capacity for your vehicle. Never overload them.

**TIRES—GENERAL INFORMATION****Tire Pressure**

Proper tire inflation pressure is essential to the safe and satisfactory operation of your vehicle. Three primary areas are affected by improper tire pressure:

*1. Safety—***WARNING!**

Improperly inflated tires are dangerous and can cause accidents.

- Under inflation increases tire flexing and can result in tire failure.
- Over inflation reduces a tire's ability to cushion shock. Objects on the road and chuck holes can cause damage that results in tire failure.
- Unequal tire pressures can cause steering problems. You could lose control of your vehicle.
- Over inflated or under inflated tires can affect vehicle handling and can fail suddenly, resulting in loss of vehicle control.
- Unequal tire pressures from one side of the vehicle to the other can cause the vehicle to drift to the right or left.

Always drive with each tire inflated to the recommended cold tire inflation pressure.



### 2. *Economy*—

Improper inflation pressures can cause uneven wear patterns to develop across the tire tread. These abnormal wear patterns will reduce tread life resulting in a need for earlier tire replacement. Underinflation also increases tire rolling resistance and results in higher fuel consumption.

### 3. *Ride Comfort and Vehicle Stability*—

Proper tire inflation contributes to a comfortable ride. Overinflation produces a jarring and uncomfortable ride.

#### **Tire Inflation Pressures**

The proper cold tire inflation pressure is listed on either the face of the driver's door or the driver's side "B" pillar.

Some vehicles may have Supplemental Tire Pressure Information for vehicle loads that are less than the maximum loaded vehicle condition. These pressure conditions will be found in the "Supplemental Tire Pressure Information" section of this manual.

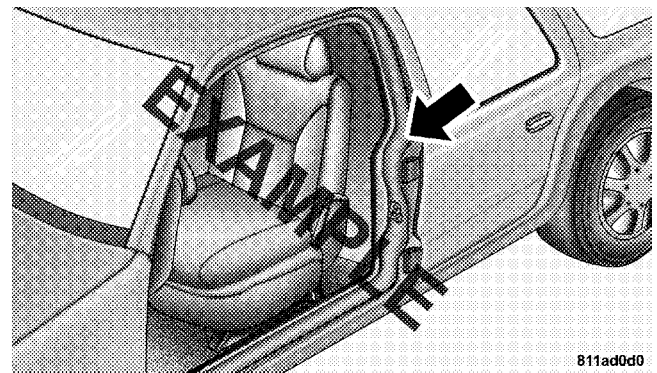

**Tire Placard Location**

The pressure should be checked and adjusted as well as inspecting for signs of tire wear or visible damage at least once a month. Use a good quality pocket-type gauge to check tire pressure. Do not make a visual judgement when determining proper inflation. Radial tires may look properly inflated even when they are under inflated.

**CAUTION!**

After inspecting or adjusting the tire pressure, always reinstall the valve stem cap—if equipped. This will prevent moisture and dirt from entering the valve stem, which could damage the valve stem.

Inflation pressures specified on the placard are always “cold tire inflation pressure”. Cold tire inflation pressure is defined as the tire pressure after the vehicle has not been driven for at least 3 hours, or driven less than 1 mile (1 km) after a 3 hour period. The cold tire inflation pressure must not exceed the maximum inflation pressure molded into the tire side wall.

Check tire pressures more often if subject to a wide range of outdoor temperatures, as tire pressures vary with temperature changes.

Tire pressures change by approximately 1 psi (7 kPa) per 12° F (7° C) of air temperature change. Keep this in mind when checking tire pressure inside a garage, especially in the winter.

Example: If garage temperature = 68° F (20° C) and the outside temperature = 32° F (0° C) then the cold tire inflation pressure should be increased by 3 psi (21 kPa), which equals 1 psi (7 kPa) for every 12° F (7° C) for this outside temperature condition.

Tire pressure may increase from 2 to 6 psi (13 to 40 kPa) during operation. DO NOT reduce this normal pressure build up or your tire pressure will be too low.

**Tire Pressures for High Speed Operation**

The manufacturer advocates driving at safe speeds within posted speed limits. Where speed limits or conditions are such that the vehicle can be driven at high speeds, maintaining correct tire inflation pressure is very important. Increased tire pressure and reduced vehicle loading may be required for high speed vehicle operation. Refer to original equipment or an authorized tire dealer for recommended safe operating speeds, loading and cold tire inflation pressures.

**WARNING!**

High speed driving with your vehicle under maximum load is dangerous. The added strain on your tires could cause them to fail. You could have a serious accident. Don't drive a vehicle loaded to the maximum capacity at continuous speeds above 75 mph (120 km/h).

**Radial-Ply Tires****WARNING!**

Combining radial ply tires with other types of tires on your vehicle will cause your vehicle to handle poorly. The instability could cause an accident. Always use radial ply tires in sets of four (or 6, in case of trucks with dual rear wheels). Never combine them with other types of tires.

Cuts and punctures in radial tires are repairable only in the tread area because of sidewall flexing. Consult your authorized tire dealer for radial tire repairs.

**Compact Spare Tire — If Equipped**

The compact spare is for temporary emergency use with radial tires. It is engineered to be used on your style vehicle only. Since this tire has limited tread life, the original tire should be repaired (or replaced) and reinstalled at the first opportunity.

**WARNING!**

Temporary use spare tires are for emergency use only. With these tires, do not drive more than 50 mph (80 km/h). Temporary-use spare tires have limited tread life. When the tread is worn to the tread wear indicators, the temporary use spare tire needs to be replaced. Be sure to follow the warnings which apply to your spare. Failure to do so could result in spare tire failure and loss of vehicle control.

Do not install a wheel cover or attempt to mount a conventional tire on the compact spare wheel, since the wheel is designed specifically for the compact spare.

Do not install more than one compact spare tire/wheel on the vehicle at any given time.

#### CAUTION!

Because of the reduced ground clearance, do not take your vehicle through an automatic car wash with the compact spare installed. Damage to the vehicle may result.

#### Limited Use Spare — If Equipped

The limited use spare tire is for temporary emergency use on your vehicle. This tire is identified by a limited use spare tire warning label located on the limited use spare tire and wheel assembly. This tire may look like the original equipped tire on the front or rear axle of your vehicle, but it is not. Installation of this limited use spare

tire affects vehicle handling. Since it is not the same tire, replace (or repair) the original tire and reinstall on the vehicle at the first opportunity.

#### WARNING!

The limited use spare tires are for emergency use only. Installation of this limited use spare tire affects vehicle handling. With this tire, do not drive more than 60 mph (100 km/h). Keep inflated to the cold tire inflation pressure listed on either your tire placard or limited use spare tire and wheel assembly. Replace (or repair) the original tire at the first opportunity and reinstall it on your vehicle. Failure to do so could result in loss of vehicle control.

#### Tire Spinning

When stuck in mud, sand, snow, or ice conditions, do not spin your vehicle's wheels above 35 mph (55 km/h).

See the paragraph on Freeing A Stuck Vehicle in Section 6 of this manual.

**WARNING!**

Fast spinning tires can be dangerous. Forces generated by excessive wheel speeds may cause tire damage or failure. A tire could explode and injure someone. Do not spin your vehicle's wheels faster than 35 mph (55 km/h) when you are stuck. And don't let anyone near a spinning wheel, no matter what the speed.

**Tread Wear Indicators**

Tread wear indicators are in the original equipment tires to help you in determining when your tires should be replaced.

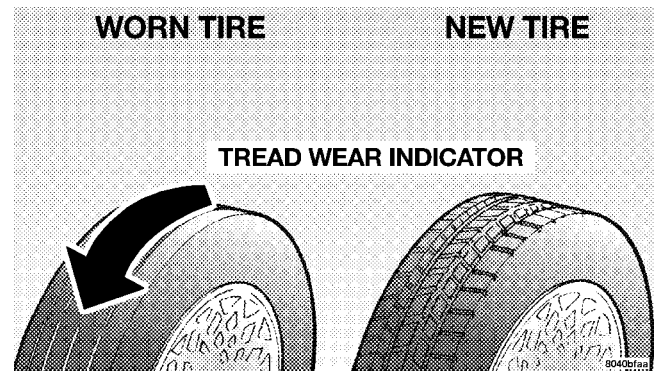

These indicators are molded into the bottom of the tread grooves and will appear as bands when the tread depth becomes 1/16 inch (2 mm). When the tread is worn to the tread wear indicators, the tire should be replaced.

Many states have laws requiring tire replacement at this point.

**Life of Tire**

The service life of a tire is dependent upon varying factors including but not limited to:

- Driving style
- Tire pressure
- Distance driven

**WARNING!**

**Tires and spare tire should be replaced after six years, regardless of the remaining tread. Failure to follow this warning can result in sudden tire failure. You could lose control and have an accident resulting in serious injury or death.**

Keep unmounted tires in a cool, dry place with as little exposure to light as possible. Protect tires from contact with oil, grease and gasoline.

**Replacement Tires**

The tires on your new vehicle provide a balance of many characteristics. They should be inspected regularly for wear and correct cold tire inflation pressure. The manufacturer strongly recommends that you use tires equivalent to the originals in size, quality and performance when replacement is needed (see the paragraph on tread wear indicators). Refer to the Tire and Loading Information placard for the size designation of your tire. The service description and load identification will be found on the original equipment tire. Failure to use equivalent replacement tires may adversely affect the safety, handling, and ride of your vehicle. We recommend that you contact your original equipment or an authorized tire dealer with any questions you may have on tire specifications or capability.

**WARNING!**

- Do not use a tire, wheel size or rating other than that specified for your vehicle. Some combinations of unapproved tires and wheels may change suspension dimensions and performance characteristics, resulting in changes to steering, handling, and braking of your vehicle. This can cause unpredictable handling and stress to steering and suspension components. You could lose control and have an accident resulting in serious injury or death. Use only the tire and wheel sizes with load ratings approved for your vehicle.
- Never use a tire with a smaller load index or capacity, other than what was originally equipped on your vehicle. Using a tire with a smaller load index could result in tire overloading and failure. You could lose control and have an accident.
- Failure to equip your vehicle with tires having adequate speed capability can result in sudden tire failure and loss of vehicle control.

**CAUTION!**

Replacing original tires with tires of a different size may result in false speedometer and odometer readings.

**Alignment And Balance**

Poor suspension alignment may result in:

- Fast tire wear.
- Uneven tire wear, such as feathering and one-sided wear.
- Vehicle pull to right or left.

Tires may also cause the vehicle to pull to the left or right. Alignment will not correct this condition. See your dealer for proper diagnosis.

Improper alignment will not cause vehicle vibration. Vibration may be a result of tire and wheel out-of-balance. Proper balancing will reduce vibration and avoid tire cupping and spotty wear.

**TIRE CHAINS**

Due to limited clearance, tire chains are not recommended.

**CAUTION!**

Damage to the vehicle may result if tire chains are used.

**SNOW TIRES**

Some areas of the country require the use of snow tires during winter. Standard tires are of the all season type and satisfy this requirement as indicated by the M+S designation on the tire side wall.

If you need snow tires, select tires equivalent in size and type to the original equipment tires. Use snow tires only in sets of 4, failure to do so may adversely affect the safety and handling of your vehicle.

Snow tires generally have lower speed ratings than what was originally equipped with your vehicle and should not be operated at sustained speeds over 75 mph (120 km/h).

**Tire Rotation Recommendations**

Tires on the front and rear axles of vehicles operate at different loads and perform different steering, driving and braking functions. For these reasons, they wear at unequal rates, and tend to develop irregular wear patterns.

These effects can be reduced by timely rotation of tires. The benefits of rotation are especially worthwhile with aggressive tread designs such as those on all season type tires. Rotation will increase tread life, help to maintain mud, snow and wet traction levels, and contribute to a smooth, quiet ride.



Follow the recommended tire rotation frequency for your type of driving found in the “Maintenance Schedules” Section of this manual. More frequent rotation is permissible if desired. The reasons for any rapid or unusual wear should be corrected before rotating. The suggested rotation method is the “forward-cross” shown in the diagram.

#### TIRE ROTATION PATTERN

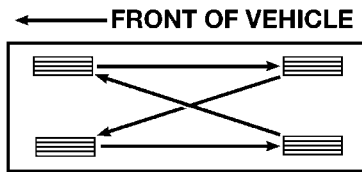

4 TIRE ROTATION

80ba79fe

#### AUTOSTICK — IF EQUIPPED

Autostick is a driver-interactive transaxle that offers manual gear shifting capability to provide you with more control. Autostick allows you to maximize engine braking, eliminate undesirable upshifts and downshifts, and improve overall vehicle performance. This system can also provide you with more control during passing, city driving, cold slippery conditions, mountain driving, trailer towing, and many other situations.

### Autostick Operation

The Autostick position is just below the Overdrive position and is identified by the word "AUTOSTICK". When you place the shift lever in the Autostick position, it can be moved from side to side. Moving the lever to the left (-) triggers a downshift and to the right (+) an upshift. The gear position will be shown in the transmission gear display.

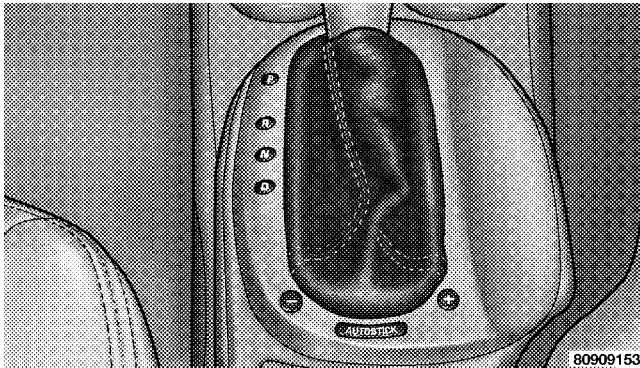

Gear Selector

You can shift in or out of the autostick mode at any time without taking your foot off the accelerator pedal. If you choose the Overdrive mode, the transaxle will operate automatically; shifting between the four available gears. When you wish to engage autostick, simply move the autostick lever to the AUTOSTICK position. The transaxle will remain in the current gear until an upshift or downshift is chosen.

Move the lever back to the Overdrive position to shift out of the Autostick mode.

### Autostick General Information

- The transaxle will automatically upshift from first to second gear and from second to third gear when engine speed reaches about 6300 RPM.
- Downshifts from third to second gear above 66 mph (106 km/h) and from second to first gear above 37 mph (60 km/h) will be ignored.
- You can start out in first, second, or third gear. Shifting into fourth gear can occur only after vehicle speed reaches 15 mph (24 km/h).

- The transaxle will automatically downshift to first gear when coming to a stop.
- Starting out in third gear is helpful in snowy or icy conditions.
- While in the Autostick mode, Speed Control will only function in third or fourth gear. Downshifting out of third gear turns off speed control.
- If the system detects powertrain overheating, the transaxle will revert to the automatic shift mode and remain in that mode until the powertrain cools off.
- If the system detects a problem it will disable the Autostick mode and the transaxle will return to the automatic mode until the problem is corrected.

### FUEL REQUIREMENTS



Your vehicle is designed to meet all emission regulations and provide excellent fuel economy when using high quality regular unleaded gasoline with an octane rating of 87. The use of premium gasoline is not recommended. The use of premium gasoline will provide no benefit over high quality regular gasolines, and in some circumstances, may result in poorer performance.

### Spark Knock

Light spark knock at low engine speeds is not harmful to your engine. However, continued heavy spark knock at high speeds can cause damage and immediate service is required.

Poor quality gasoline can cause problems such as hard starting, stalling and hesitations. If you experience these symptoms, try another brand of "regular" gasoline before considering service for the vehicle.

Over 40 automobile manufacturers around the world have issued and endorsed consistent gasoline specifications (the World Wide Fuel Charter, WWFC) to define fuel properties necessary to deliver enhanced emissions, engine performance, and durability for your vehicle. The manufacturer recommends the use of gasolines that meet the WWFC specifications if they are available.

#### **Reformulated Gasoline**

Many areas of the country require the use of cleaner burning fuel referred to as "Reformulated Gasoline".

Reformulated gasolines contain oxygenates, and are specially blended to reduce vehicle emissions and improve air quality.

The manufacturer supports the use of reformulated gasolines. Properly blended reformulated gasolines will provide excellent performance and durability of engine and fuel system components.

#### **Gasoline/Oxygenate Blends**

Some fuel suppliers blend unleaded gasoline with materials called oxygenates such as 10% ethanol, MTBE and ETBE. Oxygenates are required in some areas of the country during the winter months to reduce carbon monoxide emissions. Fuels blended with these oxygenates may be used in your vehicle.

#### **CAUTION!**

**DO NOT use gasolines containing Methanol. Use of these blends may result in starting and driveability problems and may damage critical fuel system components.**

Problems that result from using methanol/gasoline blends are not the responsibility of the manufacturer. While MTBE is an oxygenate made from Methanol, it does not have the negative effects of Methanol.

### MMT in Gasoline

MMT is a manganese containing metallic additive that is blended into some gasoline to increase the octane number. Gasolines blended with MMT offer no performance advantage beyond gasolines of the same octane number without MMT. Gasolines blended with MMT have shown to reduce spark plug life and reduce emission system performance in some vehicles. The manufacturer recommends using gasolines without MMT. Since the MMT content of gasoline may not be indicated on the pump, you should ask your gasoline retailer whether or not his/her gasoline contains MMT.

It is even more important to look for gasolines without MMT in Canada because MMT can be used at higher levels than allowed in the United States.

MMT is prohibited in both Federal and California reformulated gasolines.

### Materials Added to Fuel

All gasoline sold in the United States is required to contain effective detergent additives. Use of additional detergents or other additives is not needed under normal conditions and would result in additional cost. Therefore you should not have to add anything to the fuel.

### Fuel System Cautions

<b>CAUTION!</b>
<p><b>Follow these guidelines to maintain your vehicle's performance:</b></p> <ul style="list-style-type: none"> <li>• The use of leaded gas is prohibited by Federal law. Using leaded gasoline can impair engine performance, or damage the emission control system.</li> <li>• An out-of-tune engine, or certain fuel or ignition malfunctions, can cause the catalytic converter to overheat. If you notice a pungent burning odor or some light smoke, your engine may be out-of-tune or</li> </ul>

malfunctioning and may require immediate service. Contact your dealer for service assistance.

- The use of fuel additives which are now being sold as octane enhancers are not recommended. Most of these products contain high concentrations of methanol. Fuel system damage or vehicle performance problems resulting from the use of such fuels or additives are not the responsibility of the manufacturer.

**NOTE:** Intentional tampering with emissions control systems can result in civil penalties being assessed against you.

### Carbon Monoxide Warnings

WARNING!
Carbon monoxide (CO) in exhaust gases is deadly. Follow the precautions below to prevent carbon monoxide poisoning:

- Do not inhale exhaust gases. They contain carbon monoxide, a colorless and odorless gas which can kill. Never run the engine in a closed area, such as a garage, and never sit in a parked vehicle with the engine running for an extended period. If the vehicle is stopped in an open area with the engine running for more than a short period, adjust the ventilation system to force fresh, outside air into the vehicle.
- Guard against carbon monoxide with proper maintenance. Have the exhaust system inspected every time the vehicle is raised. Have any abnormal conditions repaired promptly. Until repaired, drive with all side windows fully open.
- Keep the trunk closed when driving your vehicle to prevent carbon monoxide and other poisonous exhaust gases from entering the vehicle.

**FLEXIBLE FUEL— (Fleet Vehicles Only)****E-85 General Information**

The information in this section is for Flexible Fuel vehicles only. These vehicles can be identified by the unique fuel filler door label that states **Ethanol (E-85) or Unleaded Gasoline Only**. This section only covers those subjects that are unique to these vehicles. Please refer to the other sections of this manual for information on features that are common between Flexible Fuel and gasoline only powered vehicles.

**CAUTION!**

Only vehicles with the E-85 fuel filler door label can operate on E-85.

**ETHANOL FUEL (E-85)**

E-85 is a mixture of approximately 85% fuel ethanol and 15% unleaded gasoline.

**WARNING!**

Ethanol vapors are extremely flammable and could cause serious personal injury. Never have any smoking materials lit in or near the vehicle when removing the fuel filler tube cap (gas cap) or filling the tank. Do not use E-85 as a cleaning agent and never use it near an open flame.

**5****Fuel Requirements**

Your vehicle will operate on both unleaded gasoline with an octane rating of 87, or E-85 fuel, or any mixture of these two.

For best results, a refueling pattern that alternates between E-85 and unleaded gasoline should be avoided. When you do switch fuels, it is recommended that

- you do not switch when the fuel gauge indicates less than 1/4 full
- you do not add less than 5 gallons when refueling
- you operate the vehicle immediately after refueling for a period of at least 5 minutes

Observing these precautions will avoid possible hard starting and/or significant deterioration in drivability during warm up.

**NOTE:** When the ambient temperature is above 90°F, you may experience hard starting and rough idle following start up even if the above recommendations are followed.

#### **Selection Of Engine Oil For Flexible Fuel Vehicles (E-85) and Gasoline Vehicles**

Whether operating the vehicle on an E-85 ethanol fuel or unleaded gasoline the engine oil requirements are the same. Refer to "Engine Oil Selection in the "Maintenance Procedures" section of this manual for the proper quality and viscosity engine oil.

#### **Starting**

The characteristics of E-85 fuel make it unsuitable for use when ambient temperatures fall below 0°F. In the range of 0°F to 32°F, you may experience an increase in the time it takes for your engine to start, and a deterioration in drivability (sags and/or hesitations) until the engine is fully warmed up.

#### **Cruising Range**

Because E-85 fuel contains less energy per gallon than gasoline, you will experience an increase in fuel consumption. You can expect your MPG and your driving range to decrease by about 30% compared to gasoline operation.

#### **Replacement Parts**

Many components in your Flexible Fuel Vehicle (FFV) are designed to be compatible with ethanol. Always be sure that your vehicle is serviced with correct ethanol compatible parts.

<b>CAUTION!</b>
<b>Replacing fuel system components with non-ethanol compatible components can damage your vehicle.</b>

#### **Maintenance**

If you operate the vehicle using E-85 fuel, follow Schedule B in the maintenance schedule section of this manual.



**CAUTION!**

Do not use ethanol mixture greater than 85% in your vehicle. It will cause difficulty in cold starting and may affect driveability.

**ADDING FUEL****Fuel Filler Cap (Gas Cap)**

The gas cap is behind the fuel filler door, on the driver's side of the vehicle. If the gas cap is lost or damaged, be sure the replacement cap is for use with this vehicle.

**CAUTION!**

Damage to the fuel system or emission control system could result from using an improper fuel tank filler tube cap (gas cap). A poorly fitting cap could let impurities into the fuel system.

**CAUTION!**

To avoid fuel spillage and overfilling, do not "top off" the fuel tank after filling.

**NOTE:** Tighten the gas cap until you hear a "clicking" sound. This is an indication that the gas cap is properly tightened.

The Malfunction Indicator Light will come on if the gas cap is not properly secured. Make sure that the gas cap is tightened each time the vehicle is refueled.

**NOTE:** When the fuel nozzle "clicks" or shuts off, the fuel tank is full.

**NOTE:** The fuel tank filler tube may have a restricting door about 50 mm (2 inches) down from the opening. If fuel is poured from a portable container, the container should have a flexible nozzle long enough to force open the restricting door.

**CAUTION!**

A poorly fitting gas cap may cause the Malfunction Indicator Lamp to turn on.

**WARNING!**

- Never have any smoking materials lit in or near the vehicle when the gas cap is removed or the tank filled.
- Never add fuel to the vehicle when the engine is running.
- A fire may result if gasoline is pumped into a portable container that is inside of a vehicle. You could be burned. Always place gas containers on the ground while filling.

**VEHICLE LOADING**

Vehicle Loading Capacities

Front Seat Occupants . . . . . 2

Rear Seat Occupants . . . . . 3

Luggage . . . . . 115 lbs. (52 kg)

Rated Vehicle Capacity . . . . . 865 lbs. ( 392 kg)

**TRAILER TOWING**

In this section you will find safety tips and information on limits to the type of towing you can reasonably do with your vehicle. Before towing a trailer carefully review this information to tow your load as efficiently and safely as possible.

To maintain warranty coverage, follow the requirements and recommendations in this manual concerning vehicles used for trailer towing.

**Common Towing Definitions**

The following trailer towing related definitions will assist you in understanding the following information:

**Gross Vehicle Weight Rating (GVWR)**

The GVWR is the total allowable weight of your vehicle. This includes driver, passengers, cargo and tongue weight. The total load must be limited so that you do not exceed the GVWR.

**Gross Trailer Weight (GTW)**

The gross trailer weight (GTW) is the weight of the trailer plus the weight of all cargo, consumables and equipment (permanent or temporary) loaded in or on the trailer in its "loaded and ready for operation" condition. The recommended way to measure GTW is to put your fully loaded trailer on a vehicle scale. The entire weight of the trailer must be supported by the scale.

**Gross Combination Weight Rating (GCWR)**

The gross combination weight rating (GCWR) is the total permissible weight of your vehicle and trailer when weighed in combination. (Note that GCWR ratings include a 68 kg (150 lbs) allowance for the presence of a driver).

**Gross Axle Weight Rating (GAWR)**

The GAWR is the maximum capacity of the front and rear axles. Distribute the load over the front and rear axles evenly. Make sure that you do not exceed either front or rear GAWR.

**WARNING!**

**It is important that you do not exceed the maximum front or rear GAWR. A dangerous driving condition can result if either rating is exceeded. You could lose control of the vehicle and have an accident.**

**5****Tongue Weight (TW)**

The downward force exerted on the hitch ball by the trailer. In most cases it should not be less than 10% or more than 15% of the trailer load. You must consider this as part of the load on your vehicle.

**Frontal Area**

The maximum height and maximum width of the front of a trailer.

**Trailer Sway Control**

The trailer sway control is a telescoping link that can be installed between the hitch receiver and the trailer tongue that typically provides adjustable friction associated with the telescoping motion to dampen any unwanted trailer swaying motions while traveling.

**Weight-Carrying Hitch**

A weight-carrying hitch supports the trailer tongue weight, just as if it were luggage located at a hitch ball or some other connecting point of the truck. These kind of hitches are the most popular on the market today and they're commonly used to tow small- and medium-sized trailers.

**Weight-Distributing Hitch**

A weight-distributing hitch includes a receiver attached to the tow vehicle, plus a removable hitch head and spring bar assembly that fits into the receiver opening and hook up brackets that connect the spring bars to the trailer frame.

**Trailer Hitch Classification**

The following chart provides the industry standard for the maximum trailer weight a given trailer hitch class can tow and should be used to assist you in selecting the correct trailer hitch for your intended towing condition. Refer to the Trailer Towing Weights (Maximum Trailer Weight Ratings) chart for the Max. GTW towable for your given drivetrain.

Trailer Hitch Classification	
Class	Max. GTW (Gross Trailer Wt.)
Class I - Light Duty	2,000 lbs (907 kg)
Class II - Medium Duty	3,500 lbs (1587 kg)
Class III - Heavy Duty	5,000 lbs (2268 kg)
Class IV - Extra Heavy Duty	10,000 lbs (4540 kg)

All trailer hitches should be professionally installed on your vehicle.

### Trailer Towing Weights (Maximum Trailer Weight Ratings)

The following chart provides the maximum trailer weight ratings towable for your given drivetrain.

Engine/Transmission	Frontal Area	Max. GTW (Gross Trailer Wt.)	Max. Tongue Wt. (See Note 1)
2.4L Automatic/ Manual	20 Sq. Ft	1000 lbs (454 kg)	110 lbs (50 kg)
2.7L Automatic/ Manual	20 Sq. Ft.	1000 lbs (454 kg)	110 lbs (50 kg)

Refer to local laws for maximum trailer towing speeds.

Note 1 – The trailer tongue weight must be considered as part of the combined weight of occupants and cargo, and should never exceed the weight referenced on the Tire and Loading Information placard. Refer to the Tire-Safety Information Section in this manual.

#### Trailer and Tongue Weight

Always load a trailer with 60% to 65% of the weight in the front of the trailer. This places 10% to 15% of the Gross Trailer Weight (GTW) on the tow hitch of your vehicle. Loads balanced over the wheels or heavier in the rear can cause the trailer to sway severely side to side which will cause loss of control of vehicle and trailer. Failure to load trailers heavier in front is the cause of many trailer accidents.

Never exceed the maximum tongue weight stamped on your bumper or trailer hitch.

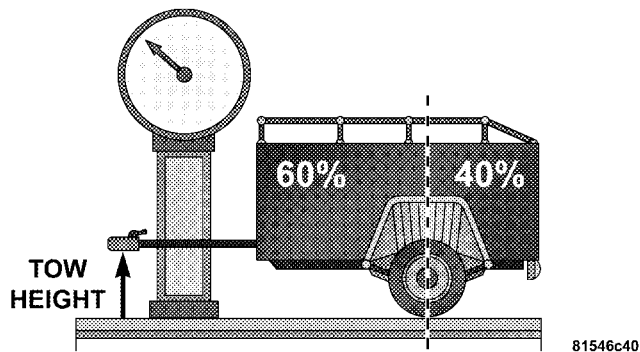

Consider the following items when computing the weight on the rear axle of the vehicle:

- The tongue weight of the trailer.
- The weight of any other type of cargo or equipment put in or on your vehicle.
- The weight of the driver and all passengers.

**NOTE:** Remember that everything put into or on the trailer adds to the load on your vehicle. Also, additional factory-installed options, or dealer-installed options, must be considered as part of the total load on your vehicle. Refer to the Tire and Loading Information placard in the Tire Safety Information Section of this manual for the maximum combined weight of occupants and cargo for your vehicle.

#### Towing Requirements

To promote proper break-in of your new vehicle drivetrain components the following guidelines are recommended:

#### CAUTION!

- Avoid towing a trailer for the first 500 miles (805 km) of vehicle operation. Doing so may damage your vehicle.
- During the first 500 miles (805 km) of trailer towing, limit your speed to 50 mph (80 km/h).

Perform the maintenance listed in Section 8 of this manual. When towing a trailer, never exceed the GAWR, or GCWR, ratings.

### WARNING!

**Improper towing can lead to an injury accident. Follow these guidelines to make your trailer towing as safe as possible:**

**Make certain that the load is secured in the trailer and will not shift during travel. When trailering cargo that is not fully secured, dynamic load shifts can occur that may be difficult for the driver to control. You could lose control of your vehicle and have an accident.**

- When hauling cargo or towing a trailer, do not overload your vehicle or trailer. Overloading can cause a loss of control, poor performance or damage to brakes, axle, engine, transmission, steering, suspension, chassis structure or tires.

- Safety chains must always be used between your vehicle and trailer. Always connect the chains to the frame or hook retainers of the vehicle hitch. Cross the chains under the trailer tongue and allow enough slack for turning corners.
- Vehicles with trailers should not be parked on a grade. When parking, apply the parking brake on the tow vehicle. Put the tow vehicle automatic transmission in P for Park. With a manual transmission, shift the transmission into reverse. Always, block or "chock" the trailer wheels.
- GCWR must not be exceeded.
- Total weight must be distributed between the tow vehicle and the trailer such that the following four ratings are not exceeded:
  1. GVWR
  2. GTW
  3. GAWR

4. Tongue weight rating for the trailer hitch utilized (This requirement may limit the ability to always achieve the 10% to 15% range of tongue weight as a percentage of total trailer weight).

#### Towing Requirements — Tires

- Do not attempt to tow a trailer while using a compact spare tire.
- Proper tire inflation pressures are essential to the safe and satisfactory operation of your vehicle. Refer to the Tires-General Information section of this manual on Tire Pressures for proper tire inflation procedures.
- Also, check the trailer tires for proper tire inflation pressures before trailer usage.
- Check for signs of tire wear or visible tire damage before towing a trailer. Refer to the Tires-General Information section of this manual on Tread Wear Indicators for the proper inspection procedure.

- When replacing tires refer to the Tires-General Information section of this manual on Replacement Tires for proper tire replacement procedures. Replacing tires with a higher load carrying capacity will not increase the vehicle's GVWR and GAWR limits.

#### Towing Requirements — Trailer Brakes

- Do **not** interconnect the hydraulic brake system or vacuum system of your vehicle with that of the trailer. This could cause inadequate braking and possible personal injury.
- An electronically actuated trailer brake controller is required when towing a trailer with electronically actuated brakes. When towing a trailer equipped with a hydraulic surge actuated brake system, an electronic brake controller is not required.
- Trailer brakes are recommended for trailers over 1,000 lbs (454 kg) and required for trailers in excess of 2,000 lbs (907 kg).



**CAUTION!**

If the trailer weighs more than 1,000 lbs (454 kg) loaded, it should have its own brakes and they should be of adequate capacity. Failure to do this could lead to accelerated brake lining wear, higher brake pedal effort, and longer stopping distances.

**WARNING!**

Do not connect trailer brakes to your vehicle's hydraulic brake lines. It can overload your brake system and cause it to fail. You might not have brakes when you need them and could have an accident.

Towing any trailer will increase your stopping distance. When towing you should allow for additional space between your vehicle and the vehicle in front of you. Failure to do so could result in an accident.

**Towing Requirements — Trailer Lights & Wiring**

Whenever you pull a trailer, regardless of the trailer size, stop lights and turn signals on the trailer are required for motoring safety.

The Trailer Tow Package may include a 4 and 7 pin wiring harness. Use a factory approved trailer harness and connector.

**NOTE:** Do not cut or splice wiring into the vehicles wiring harness.

The electrical connections are all complete to the vehicle but you must mate the harness to a trailer connector. Refer to the following illustrations.

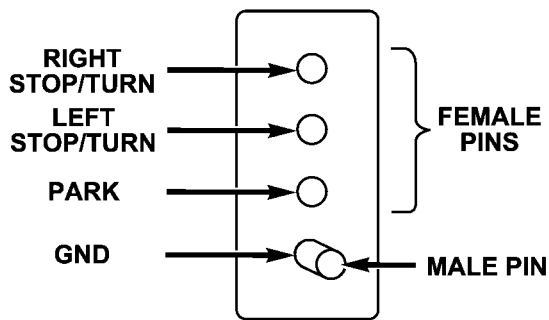

4 - Pin Connector

813262be

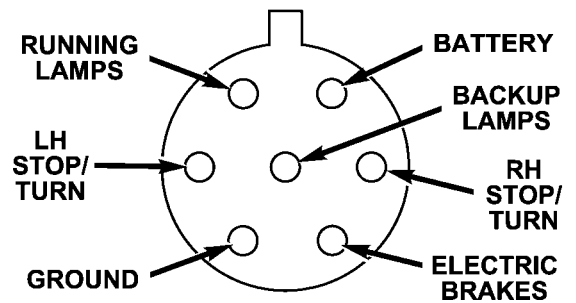

7- Pin Connector

812634c6

**Towing Tips**

Before setting out on a trip, practice turning, stopping and backing the trailer in an area away from heavy traffic.

If using a manual transmission vehicle for trailer towing, all starts must be in FIRST gear to avoid excessive clutch slippage.

**Towing Tips — Automatic Transmission**

The “D” range can be selected when towing. However, if frequent shifting occurs while in this range, the “3” range should be selected.

**NOTE:** Using the “3” range while operating the vehicle under heavy operating conditions will improve performance and extend transmission life by reducing excessive shifting and heat build up. This action will also provide better engine braking.

The automatic transmission fluid and filter should be changed if you REGULARLY tow a trailer for more than 45 minutes of continuous operation. See Schedule “B” in section 8 of this manual for transmission fluid change intervals.

**NOTE:** Check the automatic transmission fluid level before towing.

**Towing Tips — Electronic Speed Control (If Equipped)**

- Don’t use in hilly terrain or with heavy loads.

- When using the speed control, if you experience speed drops greater than 10 mph (16 km/h), disengage until you can get back to cruising speed.
- Use speed control in flat terrain and with light loads to maximize fuel efficiency.

**Towing Tips — Cooling System**

To reduce potential for engine and transmission overheating, take the following actions:

**– City Driving**

When stopped for short periods of time, put transmission in neutral and increase engine idle speed.

**– Highway Driving**

Reduce speed.

**– Air Conditioning**

Turn off temporarily.

- refer to Cooling System Operating information in the Maintenance section of this manual for more information.



---

## WHAT TO DO IN EMERGENCIES

### CONTENTS

---

■ Hazard Warning Flasher . . . . .	190	□ Traction . . . . .	200
■ If Your Engine Overheats . . . . .	190	■ Freeing A Stuck Vehicle . . . . .	201
■ Jacking And Tire Changing . . . . .	191	■ Towing A Disabled Vehicle . . . . .	201
□ Preparations For Jacking . . . . .	192	■ Towing This Vehicle Behind Another Vehicle (Flat Towing With All Four Wheels On The Ground) . . . . .	202
■ Jump-Starting Procedures If Battery Is Low . . .	197	□ Automatic Transaxle . . . . .	202
■ Driving On Slippery Surfaces . . . . .	200		
□ Acceleration . . . . .	200		

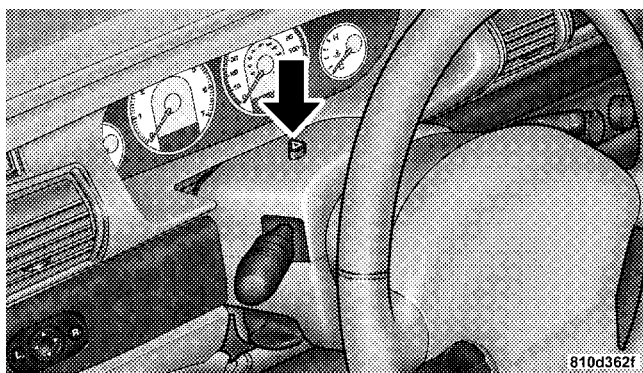
**HAZARD WARNING FLASHER**

**Hazard Flasher Switch**

 The flasher switch is on top of the steering column, just behind the steering wheel. Depress the switch and both cluster indicators and all front and rear directional signals will flash. Depress the switch again to turn Hazard Warning Flashers off.

Do not use this emergency warning system when the vehicle is in motion. Use it when your vehicle is disabled and is creating a safety hazard for other motorists.

If it is necessary to leave the vehicle to go for service, the flasher system will continue to operate with the ignition key removed and the vehicle locked.

**NOTE:** With extended use, the flasher may wear down your battery.

**IF YOUR ENGINE OVERHEATS**

In any of the following situations, you can reduce the potential for overheating by taking the appropriate action.

- On the highways — Slow down.
- In city traffic — While stopped, put transaxle in neutral, but do not increase engine idle speed.

**NOTE:** There are steps that you can take to slow down an impending overheat condition. If your air conditioner is on, turn it off. The air conditioning system adds heat to the engine cooling system and turning off the A/C removes this heat. You can also turn the Temperature control to maximum heat, the Mode control to floor, and the fan control to High. This allows the heater core to act as a supplement to the radiator and aids in removing heat from the engine cooling system.

**CAUTION!**

Driving with a hot cooling system could damage your vehicle. If temperature gauge reads "H", pull over and stop the vehicle. Idle the vehicle in Park with the air conditioner turned off until the pointer drops back into the normal range. If the pointer remains on the "H", turn the engine off immediately, and call for service.

**WARNING!**

A hot engine cooling system is dangerous. You or others could be badly burned by steam or boiling coolant. You may want to call a service center if your vehicle overheats. If you decide to look under the hood yourself, see Section 7, Maintenance, of this manual. Follow the warnings under the Cooling System Pressure Cap paragraph.

**JACKING AND TIRE CHANGING****WARNING!**

- Getting under a jacked-up vehicle is dangerous. The vehicle could slip off the jack and fall on you. You could be crushed. Never get any part of your body under a vehicle that is on a jack. Never start or run the engine while the vehicle is on a jack. If you need to get under a raised vehicle, take it to a service center where it can be raised on a lift.
- Do not attempt to change a tire on the side of the vehicle close to moving traffic. Pull far enough off the road to avoid the danger of being hit when operating the jack or changing the wheel.
- The jack is designed to use as a tool for changing tires only. The jack should not be used to lift the vehicle for service purposes. The vehicle should be jacked on a firm level surface only. Avoid ice or slippery areas.

### Preparations for Jacking

Park the vehicle on a firm level surface, avoid ice or slippery areas, and set the parking brake. Place the gear selector in PARK.

- Turn on the Hazard Warning Flasher, park vehicle on firm, level surface.
- Put gear shift in park (automatic transmission) or reverse (manual transmission).
- Set parking brake and turn off engine.
- Passengers should not remain in the vehicle while the vehicle is being jacked.

### Changing a Tire

<b>CAUTION!</b>
Care must be taken to correctly position the jack to prevent contact and possible damage to the ground effects.

The spare wheel, scissors jack, and lug wrench are stowed under the spare tire cover in the rear cargo area.

Do not attempt to raise this vehicle using a bumper jack.



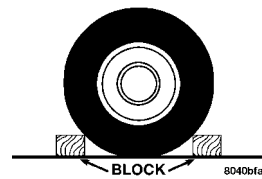
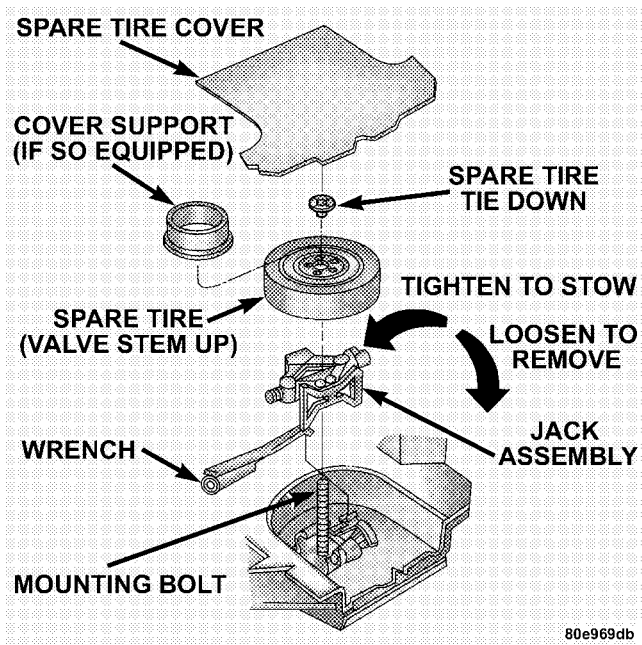

1. Block wheel diagonally opposite flat tire.

2. Remove the spare tire, scissors jack and lug wrench from stowage.

3. Before raising the vehicle, use lug wrench to carefully pry off wheel cover (if equipped with steel wheels) or center cap (if equipped with aluminum wheels). Loosen, but do not remove, the wheel nuts by turning them counterclockwise one turn while the wheel is still on the ground.

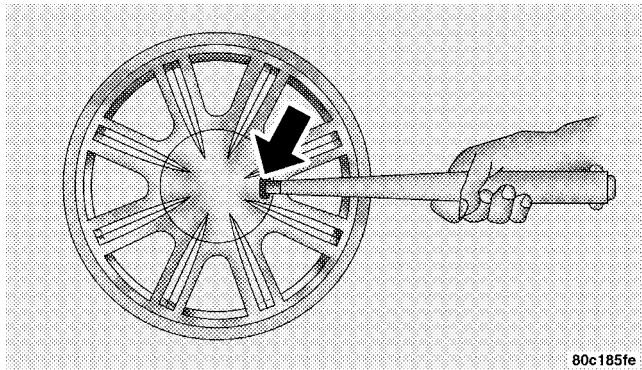

Center Cap Removal

#### WARNING!

To avoid possible personal injury, handle the wheel covers with care to avoid contact with the metal edges and retention teeth.

4. Turn the jack screw clockwise to firmly engage the jack saddle with the lift area of the sill flange. Use the lift area closest to the flat tire
5. Raise the vehicle just enough to remove flat tire and install spare tire.

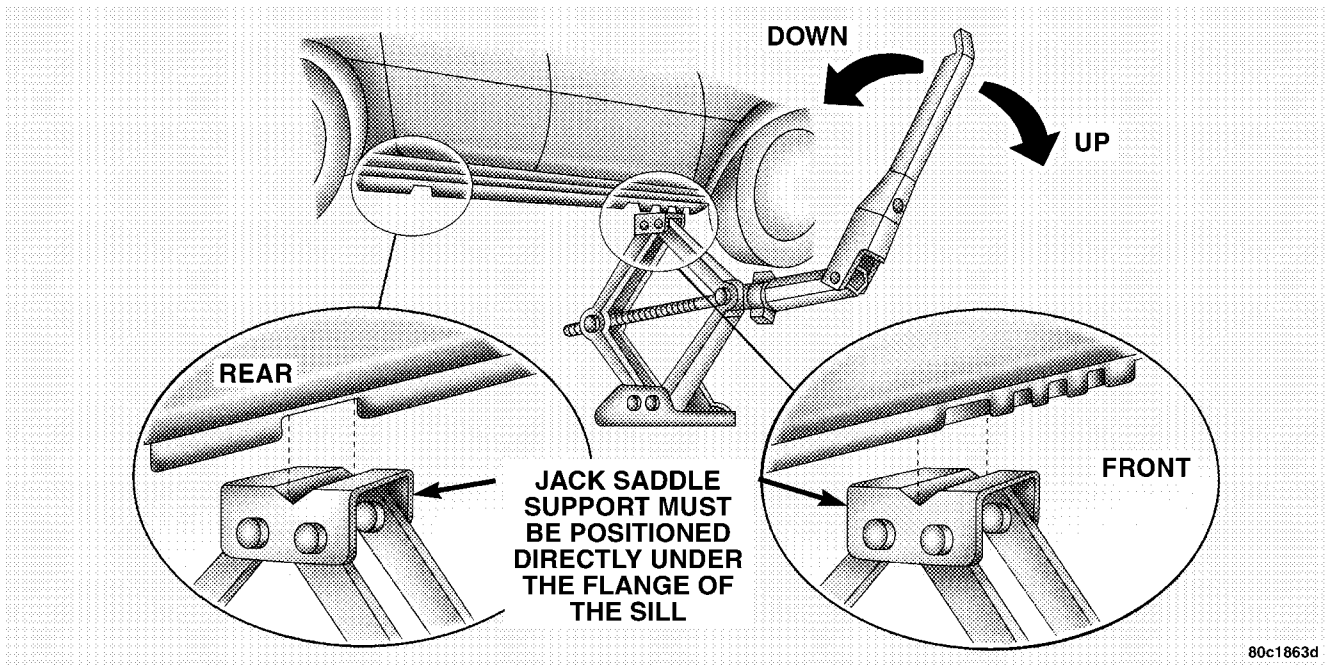

Jack Engagement Locations

**WARNING!**

Raising the vehicle higher than necessary can make the vehicle less stable. It could slip off the jack and hurt someone near it. Raise the vehicle only enough to remove the tire.

6. Remove lug nuts and tire.
7. Mount spare tire.
8. Tighten all lug nuts on mounting studs.
9. Lower the vehicle to the ground by turning the jack handle counterclockwise.
10. Fully tighten the lug nuts. Torque wheel lug nuts to 135 N·m (100 ft. lbs.).
11. Store the flat tire, jack, and tools.

**WARNING!**

A loose tire or jack thrown forward in a collision or hard stop could endanger the occupants of the vehicle. Always stow the jack parts and the spare tire in the places provided.

12. Wheel cover installation (if required). Do not attempt to install a wheel cover on a compact spare. Align valve notch in wheel cover with valve stem on wheel. Snap cover into place.

**NOTE:** When reinstalling the center cap it is necessary to align the center cap notch with the first spoke, just right of the valve stem.

13. Adjust the tire pressure as soon as possible. Correct pressure is on the label located on the driver's door.

**JUMP-STARTING PROCEDURES IF BATTERY IS LOW****WARNING!**

- Do not attempt to push or tow your vehicle to get it started. Vehicles equipped with an automatic transaxle cannot be started this way. Unburned fuel could enter the catalytic converter and once the engine has started, ignite and damage the converter and vehicle. If the vehicle has a discharged battery, booster cables may be used to obtain a start from another vehicle. This type of start can be dangerous if done improperly, so follow this procedure carefully.
- Take care to avoid the radiator cooling fan whenever the hood is raised. It can start anytime the ignition switch is on. You can be hurt by the fan.

**NOTE:** The battery is stored in a compartment behind the left front fender and is accessible without removing the tire and wheel. Remote battery terminals are located in the engine compartment for jump starting.

1. Wear eye protection and remove any metal jewelry such as watch bands or bracelets that might make an inadvertent electrical contact.
2. When boosting from a battery in another vehicle, park that vehicle within booster cable reach but without letting the vehicles touch. Set parking brake, place automatic transaxle in PARK and turn ignition to OFF for both vehicles.
3. Turn off the heater, radio and all unnecessary electrical loads.
4. Connect one end of a jumper cable to the positive terminal of the booster battery. Connect the other end to the positive jump start attachment of the discharged battery.

**WARNING!**

Do not permit vehicles to touch each other as this could establish a ground connection and person injury could result.

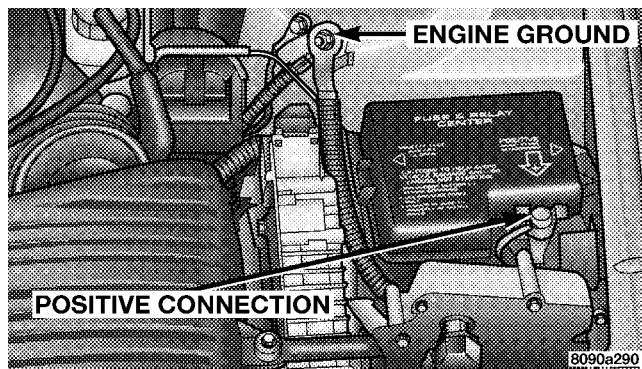

Jump Starting

5. Connect the other cable, first to the negative terminal of the booster battery and then to the jump start attachment of the vehicle with the discharged battery. Make sure you have a good contact on the engine.

**WARNING!**

Do not connect the cable to the negative post of the discharged battery. The resulting electrical spark could cause the battery to explode.

During cold weather when temperatures are below freezing point, electrolyte in a discharged battery may freeze. Do not attempt jump starting because the battery could rupture or explode. The battery temperature must be brought up above freezing point before attempting to jump start.

6. Start the engine in the vehicle that has the booster battery, let the engine idle a few minutes, then start the engine in the vehicle with the discharged battery.

7. When removing the jumper cables, reverse the above sequence exactly. Be careful of the moving belts and fan.

**WARNING!**

Any procedure other than above could result in:

1. Personal injury caused by electrolyte squirting out the battery vent;
2. Personal injury or property damage due to battery explosion;
3. Damage to charging system of booster vehicle or of immobilized vehicle.

**WARNING!**

Battery fluid is a corrosive acid solution; do not allow battery fluid to contact eyes, skin or clothing. Don't lean over battery when attaching clamps or allow the clamps to touch each other. If acid splashes in eyes or on skin, flush the contaminated area immediately with large quantities of water.

A battery generates hydrogen gas which is flammable and explosive. Keep flame or spark away from the battery. Do not use a booster battery or any other booster source with an output that exceeds 12 volts.

**6**

**WARNING!**

Battery posts, terminals and related accessories contain lead and lead compounds. Wash hands after handling.

## DRIVING ON SLIPPERY SURFACES

### Acceleration

Rapid acceleration on snow covered, wet, or other slippery surfaces may cause the front wheels to pull erratically to the right or left. This phenomenon occurs when there is a difference in the surface traction under the front (driving) wheels, particularly with high output engines.

### WARNING!

**Rapid acceleration on slippery surfaces is dangerous. Unequal traction can cause sudden pulling of the front wheels. You could lose control of the vehicle and possibly have an accident. Accelerate slowly and carefully whenever there is likely to be poor traction (ice, snow, wet, mud, loose sand, etc.).**

### Traction

When driving on wet or slushy roads, it is possible for a wedge of water to build up between the tire and road surface. This is hydroplaning and may cause partial or complete loss of vehicle control and stopping ability. To reduce this possibility, the following precautions should be observed:

1. Slow down during rainstorms or when roads are slushy.
2. Slow down if road has standing water or puddles.
3. Replace tires when tread wear indicators first become visible.
4. Keep tires properly inflated.
5. Maintain enough distance between your vehicle and the vehicle in front of you to avoid a collision in a sudden stop.

**NOTE:** If so equipped, turn on the Traction Control System to accelerate on slippery surfaces.



**FREEING A STUCK VEHICLE**

If your vehicle is equipped with Traction Control, turn the system off before attempting to “rock” the vehicle.

If your vehicle becomes stuck in mud, sand or snow, it can often be moved by a rocking motion. Turn your steering wheel right and left to clear the area around the front wheels. Then shift back and forth between Reverse and First gear. Usually the least accelerator pedal pressure to maintain the rocking motion without spinning the wheels is most effective.

**CAUTION!**

Racing the engine or spinning the wheels too fast may lead to transaxle overheating and failure. It can also damage the tires. Do not spin the wheels above 35 mph (55 km/h).

**TOWING A DISABLED VEHICLE**

Flat bed towing is the preferred towing method. If a flat bed towing vehicle is not available, a wheel lift towing vehicle may be used.

Rear towing is not recommended with the front wheels on the ground, as transaxle damage can result. If rear towing is the only alternative, a front end dolly must be used.

**CAUTION!**

Do not use sling type towing equipment. Damage to the fascia and air dam may result.

**TOWING THIS VEHICLE BEHIND ANOTHER VEHICLE (Flat towing with all four wheels on the ground)**

**Automatic Transaxle**

Your vehicle may be towed under the following conditions: The gear selector must be in NEUTRAL, the distance to be towed must not exceed 15 miles (25 km), and the towing speed must not exceed 25 mph (40 km/h). If the transaxle is not operative, or if the vehicle is to be towed more than 15 miles (25 km), the vehicle must be towed with the front wheels off the ground.

**CAUTION!**

If the vehicle being towed requires steering, the ignition switch must be in the OFF position, not in the LOCK or ACCESSORY positions.

If it is necessary to use the accessories while being towed (wipers, defrosters, etc.), the key must be in the ON position, not the ACCESSORY position. Make certain the transaxle remains in NEUTRAL.

---

## MAINTAINING YOUR VEHICLE

### CONTENTS

---

■ 2.4L Engine . . . . .	205	□ Power Steering — Fluid Check . . . . .	219
■ 2.7L Engine . . . . .	206	□ Suspension Ball Joints . . . . .	220
■ Onboard Diagnostic System — OBD II . . . . .	207	□ Body Mechanism Lubrication . . . . .	220
■ Emissions Inspection And Maintenance Programs . . . . .	208	□ Windshield Wiper Blades . . . . .	221
■ Replacement Parts . . . . .	209	□ Windshield Washers . . . . .	222
■ Dealer Service . . . . .	209	□ Exhaust System . . . . .	223
■ Maintenance Procedures . . . . .	210	□ Cooling System . . . . .	223
□ Engine Oil . . . . .	210	□ Hoses And Vacuum/Vapor Harnesses . . . . .	227
□ Crankcase Emission Control System . . . . .	216	□ Brakes . . . . .	228
□ Maintenance-Free Battery . . . . .	216	□ Fuel System Hoses . . . . .	230
□ Air Conditioner . . . . .	218	□ Automatic Transmission . . . . .	230

**204 MAINTAINING YOUR VEHICLE**

□ Appearance Care And Protection From Corrosion . . . . .	233	□ Fog Light Bulb Replacement . . . . .	244
■ Fuses . . . . .	237	□ Center Stoplight Bulb Replacement . . . . .	245
□ Underhood Fuses (Power Distribution Center) . . . . .	237	□ Rear Light Bulb Replacement . . . . .	245
□ Interior Fuses . . . . .	238	□ License Plate Bulb Replacement . . . . .	246
■ Vehicle Storage . . . . .	240	□ Headlight Aiming . . . . .	246
■ Replacement Light Bulbs . . . . .	240	■ Fluids And Capacities . . . . .	246
■ Bulb Replacement . . . . .	241	■ Fluids, Lubricants And Genuine Parts . . . . .	247
□ Headlight Bulb Replacement . . . . .	241	□ Engine . . . . .	247
□ Park, Turn Signal, Sidemarkers Bulb Replacement . . . . .	243	□ Chassis . . . . .	248

2.4L ENGINE

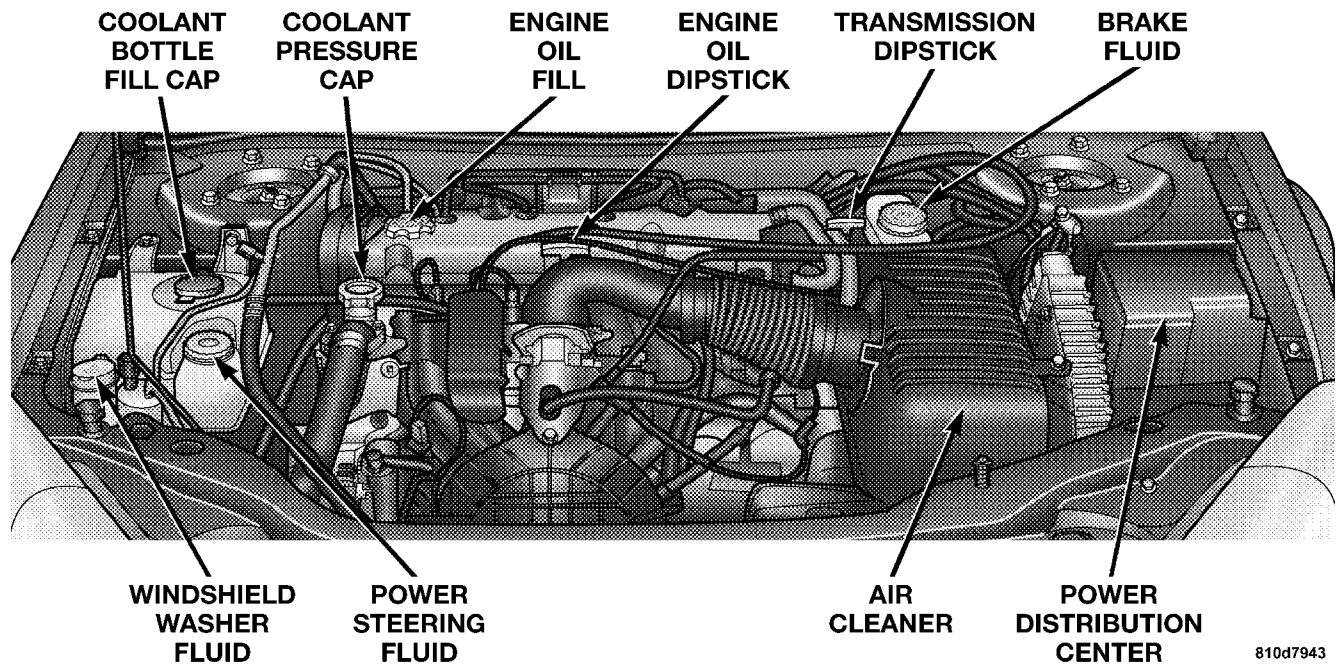

2.4L Engine Compartment

810d7943

2.7L ENGINE

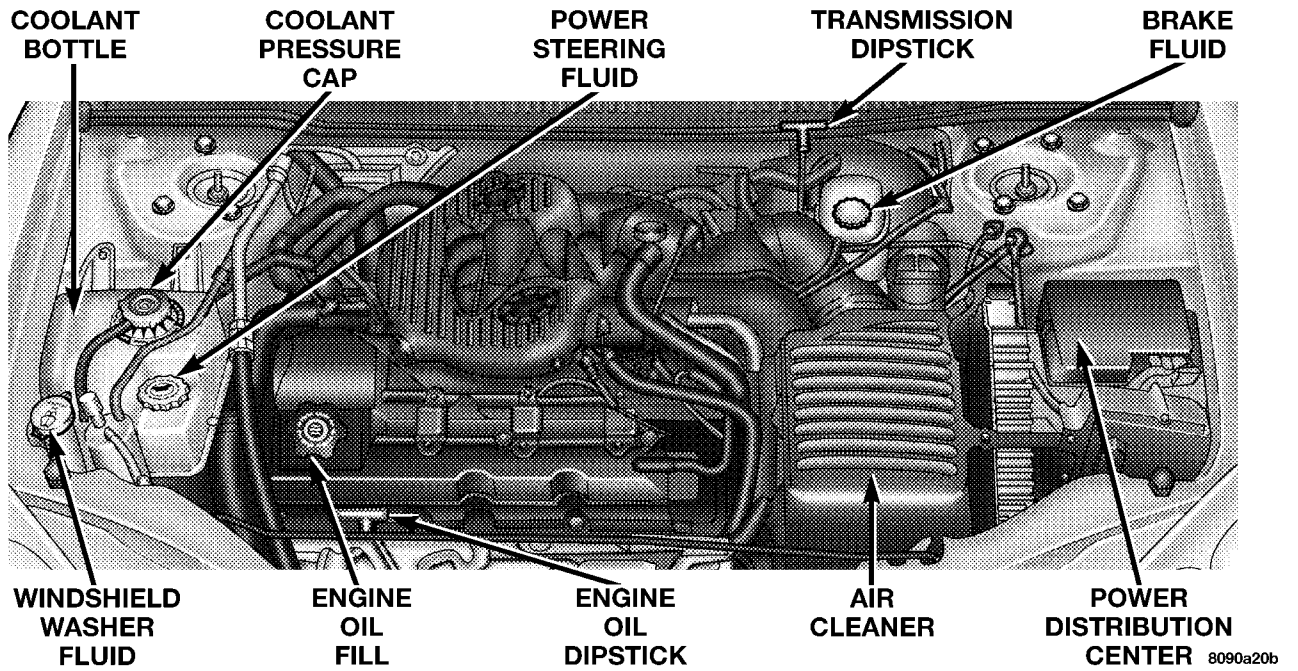

2.7L Engine Compartment

**ONBOARD DIAGNOSTIC SYSTEM — OBD II**

Your vehicle is equipped with a sophisticated onboard diagnostic system called OBD II. This system monitors the performance of the emissions, engine, and automatic transmission control systems. When these systems are operating properly, your vehicle will provide excellent performance and fuel economy, as well as engine emissions well within current government regulations.

If any of these systems require service, the OBD II system will turn on the “Malfunction Indicator Light.” It will also store diagnostic codes and other information to assist your service technician in making repairs. Although your vehicle will usually be drivable and not need towing, see your dealer for service as soon as possible.

**CAUTION!**

- Prolonged driving with the “Malfunction Indicator Light” on could cause further damage to the emission control system. It could also affect fuel economy and driveability. The vehicle must be serviced before any emissions tests can be performed.
- If the “Malfunction Indicator Light” is flashing while the engine is running, severe catalytic converter damage and power loss will soon occur. Immediate service is required.

### EMISSIONS INSPECTION AND MAINTENANCE PROGRAMS

In some localities, it may be a legal requirement to pass an inspection of your vehicle's emissions control system. Failure to pass could prevent vehicle registration.



For states which have an I/M (Inspection and Maintenance) requirement, this check verifies the following: the MIL (Malfunction Indicator Lamp) is functioning and is not on when the engine is running, and that the OBD (On Board Diagnostic) system is ready for testing.

Normally, the OBD system will be ready. The OBD system may **not** be ready if your vehicle was recently serviced, if you recently had a dead battery, or a battery replacement. If the OBD system should be determined not ready for the I/M test, your vehicle may fail the test.

Your vehicle has a simple ignition key actuated test which you can use prior to going to the test station. To check if your vehicle's OBD system is ready, you must do the following:

1. Insert your ignition key into the ignition switch.

2. Turn the ignition to the ON position, but do not crank or start the engine.

3. If you crank or start the engine, you will have to start this test over.

4. As soon as you turn your key to the ON position, you will see your MIL symbol come on as part of a normal bulb check.

5. Approximately 15 seconds later, one of two things will happen:

a. The MIL will flash for about 10 seconds and then return to being fully illuminated until you turn off the ignition key or start the engine. This means that your vehicle's OBD system is **not ready** and you should **not** proceed to the I/M station.

b. The MIL will not flash at all and will remain fully illuminated until you turn off the ignition key or start the engine. This means that your vehicle's OBD system is **ready** and you can proceed to the I/M station.



If your OBD system is **not ready**, you should see your authorized dealer or repair facility. If your vehicle was recently serviced or had a battery failure or replacement, you may need to do nothing more than drive your vehicle as you normally would in order for your OBD system to update. A recheck with the above test routine may then indicate that the system is now ready.

Regardless of whether your vehicle's OBD system is ready or not ready, if the MIL symbol is illuminated during normal vehicle operation, you should have your vehicle serviced before going to the I/M station. The I/M station can fail your vehicle because the MIL symbol is on with the engine running.

### REPLACEMENT PARTS

Use of genuine Mopar parts for normal/scheduled maintenance and repairs is highly recommended to insure the designed performance. Damage or failures caused by the use of non-Mopar parts for maintenance and repairs will not be covered by the manufacturer's warranty.

### DEALER SERVICE

Your dealer has the qualified service personnel, special tools and equipment to perform all service operations in an expert manner. Service manuals are available which include detailed service information for your vehicle. Refer to these manuals before attempting any procedure yourself.

**NOTE:** Intentional tampering with emissions control systems can result in civil penalties being assessed against you.

**WARNING!**

You can be badly injured working on or around a motor vehicle. Do only that service work for which you have the knowledge and the proper equipment. If you have any doubt about your ability to perform a service job, take your vehicle to a competent mechanic.

**MAINTENANCE PROCEDURES**

The pages that follow contain the required maintenance services determined by the engineers who designed your vehicle.

Besides the maintenance items for which there are fixed maintenance intervals, there are other items that should operate satisfactorily without periodic maintenance. However, if a malfunction of these items does occur, it could adversely affect the engine or vehicle performance. These items should be inspected if a malfunction is observed or suspected.

**Engine Oil****Checking Oil Level**

To assure proper lubrication of your vehicle's engine, the engine oil must be maintained, at the correct level. Check the oil level at regular intervals, such as every fuel stop.

The best time to check the oil level is about 5 minutes after a fully warmed engine is shut off or before starting the engine after it has sat overnight.

Checking the oil while the vehicle is on level ground will improve the accuracy of the oil level readings. Maintain the oil level between the MIN and MAX markings on the dipstick. Adding one quart of oil when the reading is at the MIN mark will result in a MAX reading on these engines.

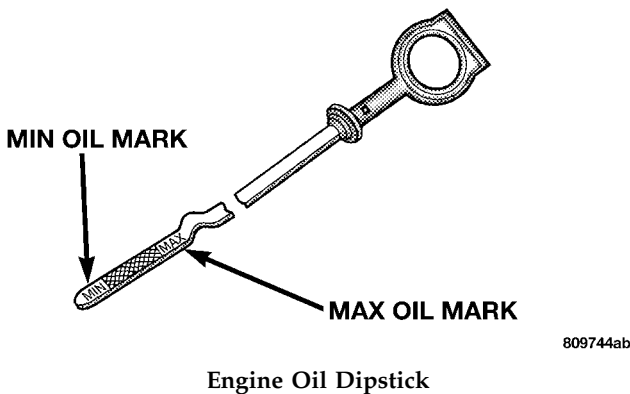

<b>CAUTION!</b>
Overfilling or underfilling will cause aeration or loss of oil pressure. This could damage your engine.

**Change Engine Oil**

Road conditions and your kind of driving affects the interval at which your oil should be changed. Check the following list to decide if any apply to you.

- Day and night temperatures are below 32° F (0° C)
- Stop and Go driving
- Extensive engine idling.
- Driving in dusty conditions
- Short trips of less than 10 miles (16.2 km)
- More than 50% of your driving is at sustained high speeds during hot weather, above 90° F (32° C)
- Trailer towing
- Taxi, Police or delivery service (commercial service)
- Off— road or desert operation
- If equipped for and operating with E-85 (ethanol) fuel.

**NOTE:** If ANY of these apply to you then change your engine oil every 3,000 miles (5 000 km) or 3 months, whichever comes first and follow schedule “B” of the “Maintenance Schedules” section of this manual.

If none of these apply to you, then change your engine oil at every interval shown on schedule "A" of the "Maintenance Schedules" section of this manual.

**NOTE:** Under no circumstances should oil change intervals exceed 6,000 miles (10 000 km) or 6 months whichever comes first.

#### Engine Oil Selection

For best performance and maximum protection under all types of operating conditions, we recommend engine oils that are API Certified and meet the requirements of DaimlerChrysler's Material Standard MS-6395. Use Mopar or an equivalent oil meeting the specification MS-6395.

#### American Petroleum Institute (API) Engine Oil Identification Symbol



This symbol means that the oil has been certified by the American Petroleum Institute (API). We only recommend API Certified engine oils that meet the requirements of DaimlerChrysler's Material Standard MS-6395. Use Mopar or an equivalent oil meeting the specification MS-6395.

### Engine Oil Viscosity (SAE Grade)

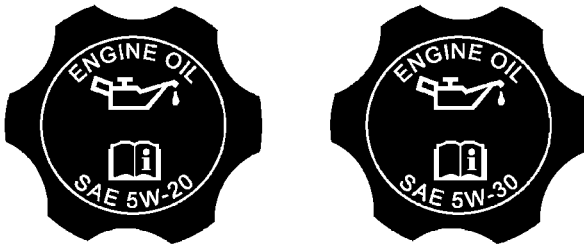

81364ec7

#### Engine Oil Fill Cap

SAE 5W-20 and SAE 5W-30 engine oils are recommended for all operating temperatures. These engine oils are designed to improve low temperature starting and vehicle fuel economy. Refer to the engine oil filler cap for the preferred engine oil viscosity grade for each vehicle.

Lubricants which do not have both, the engine oil certification mark and the correct SAE viscosity grade number should not be used.

#### Synthetic Engine Oils

You may use synthetic engine oils provided that the recommended oil quality requirements are met and the recommended maintenance intervals for oil and filter changes are followed.

#### Materials Added To Engine Oils

The manufacturer strongly recommends against the addition of any additives (other than leak detection dyes) to engine oil. Engine oil is an engineered product and its performance may be impaired by supplemental additives.

#### CAUTION!

If Flexible Fuel engine oil is not used when using E-85, engine wear may be increased significantly.

**Disposing of Used Engine Oil and Oil Filters**

Care should be taken in disposing of used engine oil from your vehicle. Used oil, indiscriminately discarded, can present a problem to the environment. Contact your dealer, service station, or governmental agency for advice on how and where used oil can be safely discarded in your area.

**Engine Oil Filter**

The engine oil filter should be replaced at every engine oil change.

**Engine Oil Filter Selection**

All manufacturer's engines have a full-flow type disposable oil filter. Use a filter of this type for replacement. The quality of replacement filters varies considerably. Only high quality filters should be used to assure most efficient service. Mopar Engine Oil Filters are high quality oil filters and are recommended.

**Drive Belts — Check Condition and Tension**

At the mileage shown in the maintenance schedules, check all drive belts for condition and proper tension. Improper belt tension can cause belt slippage and failure.

Inspect the drive belts for evidence of cuts, cracks, or glazing and replace them if there is any sign of damage which could result in belt failure. If adjustment is required, adjust the belts according to the specifications and procedures shown in the Service Manual.

Special tools are required to properly measure tension and to restore belt tension to factory specifications. Also, check belt routing to make sure there is no interference between the belts and other engine components.

**Spark Plugs**

Spark plugs must fire properly to assure engine performance and emission control. New plugs should be installed at the specified mileage. The entire set should be replaced if there is any malfunction due to a faulty spark plug. Check the specifications section for the proper type of spark plug for use in your vehicle.

**Engine Air Cleaner Filter**

Under normal driving conditions, replace the air filter at the intervals shown on Schedule "A". If, however, you drive the vehicle frequently under dusty or severe conditions, the filter element should be inspected periodically and replaced if necessary at the intervals shown on Schedule "B".

**WARNING!**

The air cleaner can provide a measure of protection in the case of engine backfire. Do not remove the air cleaner unless such removal is necessary for repair or maintenance. Make sure that no one is near the engine compartment before starting the vehicle with the air cleaner removed. Failure to do so can result in serious personal injury.

**Engine Fuel Filter**

A plugged fuel filter can cause hard starting or limit the speed at which a vehicle can be driven. Should an excessive amount of dirt accumulate in the fuel tank, frequent filter replacement may be necessary.

**Catalytic Converter**

The catalytic converter requires the use of unleaded fuel only. Leaded gasoline will destroy the effectiveness of the catalyst as an emission control device.

Under normal operating conditions, the catalytic converter will not require maintenance. However, it is important to keep the engine properly serviced to assure proper catalyst operation and prevent possible catalyst damage.

**CAUTION!**

Damage to the catalytic converter can result if your vehicle is not kept in proper operating condition. In the event of engine malfunction, particularly involving engine misfire or other apparent loss of performance, have your vehicle serviced promptly. Continued operation of your vehicle with a severe malfunction could cause the converter to overheat, resulting in possible damage to the converter and the vehicle.

**WARNING!**

A hot exhaust system can start a fire if you park over materials that can burn. Such materials might be grass or leaves coming into contact with your exhaust system. Do not park or operate your vehicle in areas where your exhaust system can contact anything that can burn.

In unusual situations involving grossly malfunctioning engine operation, a scorching odor may suggest severe and abnormal catalyst overheating. If this occurs, stop the vehicle, turn off the engine and allow it to cool. Service, to the manufacturer's specifications, should be obtained immediately.

To minimize the possibility of catalyst damage:

- Do not shut off the engine or interrupt the ignition when the transaxle is in gear and the vehicle is in motion.
- Do not try to start the engine by pushing or towing the vehicle.

- Do not idle the engine with any spark plug wires disconnected for prolonged period.

**Engine Timing Belt**

Replace the engine timing belt (2.4L Only) at the intervals described in the appropriate maintenance schedule.

**Crankcase Emission Control System**

Proper operation of this system depends on freedom from sticking or plugging due to deposits. As vehicle mileage builds up, the Positive Crankshaft Ventilation (PCV) valve and passages may accumulate deposits. If a valve is not working properly, replace it with a new valve. **DO NOT ATTEMPT TO CLEAN THE OLD PCV VALVE!**

Check ventilation hose for indication of damage or plugging deposits. Replace if necessary.

**Maintenance-Free Battery**

The top of the MAINTENANCE-FREE battery is permanently sealed. You will never have to add water, nor is periodic maintenance required.



**NOTE:** The battery is stored in a compartment behind the left front fender and is accessible without removing the tire and wheel. Remote battery terminals are located in the engine compartment for jump starting.

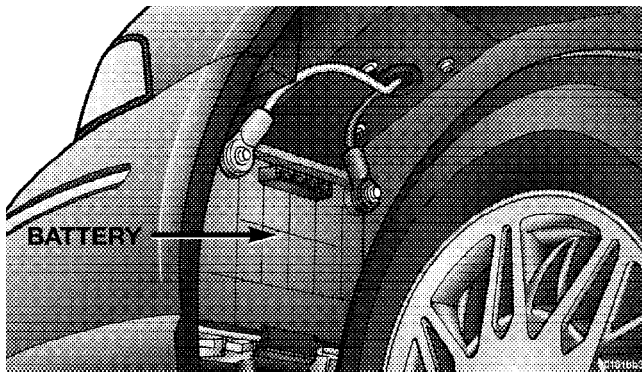

**Battery Location**

To access the battery, turn the steering wheel fully to the right and remove the inner fender shield.

### **WARNING!**

Battery posts, terminals and related accessories contain lead and lead compounds. Wash hands after handling. Battery fluid is a corrosive acid solution and can burn or even blind you. Don't allow battery fluid to contact your eyes, skin or clothing. Don't lean over a battery when attaching clamps. If acid splashes in eyes or on skin, flush the area immediately with large amounts of water. Battery gas is flammable and explosive. Keep flame or sparks away from the battery. Don't use a booster battery or any other booster source with an output greater than 12 volts. Don't allow cable clamps to touch each other.

**CAUTION!**

It is essential when replacing the cables on the battery that the positive cable is attached to the positive post and the negative cable is attached to the negative post. Battery posts are marked positive (+) and negative (-) and identified on the battery case. Cable clamps should be tight on the terminal posts and free of corrosion. Apply grease to posts and clamps after tightening. If a "fast charger" is used while the battery is in the vehicle, disconnect both vehicle battery cables before connecting the charger to battery. Do not use a "fast charger" to provide starting voltage as battery damage can result.

**Air Conditioner**

Check the air conditioning system at the start of the warm weather season.

**NOTE:** If your air conditioning performance seems lower than expected, check the front of the A/C condenser for an accumulation of dirt or insects. Clean with a gentle water spray from behind the radiator and

through the condenser as required. Fabric front fascia protectors may reduce air flow to the condenser, reducing air conditioning performance.

**WARNING!**

- Use only refrigerants and compressor lubricants approved by the manufacturer for your air conditioning system. Some unapproved refrigerants are flammable and can explode, injuring you. Other unapproved refrigerants or lubricants can cause the system to fail, requiring costly repairs. Refer to Section 3 of the Warranty Information book for further warranty information.
- The air conditioning system contains refrigerant under high pressure. To avoid risk of personal injury or damage to the system, adding refrigerant or any repair requiring lines to be disconnected should be done by an experienced repairman.

### Refrigerant Recovery and Recycling

R-134a Air Conditioning Refrigerant is a hydrofluorocarbon (HFC) that is endorsed by the Environmental Protection Agency and is an ozone-saving product. However, the manufacturer recommends that air conditioning service be performed by dealers or other service facilities using recovery and recycling equipment.

**NOTE:** Use only manufacturer approved A/C System Sealers, Stop Leak Products, Seal Conditioners, Compressor Oil, or Refrigerants.

### Power Steering — Fluid Check

Checking the power steering fluid level at a defined service interval is not required. The fluid should only be checked if a leak is suspected, abnormal noises are apparent, and/or the system is not functioning as anticipated. Coordinate inspection efforts through a certified DaimlerChrysler Dealership.

Before removing the reservoir cap, wipe the outside of the cap and reservoir so that no dirt can fall into the reservoir.

### WARNING!

Fluid level should be checked on a level surface and with the engine off to prevent injury from moving parts and to insure accurate fluid level reading. Do not overfill. Use only manufacturer recommended power steering fluid, refer to Fluids, Lubricants and Genuine Parts for correct fluid type.

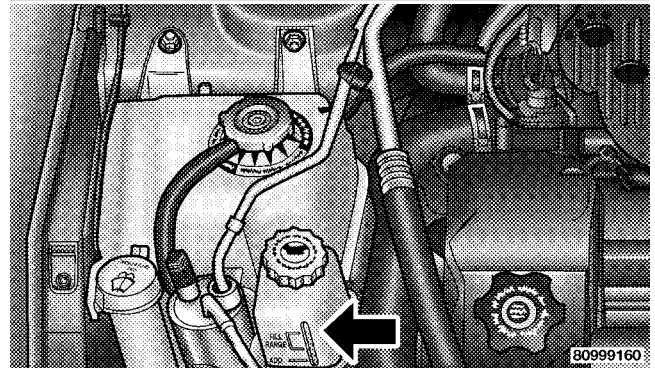

Power Steering Fluid Reservoir

Fluid level should be maintained at the proper level indicated on the side of the reservoir. If necessary, add fluid to restore the proper indicated level. With a clean cloth, wipe any spilled fluid from all surfaces. Refer to Fluids, Lubricants, and Genuine Parts for correct fluid type.

#### **Suspension Ball Joints**

There are two upper front and rear suspension ball joints. Inspect these ball joints whenever under vehicle service is done. If the seals are damaged, the ball joint should be replaced.

#### **Body Mechanism Lubrication**

Locks and all body pivot points, including such items as seat tracks, doors, liftgate and hood hinges, should be lubricated periodically to assure quiet, easy operation and to protect against rust and wear. Prior to the application of any lubricant, the parts concerned should be wiped clean to remove dust and grit; after lubricating excess oil and grease should be removed. Particular attention should also be given to hood latching components to insure proper function. When performing other

underhood services, the hood latch, release mechanism and safety catch should be cleaned and lubricated.

#### **Hood Latch**

When performing other under hood services, the hood latch release mechanism and safety catch should be inspected, cleaned, and lubricated.

It is important to maintain proper lubrication to insure that the hood mechanisms work properly and safely. Multi-Purpose Lubricant, NLGI Grade 2, should be applied sparingly to all pivot and sliding contact areas.

#### **External Lock Cylinders**

Lubricate the external lock cylinders twice a year, preferably in the fall and spring. Apply a small amount of lubricant, such as Mopar Lock Cylinder Lubricant or equivalent directly into the lock cylinder (avoid excess lubricant). Insert the key into the lock cylinder and rotate from the unlocked to the locked position; without adding more lubricant. Repeat this procedure three or four times. Wipe all the lubricant off the key with a clean cloth, to avoid soiling clothing.

If you use a lubricant that cannot be dispensed directly into the lock cylinder, apply a small amount of the lubricant to the key. Insert the key into the lock cylinder, then proceed as described above, to distribute the lubricant within the lock cylinder. Pay attention to trunk hinges, especially during cold weather, to ensure ease of trunk operation.

#### **Other Body Mechanisms**

The following body mechanisms should be inspected and, if necessary, all pivot and sliding contact areas of these components should be lubricated with the lubricant specified as follows:

##### *Engine Oil*

- Door hinges
- Hood hinges
- Trunk hinges

##### *Smooth White Body Lubricant - Such as Mopar Spray White Lube or equivalent:*

- Hood hinge springs and links
- Lock cylinders
- Parking brake mechanism
- Trunk latches
- Ash tray

#### **Windshield Wiper Blades**

Clean the rubber edges of the wiper blades and the windshield periodically with a sponge or soft cloth and a mild non abrasive cleaner. This will remove accumulations of salt or road film.

Operation of the wipers on dry glass for long periods may cause deterioration of the wiper blades. Always use washer fluid when using the wipers to remove salt or dirt from a dry windshield. Avoid using the wiper blades to remove frost or ice from the windshield. Keep the blade rubber out of contact with petroleum products such as engine oil, gasoline, etc.

### Windshield Wiper Blade Replacement

- Lift the wiper arm away from the glass.
- Push the release tab and slide the wiper blade assembly away from the wiper arm. Gently place the wiper arm on the windshield.
- Install the new blade assembly onto the wiper arm tip until it locks in place.

### Windshield Washers

The fluid reservoir in the engine compartment should be checked for fluid level at regular intervals. Fill the reservoir with windshield antifreeze (not radiator antifreeze) rated not to freeze at  $-25^{\circ}\text{F}$  ( $-31^{\circ}\text{C}$ ). Operate the system for a few seconds to flush out the residual water.

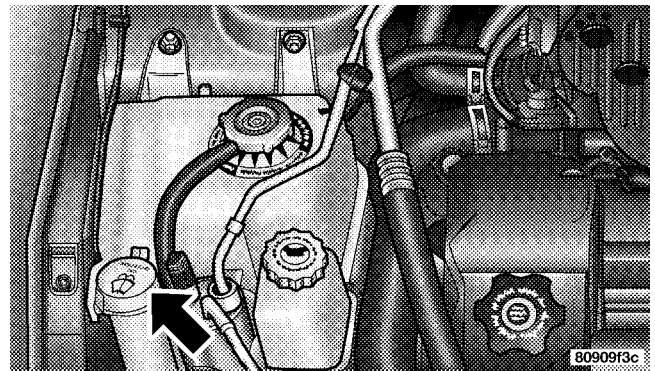

Washer Fluid Reservoir

#### WARNING!

Commercially available windshield washer solvents are flammable. They could ignite and burn you. Care must be exercised when filling or working around the washer solution.

### Exhaust System

The best protection against carbon monoxide entry into the vehicle body is a properly maintained engine exhaust system.

If you notice a change in the sound of the exhaust system; or if exhaust fumes can be detected inside the vehicle; or when the underside or rear of the vehicle is damaged; have a competent mechanic inspect the complete exhaust system and adjacent body areas for broken, damaged, deteriorated, or mispositioned parts. Open seams or loose connections could permit exhaust fumes to seep into the passenger compartment. In addition, inspect the exhaust system each time the vehicle is raised for lubrication or oil change. Replace as required.

#### WARNING!

Exhaust gases can injure or kill. They contain carbon monoxide (CO) which is colorless and odorless. Breathing it can make you unconscious and can eventually poison you. To avoid breathing CO, follow the preceding safety tips.

### Cooling System

#### WARNING!

- When working near the radiator cooling fan, disconnect the fan motor lead or turn the ignition switch to the OFF position. The fan is controlled by both the temperature of the engine cooling system and the pressure in the air conditioning system and can start at any time the ignition switch is in the ON position.
- You or others can be badly burned by hot coolant or steam from your radiator. If you see or hear steam coming from under the hood, don't open the hood until the radiator has had time to cool. Never try to open a cooling system pressure cap when the radiator is hot.

7

#### Coolant Checks

Check engine coolant (antifreeze) protection every 12 months (before the onset of freezing weather, where applicable). If coolant is dirty or rusty in appearance, the

system should be drained, flushed and refilled with fresh coolant. Check the front of the radiator for any accumulation of bugs, leaves, etc. If dirty, clean by gently spraying water from a garden hose vertically down the face of the condenser.

Check the coolant recovery bottle tubing for brittle rubber, cracking, tears, cuts and tightness of the connection at the bottle and radiator. Inspect the entire system for leaks.

#### **Cooling System — Drain, Flush and Refill**

At the intervals shown on the Maintenance Schedules, the system should be drained, flushed and refilled.

If the solution is dirty or contains a considerable amount of sediment, clean and flush with a reliable cooling system cleaner. Follow with a thorough rinsing to remove all deposits and chemicals. Properly dispose of old antifreeze solution.

#### **Selection Of Coolant**

Use only the manufacturer's recommended coolant, refer to Fluids, Lubricants and Genuine Parts for correct coolant type.

#### **CAUTION!**

Mixing of coolants other than specified HOAT engine coolants, may result in engine damage and may decrease corrosion protection. If a non-HOAT coolant is introduced into the cooling system in an emergency, it should be replaced with the specified coolant as soon as possible.

Do not use plain water alone or alcohol base engine coolant (antifreeze) products. Do not use additional rust inhibitors or antirust products, as they may not be compatible with the radiator engine coolant and may plug the radiator.

This vehicle has not been designed for use with Propylene Glycol based coolants. Use of Propylene Glycol based coolants is not recommended.

#### **Adding Coolant**

Your vehicle has been built with an improved engine coolant that allows extended maintenance intervals. This coolant can be used up to 5 Years or 100,000 miles before



replacement. To prevent reducing this extended maintenance period, it is important that you use the same coolant throughout the life of your vehicle. Please review these recommendations for using Hybrid Organic Additive Technology (HOAT) coolant.

When adding coolant, a minimum solution of 50% recommended Mopar Antifreeze/ Coolant 5 Year/100,000 Mile Formula HOAT (Hybrid Organic Additive Technology), or equivalent, in water should be used. Use higher concentrations (not to exceed 70%) if temperatures below  $-34^{\circ}\text{F}$  ( $-37^{\circ}\text{C}$ ) are anticipated.

Use only high purity water such as distilled or deionized water when mixing the water/engine coolant solution. The use of lower quality water will reduce the amount of corrosion protection in the engine cooling system.

Please note that it is the owner's responsibility to maintain the proper level of protection against freezing according to the temperatures occurring in the area where the vehicle is operated.

**NOTE:** Mixing coolant types will decrease the life of the engine coolant and will require more frequent coolant changes.

#### **Cooling System Pressure Cap**

The cap must be fully tightened to prevent loss of coolant, and to insure that coolant will return to the radiator from the coolant recovery bottle.

The cap should be inspected and cleaned if there is any accumulation of foreign material on the sealing surfaces.

**WARNING!**

- The warning words "DO NOT OPEN HOT" on the cooling system pressure cap are a safety precaution. Never add coolant when the engine is overheated. Do not loosen or remove the cap to cool an overheated engine. Heat causes pressure to build up in the cooling system. To prevent scalding or injury, do not remove the pressure cap while the system is hot or under pressure.
- Do not use a pressure cap other than the one specified for your vehicle. Personal injury or engine damage may result.

**Disposal of Used Engine Coolant**

Used ethylene glycol based engine coolant is a regulated substance requiring proper disposal. Check with your local authorities to determine the disposal rules for your community. To prevent ingestion by animals or children do not store ethylene glycol based engine coolant in open containers or allow it to remain in puddles on the

ground. If ingested by a child, contact a physician immediately. Clean up any ground spills immediately.

**Coolant Level**

The coolant bottle provides a quick visual method for determining that the coolant level is adequate. With the engine off and cold, the level of the coolant in the bottle should be between the ranges indicated on the bottle.

The radiator normally remains completely full, so there is no need to remove the radiator cap unless checking for coolant freeze point or replacing coolant. Advise your service attendant of this. As long as the engine operating temperature is satisfactory, the coolant bottle need only be checked once a month. Heater performance may also be adversely affected by low coolant levels.

When additional coolant is needed to maintain the proper level, it should be added to the coolant bottle. Do not overfill. Special procedures are required when filling the engine cooling system of the 2.7L Engine. See your authorized dealer for details.

### Points To Remember

**NOTE:** When the vehicle is stopped after a few miles (a few kilometers) of operation, you may observe vapor coming from the front of the engine compartment. This is normally a result of moisture from rain, snow, or high humidity accumulating on the radiator and being vaporized when the thermostat opens, allowing hot coolant to enter the radiator.

If an examination of your engine compartment shows no evidence of radiator or hose leaks, the vehicle may be safely driven. The vapor will soon dissipate.

- Do not overfill the coolant recovery bottle.
- Check coolant freeze point in the radiator and in the coolant recovery bottle. If antifreeze needs to be added, contents of coolant recovery bottle must also be protected against freezing.
- If frequent coolant additions are required, or if the level in the coolant recovery bottle does not drop when the engine cools, the cooling system should be pressure tested for leaks.

- Maintain coolant concentration at 50% HOAT engine coolant (minimum) and distilled water for proper corrosion protection of your engine which contains aluminum components.
- Make sure that the radiator and coolant recovery bottle overflow hoses are not kinked or obstructed.
- Keep the front of the radiator clean. If your vehicle is equipped with air conditioning, keep the front of the condenser clean, also.
- Do not change the thermostat for summer or winter operation. If replacement is ever necessary, install **ONLY** the correct type thermostat. Other designs may result in unsatisfactory coolant performance, poor gas mileage, and increased emissions.

### Hoses and Vacuum/Vapor Harnesses

Inspect surfaces of hoses and nylon tubing for evidence of heat and mechanical damage. Hard or soft spots, brittle rubber, cracking, checking, tears, cuts, abrasions, and excessive swelling indicate deterioration of the rubber.

Pay particular attention to those hoses nearest to high heat sources such as the exhaust manifold. Inspect hose routing to be sure hoses do not touch any heat source or moving component that may cause heat damage or mechanical wear.

Insure nylon tubing in these areas has not melted or collapsed. Inspect all hose connections such as clamps and couplings to make sure they are secure and no leaks are present. Components should be replaced immediately if there is any evidence of degradation that could cause failure.

### **Brakes**

In order to assure brake system performance, all brake system components should be inspected periodically. Suggested service intervals can be found in section 8.

### **WARNING!**

**Riding the brakes can lead to brake failure and possibly an accident. Driving with your foot resting or riding on the brake pedal can result in abnormally high brake temperatures, excessive lining wear, and possible brake damage. You may not have your full braking capacity in an emergency.**

### **Brake and Power Steering System Hoses**

When servicing the vehicle for scheduled maintenance, inspect surface of hoses and nylon tubing for evidence of heat and mechanical damage. Hard and brittle rubber, cracking, checking, tears, cuts, abrasion, and excessive swelling suggest deterioration of the rubber. Particular attention should be made to examining those hose surfaces nearest to high heat sources, such as the exhaust manifold.

Inspect all hose clamps and couplings to make sure they are secure and no leaks are present.

Insure nylon tubing in these areas has not melted or collapsed.

**NOTE:** Often, fluids such as oil, power steering fluid, and brake fluid are used during assembly plant operations to ease the assembly of hoses to couplings. Therefore, oil wetness at the hose-coupling area is not necessarily an indication of leakage. Actual dripping of hot fluid when systems are under pressure (during vehicle operation) should be noted before hose is replaced based on leakage.

**NOTE:** Inspection of brake hoses should be done whenever the brake system is serviced and every engine oil change.

### WARNING!

**Worn brake hoses can burst and cause brake failure. You could have an accident. If you see any signs of cracking, scuffing, or worn spots, have the brake hoses replaced immediately.**

### Master Cylinder

The fluid level in the master cylinder should be checked when performing under hood services, or immediately if the brake system warning lamp shows system failure.

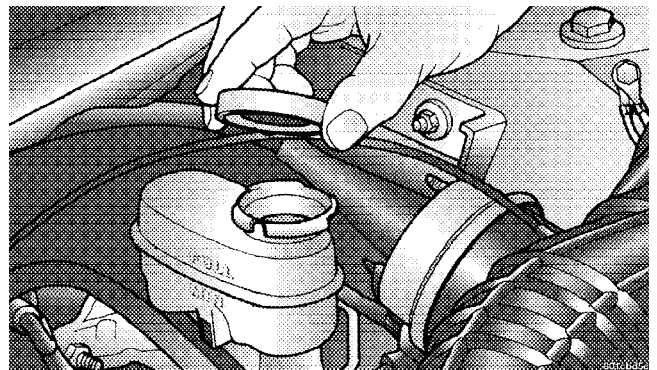

### Brake Fluid Reservoir

Be sure to clean the top of the master cylinder area before removing the cap. If necessary, fill brake fluid reservoir to the top of the fill mark chevron. With disc brakes, fluid level can be expected to fall as the brake pads wear. However, low fluid level may be caused by a leak and a checkup may be needed.

Use only manufacturer's recommended brake fluid, refer to Fluids, Lubricants and Genuine Parts for correct fluid type.

**WARNING!**

Use of a brake fluid that has a lower initial boiling point than MOPAR DOT 3 Brake Fluid or that is unidentified as to DOT FMVSS specification may result in sudden brake failure during hard or prolonged braking. You could have an accident.

**WARNING!**

Overfilling the brake fluid reservoir can result in spilling brake fluid on hot engine parts and the brake fluid catching fire.

Use only brake fluid that has been in a tightly closed container to avoid contamination from foreign matter.

Do not allow petroleum base fluid to contaminate the brake fluid as seal damage will result!

**Fuel System Hoses**

Electronic Fuel Injection high pressure fuel systems are designed with hoses and clamps which have unique material characteristics to provide adequate sealing and resist attack by deteriorated gasoline.

You are urged to use only manufacturer specified hoses and clamps, or their equivalent in material and specification, in any fuel system servicing. It is mandatory to replace all clamps that have been loosened or removed during service. Care should be taken in installing new clamps to insure they are properly torqued.

**Automatic Transmission**

Your front wheel drive vehicle has a transmission and differential assembly contained within a single housing. This is referred to as a "Transaxle."

### Selection of Lubricant

It is important that the proper lubricant is used in the transmission to assure optimum transmission performance. Use only manufacturers recommended transmission fluid, refer to Fluids, Lubricants and Genuine Parts for correct fluid type. It is important that the transmission fluid be maintained at the prescribed level using the recommended fluid.

#### CAUTION!

Using a transmission fluid other than the manufacturers recommended fluid may cause deterioration in transmission shift quality and/or torque converter shudder. Using a transmission fluid other than the manufacturers recommended fluid will result in more frequent fluid and filter changes. Refer to Fluids, Lubricants and Genuine Parts for correct fluid type.

### Procedure For Checking Fluid Level

The fluid level in the automatic transaxle should be checked whenever the vehicle is serviced. Operation with an improper fluid level will greatly reduce the life of the transaxle and of the fluid.

To properly check the automatic transaxle fluid level, the following procedure must be used:

- The vehicle must be on level ground.
- The engine should be running at curb idle speed for a minimum of 60 seconds.
- Fully apply parking brake.
- Place the gear selector momentarily in each gear position ending with the lever in P (PARK).
- Wipe the dipstick clean and reinsert until seated. Remove dipstick and note reading.
- If the fluid is cold (80°F / 27°C), the reading should be in the cross hatched area marked "COLD" (between the lower two holes in the dipstick).

- If the fluid is hot (180°F / 82°C), the reading should be in the cross hatched area marked "HOT" (between the upper two holes in the dipstick).
- If the fluid level shows low, add sufficient transmission fluid to bring to the proper level.

### CAUTION!

**Do not overfill. Dirt and water in the transaxle can cause serious damage. To prevent dirt and water from entering the transaxle after checking or replenishing fluid, make certain that the dipstick cap is seated properly.**

#### Fluid and Filter Changes

Automatic transmission fluid and filter should be changed as follows:

**Maintenance schedule "A"** — No change necessary.

**Maintenance schedule "B"** — Every 60,000 miles (96 000 km) change fluid and filter under the following conditions:

- Police, taxi, limousine, commercial type operation, or trailer towing where the vehicle is driven **regularly** for more than 45 minutes of continuous operation.

**NOTE:** Refer to Section 8 of this manual for maintenance schedules.

If the transaxle is disassembled for any reason, the fluid and filter should be changed.

#### Special Additives

The manufacture strongly recommends against the addition of any additives to the transaxle. The only exception to this policy is the use of special dyes to aid in detecting fluid leaks. The use of transmission sealers should be avoided as they may adversely affect seals.

#### Fluid Level Check

Check the fluid level by removing the fill plug. The fluid level should be between the bottom of the fill hole and a point not more than 4.0 mm below the bottom of the hole. Add fluid, if necessary, to maintain the proper level.



### Frequency of Fluid Change

Under normal operating conditions, the fluid installed at the factory will give satisfactory lubrication for the life of the vehicle. Fluid changes are not necessary unless the lubricant has become contaminated with water. If contaminated with water, the fluid should be changed immediately.

### Appearance Care And Protection From Corrosion

#### Protection of Body and Paint from Corrosion

Vehicle body care requirements vary according to geographic locations and usage. Chemicals that make roads passable in snow and ice, and those that are sprayed on trees and road surfaces during other seasons, are highly corrosive to the metal in your vehicle. Outside parking, which exposes your vehicle to airborne contaminants, road surfaces on which the vehicle is operated, extreme hot or cold weather and other extreme conditions will have an adverse effect on paint, metal trim, and underbody protection.

The following maintenance recommendations will enable you to obtain maximum benefit from the corrosion resistance built into your vehicle.

#### What Causes Corrosion?

Corrosion is the result of deterioration or removal of paint and protective coatings from your vehicle.

The most common causes are:

- Road salt, dirt and moisture accumulation.
- Stone and gravel impact.
- Insects, tree sap and tar.
- Salt in the air near seacoast localities.
- Atmospheric fallout/industrial pollutants.

#### Washing

- Wash your vehicle regularly. Always wash your vehicle in the shade using a mild car wash soap, and rinse the panels completely with clear water.
- If insects, tar or other similar deposits have accumulated on your vehicle, wash it as soon as possible.
- Use Mopar auto polish or equivalent to remove road film and stains and to polish your vehicle. Take care never to scratch the paint.

- Avoid using abrasive compounds and power buffing that may diminish the gloss or thin out the paint finish.

**CAUTION!**

Do not use abrasive or strong cleaning materials such as steel wool or scouring powder, which will scratch metal and painted surfaces.

**Special Care**

- If you drive on salted or dusty roads or if you drive near the ocean, hose off the undercarriage at least once a month.
- It is important that the drain holes in the lower edges of the doors, rocker panels and rear deck lid be kept clear and open.
- If you detect any stone chips or scratches in the paint, touch them up immediately. The cost of such repairs is considered the responsibility of the owner.
- Use Mopar touch up paint or equivalent on scratches or chips as soon as possible. Your dealer has touch up paint to match the color of your vehicle.
- If your vehicle is damaged due to an accident or similar cause which destroys the paint and protective coating have your vehicle repaired as soon as possible. The cost of such repairs is considered the responsibility of the owner.
- Aluminum wheels should be cleaned regularly with mild soap and water to prevent corrosion. To remove heavy soil, select a non abrasive, non acidic cleaner. Do not use scouring pads or metal polishes. Avoid automatic car washes that use acidic solutions or harsh brushes that may damage the wheels' protective finish.
- Your painted and chrome aluminum wheels should be treated as you would treat the finish on your car. Always use a soft non-abrasive cloth with a mild dish washing soap and water when cleaning your wheels. Never use scouring pads, steel wool or a bristle brush.

Never use cleaners that contain acid, oven cleaners or any abrasive metal cleaner as they will cause permanent staining and/or corrosion.

- If you carry special cargo such as chemicals, fertilizers, deicer salt, etc., be sure that such materials are well packaged and sealed.
- If a lot of driving is done on gravel roads, consider mud or stone shields behind each wheel.

**Interior Care**

Use Mopar Fabric Cleaner or equivalent to clean fabric upholstery and carpeting.

Use Mopar Vinyl Cleaner or equivalent to clean vinyl or leather upholstery.

Mopar Vinyl Cleaner or equivalent is specifically recommended for vinyl trim.

Use mild (Ivory Flake) solution or equivalent to clean all surfaces. Wipe with clear water and soft (lint free) cloth.

Do not use cleaners, conditioners and protectants containing silicon or bleach as these may cause gloss level increases and/or discoloration.

You should not increase the gloss level, especially on top of the instrument panel top surface. Higher gloss levels will increase the reflectivity in the windshield that could decrease visibility under bright light driving conditions.

<b>WARNING!</b>
<b>Do not use volatile solvents for cleaning purposes. Many are potentially flammable, and if used in closed areas they may cause respiratory harm.</b>

**Leather Seat Care and Cleaning**

<b>CAUTION!</b>
<b>Never use polishes, oils, cleaning fluids, solvents, detergents, or ammonia based cleaners to clean the leather. The leather has already been pretreated. The application of any leather conditioner may damage the factory applied top coat.</b>

Leather is best preserved by regular cleaning with a damp soft cloth. Small particles of dirt can act as an abrasive and damage the leather surface and should be removed immediately with a damp cloth. Stubborn soils can be removed easily with a soft cloth and Mopar Total Clean or equivalent. Care should be taken to avoid soaking the leather with any liquid.

#### **Cleaning Headlights**

Your vehicle has plastic headlights that are lighter and less susceptible to stone breakage than glass headlights.

Plastic is not as scratch resistant as glass and therefore different lens cleaning procedures must be followed.

To minimize the possibility of scratching the lenses and reducing light output, avoid wiping with a dry cloth. To remove road dirt, wash with a mild soap solution followed by rinsing.

Do not use abrasive cleaning components, solvents, steel wool or other aggressive material to clean the lenses.

#### **Glass Surfaces**

All glass surfaces should be cleaned on a regular basis with any commercial household-type glass cleaner. Never use an abrasive type cleaner. Use caution when cleaning inside rear windows equipped with electric defrosters. Do not use scrapers or other sharp instruments which may scratch the elements.

#### **Instrument Panel Cover**

The instrument panel cover has a low glare surface which minimizes reflections in the windshield. Do not use protectants or other products which may cause undesirable reflections. Use soap and warm water to restore the low glare surface.

#### **Cleaning Wood Trim**

Your vehicle's wood trim requires no specific maintenance. Your wood trim can be cleaned as needed using regularly available automotive interior cleaning and protecting products. Using a mild soap and water solution is also acceptable. Excess cleaning materials should be wiped dry with a soft terry cloth. Any harsh detergents, abrasives, abrasive cleaners, cleansers, or chemicals should be avoided, as these will damage the wood trim.

**Cleaning Plastic Instrument Cluster Lenses**

The lenses in front of the instruments in this vehicle are molded in clear plastic. When cleaning the lenses, care must be taken to avoid scratching the plastic.

- Clean with a wet soft rag. A mild soap solution may be used, but do not use high alcohol content or abrasive cleaners. If soap is used, wipe clean with a clean damp rag.
- Dry with a soft tissue.

**Seat Belt Maintenance**

Do not bleach, dye or clean the belts with chemical solvents or abrasive cleaners. This will weaken the fabric. Sun damage will also weaken the fabric.

If the belts need cleaning, use a mild soap solution or lukewarm water. Do not remove the belts from the vehicle to wash them.

Replace the belts if they appear frayed or worn or if the buckles do not work properly.

**FUSES**

**Underhood Fuses (Power Distribution Center)**

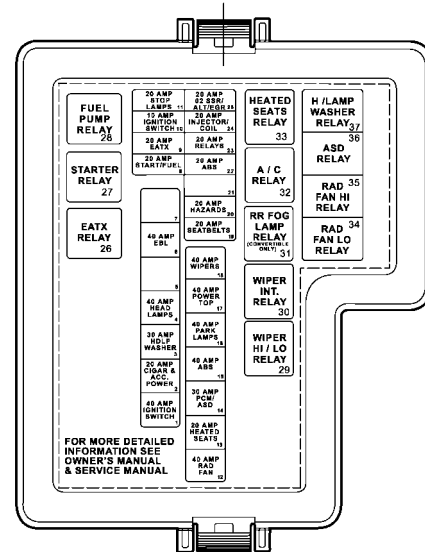

Power Distribution Center

810d5788

A Power Distribution Center is located in the engine compartment; near the air cleaner. This information applies to vehicles built without the fuse and relay numbering embossed on the Power Distribution Center Top Cover.

#### Interior Fuses



Fuse Panel Cover

The fuse access panel is behind the end cover at the left side of the instrument panel. To remove the panel, pull it out, as shown.

The identity of each fuse is indicated on the backside of the cover.

Cavity	Fuse	Circuit
1	30 Amp Green	Blower Motor
2	10 Amp Red	Right High Beam Headlight, High Beam Indicator
3	10 Amp Red	Left High Beam Headlight
4	15 Amp Blue	Power Door Lock Switch Illumination, Transmission Range Switch, Daytime Running Light Module (Canada), Power Windows, Anti-lock Brake System Module
5	10 Amp Red	Power Door Lock and Door Lock Arm/Disarm Switches, Vanity, Reading, Map, Rear Seating, Ignition, and Trunk Lights, Illuminated Entry, Radio, Power Antenna, Data Link Connector, Body Control Module, Power Amplifier

Cavity	Fuse	Circuit
6	10 Amp Red	Heated Rear Window Indicator
7	20 Amp Yellow	Instrument cluster illumination, Park and tail Lights
8	20 Amp Yellow	Power Receptacle, Horns, Ignition, Fuel, Start
9	15 Amp Blue	Power Door Lock Motors (Body Control Module)
10	20 Amp Yellow	Daytime Running Light Module (Canada)
11	10 Amp Red	Instrument Cluster, Transmission Control, Park/Neutral Switch, Body Control Module
12	10 Amp Red	Left Low beam Headlight
13	20 Amp Yellow	Right Low Beam Headlight, Fog Light Switch
14	10 Amp Red	Radio

Cavity	Fuse	Circuit
15	10 Amp Red	Turn Signal and Hazard Flashers, Wiper Switch, Seat Belt Control Module, Wiper Relays, Rear Window Defroster Relay
16	10 Amp Red	Airbag Control Module
17	10 Amp	Airbag Control Module
18	20 Amp C/BRKR	Power Seat Switch, Remote Trunk Release
19	30 Amp C/BRKR	Power Windows

**CAUTION!**

When replacing a blown fuse, it is important to use only a fuse having the correct amperage rating. The use of a fuse with a rating other than indicated may result in a dangerous electrical system overload. If a properly rated fuse continues to blow, it shows a problem in the circuit that must be corrected.

**VEHICLE STORAGE**

If you are leaving your vehicle dormant for more than 21 days you may want to take steps to protect your battery. You may:

- Disconnect the negative cable from the battery.
- Anytime you store your vehicle, or keep it out of service (i.e. vacation) for two weeks or more, run the air conditioning system at idle for about five minutes in the fresh air and high blower setting. This will insure adequate system lubrication to minimize the possibility of compressor damage when the system is started again.

**REPLACEMENT LIGHT BULBS**

<b>LIGHT BULBS — Interior</b>	<b>Bulb Number</b>
ABS Lamp . . . . .	PC 161
Instrument Cluster . . . . .	PC 194
Fog Light Indicator . . . . .	PC 161
Dome Light . . . . .	578
Front Reading/Map Lights . . . . .	906
Trunk Light . . . . .	562
Cup Holder Light . . . . .	37
Climate Control Light . . . . .	37
Traction Control Light . . . . .	PC161

<b>LIGHT BULBS — Exterior</b>	<b>Bulb Number</b>
Headlight . . . . .	9007
Park/Turn Signal (Front) . . . . .	3157A
Fog Light . . . . .	880L
Tail/Stop/Turn Signal . . . . .	3157
Back Up Light . . . . .	921
Center Stop Light . . . . .	921
License Light . . . . .	2825



**BULB REPLACEMENT**

**Headlight Bulb Replacement**

1. Open the hood and remove the two headlight mounting screws.

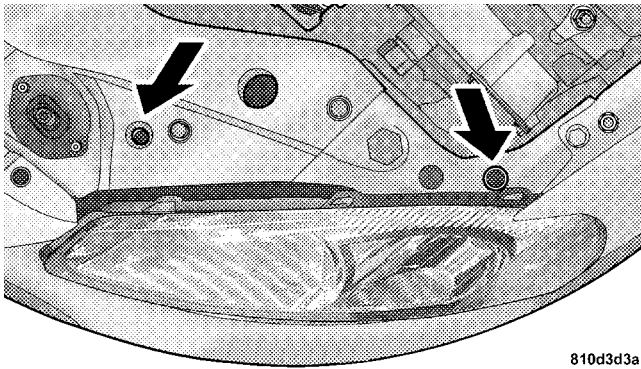

810d3d3a

2. Remove the push-in fasteners by prying under the head of the fasteners with a flat bladed tool.

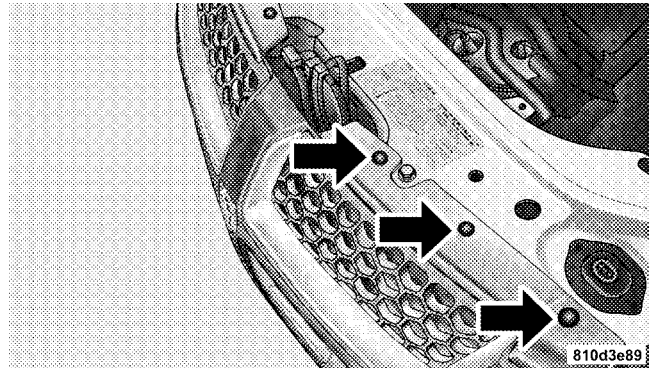

810d3e89

3. Gently pry the headlight assembly away from the fender as shown in the picture. This will free the ball stud from its retainer in the fender. Pull the headlight assembly away from the vehicle.

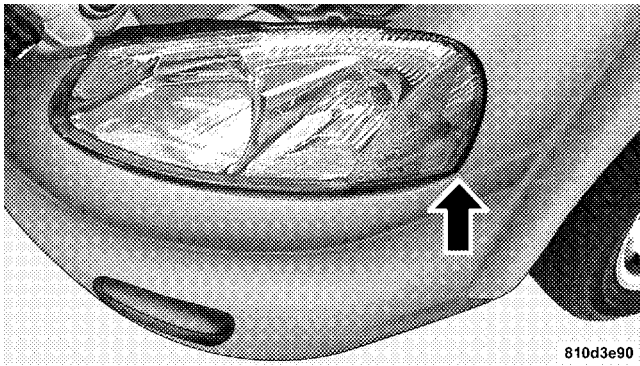

4. Turn the retaining ring counterclockwise and remove the bulb and socket assembly.

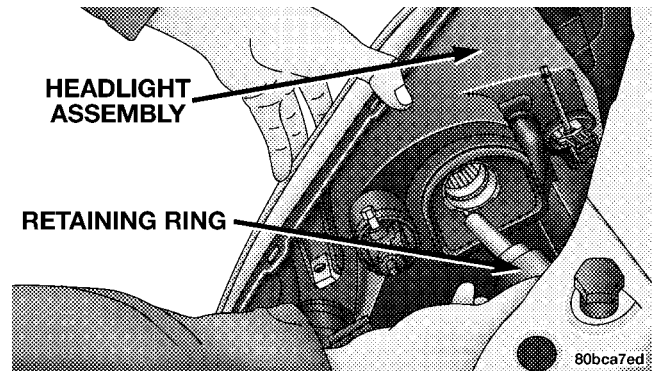

5. Pull the bulb out of the socket and replace the bulb.

<b>CAUTION!</b>
Do not touch the new bulb with your fingers. Oil contamination will severely shorten bulb life.

6. If the bulb comes in contact with any oily surface, clean the bulb with rubbing alcohol.
7. Reinsert the bulb and socket assembly and turn the retaining ring clockwise to secure the bulb.
8. Reinstall the headlight assembly.

**Park, Turn Signal, Sidemarker Bulb Replacement**

1. Open the hood and remove the two headlight assembly mounting screws. Pull the headlight assembly away from the vehicle.

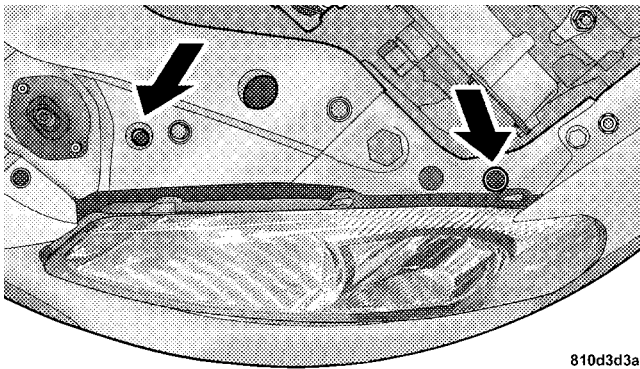

2. Turn the bulb socket counterclockwise and remove the bulb and socket assembly.

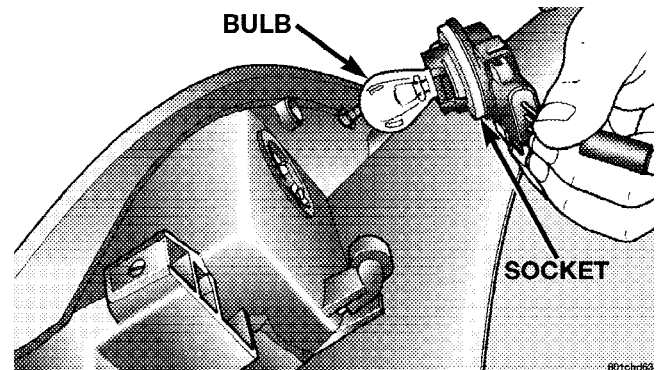

3. Pull the bulb out of the socket, replace the bulb, and reinstall the bulb and socket to the headlight assembly. Reinstall the headlight assembly.

### Fog Light Bulb Replacement

1. Remove the screw securing the light assembly to the front fascia.

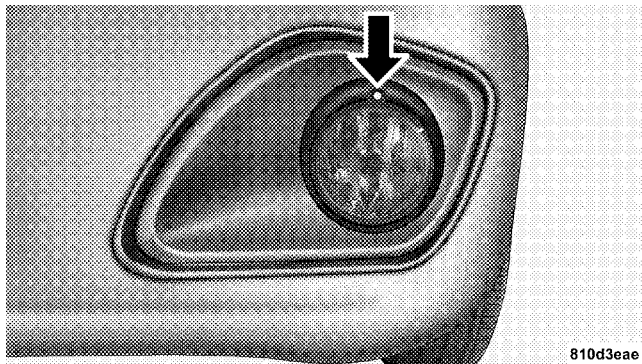

2. Pull the light assembly away from the vehicle to expose the bulb and socket assembly.

3. Disconnect the wiring connector from the bulb and socket assembly.

4. Turn the bulb and socket assembly counterclockwise to remove it from the housing.

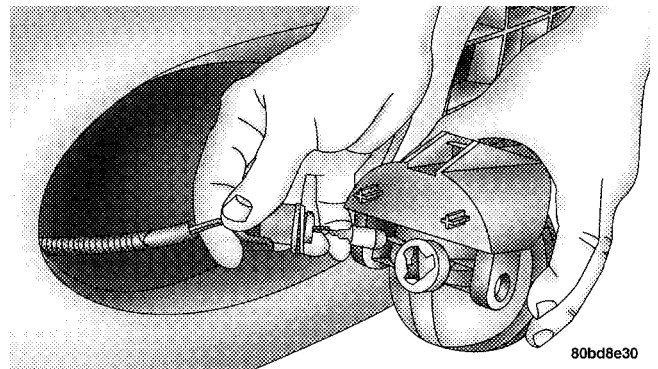

5. Install the new bulb and socket assembly, reattach the wiring connector, and reinstall the fog light assembly.

### Center Stoplight Bulb Replacement

1. Open the trunk. Turn the bulb socket counterclockwise to remove it from the housing.

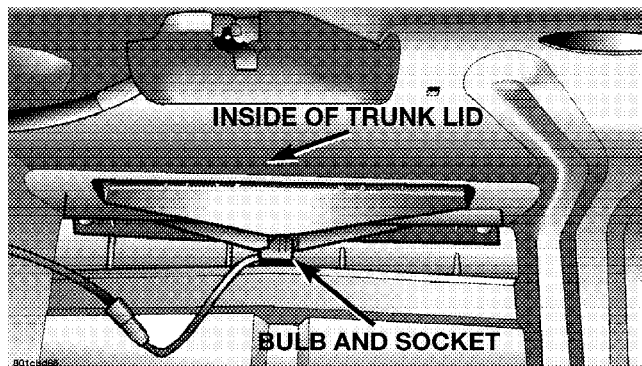

2. Pull the bulb out of the socket, replace the bulb and reinstall the bulb and socket assembly.

### Rear Light Bulb Replacement

1. Open the trunk and pull the trunk liner away to expose the wiring connector and light housing plastic retainers.

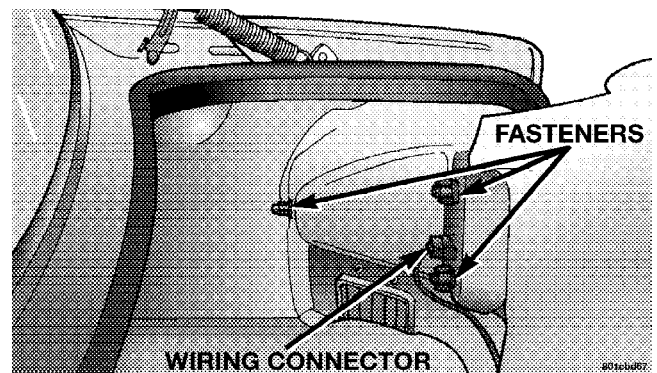

2. Disconnect the wiring connector and remove the plastic retainers. Remove the light housing from the vehicle.
3. Turn the bulb socket counterclockwise to remove it from the housing. Remove and replace the bulb then reinstall the bulb and socket assembly.
4. Reinstall the light housing and reconnect the wiring connector. Push the trunk liner back into place.

**License Plate Bulb Replacement**

1. Locate both small slots on the outboard side of the license lamp. Using a small screwdriver, remove the entire housing.
2. Turn the bulb socket counterclockwise to remove it from the housing. Pull the bulb out of the socket. Replace the bulb and snap it back into place on the housing of the chrome appliqué.

**Headlight Aiming**

The headlights on your new vehicle were aimed at the factory. The factory setting was made at a no load setting. A great increase in weight will change the aiming and it may be necessary to readjust the headlights if carrying an excessive amount of weight in the trunk, rear seats or pulling a trailer. To readjust the headlights first mark the position of the headlights on a wall prior to loading the vehicle. Load the vehicle and then readjust the headlights to the original position. If any further adjustments are necessary contact your manufacturer's dealer. A detailed service procedure is contained in the manufacturer's Service Manual. Information on purchasing a Service Manual can be found at the back of this Owner's Manual.

**FLUIDS AND CAPACITIES**

	U.S.	Metric
<b>Fuel (approximate)</b>		
2.4 and 2.7 Liter Engines (87 Octane)	16 Gallons	61 Liters
<b>Engine Oil-With Filter</b>		
2.4 and 2.7 Liter Engines (Refer to the engine oil fill cap for the correct SAE grade)	5 qts.	4.7 Liters
<b>Cooling System *</b>		
2.4 Liter Engines* (Mopar® Antifreeze/Coolant 5 Year/100,000 Mile Formula) or equivalent.	8 qts.	7.5 Liters
2.7 Liter Engines (Mopar® Antifreeze/Coolant 5 Year/100,000 Mile Formula) or equivalent.	9.5 qts.	9.0 Liters

\* Includes 1 qt. for coolant tank.

**FLUIDS, LUBRICANTS AND GENUINE PARTS**

**Engine**

<b>Component</b>	<b>Fluid, Lubricant, or Genuine Part</b>
Engine Coolant	Mopar® Antifreeze/Coolant 5 Year/100,000 Mile Formula HOAT (Hybrid Organic Additive Technology) or equivalent.
Engine Oil	Use API Certified engine oil. SAE 5W-20 and SAE 5W-30 are recommended. Refer to the engine oil fill cap for the correct SAE grade meeting DaimlerChrysler Material Standard MS-6395.
Spark Plugs	Refer to the Vehicle Emission Control Information label under the engine hood.
Oil Filter (2.4L Engine)	Mopar® Oil Filter (P/N 4105409) or equivalent.
Oil Filter (2.7L Engine)	Mopar® Oil Filter (P/N 5281090) or equivalent.
Fuel Selection	87 Octane

**Chassis**

<b>Component</b>	<b>Fluid, Lubricant, or Genuine Part</b>
Automatic Transaxle	Mopar® ATF+4 Automatic Transmission Fluid.
Brake Master Cylinder	Mopar® DOT 3, SAE J1703 should be used. If DOT 3, SAE J1703 brake fluid is not available, then DOT 4 is acceptable. Use only recommended brake fluids.
Power Steering Reservoir	Mopar® Power Steering Fluid + 4, Mopar® ATF+4 Automatic Transmission Fluid.
Steering Gear & Linkage, Ball Joints, Prop Shafts & Yokes, Wheel Bearings	Mopar® Multi-Purpose Lubricant NLGI Grade 2 or equivalent.



---

## MAINTENANCE SCHEDULES

### CONTENTS

---

■ Emission Control System Maintenance . . . . .	250	□ Schedule "B" . . . . .	253
■ Maintenance Schedules . . . . .	250	□ Schedule "A" . . . . .	263

**EMISSION CONTROL SYSTEM MAINTENANCE**

The “Scheduled” maintenance services, listed in **bold type** must be done at the times or mileages specified to assure the continued proper functioning of the emission control system. These, and all other maintenance services included in this manual, should be done to provide best vehicle performance and reliability. More frequent maintenance may be needed for vehicles in severe operating conditions such as dusty areas and very short trip driving.

Inspection and service also should be done any time a malfunction is suspected.

**NOTE:** Maintenance, replacement, or repair of the emission control devices and systems on your vehicle may be performed by any automotive repair establishment or individual using any automotive part which has been certified pursuant to U.S. EPA or, in the State of California, California Air Resources Board regulations.

**MAINTENANCE SCHEDULES**

There are two maintenance schedules that show the **required** service for your vehicle.

First is Schedule “**B**”. It is for vehicles that are operated under the conditions that are listed below and at the beginning of the schedule.

- Day or night temperatures are below 32° F (0° C).
- Stop and go driving.
- Extensive engine idling.
- Driving in dusty conditions.
- Short trips of less than 10 miles (16 km).
- More than 50% of your driving is at sustained high speeds during hot weather, above 90° F (32° C).
- Trailer towing. ◇

- Taxi, police, or delivery service (commercial service). ◇
- Off-road or desert operation.
- If equipped for and operating with E-85 (ethanol) fuel.

**NOTE:** If ANY of these apply to you then change your engine oil every 3,000 miles (5,000 km) or 3 months, whichever comes first and follow schedule B of the "Maintenance Schedules" section of this manual.

**NOTE:** IF ANY of these apply to you then flush and replace the engine coolant every 100,000 miles (160,000 km) or 60 months, whichever comes first, and follow schedule B of the "Maintenance Schedules" section of this manual.

**NOTE:** Most vehicles are operated under the conditions listed for Schedule "B".

Second is Schedule "A". It is for vehicles that are not operated under any of the conditions listed under Schedule "B".

Use the schedule that best describes your driving conditions. Where time and mileage are listed, follow the interval that occurs first.

**NOTE:** Under no circumstances should oil change intervals exceed 6 months or 6,000 miles, whichever comes first.

**CAUTION!**

Failure to perform the required maintenance items may result in damage to the vehicle.

*At Each Stop for Fuel*

- Check the engine oil level about 5 minutes after a fully warmed engine is shut off. Checking the oil level while the vehicle is on level ground will improve the accuracy of the oil level reading. Add oil only when the level is at or below the ADD or MIN mark.
- Check the windshield washer solvent and add if required.

**252 MAINTENANCE SCHEDULES**

*Once a Month*

- Check tire pressure and look for unusual wear or damage.
- Inspect the battery and clean and tighten the terminals as required.
- Check the fluid levels of coolant reservoir, brake master cylinder, and transaxle and add as needed.
- Check all lights and all other electrical items for correct operation.
- Check rubber seals on each side of the radiator for proper fit.

*At Each Oil Change*

- Change the engine oil filter.
- Inspect the exhaust system.
- Inspect the brake linings, hoses and calipers.
- Inspect the CV joints and front and rear suspension components.
- Check the automatic transmission fluid level.
- Check the brake master cylinder fluid level.
- Check the coolant level, hoses, and clamps.

**NOTE:** In 2.7L Engines equipped with Flex Fuel Engine (FFV), change engine oil every 5 months or 5,000 miles, whichever comes first. This applies to both Maintenance Schedule A and B.

**SCHEDULE "B"**

Follow schedule "B" if you usually operate your vehicle under one or more of the following conditions. Change the automatic transmission fluid and filter every 60,000 miles (96 000 km) if the vehicle is usually operated under one or more of the conditions marked with an ◇.

- Day or night temperatures are below 32° F (0° C).
- Stop and go driving.
- Extensive engine idling.
- Driving in dusty conditions.
- Short trips of less than 10 miles (16.2 km).
- More than 50% of your driving is at sustained high speeds during hot weather, above 90° F (32° C).
- Trailer towing. ◇

- Taxi, police or delivery service (commercial services). ◇
- Off-road or desert operation.
- If equipped for and operating with E-85 (ethanol) fuel.

**NOTE:** If ANY of these apply to you then change your engine oil every 3,000 miles (5 000 km) or 3 months, whichever comes first and follow schedule "B" of the "Maintenance Schedules" section of this manual.

**NOTE:** IF ANY of these apply to you then flush and replace the engine coolant every 100,000 miles (160,000 km) or 60 months, whichever comes first, and follow schedule B of the "Maintenance Schedules" section of this manual.

254 SCHEDULE "B"

Miles (Kilometers)	3,000 (5 000)	6,000 (10 000)	9,000 (15 000)	12,000 (20 000)	15,000 (25 000)	18,000 (30 000)
Change engine oil and engine oil filter, if not replaced at 3 months.	X	X	X	X	X	X
Inspect the air cleaner filter and replace if necessary.*	X	X	X	X	X	X
Inspect the front and rear brake pads, linings, rotors, rear drums and shoes.				X		
Rotate the tires.		X		X		X

Miles (Kilometers)	21,000 (35 000)	24,000 (40 000)	27,000 (45 000)	30,000 (50 000)	33,000 (55 000)	36,000 (60 000)
Change engine oil and engine oil filter, if not replaced at 3 months.	X	X	X	X	X	X
Inspect the air cleaner filter and replace if required.*	X	X	X		X	X
Replace the air cleaner filter.				X		
Inspect and check tension for power steering belt (2.4 Liter Engine). Adjust or replace if required.				X		
Inspect the front and rear brake pads, linings, rotors, rear drums and shoes.		X				X
Check and replace, if necessary, the PCV valve. *				X		
Replace the spark plugs on 2.4 liter engine.				X		
Rotate the tires.		X		X		X

256 SCHEDULE "B"

Miles (Kilometers)	39,000 (65 000)	42,000 (70 000)	45,000 (75 000)	48,000 (80 000)	51,000 (85 000)	54,000 (90 000)
Change engine oil and engine oil filter, if not replaced at 3 months.	X	X	X	X	X	X
Inspect the air cleaner filter and replace if necessary.*	X	X	X	X	X	X
Inspect the front and rear brake pads, linings, rotors, rear drums and shoes.				X		
Rotate the tires.		X		X		X



Miles (Kilometers)	57,000 (95 000)	60,000 (100 000)	63,000 (105 000)	66,000 (110 000)	69,000 (115 000)	72,000 (120 000)
Change engine oil and engine oil filter, if not replaced at 3 months.	X	X	X	X	X	X
Inspect the air cleaner filter and replace if necessary.*	X		X	X	X	X
Replace the air cleaner filter.		X				
Inspect and check tension for power steering belt (2.4 Liter Engine). Adjust or replace if required.		X				
Inspect the front and rear brake pads, linings, rotors, rear drums and shoes.		X				X
Replace the ignition cables on 2.4 liter engine.		X				
Replace the accessory drive belts on the 2.7 liter engine.		X				
Replace the spark plugs on the 2.4 liter engine.		X				
Check and replace, if necessary, the PCV valve. *†		X				

258 SCHEDULE "B"

Miles (Kilometers)	57,000 (95 000)	60,000 (100 000)	63,000 (105 000)	66,000 (110 000)	69,000 (115 000)	72,000 (120 000)
Change the automatic transmission fluid and filter. ◇		X				
Rotate the tires.		X		X		X
Flush and replace engine coolant at 60 months, if not done at 100,000 miles.		X				

Miles (Kilometers)	75,000 (125 000)	78,000 (130 000)	81,000 (135 000)	84,000 (140 000)	87,000 (145 000)	90,000 (150 000)
Change engine oil and engine oil filter, if not replaced at 3 months.	X	X	X	X	X	X
Inspect the air cleaner filter and replace if necessary.*	X	X	X	X	X	
Replace the air cleaner filter.						X
Inspect and check tension for power steering belt (2.4 Liter Engine). Adjust or replace if required.						X
Replace the engine timing belt on 2.4 liter engine.						X
Inspect the front and rear brake pads, linings, rotors, rear drums and shoes.				X		
Replace the spark plugs on 2.4 liter engine.						X
Check and replace, if necessary, the PCV valve. *‡						X
Rotate the tires.		X		X		X

260 SCHEDULE "B"

Miles (Kilometers)	93,000 (155 000)	96,000 (160 000)	99,000 (165 000)	100,000 (170 000)	102,000 (175 000)	105,000 (180 000)
Change engine oil and engine oil filter, if not replaced at 3 months.	X	X	X		X	X
Inspect the air cleaner filter and replace if necessary.*	X	X	X		X	X
Inspect the front and rear brake pads, linings, rotors, rear drums and shoes.		X				
Replace the spark plugs on the 2.7 liter engine.				X		
Check and re-tension accessory drive belts on 2.7 liter engine.						X
Replace the accessory drive belts on 2.4 liter engine.					X	
Rotate the tires.		X		X		X
Flush and replace the engine coolant, if not replaced at 60 months.				X		

Miles (Kilometers)	108,000 (185 000)	111,000 (190 000)	114,000 (195 000)	117,000 (200 000)	120,000 (205 000)
Change engine oil and engine oil filter, if not replaced at 3 months.	X	X	X	X	X
Inspect the air cleaner filter and replace if necessary.*	X	X	X	X	
Replace the air cleaner filter.					X
Replace the spark plugs on the 2.4 liter engine.					X
Replace the ignition cables on the 2.4 liter engine.					X
Inspect the front and rear brake pads, linings, rotors, rear drums and shoes.	X				X
Inspect and check tension for power steering belt (2.4 Liter Engine). Adjust or replace if required.					X
Replace the accessory drive belts on the 2.7 liter engine.					X
Check and replace, if necessary, the PCV valve. *					X
Change the automatic transmission fluid and filter. ◇					X

262 SCHEDULE "B"

Miles (Kilometers)	108,000 (185 000)	111,000 (190 000)	114,000 (195 000)	117,000 (200 000)	120,000 (205 000)
Flush and replace engine coolant at 120 months, if not done at 100,000 miles.					X
Rotate the tires.		X		X	

\* This maintenance is recommended by the manufacture to the owner but is not required to maintain the emissions warranty.

‡ This maintenance is not required if previously replaced.

Inspection and service should also be performed anytime a malfunction is observed or suspected. Retain all receipts.

**SCHEDULE "A"**

Miles (Kilometers) [Months]	6,000 (10 000) [6]	12,000 (20 000) [12]	18,000 (30 000) [18]	24,000 (40 000) [24]	30,000 (50 000) [30]	36,000 (60 000) [36]
Change engine oil and engine oil filter.	X	X	X	X	X	X
Inspect the air cleaner filter and replace if necessary.*	X	X	X	X		X
Replace the air cleaner filter.					X	
Replace the spark plugs on 2.4 liter engine.					X	
Inspect the front and rear brake pads, linings, rotors, rear drums and shoes.			X			X
Rotate the tires.	X	X	X	X	X	X

264 SCHEDULE "A"

Miles (Kilometers)	42,000 (70 000)	48,000 (80 000)	54,000 (90 000)	60,000 (100 000)	66,000 (110 000)	72,000 (120 000)
[Months]	[42]	[48]	[54]	[60]	[66]	[72]
Change engine oil and engine oil filter.	X	X	X	X	X	X
Inspect the air cleaner filter and replace if required.*	X	X	X		X	X
Replace the air cleaner filter.				X		
Inspect and check tension for power steering belt (2.4 Liter Engine). Adjust or replace if required.				X		
Inspect the front and rear brake pads, linings, rotors, rear drums and shoes.			X			X
Replace the spark plugs on 2.4 liter engine.				X		
Flush and replace the engine coolant at 60 months, if not done at 100,000 miles.				X		
Check and replace, if necessary, the PCV valve.*				X		
Replace the ignition cables on 2.4 liter engine.				X		
Replace the accessory drive belts in 2.7 liter engine.				X		
Rotate the tires.	X	X	X	X	X	X



Miles (Kilometers)	78,000 (130 000)	84,000 (140 000)	90,000 (150 000)	96,000 (160 000)	100,000 (170 000)	102,000 (180 000)	105,000 (190 000)
[Months]	[78]	[84]	[90]	[96]		[102]	[105]
Change engine oil and engine oil filter.	X	X	X	X		X	
Inspect the air cleaner filter and replace if required.*	X	X		X		X	
Replace the air cleaner filter.			X				
Inspect the front and rear brake pads, linings, rotors, rear drums and shoes.			X				
Replace the spark plugs on 2.4 liter engine.			X				
Replace the spark plugs on 2.7 liter engine.						X	
Check and replace, if necessary, the PCV valve. *‡			X				
Check and re-tension alternator drive belts on 2.7 liter engine.						X	

266 SCHEDULE "A"

Miles (Kilometers) [Months]	78,000 (130 000) [78]	84,000 (140 000) [84]	90,000 (150 000) [90]	96,000 (160 000) [96]	100,000 (170 000)	102,000 (180 000) [102]	105,000 (190 000) [105]
Replace the accessory drive belts on 2.4L engine.						X	
Flush and replace the engine coolant, if not replaced at 60 months.					X		
Rotate the tires.	X	X	X	X		X	X

Miles (Kilometers)	108,000 (200 000)	114,000 (210 000)	120,000 (220 000)
[Months]	[108]	[114]	[120]
Change engine oil and engine oil filter.	X	X	X
Inspect the air cleaner filter and replace if required.*	X	X	
Replace the air cleaner filter.			X
Inspect the front and rear brake pads, linings, rotors, rear drums and shoes.	X		
Replace the spark plugs on 2.4 liter engine.			X
Check and replace, if necessary, the PCV valve. *‡			X
Replace the engine timing belt on 2.4 liter engine.			X
Inspect and check tension for power steering belt (2.4 Liter Engine). Adjust or replace if required.			X
Replace the accessory drive belts in 2.7 liter engine.			X
Replace the ignition cables on 2.4 liter engine.			X
Flush and replace engine coolant at 120 months, if not done at 100,000 miles.			X
Rotate the tires.	X	X	X

\* This maintenance is recommended by the manufacture to the owner but is not required to maintain the emissions warranty.

‡ This maintenance is not required if previously replaced.

## 268 SCHEDULE "A"

Inspection and service should also be performed anytime a malfunction is observed or suspected. Retain all receipts.

**WARNING!**

You can be badly injured working on or around a motor vehicle. Do only that service work for which you have the knowledge and the right equipment. If you have any doubt about your ability to perform a service job, take your vehicle to a competent mechanic.

---

## IF YOU NEED CONSUMER ASSISTANCE

### CONTENTS

---

■ Suggestions For Obtaining Service For Your Vehicle . . . . .	270	■ Reporting Safety Defects . . . . .	273
□ Prepare For The Appointment . . . . .	270	□ In Canada . . . . .	273
□ Prepare A List . . . . .	270	■ Publication Order Forms . . . . .	273
□ Be Reasonable With Requests . . . . .	270	■ Department Of Transportation Uniform Tire Quality Grades . . . . .	275
■ If You Need Assistance . . . . .	270	□ Treadwear . . . . .	275
■ Warranty Information (U.S. Vehicles Only) . . . . .	272	□ Traction Grades . . . . .	275
■ Mopar® Parts . . . . .	272	□ Temperature Grades . . . . .	276

**SUGGESTIONS FOR OBTAINING SERVICE FOR YOUR VEHICLE****Prepare For The Appointment**

If you're having warranty work done, be sure to have the right papers with you. Take your warranty folder. All work to be performed may not be covered by the warranty, discuss additional charges with the service manager. Keep a maintenance log of your vehicle's service history. This can often provide a clue to the current problem.

**Prepare A List**

Make a written list of your vehicle's problems or the specific work you want done. If you've had an accident, or work done that is not on your maintenance log, let the service advisor know.

**Be Reasonable With Requests**

If you list a number of items, and you must have your vehicle by the end of the day, discuss the situation with the service advisor and list the items in order of priority. At many dealers you may obtain a rental vehicle at a

minimal daily charge. If you need a rental, it is advisable to make these arrangements when you call for an appointment.

**IF YOU NEED ASSISTANCE**

The manufacturer and its dealers are vitally interested in your satisfaction. We want you to be happy with our products and services.

Warranty service must be done by an authorized Chrysler, Dodge, or Jeep dealer. We strongly recommend that you take your vehicle to your selling dealer. They know you and your vehicle best, and are most concerned that you get prompt and high quality service. The manufacturer's dealers have the facilities, factory-trained technicians, special tools, and the latest information to assure your vehicle is fixed correctly and in a timely manner.

This is why you should always talk to your dealer's service manager first. Most matters can be resolved with this process.

- If for some reason you are still not satisfied, talk to the general manager or owner of the dealership. They want to know if you need assistance.
- If your dealership is unable to resolve the concern, you may contact the Manufacturer's Customer Center.

Any communication to the Manufacturer's Customer Center should include the following information:

- Owner's name and address
- Owner's telephone number (home and office)
- Dealership name
- Vehicle identification number
- Vehicle delivery date and mileage

*DaimlerChrysler Motors Corporation Customer Center*

P.O. Box 21-8004  
 Auburn Hills, MI 48321-8004  
 Phone: (800) 992-1997

*DaimlerChrysler Canada Inc. Customer Center*

P.O. Box 1621  
 Windsor, Ontario N9A 4H6  
 Phone —(800) 465-2001

*In Mexico contact:*

Av. Prolongacion Paseo de la Reforma, 1240  
 Sante Fe C.P. 05109  
 Mexico, D. F.  
 In Mexico (915) 729-1248 or 729-1240  
 Outside Mexico (525) 729-1248 or 729-1240

*Customer Assistance For The Hearing Or Speech Impaired (TDD/TTY)*

To assist customers who have hearing difficulties, the manufacturer has installed special TDD (Telecommunication Devices for the Deaf) equipment at its Customer Center. Any hearing or speech impaired customer who has access to a TDD or a conventional teletypewriter (TTY) in the United States can communicate with the manufacturer by dialing 1-800-380-CHRY.

***Service Contract***

You may have purchased a service contract for your vehicle to help protect you from the high cost of unexpected repairs after your manufacturer's new vehicle limited warranty expires. The manufacturer stands behind only the manufacturer's Service Contracts. If you purchased a manufacturer's Service Contract, you will receive Plan Provisions and an Owner Identification Card in the mail within three weeks of your vehicle delivery date. If you have any questions about your service contract, call the manufacturer's Service Contract National Customer Hotline at 1-800-521-9922.

The manufacturer will not stand behind any service contract that is not the manufacturer's Service Contract. It is not responsible for any service contract other than the manufacturer's Service Contract. If you purchased a service contract that is not a manufacturer's Service Contract, and you require service after your manufacturer's new vehicle limited warranty expires, please refer to your contract documents, and contact the person listed in those documents.

We appreciate that you have made a major investment when you purchased your new vehicle. Your dealer has also made a major investment in facilities, tools, and training to assure that you are absolutely delighted with your ownership experience. You'll be pleased with their sincere efforts to resolve any warranty issues or related concerns.

**WARRANTY INFORMATION (U.S. Vehicles Only)**

See the Warranty Information Booklet for the terms and provisions of DaimlerChrysler's warranties applicable to this vehicle.

**MOPAR® PARTS**

Mopar® fluids, lubricants, parts, and accessories are available from your dealer. They will help you keep your vehicle operating at its best.



**REPORTING SAFETY DEFECTS**

In the 50 United States and Washington D.C.: If you believe that your vehicle has a defect which could cause a crash or cause injury or death, you should immediately inform the National Highway Traffic Safety Administration (NHTSA) in addition to notifying the manufacturer.

If NHTSA receives similar complaints, it may open an investigation, and if it finds that a safety defect exists in a group of vehicles, it may order a recall and remedy campaign. However, NHTSA cannot become involved in individual problems between you, your dealer, and the manufacturer.

To contact NHTSA, you may either call the Auto Safety Hotline toll free at 1-888-327-4236 (TTY: 1-800-424-9153), or go to <http://www.NHTSA.gov>, or write to: NHTSA, U.S. Dept. of Transportation, Washington DC 20590. You can also obtain other information about motor vehicle safety from the Hotline.

**In Canada:**

If you believe that your vehicle has a safety defect, you should contact the Customer Service Department immediately. Canadian customers who wish to report a safety defect to the Canadian government should write to Transport Canada, Motor Vehicle Defect Investigations and Recalls, 2780 Sheffield Road, Ottawa, Ontario K1B 3V9.

**PUBLICATION ORDER FORMS**

To order the following manuals, you may use either the website or the phone numbers listed below. Visa, Mastercard, American Express, and Discover orders are accepted. If you prefer mailing your payment, please call for an order form.

**NOTE:** A street address is required when ordering manuals. (No P.O. Boxes).

- *Service Manuals.*

These comprehensive service manuals provide the information that students and professional technicians need in diagnosing/troubleshooting, problem solving, maintaining, servicing and repairing DaimlerChrysler Corporation vehicles. A complete working knowledge of the vehicle, system and/or components is written in straightforward language with illustrations, diagrams and charts.

- *Diagnostic Procedure Manuals.*

Filled with diagrams, charts and detailed illustrations, these practical manuals make it easy for students and technicians to find and fix problems on computer-controlled vehicle systems and features. They show exactly how to find and correct problems the first time, using step-by-step troubleshooting and driveability procedures, proven diagnostic tests and a complete list of all tools and equipment.

- *Owner's Manuals.*

These manuals have been prepared with the assistance of service and engineering specialists to acquaint you with specific Chrysler group vehicles. Included are starting, operating, emergency and maintenance procedures as well as specifications, capabilities and safety tips.

*Call Toll Free at:*

- 1-800-890-4038 (U.S.)
- 1-800-387-1143 (Canada)

Or

*Visit us on the World Wide Web at:*

- [www.techauthority.daimlerchrysler.com](http://www.techauthority.daimlerchrysler.com)
- [www.daimlerchrysler.ca/manuals](http://www.daimlerchrysler.ca/manuals)

### DEPARTMENT OF TRANSPORTATION UNIFORM TIRE QUALITY GRADES

The following describes the tire grading categories established by the National Highway Traffic Safety Administration. The specific grade rating assigned by the tire's manufacturer in each category is shown on the sidewall of the tires on your car.

All Passenger Car Tires Must Conform to Federal Safety Requirements in Addition to These Grades.

#### Treadwear

The treadwear grade is a comparative rating based on the wear rate of the tire when tested under controlled conditions on a specified government test course. For example, a tire graded 150 would wear one and a half (1 1/2) times as well on the government course as a tire graded 100. The relative performance of tires depends upon the actual conditions of their use, however, and may depart significantly from the norm due to variations in driving habits, service practices and differences in road characteristics and climate.

#### Traction Grades

The traction grades, from highest to lowest, are AA, A, B, and C. Those grades represent the tire's ability to stop on wet pavement as measured under controlled conditions on specified government test surfaces of asphalt and concrete. A tire marked C may have poor traction performance.

#### WARNING!

The traction grade assigned to this tire is based on straight-ahead braking traction tests, and does not include acceleration, cornering, hydroplaning, or peak traction characteristics.

**Temperature Grades**

The temperature grades are A (the highest), B, and C, representing the tire's resistance to the generation of heat and its ability to dissipate heat when tested under controlled conditions on a specified indoor laboratory test wheel. Sustained high temperature can cause the material of the tire to degenerate and reduce tire life, and excessive temperature can lead to sudden tire failure. The grade C corresponds to a level of performance which all passenger car tires must meet under the Federal Motor Vehicle Safety Standard No. 109. Grades B and A represent higher levels of performance on the laboratory test wheel than the minimum required by law.

**WARNING!**

**The temperature grade for this tire is established for a tire that is properly inflated and not overloaded. Excessive speed, underinflation, or excessive loading, either separately or in combination, can cause heat buildup and possible tire failure.**

---

# INDEX

- About Your Brakes . . . . . 149
- ABS (Anti-Lock Brake System) . . . . . 149
- Adding Engine Coolant (Antifreeze) . . . . . 224
- Adding Fuel . . . . . 177
- Adding Washer Fluid . . . . . 222
- Additives, Fuel . . . . . 173
- Aiming Headlights . . . . . 246
- Air Cleaner, Engine (Engine Air Cleaner Filter) . . . . . 215
- Air Conditioner Maintenance . . . . . 218
- Air Conditioning . . . . . 122,129
- Air Conditioning Controls . . . . . 122
- Air Conditioning, Operating Tips . . . . . 128,134
- Air Conditioning Refrigerant . . . . . 219
- Air Conditioning System . . . . . 129,218
- Air Pressure, Tires . . . . . 161
- Airbag . . . . . 30
- Airbag Deployment . . . . . 33,34
- Airbag Light . . . . . 33,34,36,46,84
- Airbag Maintenance . . . . . 36
- Airbag, Side . . . . . 35
- Airbag, Window (Side Curtain) . . . . . 30,35
- Alarm Light . . . . . 88
- Alarm, Panic . . . . . 17
- Alarm System (Security Alarm) . . . . . 19
- Alignment and Balance . . . . . 167
- Alterations/Modifications, Vehicle . . . . . 6
- Antenna, Satellite Radio . . . . . 118
- Antifreeze (Engine Coolant) . . . . . 224,246
- Capacities . . . . . 246
- Disposal . . . . . 226
- Anti-Lock Brake System (ABS) . . . . . 149
- Anti-Lock Warning Light . . . . . 87
- Anti-Theft Security Alarm (Theft Alarm) . . . . . 19
- Appearance Care . . . . . 233
- Automatic Dimming Mirror . . . . . 52
- Automatic Door Locks . . . . . 13,14
- Automatic Headlights . . . . . 62
- Automatic Temperature Control (ATC) . . . . . 122
- Automatic Transaxle . . . . . 143,145,202,230,248
- Adding Fluid . . . . . 248
- Filter . . . . . 232
- Fluid and Filter Changes . . . . . 232
- Fluid Level Check . . . . . 231
- Interlock System . . . . . 144
- Reset Mode . . . . . 145
- Selection Of Lubricant . . . . . 231,248

- Shifting ..... 145  
 Special Additives ..... 232  
 Autostick ..... 169  
 Auxiliary Power Outlet ..... 76  
  
 Ball Joints ..... 220  
 Battery ..... 216  
   Emergency Starting ..... 197  
   Gas Caution ..... 199,217  
   Heater ..... 142  
   Jump Starting ..... 197  
   Keyless Transmitter Replacement (RKE) ..... 18  
   Location ..... 197,217  
 Belts, Drive ..... 214  
 Belts, Engine ..... 216  
 Body Mechanism Lubrication ..... 220  
 B-Pillar Location ..... 156  
 Brake, Parking ..... 147  
 Brake System ..... 149,228  
   Anti-Lock (ABS) ..... 149  
   Fluid Check ..... 229  
   Hoses ..... 228  
   Master Cylinder ..... 229  
   Warning Light ..... 87  
 Brake/Transmission Interlock ..... 143,145  
 Break-In Recommendations, New Vehicle ..... 44  
 Bulb Replacement ..... 241  
 Bulbs, Light ..... 240  
  
 Capacities, Antifreeze (Engine Coolant) ..... 246  
 Capacities, Fluid ..... 246  
 Caps, Filler  
   Fuel ..... 177  
   Oil (Engine) ..... 213  
   Radiator (Coolant Pressure) ..... 225  
 Car Washes ..... 233  
 Carbon Monoxide Warning ..... 174  
 Carpeting ..... 235  
 Cassette Tape and Player Maintenance ..... 120  
 Cassette Tape Player ..... 94,103,105  
 Catalytic Converter ..... 215  
 CD (Compact Disc) Changer ..... 101,106,111,113  
 CD (Compact Disc) Player ..... 99,108,110,120  
 Center High Mounted Stop Light ..... 245  
 Central Locking ..... 13  
 Chains, Tire ..... 168

- Changing A Flat Tire . . . . . 191  
Charging System Light . . . . . 84  
Chart, Tire Sizing . . . . . 153  
Check Engine Light (Malfunction Indicator Light) . . . . . 208  
Checking Your Vehicle For Safety . . . . . 45  
Child Restraint . . . . . 36,39,41,42  
Child Restraint Tether Anchors . . . . . 41  
Child Safety Locks . . . . . 14  
Cigar Lighter . . . . . 92  
Circuit Breakers . . . . . 237,238  
Clean Air Gasoline . . . . . 172  
Cleaning  
    Glass . . . . . 236  
    Headlights . . . . . 236  
    Instrument Panel . . . . . 236  
    Wood Trim . . . . . 236  
Climate Control . . . . . 122  
Clock . . . . . 92  
Coin Holder . . . . . 50  
Compact Disc (CD) Changer . . . . . 113  
Compact Disc (CD) Maintenance . . . . . 121  
Compact Disc (CD) Player . . . . . 94,99  
Compact Spare Tire . . . . . 163  
Compass . . . . . 89  
Compass Calibration . . . . . 90  
Contract, Service . . . . . 272  
Coolant Pressure Cap . . . . . 225  
Cooling System . . . . . 223  
    Adding Coolant (Antifreeze) . . . . . 224  
    Coolant Capacity . . . . . 246  
    Coolant Level . . . . . 223,226  
    Disposal of Used Coolant . . . . . 226  
    Drain, Flush, and Refill . . . . . 224  
    Points to Remember . . . . . 227  
    Pressure Cap . . . . . 225  
    Radiator Cap . . . . . 225  
    Rubber and Plastic Components . . . . . 227  
    Selection of Coolant (Antifreeze) . . . . . 224,246,247  
Corrosion Protection . . . . . 233  
Crankcase Emission Control System . . . . . 216  
Cruise Control (Speed Control) . . . . . 66  
Cruise Light . . . . . 83  
Customer Assistance . . . . . 270  
Daytime Brightness, Interior Lights . . . . . 60



- Daytime Running Lights . . . . . 62
- Dealer Service . . . . . 209
- Defroster, Rear Window . . . . . 132
- Defroster, Windshield . . . . . 46,126,131
- Diagnostic System, Onboard . . . . . 207
- Dimmer Control . . . . . 59
- Dimmer Switch, Headlight . . . . . 63
- Dipsticks
  - Automatic Transaxle . . . . . 231
- Disposal
  - Antifreeze (Engine Coolant) . . . . . 226
  - Engine Oil . . . . . 214
- Door Ajar Warning . . . . . 13
- Door Locks . . . . . 11
- Door Locks, Automatic . . . . . 13
- Door Opener, Garage . . . . . 69
- Drive Belts . . . . . 214
- Driving
  - On Slippery Surfaces . . . . . 200
- E-85 Fuel . . . . . 175
- Electrical Outlet, Auxiliary (Power Outlet) . . . . . 76
- Electrical Power Outlets . . . . . 76
- Electronic Speed Control (Cruise Control) . . . . . 66
- Emergency, In Case of
  - Freeing Vehicle When Stuck . . . . . 201
  - Jacking . . . . . 191
  - Jump Starting . . . . . 197
  - Overheating . . . . . 190
  - Towing . . . . . 201
- Emergency Trunk Release . . . . . 20,21
- Emission Control System Maintenance . . . . . 208,250
- Engine . . . . . 205,206
  - Air Cleaner Filter . . . . . 215
  - Block Heater . . . . . 142
  - Break-In Recommendations . . . . . 44
  - Checking Oil Level . . . . . 210
  - Compartment . . . . . 205,206
  - Coolant (Antifreeze) . . . . . 223,247
  - Cooling . . . . . 223
  - Exhaust Gas Caution . . . . . 174
  - Fails to Start . . . . . 142
  - Fuel Requirements . . . . . 171,246
  - Oil . . . . . 210,246,247
  - Oil Change Interval . . . . . 211
  - Oil Selection . . . . . 212,246

Oil Synthetic	213	Fuel Requirements	175
Overheating	190	Maintenance	176
Timing Belt	216	Replacement Parts	176
Engine Oil Viscosity	246	Starting	176
Entry System, Illuminated	11	Fluid, Brake	248
Exhaust Gas Caution	45,174,223	Fluid Capacities	246
Exhaust System	223	Fluid Leaks	46
Exterior Light Service	241	Fluid Level Checks	
		Automatic Transaxle	231
Filters		Capacities	246
Air Cleaner	215	Cooling System	223
Automatic Transaxle	232	Engine Oil	210
Engine Fuel	215	Power Steering	219
Engine Oil	214,247	Fluids	247
Engine Oil Disposal	214	Fluids, Lubricants and Genuine Parts	247
Flashers		Fog Light Service	244
Hazard Warning	190	Fog Lights	62,85,244
Turn Signal	84	Folding Rear Seat	57
Flash-To-Pass	63	Freeing A Stuck Vehicle	201
Flat Tire Changing	191	Fuel	171
Flexible Fuel Vehicles		Adding	177
Cruising Range	176	Additives	173
Engine Oil	176	Clean Air	172

- Filler Cap (Gas Cap) . . . . . 177  
 Filter . . . . . 215  
 Gasoline . . . . . 171  
 Gauge . . . . . 83  
 Hoses . . . . . 230  
 Light . . . . . 88  
 Octane Rating . . . . . 247  
 Requirements . . . . . 171,246  
 Tank Capacity . . . . . 246  
 Fuel, Flexible . . . . . *See Flexible Fuel Vehicles*  
 Fueling . . . . . 177  
 Fuses . . . . . 237  
  
 Garage Door Opener (HomeLink®) . . . . . 69  
 Gas Cap (Fuel Filler Cap) . . . . . 177  
 Gasoline, Clean Air . . . . . 172  
 Gasoline (Fuel) . . . . . 171  
 Gasoline, Reformulated . . . . . 172  
 Gasoline/Oxygenate Blends . . . . . 172  
 Gauges  
   Coolant Temperature . . . . . 85,86  
   Fuel . . . . . 83  
   Speedometer . . . . . 84  
  
   Tachometer . . . . . 84  
 Gearshift . . . . . 145  
 General Information . . . . . 10,17  
 Glass Cleaning . . . . . 236  
 Gross Axle Weight Rating . . . . . 179  
 Gross Vehicle Weight Rating . . . . . 179  
  
 Hazard Warning Flasher . . . . . 190  
 Head Restraints . . . . . 56  
 Headlights . . . . . 241  
   Aiming . . . . . 246  
   Automatic . . . . . 62  
   Bulb Replacement . . . . . 241  
   Cleaning . . . . . 236  
   High Beam . . . . . 63,84  
   High Beam/Low Beam Select Switch . . . . . 63  
   Passing . . . . . 63  
   Switch . . . . . 61  
   Time Delay . . . . . 62,63  
 Heater . . . . . 122,129  
 Heater, Engine Block . . . . . 142  
 Hitches  
   Trailer Towing . . . . . 180

- HomeLink® (Garage Door Opener) Transmitter . 69  
Hood Prop . . . . . 58  
Hood Release . . . . . 58  
Hoses . . . . . 227,230
- Illuminated Entry . . . . . 11  
Immobilizer (Sentry Key) . . . . . 9  
Infant Restraint . . . . . 37  
Inside Rearview Mirror . . . . . 52  
Instrument Cluster . . . . . 82  
Instrument Panel and Controls . . . . . 81  
Instrument Panel Cover . . . . . 236  
Instrument Panel Lens Cleaning . . . . . 237  
Interior Appearance Care . . . . . 235  
Interior Fuses . . . . . 238  
Interior Lighting . . . . . 59  
Interior Lights . . . . . 59  
Introduction . . . . . 4
- Jack Location . . . . . 192  
Jack Operation . . . . . 192  
Jump Starting . . . . . 197
- Key, Programming . . . . . 10  
Key, Replacement . . . . . 9  
Key, Sentry (Immobilizer) . . . . . 9  
Keyless Entry System . . . . . 15  
Knee Bolster . . . . . 30
- Lap/Shoulder Belts . . . . . 23  
LATCH (Lower Anchors and Tether for  
Children) . . . . . 41  
Latch Plate . . . . . 24  
Latches  
Hood . . . . . 58  
Lead Free Gasoline . . . . . 171  
Leaks, Fluid . . . . . 46  
Life of Tires . . . . . 166  
Lights . . . . . 46,59  
Airbag . . . . . 34,36,46,84  
Anti-Lock . . . . . 87  
Automatic Headlights . . . . . 62  
Brake Warning . . . . . 87,147  
Bulb Replacement . . . . . 240  
Check Engine (Malfunction Indicator) . . . . . 84  
Daytime Running . . . . . 62

Dimmer Switch, Headlight . . . . .	61,63	Theft Alarm (Security Alarm) . . . . .	88
Engine Temperature Warning . . . . .	86	Traction Control . . . . .	151
Exterior Check . . . . .	46	Turn Signal . . . . .	61,62,84,243
Fog . . . . .	62,85,244	Voltage . . . . .	84
Front Replacement . . . . .	243	Load Limits . . . . .	178
Headlight Switch . . . . .	61	Loading Vehicle	
Headlights . . . . .	61	Capacities . . . . .	178
High Beam . . . . .	63	Tires . . . . .	156,178
High Beam Indicator . . . . .	84	Locks	
Illuminated Entry . . . . .	11	Central . . . . .	13
Instrument Cluster . . . . .	61	Child Protection . . . . .	14
Interior . . . . .	59	Door . . . . .	11
License . . . . .	246	Lower Anchors and Tether for CHildren (LATCH) . . . . .	41
Lights On Reminder . . . . .	62	Lubricants . . . . .	220
Low Fuel . . . . .	88	Lubrication, Body . . . . .	220
Malfunction Indicator (Check Engine) . . . . .	84	Luggage/Cargo Capacity . . . . .	178
Map Reading . . . . .	60	Lumbar Support . . . . .	55
Oil Pressure . . . . .	87	Maintenance Free Battery . . . . .	216
Rear Servicing . . . . .	245	Maintenance Procedures . . . . .	210
Seat Belt Reminder . . . . .	88	Maintenance Schedule . . . . .	250
Security Alarm (Theft Alarm) . . . . .	19	Light Duty Schedule "B" . . . . .	253
Service . . . . .	240,241		
Service Engine Soon (Malfunction Indicator) . . . . .	84		

Schedule "A" .....	263	Checking .....	210
Schedule "B" .....	253	Disposal .....	214
Malfunction Indicator Light (Check Engine) .	84,208	Filter .....	214,247
Manual, Service .....	273	Filter Disposal .....	214
Mirrors .....	52	Identification Logo .....	212
Automatic Dimming .....	52	Materials Added to .....	213
Electric Remote .....	53	Pressure Gauge .....	87
Outside .....	53	Quality .....	212
Rearview .....	52	Recommendation .....	212,246
Vanity .....	54	Synthetic .....	213
Modifications/Alterations, Vehicle .....	6	Viscosity .....	213,246
Mopar Parts .....	209,272	Onboard Diagnostic System .....	207,208
Multi-Function Control Lever .....	61	Opener, Garage Door (HomeLink®) .....	69
New Vehicle Break-In Period .....	44	Operator Manual (Owner's Manual) .....	4
Occupant Restraints .....	22	Overdrive .....	146
Odometer .....	86	Overheating, Engine .....	190
Tampering .....	86	Owner's Manual (Operator Manual) .....	4,273
Trip .....	86	Paint Care .....	233
Oil, Engine .....	210,246,247	Paint Damage .....	233
Capacity .....	246	Panic Alarm .....	17
Change Interval .....	211	Parking Brake .....	147
		Parking On Hill .....	148

- Passing Light . . . . . 63  
 Pets . . . . . 44  
 Placard, Tire and Loading Information . . . . . 156  
 Power  
   Brakes . . . . . 149  
   Door Locks . . . . . 12  
   Outlet (Auxiliary Electrical Outlet) . . . . . 76  
   Seats . . . . . 56  
   Steering . . . . . 150  
   Steering, Checking . . . . . 219  
   Sunroof . . . . . 74  
   Windows . . . . . 21,150  
 Power Steering Fluid . . . . . 248  
 Pregnant Women and Seat Belts . . . . . 29  
 Preparation for Jacking . . . . . 192  
 Pretensioners  
   Seat Belts . . . . . 27  
 Programmable Electronic Features . . . . . 69,73  
 Programming Transmitters (Remote  
 Keyless Entry) . . . . . 17,69,73  
  
 Radial Ply Tires . . . . . 163  
 Radiator Cap (Coolant Pressure Cap) . . . . . 225  
  
 Radio Broadcast Signals . . . . . 93  
 Radio Operation . . . . . 103,108,119,122  
 Radio Remote Controls . . . . . 119  
 Radio, Satellite . . . . . 115  
 Radio (Sound Systems) . . . . . 94,103,108  
 Rear Seat, Folding . . . . . 57  
 Rear Window Defroster . . . . . 132  
 Rearview Mirrors . . . . . 52  
 Reformulated Gasoline . . . . . 172  
 Refrigerant . . . . . 219  
 Reminder, Lights On . . . . . 62  
 Reminder, Seat Belt . . . . . 28  
 Remote Keyless Entry (RKE) . . . . . 15  
 Remote Sound System (Radio) Controls . . . . . 119  
 Remote Trunk Release . . . . . 20  
 Replacement Tires . . . . . 166  
 Reporting Safety Defects . . . . . 273  
 Restraint, Head . . . . . 56  
 Restraints, Occupant . . . . . 22  
 Rocking Vehicle When Stuck . . . . . 201  
 Rotation, Tires . . . . . 168  
  
 Safety Checks Inside Vehicle . . . . . 45

Safety Checks Outside Vehicle	46	Lumbar Support	55
Safety Defects, Reporting	273	Power	56
Safety Information, Tire	152	Rear Folding	57
Safety Tips	45	Reclining	55
Satellite Radio	115	Security Alarm (Theft Alarm)	19
Satellite Radio Antenna	118	Selection of Coolant (Antifreeze)	224,247
Schedule, Maintenance	250	Sentry Key (Immobilizer)	9
Seat Belt Maintenance	237	Service Assistance	270
Seat Belt Reminder	28	Service Contract	272
Seat Belts	23	Service Engine Soon Light (Malfunction Indicator)	84
Adjustable Upper Shoulder Anchorage	26	Service Manuals	273
And Pregnant Women	29	Setting the Clock	92
Child Restraint	36,37,42	Shoulder Belt Upper Anchorage	26
Extender	29	Side Airbag	35
Front Seat	24	Side Window Demisters (Defrosters)	127,132
Inspection	45	Signals, Turn	84
Operating Instructions	24	Slippery Surfaces, Driving On	200
Pretensioners	27	Snow Tires	168
Reminder	88	Spare Tire	163,164
Seats	54	Spark Plugs	214
Adjustment	54	Speed Control (Cruise Control)	66,83
Cleaning	235	Speedometer	84
Head Restraints	56		



Starting	140	Tire and Loading Information Placard	156
Cold Weather	141	Tire Identification Number (TIN)	154
Engine Fails to Start	142	Tire Markings	152
Starting and Operating	140	Tire Safety Information	152
Steering		Tires	46,160,275
Power	150,219	Aging (Life of Tires)	166
Tilt Column	64	Air Pressure	160
Steering Wheel Mounted Sound System		Alignment	167
Controls	119	Chains	168
Storage	240	Changing	191,192
Storage, Vehicle	240	Compact Spare	163
Storing Your Vehicle	240	Flat Changing	191,192
Stuck, Freeing	201	General Information	160
Sun Roof	74	High Speed	162
Supplemental Restraint System - Airbag	30	Inflation Pressures	161
		Jacking	192
Tachometer	84	Life of Tires	166
Tape Player	119	Load Capacity	156,157
Temperature Control, Automatic (ATC)	122	Quality Grading	275
Temperature Gauge, Engine Coolant	86,191	Radial	163
Theft Alarm (Security Alarm)	19	Replacement	166
Theft System (Security Alarm)	19	Rotation	168
Tilt Steering Column	64	Safety	152,160

- Sizes . . . . . 153
- Snow Tires . . . . . 168
- Spinning . . . . . 164
- Tread Wear Indicators . . . . . 165
- Tongue Weight/Trailer Weight . . . . . 181
- Towing . . . . . 178,201,202
  - Disabled Vehicle . . . . . 201
  - Guide . . . . . 181
  - Weight . . . . . 181
- Traction Control . . . . . 65,83,150
- Traction Control Switch . . . . . 65,150
- Trailer Towing . . . . . 178
  - Cooling System Tips . . . . . 187
  - Hitches . . . . . 180
  - Minimum Requirements . . . . . 182
  - Trailer and Tongue Weight . . . . . 181
  - Wiring . . . . . 185
- Trailer Towing Guide . . . . . 181
- Trailer Weight . . . . . 181
- Transaxle . . . . . 230
  - Additives . . . . . 232
  - Automatic . . . . . 143,145,230
  - Filter . . . . . 232
  - Overdrive . . . . . 146
  - Selection of Lubricant . . . . . 231
- Transmission
  - Range Indicator . . . . . 86
- Transmission . . . . . *See Transaxle*
- Transmitter Battery Service (Remote Keyless Entry) . . . . . 18
- Transmitter, Garage Door Opener (HomeLink®) . . . . . 69
- Transmitter, Remote Keyless Entry (RKE) . . . . . 15
- Transporting Pets . . . . . 44
- Tread Wear Indicators . . . . . 165
- Trip Computer . . . . . 89
- Trip Odometer . . . . . 86
- Trunk Release, Emergency . . . . . 20,21
- Trunk Release Remote Control . . . . . 20
- Turn Signals . . . . . 62,84
- Underhood Fuses . . . . . 237
- Uniform Tire Quality Grades . . . . . 275
- Universal Transmitter . . . . . 69
- Unleaded Gasoline . . . . . 171
- Vacuum/Vapor Harnesses . . . . . 227

- Vanity Mirrors . . . . . 54  
 Vehicle Identification Number (VIN) . . . . . 6  
 Vehicle Loading . . . . . 157,178  
 Vehicle Modifications/Alterations . . . . . 6  
 Vehicle Storage . . . . . 240  
 Vehicle Theft Alarm (Security Alarm) . . . . . 19  
 Vinyl Trim . . . . . 235  
 Viscosity, Engine Oil . . . . . 246  
 Voltmeter . . . . . 84  
  
 Warning, Door Ajar . . . . . 13  
 Warning Flasher, Hazard . . . . . 190  
 Warnings and Cautions . . . . . 6  
 Warranty Information . . . . . 272  
 Washer, Adding Fluid . . . . . 222  
  
 Washers, Windshield . . . . . 63,222  
 Washing Vehicle . . . . . 233  
 Waxing and Polishing . . . . . 233  
 Wheel Alignment and Balance . . . . . 167  
 Wind Buffeting . . . . . 22,75  
 Window Airbag (Side Curtain) . . . . . 30,35  
 Window Fogging . . . . . 126  
 Windows . . . . . 21  
     Power . . . . . 21  
 Windshield Washers . . . . . 63,222  
 Windshield Wipers . . . . . 62,63,221  
 Wiper Blade Replacement . . . . . 222  
 Wipers, Intermittent . . . . . 64  
 Wood Trim Cleaning . . . . . 236



**NOTES**

---

---

---

---

---

---

---

---

---

---

---

---

---

---

---

---

---

---

## NOTES

---

---

---

---

---

---

---

---

---

---

---

---

---

---

---

---

---

## NOTES

---

---

---

---

---

---

---

---

---

---

---

---

---

---

---

---

---

---

---

---

---

---

---

---

## NOTES

---

---

---

---

---

---

---

---

---

---

---

---

---

---

---

---

---

---



## Free Manuals Download Website

<http://myh66.com>

<http://usermanuals.us>

<http://www.somanuals.com>

<http://www.4manuals.cc>

<http://www.manual-lib.com>

<http://www.404manual.com>

<http://www.luxmanual.com>

<http://aubethermostatmanual.com>

Golf course search by state

<http://golfingnear.com>

Email search by domain

<http://emailbydomain.com>

Auto manuals search

<http://auto.somanuals.com>

TV manuals search

<http://tv.somanuals.com>