

TABLE OF CONTENTS

SECTION		PAGE
1	INTRODUCTION	3
2	THINGS TO KNOW BEFORE STARTING YOUR VEHICLE	7
3	UNDERSTANDING THE FEATURES OF YOUR VEHICLE	49
4	UNDERSTANDING YOUR INSTRUMENT PANEL	71
5	STARTING AND OPERATING	111
6	WHAT TO DO IN EMERGENCIES	151
7	MAINTAINING YOUR VEHICLE	163
8	MAINTENANCE SCHEDULES	203
9	IF YOU NEED CONSUMER ASSISTANCE	219
10	INDEX	229

INTRODUCTION

CONTENTS

■ Introduction	4	■ Vehicle Identification Number	6
■ How To Use This Manual	4	■ Vehicle Modifications / Alterations	6
■ Warnings And Cautions	6		

INTRODUCTION

This manual has been prepared with the assistance of service and engineering specialists to acquaint you with the operation and maintenance of your new vehicle. It is supplemented by a Warranty Information Booklet and various customer oriented documents. You are urged to read these publications carefully. Following the instructions and recommendations in this manual will help assure safe and enjoyable operation of your vehicle.

NOTE: After you read the manual, it should be stored in the vehicle for convenient reference and remain with the vehicle when sold, so that the new owner will be aware of all safety warnings.

When it comes to service, remember that your dealer knows your vehicle best, has the factory-trained technicians and genuine Mopar® parts, and is interested in your satisfaction.

WARNING!











Engine exhaust, some of its constituents, and certain vehicle components contain or emit chemicals known to the State of California to cause cancer and birth defects or other reproductive harm. In addition, certain fluids contained in vehicles and certain products of component wear contain or emit chemicals known to the State of California to cause cancer and birth defects or other reproductive harm.

HOW TO USE THIS MANUAL

Consult the table of contents to determine which section contains the information you desire.

The detailed index, at the rear of this manual, contains a complete listing of all subjects.

Consult the following table for a description of the symbols that may be used on your vehicle or throughout this owner's manual:

									
TURN SIGNALS	REAR WINDOW WIPER	WINDSHIELD WIPER INTERMITTENT	BRAKE SYSTEM WARNING PARKING BRAKE	HIGH BEAM	HORN	UPPER AIR OUTLET	HEATED SEAT LOW	DOOR LOCK	ADJUSTABLE PEDALS
									
FUEL	REAR WINDOW INTERMITTENT WIPER	WINDSHIELD WASHER	FAILURE OF ANTI-LOCK BRAKING SYSTEM	LOW BEAM	KEY ACTIVATE (POWER OUTLET)	UPPER AND LOWER AIR OUTLET	HEATED SEAT HIGH	WINDOW LIFT	TIRE PRESSURE MONITOR
									
FUEL FILL SIDE	REAR WINDOW WASHER	WINDSHIELD WASHER FLUID LEVEL	SEAT BELT	FRONT FOG LIGHT	HOOD RELEASE	LOWER AIR OUTLET	RECIRCULATION	CONVERTIBLE 4 WINDOW DOWN	VOICE RECOGNITION BUTTON
									
ENGINE OIL	REAR WINDOW DEFROST	WINDSHIELD, ELECTRICALLY HEATED	AIRBAG	EXTERIOR BULB FAILURE	LIFTGATE RELEASE AND LIFTGATE OPEN	DEFROST AND LOWER AIR OUTLET	VENTILATING FAN	POWER STEERING FLUID	UCONNECT™ BUTTON
									
BATTERY CHARGING	HEATED MIRROR	WINDSHIELD DEFROST	SIDE AIRBAG	DOME LIGHT	SLIDING DOOR	TRUNK / DECK RELEASE	AIR CONDITIONING	SEE OWNER'S MANUAL ISO	TRACTION CONTROL
									
ENGINE COOLANT TEMPERATURE	CHILD SEAT TETHER ANCHOR	WINDSHIELD WIPER AND WASHER	HAZARD	PARK LIGHTS	SLIDING DOOR	CONVERTIBLE TOP UP	EMERGENCY RELEASE HANDLE	INSTRUMENT PANEL ILLUMINATION	WARNING
									
MALFUNCTION INDICATOR LIGHT	LOWER ANCHORS AND TETHER FOR CHILDREN (LATCH)	SRS AIRBAG SUPPLEMENTAL RESTRAINT SYSTEM	WINDOW LOCK	LIGHTER	DOOR AJAR	CONVERTIBLE TOP DOWN	PASSENGER AIRBAG OFF	MASTER LIGHTING SWITCH	BAS BRAKE ASSIST SYSTEM

812ccfd5

WARNINGS AND CAUTIONS

This manual contains **WARNINGS** against operating procedures which could result in an accident or bodily injury. It also contains **CAUTIONS** against procedures which could result in damage to your vehicle. If you do not read this entire manual you may miss important information. Observe all Warnings and Cautions.

VEHICLE IDENTIFICATION NUMBER

Vehicle Identification Number (VIN) is found on a laser etched plate, located on the left front corner of the instrument panel, visible through the windshield. This number also appears on the vehicle registration or title.

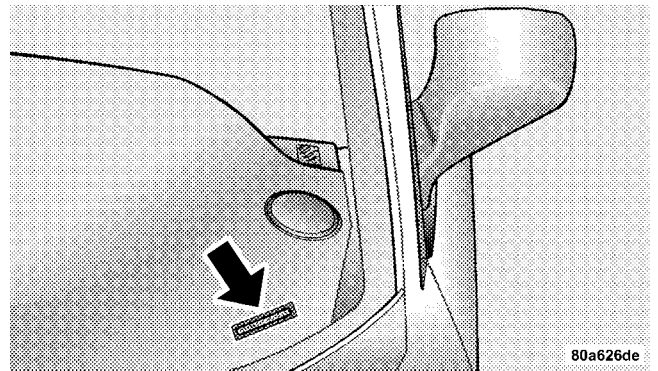

VEHICLE MODIFICATIONS / ALTERATIONS

WARNING!

Any modifications or alterations to this vehicle could seriously affect its roadworthiness and safety and may lead to an accident resulting in serious injury or death.

THINGS TO KNOW BEFORE STARTING YOUR VEHICLE

CONTENTS

■ A Word About Your Keys	9	□ Automatic Transaxle Ignition Interlock System . . .	14
□ Ignition Key Removal	9	■ Door Locks	14
□ Locking Doors With The Key	10	□ Manual Door Locks	14
□ Key-In-Ignition Reminder	10	□ Power Door Locks — If Equipped	15
■ Sentry Key	11	□ Central Locking/Unlocking — If Equipped	15
□ Replacement Keys	12	□ Automatic Door Locks — If Equipped	16
□ Sentry Key Programming	12	□ Child-Protection Door Lock System (Rear Doors)	16
□ General Information	13	■ Remote Keyless Entry — If Equipped	17
■ Steering Wheel Lock — If Equipped	13	□ To Unlock The Doors	17
□ To Manually Lock The Steering Wheel	13	□ To Lock The Doors	18
□ To Release The Steering Wheel Lock	13	□ Horn Chirp Feature	18

8 THINGS TO KNOW BEFORE STARTING YOUR VEHICLE

□ To Unlock The Trunk	18	□ Adjustable Upper Shoulder Belt Anchorage	28
□ Using The Panic Alarm	18	□ Lap/Shoulder Belt Untwisting Procedure	29
□ Programming Additional Transmitters	19	□ Seat Belts And Pregnant Women	30
□ General Information	19	□ Seat Belt Extender	31
□ Transmitter Battery Service	19	□ Driver And Front Passenger Supplemental Restraint System (SRS) - Airbags	31
■ Vehicle Theft Alarm — If Equipped	20	□ Child Restraint	39
□ To Set The Alarm	20	□ Transporting Pets	46
□ To Disarm The System	21	■ Engine Break-In Recommendations	46
□ Security System Manual Override	21	■ Safety Tips	47
■ Remote Trunk Lid Release — If Equipped	21	□ Exhaust Gas	47
■ Internal Emergency Trunk Lid Release	22	□ Safety Checks You Should Make Inside The Vehicle	47
■ Power Windows — If Equipped	23	□ Periodic Safety Checks You Should Make Outside The Vehicle	48
■ Occupant Restraints	23		
□ Lap/Shoulder Belts	24		

A WORD ABOUT YOUR KEYS

The dealer that sold you your new vehicle has the key code numbers for your vehicle locks. These numbers can be used to order duplicate keys from your dealer. Ask your dealer for these numbers and keep them in a safe place.

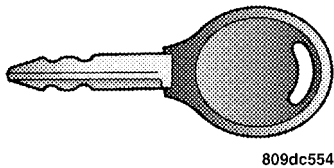

The double sided keys may be inserted into the locks with either side up.

Ignition Key Removal

Manual Transaxle

Depress and hold the release button located between the ignition switch and the instrument panel. Turn the ignition key to LOCK and remove the key.

Automatic Transaxle

Place the shift lever in PARK and make sure that the shift knob push button has returned to the out position. Turn the key to the OFF position, turn to the lock position, and remove the key.

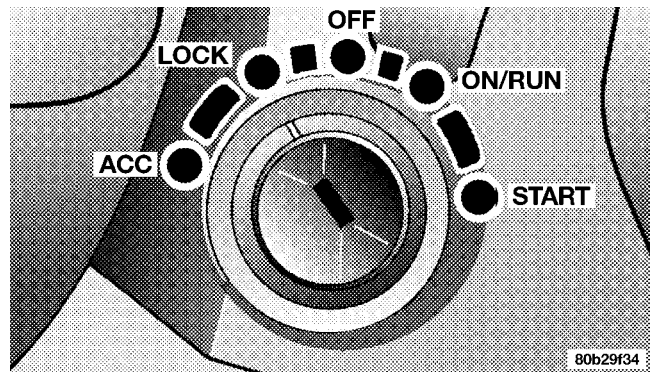

NOTE: If you try to remove the key before you place the lever in PARK, the key may become trapped temporarily in the key cylinder. If this occurs, rotate the key clockwise slightly, then remove the key as described. If a malfunction occurs, the system will trap the key in the ignition cylinder to warn you that this safety feature is

10 THINGS TO KNOW BEFORE STARTING YOUR VEHICLE

inoperable. The engine can be started and stopped but the key cannot be removed until you obtain service.

WARNING!

Leaving children in a vehicle unattended is dangerous for a number of reasons. A child or others could be injured. Children should be warned not to touch the parking brake, brake pedal or the gear selector lever. Don't leave the keys in the ignition. A child could operate power windows, other controls, or move the vehicle.

CAUTION!

An unlocked car is an invitation to thieves. Always remove key from the ignition and lock all doors when leaving the vehicle unattended.

Locking Doors With The Key

You can insert the key with either side up. To lock the door, turn the key rearward. To unlock the door, turn the key forward. See Section 7, Body Mechanism Lubrication of this manual for external lock lubrication.

Key-In-Ignition Reminder

Opening the driver's door when the key is in the ignition switch, sounds a signal to remind you to remove the key.

NOTE: With the driver's door open, and the key in the ignition, the power door locks will not lock via the interior door lock switch.

SENTRY KEY

The Sentry Key Immobilizer System prevents unauthorized operation of the vehicle by disabling the engine. The system will shut the engine off after 2 seconds of running if an invalid key is used to start the vehicle. This system utilizes ignition keys which have an electronic chip (transponder) embedded into them. Only keys that have been programmed to the vehicle can be used to start and operate the vehicle.

The Sentry Key Immobilizer System does not need to be armed or activated. Operation of the system is automatic regardless of whether or not the vehicle is locked or unlocked. During normal operation, the Theft Alarm/Immobilizer Light will come on for three (3) seconds immediately after the ignition switch is turned on for a bulb check. Afterwards, if the bulb remains on, this indicates a problem with the electronics.

If the bulb begins to flash after the bulb check, this indicates that an invalid key has been used to start the vehicle. Both of these conditions will result in the engine being shut off after two (2) seconds of running.

Keep in mind that a key which has not been programmed is also considered an invalid key even if it is cut to fit the ignition lock cylinder for that vehicle.

If the Theft Alarm/Immobilizer Light comes on during normal vehicle operation (vehicle has been running for longer than 10 seconds), a fault has been detected in the electronics and the vehicle should be serviced as soon as possible.

NOTE:

- The Sentry Key Immobilizer System is not compatible with remote starting systems. Use of these systems may result in vehicle starting problems and loss of security protection.
- Exxon/Mobil Speed Pass,TM additional Sentry Keys, or any other transponder equipped components on the same keychain will **not** cause a key-related (transponder) fault unless the additional part is **physically held against the ignition key** being used when starting the vehicle. Cell phones, pagers, or other RF electronics will not cause interference with this system.

All of the keys provided with your new vehicle have been programmed to the vehicle electronics.

Replacement Keys

NOTE: Only keys that have been programmed to the vehicle electronics can be used to start the vehicle. Once a Sentry Key has been programmed to a vehicle, it can not be programmed to any other vehicle.

At the time of purchase, the original owner is provided with a four digit PIN number. This number is required for dealer replacement of keys. Duplication of keys may be performed at an authorized dealer or by using the Customer Key Programming procedure. This procedure consists of programming a blank key to the vehicle electronics. A blank key is one which has never been programmed.

NOTE: When having the Sentry Key Immobilizer System serviced, bring all vehicle keys with you to the dealer.

Sentry Key Programming

You can program new keys to the system if you have two valid sentry keys by performing the following procedure:

1. Cut the additional Sentry Key Transponder blank(s) to match the ignition switch lock cylinder key code.
2. Insert the first valid key into the ignition switch and turn the ignition switch ON for at least 3 seconds but no longer than 15 seconds. Turn the ignition switch OFF and remove the first key.
3. Insert the second valid key and turn the ignition switch ON within 15 seconds. After ten seconds a chime will sound and the Theft Alarm Light will begin to flash. Turn the ignition switch OFF and remove the second key.
4. Insert a blank Sentry Key into the ignition switch and turn the ignition switch ON within 60 seconds. After 10 seconds a single chime will sound. The Theft Alarm Light will stop flashing, turn on for 3 seconds; then turn off.

The new Sentry Key has been programmed.

Repeat this procedure to program up to a total of 8 keys. If you do not have a programmed sentry key, contact your dealer for details.

General Information

The Sentry Key system complies with FCC rules part 15 and with RSS-210 of Industry Canada. Operation is subject to the following conditions:

- This device may not cause harmful interference.
- This device must accept any interference that may be received, including interference that may cause undesired operation.

STEERING WHEEL LOCK — IF EQUIPPED

Your vehicle may be equipped with a passive steering wheel lock. This lock prevents steering the vehicle without the ignition key. If the steering wheel is rotated no more than 1/2 turn in either direction and the key is not in the ignition switch, the steering wheel will lock.

To manually lock the steering wheel:

With the engine running, rotate the steering wheel 1/2 turn, turn off the engine and remove the key. Turn the steering wheel slightly in either direction until the lock engages.

To release the steering wheel lock:

Insert the key in the ignition switch and start the engine. If the key is difficult to turn, rotate the wheel slightly to the right or left to disengage the lock.

NOTE: If you turned the wheel to the right to engage the lock, you must turn the wheel slightly to the right to disengage it. If you turned the wheel to the left to engage the lock, turn the wheel slightly to the left to disengage it.

Automatic Transaxle Ignition Interlock System

This system prevents the key from being removed unless the shift lever is in PARK and the shift knob push-button is fully released. It also prevents shifting out of PARK unless the key is in the ON/RUN or START positions and you have depressed the brake pedal.

CAUTION!

An unlocked car is an invitation to thieves. Always remove the key from the ignition and lock all the doors when leaving the vehicle unattended.

DOOR LOCKS

Manual Door Locks

All doors are equipped with a rocker-type interior door lock. To lock a door when leaving your vehicle, press the rocker switch to the LOCK position and close the door.

NOTE: To avoid accidentally locking your keys in the vehicle, make sure you have them with you before closing any door.

WARNING!

For personal security, and safety in the event of an accident, lock the vehicle doors as you drive as well as when you park and leave the vehicle.

WARNING!

When leaving the vehicle always remove the key from the ignition lock, and lock your vehicle. Do not leave children unattended in the vehicle, or with access to an unlocked vehicle. Unsupervised use of vehicle equipment may cause severe personal injuries and death.

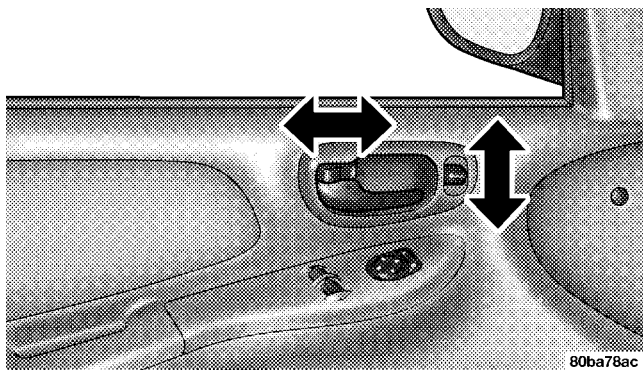
**Power Door Locks — If Equipped**

A power door lock switch is on each front door panel. Press this switch to lock or unlock the doors.

Central Locking/Unlocking — If Equipped

All vehicle doors are locked with the first turn of the key to the LOCK position. The double activation feature requires you to turn the key in the cylinder lock two times within five seconds to UNLOCK all vehicle doors at once.

You may disable this feature and unlock all the doors with one turn of the key by performing the following procedure:

NOTE: Steps 2 and 3 must be completed within 10 seconds.

1. Close all doors and place the key in the ignition switch.
2. Cycle the ignition switch ON/OFF four times ending in the OFF position.
3. Press the interior door lock switch to the UNLOCK position.

16 THINGS TO KNOW BEFORE STARTING YOUR VEHICLE

4. A single chime will sound to signify that you have successfully disabled the double activation feature. You can turn the feature back on by repeating the above mentioned procedure.

You can turn the feature back on by repeating the above mentioned procedure.

Automatic Door Locks — If Equipped

The doors will lock automatically if:

1. all doors are closed,
2. vehicle speed is above 15 mph (24 km/h),
3. the accelerator pedal is depressed.

The Automatic Door Locks can be enabled or disabled by performing the following procedure:

NOTE: Steps 2 and 3 must be completed within 10 seconds.

1. Close all doors and place the key in the ignition switch.
2. Cycle the ignition switch ON/OFF four times ending in the OFF position.

3. Press the interior door lock switch to the LOCK position.

4. A single chime will sound to signify that you have successfully completed the programming.

You can turn the feature back on by repeating the above mentioned procedure.

Child-Protection Door Lock System (Rear Doors)

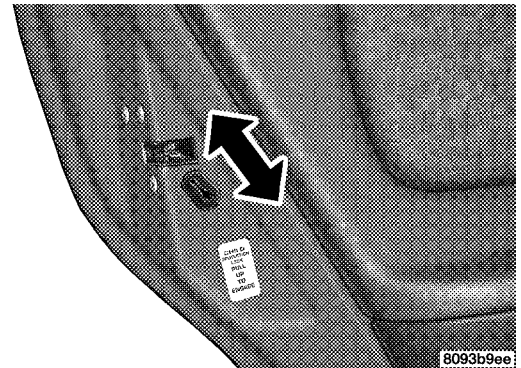

To provide a safer environment for children riding in the rear seat, the rear doors of your vehicle have the child-protection door lock system.

To use the system, open each rear door and slide the control UP to engage the locks and DOWN to disengage the child-protection locks. When the system on a door is engaged, that door can only be opened by using the outside door handle even if the inside door lock is in the unlocked position.

WARNING!

Avoid trapping anyone in a vehicle in a collision. Remember that the rear doors can only be opened from the outside when the child protection locks are engaged.

NOTE: For emergency exit with the system engaged, move the door lock rocker switch to the UNLOCK position, roll down the window and open the door with the outside door handle.

REMOTE KEYLESS ENTRY — IF EQUIPPED

This system allows you to lock or unlock the doors and trunk or activate the panic alarm from distances up to about 23 feet (7 meters) using a hand held transmitter.

2

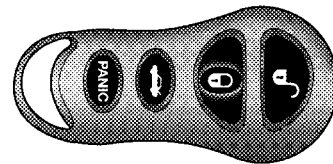

80b31f52

NOTE: A slight delay of up to two seconds can occur before the doors or trunk will unlock.

To Unlock the Doors

Press and release the UNLOCK button once to unlock the driver's door. Press the button twice within 5 seconds to unlock all doors. The interior lights also come on and remain on for about 30 seconds when you unlock the doors.

NOTE: You may turn off this feature and unlock all doors with one press of the button by following the procedure shown in the Central Locking/Unlocking paragraph.

To Lock the Doors

Press and release the LOCK button to lock all doors. The park/lamps will flash and the horn will chirp to acknowledge the signal.

Horn Chirp Feature

The horn chirp that signals that the doors have been locked can be toggled on or off by using the following procedure:

1. Insert the ignition key and turn the switch to the ON/RUN position.
2. Press and hold the UNLOCK button on the transmitter for 4 to 10 seconds.
3. Continue to hold the UNLOCK button and press the LOCK button.
4. Release both buttons.

A chime will sound to signify that the feature has been successfully completed.

To Unlock the Trunk

Press the TRUNK button on the transmitter twice to unlock the trunk.

NOTE: A slight delay of up to two seconds can occur before the trunk unlatches.

Using The Panic Alarm

To turn on the panic alarm feature, press and release the PANIC button. When the panic alarm is on the headlights and park/lamps will flash, the horn will pulse on and off and the interior lights will turn on.

The panic alarm will stay on for 3 minutes unless you press the PANIC button a second time, or until vehicle speed reaches 15 mph (24 km/h).

NOTE: When you turn off the panic alarm by pressing the PANIC button a second time, you may have to be closer to the vehicle due to the radio frequency noises of the system.

Programming Additional Transmitters

Up to four transmitters can be programmed to your vehicle. Your new vehicle was shipped with two transmitters. See your dealer for additional transmitters.

Additional transmitters can be programmed to the system by using the following procedure:

1. Insert the key into the ignition and turn the switch to the RUN position.
2. Press and hold the UNLOCK button on the transmitter for between four and ten seconds.
3. Continue to hold the UNLOCK button and press the PANIC button. A chime will sound to indicate that the transmitter programming mode has been entered.
4. Press a button on all transmitters to be programmed to the system, including any previously programmed transmitters. A chime will sound when each transmitter has been programmed.
5. Turn the ignition switch off to exit the transmitter programming mode.

General Information

This device complies with FCC rules part 15. Operation is subject to the following two conditions: (1) This device may not cause harmful interference and (2) This device must accept any interference that may be received, including interference that may cause undesired operation.

If your transmitter fails to operate from a normal distance, check for these two conditions.

1. Weak batteries in transmitter. The expected life of batteries is from one to two years.
2. Closeness to a radio transmitter such as a radio station tower, airport transmitter, and some mobile or CB radios.

Transmitter Battery Service

The recommended replacement battery is 2016 or its equivalent.

NOTE: Do not touch the battery terminals that are on the back housing or the printed circuit board.

1. With the transmitter buttons facing down, use a thin coin or similar object to pry the two halves of the transmitter apart. Make sure not to damage the rubber gasket during removal.

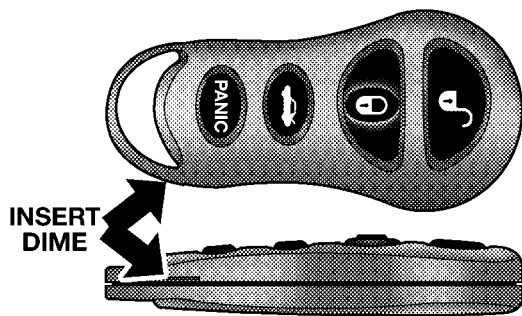

80b31f53

2. Remove and replace the batteries. Avoid touching the new batteries with your fingers. Skin oils may cause battery deterioration. If you touch a battery, clean it with rubbing alcohol.

3. To reassemble the transmitter case, snap two halves together. Make sure there is an even gap between the two halves. Test transmitter operation.

VEHICLE THEFT ALARM — IF EQUIPPED

The system monitors the doors, trunk key cylinder, and ignition for unauthorized operation.

If something triggers the alarm, the system will signal for about 18 minutes. For the first 3 minutes the horn will sound and the headlights, park/turn signal lights, tail lights and the indicator light in the cluster will flash. Then the exterior lights will flash for another 15 minutes.

If the monitored system which triggered the alarm is deactivated, the alarm will continue to sound until 3 minutes of alarm time is reached. If the monitored system which triggered the alarm is deactivated after the alarm has been on for 3 minutes, the alarm will shut off immediately.

To set the alarm:

1. Remove the keys from the ignition switch and get out of the vehicle.
2. Lock the door using either the door key, power door lock switch, or the Keyless Entry Transmitter and close all doors.

3. The indicator light in the instrument cluster will flash rapidly for 16 seconds. This shows that the system is arming. During this period, if a door is opened, the ignition switch is turned on, or the power door locks are unlocked in any manner, the system will automatically disarm. If the light comes on but does not flash, the system is arming but there is a problem in the trunk circuit. After 16 seconds the indicator light will flash slowly. This shows that the system is fully armed.

Vehicles equipped with the Sentry Key Immobilizer System can be safely started with a valid key. A valid key is one that is programmed to that particular vehicle. A valid key will disarm the system, an invalid key will trigger the alarm.

To disarm the system:

Unlock a front door using either the key or the Keyless Entry Transmitter.

Starting the vehicle with a valid Sentry key will disarm the system.

Tamper Alert

If the horn sounds 3 times when you unlock a front door using either a key or the Keyless Entry Transmitter, the alarm has been activated. Check the vehicle for tampering.

Security System Manual Override

The system will not arm if you lock the doors using the manual lock control.

REMOTE TRUNK LID RELEASE — IF EQUIPPED

You can open the trunk from inside the vehicle by pressing a switch located inside the glove compartment.

NOTE: The remote trunk release feature will operate with the ignition switch in all positions. The remote trunk release will not operate above 5 mph.

INTERNAL EMERGENCY TRUNK LID RELEASE

WARNING!

Do not allow children to have access to the trunk, either by climbing into the trunk from outside, or through the inside of the vehicle. Always close the trunk lid when your vehicle is unattended. Once in the trunk, young children may not be able to escape, even if they entered through the rear seat. If trapped in the trunk, children can die from suffocation or heat stroke.

As a security measure, a Trunk Internal Emergency Release lever is built into the trunk latching mechanism. In the event of an individual being locked inside the trunk, the trunk can be simply opened by pulling on the glow-in-the-dark lever attached to the trunk latching mechanism. See picture below.

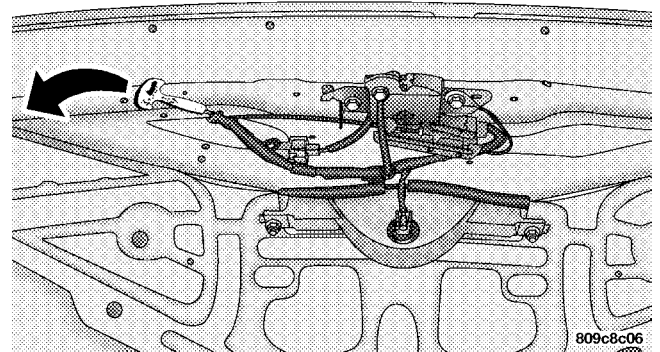

POWER WINDOWS — IF EQUIPPED

The window switches on the driver's door panel control both front windows. The switch on the passenger's door panel controls the passenger's window.

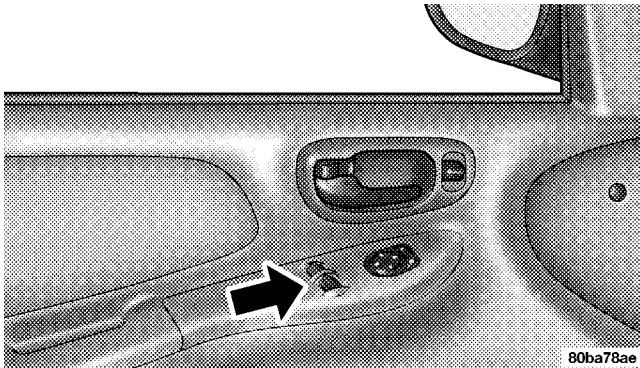
**OCCUPANT RESTRAINTS**

Some of the most important safety features in your vehicle are the restraint systems. These include the front and rear seat belts for the driver and all passengers, front airbags for both the driver and front passenger and side airbags for both the driver and front passenger. If you will be carrying children too small for adult-size belts, your seat belts also can be used to hold infant and child restraint systems.

Please pay close attention to the information in this section. It tells you how to use your restraint system properly to keep you and your passengers as safe as possible.

WARNING!

In a collision, you and your passengers can suffer much greater injuries if you are not properly buckled up. You can strike the interior of your vehicle or other passengers, or you can be thrown out of the vehicle. Always be sure you and others in your vehicle are buckled up properly.

Buckle up even though you are an excellent driver, even on short trips. Someone on the road may be a poor driver and cause a collision that includes you. This can happen far away from home or on your own street.

Research has shown that seat belts save lives, and that they can reduce the seriousness of injuries in a collision. Some of the worst injuries happen when people are thrown from the vehicle. Seat belts reduce the possibility of ejection and the risk of injury caused by striking the inside of the vehicle. **Everyone** in a motor vehicle should be belted at all times.

Lap/Shoulder Belts

All the seats in your vehicle are equipped with Lap/Shoulder Belts.

The belt webbing retractor is designed to lock during very sudden stops or collisions. This feature allows the shoulder part of the belt to move freely with you under normal conditions. But in a collision, the belt will lock and reduce your risk of striking the inside of the vehicle or being thrown out.

WARNING!

- **Wearing a seat belt incorrectly is dangerous.** Seat belts are designed to go around the large bones of your body. These are the strongest parts of your body and can take the forces of a collision the best.
- **Wearing your belt in the wrong place could make your injuries in a collision much worse.** You might suffer internal injuries, or you could even slide out of part of the belt. Follow these instructions to wear your seat belt safely and to keep your passengers safe, too.
- **Two people should never be belted into a single seat belt.** People belted together can crash into one another in an accident, hurting one another badly. Never use a lap/shoulder belt or lap belt for more than one person, no matter what their size.

Lap/Shoulder Belt Operating Instructions

1. Enter the vehicle and close the door. Sit back and adjust the seat.

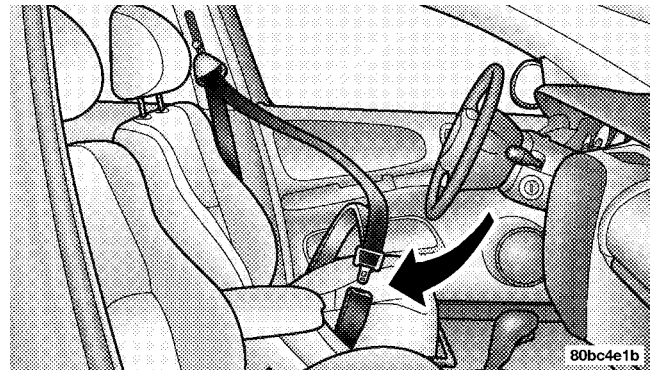

2

2. The seat belt latch plate is above the back of the front seat, next to your arm in the rear seat. Grasp the latch plate and pull out the belt. Slide the latch plate up the webbing as far as necessary to allow the belt to go around your lap.

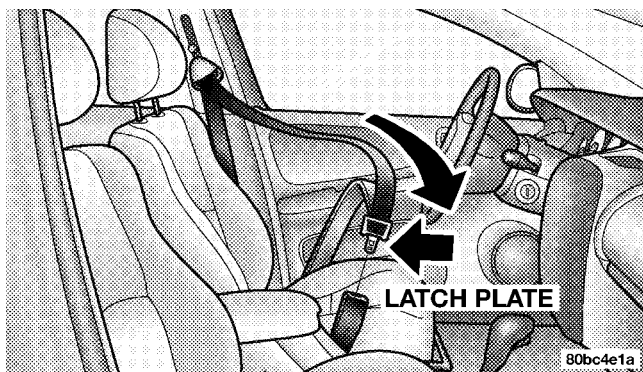

3. When the belt is long enough to fit, insert the latch plate into the buckle until you hear a "click."

WARNING!

- A belt that is buckled into the wrong buckle will not protect you properly. The lap portion could ride too high on your body, possibly causing internal injuries. Always buckle your belt into the buckle nearest you.
- A belt that is too loose will not protect you as well. In a sudden stop you could move too far forward, increasing the possibility of injury. Wear your seat belt snugly.
- A belt that is worn under your arm is very dangerous. Your body could strike the inside surfaces of the vehicle in a collision, increasing head and neck injury. A belt worn under the arm can cause internal injuries. Ribs aren't as strong as shoulder bones. Wear the belt over your shoulder so that your strongest bones will take the force in a collision.
- A shoulder belt placed behind will not protect you from injury during a collision. You are more likely to hit your head in a collision if you do not wear your shoulder belt. The lap and shoulder belt are meant to be used together.

4. Position the lap belt across your thighs, below your abdomen. To remove slack in the lap belt portion, pull up on the shoulder belt. To loosen the lap belt if it is too tight, tilt the latch plate and pull on the lap belt. A snug belt reduces the risk of sliding under the belt in a collision.

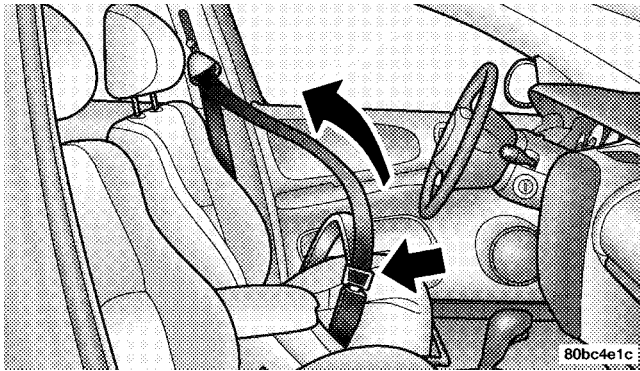

WARNING!

- A lap belt worn too high can increase the risk of internal injury in a collision. The belt forces won't be at the strong hip and pelvic bones, but across your abdomen. Always wear the lap belt as low as possible and keep it snug.
- A twisted belt can't do its job as well. In a collision it could even cut into you. Be sure the belt is straight. If you can't straighten a belt in your vehicle, take it to your dealer and have it fixed.

5. Position the shoulder belt on your chest so that it is comfortable and not resting on your neck. The retractor will withdraw any slack in the belt.

6. To release the belt, push the red button on the buckle. The belt will automatically retract to its stowed position. If necessary, slide the latch plate down the webbing to allow the belt to retract fully.

WARNING!

A frayed or torn belt could rip apart in a collision and leave you with no protection. Inspect the belt system periodically, checking for cuts, frays, or loose parts. Damaged parts must be replaced immediately. Do not disassemble or modify the system. Front seat belt assemblies must be replaced after a collision. Rear seat belt assemblies must be replaced after a collision if they have been damaged (bent retractor, torn webbing, etc.).

Adjustable Upper Shoulder Belt Anchorage

In the driver and front passenger seats, the shoulder belt can be adjusted upward or downward to position the belt away from your neck. Push up or down on the anchorage button to release the anchorage, and then move it up or down to the position that serves you best.

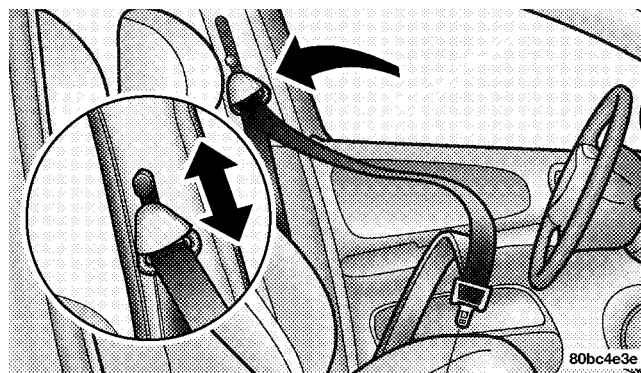

As a guide, if you are shorter than average, you will prefer a lower position, and if you are taller than average, you'll prefer a higher position. When you release the anchorage, try to move it up or down to make sure that it is locked in position.

Lap/Shoulder Belt Untwisting Procedure

Use the following procedure to untwist a twisted lap/shoulder belt.

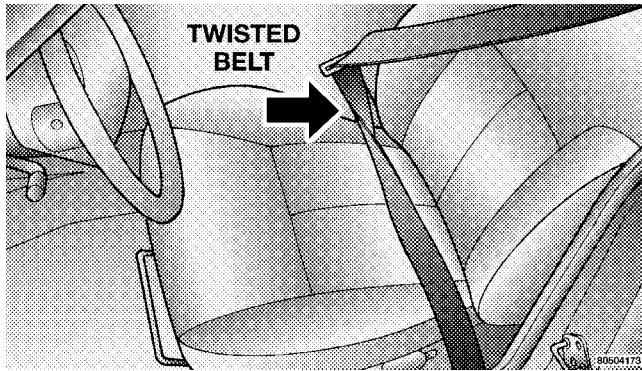

1. Position the latch plate as close as possible to the anchor point.

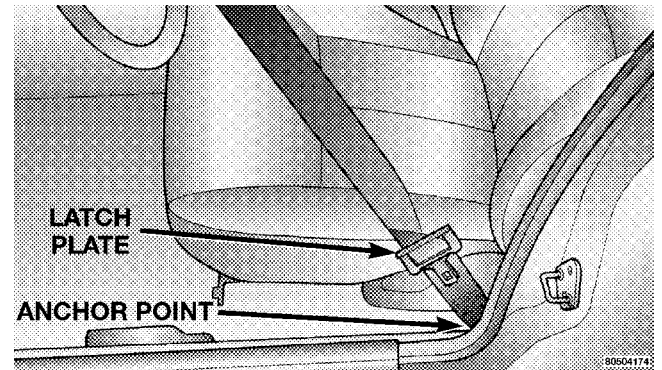

2

30 THINGS TO KNOW BEFORE STARTING YOUR VEHICLE

2. At about 6 to 12 inches above the latch plate, grasp and twist the belt webbing 180° to create a fold that begins immediately above the latch plate.

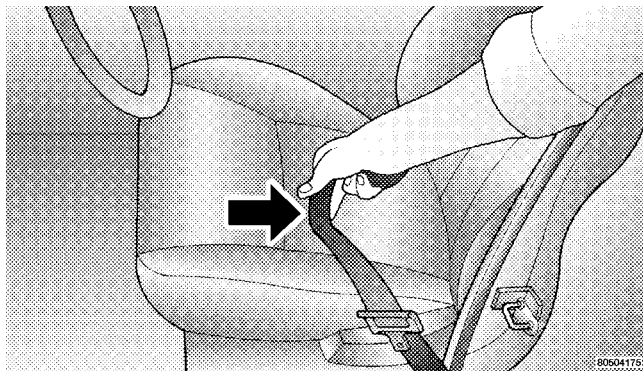

3. Slide the latch plate upward over the folded webbing. The folded webbing must enter the slot at the top of the latch plate.

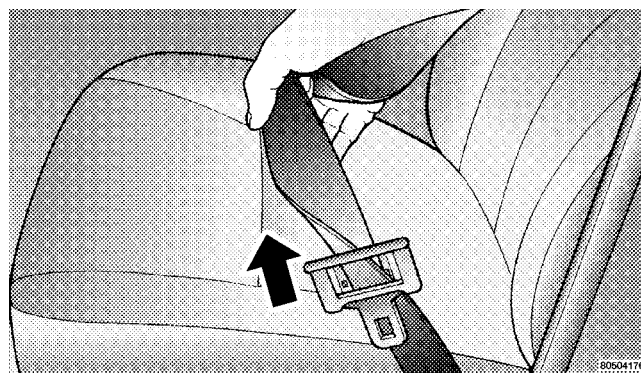

4. Continue to slide the latch plate up until it clears the folded webbing.

Seat Belts And Pregnant Women

We recommend that pregnant women use the seat belts throughout their pregnancy. Keeping the mother safe is the best way to keep the baby safe.

Pregnant women should wear the lap part of the belt across the thighs and as snug across the hips as possible.

Keep the belt low so that it does not come across the abdomen. That way the strong bones of the hips will take the force if there is a collision.

Seat Belt Extender

If a seat belt is too short, even when fully extended and when the adjustable upper shoulder belt anchorage (if equipped) is in its lowest position, your dealer can provide you with a seat belt extender. This extender should be used only if the existing belt is not long enough. When it is not required, remove the extender and store it.

WARNING!
Using a seat belt extender when not needed can increase the risk of injury in a collision. Only use when the seat belt is not long enough when it is worn low and snug, and in the recommended seating positions. Remove and store the extender when not needed.

Driver and Front Passenger Supplemental Restraint System (SRS) - Airbags

This vehicle has front airbags for both the driver and front passenger as a supplement to the seat belt restraint systems. The driver's front airbag is mounted in the center of the steering wheel. The passenger's front airbag is mounted in the instrument panel, above the glove compartment. The words SRS AIRBAG are embossed on the airbag covers.

2

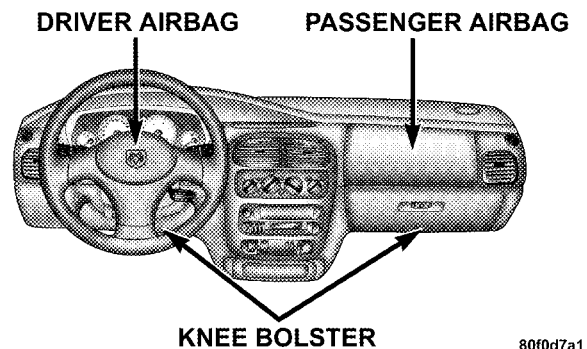

80f0d7a1

NOTE: The front airbags are certified to the Federal regulations that allow less forceful deployment.

If the vehicle is equipped with side airbags, they are located inside the driver and front passenger seats, and their covers are also labeled SRS AIRBAG.

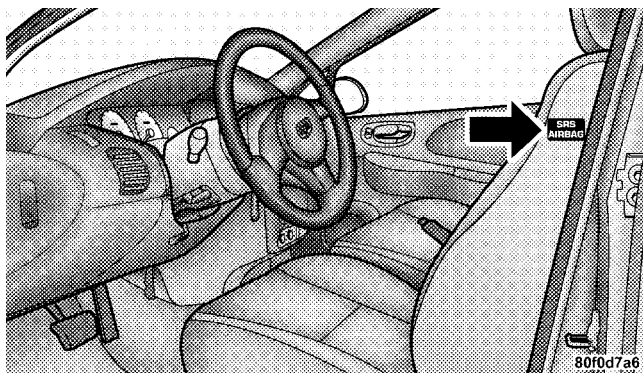

NOTE: Airbag covers may not be obvious in the interior trim; but they will open to allow airbag deployment.

WARNING!

- Do not put anything on or around the front airbag covers or attempt to manually open them. You may damage the airbags and you could be injured because the airbags are not there to protect you. These protective covers for the airbag cushions are designed to open only when the airbags are inflating.
- If your vehicle is equipped with side airbags, do not use accessory seat covers or place objects between you and the side airbags; the performance could be adversely affected and/or objects could be pushed into you, causing serious injury.
- If your vehicle is equipped with side airbags, do not attach cup holders or any other objects on or around the door. The inflating side airbag could drive the objects into occupants, causing serious injury.

Airbags inflate in moderate to high speed impacts. Along with the seat belts, front airbags work with the instrument panel knee bolsters to provide improved protection for the driver and front passenger. Side airbags also work with seat belts to improve occupant protection.

The seat belts are designed to protect you in many types of collisions. The front airbags deploy in moderate to severe frontal collisions. If your vehicle is equipped, the side airbag on the crash side of the vehicle is triggered in moderate to severe side collisions. In certain types of collisions, both the front and side airbags may be triggered. But even in collisions where the airbags work, you need the seat belts to keep you in the right position for the airbags to protect you properly.

Here are some simple steps you can take to minimize the risk of harm from a deploying airbag.

1. Children 12 years old and under should always ride buckled up in a rear seat.

Infants in rear facing child restraints (designed for children up to 20 lbs (9 kg) and less than one year old) should

NEVER ride in the front seat of a vehicle with a passenger front airbag. An airbag deployment could cause severe injury or death to infants in that position.

Children that are not big enough to properly wear the vehicle seat belt (see Section on Child Restraints) should be secured in the rear seat in child restraints or belt-positioning booster seats. Older children who do not use child restraints or belt-positioning booster seats should ride properly buckled up in the rear seat. Never allow children to slide the shoulder belt behind them or under their arm.

If a child from 1 to 12 years old must ride in the front passenger seat because the vehicle is crowded, move the seat as far back as possible, and use the proper child restraint. See the section on Child Restraint.

You should read the instructions provided with your child restraint to make sure that you are using it properly.

2. All occupants should wear their lap and shoulder belts properly.

3. The driver and front passenger seats should be moved back as far as practical to allow the front airbags room to inflate.

4. If your vehicle has side airbags, do not lean against the door; airbags will inflate forcefully into the space between you and the door.

WARNING!

- Relying on the airbags alone could lead to more severe injuries in a collision. The airbags work with your seat belt to restrain you properly. In some collisions the airbags won't deploy at all. Always wear your seat belts even though you have airbags.
- Being too close to the steering wheel or instrument panel during airbag deployment could cause serious injury. Airbags need room to inflate. Sit back, comfortably extending your arms to reach the steering wheel or instrument panel.
- If the vehicle has side airbags, they also need room to inflate. Do not lean against the door. Sit upright in the center of the seat.

Airbag System Components

The front airbag system consists of the following:

- Airbag Control Module (ACM)
- AIRBAG Readiness Light
- Driver Airbag
- Passenger Airbag
- Steering Wheel and Column
- Instrument Panel
- Crash Sensor
- Interconnecting Wiring
- Knee Impact Bolsters

The side airbag system, if equipped, consists of the following:

- AIRBAG Readiness Light (shared with the front airbag system)
- Side Airbag in the Driver's Seat
- Side Airbag in the Passenger's Seat

- Right and Left Side Impact Airbag Control Modules (SIACM)

- Interconnecting Wiring

How The Airbag System Works
Front Airbag System

- The front Airbag Control Module determines if a frontal collision is severe enough to require the airbags to inflate.
- The Airbag Control Module is not designed to detect side, roll over, or rear collisions.
- The Airbag Control Module also monitors the readiness of the electronic parts of the system whenever the ignition switch is in the START or ON/RUN positions. These include all of the items listed above except the knee bolsters, the instrument panel, and the steering wheel and column. If the key is in the OFF position, in the ACC position, or not in the ignition switch, the airbags are not on and will not inflate.

36 THINGS TO KNOW BEFORE STARTING YOUR VEHICLE

- The Airbag Control Module also turns on the AIRBAG light in the instrument panel for 6 to 8 seconds when the ignition switch is first turned to ON/RUN, then turns the light off. If it detects a malfunction in any part of the system, it turns on the light either momentarily or continuously.

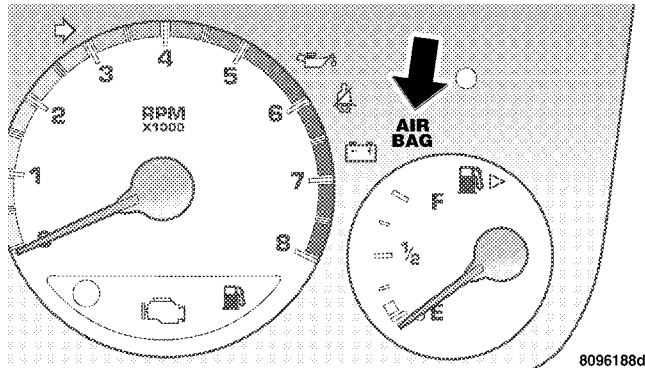

WARNING!

Ignoring the AIRBAG light in your instrument panel could mean you won't have the airbags to protect you in a collision. If the light does not come on, stays on after you start the vehicle, or if it comes on as you drive, have the airbag system checked right away.

- When the Airbag Control Module detects a collision requiring the airbags, it signals the inflator units. A large quantity of nontoxic gas is generated to inflate the airbags. The airbag covers separate and fold out of the way as the airbags inflate to their full size. The airbags fully inflate in about 50 milliseconds. This is only about half of the time it takes you to blink your eyes. The airbags then quickly deflate while helping to restrain the driver and front passenger. The driver's front airbag gas is vented through the airbag material towards the instrument panel. The passenger's front airbag gas is vented through vent holes in the sides of the airbag. In this way the airbags do not interfere with your control of the vehicle.

- The knee impact bolsters help protect the knees and position you for the best interaction with the front airbag.

If A Deployment Occurs

The airbag system is designed to deploy when the Airbag Control Module detects a moderate-to-severe frontal collision, to help restrain the driver and front passenger, and then to immediately deflate.

NOTE: A frontal collision that is not severe enough to need airbag protection will not activate the system. This does not mean something is wrong with the airbag system.

If you do have a collision which deploys the airbags, any or all of the following may occur:

- The nylon airbag material may sometimes cause abrasions and/or skin reddening to the driver and front passenger as the airbags deploy and unfold. The abrasions are similar to friction rope burns or those you might get sliding along a carpet or gymnasium floor. They are not caused by contact with chemicals. They are not permanent and normally heal quickly.
- However, if you have not healed significantly within a few days, or if you have any blistering, see your doctor immediately.
- As the airbags deflate you may see some smoke-like particles. The particles are a normal by-product of the process that generates the nontoxic gas used for airbag inflation. These airborne particles may irritate the skin, eyes, nose, or throat. If you have skin or eye irritation, rinse the area with cool water. For nose or throat irritation, move to fresh air. If the irritation continues, see your doctor. If these particles settle on your clothing, follow the garment manufacturer's instructions for cleaning.
 - It is not advisable to drive your vehicle after the airbags have deployed. If you are involved in another collision, the airbags will not be in place to protect you.

WARNING!

Deployed airbags can't protect you in another collision. Have the airbags replaced by an authorized dealer as soon as possible.

Side Airbag System — If Equipped

- The Side Impact Airbag Control Modules determine if a side collision is severe enough to require the airbag to inflate. The Side Impact Airbag Control Modules is not designed to detect roll over, front, or rear impacts.
- The Side Impact Airbag Control Module monitors the readiness of the electronic parts of the system whenever the ignition switch is in the START or ON/RUN positions. These include all of the items listed above. If the left or right SIACM detects a malfunction in any part of the system, it will send a message to the frontal ACM to turn the Airbag Light on. The Airbag Control Module also turns on the AIRBAG light in the instrument panel for 6 to 8 seconds when the ignition switch is first turned on as a diagnostic or system check, then turns the light off.

- In moderate to severe side collisions, the side airbag inflator on the crash side of the vehicle is triggered by the appropriate SIACM, releasing a quantity of non-toxic gas. The inflating side airbag exits through the seat seam into the space between the occupant and the door. The side airbag moves at a very high speed and with such a high force, that it could injure you if you are not seated properly, or if items are positioned in the area where the side airbag inflates. This especially applies to children.

Enhanced Accident Response Time — If Equipped

If the airbags deploy after an impact and the electrical system remains functional, vehicles equipped with power door locks will unlock automatically. In addition, approximately 10 seconds after the vehicle has stopped moving, the interior lights will light until the ignition switch is turned off.

Maintaining Your Airbag Systems

WARNING!

- **Modifications to any part of the airbag system could cause it to fail when you need it. You could be injured because the airbags are not there to protect you. Do not modify the components or wiring, including adding any kind of badges or stickers to the steering wheel hub trim cover or the upper right side of the instrument panel. Do not modify the front bumper, vehicle body structure, or frame.**
- **You need proper knee impact protection in a collision. Do not mount or locate any aftermarket equipment on or behind the knee bolster.**
- **It is dangerous to try to repair any part of the airbag system yourself. Be sure to tell anyone who works on your vehicle that it has airbags.**

Airbag Light

You will want to have the airbags ready to inflate for your protection in an impact. While the airbag system is designed to be maintenance free, if any of the following occurs, have an authorized dealer service the system immediately:

- The AIRBAG light does not come on or flickers during the 6 to 8 seconds when the ignition switch is first turned on.
- The light remains on or flickers after the 6 to 8 second interval.
- The light flickers or comes on and remains on while driving.

Child Restraint

Everyone in your vehicle needs to be buckled up at all times — babies and children, too. Every state in the United States and all Canadian provinces require that small children ride in proper restraint systems. This is the law, and you can be prosecuted for ignoring it.

Children 12 years and under should ride properly buckled up in a rear seat, if available. According to crash statistics, children are safer when properly restrained in the rear seats, rather than in the front.

WARNING!

In a collision, an unrestrained child, even a tiny baby, can become a missile inside the vehicle. The force required to hold even an infant on your lap could become so great that you could not hold the child, no matter how strong you are. The child and others could be badly injured. Any child riding in your vehicle should be in a proper restraint for the child's size.

Infants And Small Children

There are different sizes and types of restraints for children from newborn size to the child almost large enough for an adult safety belt. Always check the child seat Owner's Manual to ensure you have the right seat for your child. Use the restraint that is correct for your child:

- Safety experts recommend that children ride rearward-facing in the vehicle until they are at least one year old **and** weigh at least 20 lbs (9 kg). Two types of child restraints can be used rearward-facing: infant carriers and "convertible" child seats. Both types of child restraints are held in the vehicle by the lap/shoulder belt or the LATCH child restraint anchorage system.
- The infant carrier is only used rearward-facing in the vehicle. It is recommended for children who weigh up to about 20 lbs (9 kg). "Convertible" child seats can be used either rearward-facing or forward-facing in the vehicle. Convertible child seats often have a higher weight limit in the rearward-facing direction than infant carriers do, so they can be used rearward-facing by children who weigh more than 20 lbs (9 kg) but are less than one year old.
- Rearward-facing child seats must **NEVER** be used in the front seat of a vehicle with the front passenger airbag. An airbag deployment could cause severe injury or death to infants in this position.

- Children who weigh more than 20 lbs (9 kg) and who are older than one year can ride forward-facing in the vehicle. Forward-facing child seats and convertible child seats used in the forward-facing direction are for children who weigh 20 to 40 lbs (9 to 18 kg) and who are older than one year. These child seats are also held in the vehicle by the lap/shoulder belt or the LATCH child restraint anchorage system.
- The belt-positioning booster seat is for children weighing more than 18 kg (40 lbs), but who are still too small to fit the vehicle's seat belts properly. If the child cannot sit with knees bent over the vehicle's seat cushion while the child's back is against the seat back; they should use a Belt Positioning Booster Seat. The child and booster seat are held in the vehicle by the lap/shoulder belt. (Some booster seats are equipped with a front shield and are held in the vehicle by the lap portion.)

NOTE: For additional information refer to www.seatcheck.org.

WARNING!

- **Improper installation can lead to failure of an infant or child restraint. It could come loose in a collision. The child could be badly injured or killed. Follow the manufacturer's directions exactly when installing an infant or child restraint.**
- **A rearward facing infant restraint should only be used in a rear seat. A rearward facing infant restraint in the front seat may be struck by a deploying passenger airbag which may cause severe or fatal injury to the infant.**

Here are some tips on getting the most out of your child restraint:

- Before buying any restraint system, make sure that it has a label certifying that it meets all applicable Safety Standards. We also recommend that you make sure that you can install the child restraint in the vehicle where you will use it before you buy it.

42 THINGS TO KNOW BEFORE STARTING YOUR VEHICLE

- The restraint must be appropriate for your child's weight and height. Check the label on the restraint for weight and height limits.
- Carefully follow the instructions that come with the restraint. If you install the restraint improperly, it may not work when you need it.

The passenger seat belts are equipped with cinching latch plates which are designed to keep the lap portion tight around the child restraint so that it is not necessary to use a locking clip. Pulling up on the shoulder portion of the lap/shoulder belt will tighten the belt. The cinching latch plate will keep the belt tight, however, any seat belt system will loosen with time, so check the belt occasionally and pull it tight if necessary.

- In the rear seat, you may have trouble tightening the lap/shoulder belt on the child restraint because the buckle or latch plate is too close to the belt path opening on the restraint. Disconnect the latch plate from the buckle and twist the short buckle-end belt several times to shorten it. Insert the latch plate into the buckle with the release button facing out.

- If the belt still can't be tightened, or if pulling and pushing on the restraint loosens the belt, disconnect the latch plate from the buckle, turn the buckle around, and insert the latch plate into the buckle again. If you still can't make the child restraint secure, try a different seating position.
- Buckle the child into the seat according to the child restraint manufacturer's directions.
- When your child restraint is not in use, secure it in the vehicle with the seat belt or remove it from the vehicle. Do not leave it loose in the vehicle. In a sudden stop or collision, it could strike the occupants or seat backs and cause serious personal injury.

LATCH —Lower **A**nchors and **T**ether for **C**hildren
Your vehicle's rear seat is equipped with the child restraint anchorage system called LATCH, which stands for Lower Anchors and Tether for Children. The LATCH system provides for the installation of the child restraint without using the vehicle seat belt. All three rear seating positions have exclusive lower anchorages. These are round bars, located at the rear of the seat cushion where it meets the seat back, and just visible when you lean into

the rear seat to install the child restraint. You will easily feel them if you run your finger along the intersection of the surfaces. The lower strap hooks are passed over the top of each bar, pushing aside the seat cover material.

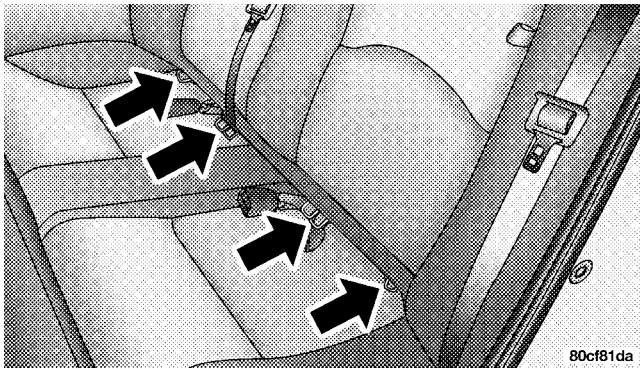

In addition, there are tether strap anchorages behind each rear seating position located in the panel between the rear seat back and the rear window — under a hinged plastic cover with this symbol on it. (Shown to the left) In recent years, only the tether anchorage has been provided in new vehicles.

To attach a child restraint tether strap:

1. Lift the cover over the anchor directly behind the seat where you are placing the child restraint.

2

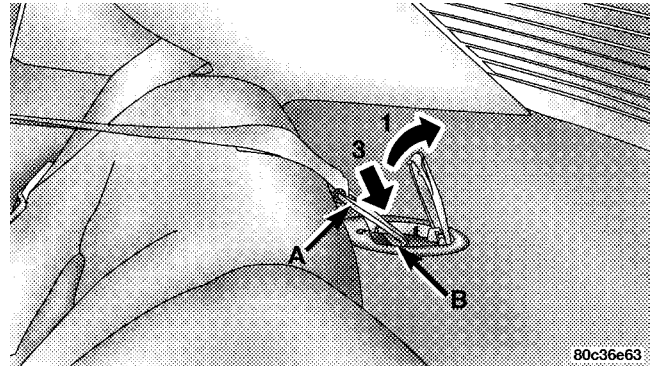

2. Route the tether strap to provide the most direct path for the strap between the anchor and the child seat. If your vehicle is equipped with adjustable rear head restraints, raise the head restraint and, where possible, route the tether strap under the head restraint and between the two posts. If not possible, lower the head restraint and pass the tether strap around the outboard side of the head restraint.

3. Attach the tether strap hook (A) of the child restraint to the anchor (B) and remove slack in the tether strap according to the child restraint manufacturer's instructions.

WARNING!

An incorrectly anchored tether strap could lead to increased head motion and possible injury to the child. Use only the anchor positions directly behind the child seat to secure a child restraint top tether strap.

Child restraint systems having attachments designed to connect to the lower anchorages are now available. Child restraints having tether straps and hooks for connection to the top tether anchorage have been available for some time. In fact, many child restraint manufacturers will provide add-on tether strap kits for some of their older products. Tether anchorage kits are also available for most older vehicles.

Because the lower anchorages are to be introduced to passenger carrying vehicles over a period of years, child restraint systems having attachments for those anchorages will continue to have features for installation in vehicles using the lap or lap/shoulder belt. They will also have tether straps, and you are urged to take advantage of all of the available attachments provided with your child restraint in any vehicle.

Installing the Child Restraint System

While there are LATCH anchorages at all three rear seating positions, do not install child restraints at all three positions at the same time. The anchorages are not designed to restrain three child restraints at one time. Instead, you may install one child restraint at the center position, or two child restraints at the right and left positions.

WARNING!

Do not install child restraint systems equipped with LATCH attachments at all three rear seating positions at one time. The LATCH anchorages are designed to restrain no more than two child restraints at a time in the event of a collision.

We urge that you carefully follow the directions of the manufacturer when installing your child restraint. Many, but not all, restraint systems will be equipped with separate straps on each side, with each having a hook or connector and a means for adjusting the tension in the strap. Forward-facing toddler restraints and some rearward-facing infant restraints will also be equipped with a tether strap, a hook and means for adjusting the tension in the strap.

In general, you will first loosen the adjusters on the lower straps and tether straps so that you can more easily attach the hook or connector to the lower anchorages and tether anchorages. Then tighten all three straps as you push the child restraint rearward and downward into the seat.

Not all child restraint systems will be installed as we have described here. Again, carefully follow the instructions that come with the child restraint system.

NOTE: If your child restraint seat is not LATCH compatible, install the restraint using the vehicle seat belts.

2

WARNING!

Improper installation of a child restraint to the LATCH anchorages can lead to failure of an infant or child restraint. The child could be badly injured or killed. Follow the manufacturer's directions exactly when installing an infant or child restraint.

Children Too Large For Booster Seats

Children who are large enough to wear the shoulder belt comfortably, and whose legs are long enough to bend over the front of the seat when their back is against the seat back, should use the lap/shoulder belt in a rear seat.

- Make sure that the child is upright in the seat.

- The lap portion should be low on the hips and as snug as possible.
- Check belt fit periodically. A child's squirming or slouching can move the belt out of position.
- If the shoulder belt contacts the face or neck, move the child closer to the center of the vehicle. Never allow a child to put the shoulder belt under an arm or behind their back.

Transporting Pets

Airbags deploying in the front seat could harm your pet. An unrestrained pet will be thrown about and possibly injured, or injure a passenger during panic braking or in a collision.

Pets should be restrained in the rear seat in pet harnesses or pet carriers that are secured by seat belts.

ENGINE BREAK-IN RECOMMENDATIONS

The engine in your new vehicle does not require a long break-in period.

Drive moderately during the first 300 miles (500 km). After the initial 60 miles (100 km), speeds up to 50 or 55 mph (80 or 90 km/h) are desirable.

While cruising, brief full-throttle acceleration, within the limits of local traffic laws, contributes to a good break-in.

Wide open throttle acceleration in low gear can be detrimental and should be avoided.

The crankcase oil installed in the engine at the factory is a high quality energy conserving type lubricant. Oil changes should be consistent with expected climate conditions under which vehicle operations will occur. The recommended viscosity and quality grades are in Section 7 of this manual.

Do not use non-detergent or straight mineral oils.

A new engine may consume some oil during its first few thousand miles of operation. This is a normal part of the break-in and not an indication of a problem.

SAFETY TIPS**Exhaust Gas****WARNING!**

Exhaust gases can injure or kill. They contain carbon monoxide (CO) which is colorless and odorless. Breathing it can make you unconscious and can eventually poison you. To avoid breathing (CO) follow the safety tips below.

Do not run the engine in a closed garage or in confined areas any longer than needed to move your vehicle in or out of the area.

If it is necessary to sit in a parked vehicle with the engine running, adjust your heating or cooling controls to force outside air into the vehicle. Set the blower at high speed.

To avoid drawing exhaust gases into the vehicle, close the trunk while driving. However, if for some reason it must

remain open, close all windows. Adjust the heating or cooling system to force outside air into the vehicle. Set the blower at high speed.

Safety Checks You Should Make Inside The Vehicle**Seat Belts**

Inspect the belt system periodically, checking for cuts, frays and loose parts. Damaged parts must be replaced immediately. Do not disassemble or modify the system.

Front seat belt assemblies must be replaced after a collision. Rear seat belt assemblies must be replaced after a collision if they have been damaged (bent retractor, torn webbing, etc.). If there is any question regarding belt or retractor condition, replace the belt.

Airbag Light

AIR BAG The light should come on and remain on for 6 to 8 seconds as a bulb check when the ignition switch is first turned to ON/RUN. If the bulb is not lit during starting, have it replaced. If the light stays on or comes on while driving, have the system checked by an authorized dealer.

Defrosters

Check operation by selecting the defrost mode and place the blower control on high speed. You should be able to feel the air directed against the windshield.

Periodic Safety Checks You Should Make Outside The Vehicle

Tires

Examine tires for excessive tread wear or uneven wear patterns. Check for stones, nails, glass, or other objects lodged in the tread. Inspect for tread cuts or sidewall cracks. Check wheel nuts for tightness, and tires (including spare) for proper pressure.

Lights

Have someone observe the operation of exterior lights while you work the controls. Check turn signal and high beam indicator lights on the instrument panel.

Fluid Leaks

Check area under vehicle after overnight parking for fuel, water, oil, or other fluid leaks. Also, if gasoline fumes are present, the cause should be corrected immediately.

UNDERSTANDING THE FEATURES OF YOUR VEHICLE

CONTENTS

■ Mirrors51	□ Folding Rear Seat57
□ Inside Day/Night Mirror51	■ To Open And Close The Hood58
□ Inside Compass/Temperature Mirror—If Equipped51	■ Lights60
□ Outside Mirror — Driver’s Side54	□ Front Map/Reading Lights — If Equipped60
□ Outside Mirror — Passenger’s Side54	□ Interior Lights60
□ Electric Remote-Control Mirrors — If Equipped54	□ Multi-Function Control Lever61
■ Seats55	□ Headlights, Parking Lights, Instrument Panel Lights61
□ Front Seat Adjustment55	□ Daytime Running Lights (Canada Only)62
□ Reclining Bucket Seats56	□ Lights-On Reminder62
□ Adjustable Head Restraints57	□ Fog Lights — If Equipped62
		□ Turn Signals62

50 UNDERSTANDING THE FEATURES OF YOUR VEHICLE

<input type="checkbox"/> Headlight Dimmer Switch62	<input type="checkbox"/> To Set At A Desired Speed66
<input type="checkbox"/> Passing Light62	<input type="checkbox"/> To Deactivate66
<input checked="" type="checkbox"/> Windshield Wipers And Washers63	<input type="checkbox"/> To Resume Speed66
<input type="checkbox"/> Windshield Washers63	<input type="checkbox"/> To Vary The Speed Setting66
<input type="checkbox"/> Mist Function63	<input type="checkbox"/> Manual Transaxle67
<input type="checkbox"/> Intermittent Wiper System63	<input type="checkbox"/> To Accelerate For Passing67
<input type="checkbox"/> Lo Speed Wipers64	<input checked="" type="checkbox"/> Power Sunroof — If Equipped68
<input type="checkbox"/> Hi Speed Wipers64	<input type="checkbox"/> Sunroof Maintenance69
<input checked="" type="checkbox"/> Tilt Steering Column64	<input type="checkbox"/> Wind Buffeting69
<input checked="" type="checkbox"/> Electronic Speed Control — If Equipped65	<input checked="" type="checkbox"/> Console Features69
<input type="checkbox"/> To Activate65	<input type="checkbox"/> Ash Receiver And Cigar Lighter70

MIRRORS

Inside Day/Night Mirror

Adjust the mirror to center on the view through the rear window. A two point pivot system allows for horizontal and vertical mirror adjustment.

Annoying headlight glare can be reduced by moving the small control under the mirror to the night position (toward rear of vehicle). The mirror should be adjusted while set in the day position (toward windshield).

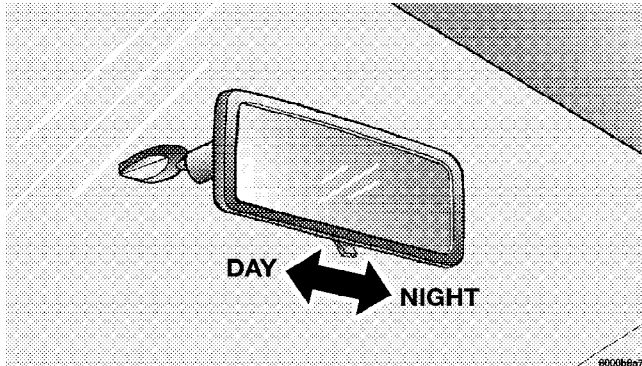

Inside Compass/Temperature Mirror—If Equipped

Adjust the mirror to center the view through the rear window. A two point pivot system allows for horizontal and vertical mirror adjustments.

Annoying headlight glare can be reduced by rotating the small knob under the mirror in the clockwise direction, so the knob points to the right (night position). The mirror should be adjusted while set in the day position (knob points towards rear of vehicle.)

3

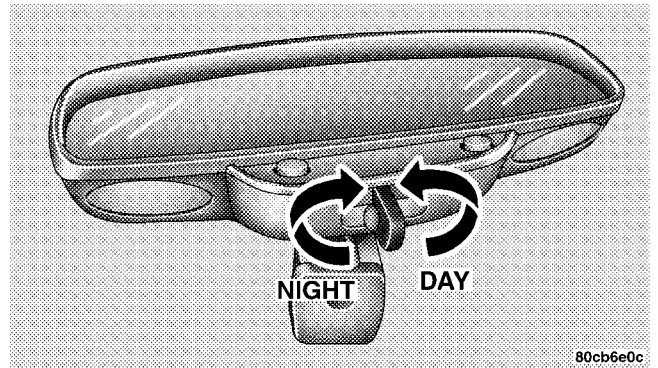

80cb6e0c

Lights

- Briefly press the “Right” button to toggle the right reading lamp “ON/OFF”. Repeat the key press to cycle the light
- Briefly press the “Left” button to toggle the left reading lamp “ON/OFF”. Repeat the key press to cycle the light.

NOTE: The light can be activated with the ignition off.

NOTE: The light(s) will automatically shut off after seven minutes with ignition off.

Temperature

Press and hold the “Right” button for 5–10 seconds (until °F/°C toggles in the display) then release the button. Repeat the key press to cycle the °F/°C in the display.

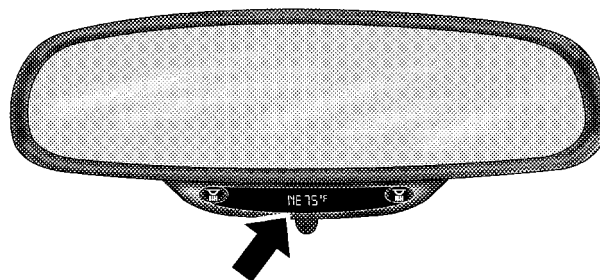

80c805c6

Display ON/OFF

Press and hold the “Right” button for 10–15 seconds (until display toggles ON/OFF) then release the button. Repeat the key press to cycle the display ON/OFF.

NOTE: The display will default “ON” at each new ignition cycle.

Compass Variance

- Find your current location and determine the correct Zone number from the map.
- Press and hold the “Left” button for 5–10 seconds (until “Zone” appears in the display), then release the button. The number displayed is the current Zone value.
- If a new Zone value is desired, briefly press the “Left” button to increment the displayed value, (Range 1–15) until you find your desired Zone number.
- No button activity for 4–5 seconds ends the Zone entry mode. The display will return to normal operation and the new Zone number will be set.

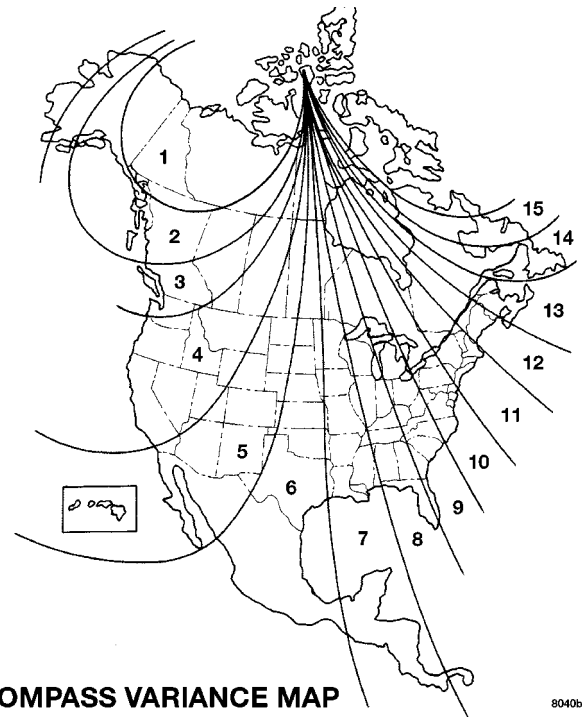

Compass Calibration

If “CAL” is not displayed, press and hold the “Left” button for 10–15 seconds, or until “CAL” appears in the display, then release the button. The compass is now in calibration mode.

The mirror can be calibrated in one of two ways

- Drive the vehicle in circles at less than 5mph (8 km/h) until “CAL” no longer appears in the display.
- Drive the vehicle under normal operating conditions.

Outside Mirror — Driver’s Side

Adjust the outside mirror to center on the adjacent lane of traffic, with a slight overlap of the view obtained on the inside mirror.

Outside Mirror — Passenger’s Side

Adjust the convex outside mirror so you can just see the side of your vehicle in the part of the mirror closest to the vehicle.

WARNING!

Vehicles and other objects seen in the passenger side convex mirror will look smaller and farther away than they really are. Relying too much on your passenger side mirror could cause you to collide with another vehicle or other object. Use your inside mirror when judging the size or distance of a vehicle seen in this convex mirror.

Electric Remote-Control Mirrors — If Equipped

Use the mirror select switch, located on the drivers door trim panel, to adjust the view obtained in the outside mirrors. Press the rocker knob to the L or R for Left or Right mirror selection. Use the center off position to guard against accidentally moving a mirror position.

Select a mirror and press one of the four arrows for the direction you want the mirror to move.

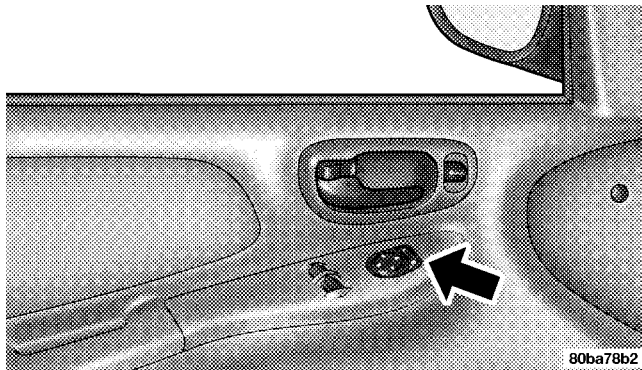

SEATS

Front Seat Adjustment

The adjusting bar is at the front of the seats, near the floor. Pull the bar up to move the seat to the desired position.

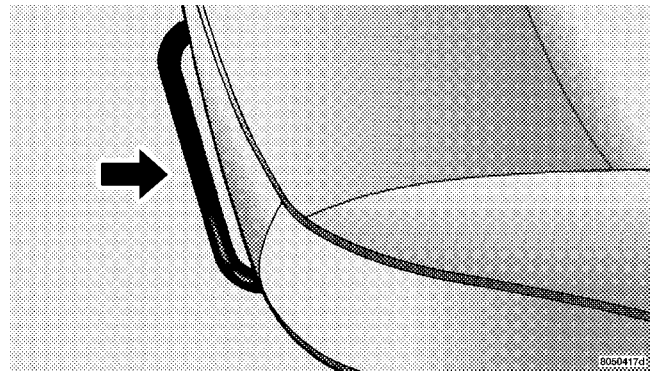

3

Using body pressure, move forward and rearward on the seat to be sure the seat adjusters have latched after the adjustment bar is released.

WARNING!

- **Adjusting a seat while the vehicle is moving is dangerous. The sudden movement of the seat could cause you to lose control. The seat belt might not be properly adjusted and you could be injured. Adjust the seat only while the vehicle is parked.**
- **Do not ride with the seatback reclined so that the shoulder belt is no longer resting against your chest. In a collision you could slide under the seat belt and be seriously or even fatally injured. Use the recliner only when the vehicle is parked.**

Reclining Bucket Seats

The recliner control is on the side of the seat. To recline, lean forward slightly before lifting the lever, then lean back to the desired position and release the lever. Lean forward and lift the lever to return the seatback to its normal position.

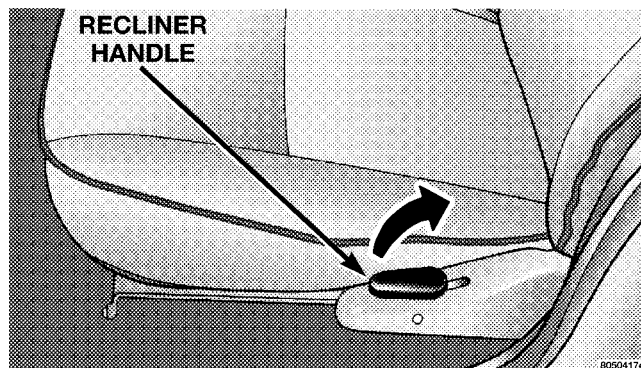

Adjustable Head Restraints

Head restraints can reduce the risk of whiplash injury in the event of impact from the rear. Pull up or push down on the restraints so that the upper edge is as high as practical. Push in on the release button to lower the head restraint.

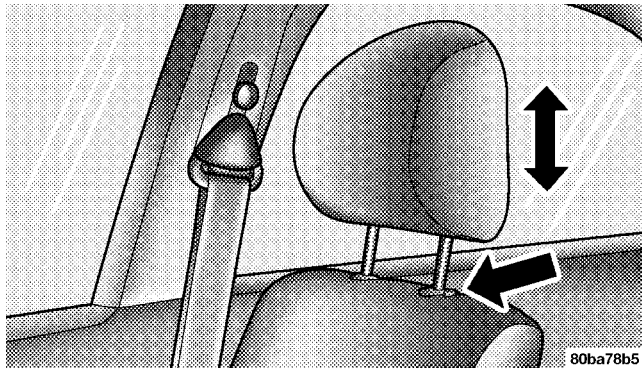

Folding Rear Seat

To provide additional storage area, the center of each rear seatback can be folded forward. Pull on the loops shown in the picture to fold down either or both seatbacks.

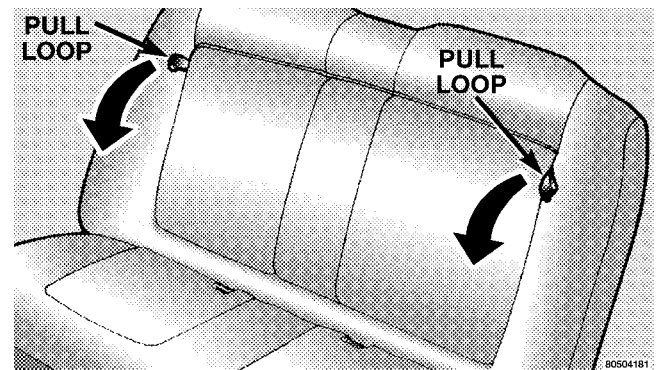

WARNING!

- It is extremely dangerous to ride in a cargo area, inside or outside of a vehicle. In a collision, people riding in these areas are more likely to be seriously injured or killed.
- Do not allow people to ride in any area of your vehicle that is not equipped with seats and seatbelts
- Be sure that everyone in your vehicle is in a seat and using a seatbelt properly.

TO OPEN AND CLOSE THE HOOD

To open the hood, two latches must be released. First pull the hood release lever located under the driver's side of the instrument panel.

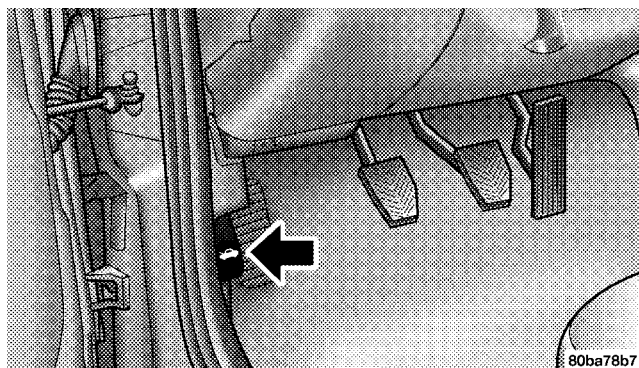

Then lift the safety catch located under the front edge of the hood, near the center and raise the hood.

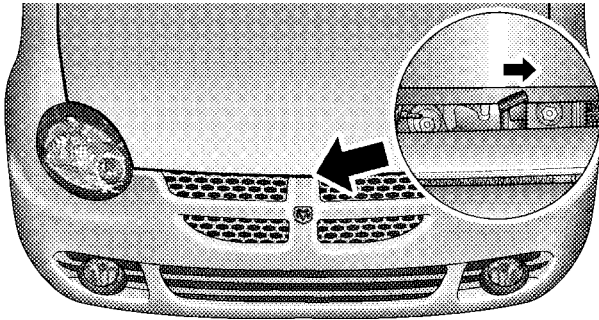

80f4ebda

Use the hood prop rod to secure the hood in the open position as shown. To prevent possible damage, do not slam the hood to close it. Use a firm downward push at the center of the hood to ensure that both latches engage.

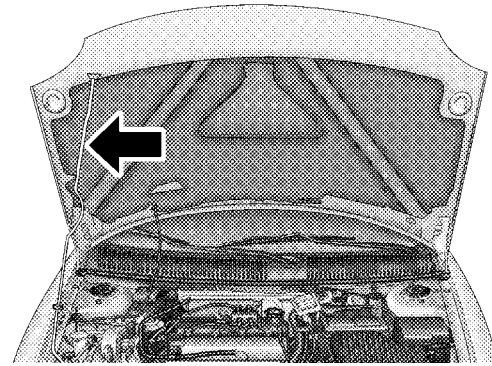

80be33d6

3

WARNING!

If the hood is not fully latched it could fly up when the vehicle is moving and block your forward vision. You could have a collision. Be sure all hood latches are fully latched before driving.

LIGHTS

Front Map/Reading Lights — If Equipped

These lights, located under the rearview mirror, can be turned on by means of switches located at the base of the rearview mirror.

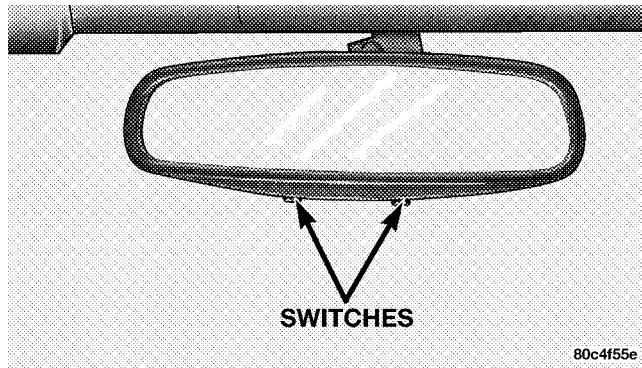

80c4f55e

NOTE: The map lights will remain on when the ignition switch is in the Run or Accessory positions.

Interior Lights

The interior lights come on when a door is opened.

The interior lights will automatically turn off in about 8 minutes if a door is left open or the dimmer control is left in the Dome light position. Turn the ignition switch ON to restore the interior light operation.

Dimmer Control

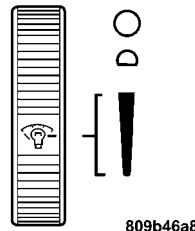

809b46a8

With the park lights or headlights on, rotating the dimmer control for the interior lights on the Multi-Function Control Lever upward will increase the brightness of the instrument panel lights.

Dome Light Position

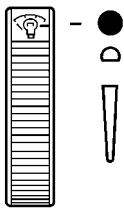

809b46b6

Rotate the dimmer control completely upward to the second detent to turn on the interior lights. The interior lights will remain on when the dimmer control is in this position.

Daytime Brightness Feature

Certain instrument panel components can be illuminated at full brightness during the daytime. These are the Odometer and Radio. This can be helpful when driving with your headlights on during the daytime such as in a parade or a funeral procession. To activate this feature, rotate the dimmer ring on the left stalk one detent lower than the dome light.

Multi-Function Control Lever

The Multi-Function Control Lever controls the operation of the headlights, parking lights, turn signals, headlight beam selection, instrument panel light dimming, interior

lights, the passing lights, and fog lights. The lever is located on the left side of the steering column.

Headlights, Parking Lights, Instrument Panel Lights

Turn the end of the Multi-Function Control Lever to the first detent for parking light operation. Turn to the second detent for headlight operation.

3

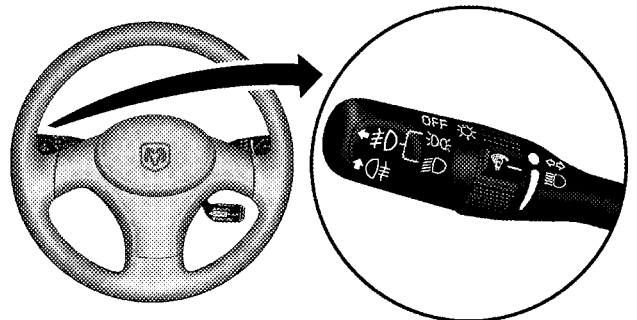

80f0d82d

To change the brightness of the instrument panel lights, rotate the center portion of the Multi-Function Control Lever up or down.

Daytime Running Lights (Canada Only)

The front fog lights will come on as Daytime Running Lights whenever the ignition is on, the headlights are off, and the parking brake is off. The headlight switch must be used for normal night time driving.

Lights-on Reminder

If the headlights or parking lights are on after the ignition is turned OFF, a chime will sound when the driver's door is opened. Leaving the headlights on for an extended period of time will discharge the battery resulting in reduced battery life and possible inability to start the vehicle.

Fog Lights — If Equipped

 The front fog light switch is on the Multi-Function Control Lever. To activate the front fog lights, turn on the headlights and pull out the end of the control lever.

NOTE: The fog lights will only operate with the headlights on low beam. Selecting high beam headlights or park lights will turn off the fog lights.

Turn Signals

Move the Multi-Function Control Lever up or down to detent and the arrows on each side of the instrument cluster flash to show proper operation of the front and rear turn signal lights. You can signal a lane change by moving the lever partially up or down.

If either light remains on and does not flash, or there is a very fast flash rate, check for a defective outside light bulb. If an indicator fails to light when the lever is moved, it would suggest that the fuse or indicator bulb is defective.

Headlight Dimmer Switch

Pull the Multi-Function Control Lever towards you to switch the headlights to HIGH beam. Pull the control lever a second time to switch the headlights to LOW beam.

Passing Light

You can signal another vehicle with your headlights by lightly pulling the Multi-Function Control Lever toward you. This will cause the headlights to turn on at high beam and remain on until the lever is released.

WINDSHIELD WIPERS AND WASHERS



The wipers and washers are operated by a switch on the control lever. The lever is located on the right side of the steering column. Move the control lever up to select the desired wiper speed.

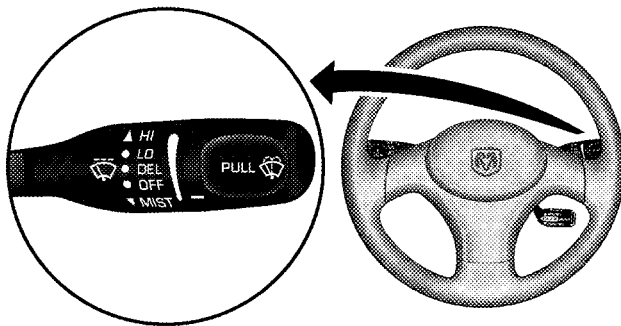

80f0d8a6

Windshield Washers

To use the washer, pull the control lever toward you and hold while spray is desired. If the lever is pulled while in the delay range, the wiper will operate in low speed for two wipe cycles after the lever is released, and then resume the intermittent interval previously selected.

If the lever is pulled while in the OFF position, the wipers will operate for two wipe cycles, then turn OFF.

CAUTION!

- In cold weather, always turn off the wiper switch and allow the wipers to return to the park position before turning off the engine. If the wiper switch is left on and the wipers freeze to the windshield, damage to the wiper motor may occur when the vehicle is restarted.

3

Mist Function

Push down on the wiper control lever to activate a single wipe to clear the windshield of road mist or spray from a passing vehicle. As long as the lever is held down, the wipers will continue to operate.

Intermittent Wiper System

Use the intermittent wiper when weather conditions make a single wiping cycle, with a variable pause between cycles, desirable. Move the lever to the first detent (DEL) position, then select the delay interval by turning

the end of the lever. Rotate the knob upward (clockwise) to decrease the delay time and downward (counterclockwise) to increase the delay time. The delay can be regulated from a maximum of approximately 18 seconds between cycles, to a cycle every second.

Lo Speed Wipers

Move the wiper stalk upward to the 2nd detent to obtain a low speed wiper function.

Hi Speed Wipers

Move the wiper stalk upward to the 3rd position to obtain the fastest wiper speed.

TILT STEERING COLUMN

To tilt the column, push down on the lever below the turn signal control and move the wheel up or down, as desired. Pull the lever back towards you to lock the column firmly in place.

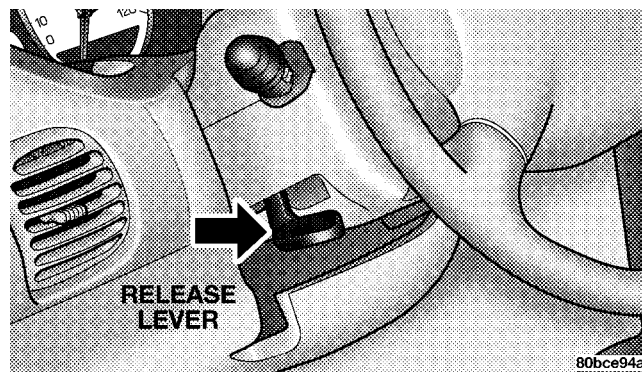

WARNING!

Tilting the steering column while the vehicle is moving is dangerous. Without a stable steering column, you could lose control of the vehicle and have an accident. Adjust the column only while the vehicle is stopped. Be sure it is locked before driving.

ELECTRONIC SPEED CONTROL — IF EQUIPPED

When engaged, this device takes over the accelerator operation at speeds greater than 25 mph (40 km/h). The speed control lever is located on the right side of the steering wheel.

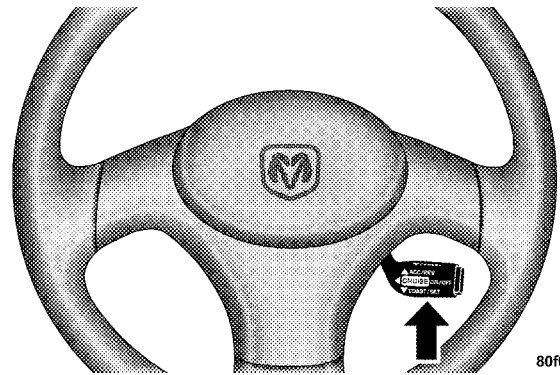

80f0d8b1

To Activate:

Push the ON/OFF button. The CRUISE indicator in the instrument cluster will illuminate. To turn the system OFF, push the ON/OFF button a second time. The CRUISE indicator will turn off. The system should be turned OFF when not in use.

WARNING!

Leaving the Electronic Speed Control system on when not in use is dangerous. You could accidentally set the system or cause it to go faster than you want. You could lose control and have an accident. Always leave the system OFF when you are not using it.

To Set At A Desired Speed:

When the vehicle has reached the desired speed, press down on the lever and release. Release the accelerator and the vehicle will operate at the selected speed.

NOTE: The vehicle should be traveling at a steady speed and on level ground before pressing the SET lever.

To Deactivate:

A soft tap on the brake pedal, pulling the speed control lever towards you "CANCEL", or normal brake or clutch pressure while slowing the vehicle will deactivate speed control without erasing the set speed memory. Pressing the ON/OFF button or turning off the ignition switch erases the set speed memory.

To Resume Speed:

To resume a previously set speed, push the "ACC/RES" lever up and release. Resume can be used at any speed above 32 km/h (20 mph).

To Vary The Speed Setting:

When the speed control is ON, speed can be increased by pushing up and holding "ACC/RES". Release the lever when the desired speed is reached, and the new speed will be set.

Tapping "ACC/RES" once will result in a 2 mph (3 km/h) speed increase. Each time the lever is tapped, speed increases so that tapping the lever three times will increase speed by 6 mph (10 km/h), etc.

To decrease speed while speed control is ON, push down and hold "COAST/SET". Release the lever when the desired speed is reached, and the new speed will be set.

Tapping the "COAST/SET" button once will result in a 1 mph (2 km/h) speed decrease. Each time the button is tapped, speed decreases.

Manual Transaxle:

Depressing the clutch pedal will disengage the speed control. A slight increase in engine RPM before the speed control disengages is normal.

Vehicles equipped with manual transaxles may need to be shifted into a lower gear to climb hills without speed loss.

WARNING!

Speed Control can be dangerous where the system can't maintain a constant speed. Your vehicle could go too fast for the conditions, and you could lose control. An accident could be the result. Don't use Speed Control in heavy traffic or on roads that are winding, icy, snow-covered, or slippery.

To Accelerate For Passing:

Depress the accelerator as you would normally. When the pedal is released, the vehicle will return to the set speed.

Using Speed Control On Hills

NOTE: The speed control system maintains speed up and down hills. A slight speed change on moderate hills is normal.

Vehicles equipped with four speed automatic transaxles may experience a downshift to 3rd gear while climbing uphill or descending downhill. This downshift to 3rd gear is necessary to maintain vehicle set speed.

On steep hills a greater speed loss or gain may occur so it may be preferable to drive without speed control.

POWER SUNROOF — IF EQUIPPED

The sunroof control is located on the headliner between the sun visors.

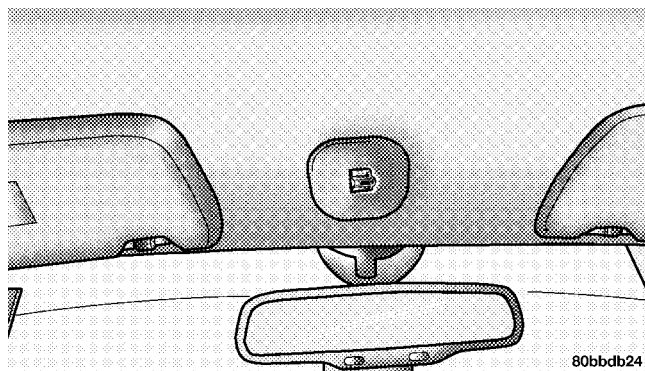

A single control “tilts” the sunroof to the vent position and also slides the sunroof rearward to the full open position. Move the switch rearward to move the sunroof panel to the full vent position. The sunroof can be stopped at any position between closed and full vent open.

Once the sunroof panel is in the full vent position, you may momentarily move the switch rearward (less than

one second) to initiate the express open mode. During this operation, any movement of the switch will stop the sunroof and it will remain in a partial open position.

To close the sunroof, hold the switch in the forward position. Again, any release of the switch will stop the movement and the sunroof will remain in a partial open condition until the switch is pushed forward again.

WARNING!

In an accident, there is a greater risk of being thrown from a vehicle with an open sunroof. You could also be seriously injured or killed. Always fasten your seat belt properly and make sure all passengers are properly secured too.

Do not allow small children to operate the sunroof. Never allow fingers or other body parts, or any object to project through the sunroof opening. Injury may result.

Sunroof Maintenance

Use only a non-abrasive cleaner and a soft cloth to clean the glass panel.

Wind Buffeting

Wind buffeting can be described as the perception of pressure on the ears or a helicopter type sound in the ears. Your vehicle may exhibit wind buffeting with the windows down, or the sunroof (if so equipped) in certain open or partially open positions. This is a normal occurrence and can be minimized. If the buffeting occurs with the rear windows open, open the front and rear windows together to minimize the buffeting. If the buffeting occurs with the sunroof open, adjust the sunroof opening to minimize the buffeting.

CONSOLE FEATURES

The Standard console with armrest has two front cup holders and a front storage tray. There are two additional cupholders; one is molded in the center of the console to hold large cups, and the other is on the underside of the console lid to serve passengers in the rear seat. The underside console lid also has an integral tissue pack holder. The covered storage area has CD and cassette holders.

3

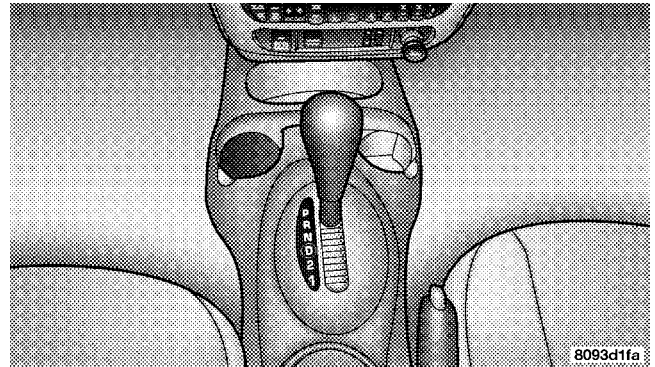

Ash Receiver and Cigar Lighter

When the Smoker's Package is ordered from your authorized dealer, an ash receiver tray and a cigar lighter element are furnished. The lighter element can be inserted in the auxiliary power outlet. The ash receiver fits snugly in a cupholder position. To clean the ash receiver, lift it from the cupholder.



UNDERSTANDING YOUR INSTRUMENT PANEL

CONTENTS

■ Instrument Panel Features74	□ AM Reception84
■ Standard Instrument Cluster75	□ FM Reception84
■ Optional Instrument Cluster76	■ Sales Code RBB—AM/FM Stereo Radio With Cassette Tape Player And CD Changer Capability84
■ Optional Instrument Cluster — R/T Model77	□ Operating Instructions84
■ Instrument Cluster Descriptions78	□ Power Button85
■ Electronic Digital Clock83	□ Electronic Volume Control85
□ Clock Setting Procedure83	□ Seek85
■ Radio General Information83	□ Tune85
□ Radio Broadcast Signals83	□ To Set The Push-Button Memory85
□ Two Types Of Signals83	□ Balance86
□ Electrical Disturbances84		

72 UNDERSTANDING YOUR INSTRUMENT PANEL

□ Fade86	□ Electronic Serial Number/Sirius Identification Number (ENS/SID)95
□ Bass And Treble Tone Control86	□ Selecting Satellite Mode In RBB And RBK Radios96
□ AM/FM Selection86	□ Selecting Satellite Mode In RBP, RBU, RAZ, And RBQ Radios96
□ Mode Button86	□ Selecting a Channel96
□ Cassette Player Features86	□ Storing And Selecting Pre-Set Channels97
□ CD Changer Control Capability — If Equipped87	□ Using The PTY (Program Type) Button (If Equipped)97
□ Radio Display Messages89	□ PTY Button "Scan"97
■ Sales Code RBK—AM/ FM Stereo Radio With CD Player And CD Changer Controls89	□ PTY Button "Seek"97
□ Radio Operation89	□ Satellite Antenna97
□ CD Player Operation91	□ Reception Quality97
□ CD Changer Control Capability — If Equipped93	■ Cassette Tape And Player Maintenance98
□ Radio Display Messages94	■ 6 Disc CD Changer — If Equipped99
■ Satellite Radio — If Equipped95	□ Loading The CD Changer99
□ System Activation95		

□ Playing Discs	99	■ Compact Disc Maintenance	101
□ Seek Button	100	■ Radio Operation And Cellular Phones	102
□ FF/Tune/RW	100	■ Climate Controls	102
□ Mode Button	100	□ Heater Only	102
□ Program Button 1	100	□ Side Window Demisters	103
□ Program Button 4 (Random Play)	100	□ Outside Air Intake	104
□ Program Button 5	100	□ Air Conditioning — If Equipped	104
□ Time Button	100	□ Operating Tips	108
□ Changing Modes	100	■ Electric Rear Window Defroster	110
□ Removing Discs From The CD Changer	101		
□ CD Changer Operation With The Changer Off	101		

INSTRUMENT PANEL FEATURES

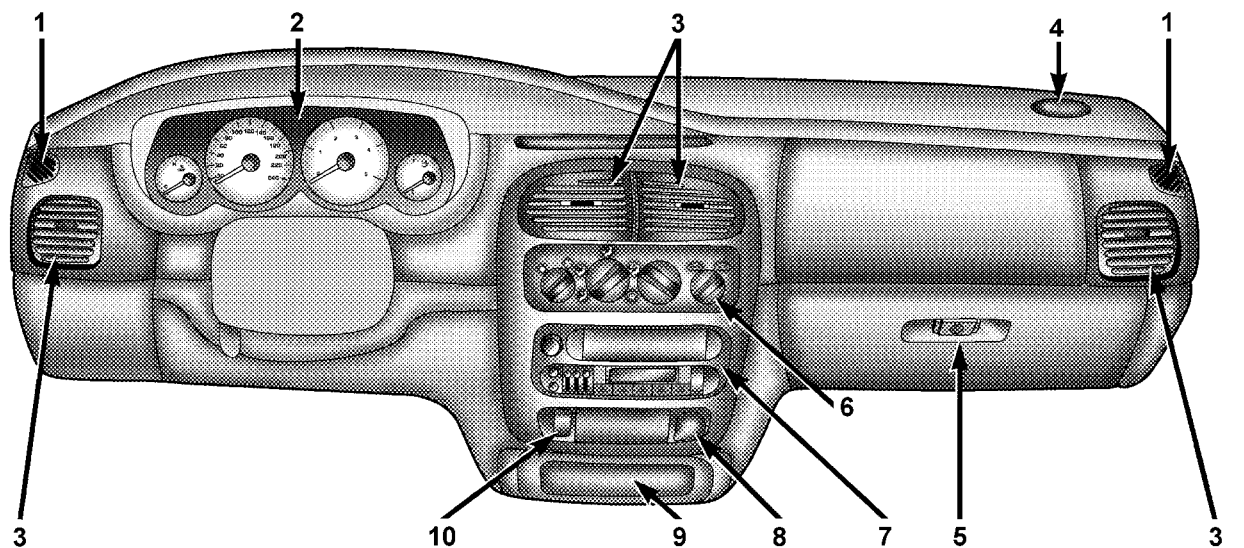

1. Side Window Demist Outlet
2. Instrument Cluster
3. Air Outlet

4. Radio Speaker
5. Glove Compartment

7. Radio
8. Cigar Lighter/
Auxiliary Power Outlet

9. Storage/CD Changer*
10. Rear Window Defrost Switch*

* If Equipped

STANDARD INSTRUMENT CLUSTER

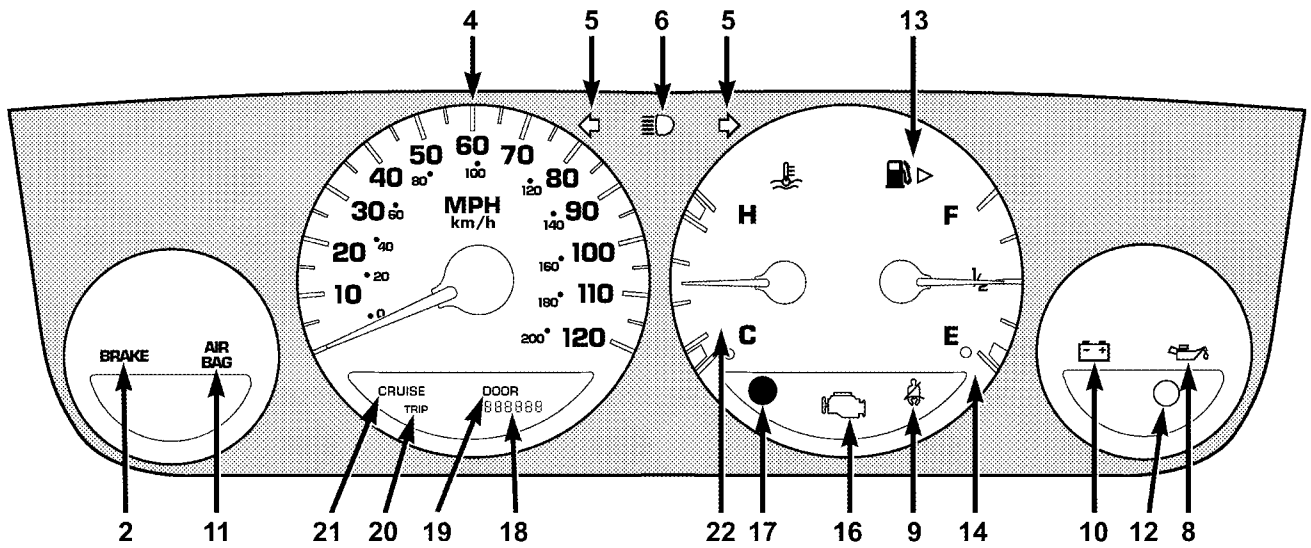

OPTIONAL INSTRUMENT CLUSTER

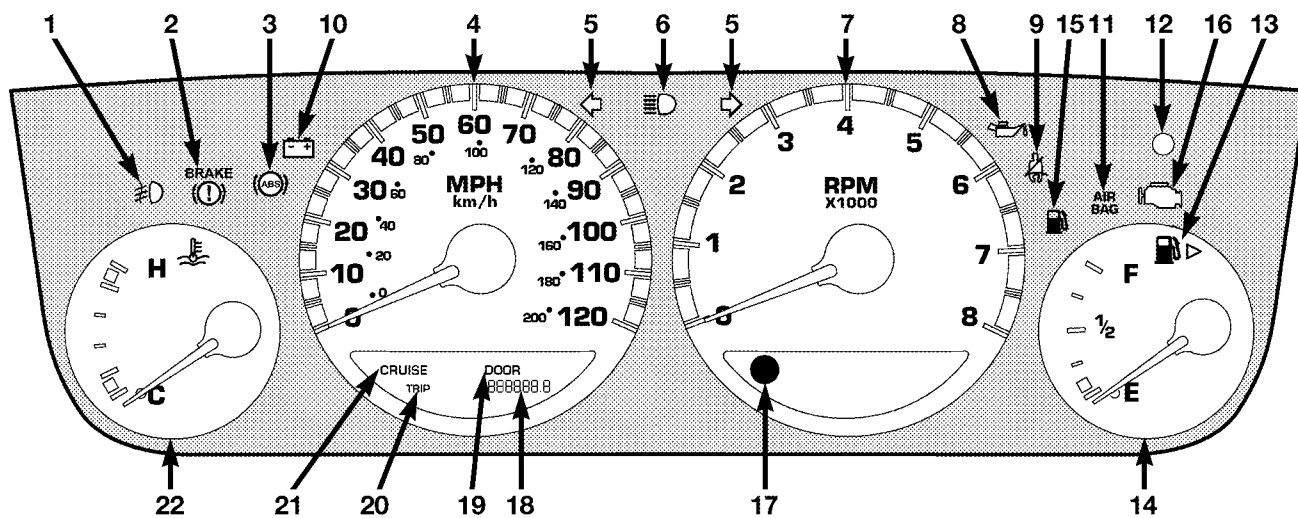

8119d323

OPTIONAL INSTRUMENT CLUSTER — R/T MODEL

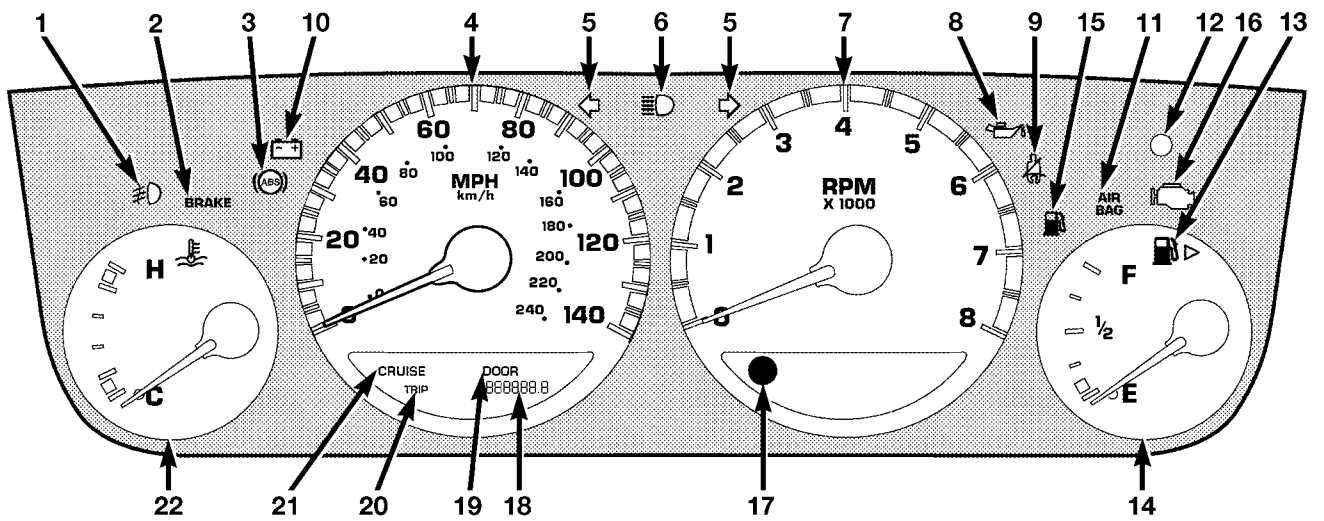

INSTRUMENT CLUSTER DESCRIPTIONS**1. Front Fog Light Indicator — If Equipped**

 This light shows when the front fog lights are ON.

2. Brake System Warning Light

BRAKE  This light monitors various brake functions, including brake fluid level and parking brake application. If the brake light comes on, it may indicate that the parking brake is applied, or there is a low brake fluid level. On vehicles equipped with Anti-lock brakes (ABS), it may also indicate an ABS malfunction that could lead to reduced braking performance.

WARNING!

Driving a vehicle with the brake light on is dangerous. A significant decrease in braking performance or vehicle stability during braking may occur. It will take you longer to stop the vehicle or will make your vehicle harder to control. You could have an accident. Have the vehicle checked immediately.

The operation of the Brake Warning light can be checked by turning the ignition key from the OFF to the ON position. The light should illuminate for three seconds, or until the engine is started, whichever comes first. The light should then go out unless the parking brake is applied or a brake fault is detected. If the light does not illuminate, have the light inspected and serviced as soon as possible.

The light will also come on when the parking brake is applied with the ignition in the ON position.

NOTE: This light shows only that the parking brake is on. It does not show the degree of brake application.

If the parking brake is off and the light remains on, have the brake system inspected as soon as possible.

3. *Anti-Lock Warning Light (ABS) — If Equipped*

 This light monitors the Anti-Lock Brake System (ABS) described elsewhere in this manual. This light will come on when the ignition key is turned to the ON position and may stay on for as long as four seconds.

If the ABS light remains on or comes on during driving, it indicates that the Anti-Lock portion of the brake system is not functioning and that service is required, however, the conventional brake system will continue to operate normally provided that the BRAKE warning light is not on.

If the ABS light is on, the brake system should be serviced as soon as possible to restore the benefit of Anti-Lock Brakes.

The warning light should be checked frequently to assure that it is operating properly. Turn the ignition key to a

point midway between ON and START. The light should come on. If the light does not come on, have the system checked by an authorized dealer.

4. *Speedometer*

Indicates vehicle speed.

5. *Turn Signal Indicators*

 The arrows will flash in unison with the exterior turn signal, when using the turn signal lever.

6. *High Beam Indicator*

 This light shows that the headlights are on high beam. Pull the turn signal lever toward the steering wheel to switch the headlights from high or low beam.

7. *Tachometer — If Equipped*

The white area of the scale shows the permissible engine revolutions-per-minute (rpm x 1000) for each gear range. Before reaching the red area, ease up on the accelerator to prevent engine damage.

8. Oil Pressure Light

 Shows low engine oil pressure. The light will come on and remain on when the ignition key is turned from the OFF to the ON position, and the light will turn off after the engine is started. If the bulb does not come on during starting, have the system checked by an authorized dealer.

If the light comes on and remains on while driving, stop the vehicle and shut off the engine. **DO NOT OPERATE THE VEHICLE UNTIL THE CAUSE IS CORRECTED.**

The light does not show the quantity of oil in the engine. This can be determined using the procedure shown in Section 7.

9. Seat Belt Reminder Light

 When the ignition key is first turned on, this light will come on for about six seconds. A chime will sound if you have not pulled the shoulder belt out of the retractor. This is a reminder to “buckle up”. If you do not buckle up, the light will remain on.

10. Charging System Light

 This light shows the status of the electrical charging system. The light should come on briefly when the ignition is first turned on and remain on briefly as a bulb check. If the light stays on or comes on while driving, it means that there is a problem with the charging system. Obtain **SERVICE IMMEDIATELY.**

11. Airbag Light

 The light comes on and remains on for 6 to 8 seconds as a bulb check when the ignition switch is first turned ON. If the light does not come on during starting, stays on, or comes on while driving, have the system checked by an authorized dealer.

12. Theft Alarm Light — If Equipped

This light will flash rapidly for several seconds when the alarm system is arming. The light will begin to flash slowly indicating that the system is armed.

13. Fuel Door Reminder

This symbol is a reminder that the Fuel Filler Door is located on the passenger's side of the vehicle.

14. Fuel Gauge

When the ignition key is in the ON position, the pointer will show the level of fuel remaining in the fuel tank.

15. Low Fuel Light — If Equipped

NOTE: The Low Fuel Light and Chime feature only functions on vehicles equipped with a tachometer.



When the fuel level drops to about 1/8 tank, the fuel symbol will light and a single chime will sound. The light will remain on until fuel is added. If the fuel level drops to about 1/2 gallon, the fuel symbol will begin to flash and the chime will sound several times.

16. Malfunction Indicator Light

This light is part of an onboard diagnostic system called OBD that monitors emissions, engine, and automatic transmission control systems. The light will illuminate briefly when the key is in the ON/RUN position before engine start. If the bulb does not come on when turning the key from OFF to ON/RUN, have the condition checked promptly.

Certain conditions such as a loose or missing gas cap, poor fuel quality, etc., may illuminate the light after engine start. The vehicle should be serviced if the light stays on through several of your typical driving cycles. In most situations, the vehicle will drive normally and will not require towing.

If the Malfunction Indicator Light flashes when the engine is running, serious conditions may exist that could lead to immediate loss of power or severe catalytic converter damage. The vehicle should be serviced as soon as possible if this occurs.

17. Odometer/Trip Odometer Reset Knob

Press this knob to switch between the odometer and trip odometer. While the trip odometer is being displayed, press and hold this knob for a few seconds to reset the trip odometer to zero miles/kilometers.

18. Odometer/Trip Odometer

Shows the total distance the vehicle has been driven.

U.S. Federal regulations require that upon transfer of vehicle ownership, the seller certify to the purchaser the

correct mileage that the vehicle has been driven. Therefore, if the odometer reading changes during repair or replacement, be sure to keep a record of the reading before and after the service so the correct mileage can be determined.

19. Door Ajar Indicator

This vacuum fluorescent display indicator illuminates when a door is not completely closed. If the door is open for more than 8 minutes and the ignition key is in the OFF position, the indicator will turn off.

20. Trip Indicator

This light will illuminate when the Trip Odometer is in use.

21. Cruise Light — If Equipped

CRUISE This indicator shows that the Speed Control System is ON.

NOTE: The word "SET" will not illuminate when the Speed Control System is on.

22. Temperature Gauge

 The temperature gauge shows engine coolant temperature. Any reading between the light

blue and red areas of the gauge shows that the engine cooling system is operating properly. The gauge pointer may show a higher than normal temperature when driving in hot weather, up mountain grades, in heavy stop and go traffic, or when towing a trailer.

If the pointer rises to the **H** (red) mark, the instrument cluster will sound a chime. Pull off the road at a safe area.

With the vehicle in Park, idle the vehicle with the air conditioner turned off until the pointer drops back into the normal range. If the pointer remains on the **H** (red) mark, turn the ignition off immediately and call for service.

There are steps that you can take to slow down an impending overheat condition. If your air conditioning is on, turn it off. The air conditioning system adds heat to the engine cooling system and turning off the A/C removes this heat. You can also turn the Temperature control to maximum heat, the Mode control to Floor and the Fan control to High. This allows the heater core to act as a supplement to the radiator and aids in removing heat from the engine cooling system.

ELECTRONIC DIGITAL CLOCK

The clock and radio each use the display panel built into the radio. A digital readout shows the time in hours and minutes whenever the ignition switch is in the ON or ACC position.

When the ignition switch is in the OFF position, or when the radio frequency is being displayed, time keeping is accurately maintained.

Clock Setting Procedure

1. Turn the ignition switch to the ON or ACC position. Using the tip of a ballpoint pen or similar object, press either the hour (H) or minute (M) buttons on the radio. The display will show TIME.
2. Press the H button to set hours or the M button to set minutes. The time setting will increase each time you press a button.

RADIO GENERAL INFORMATION

Radio Broadcast Signals

Your new radio will provide excellent reception under most operating conditions. Like any system, however, car radios have performance limitations, due to mobile operation and natural phenomena, which might lead you to believe your sound system is malfunctioning. To help you understand and save you concern about these “apparent” malfunctions, you must understand a point or two about the transmission and reception of radio signals.

Two Types of Signals

There are two basic types of radio signals... AM or Amplitude Modulation, in which the transmitted sound causes the amplitude, or height, of the radio waves to vary... and FM or Frequency Modulation, in which the frequency of the wave is varied to carry the sound.

Electrical Disturbances

Radio waves may pick up electrical disturbances during transmission. They mainly affect the wave amplitude, and thus remain a part of the AM reception. They interfere very little with the frequency variations that carry the FM signal.

AM Reception

AM sound is based on wave amplitude, so AM reception can be disrupted by such things as lightning, power lines and neon signs.

FM Reception

Because FM transmission is based on frequency variations, interference that consists of amplitude variations can be filtered out, leaving the reception relatively clear, which is the major feature of FM radio.

SALES CODE RBB—AM/FM STEREO RADIO WITH CASSETTE TAPE PLAYER AND CD CHANGER CAPABILITY

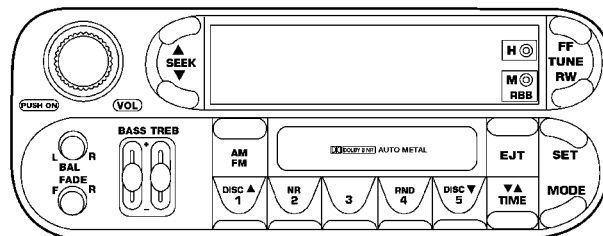

80ef1613

Operating Instructions

NOTE: Power to operate the radio is supplied through the ignition switch. It must be in the ON or ACC position to operate the radio.

NOTE: When first learning the control functions, the user should set the controls as shown in the following list.

Tone Controls...As illustrated.

Speaker Control...Centered.

Power Button

The volume control/power button pops out when pressed, this turns the sound system ON in the mode last used. Pushing the button back in turns the sound system OFF.

Electronic Volume Control

The electronic volume control turns continuously (360 degrees) in either direction without stopping. Turning the volume control to the right increases the volume and to the left decreases it.

When the audio system is turned on, the sound will be set at the same volume level as last played.

For your convenience, the volume can be turned down, but not up, when the audio system is off and the ignition is ON.

Seek

Press and release the SEEK button to search for the next station in either the AM or FM mode. Press the top of the button to seek up and the bottom to seek down. The radio will remain tuned to the new station until you

make another selection. Holding the button will bypass stations without stopping until you release it.

Tune

Press the TUNE control up or down to increase or decrease the frequency. If the button is pushed and held, the radio will continue to tune until the button is released. The frequency will be displayed and continuously updated while the button is pushed.

To Set The Push-Button Memory

When you are receiving a station that you wish to commit to push-button memory, press the SET button. The symbol SET 1 will now show in the display window. Select the "1-5" button you wish to lock onto this station and press and release that button. If a button is not selected within 5 seconds after pressing the SET button, the station will continue to play but will not be locked into push-button memory.

You may add a second station to each push-button by repeating the above procedure with this exception: Press the SET button twice and SET 2 will show in the display window. Each button can be set for SET 1 and SET 2 in both AM and FM. This allows a total of 10 AM and 10 FM

stations to be locked into push-button memory. The stations stored in SET 2 memory can be selected by pressing the push-button twice.

Every time a preset button is used a corresponding button number will be displayed.

Balance

The balance control adjusts the left-to-right speaker balance. Press the BAL button in and it will pop out. Adjust the balance and push the button back in.

Fade

The fade control provides for balance between the front and rear speakers. Press the FADE button in and it will pop out. Adjust the balance and push the button back in.

Bass and Treble Tone Control

The tone controls consist of 2 separate bands. The bass band is on the left, and the treble band is on the right. Each band is adjusted by a slider control with a detent at the mid-position. Moving the control up or down increases or decreases amplification of that band. The mid position provides a balanced output.

AM/FM Selection

Press the AM/FM button to change from AM to FM. The operating mode will be displayed next to the station frequency. The display will show ST when a stereo station is received in the FM mode.

Mode Button

Press the MODE button to select between the cassette tape player, CD changer, or the Satellite Radio (if equipped). When the Satellite Radio (if equipped) is selected "SA" will appear in your radio display.

A CD or tape may remain in the player while in the Satellite or radio mode.

Cassette Player Features

With ignition OFF and the sound system OFF, you can eject the tape cassette by pushing the EJECT button.

You can turn the tape player ON by inserting a cassette or activating the MODE button (with a cassette in the radio), but only when the ignition and radio are on.

Each time a cassette is inserted the tape player will begin playing on the side of the cassette that is facing up in the player.

Music Search

Pressing the SEEK button while playing a tape will start the Music Search mode. Press the SEEK button up for the next selection on the tape and down to return to the beginning of the current selection, or return to the beginning of the previous selection if the tape is within the first 5 seconds of the current selection.

The SEEK symbol appears on the display when Music Search is in operation. Music Search shuts off automatically when a selection has been located.

Selective Music Search

Press the SEEK button up or down to move the track number to skip forward or backward 1 to 7 selections. Press the SEEK button once to move 1 selection, twice to move 2 selections, etc.

Fast Forward And Rewind Buttons

Pressing the TUNE button up or down momentarily activates Fast Forward or Rewind and makes the directional arrows appear on the display.

To stop Fast Forward or Rewind, press the TUNE button again.

Time Button

Press the time button to toggle between station frequency and time of day.

Pressing this button while playing a cassette tape will change the side of the tape being played.

NR (Noise Reduction)

Pushing the Number 2 Pre-set button when a tape is playing deactivates the Dolby Noise Reduction System*. When Dolby is ON, the NR symbol appears on the display. Each time a tape is inserted the Dolby will turn ON.

* "Dolby" noise reduction manufactured under license from Dolby Laboratories Licensing Corporation. Dolby and the double-D symbol are trademarks of Dolby Laboratories Licensing Corporation.

CD Changer Control Capability — If Equipped

This radio is compatible with a remote mounted CD changer available through Mopar Accessories. The following instructions are for the radio controls that operate this CD changer.

Mode Button

To activate the CD changer, press the MODE button until CD information appears on the display.

Push-Button

While the CD changer is playing, press the NUMBER 1 push-button or the NUMBER 5 push-button to select a disc numbered higher or lower than the one currently being played.

Seek Button

Press the SEEK up or down to select another track on the same disc. A SEEK symbol will appear on the display.

Fast Forward And Rewind Buttons

Press and hold the FF button for fast forward. Press and hold the RW button for fast reverse.

The audio output can be heard when fast forward and fast reverse are activated.

Random Play (RND)

Press the Random button to play the tracks on the selected disc in random order for an interesting change of pace.

Random can be cancelled by pressing the button a second time or by ejecting the CD from the changer.

CD Diagnostic Indicators

When driving over a very rough road, the CD player may skip momentarily. Skipping will not damage the disc or the player, and play will resume automatically.

As a safeguard and to protect your CD player, one of the following warning symbols may appear on your display.

A CD HOT symbol indicates the player is too hot.

CD HOT will pause the operation. Play can be resumed when the operating temperature is corrected or another MODE is selected.

An ERR symbol will appear on the display if the laser is unable to read the Disc data for the following reasons:

- Excessive vibration
- Disc inserted upside down
- Damaged disc
- Water condensation on optics

Radio Display Messages

Your radio has been designed to display certain messages when a problem is detected with the CD player.

DISPLAY	EXPLANATION	WHAT TO DO
E-01	Deadlock problem	See your dealer for service
E-02	Disc eject problem	See your dealer for service
E-06	Elevator problem	See your dealer for service
E-07	Magazine eject problem	Check that magazine is OK- if not see your dealer for service
	No discs in magazine. Load discs in magazine.	
	Player overheating. Allow to cool down.	

SALES CODE RBK—AM/ FM STEREO RADIO WITH CD PLAYER AND CD CHANGER CONTROLS

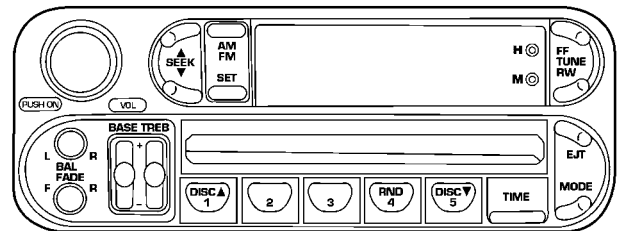

80e571f6

Radio Operation

Power/Volume Control

Press the ON/VOL control to turn the radio on. Turn the volume control clockwise to increase the volume.

NOTE: Power to operate the radio is supplied through the ignition switch. It must be in the ON or ACC position to operate the radio.

Seek

Press and release the SEEK button to search for the next station in either the AM or FM mode. Press the top of the button to seek up and the bottom to seek down. The radio will remain tuned to the new station until you make another selection. Holding the button in will bypass stations without stopping until you release it.

Tune

Press the TUNE control up or down to increase or decrease the frequency. If you press and hold the button, the radio will continue to tune until you release the button. The frequency will be displayed and continuously updated while the button is pressed.

Balance

The Balance control adjusts the left-to-right speaker balance. Press the BAL button in and it will pop out. Adjust the balance and push the button back in.

Fade

The Fade control provides for balance between the front and rear speakers. Press the FADE button in and it will pop out. Adjust the balance and push the button back in.

Bass and Treble Tone Control

The tone controls consist of 2 separate bands. The bass band is on the left, and the treble band is on the right. Each band is adjusted by a slider control with a detent at the mid-position. Moving the control up or down increases or decreases amplification of that band. The mid position provides a balanced output.

AM/FM Selection

Press the AM/FM button to change from AM to FM. The operating mode will be displayed next to the station frequency. The display will show ST when a stereo station is received.

To Set The Radio Push-Button Memory

When you are receiving a station that you wish to commit to push-button memory, press the SET button. SET 1 will show in the display window. Select the "1-5" button you wish to lock onto this station and press and release that button. If a button is not selected within 5 seconds after pressing the SET button, the station will continue to play but will not be locked into push-button memory.

You may add a second station to each push-button by repeating the above procedure with this exception: Press the SET button twice and SET 2 will show in the display window. Each button can be set for SET 1 and SET 2 in both AM and FM. This allows a total of 10 AM and 10 FM stations to be locked into push-button memory. The stations stored in SET 2 memory can be selected by pressing the push-button twice. Every time a preset button is used a corresponding button number will be displayed.

Time

Press the TIME button to change the display between radio frequency and time.

General Information

This radio complies with Part 15 of FCC rules and with RSS-210 of Industry Canada. Operation is subject to the following conditions:

1. This device may not cause harmful interference,
2. This device must accept any interference received, including interference that may cause undesired operation.

NOTE: Changes or modifications not expressly approved by the party responsible for compliance could void the user's authority to operate the equipment.

CD Player Operation

NOTE: The ignition switch must be in the ON or ACC position and the volume control ON before the CD player will operate.

Inserting The Compact Disc

CAUTION!

This CD player will accept 4 ¾ inch (12 cm) discs only. The use of other sized discs may damage the CD player mechanism.

You may either insert or eject a disc with the radio OFF.

If you insert a disc with the ignition ON and the radio OFF, the display will show the time of day.

If the power is ON, the unit will switch from radio to CD mode and begin to play when you insert the disc. The

display will show the track number and index time in minutes and seconds. Play will begin at the start of track one.

Seek

Press the top of the SEEK button for the next selection on the CD. Press the bottom of the button to return to the beginning of the current selection, or return to the beginning of the previous selection if the CD is within the first second of the current selection.

EJT — Eject

Press the EJT button and the disc will unload and move to the entrance for easy removal. The unit will switch to the radio mode.

If you do not remove the disc within 15 seconds, it will be reloaded. The unit will continue in radio mode.

The disc can be ejected with the radio and ignition OFF.

FF/TUNE/RW

Press FF (Fast Forward) and the CD player will begin to fast forward until FF is released. The RW (Reverse) button works in a similar manner.

Random Play — RND/Program Button 4

Press the RND (button 4) button while the CD is playing to activate Random Play. This feature plays the tracks on the selected disc in random order to provide an interesting change of pace.

Press the SEEK button to move to the next randomly selected track.

Press the RND (button 4) button a second time to stop Random Play.

Mode

Press the MODE button repeatedly to select between the CD player, the optional remote CD changer and the Satellite Radio (if equipped). When Satellite Radio (if equipped) is selected "SA" will appear in your radio display.

A CD or tape may remain in the player while in the Satellite mode.

Time

Press the TIME button to change the display from elapsed CD playing time to time of day.

CD Changer Control Capability — If Equipped

This radio is compatible with a remote mounted CD changer available through Mopar Accessories. The following instructions are for the radio controls that operate this CD changer.

Mode Button

To activate the CD changer, press the MODE button until CD information appears on the display.

Push-Button

While the CD changer is playing, press the NUMBER 1 push-button or the NUMBER 5 push-button to select a disc numbered higher or lower than the one currently being played.

Seek Button

Press the SEEK up or down to select another track on the same disc. A SEEK symbol will appear on the display.

Fast Forward And Rewind Buttons

Press and hold the FF button for fast forward. Press and hold the RW button for fast reverse.

The audio output can be heard when fast forward and fast reverse are activated.

Random Play (RND)

Press the Random button to play the tracks on the selected disc in random order for an interesting change of pace.

Random can be cancelled by pressing the button a second time or by ejecting the CD from the changer.

CD Diagnostic Indicators

When driving over a very rough road, the CD player may skip momentarily. Skipping will not damage the disc or the player, and play will resume automatically.

As a safeguard and to protect your CD player, one of the following warning symbols may appear on your display.

A CD HOT symbol indicates the player is too hot.

CD HOT will pause the operation. Play can be resumed when the operating temperature is corrected or another MODE is selected.



94 UNDERSTANDING YOUR INSTRUMENT PANEL

An ERR symbol will appear on the display if the laser is unable to read the Disc data for the following reasons:

- Excessive vibration
- Disc inserted upside down
- Damaged disc
- Water condensation on optics

Radio Display Messages

Your radio has been designed to display certain messages when a problem is detected with the CD player.

DISPLAY	EXPLANATION	WHAT TO DO
E-01	Deadlock problem	See your dealer for service
E-02	Disc eject problem	See your dealer for service
E-06	Elevator problem	See your dealer for service
E-07	Magazine eject problem	Check that magazine is OK- if not see your dealer for service
	No discs in magazine.	Load discs in magazine.
	Player overheating.	Allow to cool down.

805e2ab6

SATELLITE RADIO — IF EQUIPPED

Satellite radio uses direct satellite to receiver broadcasting technology to provide clear digital sound, coast to coast. The subscription service provider is Sirius™ Satellite Radio. This service offers up to 100 channels of music, sports, news, entertainment, and programming for children, directly from its satellites and broadcasting studios.

System Activation

To activate your Sirius Satellite Radio service, call the toll-free number 888-539-7474, or visit the Sirius web site at www.sirius.com. Please have the following information available when activating your system:

1. The Electronic Serial Number/Sirius Identification Number (ESN/SID).
2. Credit card information.
3. Your Vehicle Identification Number.

Electronic Serial Number/Sirius Identification Number (ENS/SID)

The Electronic Serial Number/Sirius Identification Number is needed to activate your Sirius Satellite Radio system. To access the ESN/SID, refer to the following steps:

ESN/SID Access With RBB and RBK Radios

With the ignition switch in the ACCESSORY position and the radio OFF, press the Tape Eject or CD Eject (depending on the radio type) and Time buttons simultaneously for 3 seconds. The first four digits of the twelve-digit ESN/SID number will be displayed. Press the SEEK UP button to display the next four digits. Continue to press the SEEK UP button until all twelve ESN/SID digits have been displayed. The SEEK DOWN will page down until the first four digits are displayed. The radio will exit the ESN/SID mode when any other button is pushed, the ignition is turned OFF, or 5 minutes has passed since any button was pushed.

ESN/SID Access With RBP, RBU, RAZ, and RBQ Radios

With the ignition switch in the ACCESSORY position and the radio OFF, press the CD Eject and TIME buttons simultaneously for 3 seconds. All twelve ESN/SID numbers will be displayed. The radio will exit the ESN/SID mode when any other button is pushed, the ignition is turned OFF, or 5 minutes has passed since any button was pushed.

Selecting Satellite Mode in RBB and RBK Radios

Press the MODE button repeatedly until "S A" appears in the display. A CD or tape may remain in the radio while in the Satellite radio mode.

Selecting Satellite Mode in RBP, RBU, RAZ, and RBQ Radios

Press the MODE button repeatedly until the word "SIRIUS" appears in the display. These radios will also display the following:

- After 3 seconds, the current channel name and channel number will be displayed for 5 seconds.

- The current program type and channel number will then be displayed for 5 seconds.
- The current channel number will then be displayed until an action occurs.

A CD or tape may remain in the radio while in the Satellite radio mode.

Selecting a Channel

Press and release the SEEK or TUNE buttons to search for the next channel. Press the top of the button to search up and the bottom of the button to search down. Holding the TUNE button causes the radio to bypass channels until the button is released.

Press and release the SCAN button (if equipped) to automatically change channels every 7 seconds. The radio will pause on each channel for 7 seconds before moving on to the next channel. The word "SCAN" will appear in the display between each channel change. Press the SCAN button a second time to stop the search.

NOTE: Channels that may contain objectionable content can be blocked. Contact Sirius Customer Care at

888-539-7474 to discuss options for channel blocking or unblocking. Please have your ESN/SID information available.

Storing and Selecting Pre-Set Channels

In addition to the 10 AM and 10 FM pre-set stations, you may also commit 10 satellite stations to push button memory. These satellite channel pre-set stations will not erase any AM or FM pre-set memory stations. Follow the memory pre-set procedures that apply to your radio.

Using the PTY (Program Type) Button (if equipped)

Follow the PTY button instructions that apply to your radio.

PTY Button "SCAN"

When the desired program type is obtained, press the "SCAN" button within five seconds. The radio will play 7 seconds of the selected channel before moving to the next channel of the selected program type. Press the "SCAN" button a second time to stop the search.

NOTE: Pressing the "SEEK" or "SCAN" button while performing a music type scan will change the channel by

one and stop the search. Pressing a pre-set memory button during a music type scan, will call up the memory channel and stop the search.

PTY Button "SEEK"

When the desired program is obtained, press the "SEEK" button within five seconds. The channel will change to the next channel that matches the program type selected.

Satellite Antenna

To ensure optimum reception, do not place items on the roof around the rooftop antenna location. Metal objects placed within the line of sight of the antenna will cause decreased performance. Larger luggage items should be placed as far forward as possible. Do not place items directly on or above the antenna.

Reception Quality

Satellite reception may be interrupted due to one of the following reasons.

- The vehicle is parked in an underground parking structure or under a physical obstacle.
- Dense tree coverage may interrupt reception in the form of short audio mutes.

- Driving under wide bridges or along tall buildings can cause intermittent reception.
- Placing objects over or too close to the antenna can cause signal blockage.

CASSETTE TAPE AND PLAYER MAINTENANCE

To keep the cassette tapes and player in good condition, take the following precautions:

1. Do not use cassette tapes longer than C-90; otherwise, sound quality and tape durability will be greatly diminished.
2. Keep the cassette tape in its case to protect from slackness and dust when it is not in use.
3. Keep the cassette tape away from direct sunlight, heat and magnetic fields such as the radio speakers.
4. Before inserting a tape, make sure that the label is adhering flatly to the cassette.
5. A loose tape should be corrected before use. To rewind a loose tape, insert the eraser end of a pencil into the tape drive gear and twist the pencil in the required directions.

Maintain your cassette tape player. The head and capstan shaft in the cassette player can pick up dirt or tape deposits each time a cassette is played. The result of deposits on the capstan shaft may cause the tape to wrap around and become lodged in the tape transport. The other adverse condition is low or "muddy" sound from one or both channels, as if the treble tone control were turned all the way down. To prevent this, you should periodically clean the head with a commercially available WET cleaning cassette.

As preventive maintenance, clean the head about every 30 hours of use. If you wait until the head becomes very dirty (noticeably poor sound), it may not be possible to remove all deposits with a simple WET cleaning cassette.

6 DISC CD CHANGER — IF EQUIPPED

The CD changer is located below the radio in the instrument panel. The changer plays only 4 ¾ inch (12 cm) discs. The changer holds up to 6 discs. Each disc is loaded and ejected through a single slot in front of the changer. Each disc has a numbered button with an amber light above it which, when illuminated, indicates that a disc is loaded in that particular chamber.

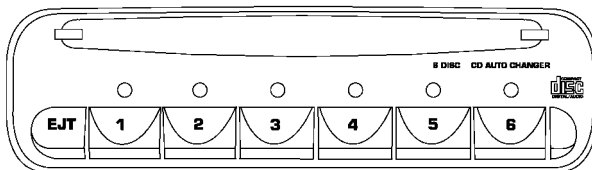

80ef1625

Loading the CD Changer

When inserting the first CD into the changer if the radio is on, wait until the single slot is illuminated on both sides and simply insert the first disc.

To insert additional CDs into the changer, the instructions follow:

1. Select and press any numbered button without an illuminated light above it.
2. Insert the CD while the light above the chosen button is flashing and the two lights on either side of the slot are illuminated.
3. Upon insertion, the CD will begin to play, and both the button light and the lights in the corner of the loading slot will illuminate.
4. Repeat the process for loading any additional CDs. The CD player will stop while additional CDs are loaded.

Playing Discs

The radio will show the CD number, the CD track number, and the Track Time Elapsed while the radio is in the CD mode. If more than one CD is loaded in the changer, the changer will automatically play the next disc after playing the last track of the current disc.

Seek Button

Press the top of this button on the radio once to play the next track. Press the bottom of the button once to return to the beginning of the current track. Press the bottom of the button twice to play the previous track.

FF/TUNE/RW

Press the FF (fast forward) button and the CD player will fast forward through the tracks until the button is released. Press the RW (rewind) button and the CD player will reverse through the tracks until the button is released.

Mode Button

Press this button to toggle between radio and cd modes.

Program Button 1

Press this button to play the next available disc.

Program Button 4 (Random Play)

Press this button while the CD is playing to activate Random Play. This feature plays the selections on the current compact disc in random order to provide an interesting change of pace. The CD changer stays in the random play mode when changing to the next disc.

NOTE: The changer will not random play between discs.

Press the top of the Seek button once to move to the next randomly selected track. Press the bottom of the Seek button to go back to the beginning of the track.

Press button 4 a second time to stop random play.

Program Button 5

Press this button to play the previous disc.

Time Button

Press this button to switch between time of day and CD track time.

Changing Modes

While in the radio mode, if a cassette is loaded, press the Mode button to switch to the tape mode. If a CD is loaded, press the Mode button to select the CD mode. If neither a tape nor CD is loaded, the radio will ignore the command.

- Inserting either a tape or CD automatically starts that mode of play.

- Pressing the AM/FM button while in the tape or CD mode will select the radio mode.
- If in the CD mode and the last CD is ejected, the radio will tune to the last station selected.

Removing Discs from the CD Changer

If there is a single CD in the changer, press the EJT button and the CD will eject. If the CD is not removed within 15 seconds, it will automatically reload into the CD changer. To eject additional CDs from the changer, first select the numbered button where the CD is located and then press the EJT button.

CD Changer Operation with the Changer Off

The CD changer is able to load and eject discs with the ignition power off. However, while the ignition is off, one of the six numbered buttons must be pressed first.

COMPACT DISC MAINTENANCE

To keep the compact discs in good condition, take the following precautions:

1. Handle the disc by its edge; avoid touching the surface.
2. If the disc is stained, clean the surface with a soft cloth, wiping from center to edge.
3. Do not apply paper or tape to the disc; avoid scratching the disc.
4. Do not use solvents such as benzine, thinner, cleaners, or antistatic sprays.
5. Store the disc in its case after playing.
6. Do not expose the disc to direct sunlight.
7. Do not store the disc where temperatures may become too high.

NOTE: If you experience difficulty in playing a particular disc, it may be damaged, oversized, or have theft protection encoding. Try a known good disc before considering disc player service.

RADIO OPERATION AND CELLULAR PHONES

Under certain conditions, the operation of a cellular phone in your vehicle can cause erratic or noisy performance from your radio. This condition may be lessened or eliminated by relocating the cellular phone antenna. This condition is not harmful to the radio. If your radio performance does not satisfactorily "clear" by the repositioning of the antenna, it is recommended that the radio volume be turned down or off during cellular phone operation.

CLIMATE CONTROLS

Heater Only

The controls are as follows:

Fan Control

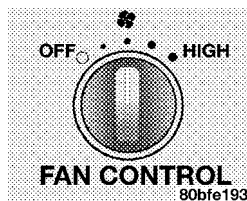

Use this control to regulate the amount of air forced through the system in any mode you select. Turn the control clockwise to increase fan speed. Turn the control to the full counterclockwise position to turn the fan off.

NOTE: There is always a small amount of air entering the vehicle even when the fan is turned off. If this becomes objectionable during cold weather, place the mode control on FLOOR to direct the air flow away from passengers.

Mode Control (Air Direction)

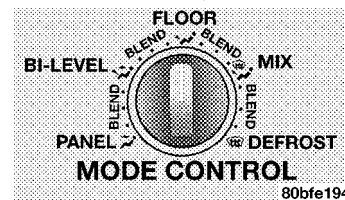

The mode control allows you to choose from several patterns of air distribution. You can select either a primary mode, as identified by the symbols, or a blend of two of these modes. The center point between modes gives an even blend of both modes. The closer the control is to a particular mode, the more air distribution you receive from that mode.

Panel

 Air is directed through the adjustable outlets in the instrument panel.

Bi-Level

 Air is directed through the panel and floor outlets.

NOTE: There is a difference in temperature between the upper and lower outlets for added comfort. The warmer air goes to the floor outlets. This feature gives improved comfort during sunny but cool conditions.

Floor

 Air is directed through the floor and side window demister outlets with a small amount through the defrost outlet.

Mix

 Air is directed through the floor, defrost, and side window demister outlets. This setting works best in cold or snowy conditions that require extra heat at the windshield. This setting is good for maintaining comfort while reducing moisture on the windshield.

Defrost

 Air is directed through the windshield and side window demister outlets. Use this setting with maximum fan and heat settings for the best windshield and side window clearing.

Temperature Control

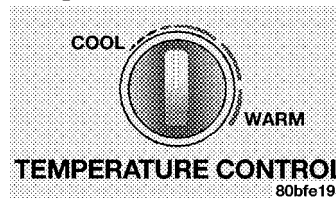

Use this control to regulate the temperature of the air inside the passenger compartment. Turn the control clockwise to increase the temperature of the air entering the vehicle.

Side Window Demisters

A side window demister outlet is at each end of the instrument panel. These nonadjustable outlets direct air toward the side windows when the system is in either the FLOOR, MIX, or DEFROST mode. The air is directed at the area of the windows through which you view the outside mirrors.

Outside Air Intake

When operating the system during the winter months, make sure the air intake, directly in front of the windshield, is free of ice, slush, snow or other obstructions such as leaves. Leaves collected in the air-intake plenum may reduce air flow and plug the plenum water drains.

The blower air will heat faster in cold weather if you use only a low blower speed for the first few minutes of vehicle operation.

During engine warm-up in cold weather, use the Defrost mode to direct any cold air away from the occupants.

Air Conditioning — If Equipped

The Air Conditioning System allows you to balance the temperature, amount, and direction of air circulating throughout the vehicle.

The air conditioning system of your vehicle contains R-134a, a refrigerant that does not deplete the ozone layer in the upper atmosphere.

CAUTION!

If your vehicle was not built with air conditioning, The manufacturer does not recommend that you install any non-factory A/C system. The design of add-on air conditioning kits may be inadequate. This may cause damage to your engine or other components which will not be covered by your warranty.

The controls are as follows:

Fan and Air Conditioning Control

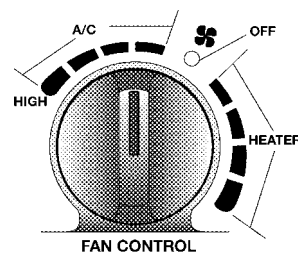

80bbdb6e

Use this control to regulate the amount of air forced through the system in any mode you select. The fan speeds to the left of the OFF position are for Air Conditioning. Choosing one of these speeds turns on the air conditioning compressor. The

fan speed increases as you move the control counter-clockwise from the OFF position.

NOTE: The air conditioning compressor will not engage until the engine has been running for about 10 seconds.

Fan speeds to the right of OFF are for heater or ventilation operation. The fan speed increases as you move the control clockwise from the OFF position.

Mode Control (Air Direction)

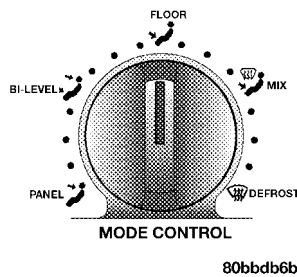

The mode control allows you to choose from several patterns of air distribution. You can select either a primary mode, as identified by the symbols, or a blend of two of these modes. The center point between modes gives an even blend of both modes. The closer the control is to a particular mode, the more air distribution you receive from that mode.

Panel

 Air is directed through the outlets in the instrument panel. These outlets can be adjusted to direct air flow.

Bi-Level

 Air is directed through the panel and floor outlets.

NOTE: There is a difference in temperature between the upper and lower outlets for added comfort. The warmer air goes to the floor outlets. This feature gives improved comfort during sunny but cool conditions.

NOTE: If you choose either the Mix or Defrost modes while the Circulation control is in the Recirculation Mode, the system will automatically switch to the Outside Air mode and the knob will move to that position.

Floor

 Air is directed through the floor outlets and side window demist outlets with a small amount through the defrost outlet.

Mix

 Air is directed through the floor, defrost and side window demist outlets. This setting works best in cold or snowy conditions that require extra heat at the windshield. This setting is good for maintaining comfort while reducing moisture on the windshield.

Defrost

 Air is directed through the windshield and side window demist outlets. Use this mode with maximum fan and temperature settings for best windshield and side window defrosting.

NOTE: The air conditioning compressor operates in both Mix and Defrost or a blend of these modes even if the fan switch is not in the A/C position. This dehumidifies the air to help dry the windshield. To improve fuel economy, use these modes only when necessary.

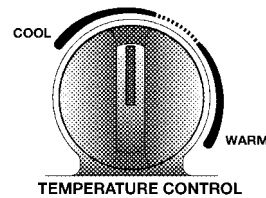
Temperature Control

80bbdb6c

Use this control to regulate the temperature of the air inside the passenger compartment. The blue area of the scale indicates cooler temperatures while the red area indicates warmer temperatures.

NOTE: If your air conditioning performance seems lower than expected, check the front of the A/C condenser located in front of the radiator, for an accumulation of dirt or insects. Clean with a gentle water spray from behind the radiator and through the condenser. Fabric front fascia protectors may reduce air flow to the condenser, reducing air conditioning performance.

Circulation Control

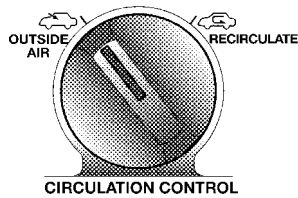

80bbdb6d

Use this control to choose between outside air intake or recirculation of the air inside the vehicle. Only use the recirculate mode to temporarily block out any outside odors, smoke, or dust and to cool the interior rapidly upon initial start up in very hot or humid weather.

This control only operates in the Outside Air and Recirculate modes; there is no in between position. Do not place the control between these positions.



















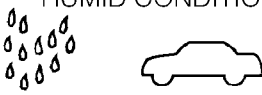

NOTE: Continuous use of the recirculate mode may make the inside air stuffy and window fogging may occur. Extended use of this mode is not recommended.

In cold weather, the use of the Recirculate position will cause windows to fog on the inside because of moisture build up inside the vehicle. For maximum defogging, select the Outside Air position.

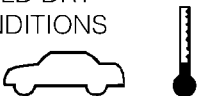
If the mode control is in the range between Mix and Defrost and you choose the Recirculate mode, the mode control knob will automatically move to the Mix position.

NOTE: If you choose either the Mix or Defrost modes and the Circulation control is in the Recirculate Mode, the system will automatically switch to the Outside Air position.

Operating Tips

WEATHER	CONTROL SETTINGS
<p>HOT WEATHER AND VEHICLE INTERIOR IS VERY HOT</p> 	<p>Open the windows, start the vehicle, and place the Circulation control at . Set the Fan control to the high A/C position (full counterclockwise) position. Set the Mode control at or between  and . Set the temperature control to full cool. After the hot air is flushed from the vehicle, turn the Circulation control to  and roll up the windows. Once you are comfortable, place the Circulation control at  and adjust the temperature control for comfort.</p>
<p>WARM WEATHER</p> 	<p>Set the Circulation control to . If it's sunny, set the Mode control at or near  and turn the air conditioning on. If it's cloudy or dark, set the Mode control at or near .</p>
<p>COOL OR COLD HUMID CONDITIONS</p> 	<p>Set the Circulation control to . If it's sunny, set the Mode control at or between  and  then turn the air conditioning on. If it's cloudy or dark, set the Mode control at or near  and turn the air conditioning on.</p>
<p>COLD DRY CONDITIONS</p> 	<p>Set the Circulation control to . Set the Mode control at or near . If it is sunny, you may want more upper air. In this case, set the Mode control at or between  and . In very cold weather, if you need extra heat at the windshield, set the Mode control at or near the .</p>

0050419e

Window Fogging

Vehicle side windows tend to fog on the inside in mild rainy or humid weather. To clear the windows, use the A/C, PANEL and blower controls. Direct the panel outlets toward the side windows. Do not use recirculate without A/C for long periods as fogging may occur.

Interior fogging on the windshield can be quickly removed by using the defrost position.

If the fogging problem persists, clean the inside window surfaces. The cause of undue fogging may be dirt collecting on the inside surface of the glass

NOTE: In cold weather, the use of the recirculate position will cause windows to fog on the inside because of moisture build up inside the vehicle. For maximum defogging, use the Outside Air position.

Summer Operation

Air conditioned vehicles must be protected with a high-quality antifreeze coolant to provide proper corrosion protection and to raise the boiling point of the coolant for protection against overheating. A 50% concentration is recommended.

Outside Air Intake

When operating the system during the winter months, make sure the air intake, directly in front of the windshield, is free of ice, slush, snow or other obstructions such as leaves. Leaves collected in the air-intake plenum may reduce air flow and plug the plenum water drains.

The blower air will heat faster in cold weather if you use only a low blower speed for the first few minutes of vehicle operation.

Side Window Demisters

A side window demister outlet is at each end of the instrument panel. These nonadjustable outlets direct air toward the side windows when the system is in either the FLOOR, MIX, or DEFROST mode. The air is directed at the area of the windows through which you view the outside mirrors.

ELECTRIC REAR WINDOW DEFROSTER

 A push-button at the center of the instrument panel, below the radio, turns the defroster and the heated mirrors (if equipped) ON or OFF. An amber light shows that the defroster is on.

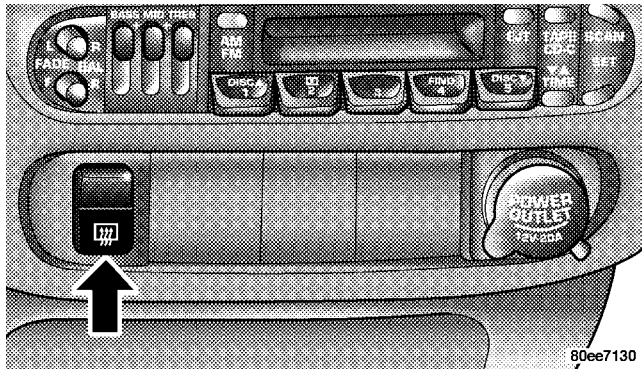

NOTE: The defroster turns off automatically after 10 minutes of operation. Each following activation of the defroster will last for five minutes.

CAUTION!

To avoid damaging the electrical conductors, do not use scrapers, sharp instruments, or abrasive window cleaners on the interior surface of the rear window. Labels can be peeled off after soaking with warm water.

STARTING AND OPERATING

CONTENTS

■ Starting Procedures	114	□ Automatic Transaxle Ignition Interlock System	116
□ Automatic Transaxle	114	□ Four Speed Automatic Transaxle	117
□ Manual Transaxle	114	□ Reset Mode	117
□ Normal Starting	114	□ Gear Ranges For Four Speed Automatic Transaxle	117
□ Starting In Cold Weather (Below 32°F Or 0°C)	115	■ Manual Transaxle — If Equipped	119
□ Extremely Cold Weather (Below -20°F Or -29°C)	115	□ Recommended Shift Speeds	120
□ If Engine Fails To Start	115	□ Downshifting	121
□ After Starting	116	■ Parking Brake	121
■ Automatic Transaxle — If Equipped	116	■ Brake System	123
□ Brake/Transmission Interlock System	116		

112 STARTING AND OPERATING

□ Anti-Lock Brake System (ABS) — If Equipped	124	■ Tire Chains	139
■ Power Steering	125	■ Snow Tires	140
■ Tire Safety Information	125	■ Tire Rotation Recommendations	141
□ Tire Markings	125	■ Fuel Requirements	141
□ Tire Identification Number (TIN)	128	□ 2.0L Standard Engine	141
□ Tire Loading And Tire Pressure	129	□ 2.0L High Output Engine	142
■ Tires—General Information	133	□ Spark Knock	142
□ Tire Pressure	133	□ Reformulated Gasoline	142
□ Tire Inflation Pressures	134	□ Gasoline/Oxygenate Blends	142
□ Radial-Ply Tires	136	□ MMT In Gasoline	143
□ Compact Spare Tire — If Equipped	136	□ Sulfur In Gasoline	143
□ Tire Spinning	137	□ Materials Added To Fuel	144
□ Tread Wear Indicators	137	□ Fuel System Cautions	144
□ Replacement Tires	138	□ Carbon Monoxide Warnings	145
□ Alignment And Balance	139	■ Adding Fuel	145
		□ Fuel Tank Filler Cap	145

■ Vehicle Loading	147	□ Warranty Requirements	148
■ Trailer Towing	148		

STARTING PROCEDURES

Before starting your vehicle, adjust your seat, adjust both inside and outside mirrors, and fasten your seat belts.

CAUTION!

Long periods of engine idling, especially at high engine speeds can cause excessive exhaust temperatures which can damage your vehicle. Do not leave your vehicle unattended with the engine running.

WARNING!

Do not leave children or animals inside parked vehicles in hot weather. Interior heat build up may cause serious injury or death.

Automatic Transaxle

The gear selector must be in the NEUTRAL or PARK position before you can start the engine.

NOTE: You must press the brake pedal before shifting out of Park.

Manual Transaxle

Place the gear selector in NEUTRAL, press the clutch pedal to the floor, and fully apply the parking brake before starting the engine.

NOTE: The engine will not start unless the clutch pedal is pressed to the floor.

Normal Starting

Normal Starting of either a cold or a warm engine does not require pumping or depressing the accelerator pedal. Simply turn the key to the START position and release when the engine starts. If the engine has not started within 5 seconds, slightly depress the accelerator pedal while continuing to crank. If the engine fails to start within 15 seconds, turn the key to the OFF position, wait 10 to 15 seconds, then repeat the normal starting procedure.

Starting in Cold Weather (Below 32°F or 0°C)

Slightly depress and hold the accelerator before starting the engine. Turn the key to the START position. When the engine starts, release the key, then the accelerator pedal. If the engine fails to start within 15 seconds, turn the key OFF wait 10 to 15 seconds, then repeat the normal starting procedure.

WARNING!

Do not attempt to push or tow your vehicle to get it started. Vehicles equipped with an automatic trans-axle cannot be started this way. Unburned fuel could enter the catalytic converter and once the engine has started, ignite and damage the converter and vehicle. If the vehicle has a discharged battery, booster cables may be used to obtain a start from another vehicle. This type of start can be dangerous if done improperly, so follow the procedure carefully. See section 6 of this manual for jump starting instructions.

Extremely Cold Weather (below -20°F or -29°C)

To insure reliable starting at these temperatures, use of an externally powered electric engine block heater (available from your dealer) is recommended.

If Engine Fails to Start

If the engine fails to start after you have followed the "NORMAL STARTING" procedure, it may be flooded. Push the accelerator pedal all the way to the floor and hold it there. Crank the engine for no more than 15 seconds. This should clear any excess fuel in case the engine is flooded. Leave the ignition key in the ON position, release the accelerator pedal and repeat the "NORMAL STARTING" procedure.

WARNING!

Never pour fuel or other flammable liquid into the throttle body air inlet opening in an attempt to start the vehicle. This could result in flash fire causing serious personal injury.

CAUTION!

To prevent damage to the starter, do not crank the engine for more than 15 seconds at a time. Wait 10 to 15 seconds before trying again.

After Starting

The idle speed will automatically decrease as the engine warms up.

AUTOMATIC TRANSAXLE — IF EQUIPPED**CAUTION!**

Damage to the transaxle may occur if the following precautions are not observed:

- Shift into PARK only after the vehicle has come to a complete stop.

- Shift into or out of REVERSE only after the vehicle has come to a complete stop and the engine is at idle speed.
- Do not shift from REVERSE, PARK, or NEUTRAL into any forward gear when the engine is above idle speed.
- Before shifting into any gear, make sure your foot is firmly on the brake pedal.

NOTE: You MUST press and hold the brake pedal down while shifting out of Park.

Brake/Transmission Interlock System

This system prevents you from moving the gear shift out of Park and into any gear unless the brake pedal is pressed. This system is active only while the ignition switch is in the ON positions. Always depress the **brake pedal first**, before moving the gear selector out of PARK.

Automatic Transaxle Ignition Interlock System

This system prevents the key from being removed unless the shift lever is in PARK and the shift knob push button is out. It also prevents shifting out of PARK unless the key is in the ON or RUN positions.

NOTE: If a malfunction occurs, the system will trap the key in the ignition cylinder to warn you that this safety feature is inoperable. The engine can be started and stopped but the key cannot be removed until you obtain service.

Four Speed Automatic Transaxle

The electronically controlled transaxle provides a precise shift schedule. The transaxle electronics are self calibrating; therefore, the first few shifts on a new vehicle may be somewhat abrupt. This is a normal condition, and precision shifts will develop within a few shift cycles.

Reset Mode

The transaxle is monitored electronically for abnormal conditions. If a condition is detected that could cause damage, the transaxle shifts automatically into second gear. The transaxle remains in second gear despite the forward gear selected. Park (P), Reverse (R), and Neutral (N) will continue to operate. This second gear limp-in feature allows the vehicle to be driven to a dealer for service without damaging the transaxle.

In the event that the problem has been momentary, the transaxle can be reset to regain all forward gears.

Stop the vehicle and shift into Park (P).

Turn the Key to OFF then restart the engine.

Shift into D and resume driving.

NOTE: Even if the transaxle can be reset, it is recommended that you visit a dealer at your earliest possible convenience. Your dealer has diagnostic equipment to determine if the problem could recur.

If the transaxle cannot be reset, dealer service is required.

Gear Ranges For Four Speed Automatic Transaxle

DO NOT race the engine when shifting from PARK or NEUTRAL positions into another gear range.

“P” Park

Supplements the parking brake by locking the transmission. The engine can be started in this range. Never use P (Park) while the vehicle is in motion. Apply the parking brake when leaving the vehicle in this range. Always apply the parking brake first, and then place the selector in P (Park) position.

WARNING!

Unintended movement of a vehicle could injure those in and near the vehicle. As with all vehicles, you should never exit a vehicle while the engine is running. Before exiting a vehicle, you should always shift the vehicle into P (Park), remove the key from the ignition, and apply the parking brake. Once the key is removed from the ignition, the transmission shift lever is locked in the P (Park) position, securing the vehicle against unwanted movement. Furthermore, you should never leave children unattended inside a vehicle.

The following indicators should be used to ensure that you have engaged the transmission shift lever into the P (Park) position:

- When shifting into P (Park), depress the button on the shift lever and firmly move the lever all the way forward until it stops.
- Look at the shift indicator window on the console to ensure it is in the P (Park) position.

- When engaged in P (Park), you will not be able to move the shifter rearward without depressing the shift lever button.

CAUTION!

Before moving the shift lever out of P (Park), you must turn the ignition from LOCK to ON so the steering wheel and shift lever are released. Otherwise, damage to the steering column or shifter could result.

“R” Reverse

Shift into this range only after the vehicle has come to a complete stop.

“N” Neutral

Engine may be started in this range.

“D” Overdrive

This range should be used for most city and highway driving. It provides smoothest up shifts and down shifts and best fuel economy.

When frequent transaxle shifting occurs while using the Overdrive range, such as when operating the vehicle under heavy loading conditions (in hilly terrain, traveling into strong head winds, or while towing trailers), use the “3” range.

“3” Drive

This range eliminates shifts into Overdrive. The transaxle will operate normally in first and second while in this range.

NOTE: Using the “3” range while operating the vehicle under heavy operating conditions will improve performance, fuel economy, and extend transaxle life by reducing excessive shifting and heat build up.

Use the “3” range when descending steep grades to prevent brake system distress.

“1” Low

This range should be used for maximum engine braking when descending steep grades. In this range, up shifts will occur only to prevent engine over speed while down shifts from 2nd to first will occur as early as possible.

MANUAL TRANSAXLE — IF EQUIPPED

NOTE: The parking brake should be engaged and the gear selector placed in REVERSE before leaving the vehicle, especially on an incline.

NOTE: Clutch must be depressed for engine to start.

Fully depress the clutch pedal before you shift gears. As you release the clutch pedal, lightly depress the accelerator pedal.

Use each gear in numerical order - do not skip a gear. Be sure the transaxle is in FIRST gear, (not THIRD), when starting from a standing position. Damage to the clutch can result from starting in THIRD.

For most city driving you will find it easier to use only the lower gears. For steady highway driving with light accelerations, 5th gear is recommended.

Never drive with your foot resting on the clutch pedal, or try to hold the vehicle on a hill with the clutch pedal partially engaged. This will cause abnormal wear on the clutch.

Never shift into REVERSE until the vehicle has come to a complete stop.

NOTE: During cold weather, until the transaxle lubricant has warmed, you may have difficulty shifting. This is normal and not harmful to the transaxle.

Recommended Shift Speeds

To use your manual transaxle for optimal fuel economy, it should be upshifted as listed in tables 1 and 2.

TABLE 1-MANUAL TRANSAXLE RECOMMENDED SHIFT SPEEDS IN MPH (KM/H)				
ENGINE SIZE	NORMAL ACCELERATION SHIFT SPEEDS			
	1 to 2	2 to 3	3 to 4	4 to 5
2.0L	14 (23)	23 (37)	29 (47)	45 (72)

TABLE 2-MANUAL TRANSAXLE RECOMMENDED SHIFT SPEEDS IN MPH (KM/H)				
ENGINE SIZE	CRUISE SHIFT SPEEDS			
	1 to 2	2 to 3	3 to 4	4 to 5
2.0L	12 (19)	18 (29)	25 (40)	32 (51)

For improved performance, your manual transaxle may be upshifted up to the maximum speeds listed in table 3 (within legal speed limits).

TABLE 3-MANUAL TRANSAXLE RECOMMENDED SHIFT SPEEDS IN MPH (KM/H)				
ENGINE SIZE	MAXIMUM PERFORMANCE SHIFT SPEEDS			
	1 to 2	2 to 3	3 to 4	4 to 5
2.0L	30 (48)	50 (80)	80 (129)	110 (177)

If you exceed these speeds, you may notice the engine cut in and out. This is caused by an electronic limiter in the engine computer. The engine will run normally when you reduce engine speed.

Downshifting

Proper downshifting may improve fuel economy and prolong engine life.

CAUTION!
If you skip more than one gear while downshifting or downshift at too high an engine speed, you could damage the engine, transaxle, or clutch.

To maintain a safe speed and prolong brake life, shift down to 2nd or 1st when descending a steep grade.

When turning a corner, or driving up a steep grade, shift down early so that the engine will not be overburdened.

PARKING BRAKE

BRAKE When the parking brake is applied with the ignition on, the Brake Light in the instrument cluster will come on.

NOTE: This light only shows that the parking brake is on. It does not show the degree of brake application.

Before leaving the vehicle, make sure that the parking brake is set. To set the parking brake, pull up firmly on the lever. Also place the gear selector in the Park position (automatic transaxle) or Reverse (manual transaxle). To release the parking brake, apply the brake pedal and pull up on the parking brake lever. Push the release button and lower the lever fully.



When parking on a hill, it is important to set the parking brake before placing the gear selector in Park, otherwise the load on the transmission locking mechanism may make it difficult to move the selector out of Park. As an added precaution, turn the front wheels toward the curb on a downhill grade and away from the curb on an uphill grade.

You should always apply the parking brake before leaving the vehicle.

WARNING!

- **Leaving children in a vehicle unattended is dangerous for a number of reasons. A child or others could be injured. Children should be warned not to touch the parking brake or the gear selector. Don't leave the keys in the ignition. A child could operate power windows, other controls, or move the vehicle.**
- **Be sure the parking brake is fully disengaged before driving; failure to do so can lead to brake failure and an accident.**

BRAKE SYSTEM

Your vehicle is equipped with power assisted brakes as standard equipment. In the event power assist is lost for any reason (for example, repeated brake applications with the engine off), the brakes will still function. The effort required to brake the vehicle will be much greater than that required with the power system operating.

WARNING!

Riding the brakes can lead to brake failure and possibly an accident. Driving with your foot resting or riding on the brake pedal can result in abnormally high brake temperatures, excessive lining wear, and possible brake damage. You wouldn't have your full braking capacity in an emergency.

5

If either of the two hydraulic systems lose normal capability, the remaining system will still function with some loss of overall braking effectiveness. This will be evident by increased pedal travel during application and greater pedal force required to slow or stop. In addition, if the

malfunction is caused by an internal leak, as the brake fluid in the master cylinder drops, the brake warning indicator will light.

Anti-Lock Brake System (ABS) — If Equipped

The ABS gives increased vehicle stability and brake performance under most braking conditions. The system automatically “pumps” the brakes during severe braking conditions to prevent wheel lock up.

All vehicle wheels and tires must be the same size and tires must be properly inflated to produce accurate signals for the computer. However, the system will compensate when the compact spare is in use.

During stops where ABS is activated, a vibration of the brake pedal may be felt and associated system noises may be heard.

NOTE: Pumping of the brake pedal will diminish the effectiveness of Anti-lock brakes and may lead to an accident. Pumping makes the stopping distance longer. Just press firmly on your brake pedal when you need to slow down or stop.

WARNING!

- **Anti-lock system (ABS) cannot prevent the natural laws of physics from acting on the vehicle, nor can it increase braking or steering efficiency beyond that afforded by the condition of the vehicle brakes and tires or the traction afforded.**
- **The ABS cannot prevent accidents, including those resulting from excessive speed in turns, following another vehicle too closely, or hydroplaning. Only a safe, attentive, and skillful driver can prevent accidents.**
- **The capabilities of an ABS equipped vehicle must never be exploited in a reckless or dangerous manner which could jeopardize the user’s safety or the safety of others.**

POWER STEERING

The power assisted steering system of your vehicle provides mechanical steering capability in the event power assist is lost.

If for some reason the hydraulic pressure is interrupted, it will still be possible to steer your vehicle. Under these conditions you will observe a substantial increase in steering effort.

TIRE SAFETY INFORMATION

Tire Markings

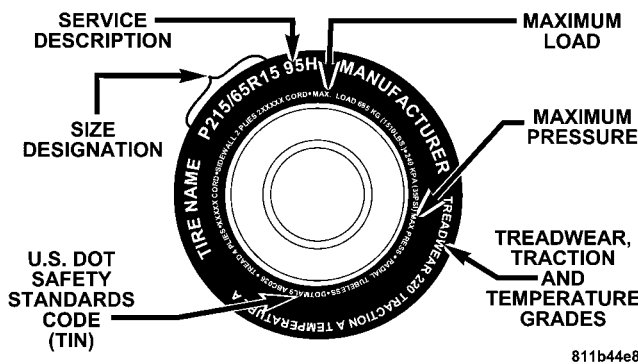

NOTE:

- P(Passenger)-Metric tire sizing is based on U.S. design standards. P-Metric tires have the letter "P" molded into the sidewall preceding the size designation. Example: P215/65R15 95H.
- European Metric tire sizing is based on European design standards. Tires designed to this standard have the tire size molded into the sidewall beginning with the section width. The letter "P" is absent from this tire size designation. Example: 215/65R15 96H
- LT(Light Truck)-Metric tire sizing is based on U.S. design standards. The size designation for LT-Metric tires is the same as for P-Metric tires except for the letters "LT" that are molded into the sidewall preceding the size designation. Example: LT235/85R16.
- Temporary Spare tires are high pressure compact spares designed for temporary emergency use only. Tires designed to this standard have the letter "T" molded into the sidewall preceding the size designation. Example: T145/80D18 103M.
- High Flotation tire sizing is based on U.S. design standards and begins with the tire diameter molded into the sidewall. Example: 31x10.5 R15 LT.

Tire Sizing Chart

EXAMPLE:	
Size Designation:	
	P = Passenger car tire size based on U.S. design standards
	"...blank..." = Passenger car tire based on European design standards
	LT = Light Truck tire based on U.S. design standards
	T = Temporary Spare tire
	31 = Overall Diameter in Inches (in)
	215 = Section Width in Millimeters (mm)
	65 = Aspect Ratio in Percent (%) —Ratio of section height to section width of tire.
	10.5 = Section Width in Inches (in)
	R = Construction Code —"R" means Radial Construction. —"D" means Diagonal or Bias Construction.
	15 = Rim Diameter in Inches (in)

EXAMPLE:**Service Description:****95** = Load Index

—A numerical code associated with the maximum load a tire can carry.

H = Speed Symbol

—A symbol indicating the range of speeds at which a tire can carry a load corresponding to its load index under certain operating conditions.

—The maximum speed corresponding to the Speed Symbol should only be achieved under specified operating conditions. (ie. tire pressure, vehicle loading, road conditions and posted speed limits).

Load Identification:**"...blank..."** = Absence of any text on sidewall of the tire indicates a Standard Load (SL) Tire**Extra Load (XL)** = Extra Load (or Reinforced) Tire**Light Load** = Light Load Tire**C,D,E** = Load range associated with the maximum load a tire can carry at a specified pressure**Maximum Load** — Maximum Load indicates the maximum load this tire is designed to carry.**Maximum Pressure** — Maximum Pressure indicates the maximum permissible cold tire inflation pressure for this tire.

Tire Identification Number (TIN)

The TIN may be found on one or both sides of the tire however the date code may only be on one side. Tires with white sidewalls will have the full TIN including date code located on the white sidewall side of the tire.

Look for the TIN on the outboard side of black sidewall tires as mounted on the vehicle. If the TIN is not found on the outboard side then you will find it on the inboard side of the tire.

EXAMPLE:
DOT MA L9 ABCD 0301
DOT = Department of Transportation —This symbol certifies that the tire is in compliance with the U.S. Department of Transportation tire safety standards, and is approved for highway use.
MA = Code representing the tire manufacturing location.(2 digits)
L9 = Code representing the tire size.(2 digits)
ABCD = Code used by tire manufacturer.(1 to 4 digits)
03 = Number representing the week in which the tire was manufactured.(2 digits) —03 means the 3rd week.
01 = Number representing the year in which the tire was manufactured.(2 digits) —01 means the year 2001. —Prior to July 2000, tire manufacturers were only required to have 1 number to represent the year in which the tire was manufactured. Example: 031 could represent the 3rd week of 1981 or 1991.

Tire Loading and Tire Pressure

Tire Placard Location

NOTE: Some vehicles have a “Tire and Loading Information” placard located on the driver’s side “B” pillar.

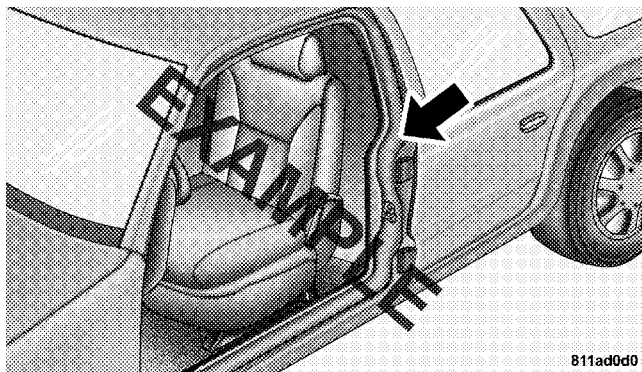

Tire and Loading Information Placard

TIRE AND LOADING INFORMATION

SEATING CAPACITY - TOTAL 5 FRONT 2 REAR 3

THE COMBINED WEIGHT OF OCCUPANTS AND CARGO SHOULD NEVER EXCEED XXX KG OR XXX LBS

TIRE	FRONT	REAR	SPARE
ORIGINAL TIRE SIZE	P195/70R14	P195/70R14	T125/70D15
COLD TIRE INFLATION PRESSURE	200kPa, 29PSI	200kPa, 29PSI	420kPa, 60PSI

SEE OWNER'S MANUAL FOR ADDITIONAL INFORMATION

4N109268

811b5a9a

This placard tells you important information about the,

- 1) number of people that can be carried in the vehicle
- 2) the total weight your vehicle can carry
- 3) the tire size designed for your vehicle
- 4) the cold tire inflation pressures for the front, rear and spare tires.

Loading

The vehicle maximum load on the tire must not exceed the load carrying capacity of the tire on your vehicle. You will not exceed the tire's load carrying capacity if you adhere to the loading conditions, tire size and cold tire inflation pressures specified on the Tire and Loading Information placard and the Vehicle Loading section of this manual.

NOTE: Under a maximum loaded vehicle condition, gross axle weight ratings (GAWR's) for the front and rear axles must not be exceeded. For further information on GAWR's, vehicle loading and trailer towing, see the Vehicle Loading section of this manual.

To determine the maximum loading conditions of your vehicle, locate the statement "The combined weight of occupants and cargo should never exceed XXX kg or XXX lbs." on the Tire and Loading Information placard. The combined weight of occupants, cargo/luggage and trailer tongue weight (if applicable) should never exceed the weight referenced here.

Steps for Determining Correct Load Limit

1. Locate the statement "The combined weight of occupants and cargo should never exceed XXX pounds" on your vehicle's placard.
2. Determine the combined weight of the driver and passengers that will be riding in your vehicle.
3. Subtract the combined weight of the driver and passengers from XXX kilograms or XXX pounds.
4. The resulting figure equals the available amount of cargo and luggage load capacity. For example, if "XXX" amount equals 1400 lbs. and there will be five 150 lb. passengers in your vehicle, the amount of available cargo and luggage load capacity is 650 lb. (1400-750 (5 x 150) = 650 lb.)
5. Determine the combined weight of luggage and cargo being loaded on the vehicle. That weight may not safely exceed the available cargo and luggage load capacity calculated in step 4.

6. If your vehicle will be towing a trailer, load from your trailer will be transferred to your vehicle. Consult this manual to determine how this reduces the available cargo and luggage load capacity of your vehicle.

NOTE: The following table shows examples on how to calculate total load, cargo/luggage and towing capacities of your vehicle with varying seating configurations and

number and size of occupants. This table is for illustration purposes only and may not be accurate for the seating and load carry capacity of your vehicle.

NOTE: For the following example the combined weight of occupants and cargo should never exceed 865 lbs. (392 Kg).

Occupants			Combined weight of occupants and cargo from Tire Placard	MINUS	Combined Occupant's weight	=	AVAILABLE Cargo/Luggage and Trailer Tongue Weight
TOTAL	FRONT	REAR					
EXAMPLE 1			865 lbs	minus	670 lbs	=	195 lbs
5	2	3					
EXAMPLE 2			865 lbs	minus	540 lbs	=	325 lbs
3	2	1					
EXAMPLE 3			865 lbs	minus	400 lbs	=	465 lbs
2	2	0					

EXAMPLE

Occupant 1: 200 lbs
 Occupant 2: 130 lbs
 Occupant 3: 160 lbs
 Occupant 4: 100 lbs
 Occupant 5: 80 lbs
 TOTAL WEIGHT: 670 lbs

Occupant 1: 210 lbs
 Occupant 2: 180 lbs
 Occupant 3: 150 lbs
 TOTAL WEIGHT: 540 lbs

Occupant 1: 200 lbs
 Occupant 2: 200 lbs
 TOTAL WEIGHT: 400 lbs

WARNING!

Overloading of your tire is dangerous. Overloading can cause tire failure, affect vehicle handling, and increase your stopping distance. Use tires of the recommended load capacity for your vehicle. Never overload them.

TIRES—GENERAL INFORMATION**Tire Pressure**

Proper tire inflation pressure is essential to the safe and satisfactory operation of your vehicle. Three primary areas are affected by improper tire pressure:

1. Safety—**WARNING!**

Improperly inflated tires are dangerous and can cause accidents.

- Under inflation increases tire flexing and can result in tire failure.
- Over inflation reduces a tire's ability to cushion shock. Objects on the road and chuck holes can cause damage that results in tire failure.
- Unequal tire pressures can cause steering problems. You could lose control of your vehicle.
- Over inflated or under inflated tires can affect vehicle handling and can fail suddenly, resulting in loss of vehicle control.
- Unequal tire pressures from one side of the vehicle to the other can cause the vehicle to drift to the right or left.

Always drive with each tire inflated to the recommended cold tire inflation pressure.

2. *Economy*—

Improper inflation pressures can cause uneven wear patterns to develop across the tire tread. These abnormal wear patterns will reduce tread life resulting in a need for earlier tire replacement. Underinflation also increases tire rolling resistance and results in higher fuel consumption.

3. *Ride Comfort and Vehicle Stability*—

Proper tire inflation contributes to a comfortable ride. Overinflation produces a jarring and uncomfortable ride.

Tire Inflation Pressures

The proper cold tire inflation pressure for passenger cars is listed on either the face of the driver's door or the driver's side "B" pillar. For vehicles other than passenger cars, the cold tire inflation pressures are listed on either the "B" pillar, the Certification Label or in the Tire Inflation Pressures brochure in the glove compartment.

Some vehicles may have Supplemental Tire Pressure Information for vehicle loads that are less than the maximum loaded vehicle condition. These pressure conditions will be found in the "Supplemental Tire Pressure Information" section of this manual.

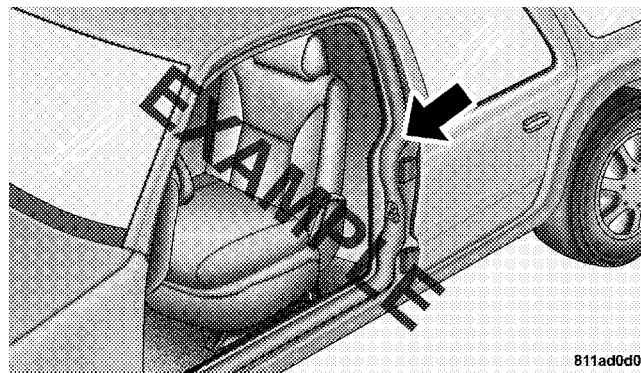

"B" PILLAR

The pressure should be checked and adjusted as well as inspecting for signs of tire wear or visible damage at least once a month. Use a good quality pocket-type gauge to check tire pressure. Do not make a visual judgement when determining proper inflation. Radial tires may look properly inflated even when they are underinflated.

CAUTION!

After inspecting or adjusting the tire pressure always reinstall the valve stem cap—if equipped. This will prevent moisture and dirt from entering the valve stem, which could damage the valve stem.

Inflation pressures specified on the placard are always “cold tire inflation pressure”. Cold tire inflation pressure is defined as the tire pressure after the vehicle has not been driven for at least 3 hours, or driven less than 1 mile (1 km) after a 3 hour period. The cold tire inflation pressure must not exceed the maximum inflation pressure molded into the tire side wall.

Check tire pressures more often if subject to a wide range of outdoor temperatures, as tire pressures vary with temperature changes.

Tire pressures change by approximately 1 psi (7 kPa) per 12° F (7° C) of air temperature change. Keep this in mind when checking tire pressure inside a garage especially in the winter.

Example: If garage temperature = 68° F (20° C) and the outside temperature = 32° F (0° C) then the cold tire inflation pressure should be increased by 3 psi (21 kPa), which equals 1 psi (7 kPa) for every 12° F (7° C) for this outside temperature condition.

Tire pressure may increase from 2 to 6 psi (13 to 40 kPa) during operation. DO NOT reduce this normal pressure build up or your tire pressure will be too low.

Tire Pressures for High Speed Operation

The manufacturer advocates driving at safe speeds within posted speed limits. Where speed limits or conditions are such that the vehicle can be driven at high speeds, maintaining correct tire inflation pressure is very important. Increased tire pressure and reduced vehicle loading may be required for high speed vehicle operation. Refer to original equipment or an authorized tire dealer for recommended safe operating speeds, loading and cold tire inflation pressures.

WARNING!

High speed driving with your vehicle under maximum load is dangerous. The added strain on your tires could cause them to fail. You could have a serious accident. Don't drive a vehicle loaded to the maximum capacity at continuous speeds above 75 mph (120 km/h).

Radial-Ply Tires**WARNING!**

Combining radial ply tires with other types of tires on your vehicle will cause your vehicle to handle poorly. The instability could cause an accident. Always use radial ply tires in sets of four (or 6, in case of trucks with dual rear wheels). Never combine them with other types of tires.

Cuts and punctures in radial tires are repairable only in the tread area because of sidewall flexing. Consult your authorized tire dealer for radial tire repairs.

Compact Spare Tire — If Equipped

The compact spare is for temporary emergency use with radial tires. It is engineered to be used on your style vehicle only. Since this tire has limited tread life, the original tire should be repaired (or replaced) and reinstalled at the first opportunity.

WARNING!

Temporary use spare tires are for emergency use only. With these tires, do not drive more than 50 mph (80 km/h). Temporary-use spare tires have limited tread life. When two or more tread wear indicators appear in adjacent grooves, the temporary use spare tire needs to be replaced. Be sure to follow the warnings which apply to your spare. Failure to do so could result in spare tire failure and loss of vehicle control.

Do not install a wheel cover or attempt to mount a conventional tire on the compact spare wheel, since the wheel is designed specifically for the compact spare.

Do not install more than one compact spare tire/wheel on the vehicle at any given time.

CAUTION!

Because of the reduced ground clearance, do not take your vehicle through an automatic car wash with the compact spare installed. Damage to the vehicle may result.

Tire Spinning

When stuck in mud, sand, snow, or ice conditions, do not spin your vehicle's wheels above 35 mph (55 km/h).

See the paragraph on Freeing A Stuck Vehicle in Section 6 of this manual.

WARNING!

Fast spinning tires can be dangerous. Forces generated by excessive wheel speeds may cause tire damage or failure. A tire could explode and injure someone. Do not spin your vehicle's wheels faster than 35 mph (55 km/h) when you are stuck. And don't let anyone near a spinning wheel, no matter what the speed.

Tread Wear Indicators

Tread wear indicators are in the original equipment tires to help you in determining when your tires should be replaced.

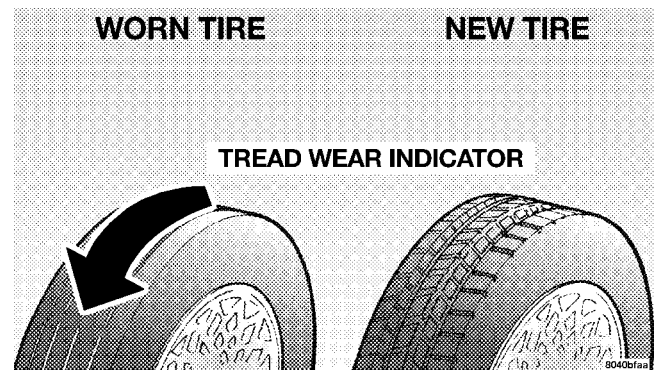

These indicators are molded into the bottom of the tread grooves and will appear as bands when the tread depth becomes 1/16 inch (2 mm). When the indicators appear in 2 or more adjacent grooves, the tire should be replaced.

Many states have laws requiring tire replacement at this point.

Replacement Tires

The tires on your new vehicle provide a balance of many characteristics. They should be inspected regularly for wear and correct cold tire inflation pressure. The manufacturer strongly recommends that you use tires equivalent to the originals in size, quality and performance when replacement is needed (see the paragraph on tread wear indicators). Refer to the Tire and Loading Information placard for the size designation of your tire. The service description and load identification will be found on the original equipment tire. Failure to use equivalent replacement tires may adversely affect the safety, handling, and ride of your vehicle. We recommend that you contact your original equipment or an authorized tire dealer with any questions you may have on tire specifications or capability.

WARNING!

- **Do not use a tire, wheel size or rating other than that specified for your vehicle. Some combinations of unapproved tires and wheels may change suspension dimensions and performance characteristics, resulting in changes to steering, handling, and braking of your vehicle. This can cause unpredictable handling and stress to steering and suspension components. You could lose control and have an accident resulting in serious injury or death. Use only the tire and wheel sizes with load ratings approved for your vehicle.**
- **Never use a tire with a smaller load index or capacity, other than what was originally equipped on your vehicle. Using a tire with a smaller load index could result in tire overloading and failure. You could lose control and have an accident.**
- **Failure to equip your vehicle with tires having adequate speed capability can result in sudden tire failure and loss of vehicle control.**

CAUTION!

Replacing original tires with tires of a different size may result in false speedometer and odometer readings.

Alignment And Balance

Poor suspension alignment may result in:

- Fast tire wear.
- Uneven tire wear, such as feathering and one-sided wear.
- Vehicle pull to right or left.

Tires may also cause the vehicle to pull to the left or right. Alignment will not correct this condition. See your dealer for proper diagnosis.

Improper alignment will not cause vehicle vibration. Vibration may be a result of tire and wheel out-of-balance. Proper balancing will reduce vibration and avoid tire cupping and spotty wear.

Tire Chains

If driving conditions require tire chains for your vehicle, chains that meet SAE class "S" requirements can be used, but they must be installed on tire sizes P175/70R14, 185/65R14, P185/65R14, 185/60R15, or P185/60R15 tires. Contact your local dealership or tire dealer for these tire sizes.

CAUTION!

To avoid damage to your vehicle or tires, observe the following precautions:

- Because of restricted chain clearance between tires and other suspension components, it is important that only chains in good condition are used. Broken chains can cause serious damage. Stop the vehicle immediately if noise occurs that could indicate chain breakage. Remove the damaged parts of the chain before further use.
- Install chains on the front wheels as tightly as possible and then retighten after driving about ½ mile (0.8 km).
- Do not exceed 45 mph (70 km/h).
- Drive cautiously and avoid severe turns and large bumps, especially with a loaded vehicle.
- Do not drive for prolonged period on dry pavement.
- Observe the tire chain manufacturer's instructions on the method of installation, operating speed, and conditions for use. Always use the lower suggested operating speed of the chain manufacturer if different than the speed recommended by the manufacture.

Snow Tires

Some areas of the country require the use of snow tires during winter. Standard tires are of the all season type and satisfy this requirement as indicated by the M+S designation on the tire side wall.

If you need snow tires, select tires equivalent in size and type to the original equipment tires. Use snow tires only in sets of 4, failure to do so may adversely affect the safety and handling of your vehicle.

Snow tires generally have lower speed ratings than what was originally equipped with your vehicle and should not be operated at sustained speeds over 75 mph (120 km/h).

Tire Rotation Recommendations

Tires on the front and rear axles of vehicles operate at different loads and perform different steering, driving and braking functions. For these reasons, they wear at unequal rates, and tend to develop irregular wear patterns.

These effects can be reduced by timely rotation of tires. The benefits of rotation are especially worthwhile with aggressive tread designs such as those on all season type tires. Rotation will increase tread life, help to maintain mud, snow and wet traction levels, and contribute to a smooth, quiet ride.

Follow the recommended tire rotation frequency for your type of driving found in the "Maintenance Schedules" Section of this manual. More frequent rotation is permissible if desired. The suggested rotation method is the "forward-cross" shown in the diagram.

TIRE ROTATION PATTERN

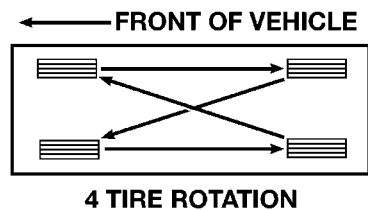

80ba79fe

5

FUEL REQUIREMENTS

2.0L Standard Engine



Your engine is designed to meet all emission regulations and provide excellent fuel economy and performance when using high quality unleaded "regular" gasoline having an octane rating of 87. The use of premium gasoline is not recommended.

The use of premium gasoline will provide no benefit over high quality regular gasolines, and in some circumstances may result in poorer performance.

2.0L High Output Engine



Your engine is designed to meet all emission regulations and provide excellent fuel economy and performance when using high quality unleaded gasoline having an octane rating of 91. The purchase of higher octane is not recommended.

High quality unleaded gasoline having a minimum octane rating of 87 may safely be used for your vehicle. Use of these lower octane gasolines, however, may result in reduced acceleration performance.

Spark Knock

Light spark knock at low engine speeds is not harmful to your engine. However, continued heavy spark knock at high speeds can cause damage and immediate service is required. Engine damage resulting from operation with a heavy spark knock may not be covered by the new vehicle warranty.

Poor quality gasoline can cause problems such as hard starting, stalling and hesitations. If you experience these symptoms, try another brand of "regular" gasoline before considering service for the vehicle.

Over 40 automobile manufacturers around the world have issued and endorsed consistent gasoline specifications (the World Wide Fuel Charter, WWFC) to define fuel properties necessary to deliver enhanced emissions, engine performance, and durability for your vehicle. The manufacturer recommends the use of gasolines that meet the WWFC specifications if they are available.

Reformulated Gasoline

Many areas of the country require the use of cleaner burning fuel referred to as Reformulated Gasoline. Reformulated gasolines contain oxygenates, and are specifically blended to reduce vehicle emissions and improve air quality.

The manufacturer supports the use of reformulated gasolines. Properly blended reformulated gasolines will provide excellent performance and durability for the engine and fuel system components.

Gasoline/Oxygenate Blends

Some fuel suppliers blend unleaded gasoline with materials called oxygenates such as 10% ethanol, MTBE and ETBE. Oxygenates are required in some areas of the

country during the winter months to reduce carbon monoxide emissions. Fuels blended with these oxygenates may be used in your vehicle.

CAUTION!

DO NOT use gasolines containing Methanol. Gasoline containing methanol may damage critical fuel system components.

Problems that result from using methanol/gasoline blends are not the responsibility of The manufacturer and may not be covered by the vehicle warranty. While MTBE is an oxygenate made from Methanol, it does not have the negative effects of Methanol.

MMT in Gasoline

MMT is a manganese containing metallic additive that is blended into some gasoline to increase octane. Gasolines blended with MMT provide no performance advantage beyond gasolines of the same octane number without MMT. Gasolines blended with MMT have shown to reduce spark plug life and reduce emission system

performance in some vehicles. The manufacturer recommends that gasolines free of MMT be used in your vehicle. The MMT content of gasoline may not be indicated on the gasoline pump, therefore you should ask your gasoline retailer whether or not his/her gasoline contains MMT.

It is even more important to look for gasolines without MMT in Canada because MMT can be used at higher levels than allowed in the United States.

MMT is prohibited in both Federal and California reformulated gasolines.

Sulfur in Gasoline

Your vehicle may have been designed to meet California low emission standards with cleaner burning California reformulated gasoline with low sulfur. This vehicle may be sold nationwide. Your vehicle will operate satisfactorily on fuels meeting Federal specifications, but emission control system performance may be adversely affected.

Gasoline sold outside of California is permitted to have higher sulfur levels which may affect the performance of the vehicle's catalytic converter. This may cause the

Malfunction Indicator light to illuminate. The manufacturer recommends that you try a different brand of unleaded gasoline having lower sulfur to determine if the problem is fuel related prior to returning your vehicle to an authorized dealer for service.

CAUTION!

If the Check Engine or Service Engine Soon light is flashing, immediate service is required. See the On Board Diagnostics paragraph in the Maintenance section of this manual.

Materials Added to Fuel

All gasoline sold in the United States is required to contain effective detergent additives. Use of additional detergents or other additives is not needed under normal conditions and would result in unnecessary cost. Therefore you should not have to add anything to the fuel.

Fuel System Cautions

CAUTION!

Follow these guidelines to maintain your vehicle's performance:

- The use of leaded gas is prohibited by Federal law. Using leaded gasoline can impair engine performance, damage the emission control system, and could result in loss of warranty coverage.
- An out-of-tune engine, or certain fuel or ignition malfunctions, can cause the catalytic converter to overheat. If you notice a pungent burning odor or some light smoke, your engine may be out of tune or malfunctioning and may require immediate service. Contact your dealer for service assistance.
- The use of fuel additives which are now being sold as octane enhancers is not recommended. Most of these products contain high concentrations of methanol. Fuel system damage or vehicle performance problems

resulting from the use of such fuels or additives is not the responsibility of the manufacturer and may not be covered under the New Vehicle Warranty.

NOTE: Intentional tampering with emissions control systems can result in civil penalties being assessed against you.

Carbon Monoxide Warnings

WARNING!

Carbon monoxide (CO) in exhaust gases is deadly. Follow the precautions below to prevent carbon monoxide poisoning:

- Do not inhale exhaust gases. They contain carbon monoxide, a colorless and odorless gas which can kill. Never run the engine in a closed area, such as a garage, and never sit in a parked vehicle with the engine running for an extended period. If the vehicle is stopped in an open area with the engine running for more than a short period, adjust the ventilation system to force fresh, outside air into the vehicle.

- Guard against carbon monoxide with proper maintenance. Have the exhaust system inspected every time the vehicle is raised. Have any abnormal conditions repaired promptly. Until repaired, drive with all side windows fully open.
- Keep the liftgate closed when driving your vehicle to prevent carbon monoxide and other poisonous exhaust gases from entering the vehicle.

ADDING FUEL

NOTE: The fuel tank filler tube has a restricting door about 2 inches (50 mm) down from the opening. If fuel is poured from a portable container, the container should have a flexible nozzle long enough to force open the restricting door.

Fuel Tank Filler Cap

The gas cap is behind the fuel filler door, on the passenger's side of the vehicle. If the gas cap is lost or damaged, be sure the replacement cap has been designed for use with this vehicle.

CAUTION!

Damage to the fuel system or emission control system could result from using an improper fuel tank filler tube cap (gas cap). A poorly fitting cap could let impurities into the fuel system.

CAUTION!

A poorly fitting gas cap may cause the Malfunction Indicator Lamp to turn on.

NOTE: When the fuel nozzle “clicks” or shuts off, the fuel tank is full.

CAUTION!

To avoid fuel spillage and overfilling, do not “top off” the fuel tank after filling.

NOTE: Tighten the gas cap about 1/4 turn until you hear one click. This is an indication that the cap is properly tightened.

If the gas cap is not tightened properly, the Malfunction Indicator light will come on. Be sure the gas cap is tightened every time the vehicle is fueled.

WARNING!
<ul style="list-style-type: none"> • Remove the fuel tank filler tube cap (gas cap) slowly to prevent fuel spray from the filler neck which may cause injury. • The volatility of some gasolines may cause a build up of pressure in the fuel tank that may increase while you drive. This pressure can result in a spray of gasoline and/or vapors when you remove the cap from a hot vehicle. Removing the cap slowly allows the pressure to vent and prevents fuel spray. • Never have any smoking materials lit in or near the vehicle when the gas cap is removed or the tank filled. • Never add fuel when the engine is running.

WARNING!
<p>A fire may result if gasoline is pumped into a portable container that is inside of a vehicle. You could be burned. Always place gas containers on the ground while filling.</p>

VEHICLE LOADING

Vehicle Loading Capacities

Front Seat Occupants	2
Rear Seat Occupants	3
Luggage	115 lbs. (52 kg)
Rated Vehicle Capacity	865 lbs. (392 kg)

- Turn off engine.
- Rotate the gas cap to the left to remove.
- To replace the cap, insert it into the filler neck and tighten to the right until at least one click is heard.

TRAILER TOWING

In this section you will find safety tips and information on limits to the type of towing you can reasonably do with your vehicle. Before towing a trailer carefully review this information to tow your load as efficiently and safely as possible.

To maintain warranty coverage, follow the requirements and recommendations in this manual concerning vehicles used for trailer towing.

Perform maintenance services as prescribed in the maintenance schedules manual. When your vehicle is used for trailer towing, never exceed the gross axle weight rating (GAWR) by the addition of:

- The tongue weight of the trailer.
- The weight of any other type of cargo or equipment put in or on your vehicle.
- Remember that everything put in or on the trailer adds to the load on your vehicle.

Warranty Requirements

The Manufacturer's Passenger Vehicle Warranty will apply to vehicles used to tow trailers for non-commercial use. However the following conditions must be met:

- The maximum trailer load for vehicles with the Standard 2.0L Engine and manual transaxles is 1,500 lbs (680 kg).
- The maximum trailer load for vehicles with the Standard 2.0L Engine and automatic transaxles is 1,000 lbs (454 kg).
- Trailer towing is not recommended for vehicles with the optional 2.0L Magnum Engine (R/T) and manual transaxle.
- If using a manual transaxle vehicle for trailer towing, all starts must be in FIRST gear to avoid excessive clutch slippage.
- The maximum frontal area of the trailer cannot exceed 20 square feet (1.86 square meters).
- The trailer tongue load must be considered as part of the combined weight of occupants and cargo, and should never exceed the weight referenced on the Tire

and Loading Information placard. Refer to the Tire–Safety Information Section in this manual.

- The “D” range can be selected when towing. However, if frequent shifting occurs while in this range, the “3” range must be selected.

NOTE: Using the “3” range while operating the vehicle under heavy operating conditions will improve performance and extend transaxle life by reducing excessive shifting and heat build up.

WARNING!

Connecting trailer brakes to your vehicle’s hydraulic brake lines can overload your brake system and cause it to fail. You might not have brakes when you need them and could have an accident.

- Do not attempt to tow a trailer while using a compact spare tire.
- Whenever you pull a trailer, regardless of the trailer size, stop lights and turn signals on the trailer are recommended for motoring safety.

- The automatic transaxle fluid and filter should be changed if you **REGULARLY** tow a trailer for more than 45 minutes of continuous operation. See Schedule “B” in section 8 of this manual for transaxle fluid change intervals.

NOTE: Check the automatic transaxle fluid level before towing.

NOTE: For vehicles equipped with Autostick. By using the Autostick modes, and selecting a specific gear range, frequent shifting can be avoided. The highest gear range should be selected that allows for adequate performance. For example, choose “4” if the desired speed can be maintained. Choose “3” or “2” if needed to maintain the desired speed.

NOTE: Extended driving at high RPM should be avoided to prevent excess heat generation. A reduction in vehicle speed may be required to avoid extended driving at high RPM. Return to a higher gear range or vehicle speed when road conditions and RPM level allows.

WHAT TO DO IN EMERGENCIES

CONTENTS

■ Hazard Warning Flasher	152	□ Traction	160
■ If Your Engine Overheats	152	■ Freeing A Stuck Vehicle	160
■ Jacking And Tire Changing	153	■ Towing A Disabled Vehicle	161
□ Preparations For Jacking	154	□ With Ignition Key	161
□ Instructions	154	□ Without The Ignition Key	162
■ Jump-Starting Procedures If Battery Is Low	157	□ Towing This Vehicle Behind Another Vehicle (Flat Towing With All Four Wheels On The Ground)	162
■ Driving On Slippery Surfaces	159		
□ Acceleration	159		

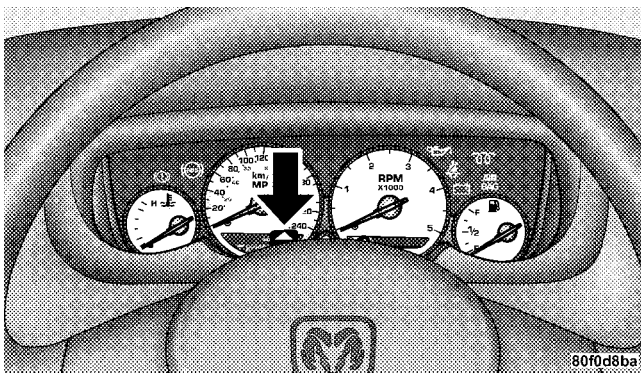
HAZARD WARNING FLASHER

 The flasher switch is on top of the steering column, just behind the steering wheel. Depress the switch and both cluster indicators and all front and rear directional signals will flash. Depress the switch again to turn Hazard Warning Flashers off.

Do not use this emergency warning system when the vehicle is in motion. Use it when your vehicle is disabled and is creating a safety hazard for other motorists.

If it is necessary to leave the vehicle to go for service, the flasher system will continue to operate with the ignition key removed and the vehicle locked.

NOTE: With extended use, the flasher may wear down your battery.

IF YOUR ENGINE OVERHEATS

In any of the following situations, you can reduce the potential for overheating by taking the appropriate action.

- On the highways — Slow down.
- In city traffic — While stopped, put transaxle in neutral, but do not increase engine idle speed.

NOTE: There are steps that you can take to slow down an impending overheat condition. If your air conditioner is on, turn it off. The air conditioning system adds heat to the engine cooling system and turning off the A/C removes this heat. You can also turn the Temperature control to maximum heat, the Mode control to floor, and the fan control to High. This allows the heater core to act as a supplement to the radiator and aids in removing heat from the engine cooling system.

CAUTION!

Driving with a hot cooling system could damage your vehicle. If temperature gauge reads "H", pull over and stop the vehicle. Idle the vehicle with the air conditioner turned off until the pointer drops back into the normal range. If the pointer remains on the "H", turn the engine off immediately, and call for service.

WARNING!

A hot engine cooling system is dangerous. You or others could be badly burned by steam or boiling coolant. You may want to call a service center if your vehicle overheats. If you decide to look under the hood yourself, see Section 7, Maintenance, of this manual. Follow the warnings under the Cooling System Pressure Cap paragraph.

JACKING AND TIRE CHANGING**WARNING!**

- Getting under a jacked-up vehicle is dangerous. The vehicle could slip off the jack and fall on you. You could be crushed. Never get any part of your body under a vehicle that is on a jack. Never start or run the engine while the vehicle is on a jack. If you need to get under a raised vehicle, take it to a service center where it can be raised on a lift.
- Do not attempt to change a tire on the side of the vehicle close to moving traffic. Pull far enough off the road to avoid the danger of being hit when operating the jack or changing the wheel.

Preparations For Jacking

Park the vehicle on a firm level surface, avoid ice or slippery areas, and set the parking brake. Place the gear selector in PARK (automatic transaxle) or REVERSE (manual transaxle).

- Turn on the Hazard Warning Flasher.

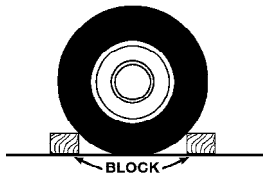

- Block both the front and rear of the wheel diagonally opposite the jacking position. For example, if changing the right front tire, block the left rear wheel.

- Passengers should not remain in the vehicle while the vehicle is being jacked.

Instructions

The spare wheel, scissors jack, and lug wrench are stowed under the spare tire cover in the rear cargo area.

Do not attempt to raise this vehicle using a bumper jack.

1. Remove the spare wheel, scissors jack and lug wrench from stowage.

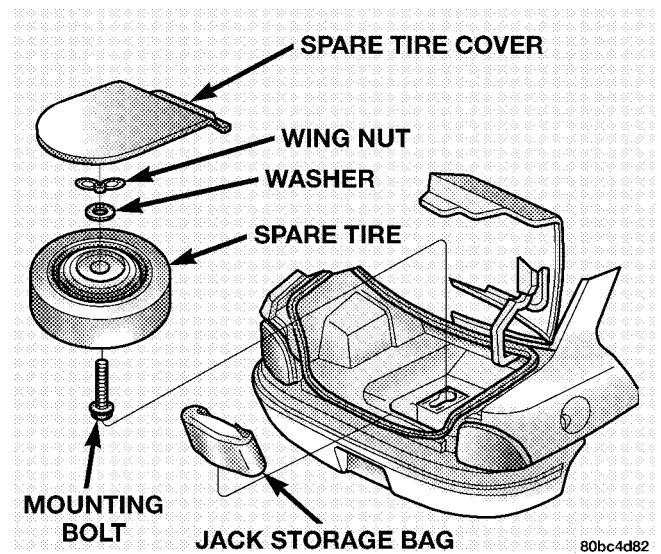

2. Loosen, but do not remove, the wheel nuts by turning them to the left one turn while the wheel is still on the ground.

80bc4d82

CAUTION!

Do not attempt to raise the vehicle by jacking on the crossmember below the radiator or on the front suspension crossmember.

3. Jack saddle support must be positioned in between locating darts at the front of the vehicle and behind locating dart at the rear. Turn the jack screw to the right until the jack head is properly engaged with the lift area closest to the wheel to be changed.

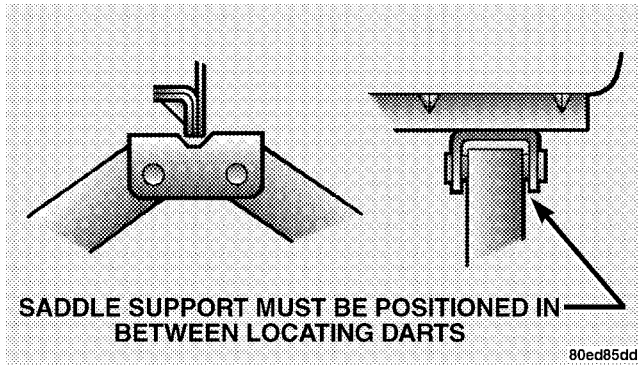

Do not raise the vehicle until you are sure the jack is securely engaged.

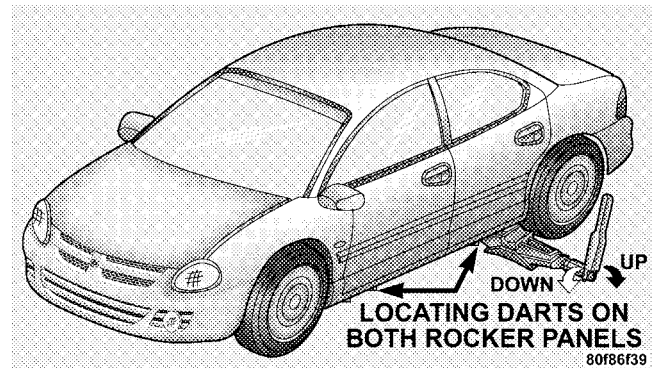

4. Raise the vehicle by turning the jack screw to the right. Raise the vehicle only until the tire clears the surface. Minimum tire lift provides maximum vehicle stability.

WARNING!

Raising the vehicle higher than necessary can make the vehicle less stable. It could slip off the jack and hurt someone near it. Raise the vehicle only enough to remove the tire.

5. Remove the wheel nuts and pull the wheel and wheel covers where applicable off the hub. Install the spare wheel and wheel nuts with the cone shaped end of the nuts toward the wheel. Lightly tighten the nuts. To avoid the risk of forcing the vehicle off the jack, do not tighten the nuts fully until the vehicle has been lowered.

WARNING!

To avoid possible personal injury, handle the wheel covers with care to avoid contact with any sharp edges.

NOTE: The wheel cover is held on the wheel by the wheel nuts. When reinstalling original wheel, properly

align the wheel cover to the valve stem, place the wheel cover onto the wheel, then install the wheel nuts.

6. Lower the vehicle by turning the jack screw to the left.
7. Finish tightening the nuts. Push down on the wrench while tightening the wheel nuts. Alternate nuts until each nut has been tightened twice. Correct wheel nut torque is 100 ft. lbs. (135 N·m). If you are not sure about the tightness, have them checked with a torque wrench by your dealer or at a service station.
8. Remove the wheel blocks and lower the jack until it is free. Stow the lug wrench, replaced tire, and jack. Secure all parts using the means provided.

WARNING!

A loose tire or jack thrown forward in a collision or hard stop could endanger the occupants of the vehicle. Always stow the jack parts and the spare tire in the places provided.

9. Adjust the tire pressure as soon as possible.

NOTE: The spare tire well is designed to hold the compact spare tire or a deflated (flat) tire. A fully inflated tire will not fit in the spare tire well.

JUMP-STARTING PROCEDURES IF BATTERY IS LOW

WARNING!

Take care to avoid the radiator cooling fan whenever the hood is raised. It can start anytime the ignition switch is on. You can be hurt by the fan.

WARNING!

Do not attempt to push or tow your vehicle to get it started. Vehicles equipped with an automatic transaxle cannot be started this way. Unburned fuel could enter the catalytic converter and once the engine has started, ignite and damage the converter and vehicle. If the vehicle has a discharged battery, booster cables may be used to obtain a start from another vehicle. This type of start can be dangerous if done improperly, so follow this procedure carefully.

6

1. Wear eye protection and remove any metal jewelry such as watch bands or bracelets that might make an inadvertent electrical contact.
2. When boosting from a battery in another vehicle, park that vehicle within booster cable reach but without letting the vehicles touch. Set parking brake, place automatic transaxle in PARK (manual transaxle in NEUTRAL) and turn ignition to OFF for both vehicles.
3. Turn off the heater, radio and all unnecessary electrical loads.

4. Connect one end of a jumper cable to the positive terminal of the booster battery. Connect the other end to the positive terminal of the discharged battery.

WARNING!

Do not permit vehicles to touch each other as this could establish a ground connection and personal injury could result.

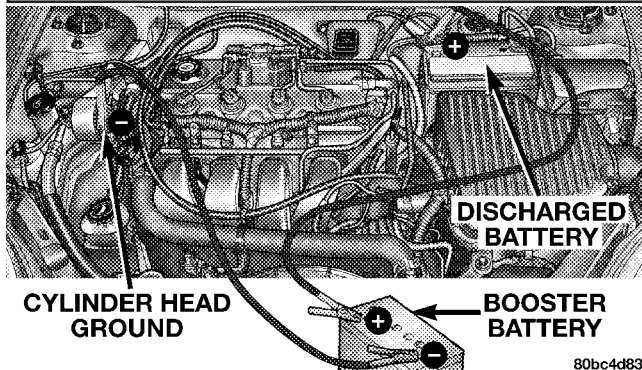
**WARNING!**

Battery fluid is a corrosive acid solution; do not allow battery fluid to contact eyes, skin or clothing. Don't lean over battery when attaching clamps or allow the clamps to touch each other. If acid splashes in eyes or on skin, flush the contaminated area immediately with large quantities of water.

A battery generates hydrogen gas which is flammable and explosive. Keep flame or spark away from the vent holes. Do not use a booster battery or any other booster source with an output that exceeds 12 volts.

5. Connect the other cable, first to the negative terminal of the booster battery and then to the engine of the vehicle with the discharged battery. Make sure you have a good contact on the engine.

WARNING!

Do not connect the cable to the negative post of the discharge battery. The resulting electrical spark could cause the battery to explode.

During cold weather when temperatures are below freezing point, electrolyte in a discharged battery may freeze. Do not attempt jump starting because the battery could rupture or explode. The battery temperature must be brought up above freezing point before attempting to jump start.

WARNING!

Any procedure other than above could result in:

1. Personal injury caused by electrolyte squirting out the battery vent;
2. Personal injury or property damage due to battery explosion;
3. Damage to charging system of booster vehicle or of immobilized vehicle.

6. If the vehicle is equipped with sentry key immobilizer, turn the ignition switch to the ON/RUN position for 3 seconds prior to moving the ignition switch to the crank position and starting the vehicle.

7. Start the engine in the vehicle that has the booster battery, let the engine idle a few minutes, then start the engine in the vehicle with the discharged battery.

8. When removing the jumper cables, reverse the above sequence exactly. Be careful of the moving belts and fan.

DRIVING ON SLIPPERY SURFACES**Acceleration**

Rapid acceleration on snow covered, wet, or other slippery surfaces may cause the front wheels to pull erratically to the right or left. This phenomenon occurs when there is a difference in the surface traction under the front (driving) wheels, particularly with high output engines.

WARNING!

Rapid acceleration on slippery surfaces is dangerous. Unequal traction can cause sudden pulling of the front wheels. You could lose control of the vehicle and possibly have an accident. Accelerate slowly and carefully whenever there is likely to be poor traction (ice, snow, wet, mud, loose sand, etc.).

Traction

When driving on wet or slushy roads, it is possible for a wedge of water to build up between the tire and road surface. This is hydroplaning and may cause partial or complete loss of vehicle control and stopping ability. To reduce this possibility, the following precautions should be observed:

1. Slow down during rainstorms or when roads are slushy.
2. Slow down if road has standing water or puddles.
3. Replace tires when tread wear indicators first become visible.

4. Keep tires properly inflated.

5. Maintain enough distance between your vehicle and the vehicle in front of you to avoid a collision in a sudden stop.

FREEING A STUCK VEHICLE

If your vehicle becomes stuck in mud, sand or snow, it can often be moved by a rocking motion. Turn your steering wheel right and left to clear the area around the front wheels. Then shift back and forth between Reverse and First gear. Usually the least accelerator pedal pressure to maintain the rocking motion without spinning the wheels is most effective.

WARNING!

Fast spinning tires can be dangerous. Forces generated by excessive wheel speeds may cause tire damage or failure. A tire could explode and injure someone. Do not spin your vehicle's wheels faster than 35 mph (55km/h) when you are stuck. And don't let anyone near a spinning wheel, no matter what the speed.

CAUTION!

Racing the engine or spinning the wheels too fast may lead to transaxle overheating and failure. It can also damage the tires. Do not spin the wheels above 35 mph (55km/h).

TOWING A DISABLED VEHICLE**With Ignition Key****Four Speed Automatic Transaxle**

Your vehicle may be towed under the following conditions: The steering column must be unlocked and the gear selector must be in NEUTRAL, the distance to be towed must not exceed 100 miles (160 km), and the towing speed must not exceed 44 mph (72 km/h). If the transaxle is not operative, or if the vehicle is to be towed more than 100 miles (160 km), the vehicle must be towed with the front wheels off the ground to avoid damage to the transaxle.

Manual Transaxle

Your vehicle may be towed if the gearshift lever is in NEUTRAL. If the transaxle is not operative, the vehicle must be towed with the front wheels off the ground.

All Transaxles

CAUTION!

If the vehicle being towed requires steering, the ignition switch must be in the OFF position, not in the LOCK or ACCESSORY positions.

If it is necessary to use the accessories while being towed (wipers, defrosters, etc.), the key must be in the ON position, not the ACCESSORY position. Make certain the transaxle remains in NEUTRAL.

Without The Ignition Key

Special care must be taken when the vehicle is towed with the ignition in the LOCK position. A dolly should be used under the front wheels if the rear wheels are raised. Proper towing equipment is necessary to prevent damage to the vehicle.

Towing This Vehicle Behind Another Vehicle (Flat Towing With All Four Wheels On The Ground)

If your vehicle is equipped with a manual transaxle, it may be towed at any legal highway speed, for any distance, if the transaxle is in neutral.

If the ignition key is not available, vehicles with automatic transaxles can not be flat towed at any time.

MAINTAINING YOUR VEHICLE

CONTENTS

■ 2.0L Engine Compartment	165	□ Maintenance-Free Battery	175
■ Onboard Diagnostic System — OBD II	166	□ Air Conditioner	176
■ Emissions Inspection And Maintenance Programs	167	□ Power Steering Fluid Check	177
■ Replacement Parts	168	□ Front Suspension Ball Joints	178
■ Dealer Service	168	□ Body Lubrication	178
■ Maintenance Procedures	169	□ Windshield Wiper Blades	178
□ Engine Oil	169	□ Windshield Wiper Blade Replacement	179
□ Ignition Wiring System	174	□ Windshield Washer Aiming	179
□ Crankcase Emission Control System	174	□ Windshield Washer Reservoir	179
□ Fuel Filter	175	□ Exhaust System	179
□ Air Cleaner Element (Filter)	175	□ Cooling System	180

164 MAINTAINING YOUR VEHICLE

□ Hoses And Vacuum/Vapor Harnesses	184	■ Bulb Replacement	197
□ Brake System	185	□ Headlight Bulb Replacement	197
□ Automatic Transaxle	187	□ Front Park/Turn Signal Lights	199
□ Manual Transaxle	189	□ Front Sidemarket Light	199
□ Appearance Care And Protection From Corrosion	190	□ Tail/Stop, Rear Turn Signals And Back-Up Lights	199
■ Fuses	195	□ Center High Mounted Stop Light	199
□ Underhood Fuses (Power Distribution Center)	195	■ Fluids And Capacities	200
□ Interior Fuses	195	■ Recommended Fluids, Lubricants And Genuine Parts	201
■ Vehicle Storage	196	□ Engine	201
■ Replacement Bulbs	196	□ Chassis	201

2.0L ENGINE COMPARTMENT

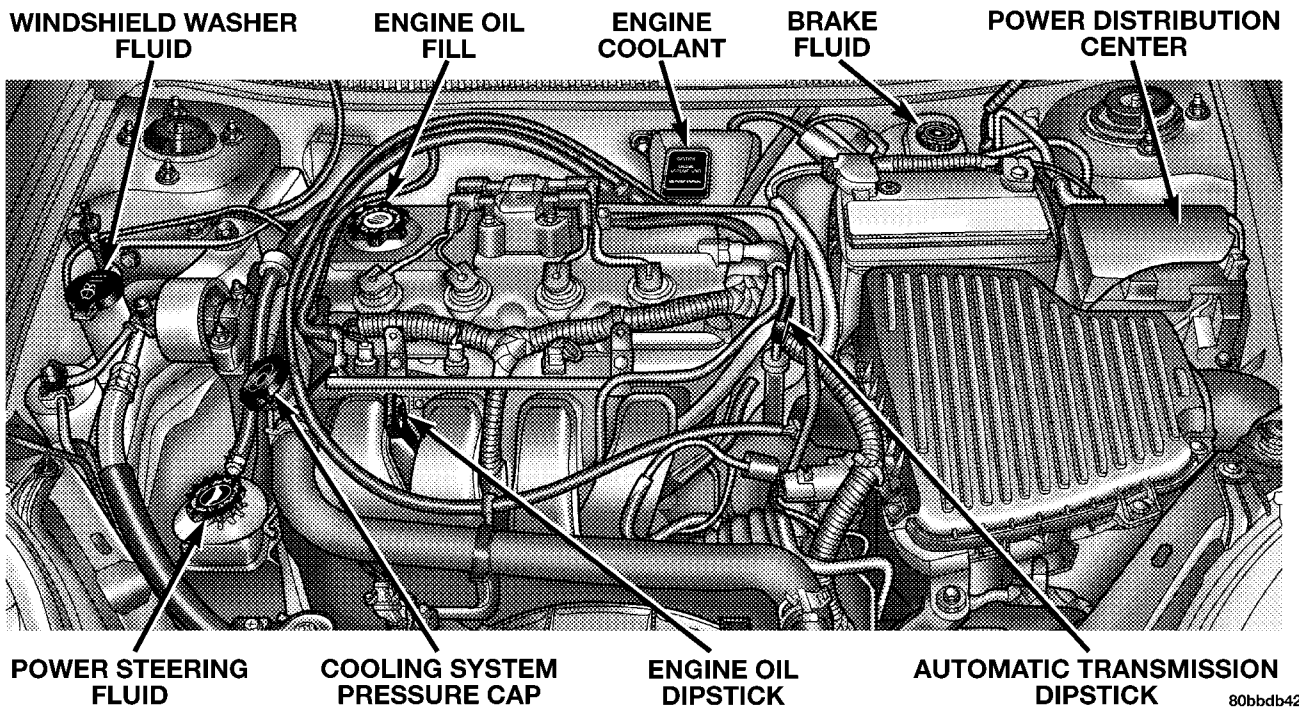

80bbdb42

ONBOARD DIAGNOSTIC SYSTEM — OBD II

Your vehicle is equipped with a sophisticated onboard diagnostic system called OBD II. This system monitors the performance of the emissions, engine, and automatic transmission control systems. When these systems are operating properly, your vehicle will provide excellent performance and fuel economy, as well as engine emissions well within current government regulations.

If any of these systems require service, the OBD II system will turn on the “Malfunction Indicator Light.” It will also store diagnostic codes and other information to assist your service technician in making repairs. Although your vehicle will usually be drivable and not need towing, see your dealer for service as soon as possible.

CAUTION!

- **Prolonged driving with the “Malfunction Indicator Light” on could cause further damage to the emission control system. It could also affect fuel economy and driveability. The vehicle must be serviced before any emissions tests can be performed.**
- **If the “Malfunction Indicator Light” is flashing while the engine is running, severe catalytic converter damage and power loss will soon occur. Immediate service is required.**

EMISSIONS INSPECTION AND MAINTENANCE PROGRAMS

In some localities, it may be a legal requirement to pass an inspection of your vehicle's emissions control system. Failure to pass could prevent vehicle registration.



For states which have an I/M (Inspection and Maintenance) requirement, this check verifies the following: the MIL (Malfunction Indicator Lamp) is functioning and is not on when the engine is running, and that the OBD (On Board Diagnostic) system is ready for testing.

Normally, the OBD system will be ready. The OBD system may **not** be ready if your vehicle was recently serviced, if you recently had a dead battery, or a battery replacement. If the OBD system should be determined not ready for the I/M test, your vehicle may fail the test.

Your vehicle has a simple ignition key actuated test which you can use prior to going to the test station. To check if your vehicle's OBD system is ready, you must do the following:

1. Insert your ignition key into the ignition switch.
2. Turn the ignition to the ON position, but do not crank or start the engine.
3. If you crank or start the engine, you will have to start this test over.
4. As soon as you turn your key to the ON position, you will see your MIL symbol come on as part of a normal bulb check.
5. Approximately 15 seconds later, one of two things will happen:
 - a. The MIL will flash for about 10 seconds and then return to being fully illuminated until you turn off the ignition key or start the engine. This means that your vehicle's OBD system is **not ready** and you should **not** proceed to the I/M station.
 - b. The MIL will not flash at all and will remain fully illuminated until you turn off the ignition key or start the engine. This means that your vehicle's OBD system is **ready** and you can proceed to the I/M station.

If your OBD system is **not ready**, you should see your authorized dealer or repair facility. If your vehicle was recently serviced or had a battery failure or replacement, you may need to do nothing more than drive your vehicle as you normally would in order for your OBD system to update. A recheck with the above test routine may then indicate that the system is now ready.

Regardless of whether your vehicle's OBD system is ready or not ready, if the MIL symbol is illuminated during normal vehicle operation, you should have your vehicle serviced before going to the I/M station. The I/M station can fail your vehicle because the MIL symbol is on with the engine running.

REPLACEMENT PARTS

Use of genuine Mopar parts for normal/scheduled maintenance and repairs is highly recommended to insure the designed performance. Damage or failures caused by the use of non-Mopar parts for maintenance and repairs will not be covered by the manufacturer warranty.

DEALER SERVICE

Your dealer has the qualified service personnel, special tools and equipment to perform all service operations in an expert manner. Service manuals are available which include detailed service information for your vehicle. Refer to these manuals before attempting any procedure yourself.

NOTE: Intentional tampering with emissions control systems can result in civil penalties being assessed against you.

WARNING!

You can be badly injured working on or around a motor vehicle. Do only that service work for which you have the knowledge and the proper equipment. If you have any doubt about your ability to perform a service job, take your vehicle to a competent mechanic.

MAINTENANCE PROCEDURES

The pages that follow contain the **required** maintenance services determined by the engineers who designed your vehicle.

Besides the maintenance items for which there are fixed maintenance intervals, there are other items that should operate satisfactorily without periodic maintenance. However, if a malfunction of these items does occur, it could adversely affect the engine or vehicle performance. These items should be inspected if a malfunction is observed or suspected.

Engine Oil**Checking Oil Level**

To assure proper engine lubrication, the engine oil must be maintained at the correct level. Check the oil level at regular intervals, such as every fuel stop.

The best time to check the engine oil level is about 5 minutes after a fully warmed engine is shut off, or before starting the engine after it has sat overnight.

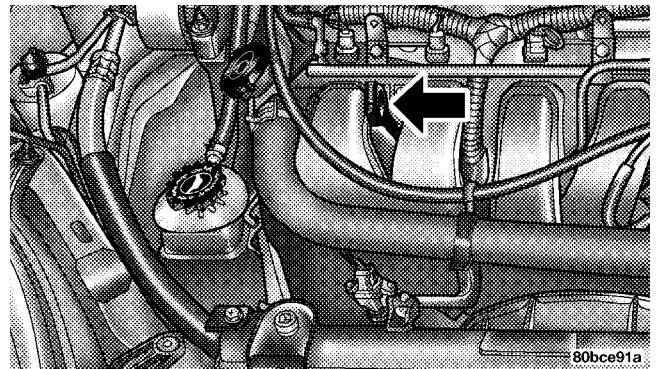

Checking the oil while the vehicle is on level ground will improve the accuracy of the oil level readings. Maintain

the oil level between the MIN and MAX markings on the dipstick. Adding one quart of oil when the reading is at the MIN mark will result in a MAX reading on these engines.

CAUTION!

Overfilling or underfilling will cause aeration or loss of oil pressure. This could damage your engine.

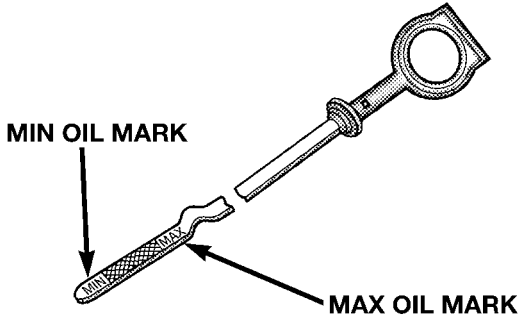

809744ab

Change Engine Oil

Road conditions and your kind of driving affects the interval at which your oil should be changed. Check the following list to decide if any apply to you.

- Day and night temperatures are below 32°F (0°C)
- Stop and Go driving
- Extensive engine idling
- Driving in dusty conditions
- Short trips of less than 10 miles (16.2 km)
- More than 50% of your driving is at sustained high speeds during hot weather, above 90°F (32°C)
- Trailer towing
- Taxi, Police, or delivery service (commercial service)
- Off-road or desert operation
- If equipped for and operating with E-85 (ethanol) fuel

NOTE: If ANY of these apply to you then change your engine oil every 3,000 miles (5 000 km) or 3 months, whichever comes first and follow schedule "B" of the "Maintenance Schedules" section of this manual.

If none of these apply to you, then change your engine oil at every interval shown on schedule "A" of the "Maintenance Schedules" section of this manual.

NOTE: Under no circumstances should oil change intervals exceed 6000 miles (10 000 km) or 6 months whichever comes first.

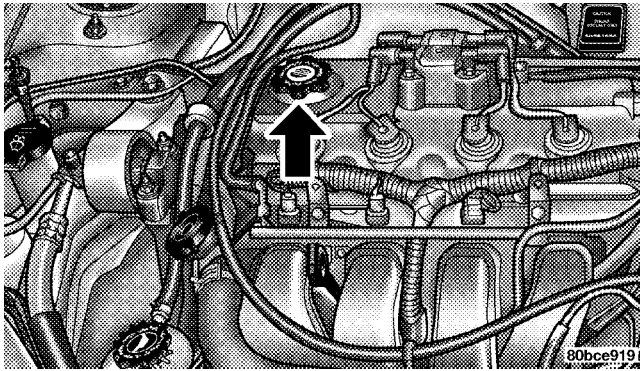

Engine Oil Selection

For best performance and maximum protection under all types of operating conditions, the manufacturer only recommends engine oils that are API certified and meet the requirements of DaimlerChrysler Material Standard MS-6395.

American Petroleum Institute (API) Engine Oil Identification Symbol



This symbol means that the oil has been certified by the American Petroleum Institute (API). The manufacturer only recommends API Certified engine oils.

7

Engine Oil Viscosity Chart

The proper SAE viscosity grade of engine oil should be selected based on the following recommendation and be within the operating temperature shown in the engine oil viscosity chart.

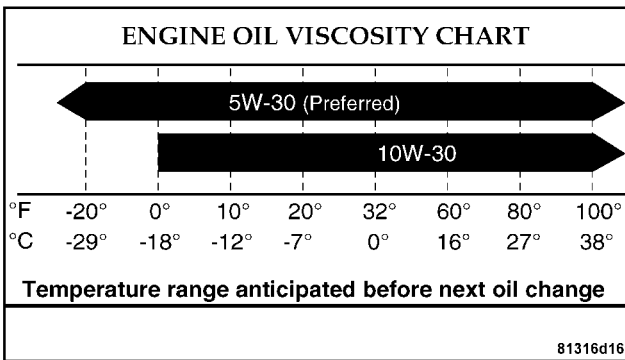

Synthetic Engine Oils

There are a number of engine oils being promoted as either synthetic or semi-synthetic. If you chose to use such a product, use **only** those oils that are American Petroleum Institute (API) Certified and SAE viscosity standard. Follow the service schedule that describes your driving type.

Materials Added To Engine Oils

The manufacturer strongly recommends against the addition of any additives (other than leak detection dyes) to

the engine oil. Engine oil is an engineered product and it's performance may be impaired by supplemental additives.

Disposing of Used Engine Oil

Care should be taken in disposing of used engine oil from your vehicle. Used oil, indiscriminately discarded, can present a problem to the environment. Contact your dealer, service station, or governmental agency for advice on how and where used oil can be safely discarded in your area.

Engine Oil Filter

The engine oil filter should be replaced at every engine oil change.

Engine Oil Filter Selection

All of this manufacturers engines have a full-flow type disposable oil filter. Use a filter of this type for replacement. The quality of replacement filters varies considerably. Only high quality filters should be used to assure most efficient service. Mopar Engine Oil Filters are high quality oil filters and are recommended.

Drive Belts — Check Condition and Tension

At the mileage shown in the maintenance schedules, check all drive belts for condition and proper tension. Improper belt tension can cause belt slippage and failure.

Inspect the drive belts for evidence of cuts, cracks, or glazing and replace them if there is any sign of damage which could result in belt failure. If adjustment is required, adjust the belts according to the specifications and procedures shown in the Service Manual.

Special tools are required to properly measure tension and to restore belt tension to factory specifications. Also, check belt routing to make sure there is no interference between the belts and other engine components.

Spark Plugs

Spark plugs must fire properly to assure engine performance and emission control. New plugs should be installed at the specified mileage. The entire set should be replaced if there is any malfunction due to a faulty spark plug. Check the specifications section for the proper type of spark plug for use in your vehicle.

Catalytic Converter

The catalytic converter requires the use of unleaded fuel only. Leaded gasoline will destroy the effectiveness of the catalyst as an emission control device.

Under normal operating conditions, the catalytic converter will not require maintenance. However, it is important to keep the engine properly tuned to assure proper catalyst operation and prevent possible catalyst damage.

CAUTION!

Damage to the catalytic converter can result if your vehicle is not kept in proper operating condition. In the event of engine malfunction, particularly involving engine misfire or other apparent loss of performance, have your vehicle serviced promptly. Continued operation of your vehicle with a severe malfunction could cause the converter to overheat, resulting in possible damage to the converter and the vehicle.

WARNING!

A hot exhaust system can start a fire if you park over materials that can burn. Such materials might be grass or leaves coming into contact with your exhaust system. Do not park or operate your vehicle in areas where your exhaust system can contact anything that can burn.

In unusual situations involving grossly malfunctioning engine operation, a scorching odor may suggest severe and abnormal catalyst overheating. If this occurs, stop the vehicle, turn off the engine and allow it to cool. Service, including a tune up to manufacturers specifications, should be obtained immediately.

To minimize the possibility of catalyst damage:

- Do not shut off the engine or interrupt the ignition when the transaxle is in gear and the vehicle is in motion.
- Do not try to start the engine by pushing or towing the vehicle.

- Do not idle the engine with any spark plug wires disconnected for prolonged period.

Engine Timing Belt

Replace the engine timing belt at the intervals described in the appropriate maintenance schedule.

Ignition Wiring System

The ignition cables should be kept clean and properly connected. Terminals should be fully seated. Cracked, damaged, or faulty cables should be replaced.

Crankcase Emission Control System

Proper operation of this system depends on freedom from sticking or plugging due to deposits. As vehicle mileage builds up, the PCV valve and passages may accumulate deposits. If a valve is not working properly, replace it with a new valve. **DO NOT ATTEMPT TO CLEAN THE OLD PCV VALVE!**

Check ventilation hose for indication of damage or plugging deposits. Replace if necessary.

Fuel Filter

A plugged fuel filter can cause hard starting or limit the speed at which a vehicle can be driven. Should an excessive amount of dirt accumulate in the fuel tank, frequent filter replacement may be necessary.

Air Cleaner Element (Filter)

Under normal driving conditions, replace the filter at the intervals shown on Schedule "A". If, however, you drive the vehicle frequently under dusty or severe conditions, the filter element should be inspected periodically and replaced if necessary at the intervals shown on Schedule "B".

WARNING!

The air cleaner can provide a measure of protection in the case of engine backfire. Do not remove the air cleaner unless such removal is necessary for repair or maintenance. Make sure that no one is near the engine compartment before starting the vehicle with the air cleaner removed. Failure to do so can result in serious personal injury.

Maintenance-Free Battery

The top of the MAINTENANCE-FREE battery is permanently sealed. You will never have to add water, nor is periodic maintenance required.

CAUTION!

When servicing the battery, always reinstall the battery thermowrap. The thermowrap provides battery heat protection and will extend overall battery life. Failure to reinstall the thermowrap can result in evaporative loss of the battery fluid.

WARNING!

Battery posts, terminals and related accessories contain lead and lead compounds. Wash hands after handling.

Battery fluid is a corrosive acid solution and can burn or even blind you. Don't allow battery fluid to contact your eyes, skin or clothing. Don't lean over a battery when attaching clamps. If acid splashes in eyes or on skin, flush the area immediately with large amounts of water.

Battery gas is flammable and explosive. Keep flame or sparks away from the battery. Don't use a booster battery or any other booster source with an output greater than 12 volts. Don't allow cable clamps to touch each other.

CAUTION!

It is essential when replacing the cables on the battery that the positive cable is attached to the positive post and the negative cable is attached to the negative post. Battery posts are marked positive (+) and negative (-) and identified on the battery case. Cable clamps should be tight on the terminal posts and free of corrosion. Apply grease to posts and clamps after tightening.

If a "fast charger" is used while the battery is in the vehicle, disconnect both vehicle battery cables before connecting the charger to battery. Do not use a "fast charger" to provide starting voltage as battery damage can result.

Air Conditioner

Check the air conditioning system at the start of the warm weather season.

NOTE: If your air conditioning performance seems lower than expected, check the front of the A/C condenser for an accumulation of dirt or insects. Clean with

a gentle water spray from behind the radiator and through the condenser as required. Fabric front fascia protectors may reduce air flow to the condenser, reducing air conditioning performance.

WARNING!

The air conditioning system contains refrigerant under high pressure. To avoid risk of personal injury or damage to the system, adding refrigerant or any repair requiring lines to be disconnected should be done by an experienced repairman.

Refrigerant Recovery And Recycling

The air conditioning system of your vehicle contains R-134a, a refrigerant that does not deplete the ozone layer in the upper atmosphere, the manufacturer recommends that air conditioning service be done by facilities using refrigerant recycling and recovery equipment that meets SAE standard J1991.

NOTE: Air Conditioning systems found to be contaminated with A/C System Sealers, Stop Leak Products, Seal

Conditioners, Compressor Oils, or Refrigerants not approved by the manufacturer, voids the warranty for the Air Conditioning system.

Power Steering Fluid Check

Checking the power steering fluid level at a defined service interval is not required. The fluid should only be checked if a leak is suspected, abnormal noises are apparent, and/or the system is not functioning as anticipated. Coordinate inspection efforts through a certified DaimlerChrysler Dealership.

WARNING!

Fluid level should be checked on a level surface and with the engine off to prevent injury from moving parts and to insure accurate fluid level reading. Do not overfill. Use only manufacturers recommended power steering fluid.

If necessary, add fluid to restore to the proper indicated level. With a clean cloth, wipe any spilled fluid from all surfaces. Refer to Recommended Fluids, Lubricants, and Genuine Parts for correct fluid types.

Front Suspension Ball Joints

There are two front suspension lower ball joints that are permanently lubricated. Inspect these ball joints whenever under-vehicle service is done. Damaged seals should be replaced to prevent leakage or grease contamination.

Body Lubrication

Locks and all body pivot points, including such items as seat tracks, doors, trunk and hood hinges, should be lubricated periodically to assure quiet, easy operation and to protect against rust and wear. Prior to the application of any lubricant, the parts concerned should be wiped clean to remove dust and grit; after lubricating excess oil and grease should be removed. Particular attention should also be given to hood latching components to insure proper function. When performing other underhood services, the hood latch, release mechanism and safety catch should be cleaned and lubricated.

The external lock cylinders should be lubricated twice a year, preferably in the fall and spring. Apply a small amount of a high quality lubricant such as Mopar® Lock Cylinder Lubricant directly into the lock cylinder.

Windshield Wiper Blades

Clean the rubber edges of the wiper blades and the windshield periodically with a sponge or soft cloth and a mild non abrasive cleaner, or use the washer solvent. This will remove accumulations of salt or road film and help reduce streaking and smearing.

Operation of the wipers on dry glass for long periods may cause deterioration of the wiper blades. Always use washer fluid when using the wipers to remove salt or dirt from a dry windshield. Avoid using the wiper blades to remove frost or ice from the windshield. Make sure that they are not frozen to the glass before turning them on to avoid damaging the blade. Keep the blade rubber out of contact with petroleum products such as engine oil, gasoline, etc.

Windshield Wiper Blade Replacement

1. Lift the wiper arm away from the glass.
2. Rotate the blade 45 degrees to gain access to the release tab.
3. Push the release tab shown in the picture and slide the wiper blade assembly down along the arm. Gently place the wiper arm on the windshield.

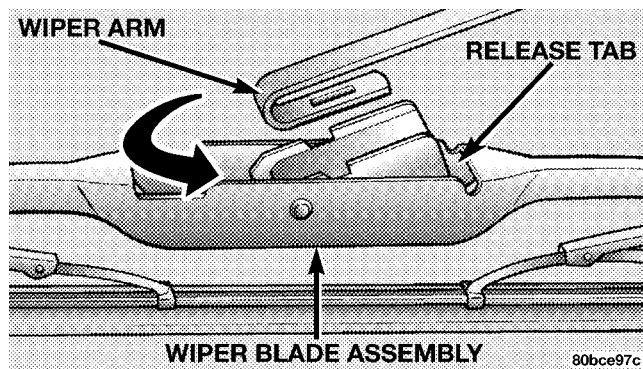

4. Install the new blade assembly onto the wiper arm tip until it locks in place.

Windshield Washer Aiming

To change the aim of the windshield washers, place a safety pin into the nozzle opening and move the nozzle slightly. Continue making slight adjustments until you obtain the desired pattern.

Windshield Washer Reservoir

The washer fluid reservoir is located in the engine compartment and should be checked for fluid level at regular intervals. Fill the reservoir with windshield washer solvent (not radiator antifreeze)

Exhaust System

The best protection against carbon monoxide entry into the vehicle body is a properly maintained engine exhaust system.

If you notice a change in the sound of the exhaust system; or if exhaust fumes can be detected inside the vehicle; or when the underside or rear of the vehicle is damaged; have a competent mechanic inspect the complete exhaust system and adjacent body areas for broken, damaged, deteriorated, or mispositioned parts. Open seams or loose connections could permit exhaust fumes to seep

into the passenger compartment. In addition, inspect the exhaust system each time the vehicle is raised for lubrication or oil change. Replace as required.

WARNING!

Exhaust gases can injure or kill. They contain carbon monoxide which is colorless and odorless. Breathing it can make you unconscious and can eventually poison you. Follow the above precautions to keep your exhaust system as safe as possible.

Cooling System**WARNING!**

- When working near the radiator cooling fan, disconnect the fan motor lead or turn the ignition key to the OFF position. The fan is temperature controlled and can start at any time the ignition key is in the ON position.
- You or others can be badly burned by hot coolant or steam from your radiator. If you see or hear steam coming from under the hood, don't open the hood until the radiator has had time to cool. Never try to open a cooling system pressure cap when the radiator is hot.

Coolant Checks

Check coolant protection every 12 months (before the onset of freezing weather, where applicable). If coolant is dirty or rusty in appearance, the system should be drained, flushed and refilled with fresh coolant.

Check the front of the radiator for an accumulation of bugs, leaves, etc. Clean the radiator by gently spraying water from a garden hose at the back of the core.

Check the recovery bottle tank tubing for condition and tightness of connection at the bottle and radiator. Inspect the entire system for leaks.

With the engine at normal operating temperature (but not running), check the cooling system pressure cap for proper vacuum sealing by draining a small amount of coolant from the radiator drain cock. If the cap is sealing properly, the coolant will begin to drain from the reserve tank. Do not remove the cap when the cooling system is hot.

Cooling System — Drain, Flush and Refill

At the intervals shown on the Maintenance Schedules, the system should be drained, flushed and refilled.

If the solution is dirty and contains a considerable amount of sediment, clean and flush with a reliable cooling system cleaner. Follow with a thorough rinsing to remove all deposits and chemicals. Discard oil antifreeze solution.

Engine Coolant Disposal

Used ethylene glycol based engine coolant is a regulated substance requiring proper disposal. Check with your local authorities to determine the disposal rules for your community. Do not store ethylene glycol based engine coolant in open containers or allow it to remain in puddles on the ground. Prevent ingestion by animals or children. If ingested by a child, contact a physician immediately.

Selection Of Coolant

Use only the manufacturers recommended coolant, refer to Recommended Fluids, Lubricants and Genuine Parts for correct coolant type.

CAUTION!

Mixing of coolants other than specified (non-HOAT), may result in engine damage that may not be covered under the new vehicle warranty, and decreased corrosion protection. If a non-HOAT coolant is introduced into the cooling system in an emergency, it should be replaced with the specified coolant as soon as possible.

Do not use plain water alone or alcohol base antifreeze products. Do not use additional rust inhibitors or antirust products, as they may not be compatible with the radiator coolant and may plug the radiator.

This vehicle has not been designed for use with Propylene Glycol based coolants. Use of Propylene Glycol based coolants is not recommended.

Adding Coolant

When adding coolant, a minimum solution of 50% ethylene glycol antifreeze coolant in water should be used. Use higher concentrations (not to exceed 70%) if temperatures below -34°F (-37°C) are anticipated.

Use only high purity water such as distilled or deionized water when mixing the water/antifreeze solution. The use of lower quality water will reduce the amount of corrosion protection in the engine cooling system.

Please note that it is the owner's responsibility to maintain the proper level of protection against freezing according to the temperatures occurring in the area where the vehicle is operated.

NOTE: Mixing coolant types will decrease the life of the engine coolant and will require more frequent coolant changes.

Cooling System Pressure Cap

The cap must be fully tightened to prevent loss of coolant, and to insure that coolant will return to the radiator from the coolant reserve tank.

The cap should be inspected and cleaned if there is any accumulation of foreign material on the sealing surfaces.

WARNING!

The warning words “DO NOT OPEN HOT” on the cooling system pressure cap are a safety precaution. never add coolant when the engine is overheated. Do not loosen or remove the cap to cool an overheated engine. Heat causes pressure to build up in the cooling system. To prevent scalding or injury, do not remove the pressure cap while the system is hot or under pressure.

Coolant Level

The coolant bottle provides a quick visual method for determining that the coolant level is adequate. With the engine idling, and warm to normal operating temperature, the level of the coolant in the bottle should be between the “FULL” and “ADD” marks.

The radiator normally remains completely full, so there is no need to remove the radiator cap unless checking for

coolant freeze point or replacing coolant. Advise your service attendant of this. As long as the engine operating temperature is satisfactory, the coolant bottle need only be checked once a month.

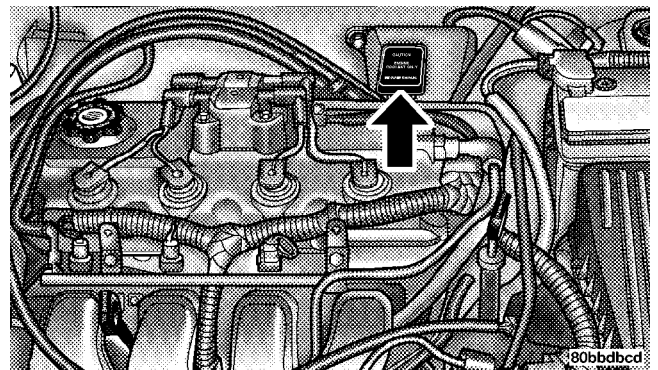

When additional coolant is needed to maintain the proper level, it should be added to the coolant bottle. Do not overfill.

Points to Remember

NOTE: When the vehicle is stopped after a few miles of operation, you may observe vapor coming from the front

of the engine compartment. This is normally a result of moisture from rain, snow, or high humidity accumulation on the radiator and being vaporized when the thermostat opens, allowing hot water to enter the radiator.

If an examination of your engine compartment shows no evidence of radiator or hose leaks, the vehicle may be safely driven. The vapor will soon dissipate.

- A. Do not overfill the coolant bottle.
- B. Check coolant freeze point in the system.
- C. If frequent coolant additions are required, the cooling system should be pressure tested for leaks.
- D. Maintain coolant concentration at 50% ethylene glycol antifreeze (minimum) in water for proper corrosion protection of your engine which contains aluminum components.
- E. Make sure that the radiator and coolant bottle hoses are not kinked or obstructed.

F. Keep the front of the radiator clean. If your vehicle has air conditioning, keep the front of the condenser clean, also.

G. Do not change the thermostat for summer or winter operation. If replacement is ever necessary, install **ONLY** the correct type thermostat. Other designs may result in unsatisfactory coolant performance, poor gas mileage, and increased emissions.

Hoses And Vacuum/Vapor Harnesses

Inspect surfaces of hoses and nylon tubing for evidence of heat and mechanical damage. Hard or soft spots, brittle rubber, cracking, checking, tear, cuts, abrasions, and excessive swelling indicate deterioration of the rubber.

Pay particular attention to the hoses nearest to high heat sources such as the exhaust manifold. Inspect hose routing to be sure hoses do not touch any heat source or moving component that may cause heat damage or mechanical wear.

Insure nylon tubing in these areas has not melted or collapsed.

Inspect all hose connections such as clamps and couplings to make sure they are secure and no leaks are present.

Components should be replaced immediately if there is any evidence of degradation that could cause failure.

Brake System

In order to assure brake system performance, all brake system components should be inspected periodically. Suggested service intervals can be found in the Maintenance Section.

WARNING!

Riding the brakes can lead to brake failure and possibly an accident. Driving with your foot resting or riding on the brake pedal can result in abnormally high brake temperatures, excessive lining wear, and possible brake damage. You wouldn't have your full braking capacity in an emergency.

Brake and Power Steering System Hoses

When servicing the vehicle for scheduled maintenance, inspect surface of hoses and nylon tubing for evidence of heat and mechanical damage. Hard and brittle rubber, cracking, checking, tears, cuts, abrasions, and excessive swelling suggest deterioration of the rubber. Particular attention should be made to examining those hose surfaces nearest to high heat sources, such as the exhaust manifold.

Inspect all hose clamps and couplings to make sure they are secure and no leaks are present.

Insure nylon tubing in these areas has not melted or collapsed.

NOTE: Often, fluids such as oil, power steering fluid, and brake fluid are used during assembly plant operations to ease the assembly of hoses to couplings. Therefore, oil wetness at the hose-coupling area is not necessarily an indication of leakage. Actual dripping of hot fluid when systems are under pressure (during vehicle operation) should be noted before hose is replaced based on leakage.

NOTE: Inspection of brake hoses should be done whenever the brake system is serviced and every engine oil change.

WARNING!

Worn brake hoses can burst and cause brake failure. You could have an accident. If you see any signs of cracking, scuffing, or worn spots, have the brake hoses replaced immediately.

Brake Master Cylinder

The fluid level in the master cylinder should be checked when performing under hood services, or immediately if the brake system warning lamp is on.

Be sure to clean the top of the master cylinder area before removing the cap. If necessary, add fluid to bring the fluid level up to the requirements described on the brake fluid reservoir. Fluid level can be expected to fall as the brake pads wear. Brake fluid level should be checked when pads are replaced. However, low fluid level may be caused by a leak and a checkup may be needed.

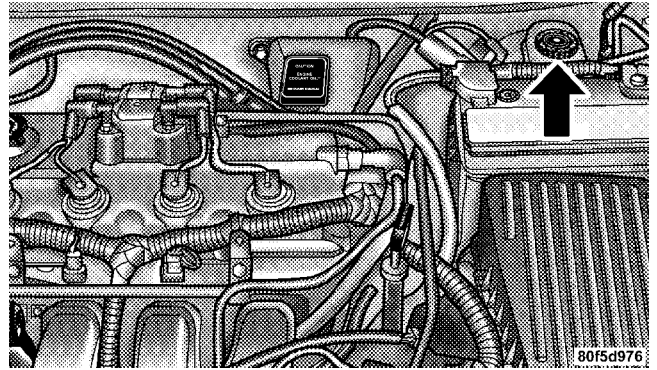

Use only manufacturers recommended brake fluid, refer to Recommended Fluids, Lubricants and Genuine Parts for correct fluid type.

WARNING!

Use of a brake fluid that may have a lower initial boiling point or unidentified as to specification, may result in sudden brake failure during hard prolonged braking. You could have an accident.

WARNING!

Overfilling the brake fluid reservoir can result in spilling brake fluid on hot engine parts and the brake fluid catching fire.

Use only brake fluid that has been in a tightly closed container to avoid contamination from foreign matter.

Do not allow petroleum based fluid to contaminate the brake fluid as seal damage will result!

Automatic Transaxle

All front wheel drive vehicles have a transaxle and differential assembly contained within a single housing.

Selection of Lubricant

It is important that the proper lubricant is used in the transaxle to assure optimum transaxle performance. Use only manufacturers recommended transmission fluid, refer to Recommended Fluids, Lubricants and Genuine Parts for correct fluid type. It is important that the transmission fluid be maintained at the prescribed level using the recommended fluid.

CAUTION!

Using a transmission fluid other than the manufacturers recommended fluid may cause deterioration in transmission shift quality and/or torque converter shudder. Using a transmission fluid other than the manufacturers recommended fluid will result in more frequent fluid and filter changes. Refer to Recommended Fluids, Lubricants and Genuine Parts for correct fluid type.

Fluid Level Check

The fluid level in the automatic transaxle should be checked whenever the vehicle is serviced. Operation with an improper fluid level will greatly reduce the life of the transaxle and of the fluid.

Procedure for Checking Fluid Level

Check the fluid level while the transmission is at normal operating temperature. This occurs after at least 15 miles (25 km) of driving. At normal operating temperature, which is approximately 180°F (82°C), the fluid cannot be held comfortably between the fingertips.

To check the fluid level properly, the following procedure must be used:

1. The vehicle must be on level ground.
2. The engine should be running at curb idle speed for at minimum of 60 seconds.
3. Fully apply parking brake.
4. Place the gear selector momentarily in each gear position ending with the lever in P (PARK).
5. Remove the dipstick, wipe it clean and reinsert it until seated.
6. Remove the dipstick again and note the fluid level on both sides. The fluid level should be in the crosshatch area at normal operating temperatures. If the fluid is low, add as required into the dipstick tube. **Do not overfill.**

NOTE: If it is necessary to check the transmission **below** the operating temperature, the fluid level should be between the two COLD (lower) holes on the dipstick with the fluid at approximately 80°F (27°C) (room temperature). If the fluid level is correctly established at room temperature, it should be between the HOT (upper)

reference holes when the transmission reaches 180°F (82°C). Remember it is best to check the level at the normal operating temperature.

TRANSAXLE DIPSTICK

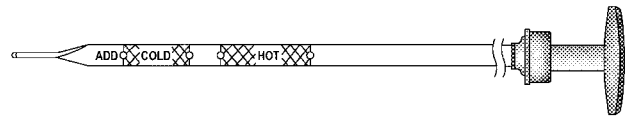

80ceda3d

If the fluid level shows low, add sufficient transmission fluid to bring to the proper level.

CAUTION!

Do not overfill. Dirt and water in the transaxle can cause serious damage. To prevent dirt and water from entering the transaxle after checking or replenishing fluid, make certain that the dipstick cap is seated properly.

Fluid and Filter Changes

Automatic transmission fluid and filter should be changed as follows:

Maintenance schedule "A" — No change necessary.

Maintenance schedule "B" — Every 60,000 miles (96 000 km) change fluid and filter under the following conditions:

- Police, taxi, limousine, commercial type operation, or trailer towing where the vehicle is driven **regularly** for more than 45 minutes of continuous operation.

NOTE: Refer to Section 8 of this manual for maintenance schedules.

If the transaxle is disassembled for any reason, the fluid and filter should be changed.

Special Additives

The manufacturer recommends against the addition of any fluid additives to the transaxle. The only exception to this policy is the use of special dyes to aid in detecting fluid leaks. The use of transmission sealers should be avoided as they may adversely affect seals.

Manual Transaxle**Lubricant Selection**

Use only manufacturers recommended transmission fluid, refer to Recommended Fluids, Lubricants and Genuine Parts for correct fluid type.

Fluid Level Check

Check the fluid level by removing the fill plug. The fluid level should be between the bottom of the fill hole and a point not more than 3/16" (4.76 mm) below the bottom of the hole.

Add fluid, if necessary, to maintain the proper level.

Frequency of Fluid Change

Under normal operating conditions, the fluid installed at the factory will give satisfactory lubrication for the life of the vehicle. Fluid changes are not necessary unless the following conditions exist:

- The lubricant has become contaminated with water. If contaminated with water, the fluid should be changed immediately.
- If severe usage has occurred, refer to Maintenance Schedule "B" in Section 8 of this manual.

Appearance Care and Protection from Corrosion**Protection of Body and Paint from Corrosion**

Vehicle body care requirements vary according to geographic locations and usage. Chemicals that make roads passable in snow and ice, and those that are sprayed on trees and road surfaces during other seasons, are highly corrosive to the metal in your vehicle. Outside parking, which exposes your vehicle to airborne contaminants, road surfaces on which the vehicle is operated, extreme

hot or cold weather and other extreme conditions will have an adverse effect on paint, metal trim, and underbody protection.

The following maintenance recommendations will enable you to obtain maximum benefit from the corrosion resistance built into your vehicle.

What Causes Corrosion?

Corrosion is the result of deterioration or removal of paint and protective coatings from your vehicle.

The most common causes are:

- Road salt, dirt and moisture accumulation.
- Stone and gravel impact.
- Insects, tree sap and tar.
- Salt in the air near sea coast localities.
- Atmospheric fallout/industrial pollutants.

Washing

- Wash your vehicle regularly. Always wash your vehicle in the shade using a mild car wash soap, and rinse the panels completely with clear water.
- If insects, tar or other similar deposits have accumulated on your vehicle, wash it as soon as possible.
- Use Mopar auto polish to remove road film and stains and to polish your vehicle. Take care never to scratch the paint.
- Avoid using abrasive compounds and power buffing that may diminish the gloss or thin out the paint finish.

CAUTION!

Do not use abrasive or strong cleaning materials such as steel wool or scouring powder, which will scratch metal and painted surfaces. Many wheel cleaners contain acids that may harm the wheel surface.

Special Care

- If you drive on salted or dusty roads or if you drive near the ocean, hose off the undercarriage at least once a month.
- It is important that the drain holes in the lower edges of the doors, rocker panels and rear deck lid be kept clear and open.
- If you detect any stone chips or scratches in the paint, touch them up immediately. The cost of such repairs is considered the responsibility of the owner.
- Use Mopar touch up paint on scratches or chips as soon as possible. Your dealer has touch up paint to match the color of your vehicle.

- If your vehicle is damaged due to an accident or similar cause which destroys the paint and protective coating, have your vehicle repaired as soon as possible. The cost of such repairs is considered the responsibility of the owner.
- If you carry special cargo such as chemicals, fertilizers, deicer salt, etc., be sure that such materials are well packaged and sealed.
- If a lot of driving is done on gravel roads, consider mud or stone shields behind each wheel.

Wheel And Wheel Trim Care

All wheels and wheel trim, especially Aluminum and Chrome plated, should be cleaned regularly, using mild soap and water to maintain their luster and to prevent corrosion. Wash them with the same soap solution as the body of your vehicle. Rinse wheels thoroughly.

When cleaning extremely dirty wheels, care must be taken in the selection of tire and wheel cleaning chemicals and equipment to prevent damage to the wheels.

Only Mopar Wheel Cleaners are recommended. Any of the "DO NOT USE" items listed below can damage wheels and wheel trim.

DO NOT USE:

- Any abrasive cleaner
- Any abrasive cleaning pad (such as steel wool) or abrasive brush
- Any cleaner that contains an acid which can react with and discolor the chrome surface.

CAUTION!
Many wheel cleaners contain acids that may harm the wheel surface.

- Oven cleaner
- A car wash that uses carbide-tipped wheel cleaning brushes or acidic solutions.

Interior Care

Use Mopar Fabric Cleaner to clean fabric upholstery and carpeting.

Use Mopar Vinyl Cleaner to clean vinyl upholstery.

Mopar Vinyl Cleaner is specifically recommended for vinyl trim.

Your leather upholstery can be best preserved by regular cleaning with a damp soft cloth. Small particles of dirt can act as an abrasive and damage the leather upholstery and should be removed promptly with a damp cloth. Stubborn soils can be removed easily with a soft cloth and Mopar Total Clean. Care should be taken to avoid soaking your leather upholstery with any liquid. Please do not use polishes, oils, cleaning fluids, solvents, detergents, or ammonia based cleaners to clean your leather upholstery. Application of a leather conditioner is not required to maintain the original condition.

WARNING!

Do not use volatile solvents for cleaning purposes. Many are potentially flammable, and if used in closed areas they may cause respiratory harm.

Cleaning Headlights

Your vehicle has plastic headlights that are lighter and less susceptible to stone breakage than glass headlights.

Plastic is not as scratch resistant as glass and therefore different lens cleaning procedures must be followed.

To minimize the possibility of scratching the lenses and reducing light output, avoid wiping with a dry cloth. To remove road dirt, wash with a mild soap solution followed by rinsing.

Do not use abrasive cleaning components, solvents, steel wool or other aggressive material to clean the lenses.

Glass Surfaces

All glass surfaces should be cleaned on a regular basis with any commercial household-type glass cleaner. Never use an abrasive type cleaner. Use caution when cleaning inside rear windows equipped with electric defrosters. Do not use scrapers or other sharp instruments which may scratch the elements.

Instrument Panel Cover

The instrument panel cover has a low glare surface which minimizes reflections in the windshield. Do not use protectants or other products which may cause undesirable reflections. Use soap and warm water to restore the low glare surface.

Cleaning Plastic Instrument Cluster Lenses

The lenses in front of the instruments in the vehicle are molded in clear plastic. When cleaning the lenses, care must be taken to avoid scratching the plastic.

1. Clean with a wet soft rag. A mild soap solution may be used, but do not use high alcohol content or abrasive cleaners. If soap is used, wipe clean with a clean damp rag.

2. Dry with a soft tissue.

Seat Belt Maintenance

Do not bleach, dye or clean the belts with chemical solvents or abrasive cleaners. This will weaken the fabric. Sun damage will also weaken the fabric.

If the belts need cleaning, use a mild soap solution or lukewarm water. Do not remove the belts from the vehicle to wash them.

Replace the belts if they appear frayed or worn or if the buckles do not work properly.

FUSES

Underhood Fuses (Power Distribution Center)

A Power Distribution Center is located in the engine compartment; next to the battery. A label identifying the components and circuits is located on the underside of the cover.

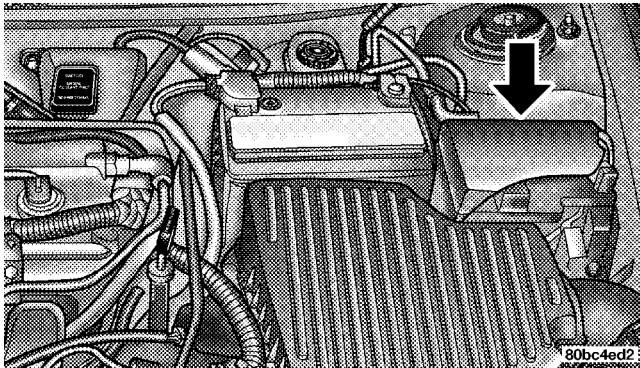

Interior Fuses

The fuse access panel is behind the end cover at the left side of the instrument panel. To remove the panel, pull it out, as shown. A diagram identifying the components and circuits is located on the inside of the cover.

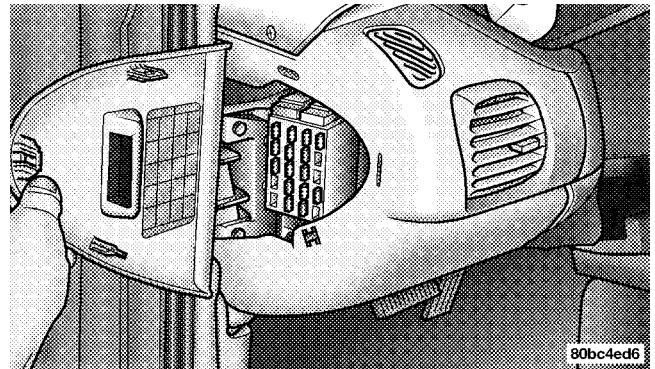

CAUTION!

When replacing a blown fuse, it is important to use only a fuse having the correct amperage rating. The use of a fuse with a rating other than indicated may result in a dangerous electrical system overload. If a properly rated fuse continues to blow, it shows a problem in the circuit that must be corrected.

VEHICLE STORAGE

If you will not be using your vehicle for more than 21 days you may want to take steps to preserve your battery. You may:

- Disengage the mini fuse in the Power Distribution Center labeled IOD (Ignition Off-Draw).
- Or, disconnect the negative cable from the battery.

REPLACEMENT BULBS

LIGHT BULBS — Inside

Bulb No.

ABS Indicator	LED
Airbag Indicator	LED
Brake System Warning Indicator	LED
Climate Controls	LED
Console Gear Selector	PC194
Dome Light	T579
Front Fog Indicator	LED
High Beam Indicator	PC194
Instrument Cluster Illumination	PC194
Low Fuel Indicator	LED
Low Oil Pressure Indicator	LED
Rear Cargo	T906
Seat Belt Indicator	LED
Security Alarm Indicator	LED
Malfunction Indicator Light	LED
Turn Signal Indicator	PC194
Voltage Indicator	LED

All the inside bulbs are brass or glass wedge base. Aluminum base bulbs are not approved and should not be used for replacement.

LIGHTS BULBS — Outside	Bulb No.
Headlight	9007
Front Park/Turn Signal Light	3457AK
Front Side Marker Light	168
Front Fog Light	899
Center High Mounted Stop Light (CHMSL)	921-W16W
Rear Tail/Stop/Turn Signal Light	3157-P27/7W
Backup Light	921-W16W
License Light	168

BULB REPLACEMENT

Headlight Bulb Replacement

CAUTION!

Do not touch the new headlight bulb with your fingers. Oil contamination will severely shorten bulb life.

1. Remove the three upper fascia screws.

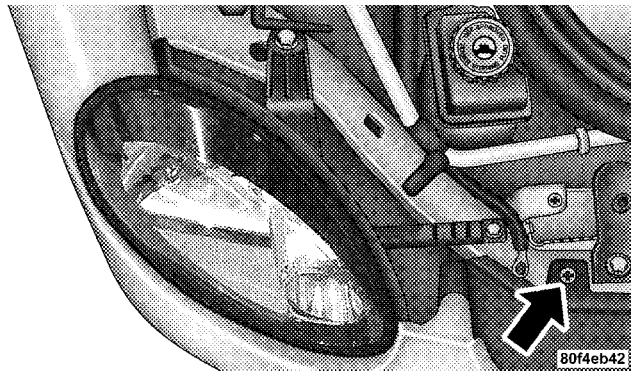

2. Remove two screws from the headlight assembly and remove the assembly from the vehicle.

NOTE: The headlight assembly is located to the fender by a molded pin. Pull the outboard side of the headlight straight out until the molded pin clears the fender, then slide the headlight out from behind the bumper fascia and grille.

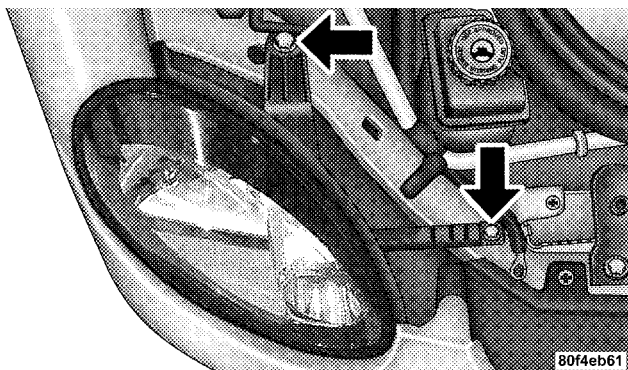

3. Disconnect the electrical connector.

4. Remove the retaining ring and replace the bulb.

CAUTION!

During installation, be sure when tightening the inboard screw, to only tighten until the rubber grommet on the screw starts to compress against the headlamp module housing.

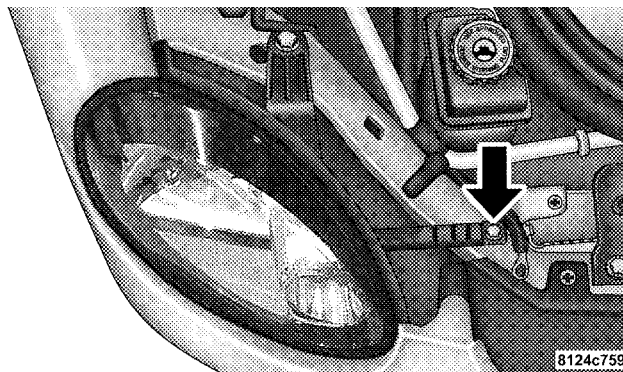

Front Park/Turn Signal Lights

1. Remove the headlight assembly
2. Twist the bulb socket 1/4 turn and remove.
3. Pull the bulb from the socket and replace.

Front Sidemarker Light

1. Remove the screws and push-pins from the front fender splash shield.
2. Reach between the fender and the splash shield, grasp the bulb and socket assembly and turn it counterclockwise. Remove the bulb and socket assembly from the light housing.
3. Pull the bulb out of the socket and replace the bulb. Reinstall the bulb and socket assembly and replace the fender splash shield.

Tail/Stop, Rear Turn Signals and Back-up Lights

1. Open the trunk and move the trunk liner away from the rear light mounting area.
2. Twist the bulb socket 1/4 turn to remove it from the housing.
3. Pull bulb from socket and replace

Center High Mounted Stop Light

1. Twist the socket 1/4 turn and remove it from the housing.
2. Pull the bulb out of the socket and replace.

FLUIDS AND CAPACITIES

	U.S.	Metric
Fuel (Approximate)		
Standard 2.0L Engines 87 Octane	12.5 Gallons	47.5 Liters
High Output 2.0L Engines 91 Octane	12.5 Gallons	47.5 Liters
Engine Oil-With Filter		
2.0 Liter Engines (SAE 5W-30, API Certified Engine Oils)	4.5 qts	4.3 Liters
Cooling System *		
2.0 Liter Engines (Mopar® Antifreeze/Coolant 5 Year/100,000 Mile Formula)	6.5 qts	6.2 Liters

* Includes heater and coolant recovery bottle filled to MAX level.

RECOMMENDED FLUIDS, LUBRICANTS AND GENUINE PARTS

Engine

Component	Fluids, Lubricants and Genuine Parts
Engine Coolant	Mopar® Antifreeze/Coolant 5 Year/100,000 Mile Formula HOAT (Hybrid Organic Additive Technology)
Engine Oil	Use API Certified SAE 5W-30 Engine Oil. Refer to oil viscosity chart for correct SAE grade meeting DaimlerChrysler Material Standard MS-6395.
Engine Oil Filter	Mopar 4105409 or equiv.
Spark Plugs	Refer to the Vehicle Emission Control Information label in the engine compartment.
Fuel Selection	91 Octane for 2.0L H.O. and 87 Octane for 2.0L Standard Engine.

Chassis

Component	Fluids, Lubricants and Genuine Parts.
Automatic Transmission	Mopar® ATF+4 Automatic Transmission Fluid.
Manual Transmission Fluid	Mopar® ATF+4 Automatic Transmission Fluid.
Brake Master Cylinder	Mopar® DOT 3 and SAE J1703 should be used. If DOT 3 brake fluid is not available, then DOT 4 is acceptable. Use only recommended brake fluids.
Power Steering Reservoir	Mopar® ATF+4 Automatic Transmission Fluid.

MAINTENANCE SCHEDULES

CONTENTS

■ Emission Control System Maintenance	204	□ Schedule "B"	207
■ Maintenance Schedules	204	□ Schedule "A"	215

EMISSION CONTROL SYSTEM MAINTENANCE

The “Scheduled” maintenance services, listed in **bold type** must be done at the times or mileages specified to assure the continued proper functioning of the emission control system. These, and all other maintenance services included in this manual, should be done to provide best vehicle performance and reliability. More frequent maintenance may be needed for vehicles in severe operating conditions such as dusty areas and very short trip driving.

Inspection and service also should be done any time a malfunction is suspected.

NOTE: Maintenance, replacement, or repair of the emission control devices and systems on your vehicle may be performed by any automotive repair establishment or individual using any automotive part which has been certified pursuant to U.S. EPA or, in the State of California, California Air Resources Board regulations.

MAINTENANCE SCHEDULES

There are two maintenance schedules that show the **required** service for your vehicle.

First is Schedule “**B**”. It is for vehicles that are operated under the conditions that are listed below and at the beginning of the schedule.

- Day or night temperatures are below 32°F (0°C).
- Stop and go driving.
- Extensive engine idling.
- Driving in dusty conditions.
- Short trips of less than 10 miles (16.2 km).
- More than 50% of your driving is sustained high speeds during hot weather, above 90°F (32°C).
- Trailer towing.†◇
- Taxi, police or delivery service (commercial services).†◇
- Off-road or desert operation.

- If equipped for and operating with E-85 (ethanol) fuel.

NOTE: If ANY of these apply to you then change your engine oil every 3,000 miles (5 000 km) or 3 months, whichever comes first and follow schedule "B" of the "Maintenance Schedules" section of this manual.

NOTE: Most vehicles are operated under the conditions listed for Schedule "B".

Second is Schedule "A". It is for vehicles that are not operated under any of the conditions listed under Schedule "B".

Use the schedule that best describes your driving conditions. Where time and mileage are listed, follow the interval that occurs first.

CAUTION!

Failure to perform the required maintenance items may result in damage to the vehicle.

At Each Stop for Fuel

- Check the engine oil level about 5 minutes after a fully warmed engine is shut off. Checking the oil level while the vehicle is on level ground will improve the accuracy of the oil level reading. Add oil only when the level is at or below the ADD or MIN mark.
- Check the windshield washer solvent and add if required.

Once a Month

- Check tire pressure and look for unusual wear or damage.
- Inspect the battery and clean and tighten the terminals as required.
- Check the fluid levels of coolant reservoir, brake master cylinder, power steering and transaxle and add as needed.
- Check all lights and all other electrical items for correct operation.

206 MAINTENANCE SCHEDULES

- Check rubber seals on each side of the radiator for proper fit.

At Each Oil Change

- Change the engine oil filter.
- Inspect the exhaust system.
- Inspect the brake hoses.
- Inspect the CV joints and front suspension components.

- Check the automatic transaxle fluid level.
- Check the manual transaxle fluid level and fill plug condition.
- Check the coolant level, hoses, and clamps.
- Rotate the tires at each oil change interval shown on Schedule "A" 6,000 miles (10 000 km) or every other interval shown on Schedule "B" 6,000 miles (10 000 km).

Schedule "B"

Follow schedule "B" if you usually operate your vehicle under one or more of the following conditions.

Change the automatic transmission fluid and filter every 60,000 miles (96 000 km) if the vehicle is usually operated under one or more of the conditions marked with an ◇.

Change the manual transaxle fluid every 48,000 miles (77 000 km) if the vehicle is usually operated under one or more of the conditions marked with an †.

- Day or night temperatures are below 32°F (0°C).
 - Stop and go driving.
 - Extensive engine idling.
 - Driving in dusty conditions.
 - Short trips of less than 10 miles (16.2 km).
 - More than 50% of your driving is sustained high speeds during hot weather, above 90°F (32°C).
- Trailer towing. † ◇
 - Taxi, police or delivery service (commercial services). † ◇
 - Off-road or desert operation.
 - **If equipped for and operating with E-85 (ethanol) fuel.**

NOTE: If ANY of these apply to you then change your engine oil every 3,000 miles (5 000 km) or 3 months, whichever comes first and follow schedule "B" of the "Maintenance Schedules" section of this manual.

If none of these apply to you, then change your engine oil at every interval shown on schedule "A" of the "Maintenance Schedules" section of this manual.

208 SCHEDULE "B"

Miles (Kilometers)	3,000 (5 000)	6,000 (10 000)	9,000 (14 000)	12,000 (19 000)	15,000 (24 000)
Change engine oil and engine oil filter.	X	X	X	X	X
Inspect the front brake pads and rear brake linings and rotors.			X		
Inspect and replace, if required, the make-up air filter (located inside the air cleaner).					X
Inspect and replace, if required, the air cleaner element (filter) . *					X

Miles (Kilometers)	18,000 (29 000)	21,000 (34 000)	24,000 (38 000)	27,000 (43 000)	30,000 (48 000)
Change engine oil and engine oil filter.	X	X	X	X	X
Inspect the front brake pads and rear brake linings and rotors.	X			X	
Replace air cleaner element (filter) .					X
Check and replace, if necessary, the PCV valve . *					X
Adjust the generator belt tension.					X
Replace the make-up air filter (located inside the air cleaner).					X
Replace the spark plugs .					X
Inspect the tie rod ends and boot seal.					X

210 SCHEDULE "B"

Miles (Kilometers)	33,000 (53 000)	36,000 (58 000)	39,000 (62 000)	42,000 (67 000)	45,000 (72 000)
Change engine oil and engine oil filter.	X	X	X	X	X
Inspect the front brake pads and rear brake linings and rotors.		X			X
Inspect and replace, if necessary, the air cleaner element (filter) . *					X
Inspect and replace, if required, the make-up air filter (located inside the air cleaner).					X

Miles (Kilometers)	48,000 (77 000)	51,000 (82 000)	54,000 (86 000)	57,000 (91 000)	60,000 (96 000)
Change engine oil and engine oil filter.	X	X	X	X	X
Inspect the front brake pads and rear brake linings and rotors.			X		
Replace air cleaner element (filter) .					X
Check and replace, if necessary, the PCV valve . *‡					X
Change the automatic transaxle fluid and adjust the bands. ◇					X
Replace manual transaxle fluid. †	X				
Inspect the tie rod ends and boot seals.					X
Replace the drive belts.					X
Replace the make-up air filter (located inside the air cleaner).					X
Replace the spark plugs .					X
Replace the ignition cables .					X

212 SCHEDULE "B"

Miles (Kilometers)	63,000 (101 000)	66,000 (106 000)	69,000 (110 000)	72,000 (115 000)	75,000 (120 000)
Change engine oil and engine oil filter.	X	X	X	X	X
Inspect the front brake pads and rear brake linings and rotors.	X			X	
Inspect and replace, if necessary, the air cleaner element (filter) . *					X
Inspect and replace, if required, the make-up air filter (located inside the air cleaner).					X

Miles (Kilometers)	78,000 (125 000)	81,000 (130 000)	84,000 (134 000)	87,000 (139 000)	90,000 (144 000)
Change engine oil and engine oil filter.	X	X	X	X	X
Inspect the front brake pads and rear brake linings and rotors.		X			X
Replace air cleaner element (filter) .					X
Check and replace, if necessary, the PCV valve . *‡					X
Inspect the tie rod ends and boot seals.					X
Adjust the generator drive belt tension.					X
Replace the make-up air filter (located inside the air cleaner).					X
Replace the spark plugs .					X

214 SCHEDULE "B"

Miles (Kilometers)	93,000 (149 000)	96,000 (154 000)	99,000 (158 000)	102,000 (163 000)	105,000 (168 000)
Change engine oil and engine oil filter.	X	X	X	X	X
Inspect the front brake pads and rear brake linings and rotors.			X		
Inspect and replace, if necessary, the air cleaner element (filter) . *					X
Replace manual transaxle fluid. †		X			
Flush and replace the engine coolant.				X	
Replace the engine timing belt .					X
Inspect and replace, if required, the make-up air filter (located inside the air cleaner).					X

* This maintenance is recommended by the manufacture to the owner but is not required to maintain the emissions warranty.

‡ This maintenance is not required if previously replaced.

† This maintenance is required only for police, taxi, limousine type operation, or trailer towing.

◇ This maintenance is required only for police, taxi, limousine type operation, or trailer towing.

Inspection and service should also be performed anytime a malfunction is observed or suspected. Retain all receipts.

Schedule "A"

Miles (Kilometers) [Months]	6,000 (10 000) [6]	12,000 (19 000) [12]	18,000 (29 000) [18]	24,000 (38 000) [24]	30,000 (48 000) [30]	36,000 (58 000) [36]
Change engine oil and engine oil filter.	X	X	X	X	X	X
Inspect the brake linings.			X			X
Replace the engine air cleaner filter .					X	
Replace the spark plugs .					X	
Inspect the tie rod ends and boot seals.					X	
Replace the make-up air filter (located inside the air cleaner).					X	
Adjust generator drive belt tension					X	

216 SCHEDULE "A"

Miles (Kilometers)	42,000 (67 000)	48,000 (77 000)	54,000 (86 000)	60,000 (96 000)	66,000 (106 000)
[Months]	[42]	[48]	[54]	[60]	[66]
Change engine oil and engine oil filter.	X	X	X	X	X
Inspect the brake linings.			X		
Replace the engine air cleaner filter .				X	
Replace the spark plugs and ignition cables .				X	
Inspect the tie rod ends and boot seals.				X	
Inspect the PCV valve and replace, if necessary.*				X	
Flush and replace the engine coolant at 60 months, regardless of mileage.				X	
Replace the make-up air filter (located inside the air cleaner).				X	
Replace drive belts.				X	

Miles (Kilometers)	72,000 (115 000)	78,000 (125 000)	84,000 (134 000)	90,000 (144 000)	96,000 (154 000)	102,000 (160 000)
[Months]	[72]	[78]	[84]	[90]	[96]	[102]
Change engine oil and engine oil filter.	X	X	X	X	X	X
Inspect the front brake pads and rear brake linings and rotors.	X			X		
Replace the engine air cleaner filter .				X		
Replace the spark plugs .				X		
Inspect the tie rod ends and boot seals.				X		
Inspect the PCV valve and replace if necessary. Not required if previously changed. * ‡				X		
Replace the make-up air filter (located inside the air cleaner).				X		
Adjust the generator drive belt tension.				X		
Flush and replace the engine coolant at 60 months, regardless of mileage.						X
Replace engine timing belt .						X

* This maintenance is recommended by the manufacture to the owner but is not required to maintain the emissions warranty.

‡ This maintenance is not required if previously replaced.

WARNING!

You can be badly injured working on or around a motor vehicle. Do only that service work for which you have the knowledge and the right equipment. If you have any doubt about your ability to perform a service job, take your vehicle to a competent mechanic.

IF YOU NEED CONSUMER ASSISTANCE

CONTENTS

■ Suggestions For Obtaining Service For Your Vehicle	220	■ Reporting Safety Defects	224
□ Prepare For The Appointment	220	□ In Canada	224
□ Prepare A List	220	■ Publication Order Forms	225
□ Be Reasonable With Requests	220	■ Department Of Transportation Uniform Tire Quality Grades	226
■ If You Need Assistance	220	□ Treadwear	226
■ Warranty Information	222	□ Traction Grades	226
■ Mopar® Parts	224	□ Temperature Grades	227

SUGGESTIONS FOR OBTAINING SERVICE FOR YOUR VEHICLE**Prepare For The Appointment**

If you're having warranty work done, be sure to have the right papers with you. Take your warranty folder. All work to be performed may not be covered by the warranty, discuss additional charges with the service manager. Keep a maintenance log of your vehicle's service history. This can often provide a clue to the current problem.

Prepare A List

Make a written list of your vehicle's problems or the specific work you want done. If you've had an accident, or work done that is not on your maintenance log, let the service advisor know.

Be Reasonable With Requests

If you list a number of items, and you must have your vehicle by the end of the day, discuss the situation with the service advisor and list the items in order of priority. At many dealers you may obtain a rental vehicle at a

minimal daily charge. If you need a rental, it is advisable to make these arrangements when you call for an appointment.

IF YOU NEED ASSISTANCE

The manufacturer and its dealers are vitally interested in your satisfaction. We want you to be happy with our products and services.

Your selling dealer is best equipped and most anxious to provide prompt resolution for any warranty issue or related matter that you may experience. The manufacturer's dealers have the facilities, factory-trained technicians, special tools, and the latest information to assure your vehicle is fixed correctly and in a timely manner. The manufacturer has empowered its dealers to make warranty and repair decisions that ensure you are not inconvenienced. There is no need for you to wait for a decision from the manufacturer. If a special circumstance occurs that requires information from the manufacturer, we have asked the dealer's service management to make the contact on your behalf.

This is why you should always talk to your dealer's service manager first. Most matters can be resolved with this process.

- If for some reason you are still not satisfied, talk to the general manager or owner of the dealership. They want to know if you need assistance.
- If your dealership is unable to resolve the concern, you may contact the Manufacturer's Customer Center.

Any communication to the Manufacturer's Customer Center should include the following information:

- Owner's name and address
- Owner's telephone number (home and office)
- Dealership name
- Vehicle identification number
- Vehicle delivery date and mileage

DaimlerChrysler Motors Corporation Customer Center

P.O. Box 21-8004
 Auburn Hills, MI 48321-8004
 Phone: (800) 992-1997

DaimlerChrysler Canada Inc. Customer Center

P.O. Box 1621
 Windsor, Ontario N9A 4H6
 Phone —(800) 465-2001

In Mexico contact:

Av. Prolongacion Paseo de la Reforma, 1240
 Sante Fe C.P. 05109
 Mexico, D. F.
 In Mexico (915) 729-1248 or 729-1240
 Outside Mexico (525) 729-1248 or 729-1240

Customer Assistance For The Hearing Or Speech Impaired (TDD/TTY)

To assist customers who have hearing difficulties, the manufacturer has installed special TDD (Telecommunication Devices for the Deaf) equipment at its Customer Center. Any hearing or speech impaired customer who has access to a TDD or a conventional teletypewriter (TTY) in the United States can communicate with the manufacturer by dialing 1-800-380-CHRY.

Service Contract

You may have purchased a service contract for your vehicle to help protect you from the high cost of unexpected repairs after your manufacturer's new vehicle limited warranty expires. The manufacturer stands behind only the manufacturer's Service Contracts. If you purchased a manufacturer's Service Contract, you will receive Plan Provisions and an Owner Identification Card in the mail within three weeks of your vehicle delivery date. If you have any questions about your service contract, call the manufacturer's Service Contract National Customer Hotline at 1-800-521-9922.

The manufacturer will not stand behind any service contract that is not the manufacturer's Service Contract. It is not responsible for any service contract other than the manufacturer's Service Contract. If you purchased a service contract that is not a manufacturer's Service Contract, and you require service after your manufacturer's new vehicle limited warranty expires, please refer to your contract documents, and contact the person listed in those documents.

We appreciate that you have made a major investment when you purchased your new vehicle. Your dealer has also made a major investment in facilities, tools, and training to assure that you are absolutely delighted with your ownership experience. You'll be pleased with their sincere efforts to resolve any warranty issues or related concerns.

WARRANTY INFORMATION

See your manufacturer's Warranty Information Booklet for information on warranty coverage and transfer of warranty.

DESCRIPTION	1 Yr/ 12,000	2 Yr/ 24,000	3 Yr/ 36,000	3 Yr/ 50,000	3 Yr/ Unlmtd	5 Yr/ 100,000	7 Yr/ 70,000	8 Yr/ 80,000
Basic Limited Warranty Coverage	████████████████████							
Special Extended Warranty Coverage								
Powertrain Limited Warranty (\$100 deductible)	████████████████████			1st Owner & 2nd Owner with Paid Powertrain Transfer				
	2nd Owner If Powertrain Not Transferred and 3rd (And After) Owners							
Anti-Corrosion Perforation Limited Warranty: All Panels	████████████████████			████████████████████				
Outer Panels	████████████████████			████████████████████				
Federal Emission Warranty	████████████████████			████████████████████				
Federal Emission Warranty - Specified Components	████████████████████			████████████████████				
California Emission Warranty	████████████████████			████████████████████				
California Emission Warranty - Specified Components	████████████████████			████████████████████				

NOTE: Vehicles used as a police vehicle, taxi, limousine, postal delivery vehicle, ambulance or rental vehicle are covered only under the 3 year/36,000 mile Basic Limited Warranty.

8132c269

MOPAR® PARTS

Mopar® fluids, lubricants, parts, and accessories are available from your dealer. They will help you keep your vehicle operating at its best.

REPORTING SAFETY DEFECTS

In the 50 United States and Washington D.C.: If you believe that your vehicle has a defect which could cause a crash or cause injury or death, you should immediately inform the National Highway Traffic Safety Administration (NHTSA) in addition to notifying the manufacturer.

If NHTSA receives similar complaints, it may open an investigation, and if it finds that a safety defect exists in a group of vehicles, it may order a recall and remedy campaign. However, NHTSA cannot become involved in individual problems between you, your dealer, and the manufacturer.

To contact NHTSA, you may either call the Auto Safety Hotline toll free at 1-800-424-9393 (or 366-0123 in Washington DC area) or write to: NHTSA, U.S. Dept. of Transportation, Washington DC 20590. You can also obtain other information about motor vehicle safety from the Hotline.

In Canada:

If you believe that your vehicle has a safety defect, you should contact the Customer Service Department immediately. Canadian customers who wish to report a safety defect to the Canadian government should write to Transport Canada, Motor Vehicle Defect Investigations and Recalls, 2780 Sheffield Road, Ottawa, Ontario K1B 3V9.

PUBLICATION ORDER FORMS

To order the following manuals, you may use either the website or the phone numbers listed below. Visa, Mastercard, American Express, and Discover orders are accepted. If you prefer mailing your payment, please call for an order form.

NOTE: A street address is required when ordering manuals. (No P.O. Boxes).

- *Service Manuals.*

These comprehensive service manuals provide the information that students and professional technicians need in diagnosing/troubleshooting, problem solving, maintaining, servicing and repairing DaimlerChrysler Corporation vehicles. A complete working knowledge of the vehicle, system and/or components is written in straightforward language with illustrations, diagrams and charts.

- *Diagnostic Procedure Manuals.*

Filled with diagrams, charts and detailed illustrations, these practical manuals make it easy for students and

technicians to find and fix problems on computer-controlled vehicle systems and features. They show exactly how to find and correct problems the first time, using step-by-step troubleshooting and driveability procedures, proven diagnostic tests and a complete list of all tools and equipment.

- *Owner's Manuals.*

These manuals have been prepared with the assistance of service and engineering specialists to acquaint you with specific Chrysler group vehicles. Included are starting, operating, emergency and maintenance procedures as well as specifications, capabilities and safety tips.

Call Toll Free at **1-800-890-4038 (U.S.)** or **1-800-387-1143 (Canada)**

Or

Visit us on the World Wide Web at:

www.techauthority.daimlerchrysler.com
www.daimlerchrysler.ca/manuals

or

DEPARTMENT OF TRANSPORTATION UNIFORM TIRE QUALITY GRADES

The following describes the tire grading categories established by the National Highway Traffic Safety Administration. The specific grade rating assigned by the tire's manufacturer in each category is shown on the sidewall of the tires on your car.

All Passenger Car Tires Must Conform to Federal Safety Requirements in Addition to These Grades.

Treadwear

The treadwear grade is a comparative rating based on the wear rate of the tire when tested under controlled conditions on a specified government test course. For example, a tire graded 150 would wear one and a half (1 1/2) times as well on the government course as a tire graded 100. The relative performance of tires depends upon the actual conditions of their use, however, and may depart significantly from the norm due to variations in driving habits, service practices and differences in road characteristics and climate.

Traction Grades

The traction grades, from highest to lowest, are A, B, and C, and they represent the tire's ability to stop on wet pavement as measured under controlled conditions on specified government test surfaces of asphalt and concrete. A tire marked C may have poor traction performance.

WARNING!

The traction grade is based on braking (straight-ahead) traction tests and does not include cornering (turning) performance.

Temperature Grades

The temperature grades are A (highest), B, and C, representing the tire's resistance to the generation of heat and its ability to dissipate heat when tested under controlled conditions on a specified indoor laboratory test wheel. Sustained high temperature can cause the material of the tire to degenerate and reduce tire life, and excessive temperature can lead to sudden tire failure. The grade C corresponds to a level of performance which all passenger car tires must meet under the Federal Motor Vehicle Safety Standard No. 109. Grades B and A represent higher levels of performance on the laboratory test wheel than the minimum required by law.

WARNING!

The temperature grade is established for a tire that is properly inflated and not overloaded. Excessive speed, underinflation, or excessive loading, either separately or in combination, can cause heat buildup and possible tire failure.

INDEX

- ABS (Anti-Lock Brake) System 124
Adding Engine Coolant (Antifreeze) 182
Adding Fuel 145
Air Cleaner, Engine 175
Air Conditioning 104,176
Air Conditioning Controls 104
Air Conditioning Refrigerant 177
Air Conditioning System 176
Air Pressure, Tires 134
Airbag 31
Airbag Deployment 37
Airbag Light 39,47,80
Airbag Maintenance 39
Airbag, Side 38
Alarm, Panic 18
Alarm System 20,80
Alignment and Balance 139
Alterations/Modifications, Vehicle 6
Antenna, Satellite Radio 97
Antifreeze (Engine Coolant) 200,201
 Capacities 200
Anti-Lock Brake System 124
Anti-Lock Warning Light 79
Anti-Theft Security Alarm 20
Appearance Care 190
Arming Theft System 20
Ashtrays and Lighter 70
Automatic Door Locks 16
Automatic Transaxle 9,114,116,117,187
 Fluid and Filter Changes 189
 Fluid Level Check 187
 Interlock System 14,116
 Reset Mode 117
 Selection Of Lubricant 187
 Shifting 117
 Special Additives 189
Ball Joints 178
Battery 175
 Keyless Transmitter Replacement 19
Belts, Drive 173
Belts, Engine 174
Body Mechanism Lubrication 178
B-Pillar Location 129
Brake Fluid 201
Brake, Parking 121

- Brake System 123,185
 Anti-Lock 124
 Hoses 185
 Master Cylinder 186
 Parking 121
 Warning Light 78
 Brakes 123,185
 Brake/Transmission Interlock 116
 Break-In Recommendations, New Vehicle 46
 Bulb Replacement 196,197

 Calibration, Compass 54
 Capacities, Antifreeze (Engine Coolant) 200
 Capacities, Fluid 200
 Caps, Filler
 Fuel 145
 Carbon Monoxide Warning 145
 Cassette Tape and Player Maintenance 98
 Cassette Tape Player 84,86
 Catalytic Converter 173
 Caution, Exhaust Gas 47
 CD Changer 87,92,93,99
 CD Player 89,91

 CD Player Maintenance 101
 Cellular Phone 102
 Center High Mounted Stop Light 199
 Central Door Locks 15
 Central Locking 15
 Chains, Tire 139
 Changing A Flat Tire 153
 Charging System Light 80
 Chart, Tire Sizing 126
 Child Restraint 39
 Child Safety Locks 16
 Circuit Breakers 195
 Cleaning
 Glass 194
 Headlights 193
 Climate Control 102
 Clock 83
 Compact Disc Changer 99
 Compact Disc Maintenance 101
 Compact Spare Tire 136
 Compass 51
 Compass Calibration 54
 Compass Variance 53

- Console 69
Contract, Service 222
Coolant 181,200,201
Cooling System 180
 Adding Coolant (Antifreeze) 182
 Coolant Level 180,183
 Disposal of Used Coolant 181
 Drain, Flush, and Refill 181
 Inspection 183
 Points to Remember 182,183
 Pressure Cap 182
 Rubber and Plastic Components 184
 Selection of Coolant 181
Corrosion Protection 190
Crankcase Emission Control System 174
Cruise Light 82
Cup Holder 69
Customer Assistance 220
- Daytime Brightness, Interior Lights 61
Daytime Running Lights 62
Dealer Service 168
Defroster, Rear Window 110
Defroster, Windshield 48,103,106
Deploying, Airbag 37
Diagnostic System, Onboard 166
Dimmer Control 60
Dimmer Switch, Headlight 62
Disarming, Theft System 21
Disposal
 Engine Oil 172
Domelight 61
Door Locks 14
Door Locks, Automatic 16
Downshifting 121
Drive Belts 173
Driving
 On Slippery Surfaces 159
- Electric Remote Mirrors 54
Electronic Speed Control 65
Emergency, In Case of
 Jacking 153
 Jump Starting 157
 Towing 161
Emergency Trunk Release 22

- Emission Control System Maintenance 167,204
- Engine 165
- Break-In Recommendations 46
 - Checking Oil Level 169
 - Compartment 165
 - Cooling 180
 - Exhaust Gas Caution 145
 - Jump Starting 157
 - Oil 169,200,201
 - Oil Change Interval 170
 - Oil Filter 201
 - Oil Selection 171
 - Oil Synthetic 172
 - Overheating 152
 - Temperature Gauge 82
 - Timing Belt 174
- Engine Oil Viscosity Chart 171
- Exhaust Gas Caution 47,145
- Exhaust Pipes 179
- Exhaust System 179
- Extender, Seat Belt 31
- Filters
- Air Cleaner 175
 - Automatic Transaxle 189
 - Engine Fuel 175
 - Engine Oil 172,201
- Flashers
- Hazard Warning 152
- Flooded Engine Starting 115
- Fluid, Brake 201
- Fluid Capacities 200
- Fluid Leaks 48
- Fluid Level Checks
- Automatic Transaxle 187
 - Manual Transaxle 189
- Fog Lights 62,78
- Folding Rear Seat 57
- Freeing A Stuck Vehicle 160
- Front Suspension Ball Joints 178
- Fuel 141,201
- Adding 145
 - Capacity 200
 - Filler Cap 145
 - Filter 175

Gauge	81	Cleaning	193
Light	81	High Beam	79
Octane Rating	141	Switch	61
Tank Capacity	200	Heater	102
Fuel System Caution	144	Hood Prop	59
Fuses	195	Hood Release	58
Gas Cap	145	Hoses	184
Gasoline	200	Ignition	
Gasoline, Reformulated	142	Key	9
Gasoline/Oxygenate Blends	142	Wiring System	174
Gauges		Immobilizer	11,21
Coolant Temperature	82	Infant Restraint	40
Fuel	81	Inside Rearview Mirror	51
Tachometer	79	Instrument Cluster	75,76,77,78
Gearshift	117	Instrument Panel and Controls	74
General Information	13	Instrument Panel Cover	194
Glass Cleaning	194	Instrument Panel Lens Cleaning	194
Hazard Warning Flasher	152	Interior Appearance Care	193
Head Restraints	57	Interior Fuses	195
Headlights	61	Interior Lights	60
Bulb Replacement	197	Intermittent Wipers	63
		Introduction	4

Jack Operation	153	Brake Warning	78
Jacking Instructions	154	Center Mounted Stop	199
Jump Starting	157	Daytime Running	62
Key, Programming	12	Dimmer Switch, Headlight	61,62
Key Release Button	9	Dome	61
Key, Replacement	12	Exterior Check	48
Key, Sentry	11	Fog	62,78
Key-In Reminder	10	Headlights On Reminder	62
Keyless Entry System	17	High Beam Indicator	79
Keys	9	Instrument Cluster	61
Lane Change and Turn Signals	79	Interior	60
Lap/Shoulder Belts	24	Lights On Reminder	62
LATCH		Low Fuel	81
(Lower Anchors and Tether for CHildren)	42	Malfunction Indicator	81
Lead Free Gasoline	141	Map Reading	60
Leaks, Fluid	48	Oil Pressure	80
Light Bulbs	196,197	Park	61
Lighter, Cigar	70	Passing	62
Lights	60	Rear Servicing	199
Airbag	39,47,80	Rear Tail	199
Anti-Lock	79	Seat Belt Reminder	80
		Security Alarm	21
		Side Marker	199

- Theft Alarm 80
Turn Signal 62,79,199
Voltage 80
Warning (Instrument Cluster Description) 78
Loading Vehicle 147
Tires 129
Locks 14
Child Protection 16
Door 14
Power Door 15
Steering Wheel 13
Lubrication, Body 178
- Maintenance 169,204
Maintenance, Airbag 39
Maintenance Free Battery 175
Maintenance Procedures 169
Maintenance Schedule 204
Schedule "A" 215
Schedule "B" 207
Maintenance, Sunroof 69
Malfunction Indicator Light 81,167
Manual, Service 225
- Manual Transaxle 67,114,119,189
Downshifting 121
Fluid Level Check 189
Frequency of Fluid Change 190
Lubricant Selection 189
Map/Reading Lights 60
Master Cylinder 186
Mirrors 51
Compass/Temperature 51
Electric Remote 54
Outside 54
Rearview 51
Modifications/Alterations, Vehicle 6
Mopar Parts 168,224
Multi-Function Control Lever 61,62
- Occupant Restraints 23
Odometer
Trip 81
Oil, Engine 169,200
Capacity 200
Change Interval 170
Checking 169

- Disposal 172
 Filter 172
 Identification Logo 171
 Materials Added to 172
 Quality 171
 Recommendation 171,200
 Synthetic 172
 Viscosity 171
 Oil Pressure Light 80
 Onboard Diagnostic System 166,167
 Operator Manuals 4
 Outside Air Intake 104,109
 Outside Rearview Mirrors 54
 Overdrive 118
 Overheating, Engine 152
 Owner's Manual 4,225
- Paint Care 190
 Panic Alarm 18
 Parking Brake 121
 Passing Light 62
 Pets 46
 Phone, Cellular 102
- Placard, Tire and Loading Information 129
 Power
 Door Locks 15
 Steering 125,177
 Steering, Checking 177
 Sunroof 68
 Windows 23
 Power Steering Fluid 201
 Pregnant Women and Seat Belts 30
 Preparation for Jacking 154
 Programming Transmitters 19
- Radial Ply Tires 136
 Radio 83,84,89
 Radio Broadcast Signals 83
 Radio Operation 84,89
 Radio, Satellite 95
 Rear Window Defroster 110
 Reclining Front Seats 56
 Recommended Fluids, Lubricants and Genuine
 Parts 201
 Reformulated Gasoline 142
 Refrigerant 177

Release, Hood	58	Maintenance	194
Remote Keyless Entry	17	Rear Seat	24
Remote Trunk Release	21	Untwisting Procedure	29
Replacement Bulbs	196	Seats	55
Replacement Keys	12	Adjustment	55
Replacement Parts	168	Head Restraints	57
Replacement Tires	138	Rear Folding	57
Reporting Safety Defects	224	Reclining	56
Rotation, Tires	141	Security Alarm	20,80
Safety Checks Inside Vehicle	47	Sentry Key	11,21
Safety Checks Outside Vehicle	48	Sentry Key Programming	12
Safety Defects, Reporting	224	Service Assistance	220
Safety Information, Tire	125	Service Contract	222
Safety Tips	47	Service Manuals	225
Satellite Radio	95	Setting the Clock	83
Satellite Radio Antenna	97	Shift Speeds	120
Seat Belts	23	Shift Speeds, Manual Transaxle	120
Adjustable Upper Shoulder Anchorage	28	Shoulder Belt Upper Anchorage	28
And Pregnant Women	30	Side Airbag	38
Child Restraint	39	Side Window Demisters	103,109
Extender	31	Slippery Surfaces, Driving On	159
Front Seat	24	Snow Tires	140
		Spark Plugs	173

Speed Control	65,82	Theft System Disarming	21
Speedometer	79	Tilt Steering Column	64
Speedometer and Odometer	75,76,77	Tire and Loading Information Placard	129
Starting	114	Tire Identification Number (TIN)	128
Engine Fails to Start	115	Tire Markings	125
Starting Procedures	114	Tire Safety Information	125
Steering		Tires	48,133,226
Power	125	Air Pressure	133
Tilt Column	64	Alignment	139
Wheel Lock	13	Chains	139
Storage, Vehicle	196	Changing	153
Sun Roof	68	Compact Spare	136
Sunroof Maintenance	69	General Information	133
Supplemental Restraint System - Airbag	31	High Speed	135
Synthetic Engine Oil	172	Inflation Pressures	134
		Jacking	153
Tachometer	79	Load Capacity	129,130
Tape Player	98	Quality Grading	226
Temperature Control, Automatic	102	Radial	136
Temperature Gauge, Engine Coolant	82,153	Replacement	138
Theft Alarm	20	Rotation	141
Theft System	20	Safety	125,133
Theft System Arming	20	Sizes	126

Snow Tires	140	Underhood Fuses	195
Spinning	137	Uniform Tire Quality Grades	226
Tread Wear Indicators	137	Untwisting Procedure, Seat Belt	29
Towing		Vacuum/Vapor Harnesses	184
Disabled Vehicle	161	Variance, Compass	53
Trailer Towing	148	Vehicle Identification Number	6
Minimum Requirements	148	Vehicle Loading	130,147
Trailer and Tongue Weight	149	Vehicle Modifications/Alterations	6
Warnings	148	Vehicle Storage	196
Transaxle		Warning Lights	
Automatic	9,114,116,117,187	(Instrument Cluster Description)	78
Manual	9,67,114,119,189	Warnings and Cautions	6
Overdrive	118	Warranty Information	222
Selection of Lubricant	187	Washer, Adding Fluid	179
Transmitter Battery Service	19	Washers, Windshield	63
Transporting Pets	46	Washing Vehicle	191
Tread Wear Indicators	137	Wheel Alignment and Balance	139
Trip Odometer	81	Wheel and Wheel Trim Care	192
Trip Odometer Reset Button	81	Wind Buffeting	69
Trunk Release Button	21	Window Fogging	109
Trunk Release, Emergency	22		
Trunk Release Remote Control	21		
Turn Signals	62,79		

Windows	
Power	23
Windshield Washer Aiming	179
Windshield Washers	63
Fluid	179
Windshield Wiper Blades	178
Windshield Wipers	63
Wiper Blade Replacement	179
Wipers, Intermittent	63
Wiring, Ignition	174

Free Manuals Download Website

<http://myh66.com>

<http://usermanuals.us>

<http://www.somanuals.com>

<http://www.4manuals.cc>

<http://www.manual-lib.com>

<http://www.404manual.com>

<http://www.luxmanual.com>

<http://aubethermostatmanual.com>

Golf course search by state

<http://golfingnear.com>

Email search by domain

<http://emailbydomain.com>

Auto manuals search

<http://auto.somanuals.com>

TV manuals search

<http://tv.somanuals.com>